

Dijets in Diffractive Photoproduction

Karel Černý

Institute of Particle and Nuclear Physics

Charles University in Prague



DIS 2008 London



On behalf of the
H1 Collaboration

Introduction – QCD factorization

QCD hard factorization = assumption of:

$$\sigma^{diff.}(ep \rightarrow e X p) \approx \underbrace{f_{i/p}(\beta, Q^2, x_{IP}, t)}_{\text{diffractive parton distribution functions}} \times \underbrace{\sigma(\beta, Q^2)}_{\text{QCD subprocess cross section}}$$

diffractive parton
distribution functions

QCD subprocess
cross section

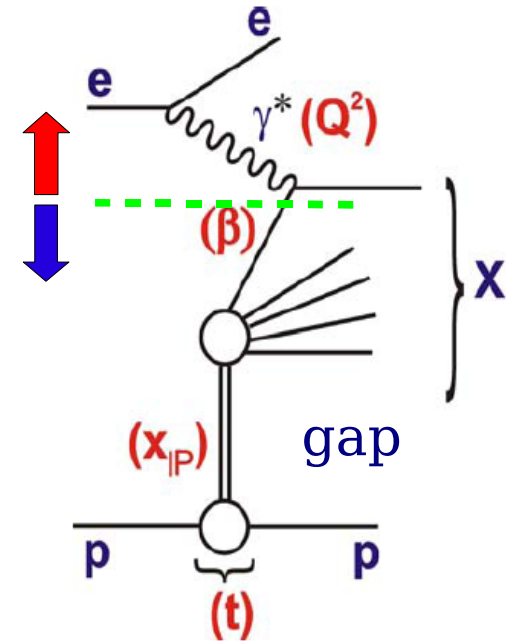

H1 fits vs. Tevatron

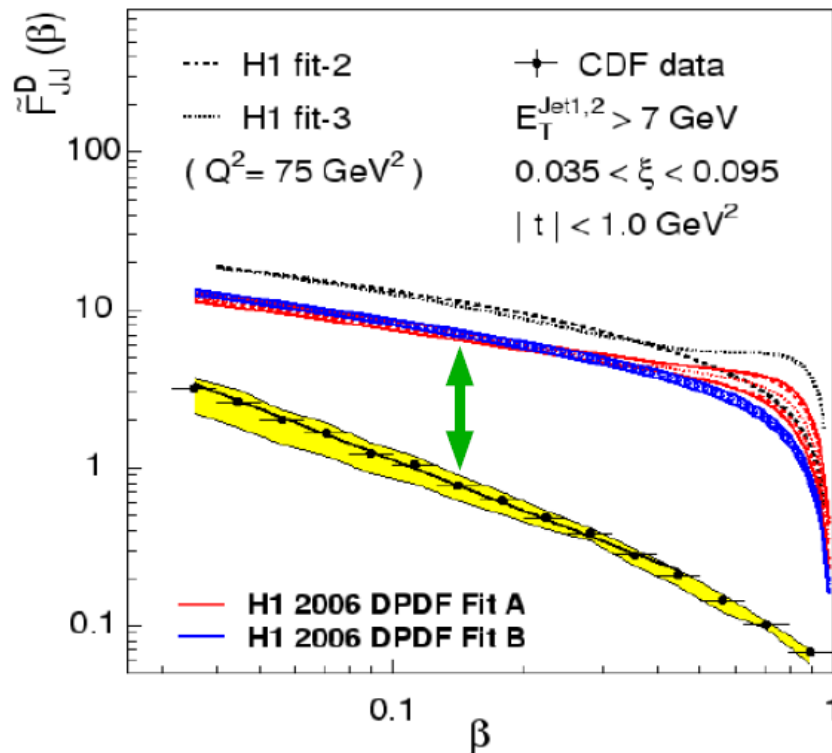

H1 DPDF fits fail to predict Tevatron data.

QCD factorization not expected to hold in diffractive h-h scattering (Kaidalov et al., 2003).

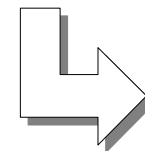

Introduction

Test of factorization in photoproduction

direct γ ($x_\gamma = 1$)

resolved γ ($x_\gamma < 1$)

x_γ – four-momentum fraction of the photon in the hard interaction

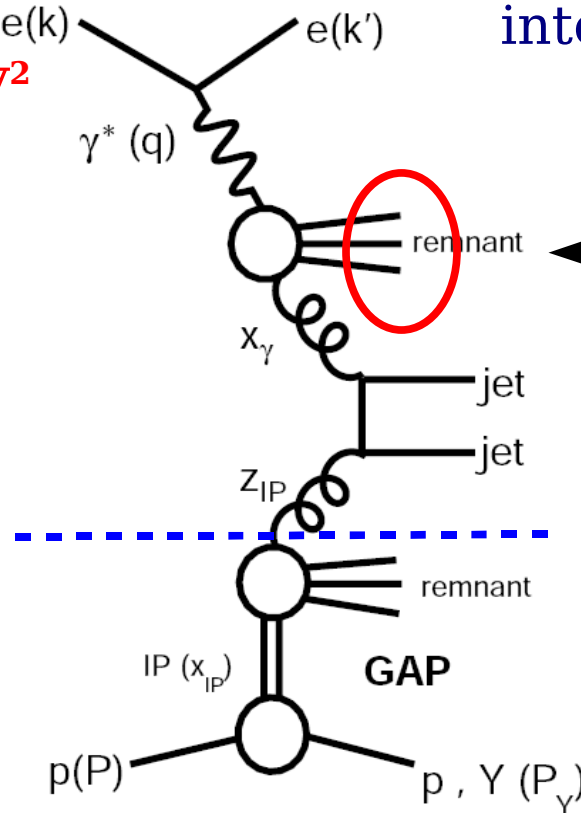
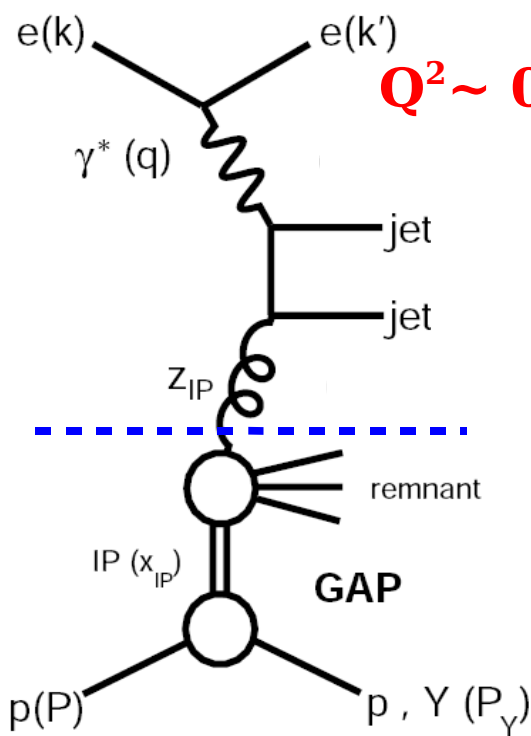

Rescattering of γ remnant in resolved makes the gap less likely to survive.

Resolved photon interactions are similar to h-h scattering

x_{IP} – four-momentum fraction of proton carried by diff. exchange IP
 z_{IP} – four-momentum fraction of IP carried by parton

Introduction - Recent results

H1 Diffractive Dijet Photoproduction

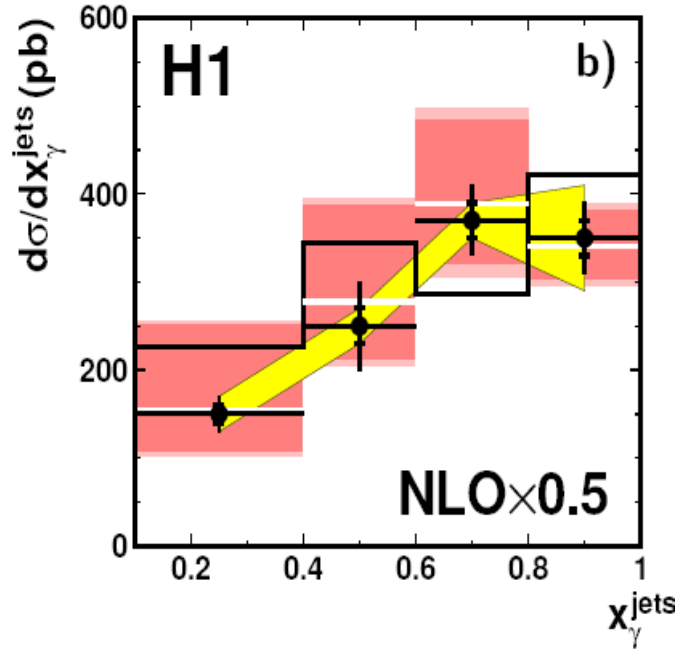
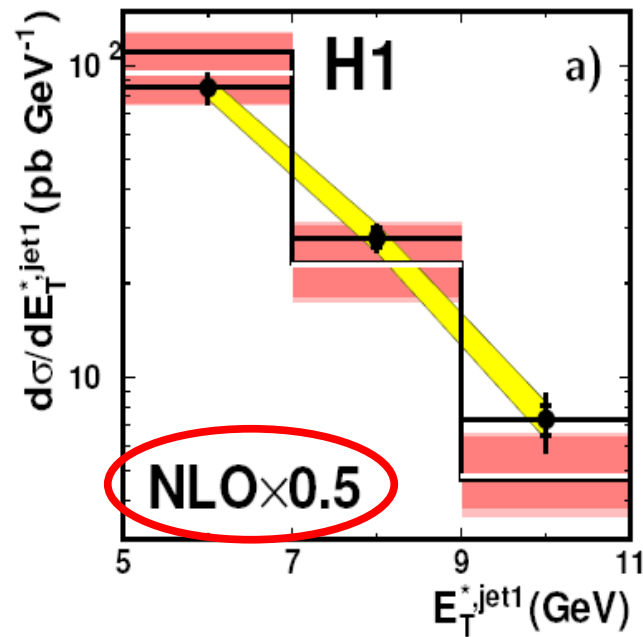

ZEUS

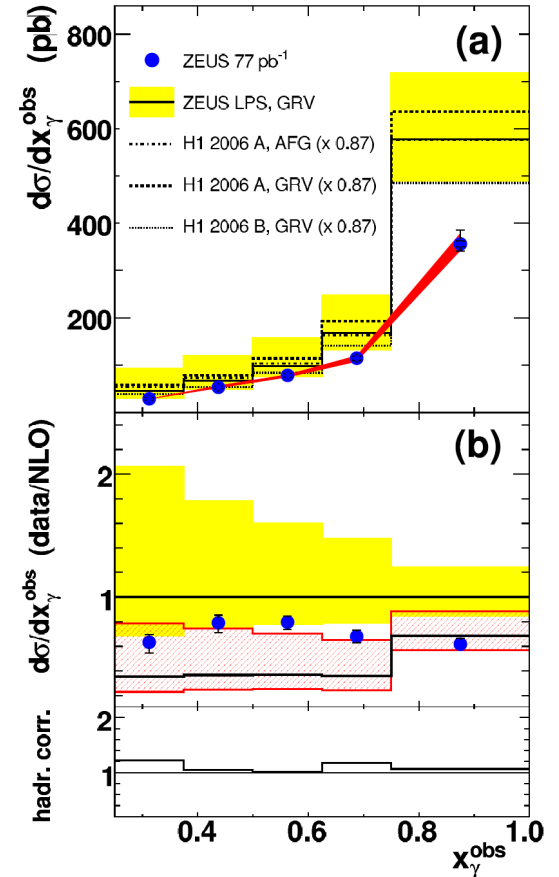

H1 96-97: $E_T^{jet1} > 5 \text{ GeV}$ suppression by **0.5**

ZEUS 99-00: $E_T^{jet1} > 7.5 \text{ GeV}$ **weak** (0.6 -0.9) suppression

Possible explanation: **different E_T ranges** (ZEUS@DIS07)

Neither experiment sees difference between direct and resolved regions, in contrast to theoretical expectations.

Introduction

γp / DIS - motivation for E_T dependence

Double ratio of $(\text{data/NLO})^{\gamma p} / (\text{data/NLO})^{\text{DIS}}$

based on 96-97 data from: [Eur.Phys.J. \(2007\) C51:549-568](#)

H1 Diffractive Dijet Production

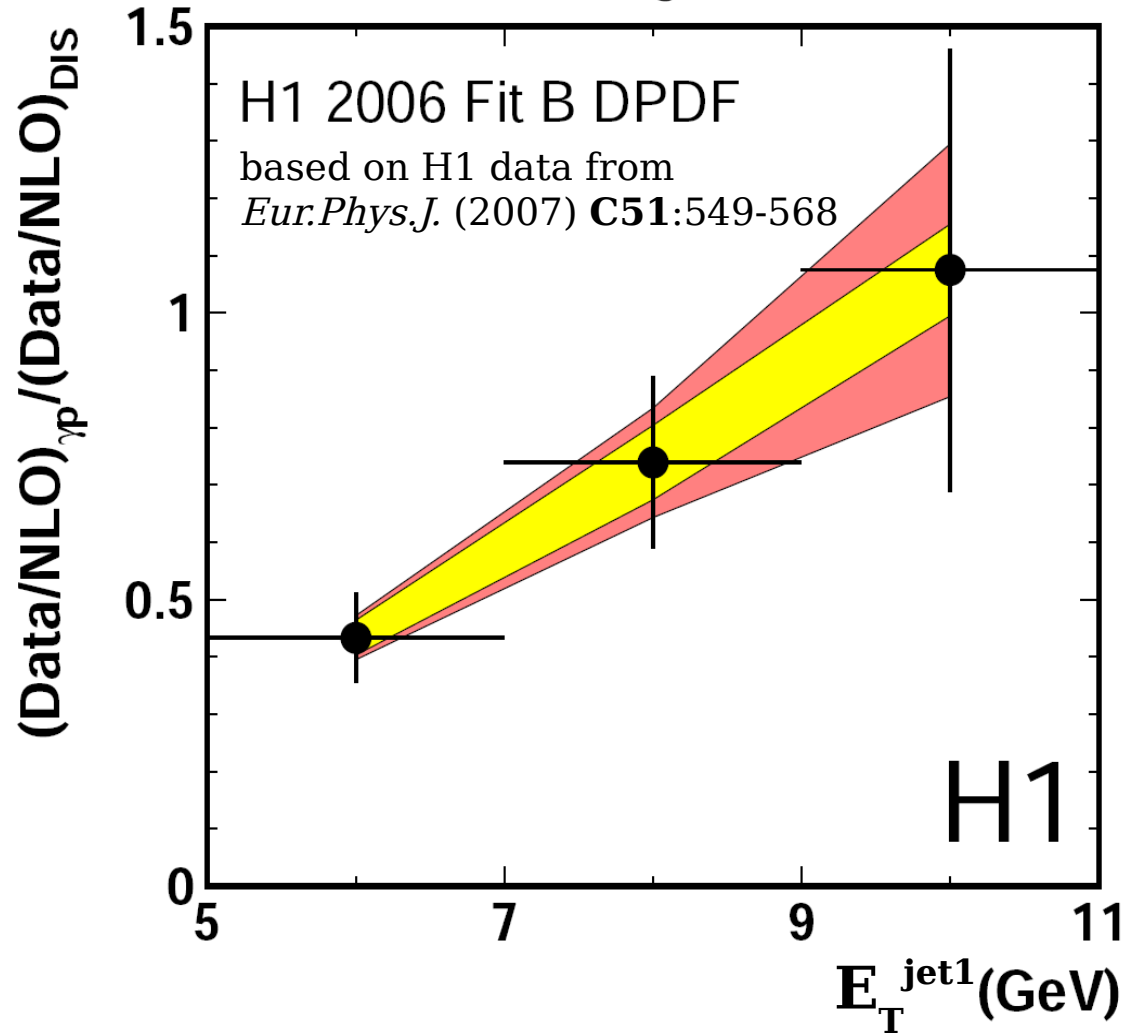

Further suggestion of possible dependence of the gap survival on the E_T range.

Large uncertainties dominated by statistics.

DPDF uncertainty cancels in the double ratio.

The plot not presented, so far – based on published data.

Data and Event Selection (1/2)

- Analysis based on 99-00 e+ HERA data.
- Integrated luminosity $\sim 54 \text{ pb}^{-1}$ (three times higher than prev. H1 analysis).
- Outgoing electron is tagged in an electron tagger.
- Diffractive events selected by **Large Rapidity Gap (LRG)**.

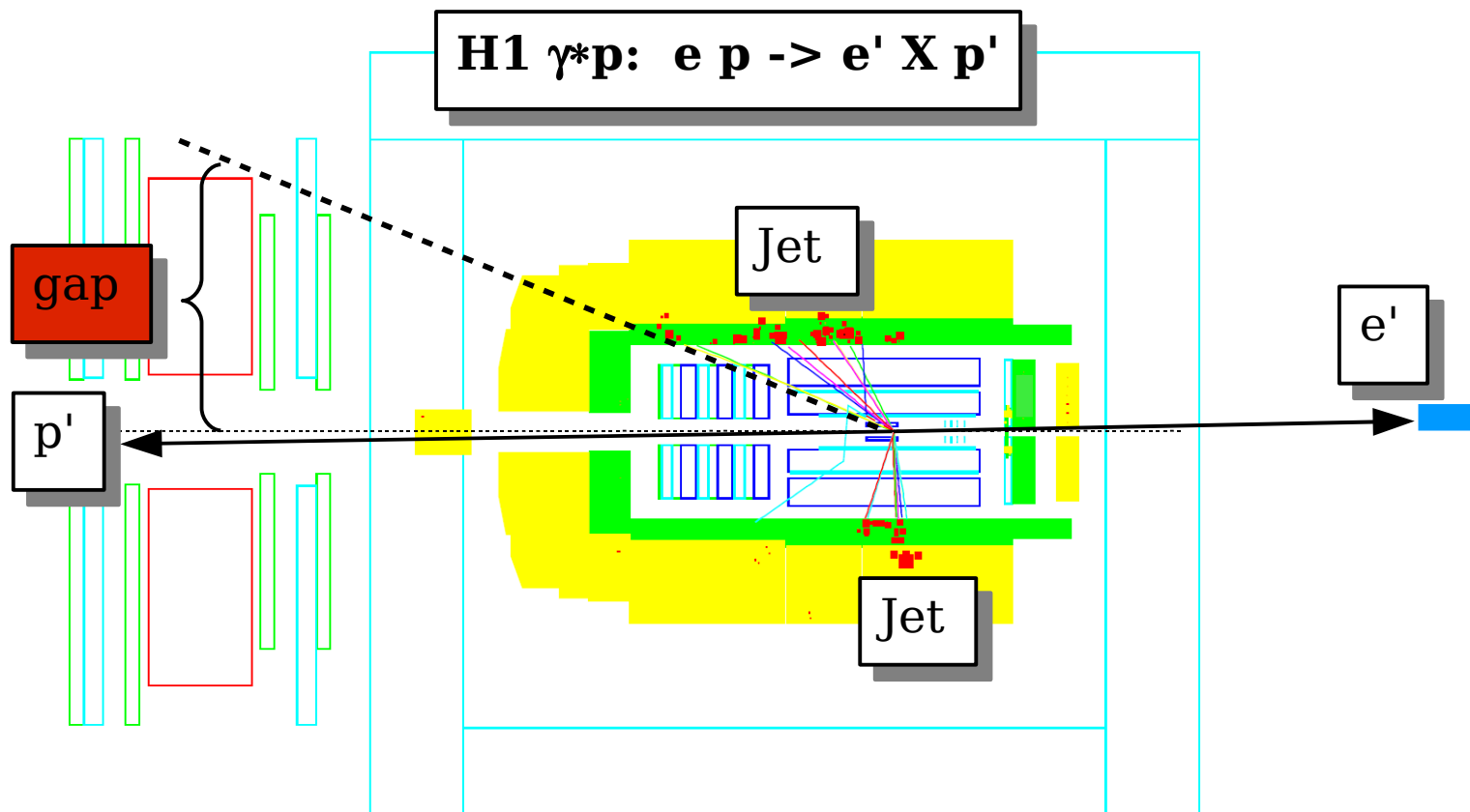

Data and Event Selection (2/2)

Measurements are carried out in two kinematic ranges.

low E_T

high E_T

$$E_T^{\text{jet1}} > 5 \text{ GeV}$$

$$E_T^{\text{jet1}} > 7.5 \text{ GeV}$$

$$E_T^{\text{jet2}} > 4 \text{ GeV}$$

$$E_T^{\text{jet2}} > 6.5 \text{ GeV}$$

$$-1 < \eta^{(\text{jet 1 and 2})} < 2$$

$$-1.5 < \eta^{(\text{jet 1 and 2})} < 1.5$$

$$x_{\text{IP}} < 0.03$$

$$x_{\text{IP}} < 0.025$$

limited by the e-tagger acceptance

$$\left\{ \begin{array}{l} 0.3 < y_e < 0.65 \\ Q^2 < 0.01 \text{ GeV}^2 \end{array} \right.$$

proton dissociation is allowed

$$\left\{ \begin{array}{l} |t| < 1 \text{ GeV}^2 \\ M_Y < 1.6 \text{ GeV} \end{array} \right.$$

different from ZEUS

$$\left\{ \begin{array}{l} 0.3 < y_e < 0.65 \dots 0.2 < y_{\text{JB}} < 0.85 \\ Q^2 < 0.01 \text{ GeV}^2 \dots Q^2 < 1 \text{ GeV}^2 \end{array} \right. \text{ZEUS}$$

$$|t| < 1 \text{ GeV}^2$$

$$M_Y < 1.6 \text{ GeV}$$

Theoretical Predictions

The measured cross sections are compared with NLO QCD calculations: GRV γ PDFs, $N_f=5$, $\Lambda_4=0.228$ MeV, $\mu_r=\mu_f=E_T^{\text{jet1}}$

- Frixione-Ridolfi program: [H1 2006 DPDF Fit A & B](#) ... Eur.Phys.J.C48:715-748,2006
[H1 2007 DPDF Fit Jets](#) ... JHEP 0710:042,2007
- Klasen & Kramer program calculations
(provided by Michael Klasen): [H1 2006 DPDF Fit B](#)

More than one DPDF fits used in order to estimate the effect of DPDF uncertainties.

Hadronization corrections are calculated by means of a LO Rapgap MC generator. The results are compared at the level of stable hadrons.

Results

H1 PRELIMINARY

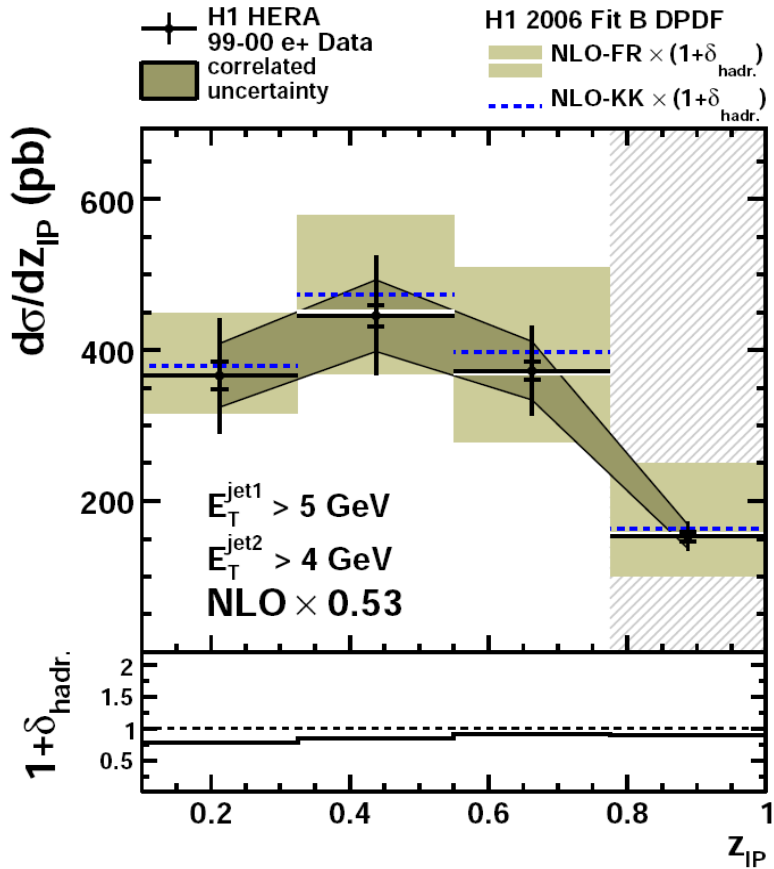

Differential cross sections in z_{IP}

$$Z_{IP} \sim \frac{\sum_{jets} (E + p_z)}{2 \cdot E_{proton} \cdot X_{IP}}$$

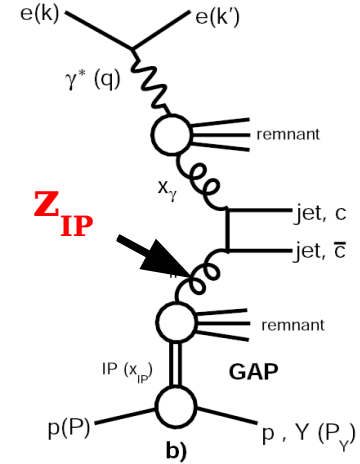

Global suppression (or survival probability) ~ 0.5 confirming previous H1 result.

Best shape description by Fit B.

DPDF uncertainties are small at low z_{IP} but large at high z_{IP} .

Last z_{IP} bin is beyond the range of DPDF fits so the predictions must be taken cautiously.

H1 PRELIMINARY

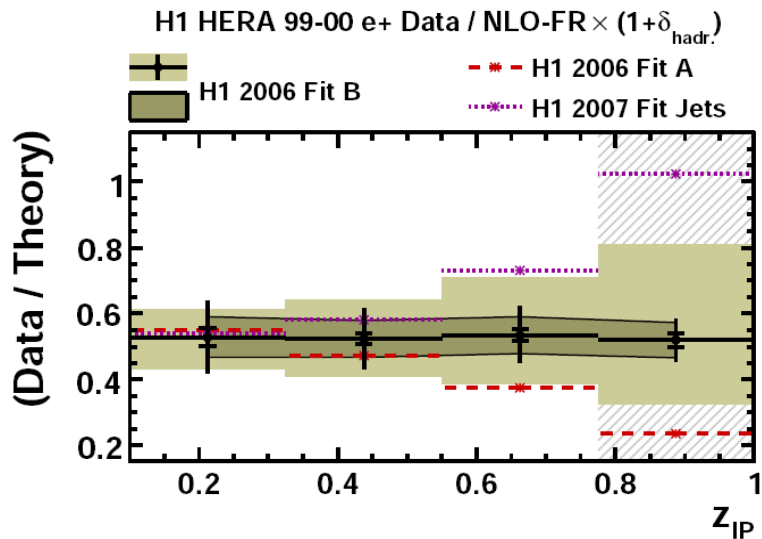

H1 PRELIMINARY

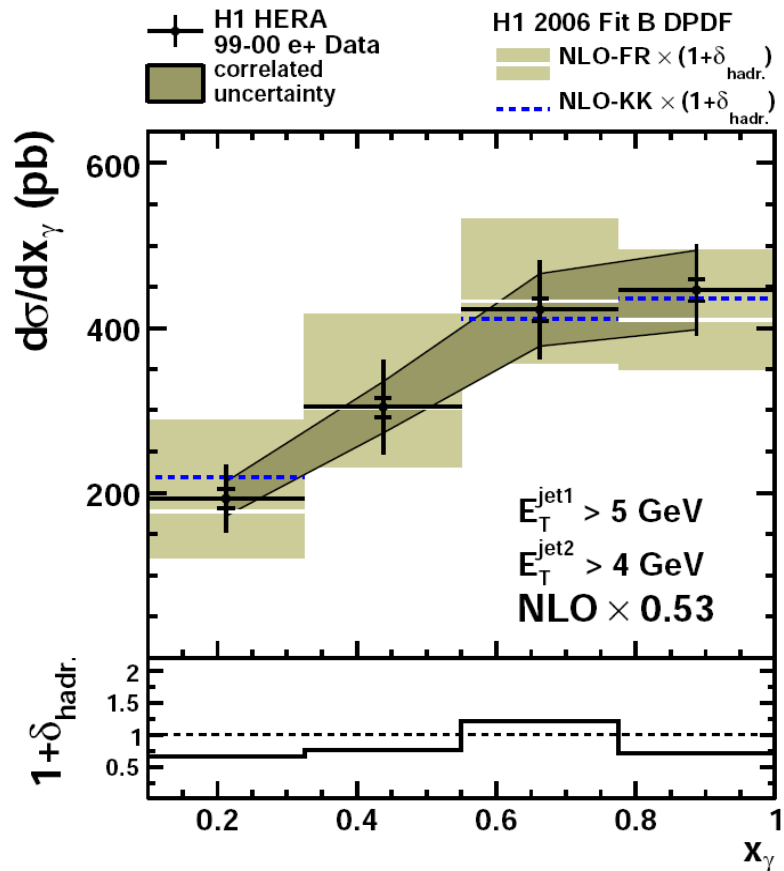

H1 PRELIMINARY

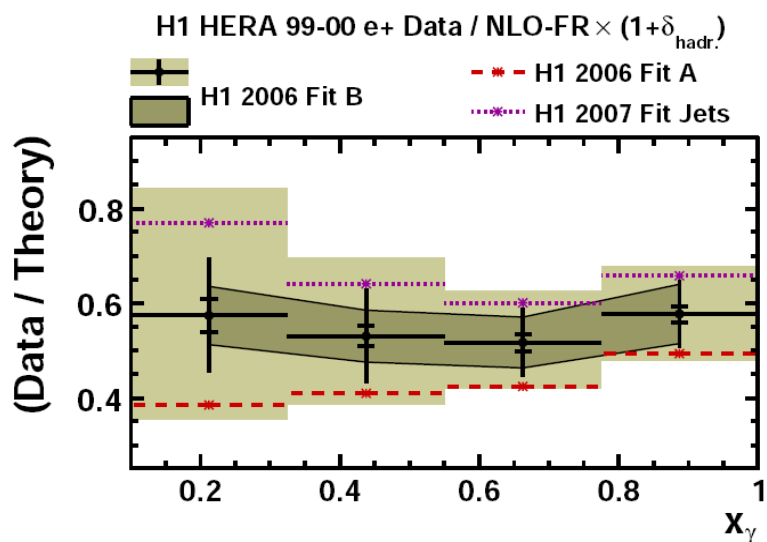

Differential cross sections in x_γ

$$X_\gamma \sim \frac{\sum_{jets} (E - p_z)}{\sum_{HFS} (E - p_z)}$$

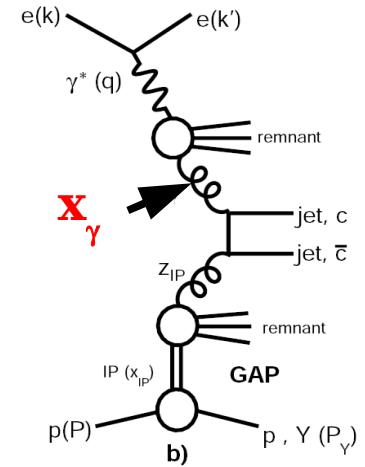

There is no evidence for any difference in survival probabilities for resolved and direct photons.

Integrated survival probabilities:

$$S_{fit B}^{FR} = \underline{0.54} \pm 0.01 (stat.) \pm 0.10 (syst.)^{+0.14}_{-0.13} (scale)$$

$$S_{fit B}^{KK} = 0.51 \pm 0.01 (stat.) \pm 0.10 (syst.)$$

$$S_{fit Jets}^{FR} = 0.65 \pm 0.01 (stat.) \pm 0.11 (syst.)$$

$$S_{fit A}^{FR} = 0.43 \pm 0.01 (stat.) \pm 0.10 (syst.)$$

Differential cross sections in E_T^{jet1}

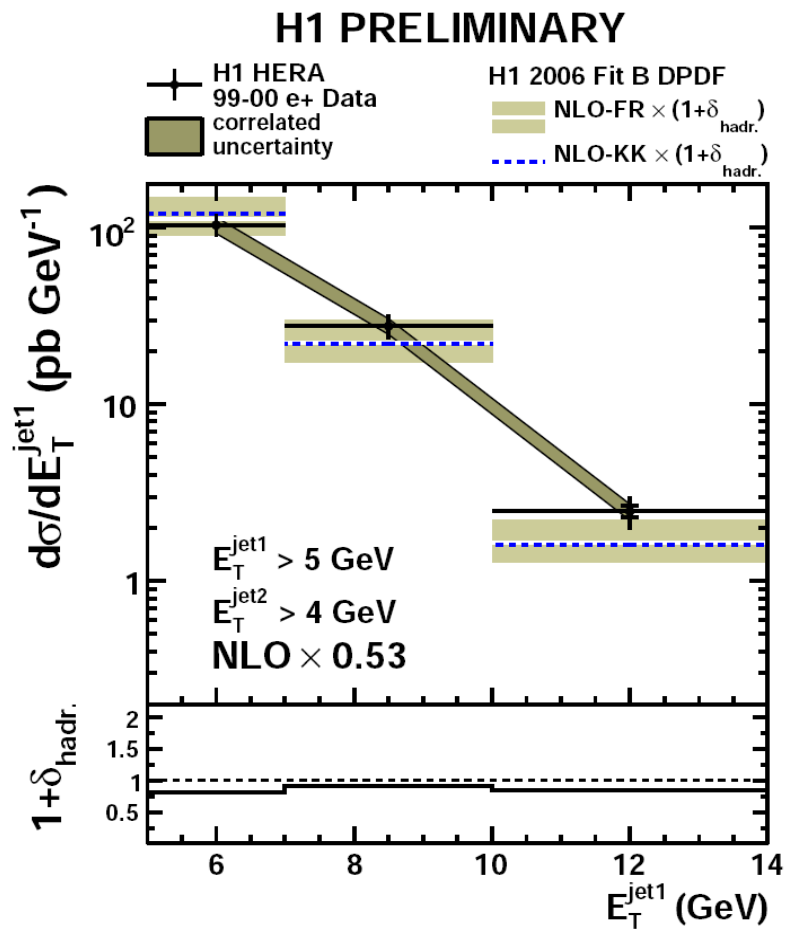

Another suggestion for harder E_T^{jet1} slope in data than NLO theory.

$$5 < E_T^{\text{jet1}} < 7 \text{ GeV}$$

within uncertainties ratio ranges between **0.3 – 0.7** (confirming previous H1 result).

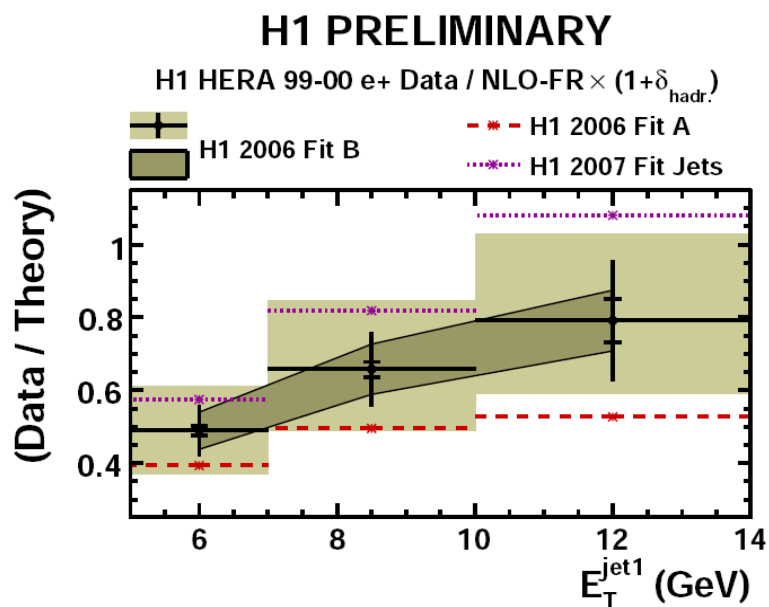

$$E_T^{\text{jet1}} > 7 \text{ GeV}$$

within uncertainties ratio is compatible with **~ 0.8** (cf. previous ZEUS result)

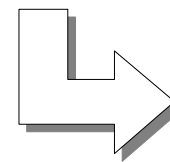

higher E_T jets

H1 PRELIMINARY

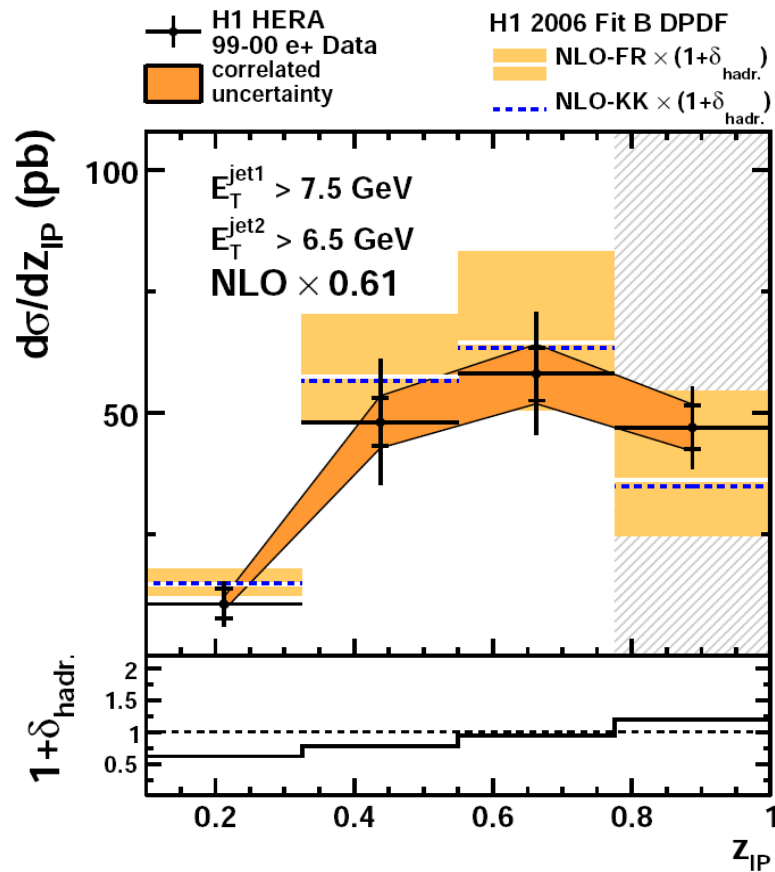

Analysis at Larger E_T z_{IP} dependence

Kinematics chosen as close as possible to ZEUS measurement.

The y range still different from ZEUS ($0.2 < y < 0.85$).

Here and for other variables Fit B continues to describe the shapes well.

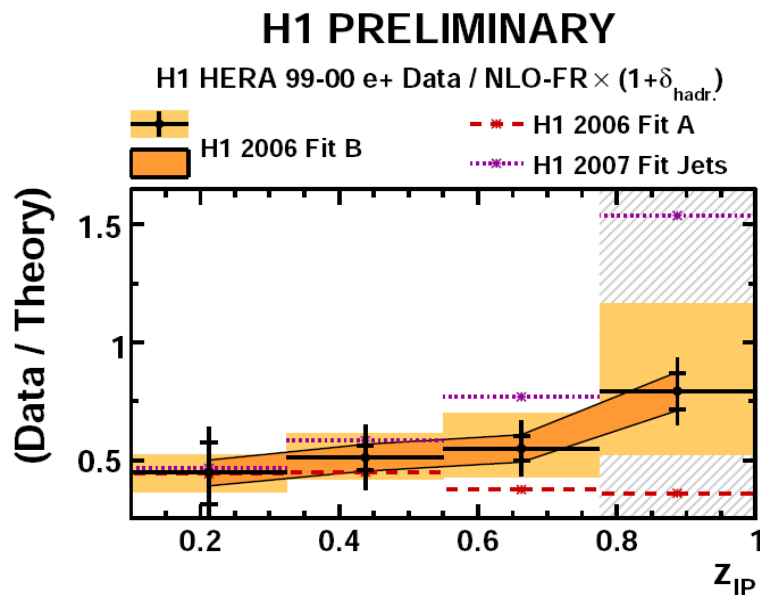

Analysis at Larger E_T

E_T^{jet1} dependence

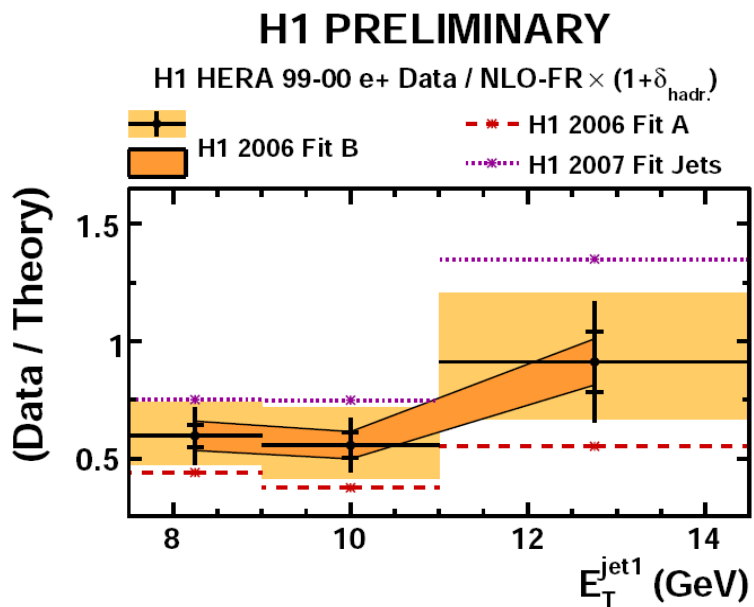
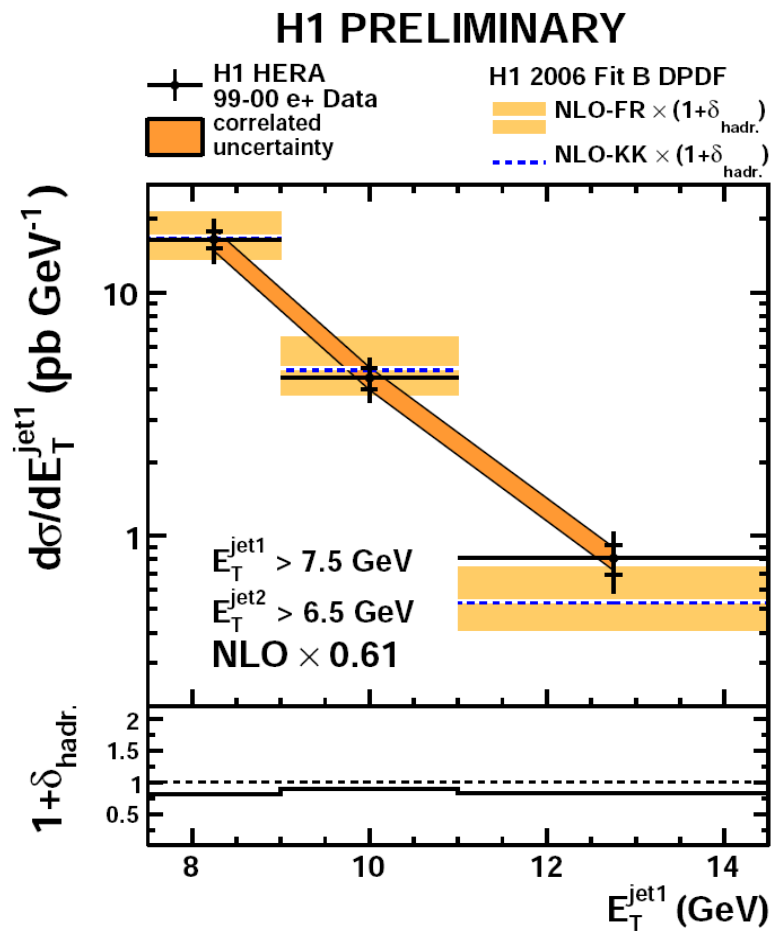

Larger integrated survival probabilities than for lower E_T cuts:

$$S_{\text{fit B}}^{\text{FR}} = \underline{0.61} \pm 0.03 \text{ (stat.)} \pm 0.13 \text{ (syst.)} {}^{+0.16}_{-0.14} \text{ (scale)}$$

$$S_{\text{fit B}}^{\text{KK}} = 0.62 \pm 0.03 \text{ (stat.)} \pm 0.14 \text{ (syst.)}$$

$$S_{\text{fit Jets}}^{\text{FR}} = 0.79 \pm 0.04 \text{ (stat.)} \pm 0.16 \text{ (syst.)}$$

$$S_{\text{fit A}}^{\text{FR}} = 0.44 \pm 0.02 \text{ (stat.)} \pm 0.09 \text{ (syst.)}$$

Similar survival probability range as to ZEUS in similar E_T range if data and DPDF uncertainties taken into account.

E_T dependence not excluded but cannot be independently verified.

H1 PRELIMINARY

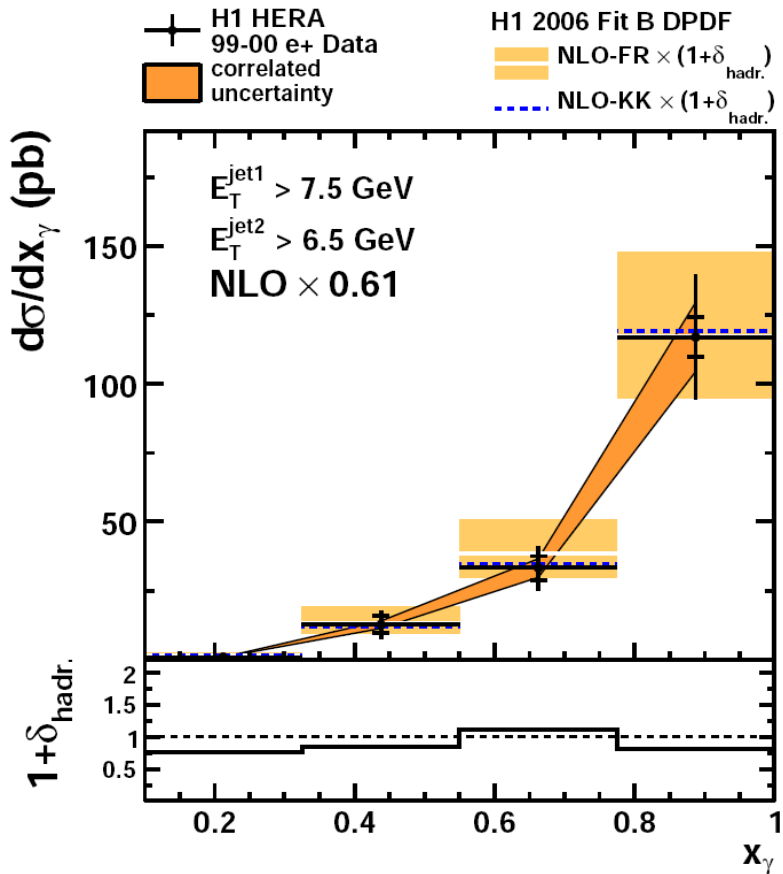

H1 PRELIMINARY

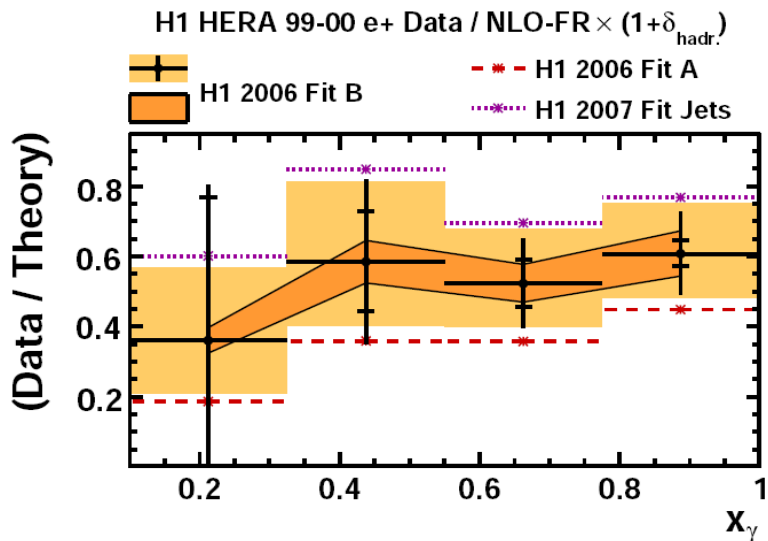

Analysis at Larger E_T

x_γ dependence

ZEUS

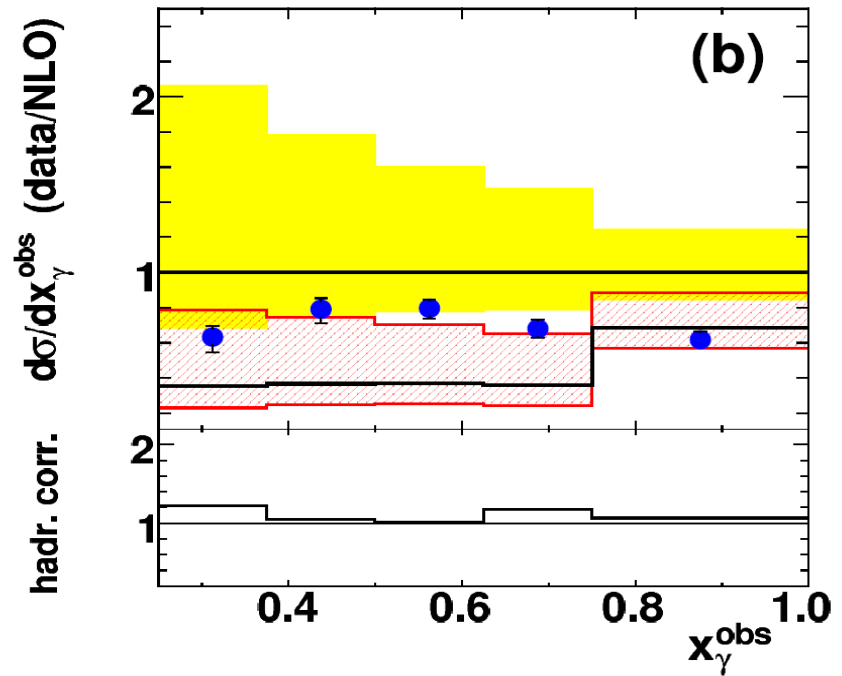

Within errors the suppression is the same for resolved and direct processes.

Summary

- (1) New H1 data yield gap survival probability significantly less than unity in some regions (low E_T)
... but consistent with recent ZEUS data (at high E_T).
- (2) Evidence that gap destruction becomes less likely if the jet kinematics is restricted into the range of higher E_T (weaker integrated suppression in the high E_T analysis).
- (3) In contrast to most expectations there is no evidence for any difference between the survival probability for the resolved and the direct processes.

**Further plots from
both analyses**

H1 PRELIMINARY

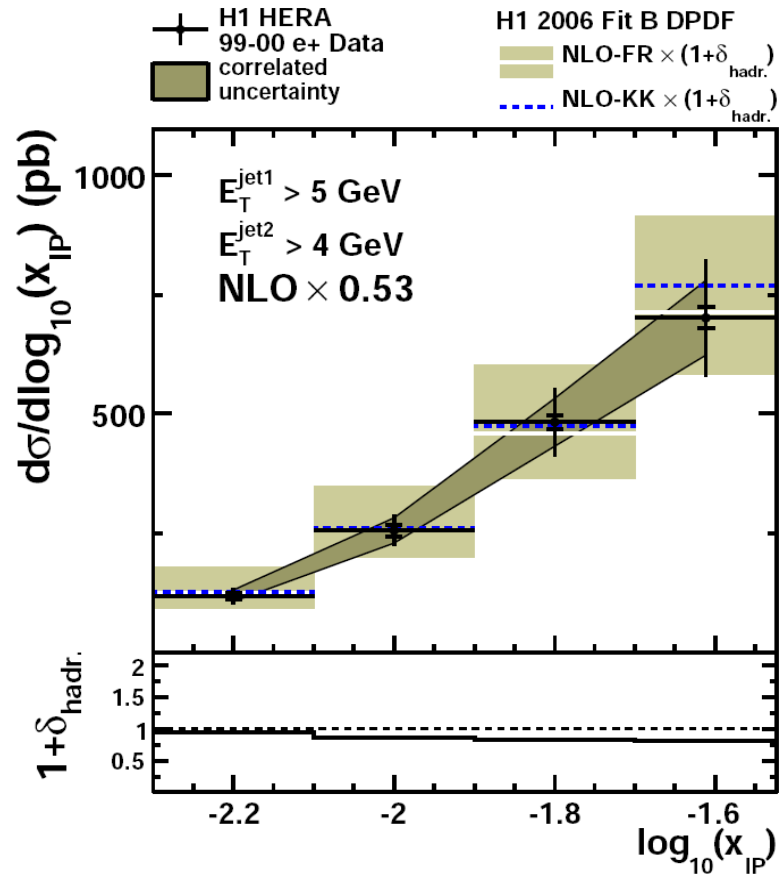

H1 PRELIMINARY

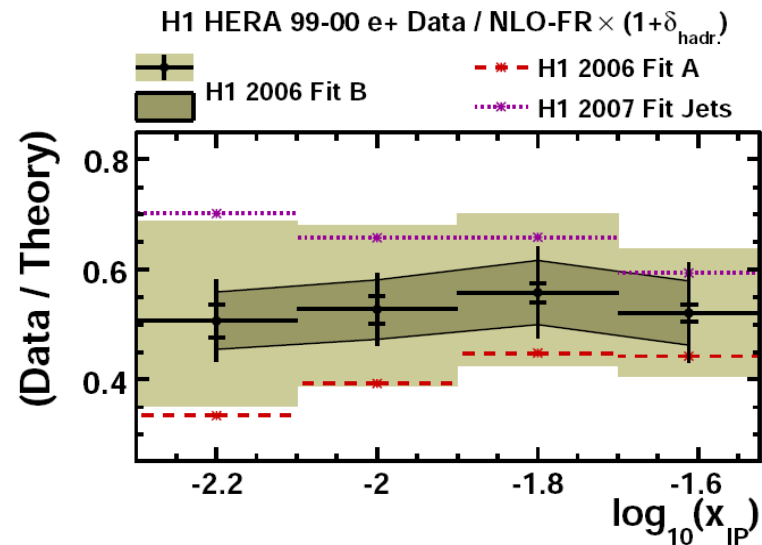

H1 PRELIMINARY

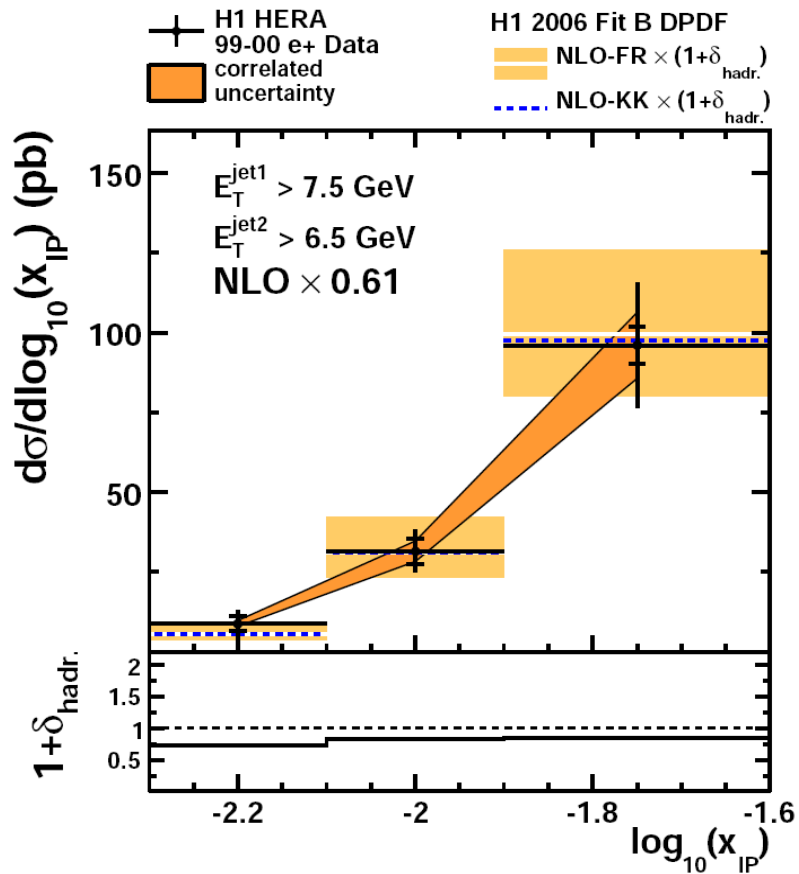

H1 PRELIMINARY

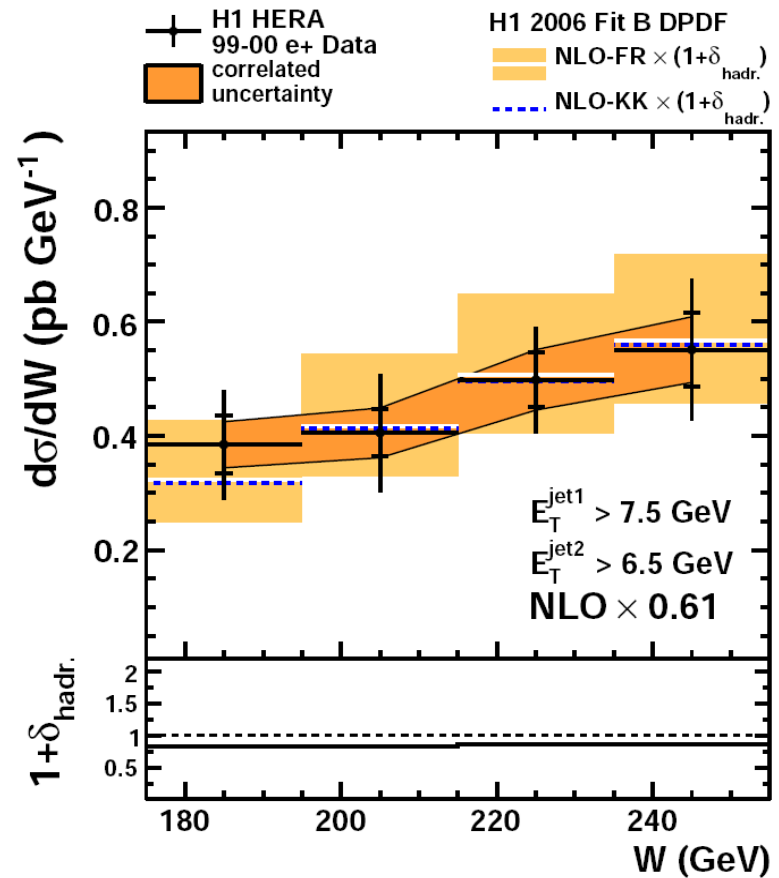

H1 PRELIMINARY

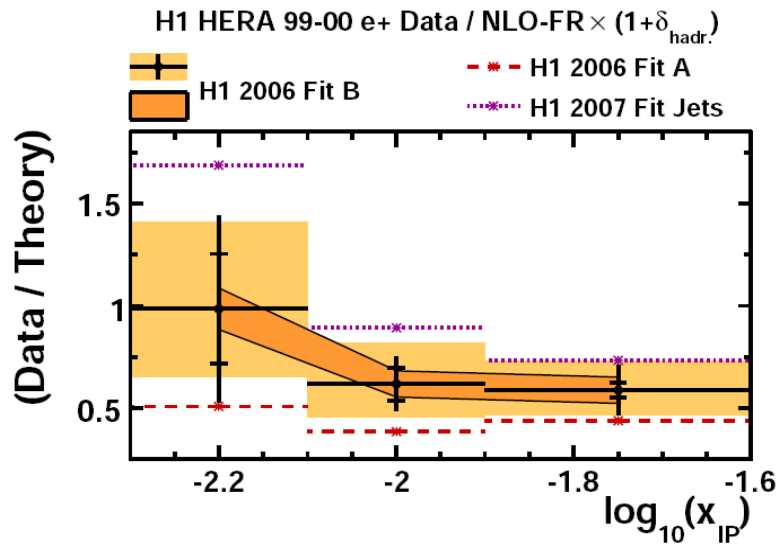

H1 PRELIMINARY

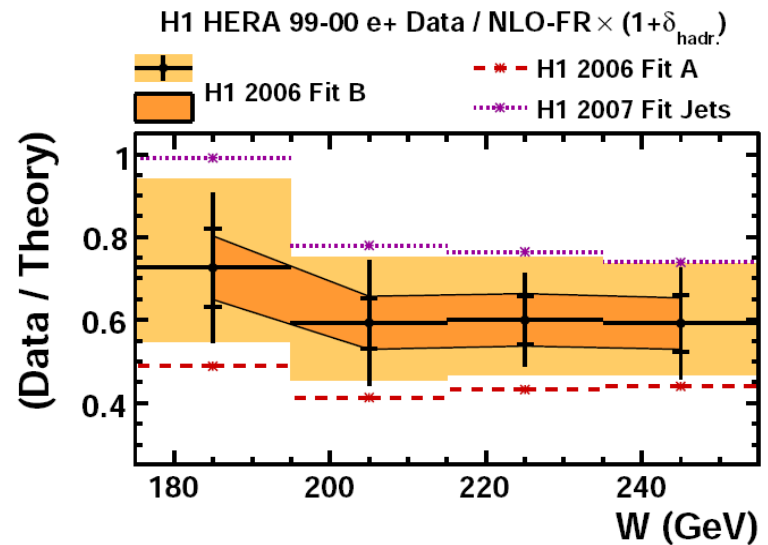

H1 PRELIMINARY

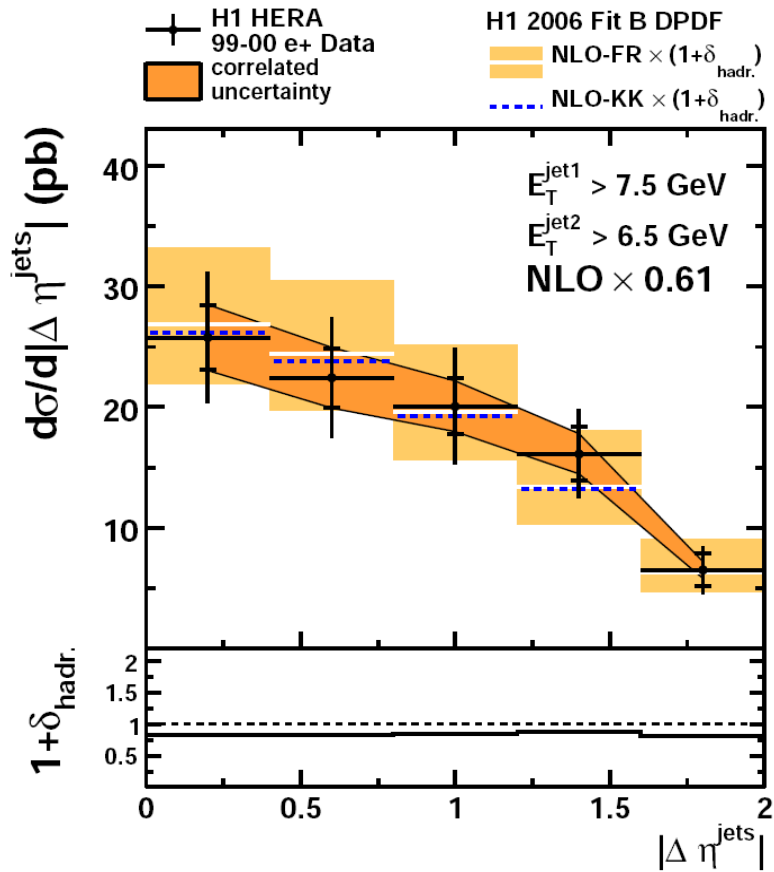

H1 PRELIMINARY

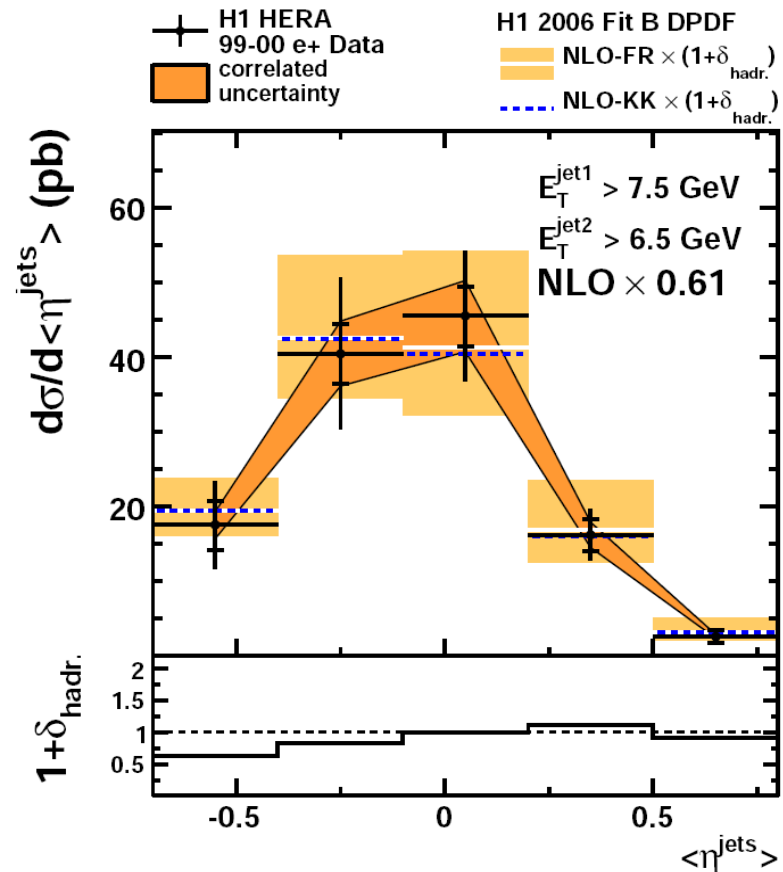

H1 PRELIMINARY

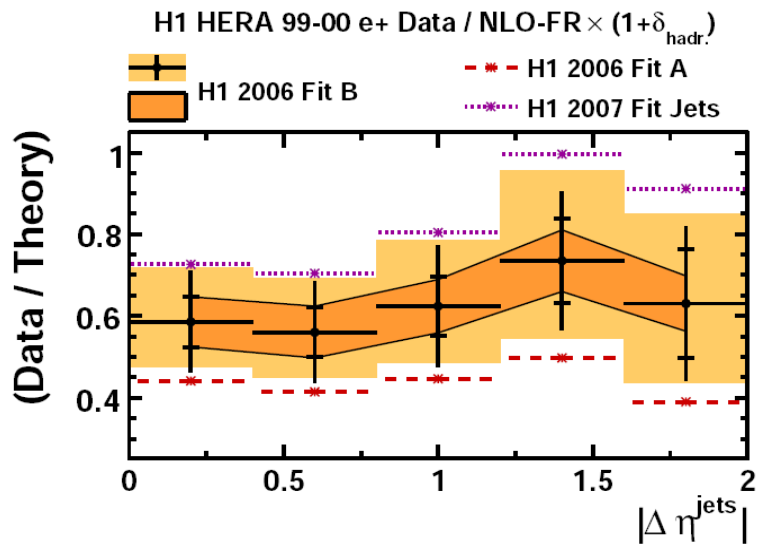

H1 PRELIMINARY

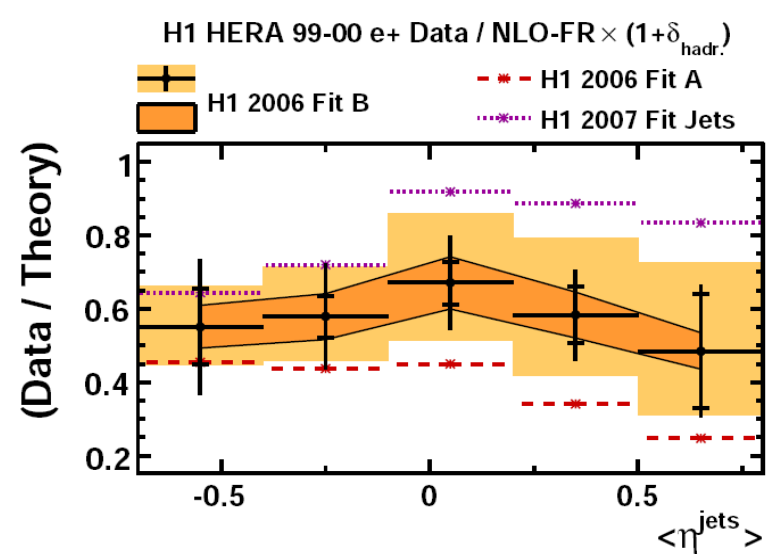

H1 PRELIMINARY

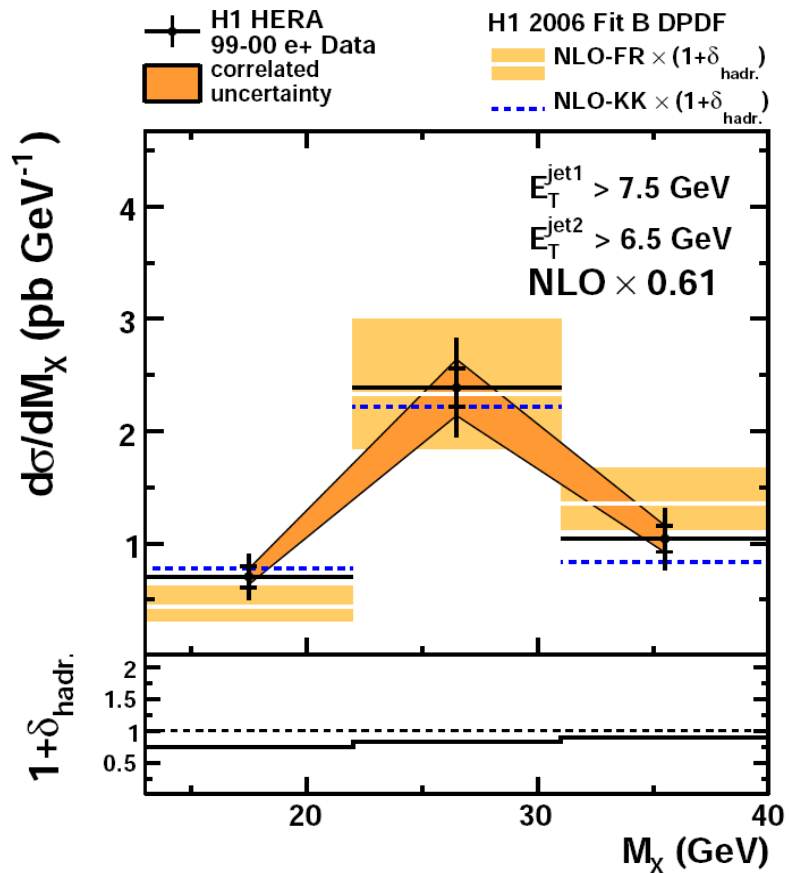

H1 PRELIMINARY

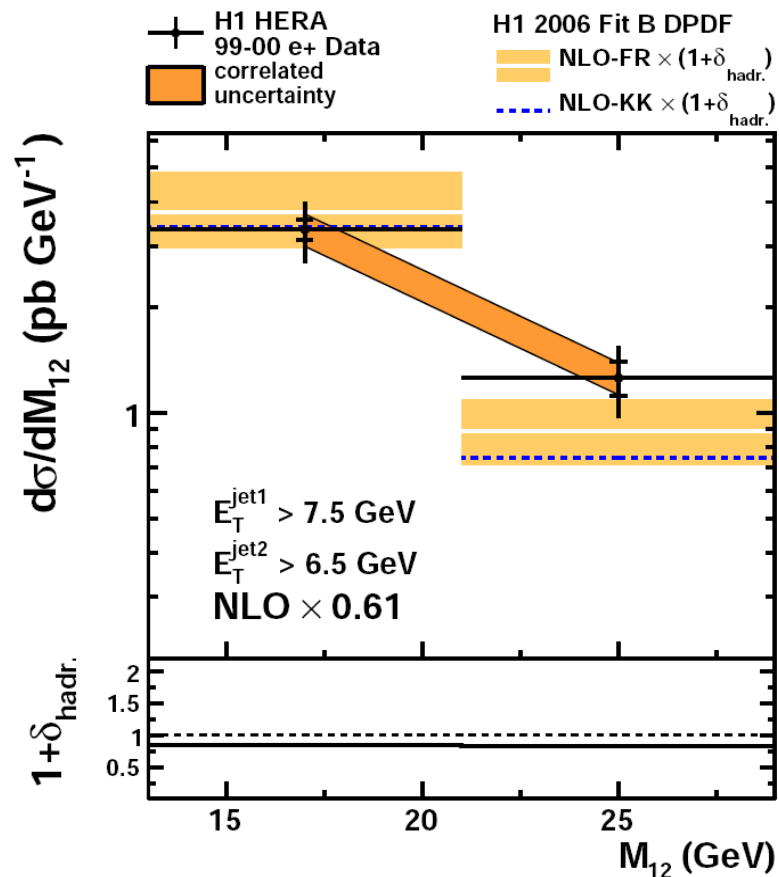

H1 PRELIMINARY

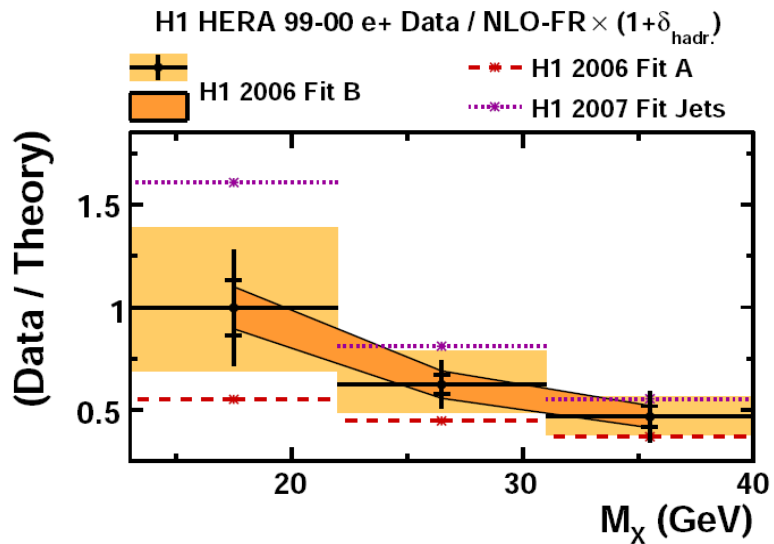

H1 PRELIMINARY

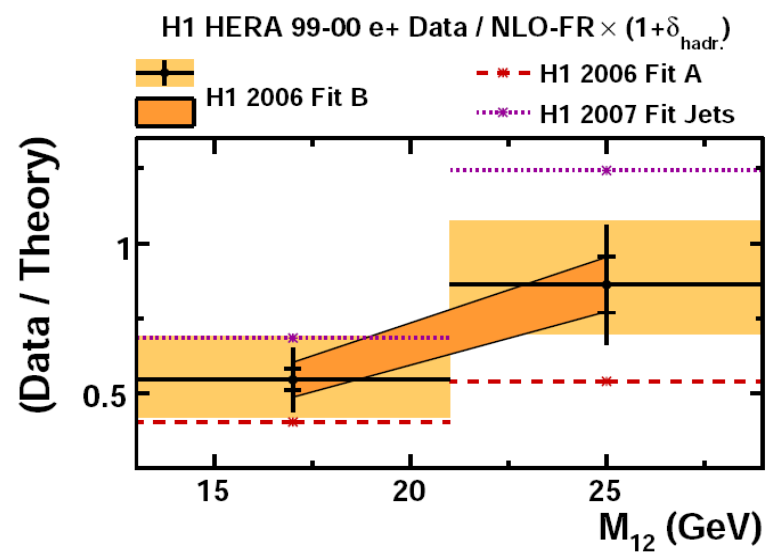

Backup

DPDF Fits

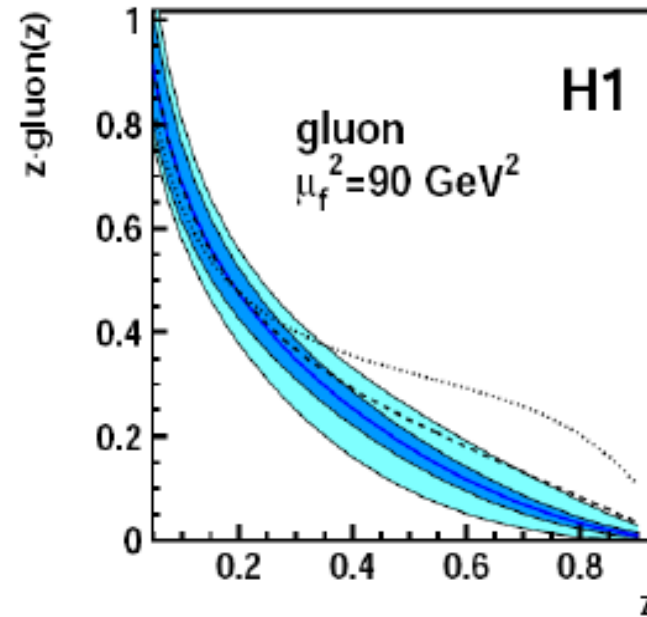
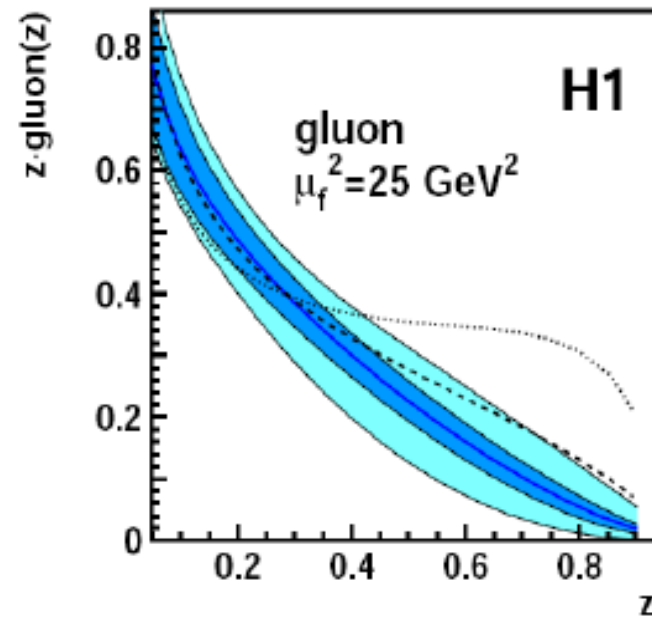
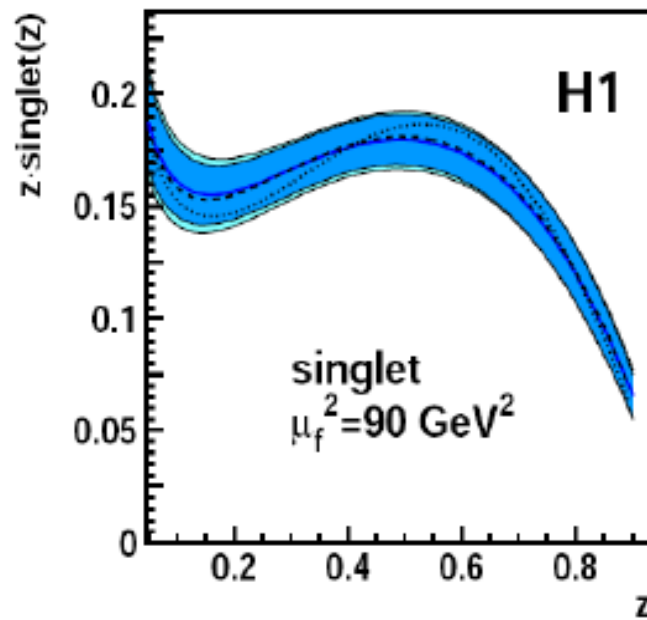
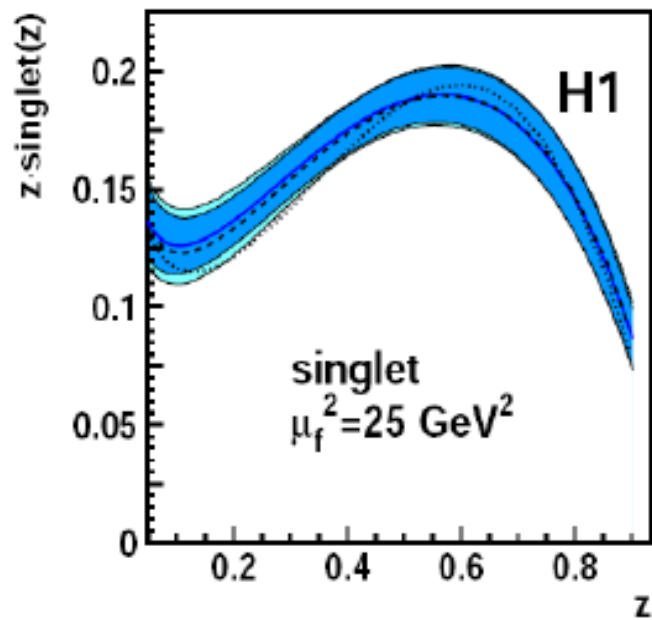

- H1 2007 Jets DPDF
- exp. uncertainty
- exp. + theo. uncertainty
- ⋯ H1 2006 DPDF fit A
- - - H1 2006 DPDF fit B