

Measurement of F_2^{cc} and F_2^{bb} at H1

Andrew Mehta

University of Liverpool



H1 Collaboration

- Motivation
- Experimental Techniques
- Inclusive charm cross section in DIS
- Inclusive beauty cross section in DIS

Motivation

DIS

Photoproduction (γp)

Direct

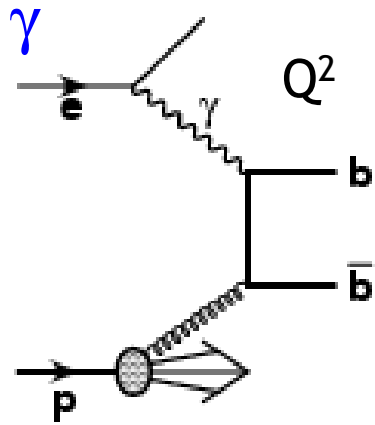

Resolved γ

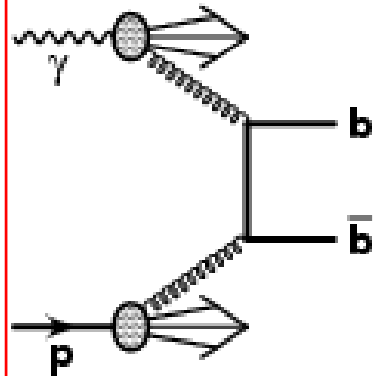

(flavour excitation)

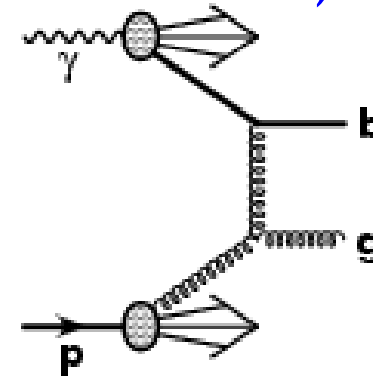
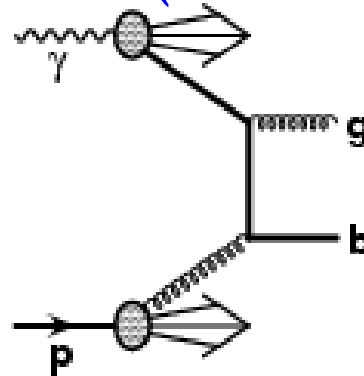

Test of perturbative QCD: multi-scale problem (Q^2, m_b^2, p_t^2)

Independent measurement of gluon

Theoretical approaches: massless, massive (FFNS) and general mass (GM-VFNS) flavour number schemes.

PDFs: F_2^{bb} measurements at high Q^2 important for LHC e.g. $bb \rightarrow H$

LO (α_s) + Parton shower: DGLAP (PYTHIA/RAPGAP), CCFM (CASCADE)

NLO (α_s^2) calculations: Fixed order (FMNR/HVQDIS), GM-VFNS PDFs

Experimental Technique

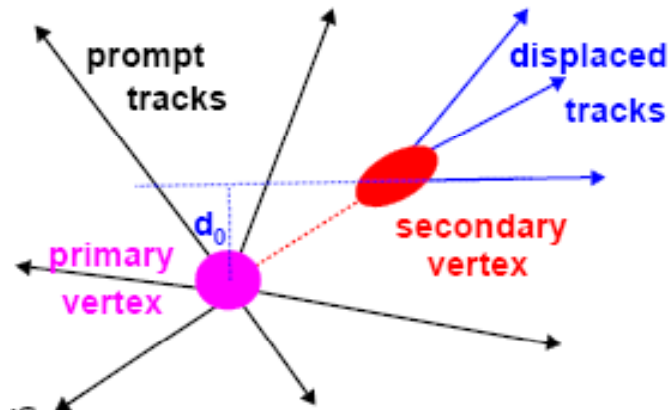

Displaced tracks

Measure impact parameter back to primary vertex.
Higher efficiency than explicit secondary vertex.
 $p_t^{track} > 0.5 \text{ GeV}$ reduces extrapolations.

Other main methods:

D^* to tag charm

Muons and jets

Use μ impact parameter combined with p_t^{rel} to tag b

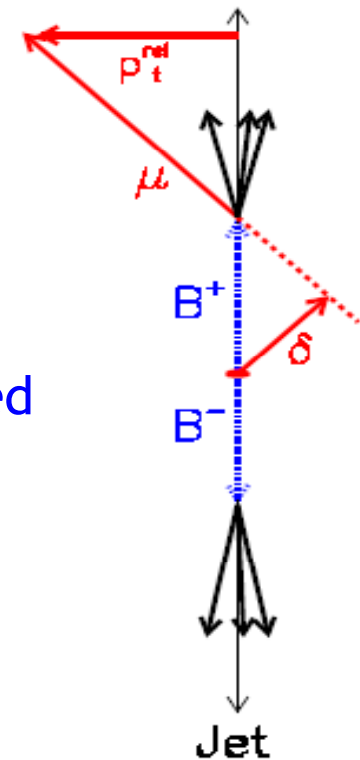

H1 Vertex Detector

Central Silicon Tracker ($30^\circ < \theta < 150^\circ$)

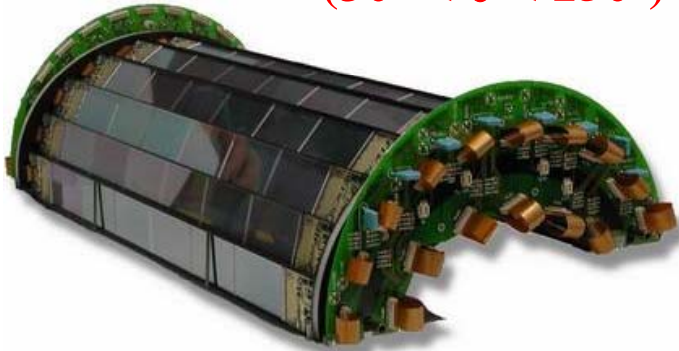

- Rebuilt to take into account HERA II beamline
- Double layer double sided strips
- Precise determination of impact parameter in transverse plane
- Resolution of $|\delta|$ for hits in both layers:

$$33 \mu\text{m} \oplus \frac{90 \mu\text{m}}{P_T / \text{GeV}}$$

Signed impact parameter δ

$$\alpha < 90^\circ \rightarrow \delta = +|\delta|$$

$$\alpha > 90^\circ \rightarrow \delta = -|\delta|$$

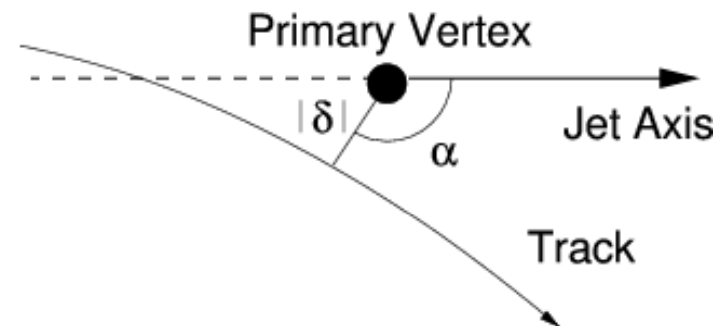
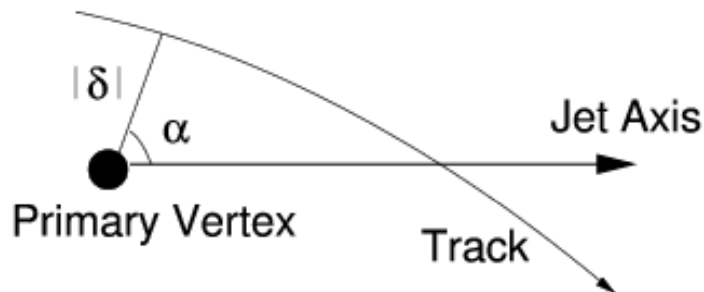

Displaced Track Method

Signed Impact parameter δ

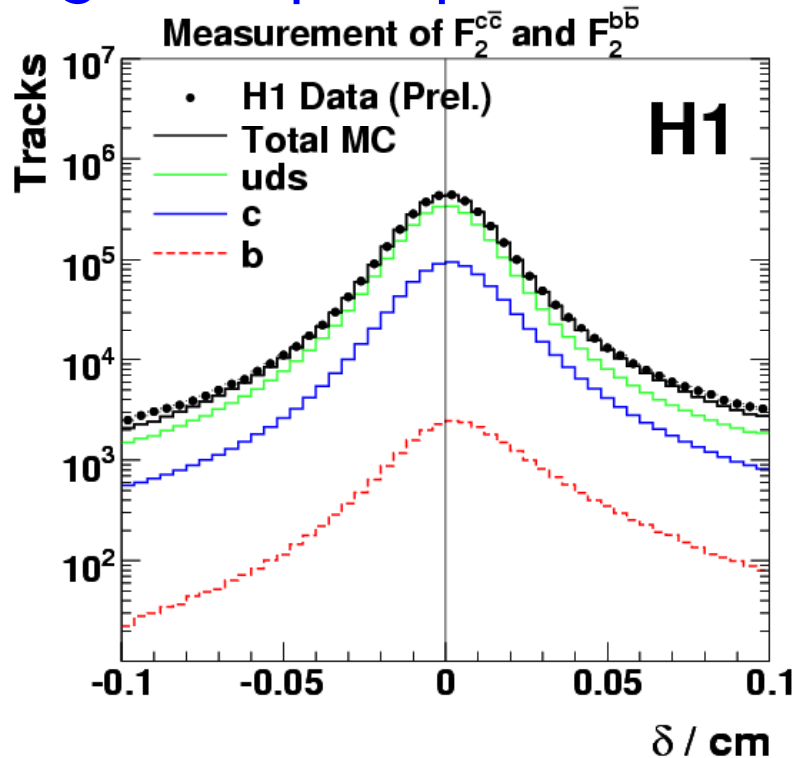

Charm and beauty asymmetric due to lifetime

Light flavours mostly symmetric

Significance

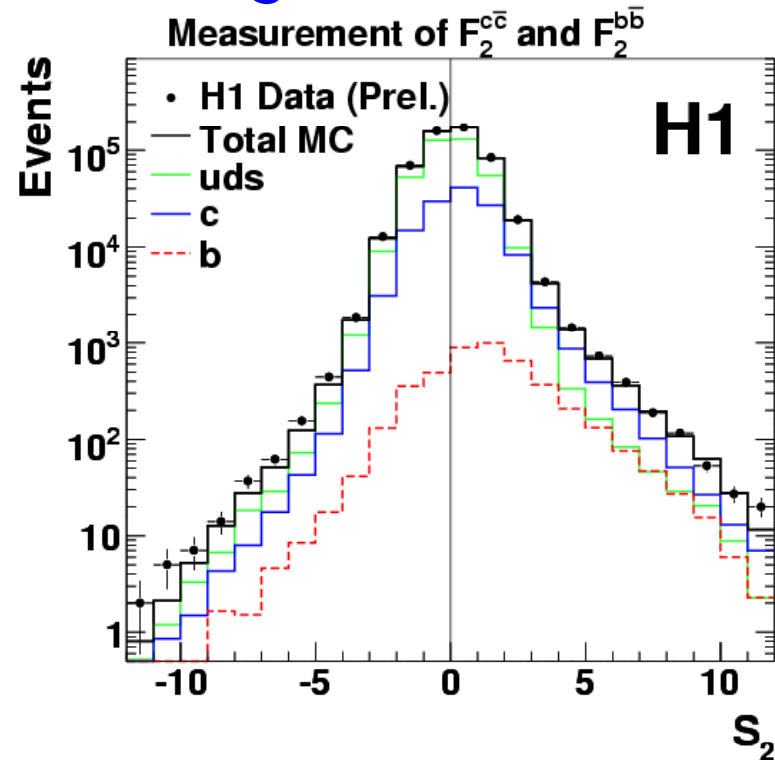

$$\text{Significance} = \delta / \sigma(\delta)$$

Displaced Track Method

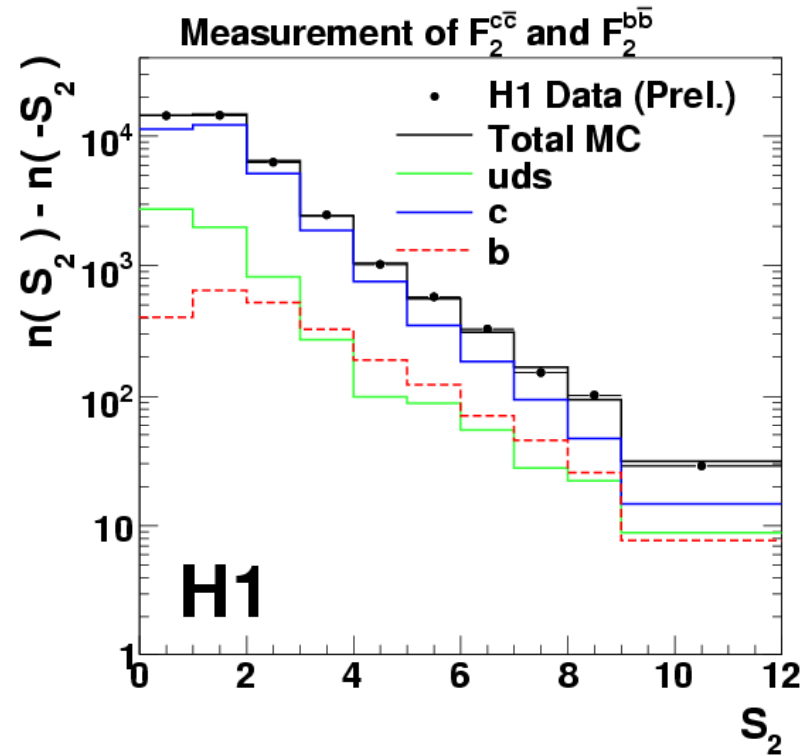
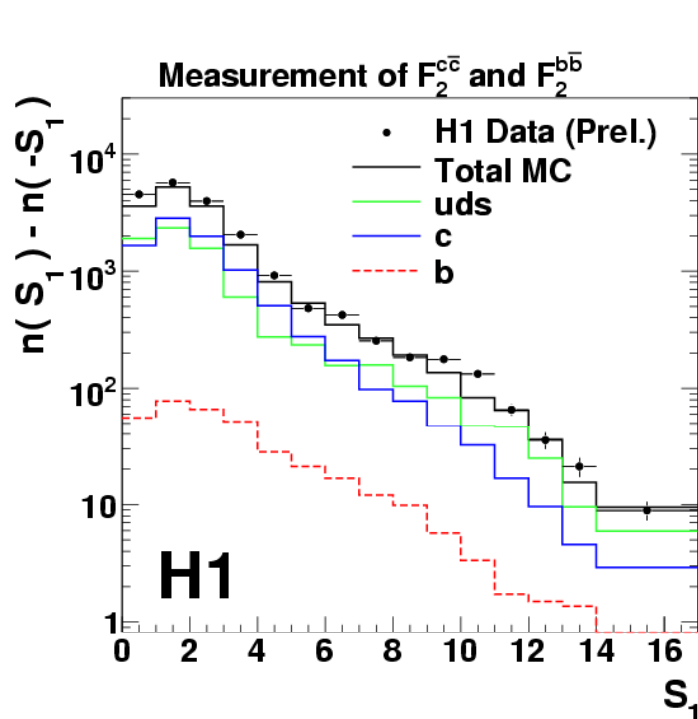

Take first and second most significant track and subtract negatives from positives.

We are left with distributions dominated by heavy flavours.

Fit distributions with templates of lights, charm and bottom to obtain the heavy flavour fractions.

Data Samples

Published data:

Eur. Phys. J. C40 (2005) 349 (hep-ex/0411046)

Eur. Phys. J. C45 (2006) 23 (hep-ex/0507081)

e⁺p data 1999-2000, $L_{\text{int}} = 57 \text{ pb}^{-1}$

Preliminary data:

e⁻p data 2006, $L_{\text{int}} = 54 \text{ pb}^{-1}$

similar method with similar statistical and systematic errors

Still to analyse:

e⁺p data 2006-2007, $L_{\text{int}} \sim 130 \text{ pb}^{-1}$

Comparisons of HERA I and HERA II

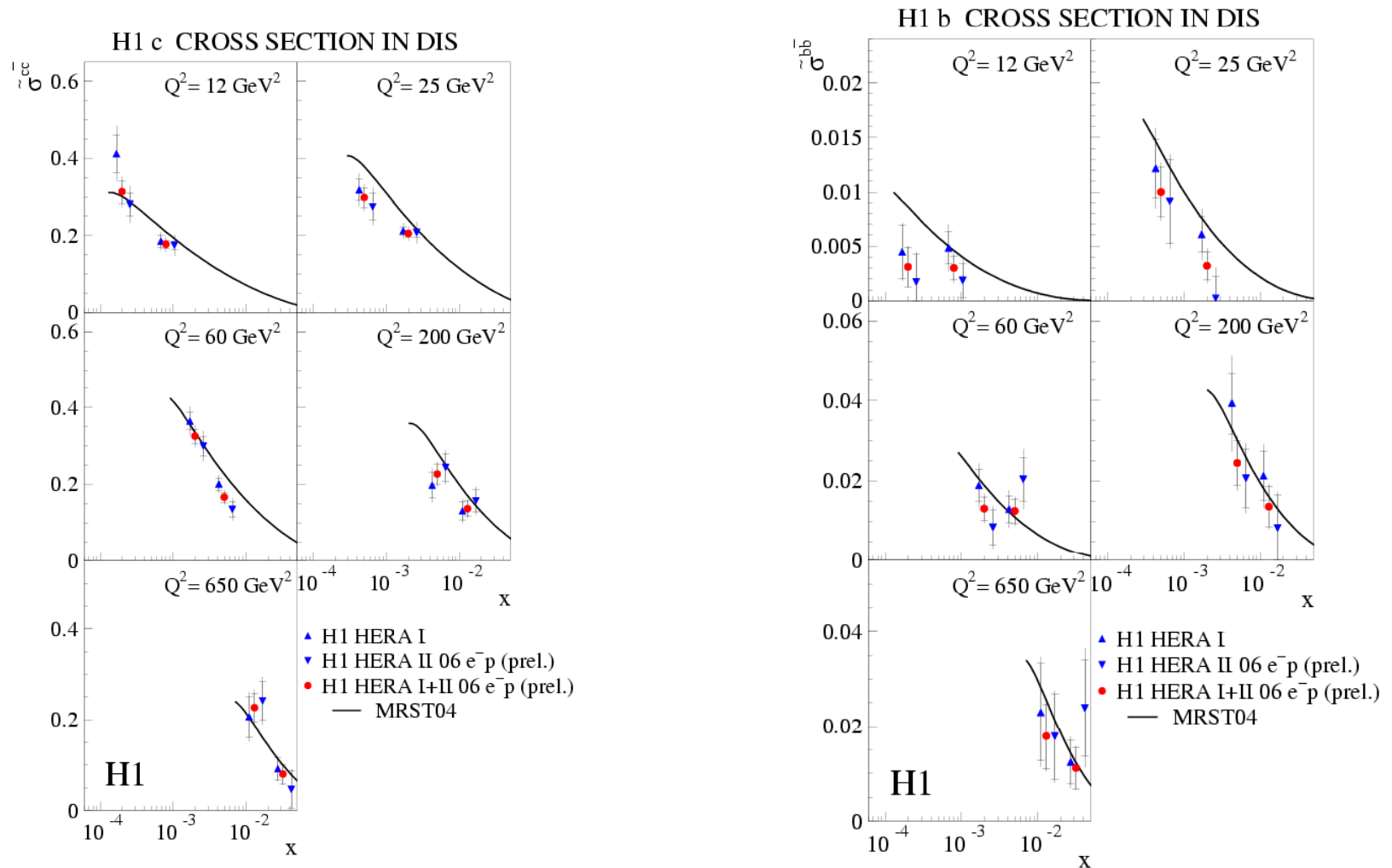

Good agreement despite a rebuild of silicon tracker!

We combine the HERA I and HERA II data.

Inclusive c cross section in DIS

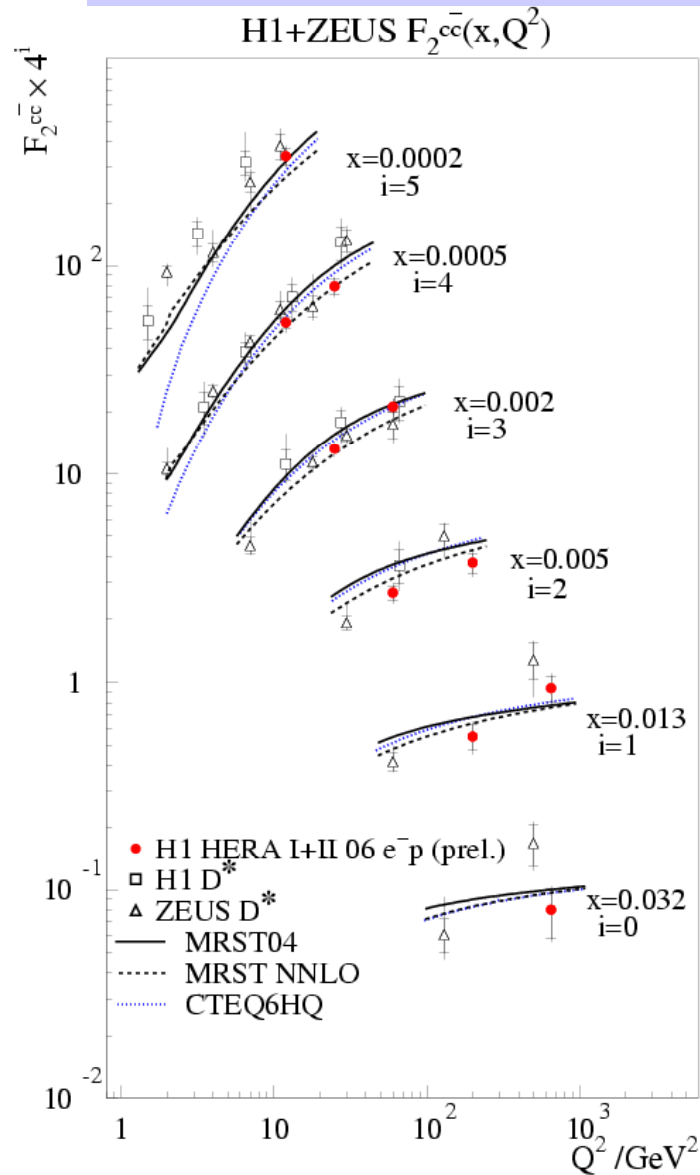

H1 data obtained using displaced track method and D^* method. Good agreement with different techniques.

Data described by QCD. More variation with models at low Q^2 near $Q^2 \sim m_c^2$.

Difficult to measure with displaced track method without large extrapolation.

GM-VFNS CTEQ6HQ, MRST04, MRST NNLO

Inclusive c cross section in DIS

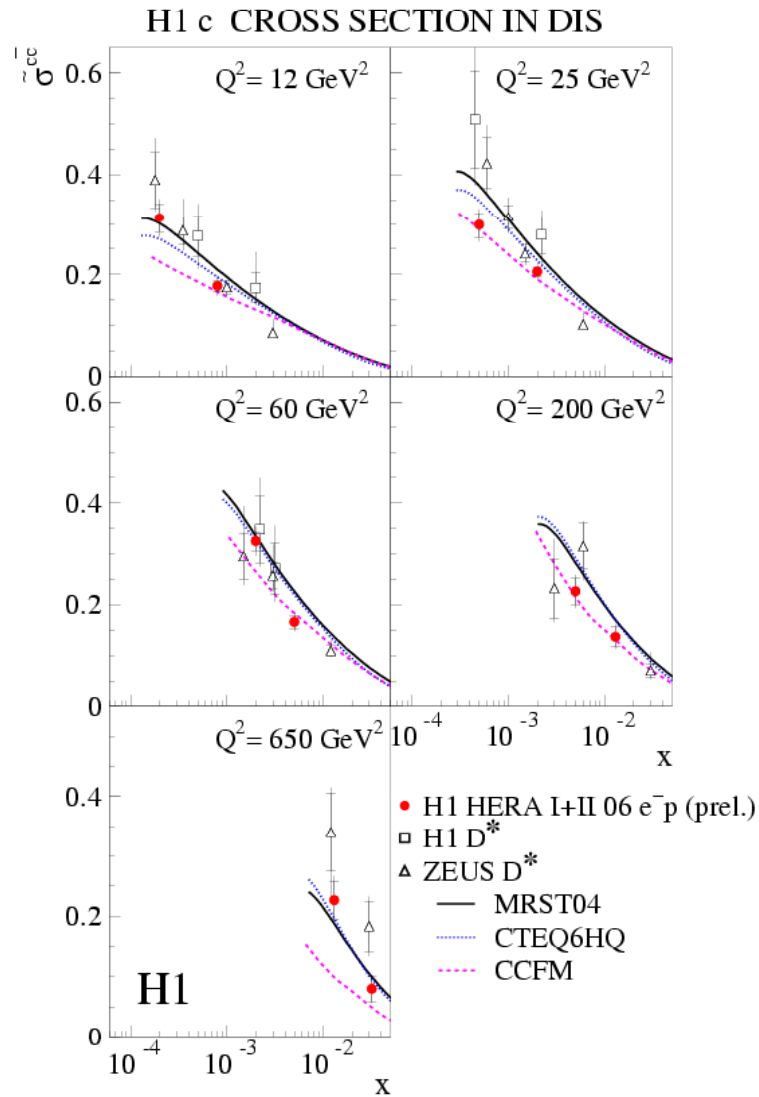

H1 data obtained using displaced track method and D^* method. Good agreement with different techniques.

Data described by QCD.

GM-VFNS CTEQ6HQ, MRST04
 Massive FFNS CCFM

Inclusive c cross section in DIS

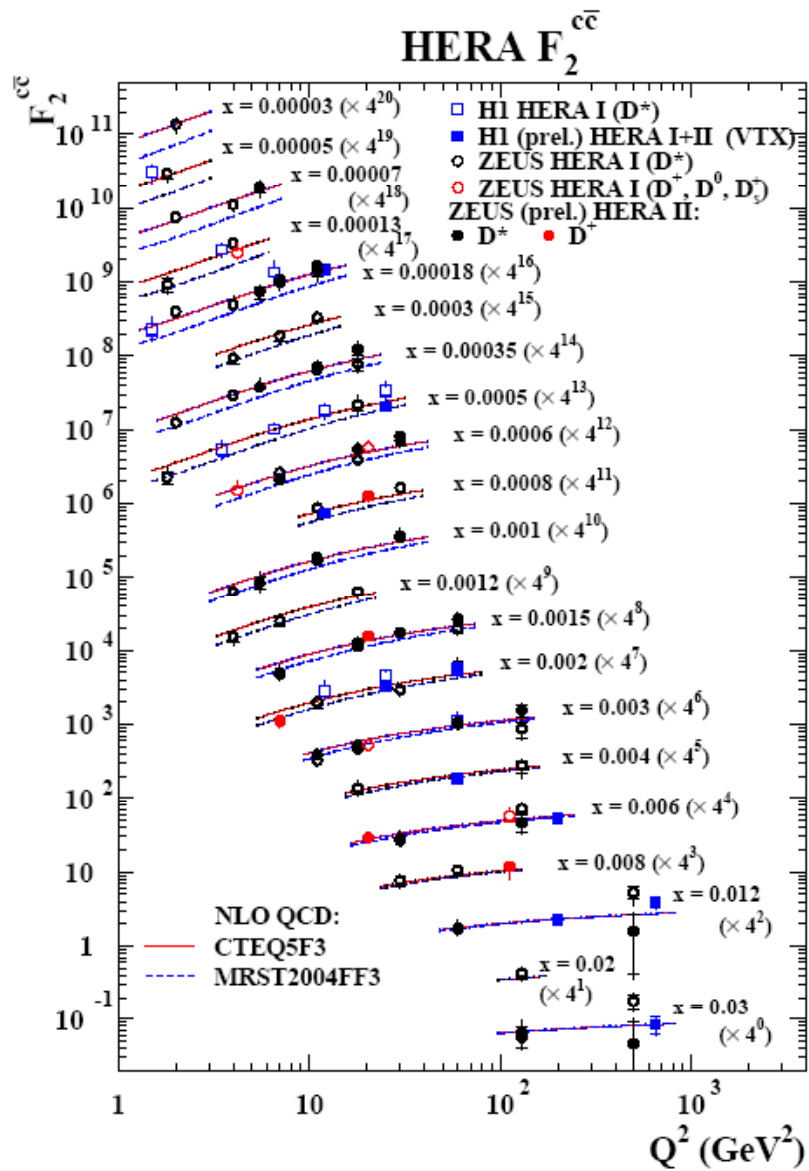

Comparison of all $F_2^{c\bar{c}}$ data
 Good agreement of all datasets

Inclusive b cross section in DIS

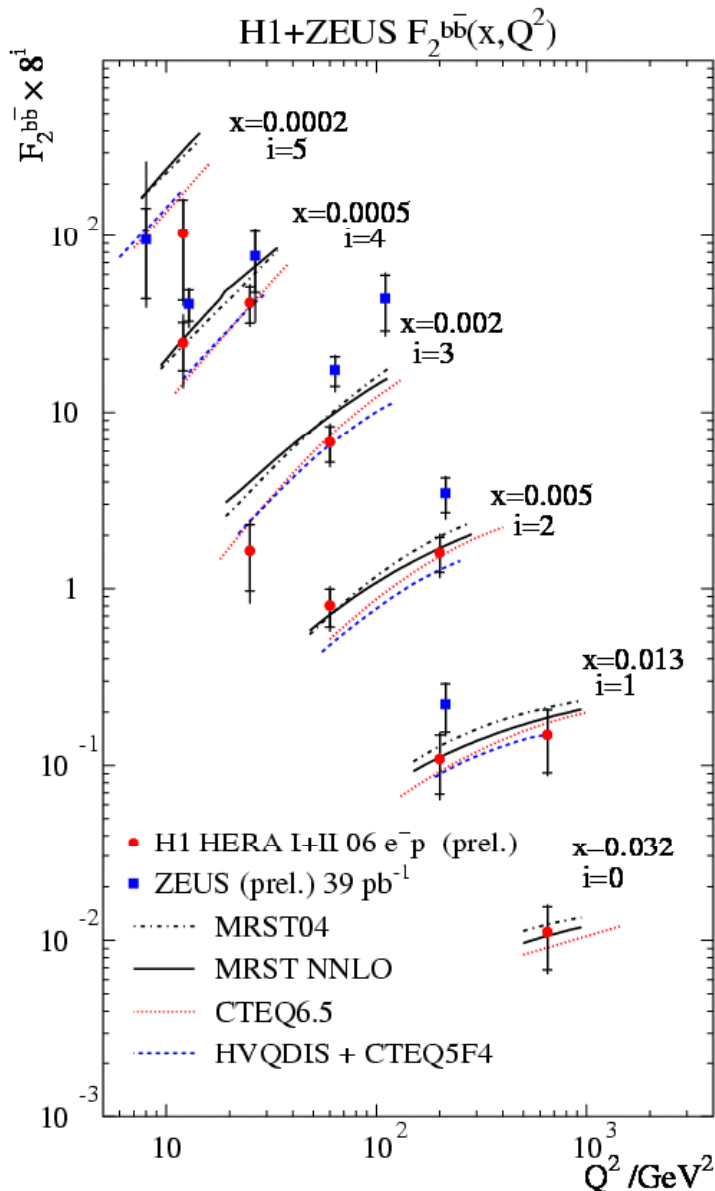

H1 data (HERA-I + HERA II) obtained using displaced track method.

ZEUS from muon plus jet.

ZEUS data tend to be a little higher than H1.

Extrapolations tend to be larger in muon plus jets, but errors are still large at the moment.

H1 Data described by QCD. Errors too big at present to discriminate but no evidence of an excess.

GM-VFNS CTEQ6HQ, MRST04, MRST NNLO

Inclusive b cross section in DIS

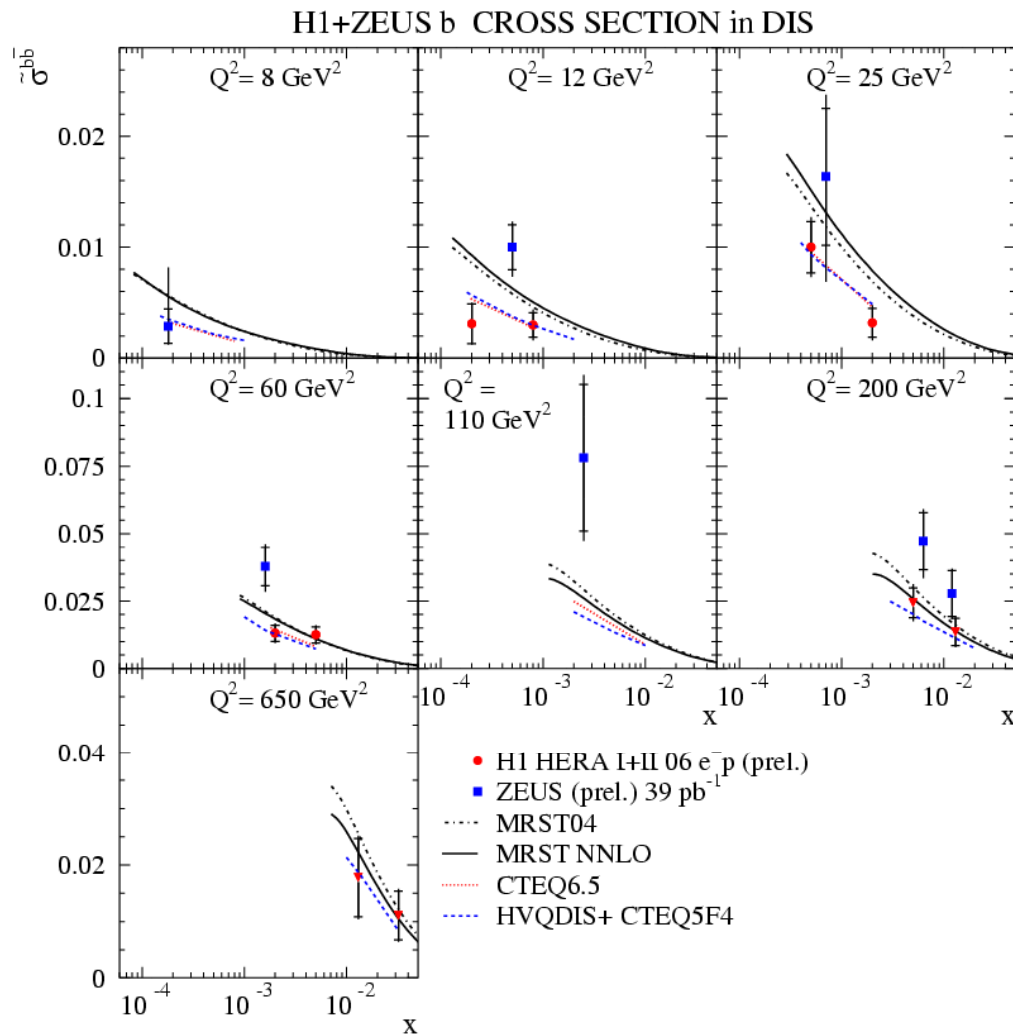

Large b mass means x_g probed for $x_g > 10^{-3}$.

b also tests perturbative scales and QCD prescription

Large differences in predictions for $Q^2 \leq m_b^2$

Not enough data to distinguish yet

Good agreement at High Q^2 where LHC measurements will be made

GM-VFNS CTEQ6HQ,
MRST04, FFNS CCFM

Conclusions

- New measurements of F_2^{cc} and F_2^{bb} with HERA II data.
- Good agreement with HERA I.
- Provide a stringent test of perturbative QCD.
- Good check of b density useful for LHC searches.
- Data so far well described by pQCD (NLO, NNLO) .
- Comparison with muon+jets not perfect, but errors large at the moment.
- Still twice as much HERA II data to be analysed. Should result in much better results than published data.