



CERN Accelerator School

Power converter requirements

Jean-Paul Burnet
CERN



- Introduction
- What do we power?
- What is special with magnet powering?
- What are the power converter requirements?
 - Magnet parameters
 - Circuit layout
 - Operation duty cycles
 - Power converter performance
- What shall contain a functional specification?
- What should I worry about?



Introduction

This talk will describe the beginning of a project for a new particles accelerator.

Before any design of power converters, the first step is to write a functional specification which describes the powering of the accelerator and the performance required by the power converters.

Many technical points have to be raised and worked for optimization.

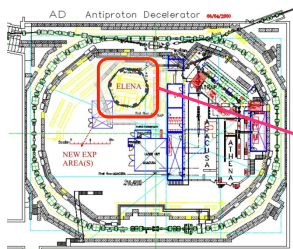

ELENA: Extra Low Energy Antiproton Ring ↗

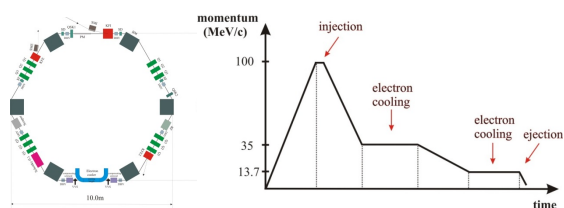

Introduction

Wikipedia: A power supply is a device that supplies electric power to an electrical load.

Power supplies are everywhere:
Computer, electronics, motor drives,...

Here, the presentation covers only the very special ones for particles accelerators.

Power supply \neq power converter
US labs use magnet power supplies
CERN accelerators use power converter
CERN experiments use power supply

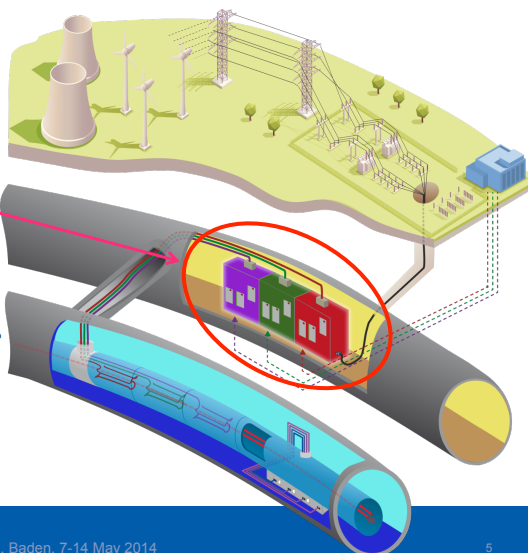

CAS, Baden, 7-14 May 2014

5

What do we power?

The main loads of a particles accelerator are the magnets and the radiofrequency system.

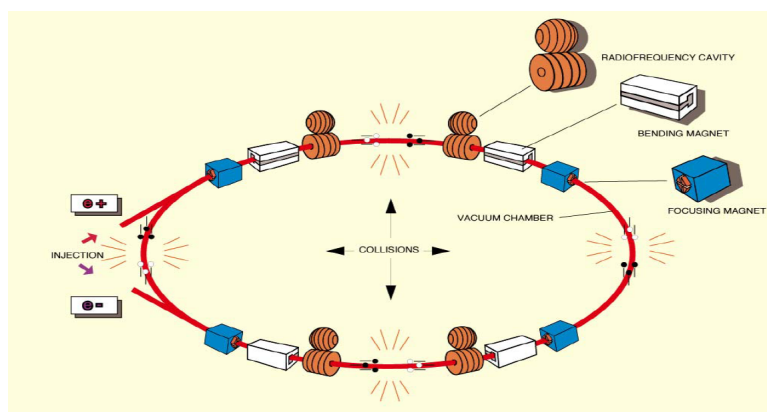

CAS, Baden, 7-14 May 2014

6

What do we power?

The magnet families are :

Dipole: Bend the beam

Quadrupole: focus the beam

Sextupole: correct chromaticity

Octupole: Landau damping

Skew: coupling horizontal&vertical betatron oscillations

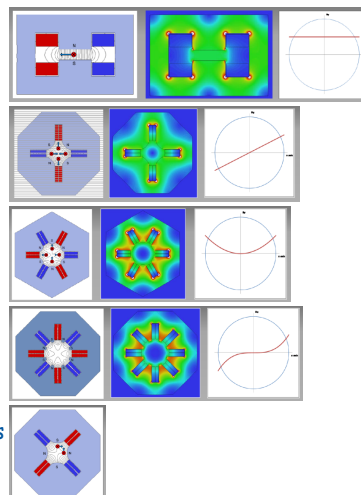

<http://cas.web.cern.ch/CAS/Belgium-2009/Lectures/Bruges-lectures.htm>



CAS, Baden, 7-14 May 2014

7

What do we power?

For beam transfer, special magnets are needed. The families are :

Electrostatic septum

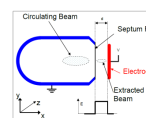
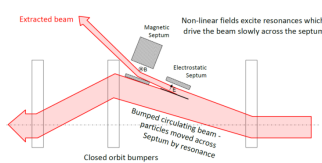

Septum magnet

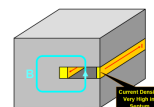
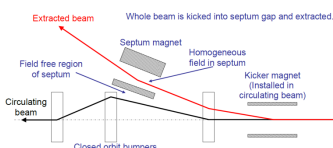

Kicker Magnet
Rise time # 10ns-1μs

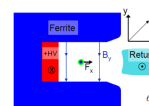

Kicker generators are very special and generally handled by kicker people.

<http://cas.web.cern.ch/CAS/Belgium-2009/Lectures/Bruges-lectures.htm>



CAS, Baden, 7-14 May 2014

8

What do we power?

For the radio frequency system, the RF power comes through power amplifiers.
The families of RF power amplifiers are :

Solid state amplifier, Low power, 100V, 1-100kW



Tetrode, Medium power, 10kV, 100kW

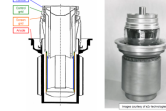

IOT, Medium power, 20-50kV, 10-100kW



Klystron, High power RF, 50-150kV, 1-150MW

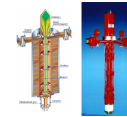

<http://cas.web.cern.ch/CAS/Denmark-2010/Lectures/ebeltoft-lectures.html>



What is special with magnet powering?

In a synchrotron, the beam energy is proportional to the magnetic field ($B \cdot \rho = p/e$).

The magnetic field is generated by the current circulating in the magnet coils.

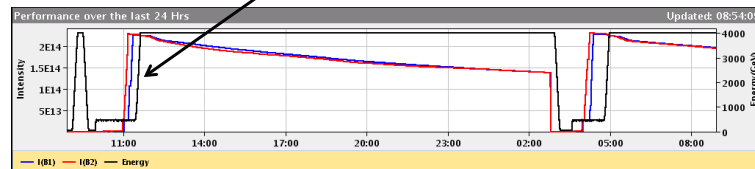
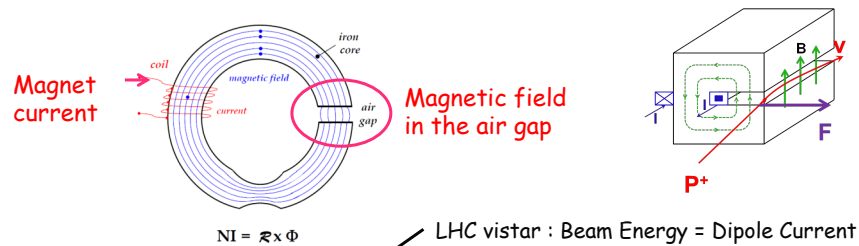

What is special with magnet powering?

The dipole magnets shall have a high field homogeneity which means a high current stability. The good field region is defined typically within $\pm 10^{-4} \Delta B/B$.

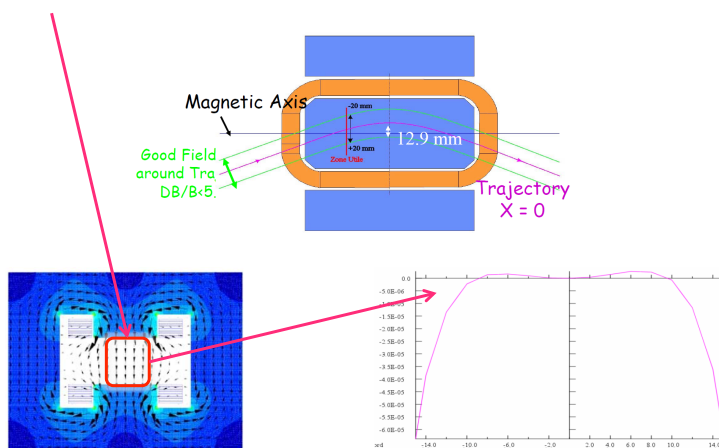

What is special with magnet powering?

The relation between the current and B-field isn't linear due to magnetic hysteresis and eddy currents.

In reality, $\text{Beam Energy} = kb \times \text{Dipole field} \neq ki \times \text{Dipole current}$

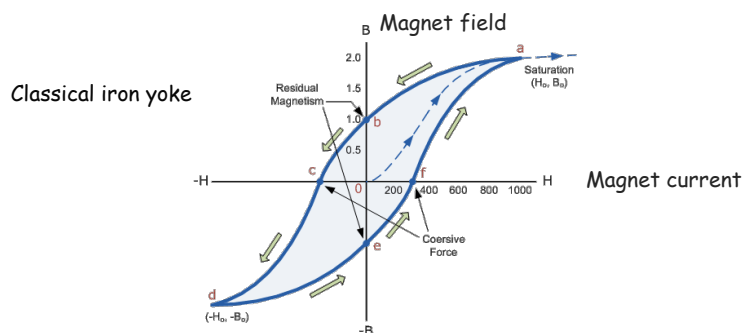

What is special with magnet powering?

For superconducting magnets, the field errors (due to eddy currents) can have dynamic effects.

$$\vec{B}_y + i\vec{B}_x = \sum_{n=1}^{\infty} C_n \left(\frac{z}{R_{eff}} \right)^{n-1} = B_1 \sum_{n=1}^{\infty} \frac{(b_n + ia_n)}{10^4} \left(\frac{z}{R_{eff}} \right)^{n-1}$$

Decay is characterised by a significant drift of the multipole errors when the current in a magnet is held constant, for example during the injection plateau. When the current in a magnet is increased again (for example, at the start of the energy ramp), the multipole errors bounce back ("snap back") to their pre-decay level following an increase of the operating current by approximately 20 A.

For the energy ramp such as described in [3], the snapback takes 50-80 seconds but this can vary if, for example, the rate of change of current in the magnet is changed.

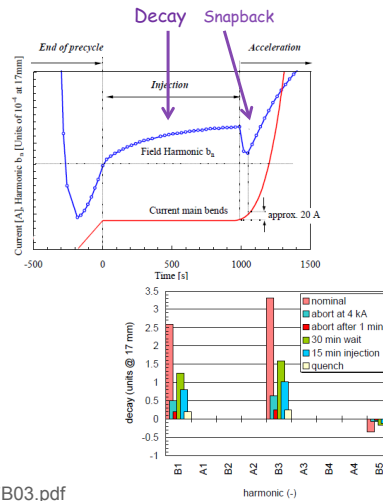

<http://accelconf.web.cern.ch/accelconf/e00/PAPERS/MOP7B03.pdf>



What is special with magnet powering?

Measuring the magnetic field is very difficult and needs a magnet outside the tunnel.

In most of the synchrotrons, all the magnets (dipole, quadrupole, sextupole, orbit correctors,...) are current control.

The beam energy is controlled by the current of the dipole magnet.

To operate a synchrotron, operator needs to measure the beam position with pick-up.

From control room:

Is my accelerator an Ampere meter ?



Power converter requirements

Now, you know that accelerators need high precision power converters.

What are the main parameters you should define with

accelerator physicists
&
magnet designers?

Don't let the accelerator physicists work alone with the magnet designers.

Powering optimization plays with magnet parameters

The power engineers have to be included in the accelerator design from the beginning!



CAS, Baden, 7-14 May 2014

15

Magnet parameters

Magnet parameters seen by the power converters:

- Inductance, in mH
- Resistance, in $m\Omega$
- Current limits
- Voltage limits (insulation class)
- di/dt limits

much better, magnet model including saturation effect.

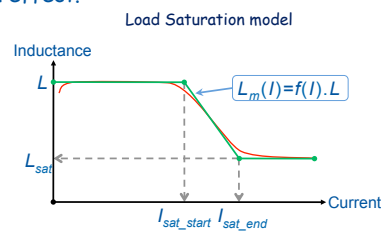
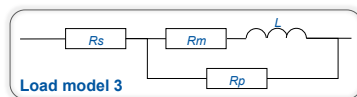

Even better, magnet model between Bfield and current.



CAS, Baden, 7-14 May 2014

16

Circuit layout

The magnets can be powered individually or in series.

Individually:

- increase flexibility of beam optic
- B-field can be different depending of the cycles (hysteresis)
- Global cost is higher, more DC cables, more power converters
- Needed when the voltage goes too high (>10kV magnet class)
- Needed when the energy stored is too big (superconducting magnets)

Series connected:

- B-field identical
- Rigid optic. Need trim power converters to act locally.
- Global cost reduced, less DC cables, less power converters but bigger in power rating.



CAS, Baden, 7-14 May 2014

17

Circuit layout

To get the same B-field in all the magnets, the classical solution is to put all the magnets in series.

Generally done with dipole, quadrupole and sextupole.

Example of SPS quadrupole



Lead to high power system for Dipole and quadrupole powering.

Return cable must be put in opposite direction to the magnet to avoid making loop.

Or power all the upper coils in one way, and back with the lower coils.

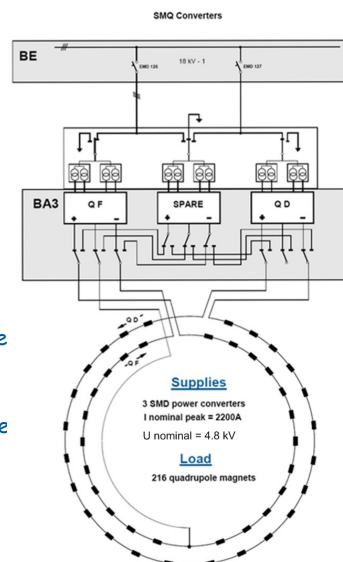

CAS, Baden, 7-14 May 2014

18

Circuit layout

But when the power becomes too high, the circuit needs to be split.
First time with LHC in 8 sectors.

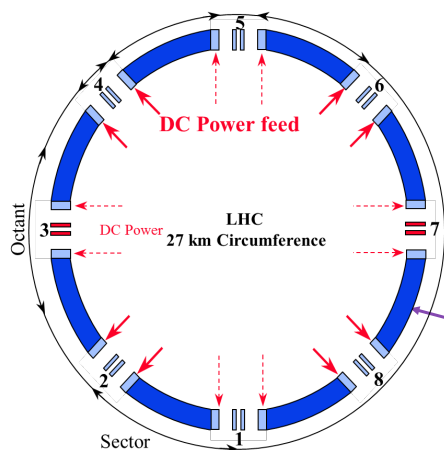

Tracking between sector !

Powering Sector:

154 dipole magnets
total length of 2.9 km



CAS, Baden, 7-14 May 2014

19

Circuit layout

For synchrotron source lights, the quadrupole are generally individually powered to adjust the beam size (beta function) for each users (corresponding to a FODO cell).
Example, SESAME cell.

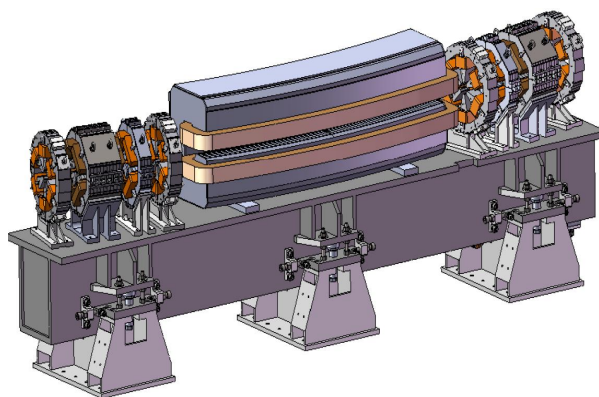

CAS, Baden, 7-14 May 2014

20

Nested circuits

Nested powering scheme is popular with accelerator physicists and magnet designers.

Allows association of different magnets or to correct local deviation over a long series of magnets.

Main reasons: saving on DC cables, current leads, lower power converter rating,...

Example, LHC inner triplet

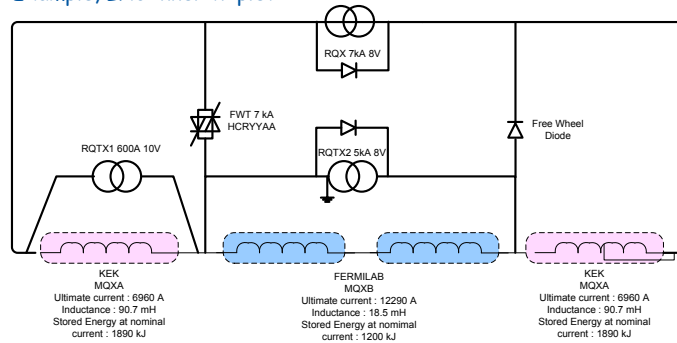

Circuits are coupled!
control issues!



CAS, Baden, 7-14 May 2014

21

Circuit optimization

The powering optimization plays with the magnet parameters, the power converter parameters and the circuit layout.

For the same integral field, the magnet can be done in different ways.

The magnet parameters are:

- Number of turns per coil N
- Maximum current I
- Current density in the conductor J
- Length/field strength of the magnet

Advantages of large N

- Lower I
- Lower losses in DC cables
- Better efficiency of power converter

Drawbacks of large N

- Higher voltage
- Magnet size (coil are bigger due to insulation)



CAS, Baden, 7-14 May 2014

22

Circuit optimization

Advantages of lower J

- Lower losses in magnet
- Less heat to dissipate in air or water

Drawbacks

- Higher capital cost
- Larger magnets

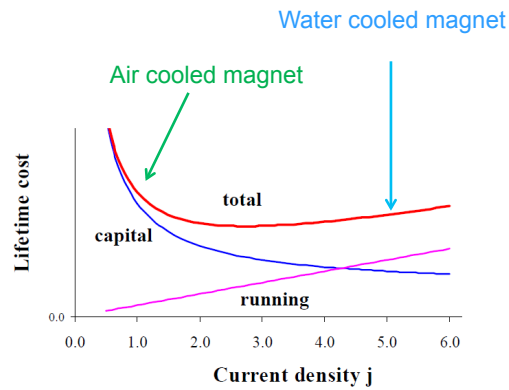

Global optimization shall be done including capital investment, cooling system and energy consumption.



CAS, Baden, 7-14 May 2014

23

DC magnet

DC magnets have a solid yoke which prevents to pulse it. They are used for economical reasons in experimental areas or transfer lines.



Their eddy currents need a long decay time to disappear (tens of second to minutes). The yoke represents ~50% of the magnet cost.

If the beam isn't present all the time, then big saving can be achieved by pulsing the magnets. The energy consumption is proportional to beam duty cycle.

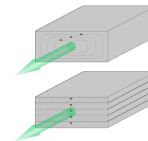

DC magnet advantages

- Cheaper magnets
- Simple powering scheme

DC magnet Drawback

- High energy consumption

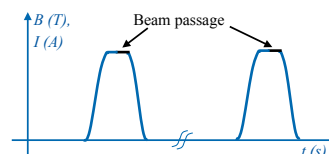

One example of study for EAST Area at CERN, where a energy reduction of 90% could be achieved. <https://edms.cern.ch/document/1255278/1>



CAS, Baden, 7-14 May 2014

24

Magnet grounding

For safety reasons, the magnet shall be isolated from the mains. The power converter needs an insulation transformer in its topology.

The magnets shall be connected to the ground somewhere, they can't be left floating with parasitic capacitances.

One polarity can be connected directly to the ground, or via a divider for a better voltage sharing.

The ground current shall be monitor.

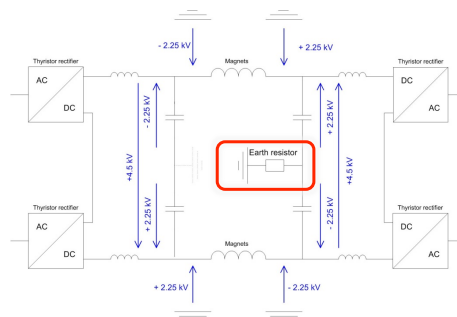

Magnet protection

The magnets shall have its own interlock system.

For warm magnets, it is quite simple (water flow, thermostat, red button,...).

For superconducting magnets, it is quite complex (quench protection).

This interlock system shall request a power abort to the power converter.

Be careful, magnets are inductive load, the circuit can't be opened !

The power converter shall assure a freewheeling path to the current.

It can be inside the power converter for warm magnet,

or outside for superconducting magnet.

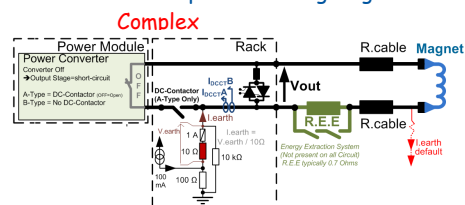
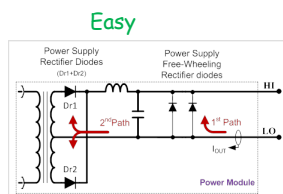

ripples

The acceptable current ripple has to be fixed by the accelerator physicists.
 In fact, it is the maximum B-field ripple which needs to be determined.
 From the B-field ripple, we can determine the current ripple and then, fix the voltage ripple.

V

Power converter

Control ↑

I

Load
H(s)

B

Magnet
F(s)

! (Warning)

$$V = R \cdot I + L \cdot \frac{dI}{dt}$$

$$\Rightarrow H(s) = 1 / (L/R \cdot s + 1)$$

Voltage ripple is generated by the power converter

Current ripple Depends of the load

Current ripple is defined by load transfer function (cables & magnet)

B-Field ripple is depends on magnet transfer function (vacuum chamber,...)

CAS, Baden, 7-14 May 2014

27

Voltage ripple specification

The voltage ripple has to be specified for all frequencies.

- <50Hz: for regulation performance
- 50-1200Hz: for grid disturbance
- 1-150kHz: for power converter switching frequency
- >150kHz: for EMC

Frequency Range [Hz]	Voltage Level [dBµV]	Notes
< 50	65	2 mV _{rms} at 50 Hz
50 - 300	75	8 mV _{rms} at 300 Hz
300 - 60,000	75	8 mV _{rms} (constant)
60,000 - 150,000	70	3.2 mV _{rms} at 150 kHz
150,000 - 500,000	55	2 mV _{rms} at 150 kHz, 0.6 mV _{rms} at 500 kHz
500,000 - 5,000,000	55	0.6 mV _{rms} (constant)
5,000,000 - 30,000,000	60	1.0 mV _{rms} at 30 MHz
> 30,000,000	60	1.0 mV _{rms} (constant)

CAS, Baden, 7-14 May 2014

28

Magnet cycle

The way that the magnets will be operated has to be defined from the beginning.

- Type of control: Current / B-field
- Maximum - minimum current
- Complete cycle
 - Injection current
 - Maximum dI/dt, ramp-up
 - Maximum flat top current
 - Maximum dI/dt, ramp-down
 - Return current
 - Cycle time
- Degauss cycle / pre-cycle
- Standby mode

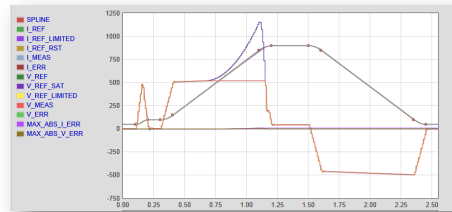
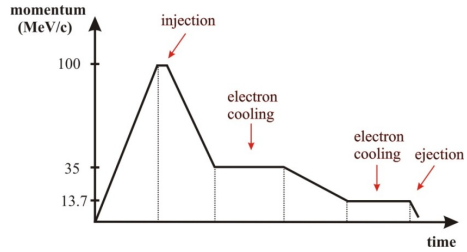

Magnet cycle

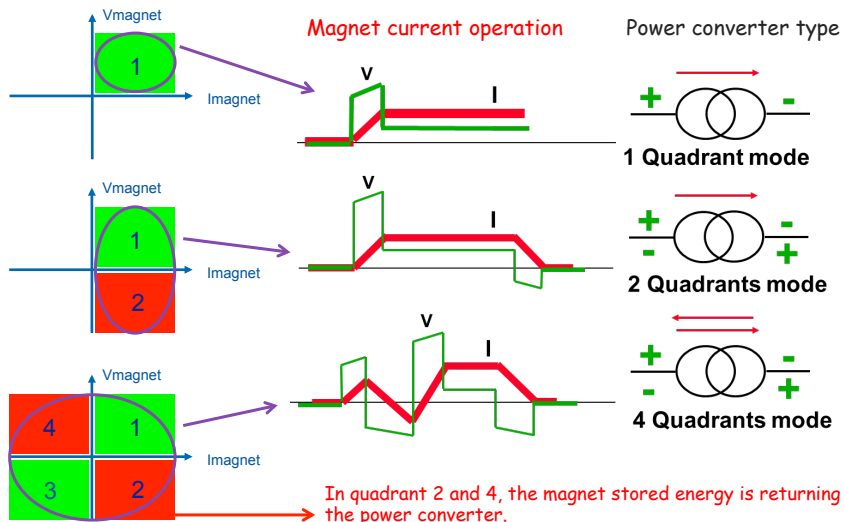

$$E_{\text{magnet}} = 0.5 * L_{\text{magnet}} * I^2$$



Power converter performance

The performance of the power converters have to be defined with the accelerator physicists at the beginning of the project.

The term of precision is only a generic term covering accuracy, reproducibility and stability.

The requirements depend on the magnet type and function. The most demanding are the dipole and quadrupole magnets.

The tracking error is the ability of the power converter to follow the reference function.

- The static part is covered by the static performance (accuracy and reproducibility)
- The dynamic part comes from timing error and lagging error of the regulation.

All these requirements lead to the definition of the power converter controller.



CAS, Baden, 7-14 May 2014

31



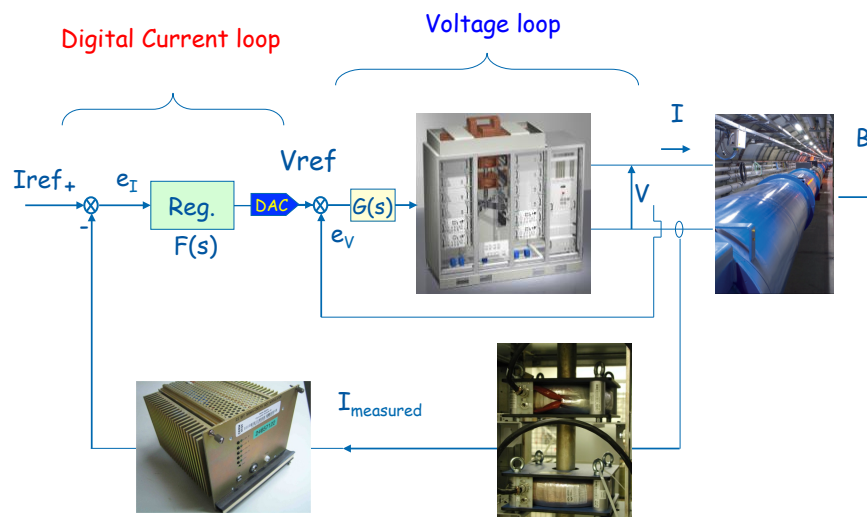

Power Converter control



CAS, Baden, 7-14 May 2014

32

Which current transducers can we use?

	DCCTs	Hall effect	CTs	Rogowsky	Shunts
					
Principle	Zero flux detection	Hall effect	Faraday's law	Faraday's law	Ohm's law
Output	Voltage or current	Voltage or current	Voltage	Voltage	Voltage
Accuracy	Best devices can reach a few ppm stability and repeatability	Best devices can reach 0.1%	Typically not better than 1%	Typically %, better possible with digital integrators	Can reach a few ppm for low currents, <1% for high currents
Ranges	50A to 20kA	hundreds mA to tens of kA	50A to 20kA	high currents possible, up to 100kA	From <1mA up to several kA
Bandwidth	DC ..kHz for the higher currents, DC..100kHz for lower currents	DC up to couple hundred kHz	Typically 50Hz up to a few hundreds of kHz	Few Hz possible, up to the MHz	Up to some hundreds of kHz with coaxial assemblies
Isolation	Yes	Yes	Yes	Yes	No
Error sources	Magnetic (remanence, external fields, centering) Burden resistor (thermal settling, stability, linearity, tempco) Output amplifier (stability, noise, CMR, tempco)	Magnetic Burden resistor Output amplifier Hall sensor stability (tempco, piezoelectric effect)	Magnetic (remanence, external fields, centering, magnetizing current) Burden resistor	Magnetic Integrator (offset stability, linearity, tempco)	Power coefficient, tempco, ageing, thermal voltages



High-precision definition

Accuracy

The closeness of agreement between a test result and the accepted reference value. (ISO)

Reproducibility

Uncertainty when returning to a set of previous working values from cycle to cycle of the machine.

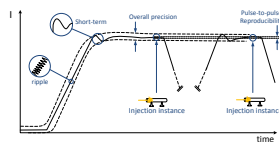

Stability

Maximum deviation over a period with no changes in operating conditions.

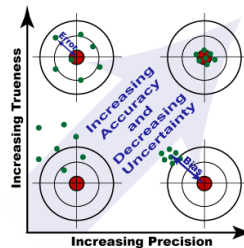
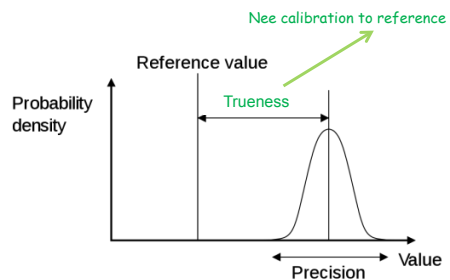
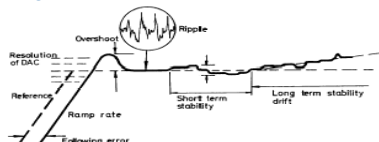

Power converter resolution

Smallest increment that can be induced or discerned.

The resolution is expressed in ppm of maximum DCCT current.
Resolution is directly linked to A/D system.

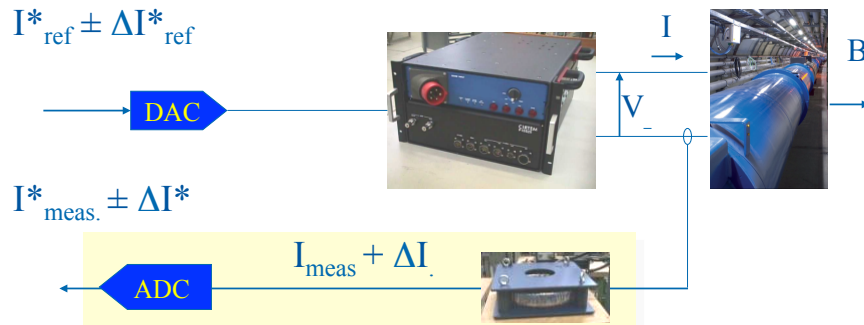

Current regulation

The performance of the current regulation is critical for the machine. It can be a nightmare for operators if the current doesn't follow the reference!

The controller has to manage the tracking error as well as the regulation.

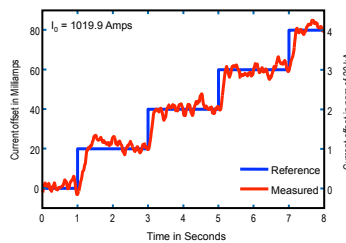
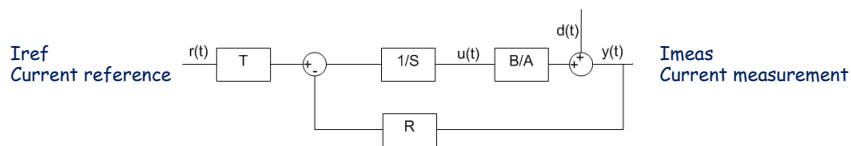

Power converter control

The converter control system is the interface with the operators.

It manages the timing system, the communication, the state machine, the regulation...



With particles accelerators, the main difficulty is the need of synchronisation for all equipment to control which prevents using directly standard commercial solution.

Acceptable synchronization jitter for power converters ~ 1-100µs
It depends of the cycle time.

LHC cycle = 20', acceptable jitter 100µs, sampling at 1ms

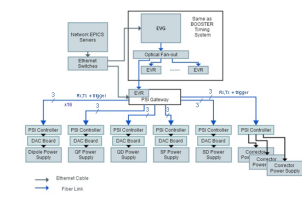
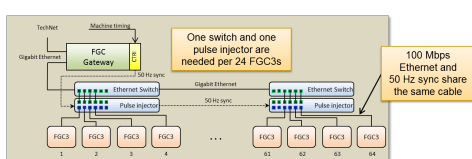

Power converter availability

The power converters are a key player in machine availability.

Their MTBF is generally on the order of 100000H.

With 1700 power converters in the LHC, a power converter is down every 3 days in average.

Improving the MTBF is quite difficult, be careful with thermal design.

How can we improve the situation?



Work on the MTTR

Redundancy, n+1



Hot spare, 1 and 1



Why the magnet power converters are so special?

The magnet power converters are high precision current control.

To build it, the technical solutions are outside the industrial standard:

- Need very low ripple
 - Need current and voltage control over large range
 - Operate in 1-2-4 quadrant
- } Special topologies
- Need high precision measurement
 - Need high performance electronics
 - Need sophisticated control and algorithm
- } Special electronics and control

Powering a magnet isn't classical. **It is always custom power supplies**

A power converter functional specification shall be written before starting the power converter design.



What shall contain the functional specification?

Short description of the machine

Description of the loads

- Magnet layout
- Magnet parameters
- Optimization with integral cost and energy saving

Description of the operation duty cycle

- Machine cycles
- Minimum and maximum beam energy

Power converter requirements

- Power converter rating
- Current precision
- Current tracking
- Control system
- Energy management
- Lock-out and safety procedure
- Infrastructure (layout, Electricity, Cooling, handling...)

Purchasing and development strategy

Planning

Budget

Resource



Power converter time scale

From power converter functional specification <https://edms.cern.ch/document/829344/3>

- > Power converter design
- > simulation
- > Component design
- > 3D mechanical integration
- > Production
- > Laboratory Tests
- > On site commissioning

Minimum 18 months up to 3 years when special development is needed.

CAS, Baden, 7-14 May 2014
41

Power converter purchasing

From power converter functional specification <https://edms.cern.ch/document/1292325>

- > Power converter technical specification
- > Call for tender
- > Award of contract
- > Design report
- > Prototype acceptance
- > Series production
- > On site commissioning

Minimum 6 months

Minimum 12 months

CAS, Baden, 7-14 May 2014
42

What should I worry about?

The design of power converters covers a large range of disciplines.
Need more than one specialist to built it, team work !

Power part:

- Power converter topology
- Semiconductors, switching frequency, thermal design, fatigue while cycling,...
- Filtering
- EMC
- Connection to AC grid
- Energy management
- Protection and safety...

Control part:

- Accuracy class
- Digitalisation
- Control loops
- Timing & synchronisation
- Control interfaces
- Interlocks...



What should I worry about?

In this first talk, I tried to make a list of questions that you can face when making a particles accelerator.

You should find a lot of information to help you with the design of power converters and associated control during the next week.

Time	Wednesday 7 May	Thursday 8 May	Friday 9 May	Saturday 10 May	Sunday 11 May	Monday 12 May	Tuesday 13 May	Wednesday 14 May
08:30		Introduction and Accelerator Basics	Power Converters and Power Quality I	RF Solid State Amplifiers		Thermal Design		Seminars
09:30		R. Bradley	K. Kuhl	J. Jacob		R. Kaman		N. Yagci
09:30	A	Requirements on Power Converters	EMC	Long Pulse Converters		Design Methods and Tools		Power Converters for Accelerators
10:30	R	J.-P. Barrot	A. Chassy	J. Eckhardt	E	T. Mervand		R. Vianina
11:00	R	COFFEE	COFFEE	COFFEE	X	COFFEE		COFFEE
11:00	I	Definition of Power Converters	Power Converters and Power Quality II	Solid State Power Modulators	C	Regulation Theory	Half Day at ABB	Power in-line Practice
12:00	V	D. Aguilu	D. Stenmako	J. Bels	U	F. Bussat		J.-P. Barrot
12:00	A	Definition of Power Converters II	Switched Mode 1 Q Converters	Power Converter Controls, Radiation Risks & Mitigation	R	High Precision Current Measurement for Power Converters	*	Closing Remarks
13:00	L	D. Aguilu	R. Petrocchi	B. Todd	S	M. Cuperena	Half Day at PSI	R. Bailey
14:30	D	LUNCH	LUNCH	LUNCH	I	LUNCH		LUNCH
14:30	A	Active Devices	Switched Mode 4 Q Converters	Power Filter Design	O	A Review of ADCs & DACs and their Application		D
15:30	V	M. Rahimi	Y. Thuret	R. Kaman	N	J. Pickering		E
15:30	V	Passive Devices: Magnetic	Converters for Low Frequency Machines	Protection and Interlocks		Controls and Interlocks		P
16:30		P. Vanzorge	J. F. Bouaille	B. Todd		Q. King		A
17:00		TEA	TEA	TEA		TEA		R
17:00		Passive Devices: Capacitive	Switching Proton Therapy	Seminar: Swiss FEL, the X-Ray Free Electron Laser at PSI		Seminar: Overview on Latest Development of ABB Power Semiconductors Technology and Research Topics		T
18:00	Registration	R. Gollay	G. Göttsch	H. Brann		I. Nisue		U
18:00	Buffer Dinner	Dinner	Dinner	Dinner	Special Dinner	Dinner	Dinner	R
19:30								E



Summary

The magnet power converters are driving the beam.

Their performance are very challenging for particles accelerators.

A functional specification will help to clarify the requirements with the accelerator physicists, magnet designers, project manager....

Energy is a major concern for society. Powering optimization is mandatory.



WikipediA
The Free Encyclopedia

Particles accelerators need all your
creativity in many technical fields!



CAS, Baden, 7-14 May 2014

45

Summary



At this stage, you should still have a lot of questions.

You will find in the next talks everything regarding power electronics and control.

I will come back at the end of the school with examples to illustrate
how we can do the right thing.

Enjoy your CAS!



CAS, Baden, 7-14 May 2014

46