

EMC

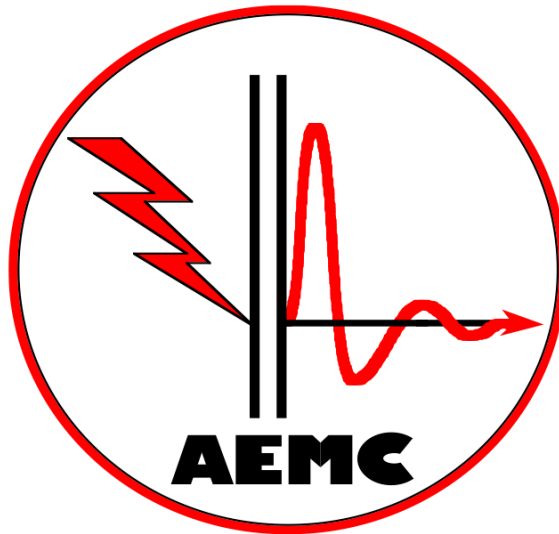

EMC of Power Converters

Friday 9 May 2014

Alain CHAROY - (0033) 4 76 49 76 76 - a.charoy@aemc.fr

Electromagnetism is just electricity

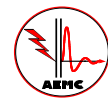

Converters are particularly concerned with EMC:

- **Conducted disturbances (Mainly by large converters)**
 - For the converter itself (self immunity)
 - For the environment (common mode disturbances)
- **Radiated disturbances (even by small converters)**
 - Near fields couplings
 - Far field radiation (mainly for radio receivers)

Beware of unreasonable EMC Standards!

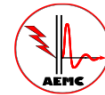

Conducted emission limits of EMC standards for large equipment (inverters, speed drives, arc welders, lifts...) are really too high:

Mains terminal disturbance voltage limits for class A equipment measured on a test site

Frequency band MHz	Class A equipment limits dB(μV)					
	Group 1		Group 2		Group 2 ^a	
	Quasi-peak	Average	Quasi-peak	Average	Quasi-peak	Average
0,15 – 0,50	79	66	100	90	130	120
0,50 – 5	73	60	86	76	125	115
5 – 30	73	60	Decreasing linearly with logarithm of frequency to 70 60		115	105

^a Mains supply currents in excess of 100 A per phase when using the CISPR voltage probe or a suitable V-network (LISN or AMN).

115 dB_{μV} into 9 kHz = 126 dB_{μV} into 120 kHz equivalent to 40 mA into 50 Ω

While the limit corresponding to the **radiated emission** according to **Class A + 10 dB** from 30 MHz to 230 MHz is smaller than **30 μA** (in common mode for any cable)!

Poorly filtered 300kVA inverter conducted spectrum

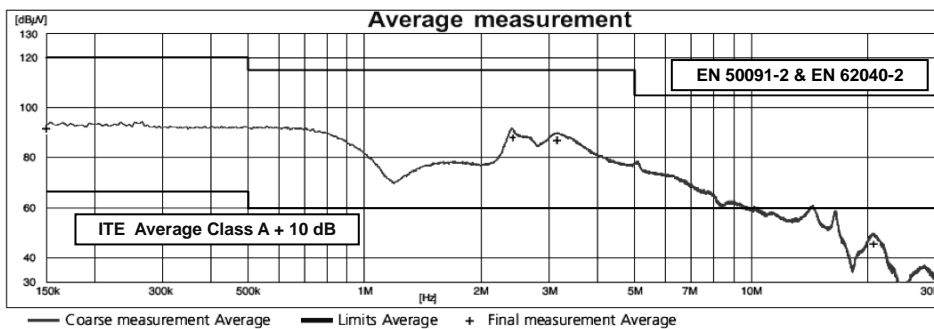
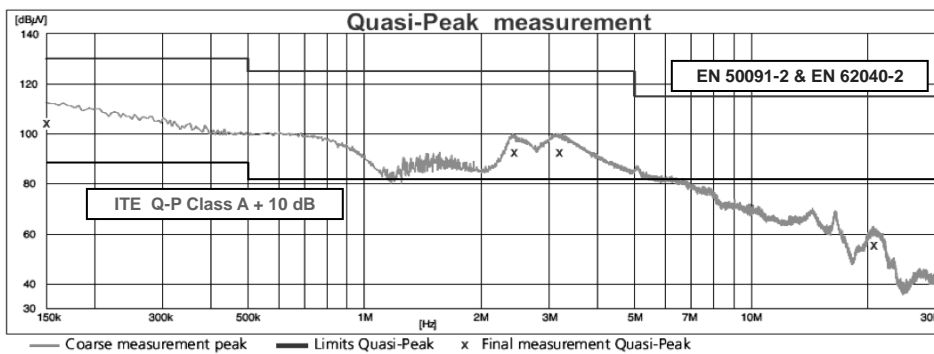
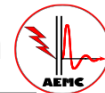

Beware of 2 kHz to 150 kHz band !

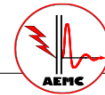

Inverter currents in time & frequency domain (currently, no CISPR limit apply)

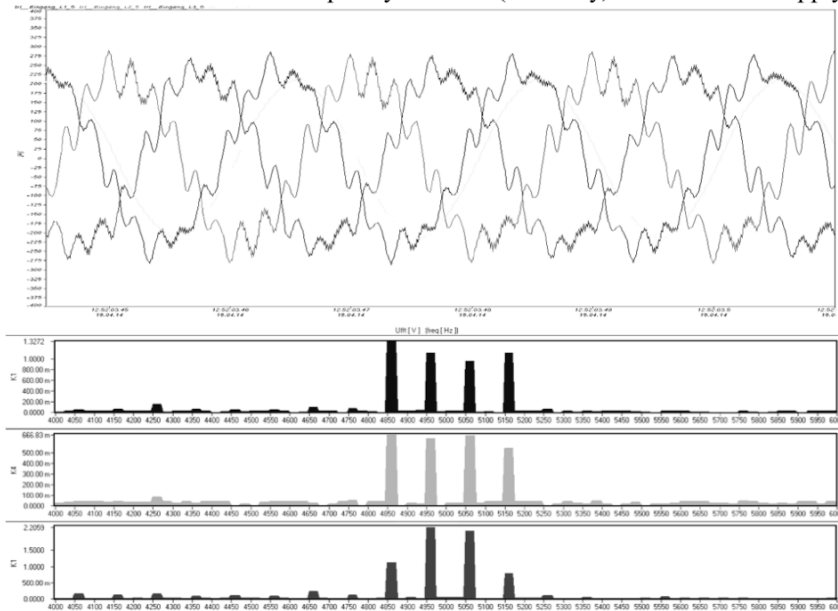

Suggested specification for immunity testing: IEC 61000-4-16

Let's specify modified EMC Standards !

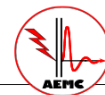

Conducted emission limits for ITER Facility

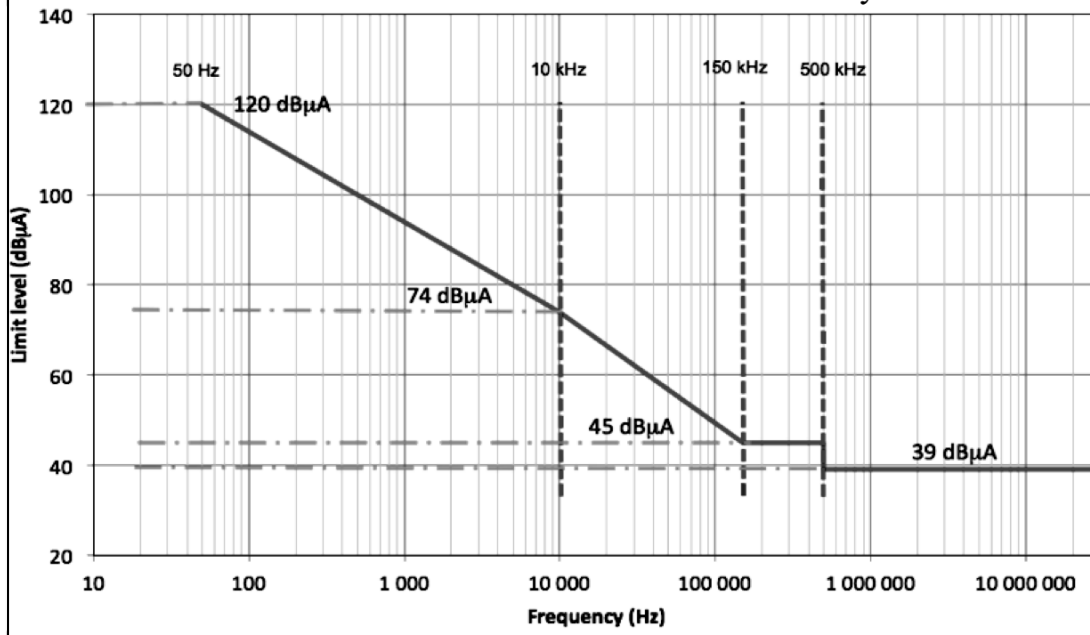

DC / DC Converter instability

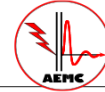

A switch-Mode Converter at low frequency introduces a **negative incremental impedance**

$$Z_{IN} = \Delta V / \Delta I \quad (\text{for } P = \text{constant, when } U \text{ decreases, } I \text{ increases}).$$

Risks :

- No start.
- Start but wrong output voltage.
- Output voltage instability.
- Destruction of the converter.

Solutions :

- Add a large (larger) capacitor at the DC/DC converter input.
- Reduce the source impedance (example: several pairs in //).
- Reduce the converter bandwidth.

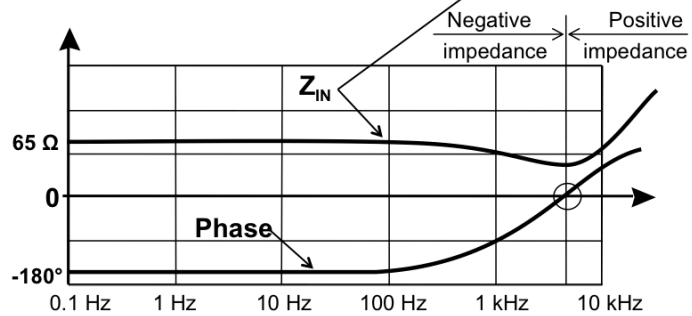
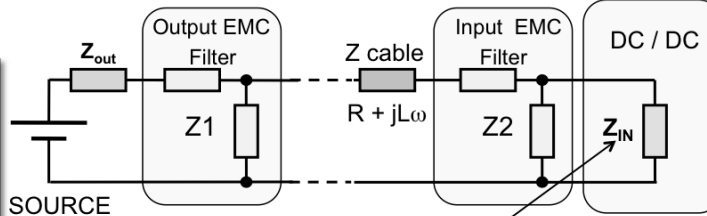

Let's read and uphold data-sheets !

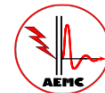

Parameter	Symbol	Min.	Typ.*	Max.	Units	Test Conditions
Output High Level Common Mode Transient Immunity	CM _H	15	30		kV/μs	T _A = 25°C, I _F = 10 to 16 mA, V _{CM} = 1500 V, V _{CC} = 30 V
Output Low Level Common Mode Transient Immunity	CM _L	15	30		kV/μs	T _A = 25°C, V _{CM} = 1500 V, V _F = 0 V, V _{CC} = 30 V

* typical values at T_A = 25°C

Gate Drive Optocoupler HCPL 3120 Technical Data

Diode overvoltage on the inverter IGBT 200A CM Mitsubishi 24A

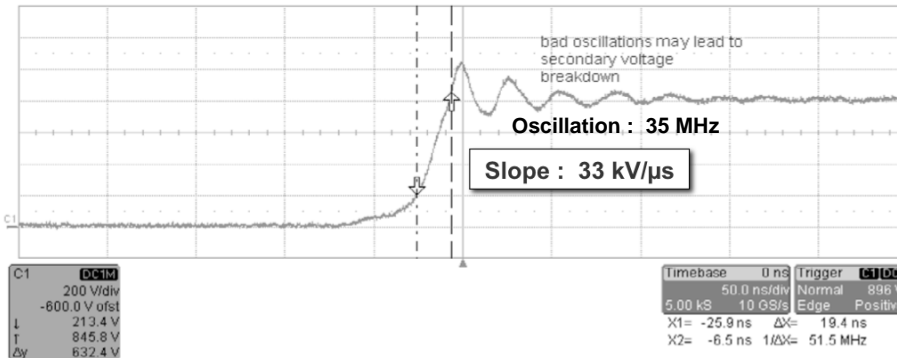

C1
DC1M
200 V/div
-800.0 V ofst
L 213.4 V
T 845.8 V
dy 632.4 V

Timebase 0 ns
50.0 ns/div
5.00 kS 10 GS/s
Trigger 896 V
Normal Edge Positive
X1= -25.9 ns Δx= 19.4 ns
X2= -6.5 ns 1/Δx= 51.5 MHz

EMC on-site mitigation

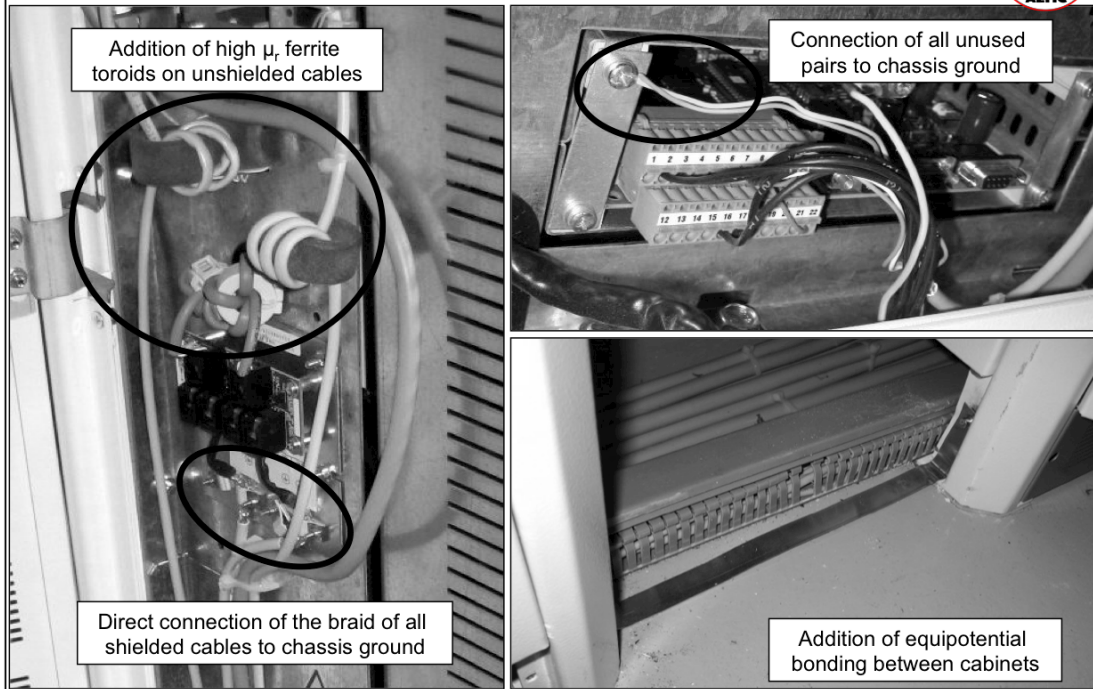
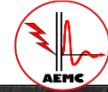

Maximal CM current over internal cables

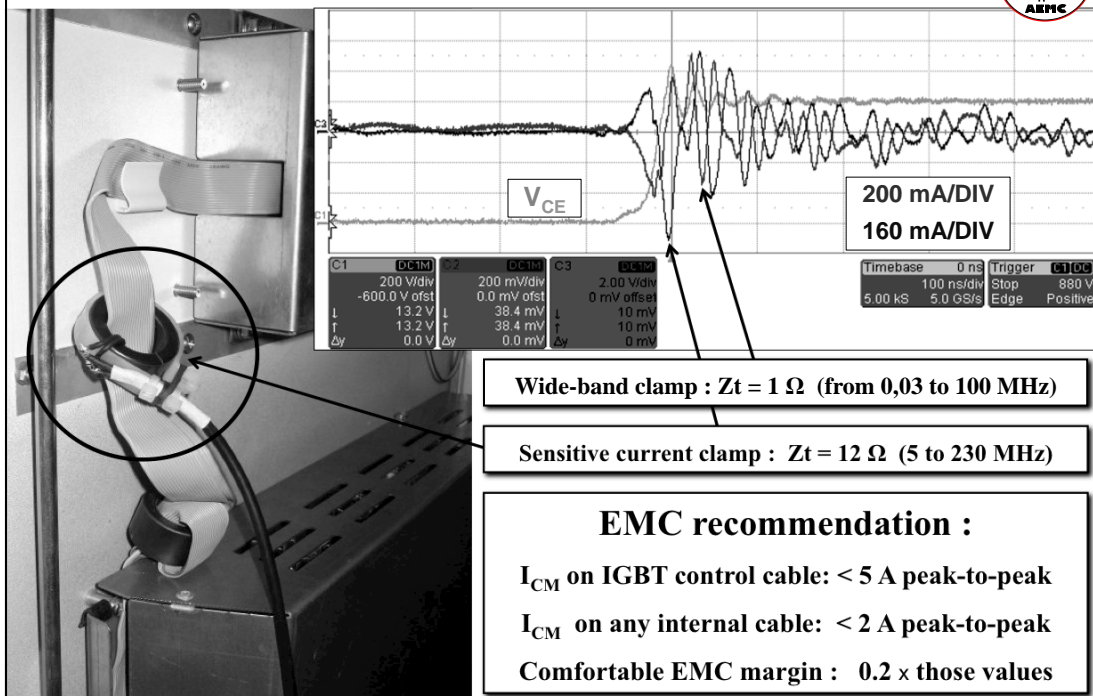
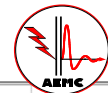

DC/DC Input to output common mode

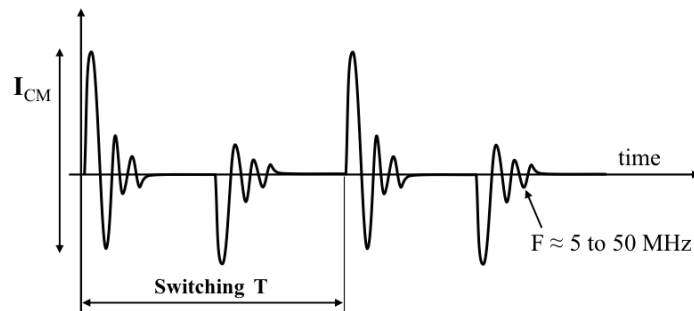
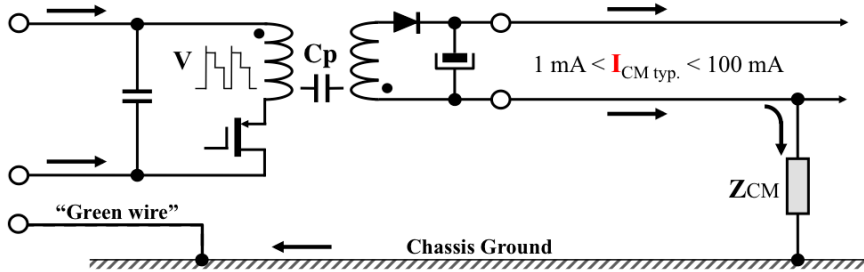
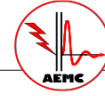

DC/AC Input to output common mode

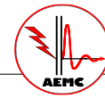

Switching inverters and motor drives are noisy sources in common mode

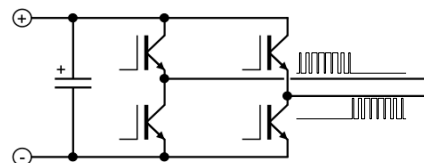
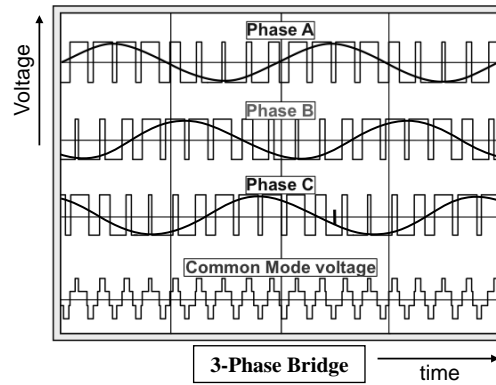
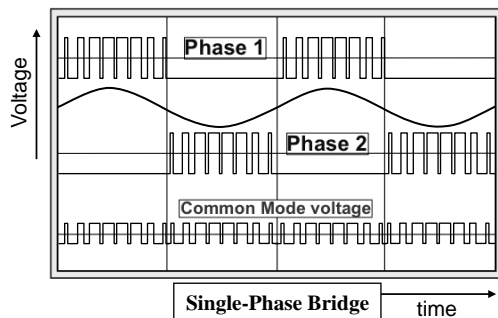

Principle schematics of a H-Bridge (here a Single-Phase Bridge)

3 cases of input - output common mode

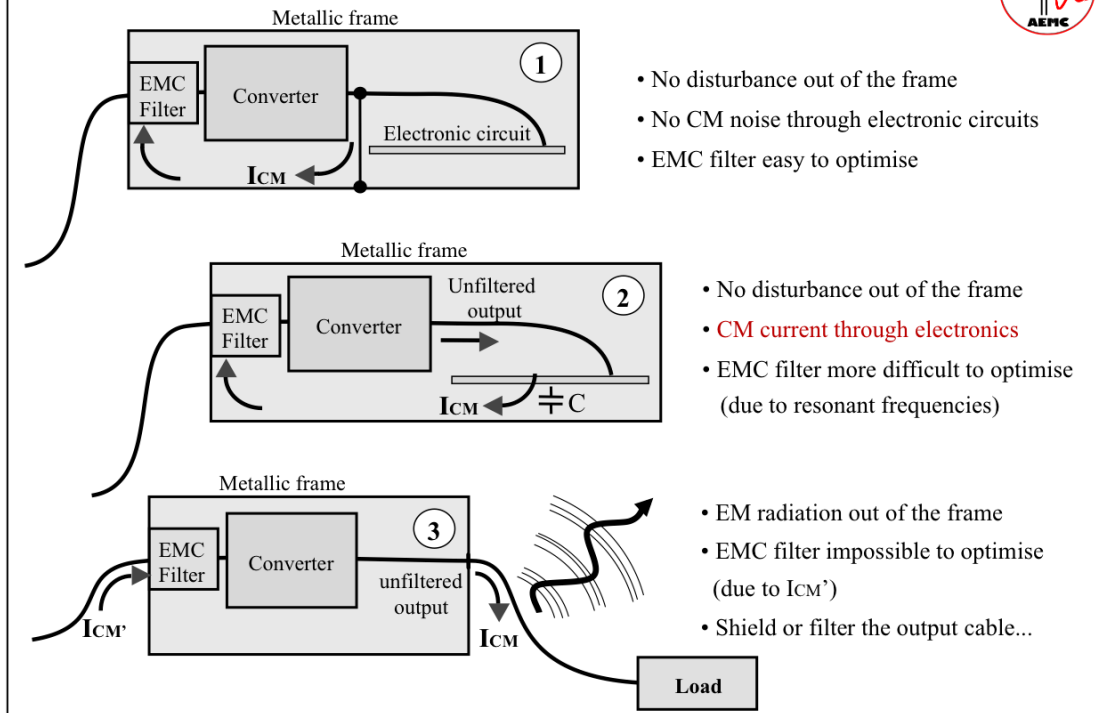
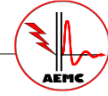

EMC overview of a large UPS

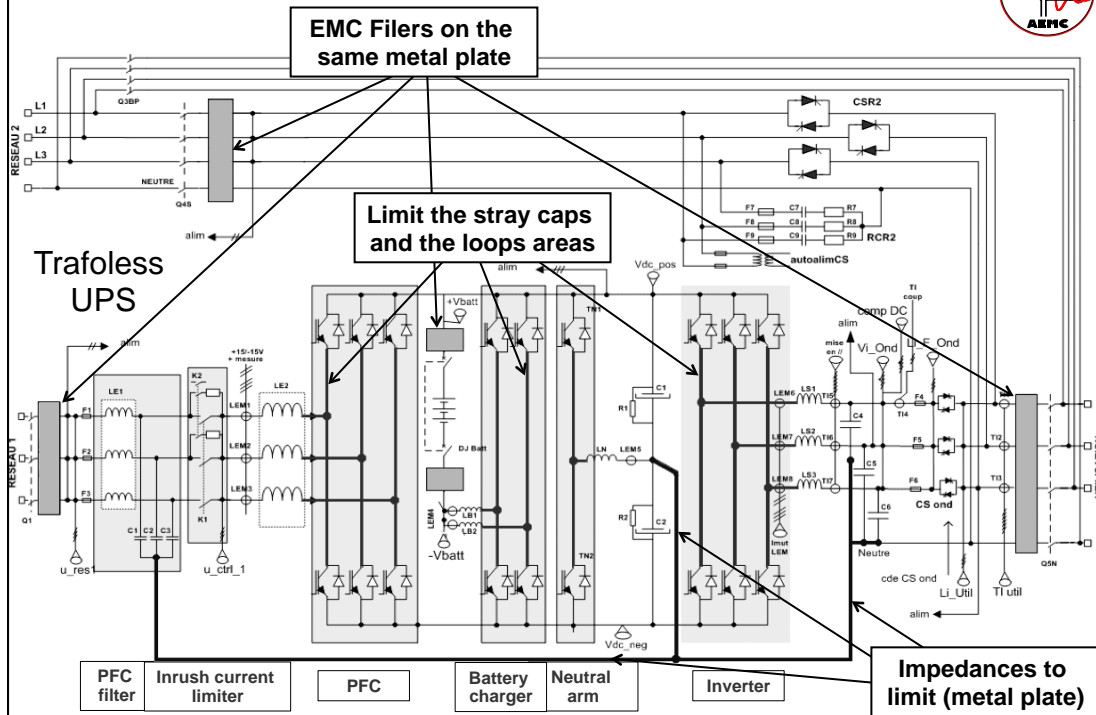
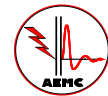

Will you find the errors of this assembly?

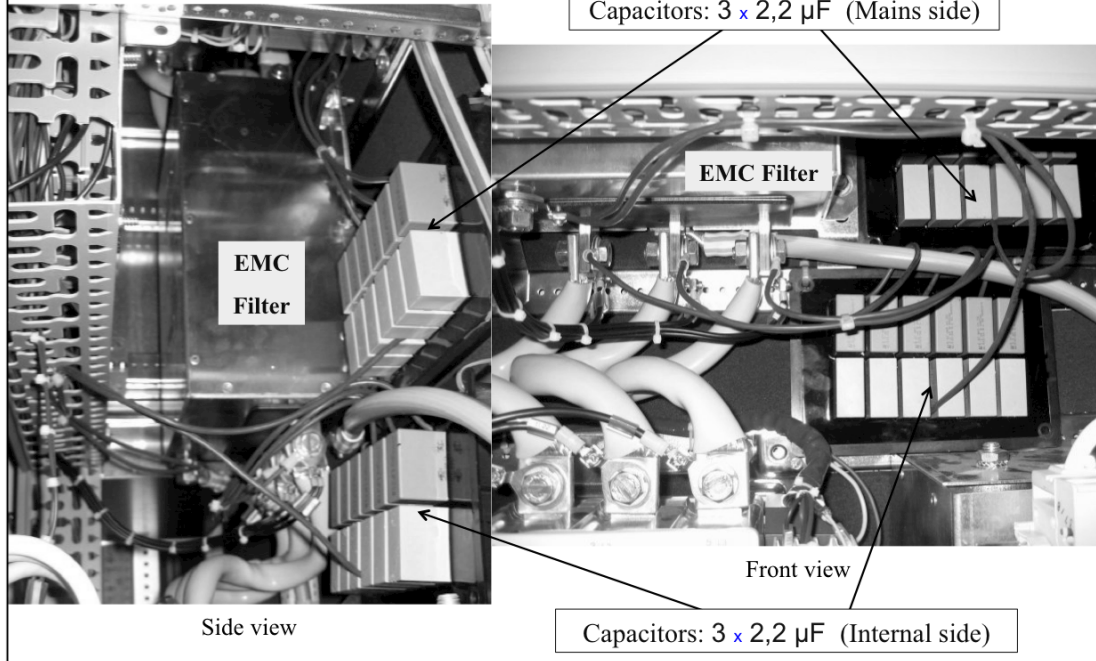
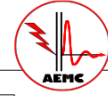

Cabling effects

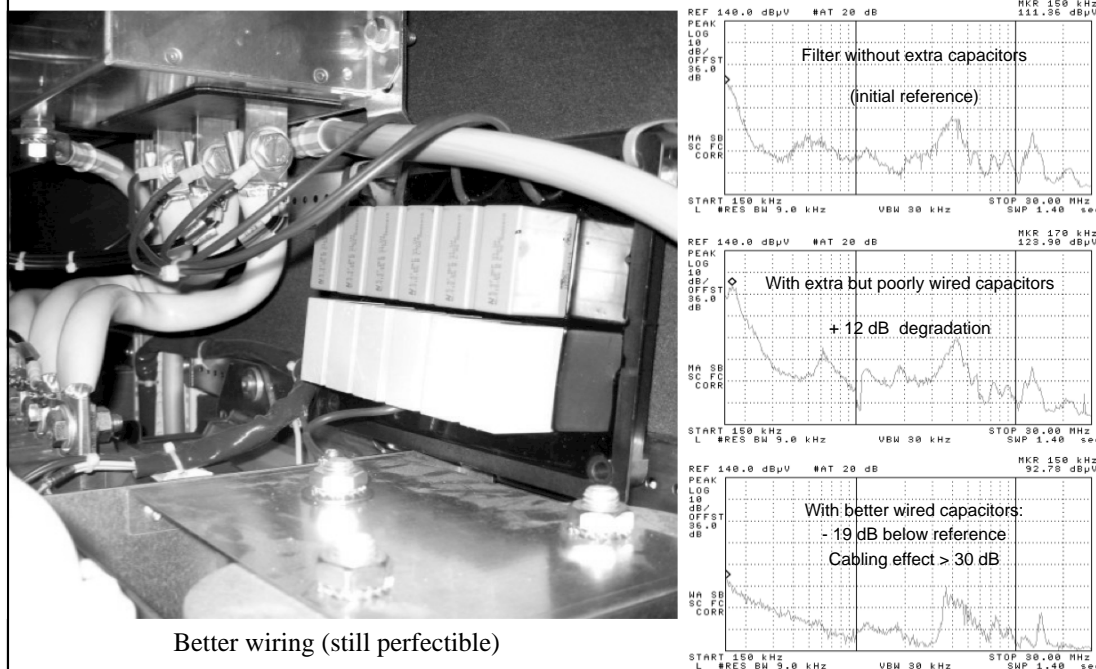
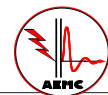

Oscillations of an H-Bridge

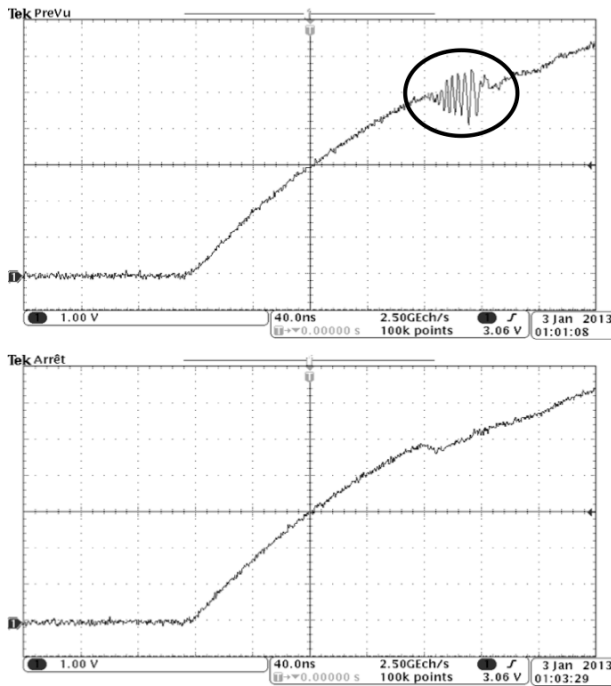
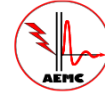

Re-lightning of the opposite MOS or IGBT V_{GS} via the Miller capacitance.

Causes :

- $V_{DC\ bus} \geq 100\ V$ (400 V here).
- Driver with zero voltage blocking.
- Too long gate trace (within 5 cm).

Effect :

- Radiated emission (here $\approx 200\ MHz$).

Fixes:

- Addition of a push-pull near the gate.
- Negative voltage blocking.
- Control with a pulse transformer.

Electrical Fast Transient in Burst (EFT/B)

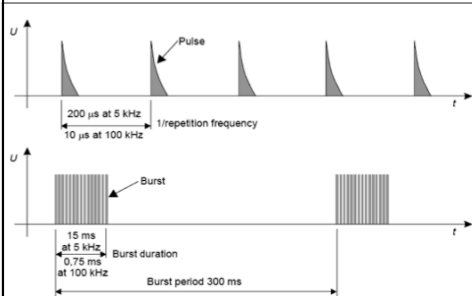
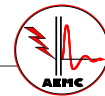

Characteristics:

- polarity: positive/negative
 - output type: coaxial, $50\ \Omega$ (10 ± 2) nF
 - d.c. blocking capacitor: $5\ kHz$ or $100\ kHz \pm 20\ %$
 - repetition frequency: asynchronous
 - relation to a.c. mains: (15 ± 3) ms at 5 kHz
($0,75 \pm 0,15$) ms at 100 kHz
 - burst duration: (300 ± 60) ms
 - burst period:
 - wave shape of the pulse
 - into $50\ \Omega$ load
- rise time $t_r = (5 \pm 1,5)\ ns$
 pulse width $t_w = (50 \pm 15)\ ns$
 peak voltage = $\pm 10\ %$

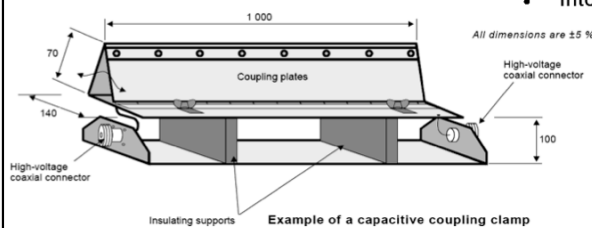

IEC 61000-4-4 Immunity Test

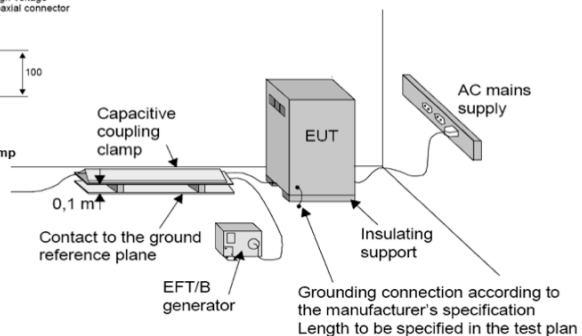

Power converters may radiate in excess

(Both large and small cabinets and attached cables)

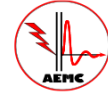

Selection of a differential probe

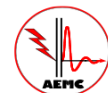

To measure voltages on an H-bridge (V_{GS} or blocking overvoltage), use a differential probe with at least:

Bandwidth ≥ 100 MHz

CMRR ≥ 50 dB @ 1 MHz

Suggested models:

4233 or 4234 (Probe Master) or

SI-9110 (Sapphire Instruments)

To measure peak overvoltage, trigger the oscilloscope in "normal" mode on the signal peak.

Example of Home-Made Voltage Probe

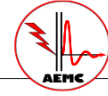

1500 Ohm Probe (150 kHz to 30 MHz)

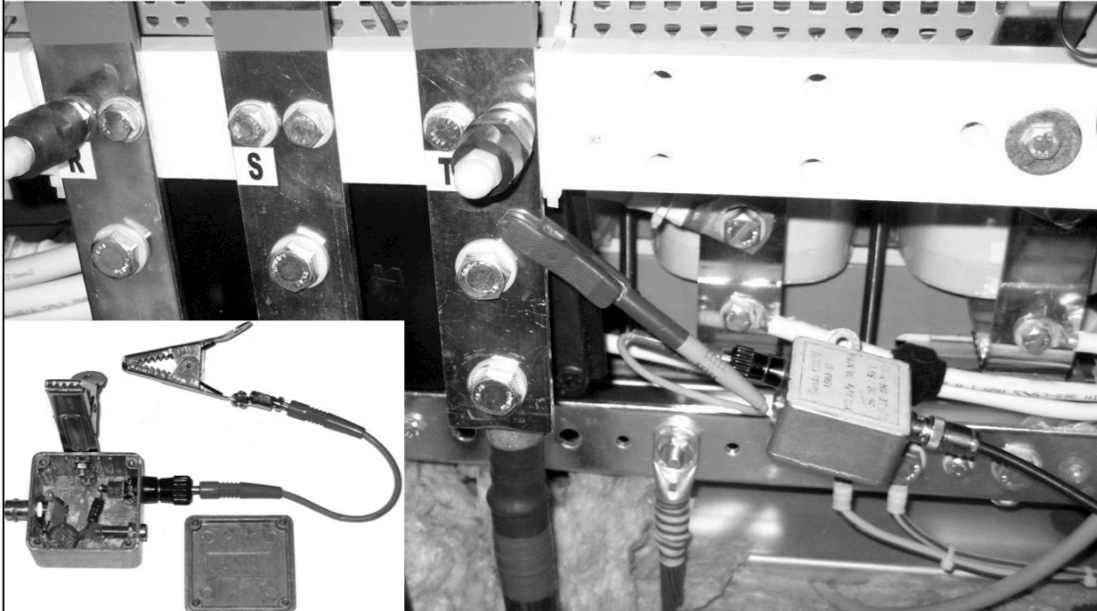

Example of Home-Made Current Probe

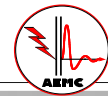

$Z_t = 10 \Omega$ (+1 / - 2 dB from 3 MHz to 300 MHz)

Let's check Home - Made Probes

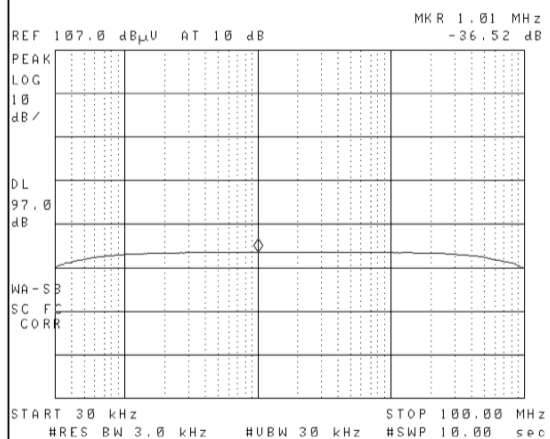
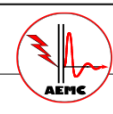

Frequency response of a home-made
1500 Ω Voltage Probe

Nominal insertion loss = 36 dB
+ 0 / -1 dB from 150 kHz to 30 MHz

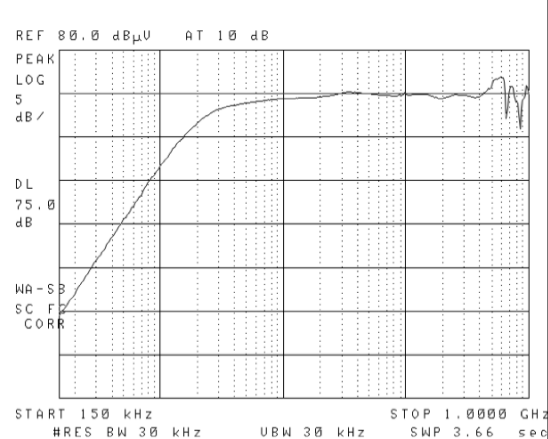

Frequency response of a home-made
10 Ω Current Probe

Nominal Transfer Impedance = 20 dB Ω
In-band Output SWVR \leq 1.5
Nominal primary circuit load = 5 Ω

Examples of Home-Made probes

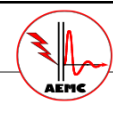

$\Delta V/\Delta t$ - 1 pF probe
(50 mV / V/ns up to 1 GHz)



$\Delta B/\Delta t$ passive probe



BNC Shunt
for current
injection
(for Zt of Coaxial
cable assessment)

Questions ?

