

POWER CONVERTERS FOR CYCLING MACHINES



CERN Accelerator School
Baden
Friday, May 10th 2014

TIME LINE AND CONTENT

- DC and AC accelerators
- Suitable waveforms in cycling machines
- The magnet load
- Reactive power
- Slow and fast cycling accelerators
- Typical ratings 2 examples (SPS, ESRF booster)
- Cycling converter requirements
- Mechanical energy storage
- The 'White Circuit' (inductive energy storage)
- Recent capacitive energy storage (SLS, CERN PS...)

DC AND AC ACCELERATORS

Some circular accelerators are DC operated.

→ Cyclotrons

→ Storage Rings, but they are Accelerators if DC is slowly ramped.

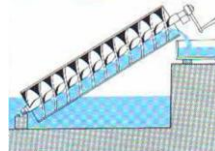

Constant radius machine that are real accelerators must be AC.

The magnetic field must increase as energy is raised:

→ The betatron

→ The Synchrotron



AC WAVE FORM FROM POWER MECHANICAL GENERATOR

Simple Alternating Current Wave to produce AC magnetic field

- The required magnetic field is unidirectional (always positive!)
- The acceleration goes from low to high energy.
- The usual AC wave (without bias is inappropriate)

- Less than $\frac{1}{4}$ of the cycle,
- Excess RMS current,
- High AC losses
- High Gradient at injection

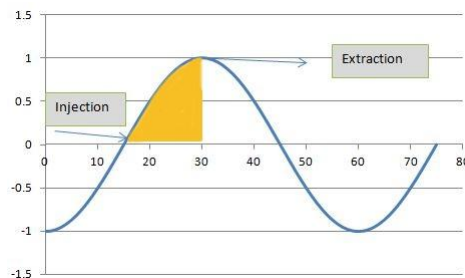

• Not used

MAGNETIC FIELD AND WAVEFORM CRITERIA

For the acceleration of a particle:

Physics laws:

- Particle momentum (rigidity) $E_p = mv$ proportional to B ,
- RF Accelerating Voltage needs to be proportional to $\partial B/\partial t$
- Discontinuities in $\partial B/\partial t$ and RF voltage would generate synchrotron oscillation with possible beam loss.
- Smooth $\partial B/\partial t$ variations enables the proper acceleration path.

WAVEFORM CRITERIA → SYNCHROTRON RADIATION

Synchrotron radiation is only emitted by ultra relativistic particle beams
electrons at $E \sim 1$ GeV
protons at $E \sim 1$ TeV
when bent in a magnetic field !

As a consequence:

- synchrotron radiation loss is proportional to $B^2 E^2$
- for a constant radius accelerator is proportional to B^4
- RF voltage V_{rf} to maintain energy is proportional to B^4
- And finally the RF power is proportional to $k * B^4 + k_2 * B^8$

WAVEFORM CRITERIA → EDDY CURRENTS EFFECTS

Generated by alternating magnetic field cutting a conducting surface:

Eddy current in vacuum vessel and magnet yoke are proportional to $\partial B/\partial t$

Eddy currents produce:

- negative dipole field - reduces main field magnitude;
- sextupole field – affects chromaticity and resonances;

Eddy current effects proportional to → $(1/B)(\partial B/\partial t)$ – critical at injection and just after

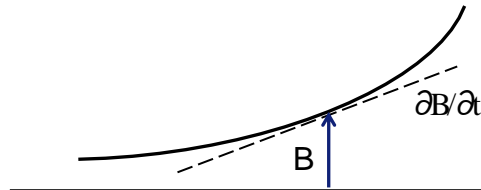

WAVEFORM CRITERIA → DISCONTINUOUS OPERATION

Circulating beam in a storage ring slowly decay with time – very inconvenient for experimental users. Thermal effect and normalisation of the data's acquired are sufficient to envisage solutions.

'top up mode' operation by the booster synchrotron – beam is only accelerated and injected once every n booster cycles, to maintain constant current in the main ring.

Several strategies :

- at fixed interval (every X minutes or seconds) → called Δt (Diamond, APS...)
- at fixed beam current decay (as soon as I beam has decreased $X\%$) → called ΔI (SLS, Elettra, Soleil, Bessy, Spring8, Petra...)

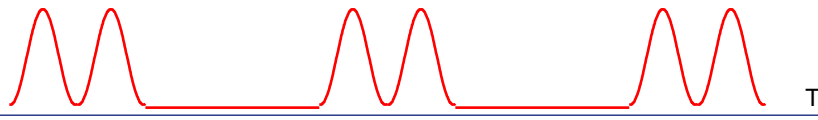

POSSIBLE WAVEFORM 1) LINEAR RAMP

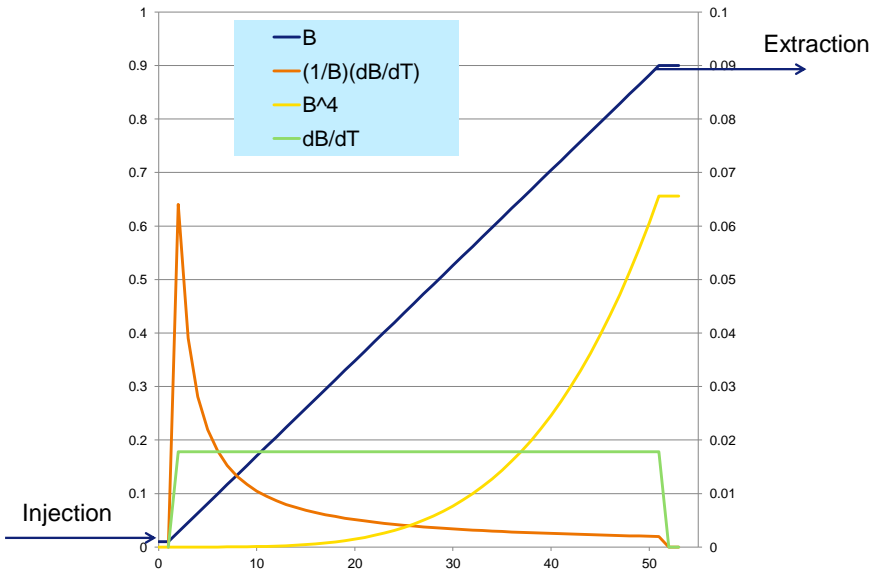

POSSIBLE WAVEFORM 2) BIASED SINE WAVE

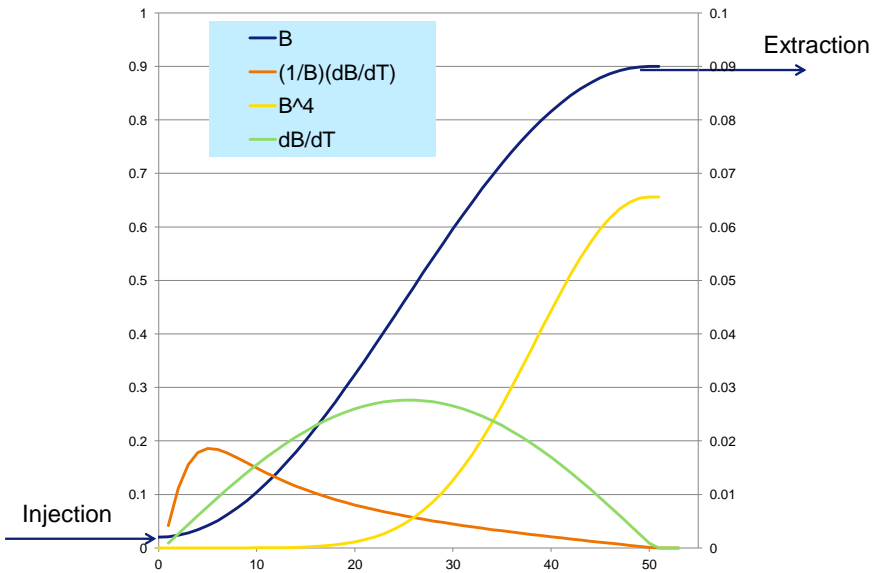

POSSIBLE WAVEFORM 3) BEAM OPTIMIZED SHAPE

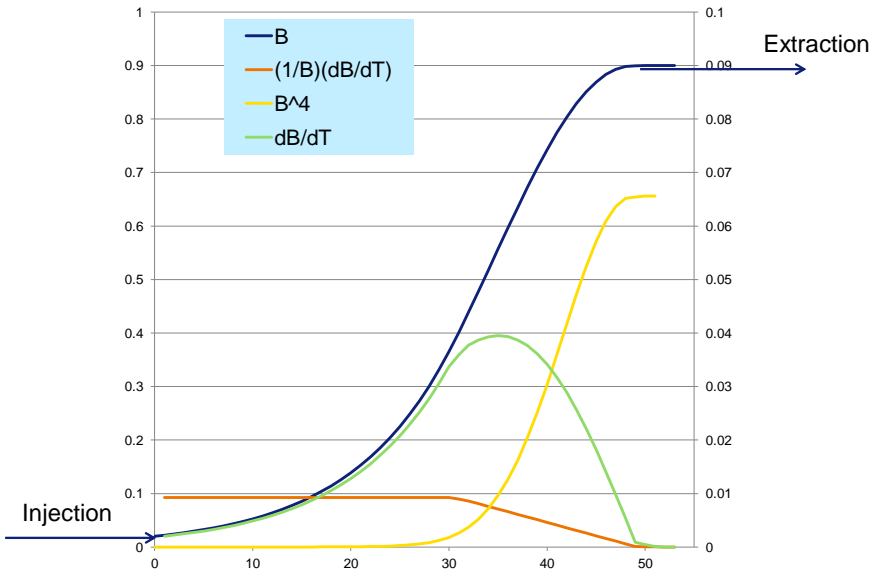

WAVEFORM SUITABILITY

Waveform	Suitability
Linear Ramp	Gradient constant during acceleration Limited voltage needs in the power supply $(\partial B/\partial t)/B$ very high at injection and low energy
Biased Sinewave	$(\partial B/\partial t)/B$ maximum soon after injection but much lower than the linear ramp. Very limited control of the waveform during acceleration
Beam Optimized Waveform	Provides low $(\partial B/\partial t)/B$ at injection and up to half the wave. Presents engineering challenges like much more voltage requested in the power supply and across the magnets terminals.

MAGNET LOADS, DIPOLE AND QUADRUPOLE FUNCTIONS

Magnet current: I
 Magnet voltage: V
 Series inductance: L
 Series resistance: R
 Distributed capacitance to earth: c

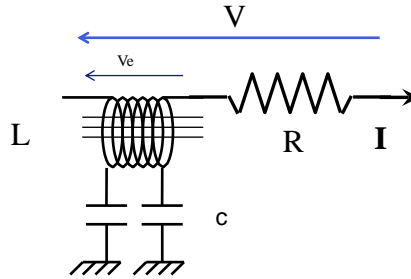

Ohms law: $V = RI + L \partial I / \partial t \rightarrow$ Power $\rightarrow VI = RI^2 + LI (\partial I / \partial t)$

Stored energy in the inductance $E = \frac{1}{2} LI^2$
 The variation of the energy $\rightarrow \partial E / \partial t = LI (\partial I / \partial t)$

Power $\rightarrow VI = \underbrace{RI^2}_{\text{Active power}} + \underbrace{LI \partial I / \partial t}_{\text{Reactive power}}$
 resistive losses alternates between +Ve and -Ve

FAST AND SLOW CYCLING ACCELERATORS

Slow cycling:

- Cycling time 1s to 10s
- large proton accelerators.

Medium cycling:

- Cycling time 200ms to 1s
- Separated function electron accelerators.
- Single shot or multi shots

Fast cycling:

- Repetition rate 10 to 50 Hz.
- Combined function electron accelerators (1950s and 60s) and high current medium energy proton accelerators.

EXAMPLE 1 THE CERN SPS

A slow cycling synchrotron.

Dipole power supply parameters (744 magnets):

• peak proton energy	450	GeV
• cycle time (fixed target)	8.94	s
• peak current	5.75	kA
• peak dI/dt	1.9	kA/s
• magnet resistance	3.25	Ω
• magnet inductance	6.6	H
• magnet stored energy	109	MJ

SPS CURRENT WAVEFORM

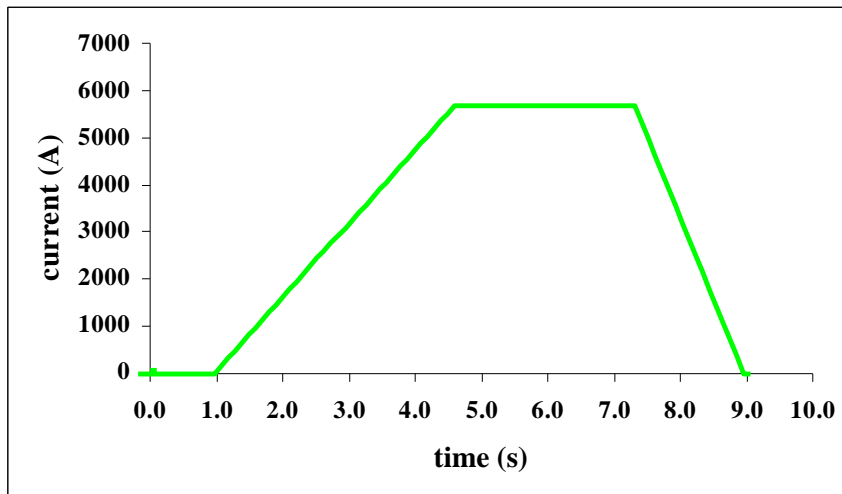

SPS VOLTAGE WAVEFORMS

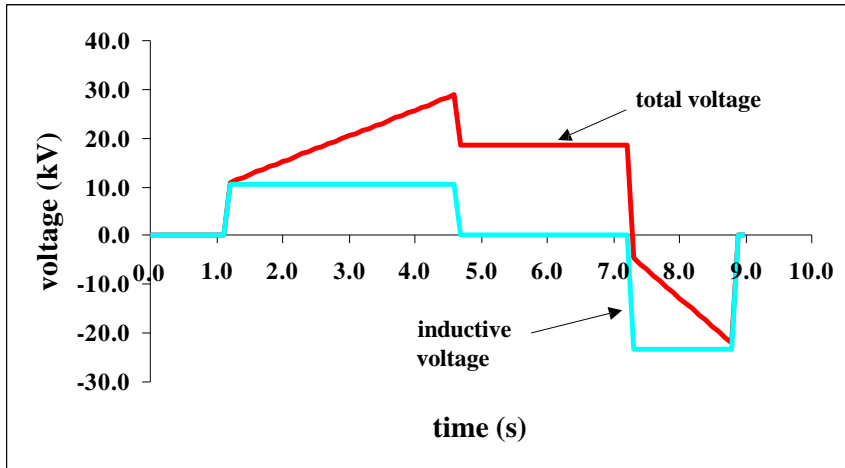

SPS MAGNET POWER

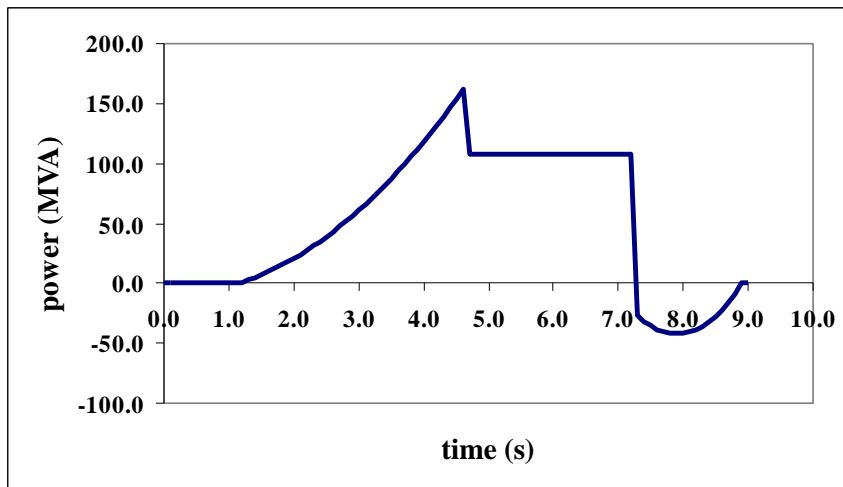

EXAMPLE 2 : ESRF BOOSTER

A 'fast' cycling synchrotron with separate focusing functions. (3 circuits)

magnet electrical parameters

- peak electron energy 6.04 GeV
- cycle time 100 ms
- cycle frequency 10 Hz
- peak dipole current 1467 A
- magnet resistance 568 m Ω
- magnet inductance 178 mH
- magnet stored energy 191 kJ

ESRF BOOSTER DIPOLE CURRENT WAVEFORM

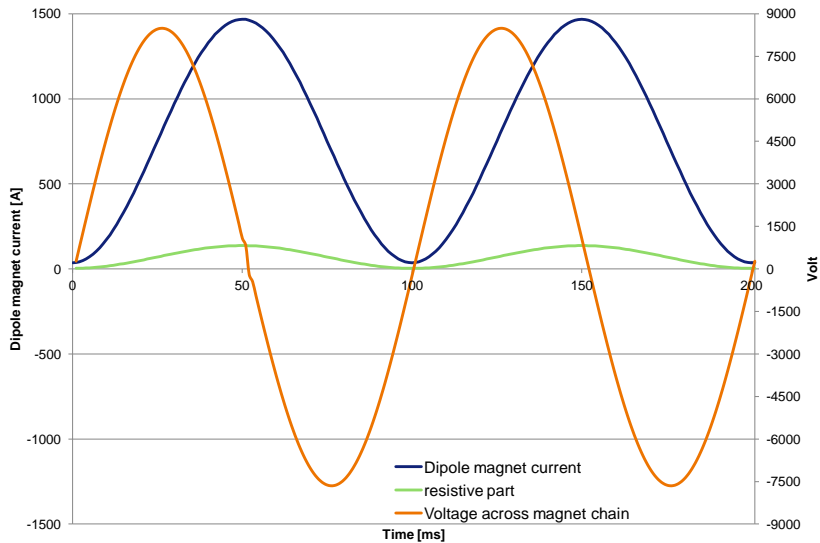

ESRF BOOSTER POWER WAVEFORM

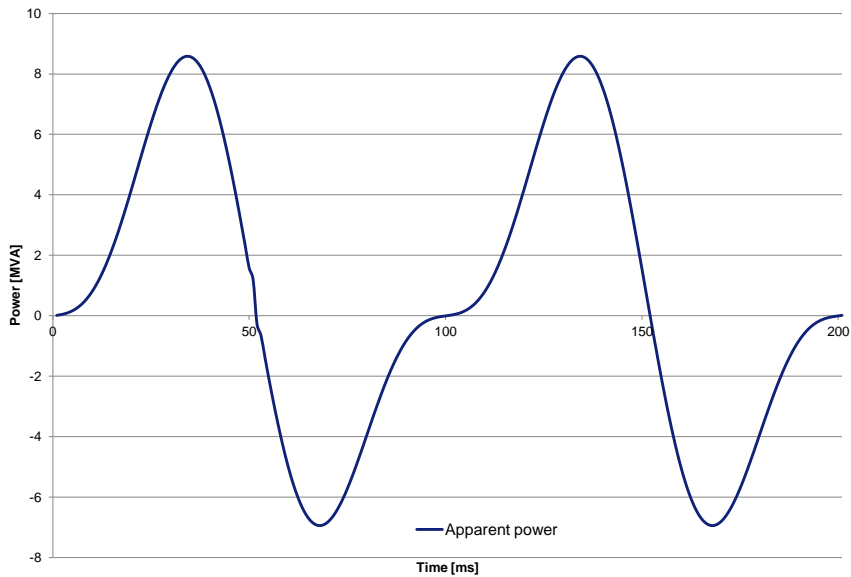

FAST CYCLING SYNCHROTRONS

In the middle of the last century, the solution using the public distribution network with the 50Hz repetition rate was used (example Nina at Daresbury laboratory).

The induced voltage being dominated by the frequency and the large inductance:

$$V \approx L \frac{\partial I}{\partial t} \rightarrow V \approx 2 \pi F L I$$

With F the frequency of the cycling wave, the apparent power = $2 \pi F L I^2$ is often above 100MVA oscillating from positive to negative energies values during the cycle.

The rigidity of the public distribution was supposed to cope with such large energies exchanges.

Not accepted everywhere!

CYCLING CONVERTER REQUIREMENTS

A power converter system needs to provide:

- a unidirectional alternating waveform
- accurate control of waveform amplitude
- accurate control of waveform phase and timing when multiple converters are used
- storage of magnetic energy during low field for efficiency purposes
- Avoid disturbances on the neighbouring customers
- if possible, waveform control to compensate for magnetic non linearity's
- if needed (and possible) discontinuous operation for 'top up mode'

WHY STORING LOCALLY ENERGY ?

One of the difficulty which influences the choice of the converter is to be as transparent to the supply network as possible.

The flicker problem:

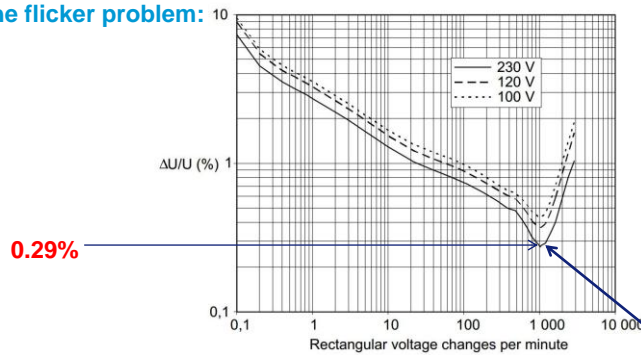

NOTE – Two consecutive voltage changes (one positive and one negative) constitute one "cycle", i.e. two voltage changes per second mean a 1 Hz fluctuation.

1200 voltage changes per minutes = 20 changes per second → 10Hz!

The tolerated value is 0.29% → rigidity 345 times higher than energy exchange!

EXAMPLE WITH ESRF BOOSTER SYNCHROTRON DIPOLE MAGNETS

This power fluctuation of 15.5MVA should produce less than 0.29% $\Delta U/U$ on the local network voltage.

The current value at ESRF on the 20kV 50Hz mains short circuit power is 150MVA.

- this power exchange will therefore produce more than 10% $\Delta U/U$ at 10Hz!
- The maximum allowed is $0.29\% \times 150\text{MVA} = 435\text{kVA}$
- Storage of magnetic energy during low field for flicker constraint is therefore mandatory to avoid disturbances on the neighbouring customers

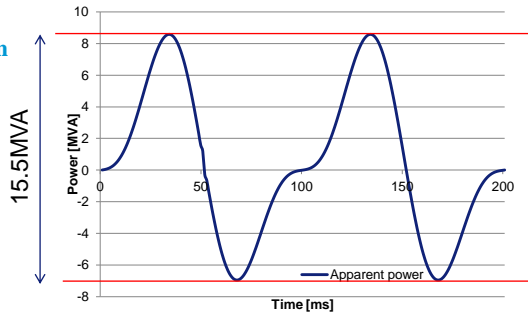

These 15.5MVA is only for the dipole circuit, but all cycling magnets and RF system have to store energy to avoid to break the $\Delta U/U$ curve of the flicker!

With 225kV – 7GVA short circuit capacity allows 20MVA cycling power at 10Hz.

'SLOW CYCLING' MECHANICAL STORAGE

The slow repetition rate cycling machine can use mechanical rotating energy storage. The reliability and the costs are high. This is not suitable for cycling rate lower than around 2 seconds due to mechanical high constraints.

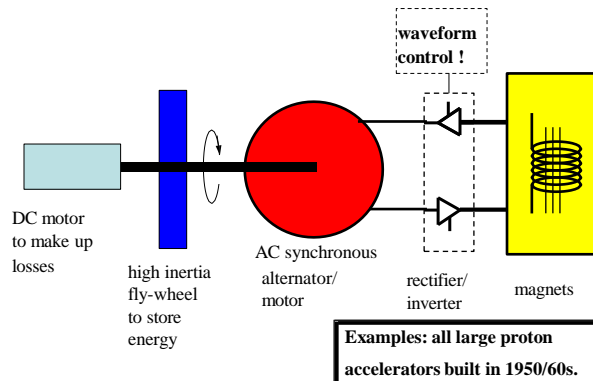

SOLUTION USING THE VERY LARGE SHORT CIRCUIT EUROPEAN GRID

The dipole supply of the SPS of CERN.

14 converter modules (each 2 sets of 12 pulse phase controlled thyristor rectifiers) supply the ring dipoles in series; waveform control!

Each module is connected to its own 18 kV feeder, which are directly fed from the 400 kV French network.

Saturable reactor/capacitor parallel circuits limit voltage fluctuations.

The main part of the voltage fluctuation is the reactive power exchange.

The limit for a 9 sec cycling machine is 1.2% $\Delta U/U$ over the local network.

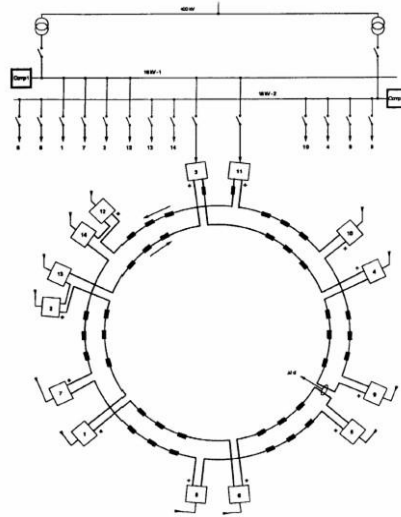

REACTIVE POWER COMPENSATION.

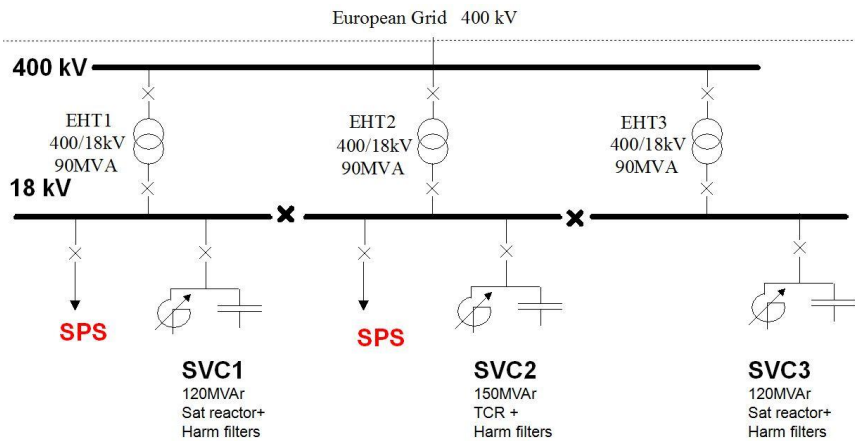

MEDIUM AND FAST CYCLING INDUCTIVE STORAGE.

Fast and medium cycling accelerators (mainly electron synchrotrons) developed in 1960/70s used inductive energy storage:

Inductive storage was roughly half the cost per kJ of capacitive storage. The lifetime of the capacitor banks is an issue at reasonable cost.

The ‘standard circuit’ was developed at Princeton-Pen accelerator – the ‘White Circuit’.

WHITE CIRCUIT – SINGLE CELL

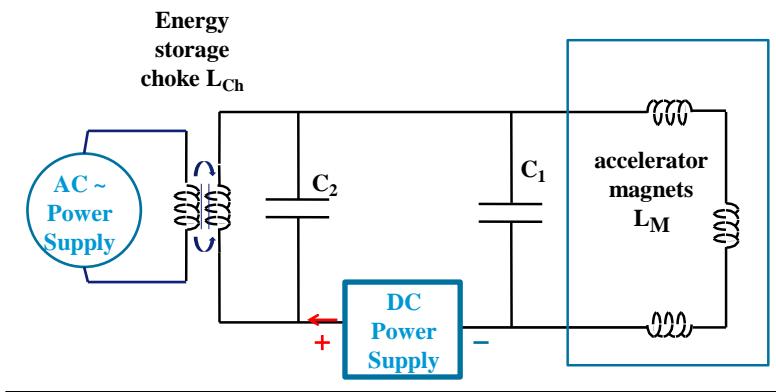

Examples: Boosters for SRS, BESSY1, ESRF...
medium to fast cycling ‘small’ synchrotrons.

Single cell circuit:

- Magnets are all in series (L_M)
- circuit oscillation frequency ω
- C_1 resonates magnet in parallel: $C_1 = \omega^2/L_M$
- C_2 resonates energy storage choke: $C_2 = \omega^2/L_{Ch}$
- energy storage choke has a primary winding closely coupled to the main winding
- only small ac present in d.c. source
- no DC present in AC source
- WAVEFORM CONTROL limited to % adjustment.

Magnet current is biased sin wave

Amplitude of I_{AC} and I_{DC} independently controlled.

Usually fully biased, so

$$I_{DC} \sim I_{AC}$$

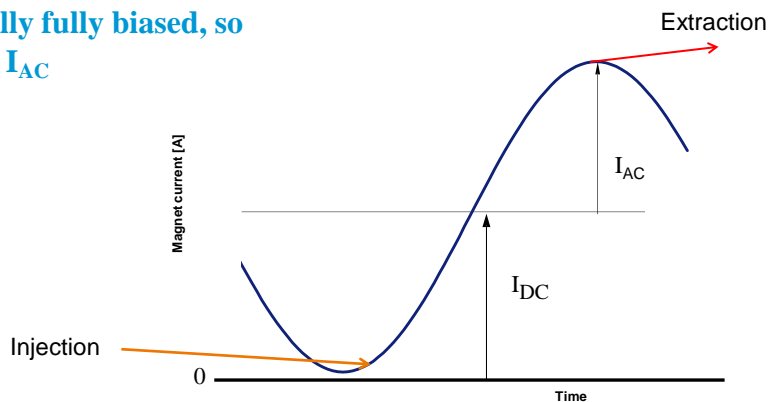

WHITE CIRCUIT PARAMETERS

Magnet current: $I_M = I_{DC} + I_{AC} \sin(\omega t)$;

Magnet voltage: $V_M = R_M I_M + \omega I_{AC} L_M \cos(\omega t)$

Choke inductance: $L_{Ch} = \alpha L_M$

(α is determined by inductor/capacitor economics)

Choke current: $I_{Ch} = I_{DC} - (1/\alpha) I_{AC} \sin(\omega t)$;

Peak magnet energy: $E_M = (1/2) L_M (I_{DC} + I_{AC})^2$;

Peak choke energy: $E_{Ch} = (1/2) \alpha L_M (I_{DC} + I_{AC}/\alpha)^2$;

Typical values: $I_{DC} \sim I_{AC}$; if $\alpha \sim 2$; ESRF case $\alpha = 1.2$

Then $E_M \sim 2 L_M (I_{DC})^2$;

$$E_{Ch} \sim (9/4) L_M (I_{DC})^2, \text{ ESRF case } \sim 2 L_M (I_{DC})^2$$

MULTI-CELL WHITE CIRCUIT (NINA, DESY AND... OTHERS)

For high voltage circuits, the magnets are segmented into a number of separate groups to ease the magnet insulation.

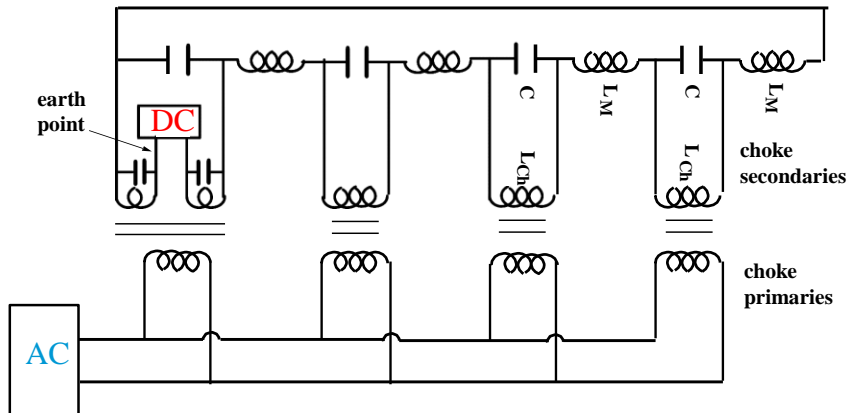

MULTI-CELL WHITE CIRCUIT

Benefits for an 'n' section circuit

- magnets are still in series for current continuity and equity
- voltage across each section is only $1/n$ of total
- maximum voltage to earth is only $1/2n$ of total
- choke has to be split into n identical sections
- DC is at centre of one split section (earth point)
- AC is connected through a paralleled primary
- the paralleled primary must be close coupled to secondary to balance voltages in the circuit
- NO waveform control.

EXAMPLE DESY LAYOUT

DESY 12.5Hz booster synchrotron

Courtesy Hans-Jörg Eckold

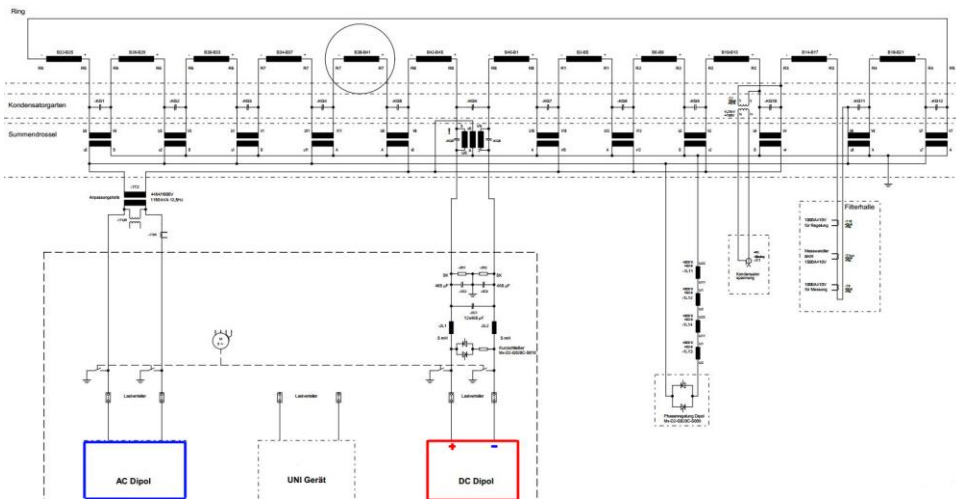

DEVELOPMENT OF CAPACITIVE ENERGY STORAGE

Technical and economic developments in electrolytic capacitors manufacture now result in capacitive storage being lower cost than inductive energy storage (providing voltage reversal is not needed). Polypropylene capacitors are now suitable also for such large capacitive energy storage.

Also semi-conductor technology now allows the use of fully controlled devices (GTO's, IGBT's and IGCT's) giving waveform control at large current and medium voltages.

Medium sized synchrotrons with cycling times of 200ms up to 2s can now take advantage of these developments for cheaper and dynamically controllable power magnet converters – **WAVEFORM CONTROL is now accessible!**

EXAMPLE: SWISS LIGHT SOURCE BOOSTER DIPOLE CIRCUIT.

The single line diagram of one of the SLS power supply:

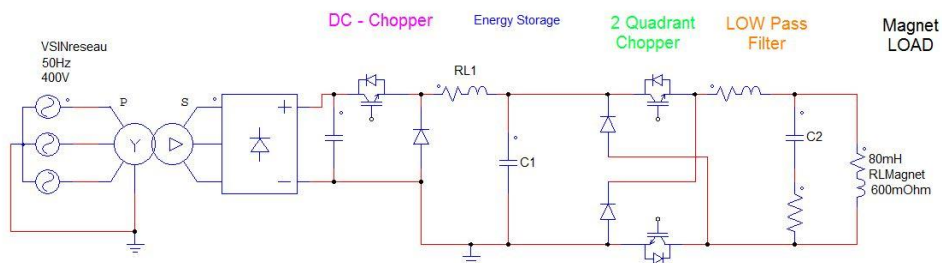

The stored energy is 28kJ for each combined function magnet ring (BD,BF) and the cycling period is 320ms (\rightarrow 3.1Hz).

FULL SCHEMATIC 2 X TIMES CURRENT AND VOLTAGE SPLIT

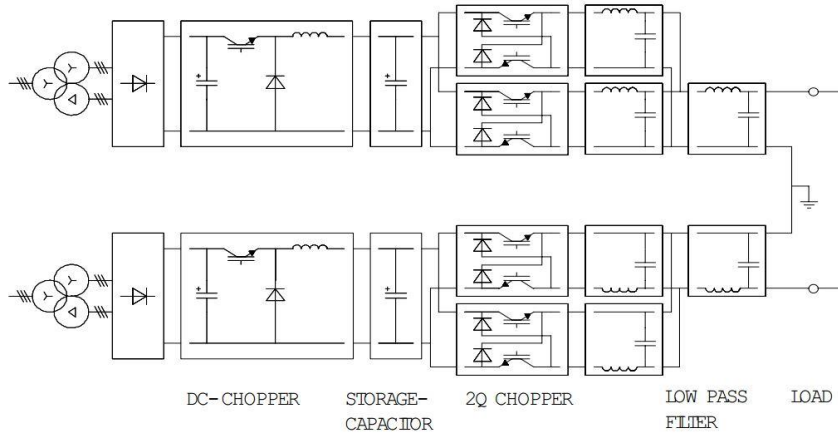

SLS BOOSTER WAVEFORMS

The sine wave can be controlled



Variation of the voltage in the Capacitor

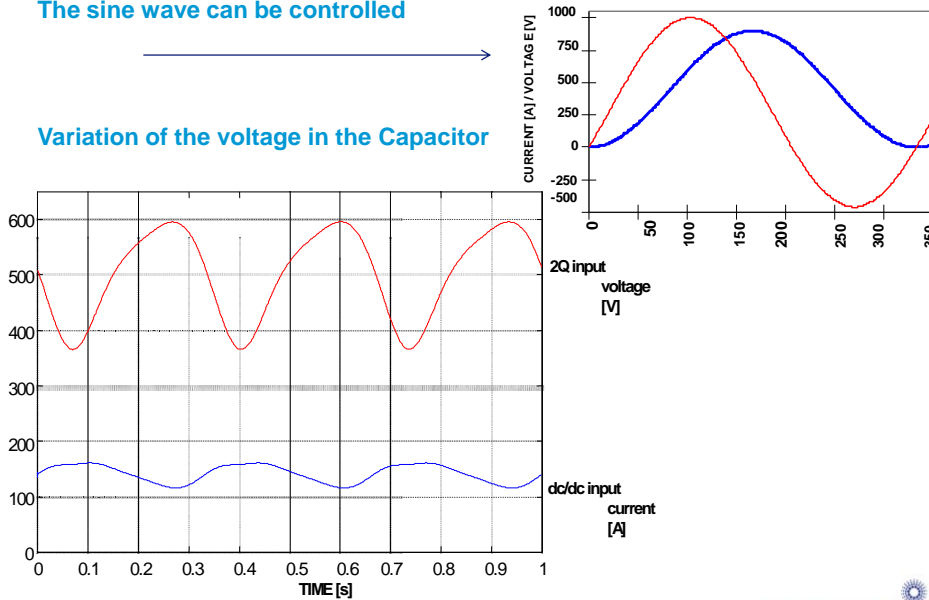

ASSESSMENT OF PULSE WIDTH MODULATION CIRCUIT (PWM)

Comparison with the White Circuit:

- the **PWM** circuit does not need a costly energy storage choke with increased power losses
- within limits of rated current and voltage, the PWM provides flexibility of output waveform
- after switch on, the PWM circuit requires less than one second to stabilise (valuable in 'top up mode').

Booster Power Save Mode

- Top-up mode
 - Define desired Top-up current and current per injection cycle
 - inject every few min. e.g. Top-up 350+1mA: inject 1mA every 160sec
- Booster magnet power supplies
 - Power save: (symbolic: 10 cycles to full power for bend PS)
 - Magnet PS: ~200kW
 - Ramp: 7 power supplies
 - Trigger 8s of 160s
 - ⇒ 5% duty cycle
 - ⇒ reduce to 10kW
 - ⇒ save ~100k\$/year

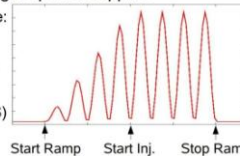

However:

- the current and voltages possible in switched mode circuits are restricted by component ratings.

CASE OF SLOW CYCLING IN PWM WITH INTEGRATED CAPACITOR STORAGE

the CERN Power converter for the Proton Synchrotron (PS) accelerator.

→ Was powered by rotating machine, 90MVA!

→ Basic electrical data for the magnets: + / - 10kV, 6kA, 2.4 sec cycle

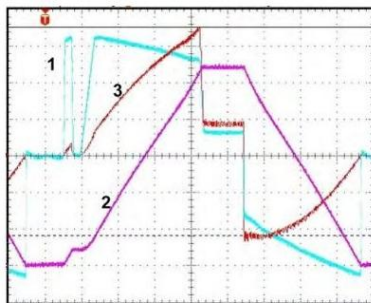

1: Voltage (2.7kV/div)
 2: Current (1kA/div)
 3: Active power (11.5MW/div)
 Time: 200ms/div

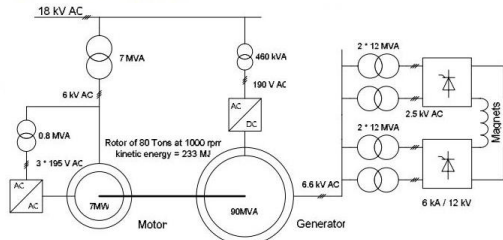

POPS (POWER CONVERTER FOR PROTON SYNCHROTRON)

In 2007 the mechanical storage has been replaced by capacitive storage,

Global view of the single line diagram

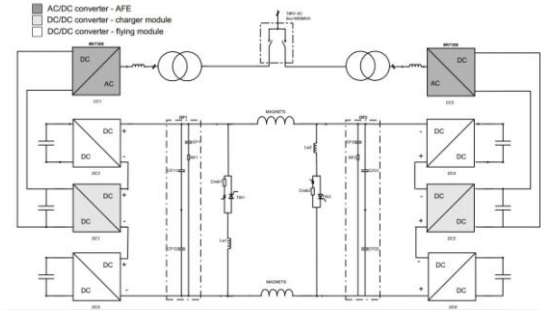

detail of one DC/DC converter

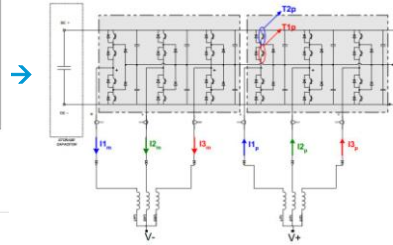

each leg is based by 3 parallel neutral clamped legs
 allowing to produce 3 voltage levels (+VDC/2, 0, -VDC/2)

POPS CAPACITIVE STORAGE

The capacitor banks are located in containers,

Each container (40" shelter) housed 126 units parallel connected total value **0.25 Farads 5kV**

→ **3MJ** stored in each container (40" shelter)

Usable energy from **5 to 2 kV** → **2.5MJ**

6 capacitor banks for the 6 DC/DC converters,

→ **15MJ** are available for the magnets.

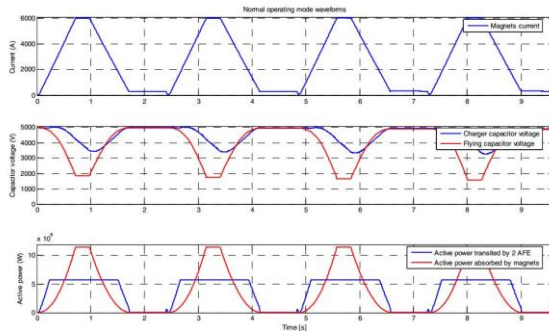

CONCLUSION

The Converters for cycling machines are vital for many large instruments in the physics and applied research. They have slowly evolved since half a century and the main topic is how to master the energy exchange between the power source and the magnetic volume where the particle circulate.

Many thanks to Neil Marks (my first boss) for the authorization to use the transparency prepared for the CAS 2004 , to the Desy power supply group, Jean-Paul Burnet (CERN) for the interesting discussions on these topics.

Thank you for your attention