

Versatile Link Radiation Qualification



Jan Troska

*Stéphane Détraz, Lauri Olanterä, Csaba Soos,
Sarah Storey, Christophe Sigaud, François Vasey
Luis Amaral, Alberto Jimenez Pacheco, Pavel Stejskal*

- Versatile Link Project
- Radiation effects assessment
- Survivability outlook for Phase 2 upgrades

Versatile Link Project

- Optical Physical layer linking front- to back-end
- Bidirectional, ~5Gbps
- Versatile
 - Multimode (850nm) and Singlemode (1310nm) versions
 - Point to Point and Point to Multipoint architectures
- Front-end pluggable module
- Joint Project Proposal submitted to ATLAS & CMS upgrade steering groups in 2007 and endorsed in 2008
- Kick-off mtg in April 2008
 - Phase I: Proof of Concept (18mo)
 - Phase II: Feasibility Study (18mo)
 - Phase III: Pre-prodn. readiness (18mo)

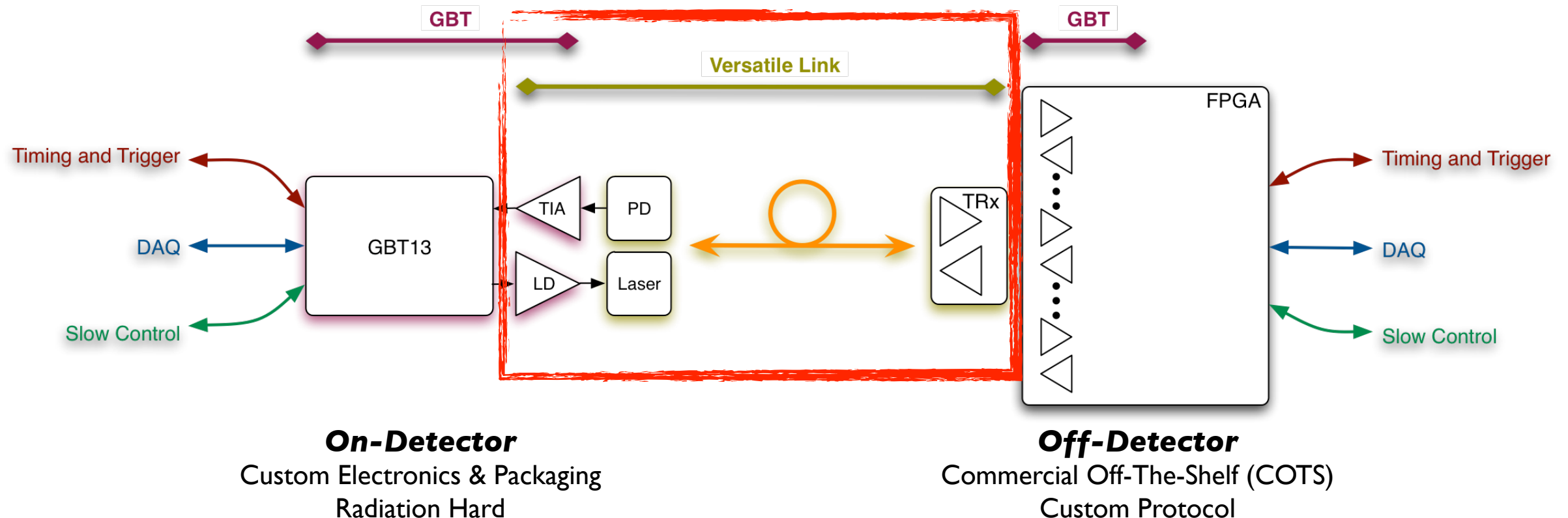

Project Structure and Partners

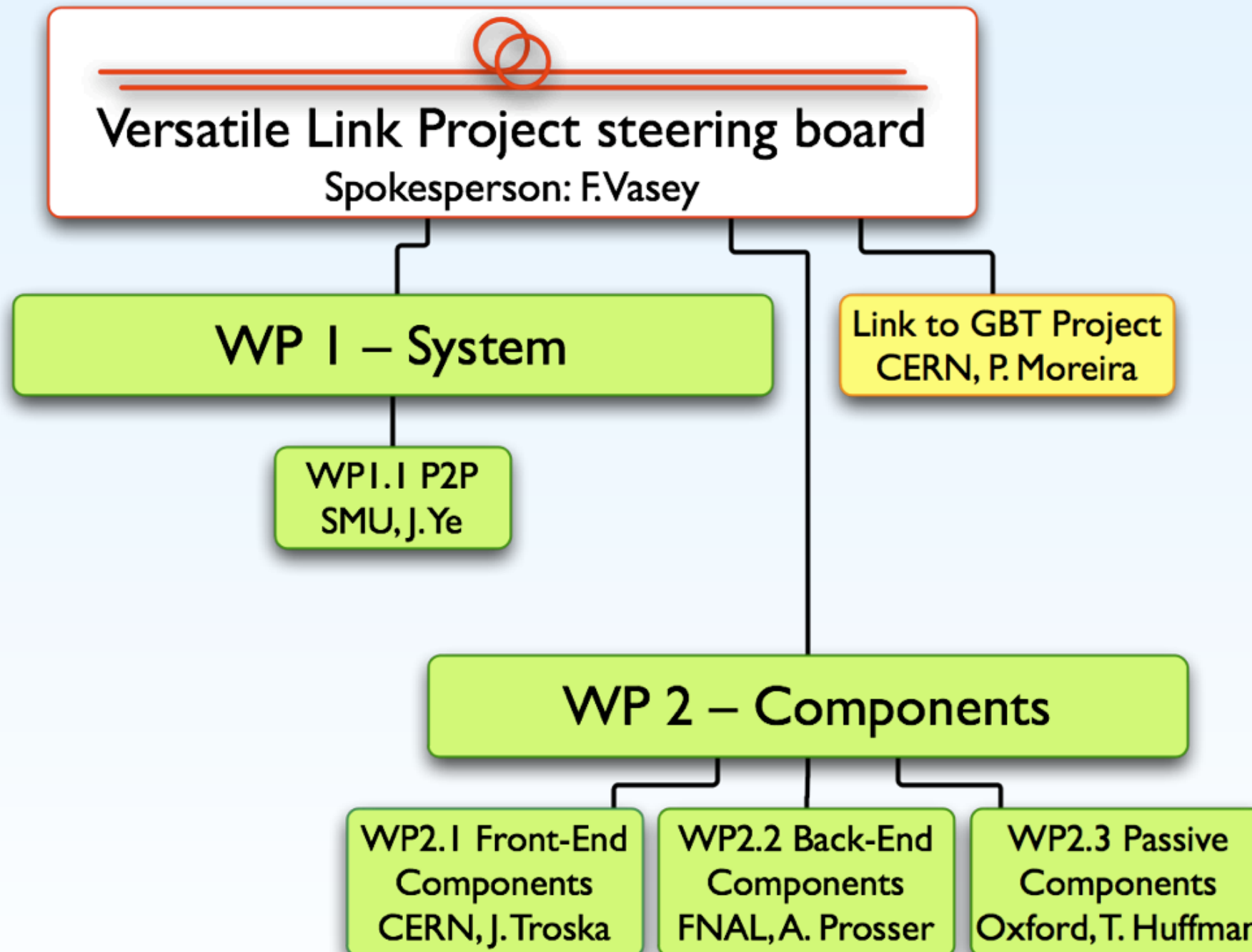

Front-end pluggable module

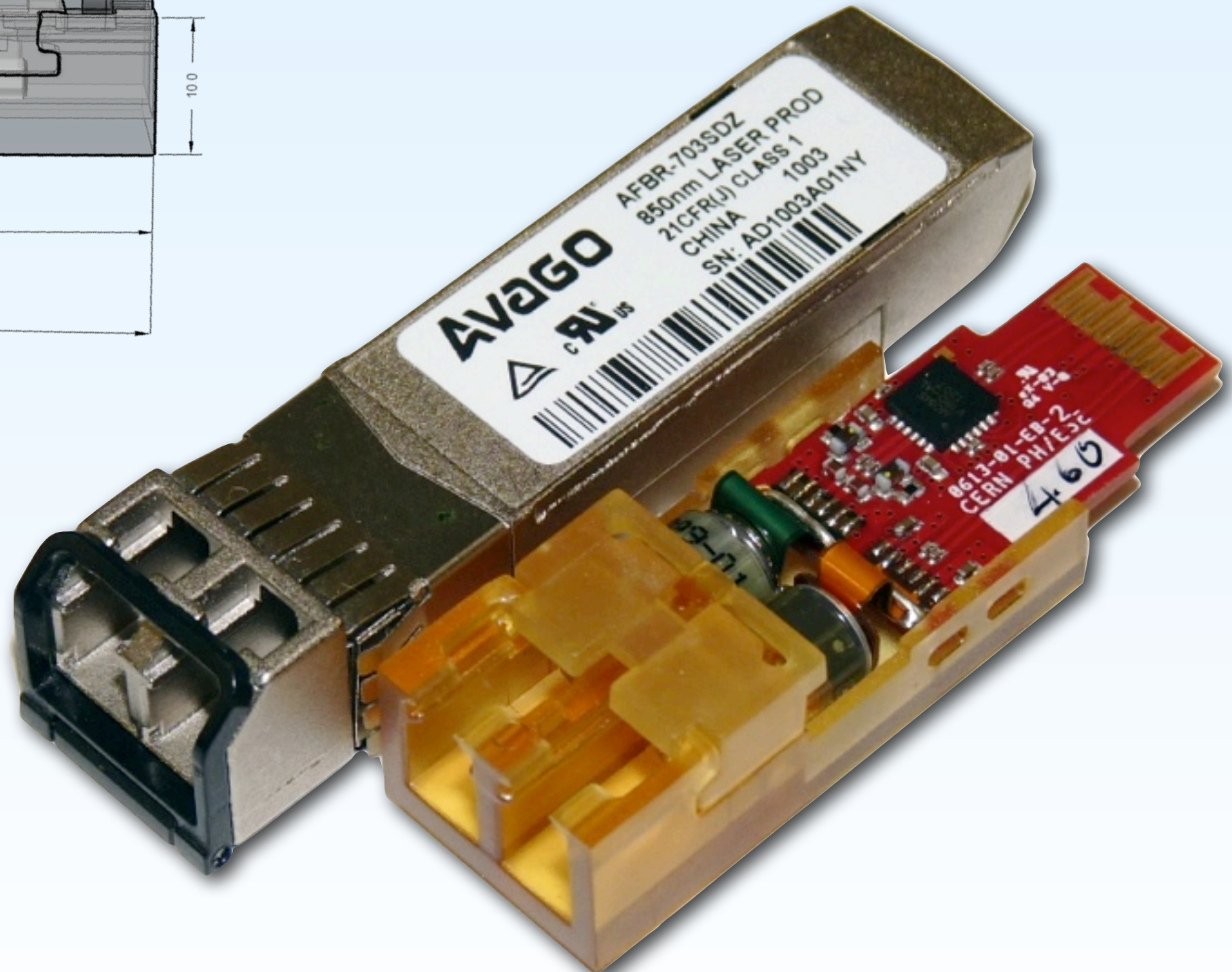
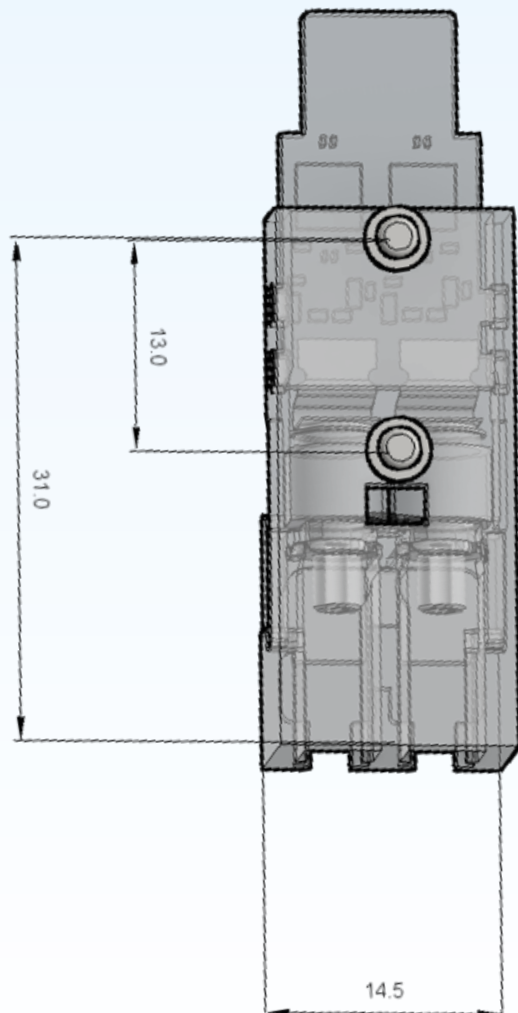
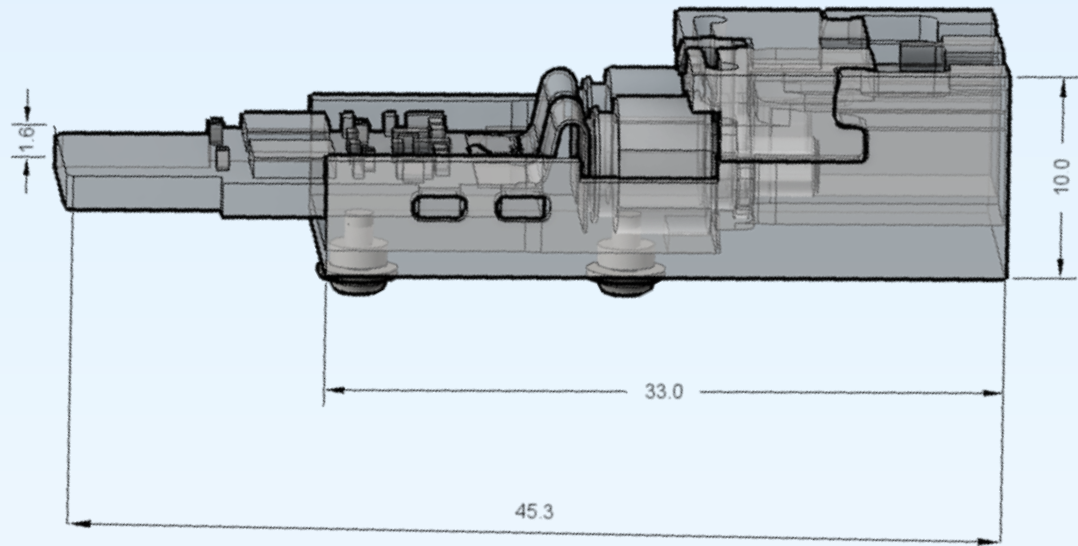

Versatile Link Overview

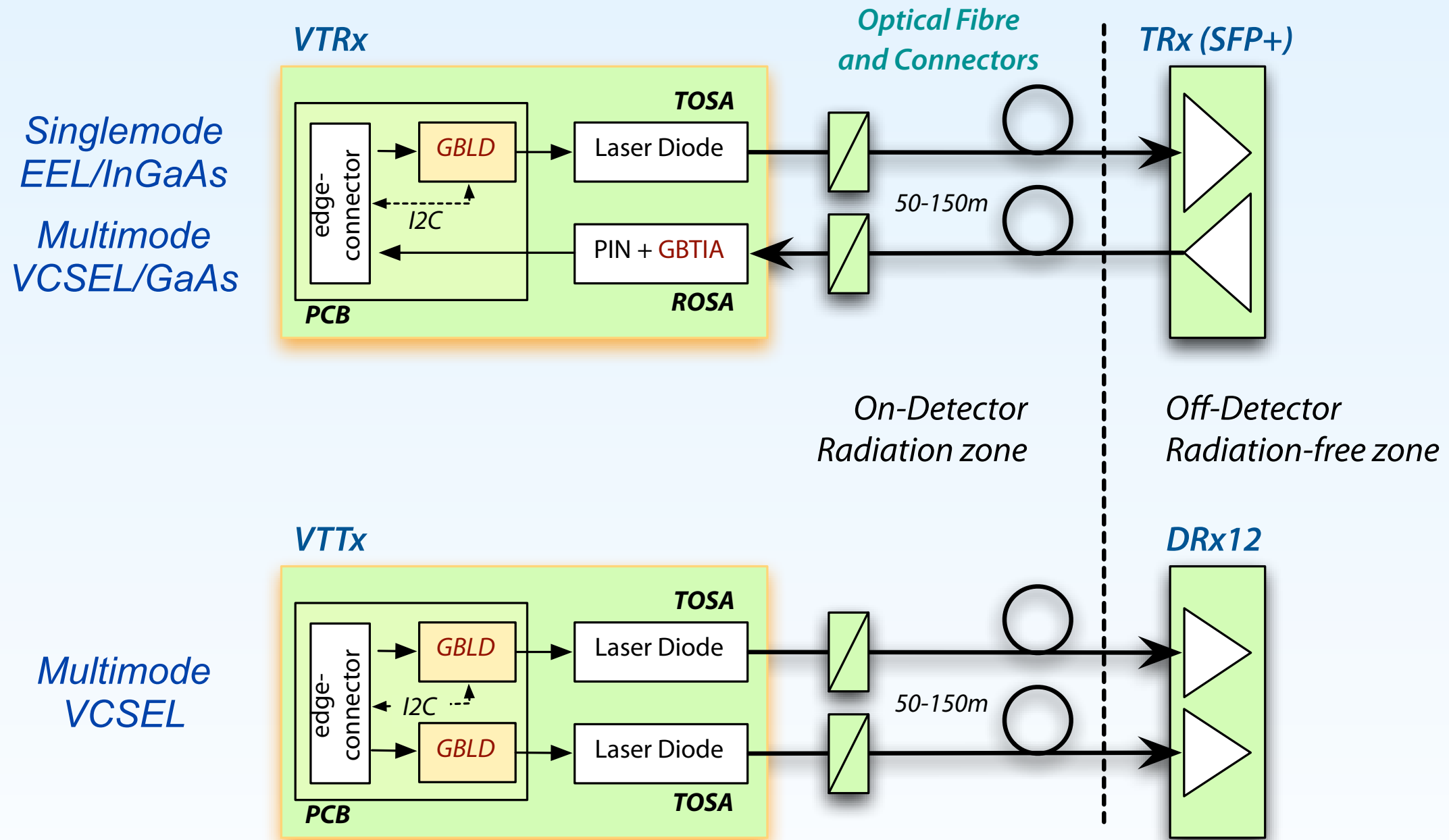

Design Status

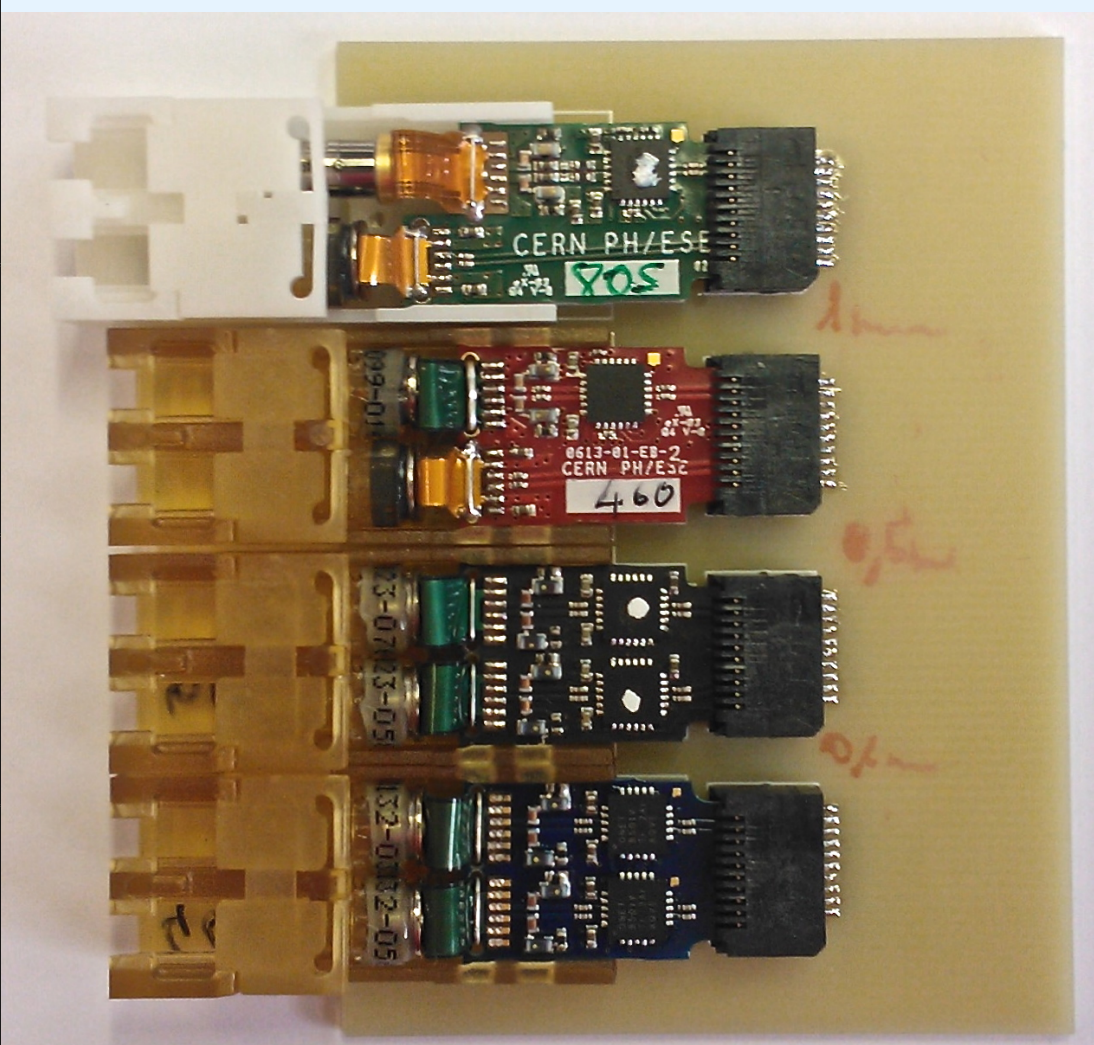
Variant	Laser Driver	TOSA	ROSA	Picture
Single-mode VTRx	GBLD v4.1	Edge Emitter Laser	InGaAs GBTIA v2	
Multi-mode VTRx	GBLD v4.1	850 nm VCSEL	GaAs GBTIA v2	
Multi-mode VTTx	GBLD v4.1	850 nm VCSEL	-	
Rad-soft VTTx	ONET8501V	850 nm VCSEL		

- Performance demonstrated at TWEPP 2012
- Final circuit board layout now complete
- Prototypes available

Procurement quantities

Expt & User	TOSA		ROSA		Latch		VTRx		VTTx
	SM	MM	SM	MM	SM	MM	SM	MM	MM
CMS PIXph1	3000								
CMS HCAL	200	4400	200	400	200	2400	200	400	2000
ATLAS SmWh		1850		650		1250		650	600
ATLAS LArg		150		150		150		150	
LHCb		16900		2900		9900		2900	7000
Alice		9950		3550		6750		3550	3200
BE-BI-BL	500		500		500		500		
BE-BI-QP	500		500		500		500		
Totals	4300	33250	1200	7650	1200	20450	1200	7650	12800

- CERN organises procurement on behalf of users
- Overall budget for all items is around 2.8 MCHF

- Procurement process defined and started
 - Need to take funding into account to finalize timing of commercial actions
 - Tendering needs to be completed to know final cost
 - Contract must be placed reasonably soon after tender
- One year from TOSA contract placement to first delivery of VTXx
- Volume production to kick-off by the end of 2014

- Versatile Link Project
- **Radiation effects assessment**
- Survivability outlook for Phase 2 upgrades

Assessment of radiation effects

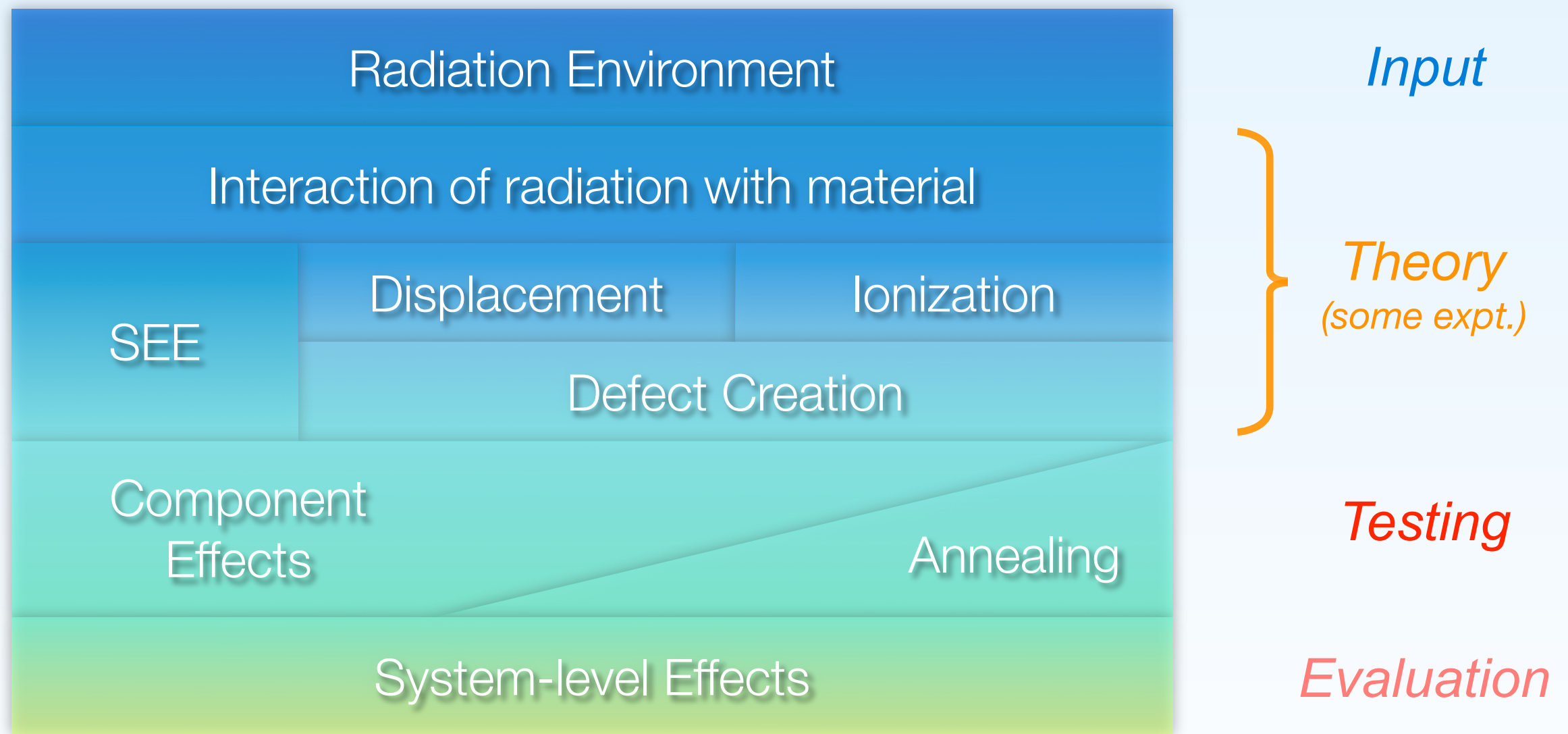

Radiation levels for CMS at HL-LHC

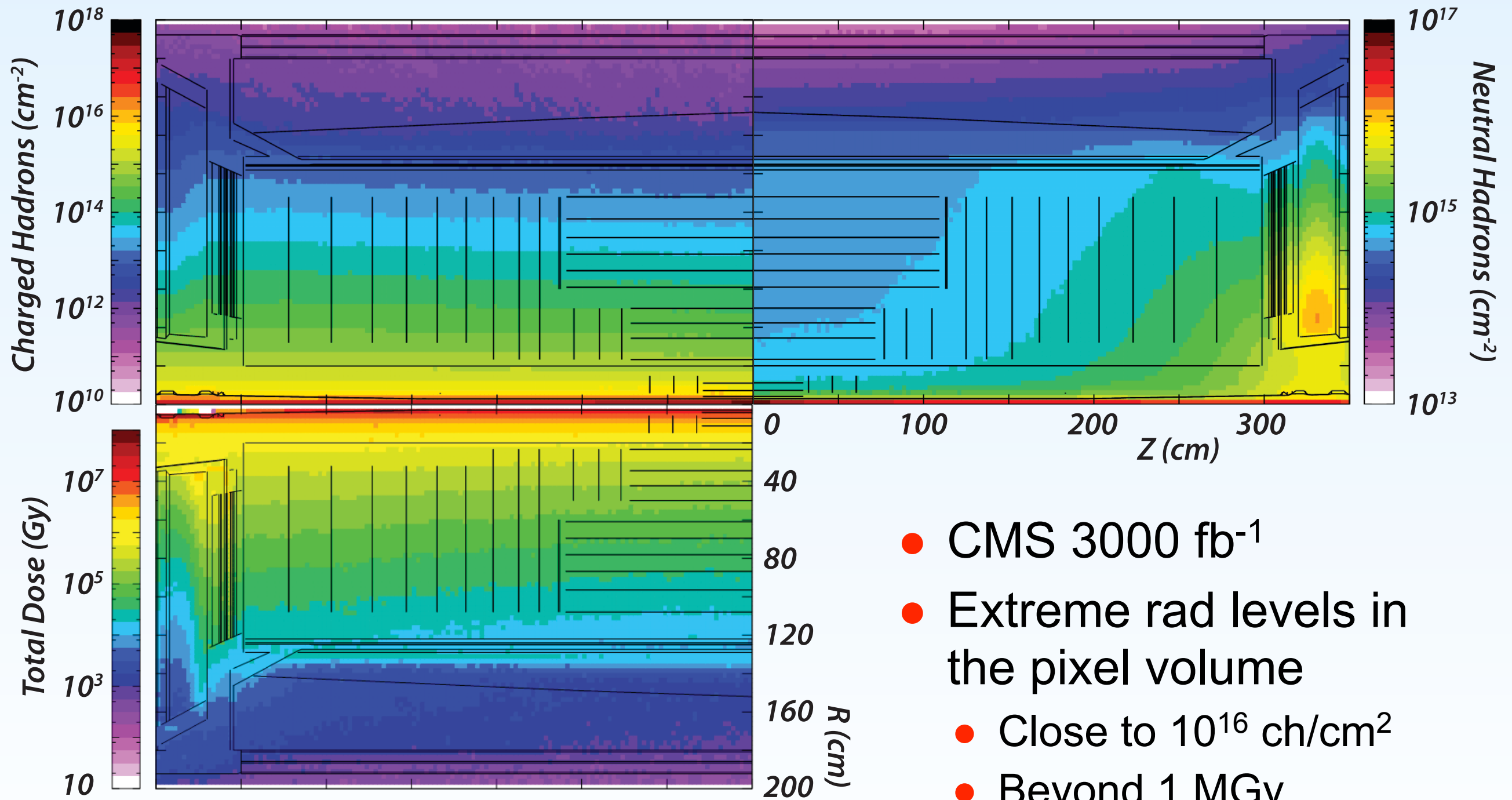

In terms of flux

CMS pp 7TeV FLUKA: All Particles

10000.0 [$\mu\text{b}^{-1} \text{s}^{-1}$]

$10^{34} / \text{cm}^2/\text{s}$

Estimation only, not for publication

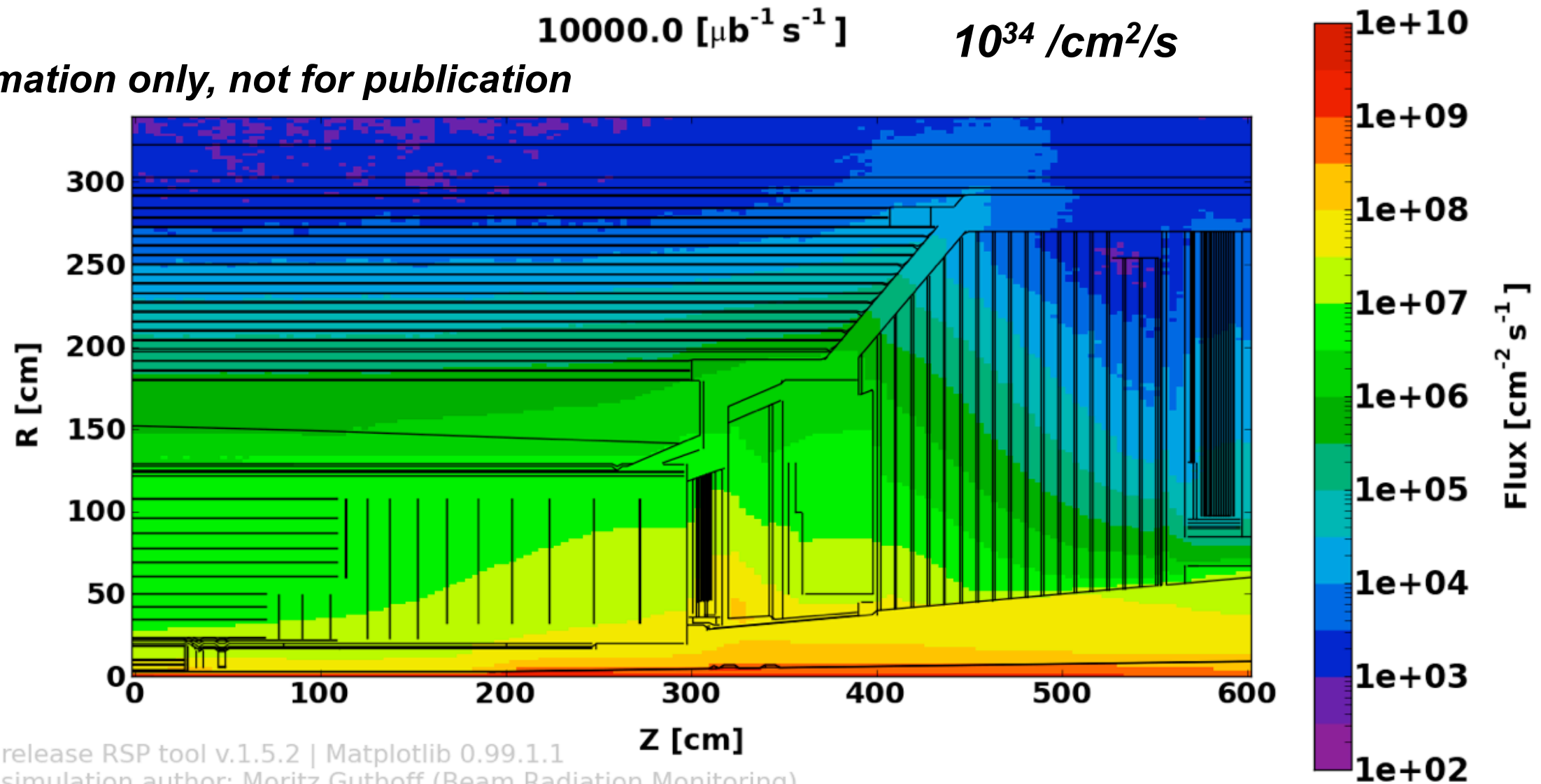

- Tracker: $10^8 / \text{cm}^2/\text{s}$
- Calorimeter: $10^6 / \text{cm}^2/\text{s}$

HL-LHC  x10

Radiation tolerance levels

- VL specifications define two tolerance levels depending on application

Table 4.1.1 Versatile link environmental requirements







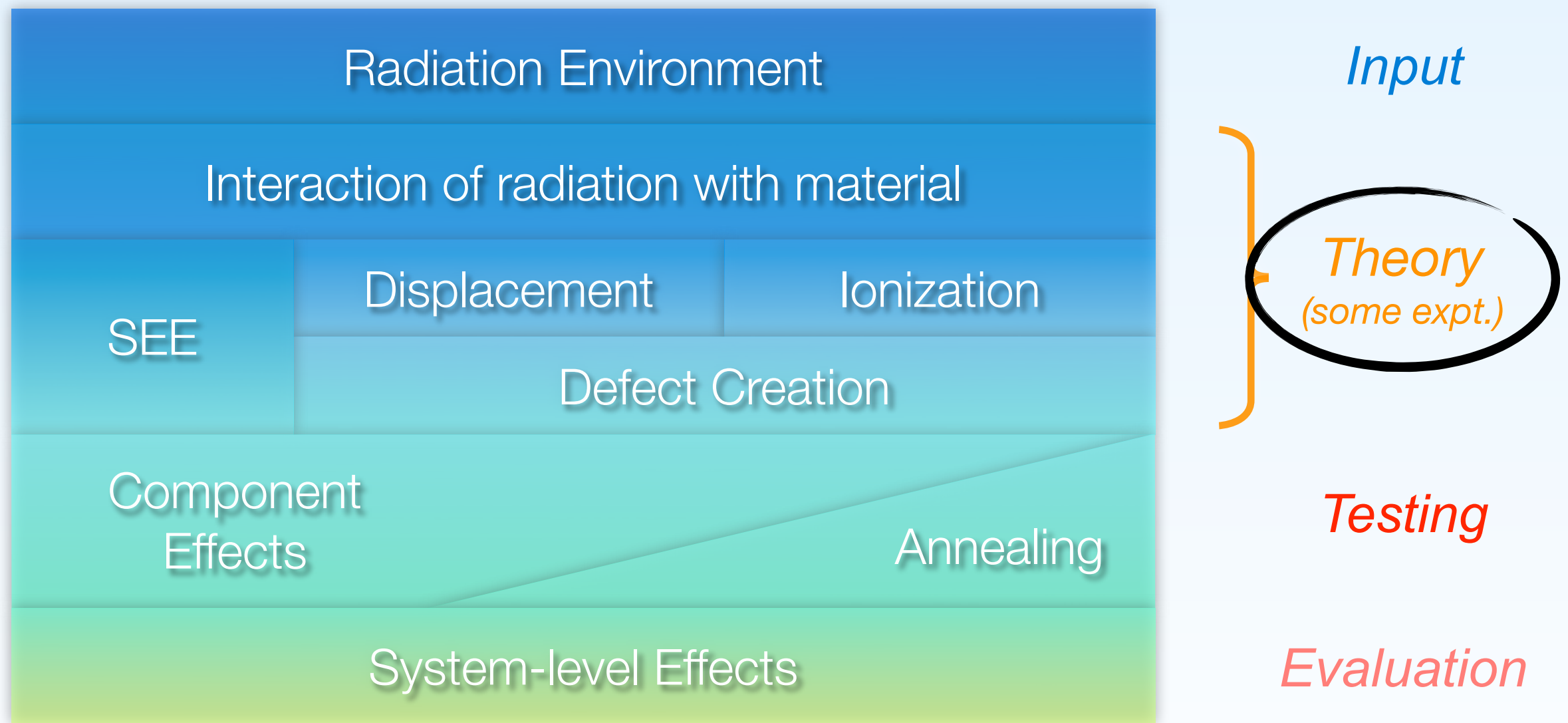





	Tolerance level	Dose and fluence ¹ (1Mev neutron equivalent)
4.1.1.1	Calorimeter	10 kGy 5×10^{14} n/cm ²
4.1.1.2	Tracker	500 kGy 2×10^{15} n/cm ² 1×10^{15} h/cm ²

- All of the upcoming production will be qualified for the Calorimeter tolerance level
 - Nevertheless, up until now component qualification for selection purposes has been carried out up to HL-LHC Tracker levels

Assessment of radiation effects



Radiation Effects Summary

Device	Displacement	Total Dose	SEU
Transmitters <i>LEDs</i> <i>Lasers</i>			
Receivers <i>P-I-N</i> <i>APD</i> <i>CCD</i>			
Switches <i>Optocouplers</i>			
Passives <i>Fibres</i> <i>Couplers</i> <i>Connectors</i>			

 Danger!!  Beware  Probably OK!

Radiation Effects Summary

Device	Displacement	Total Dose	SEU
Transmitters <i>LEDs</i> <i>Lasers</i>	●	●	●
Receivers <i>P-I-N</i> <i>APD</i> <i>CCD</i>	●	●	●
Switches <i>Optocouplers</i>	●	●	●
Passives <i>Fibres</i> <i>Couplers</i> <i>Connectors</i>	●	●	●

● Danger!! ● Beware ● Probably OK!

In-situ testing
highly desirable

Assessment of radiation effects

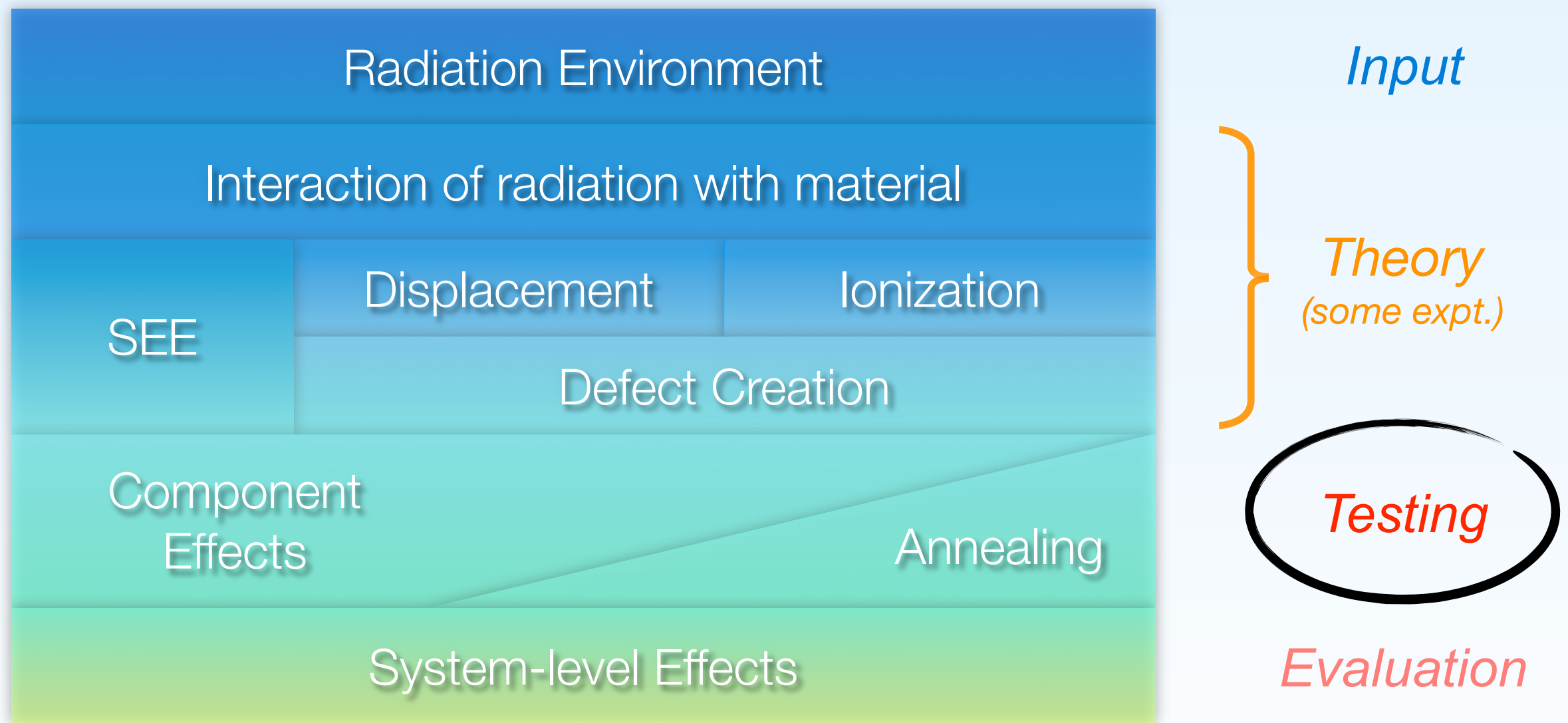

Typical behaviour of Laser Diodes

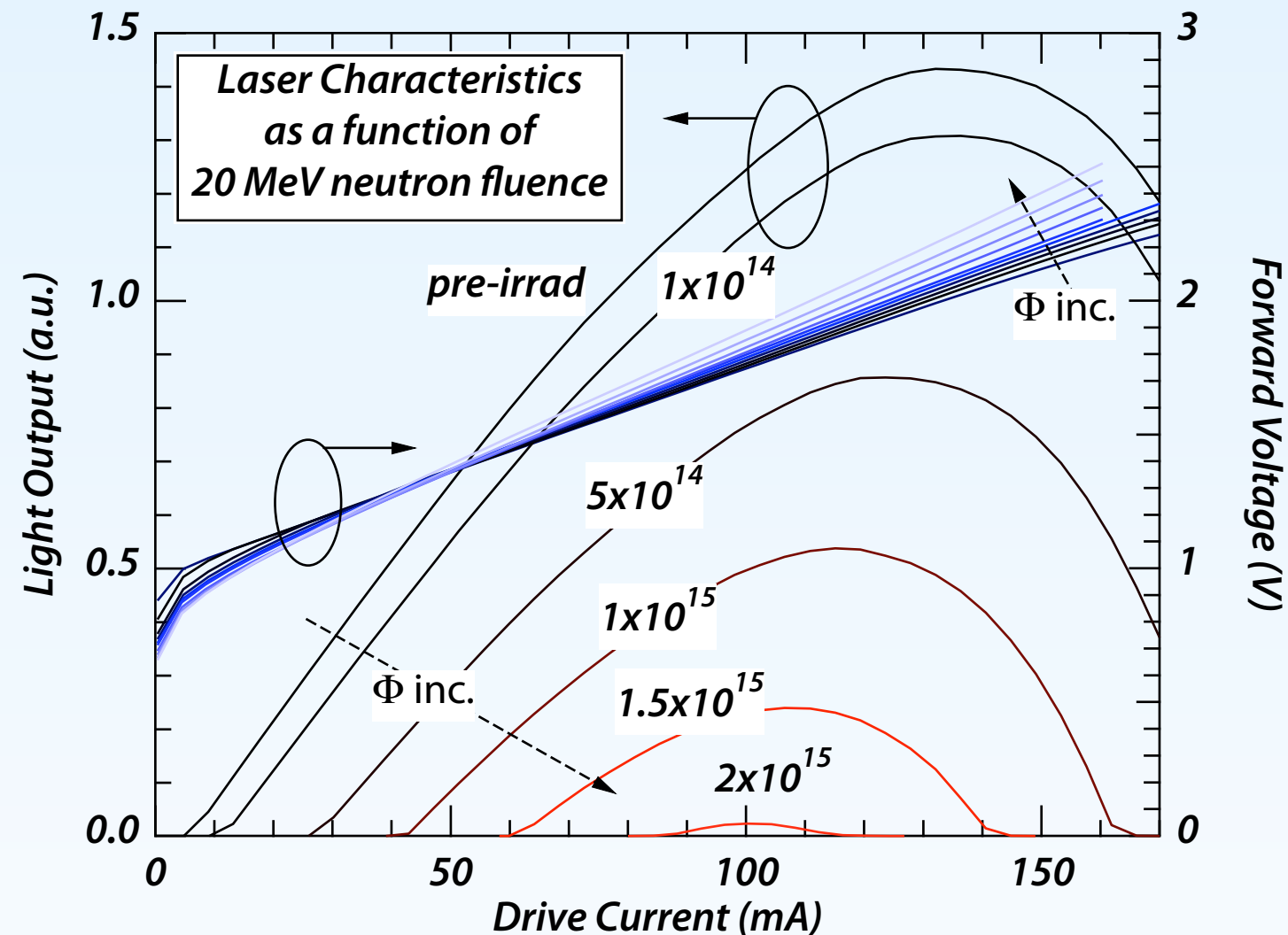

- As radiation level increases, defects are introduced into the material that decrease carrier lifetime
 - Observe increased laser threshold current & reduced efficiency

Laser device testing

- Irradiation of large variety of devices over several tests
 - Louvain la Neuve (B) 20 MeV neutron beam (two tests)
 - PSI 190 MeV pion beam for cross-calibration (2-3x more damaging)
- Once candidates narrowed down, have included target devices in 3 further neutron tests

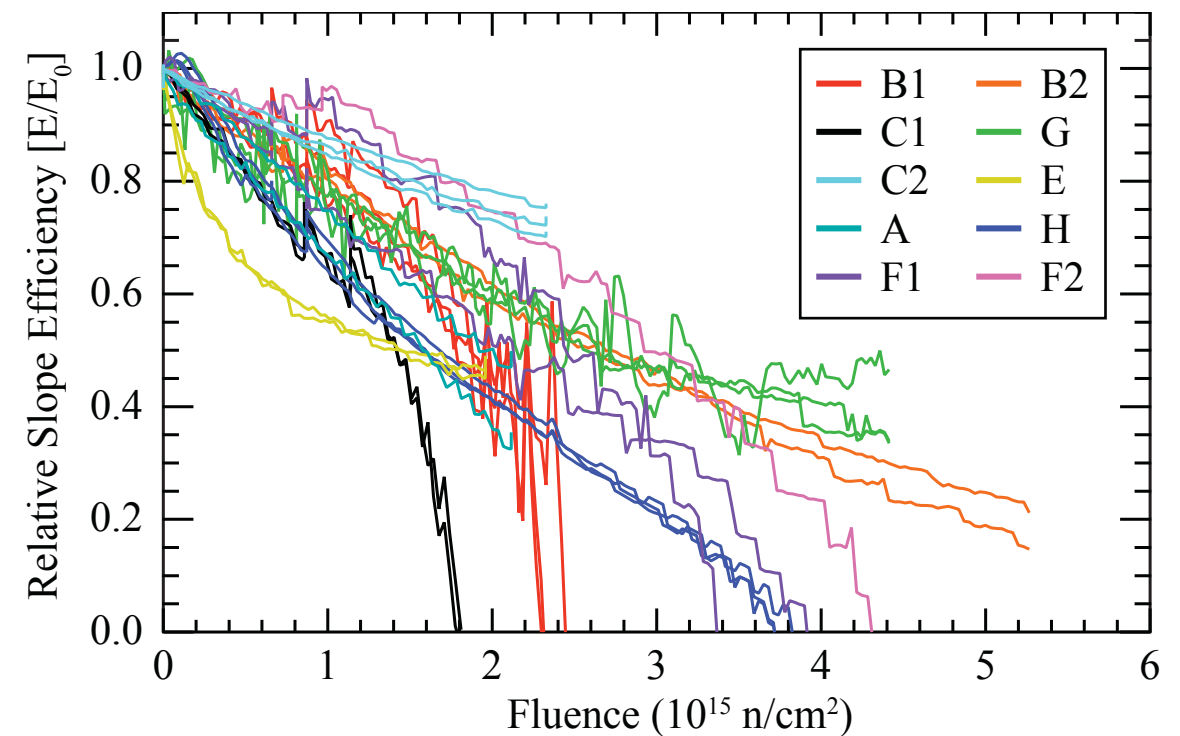
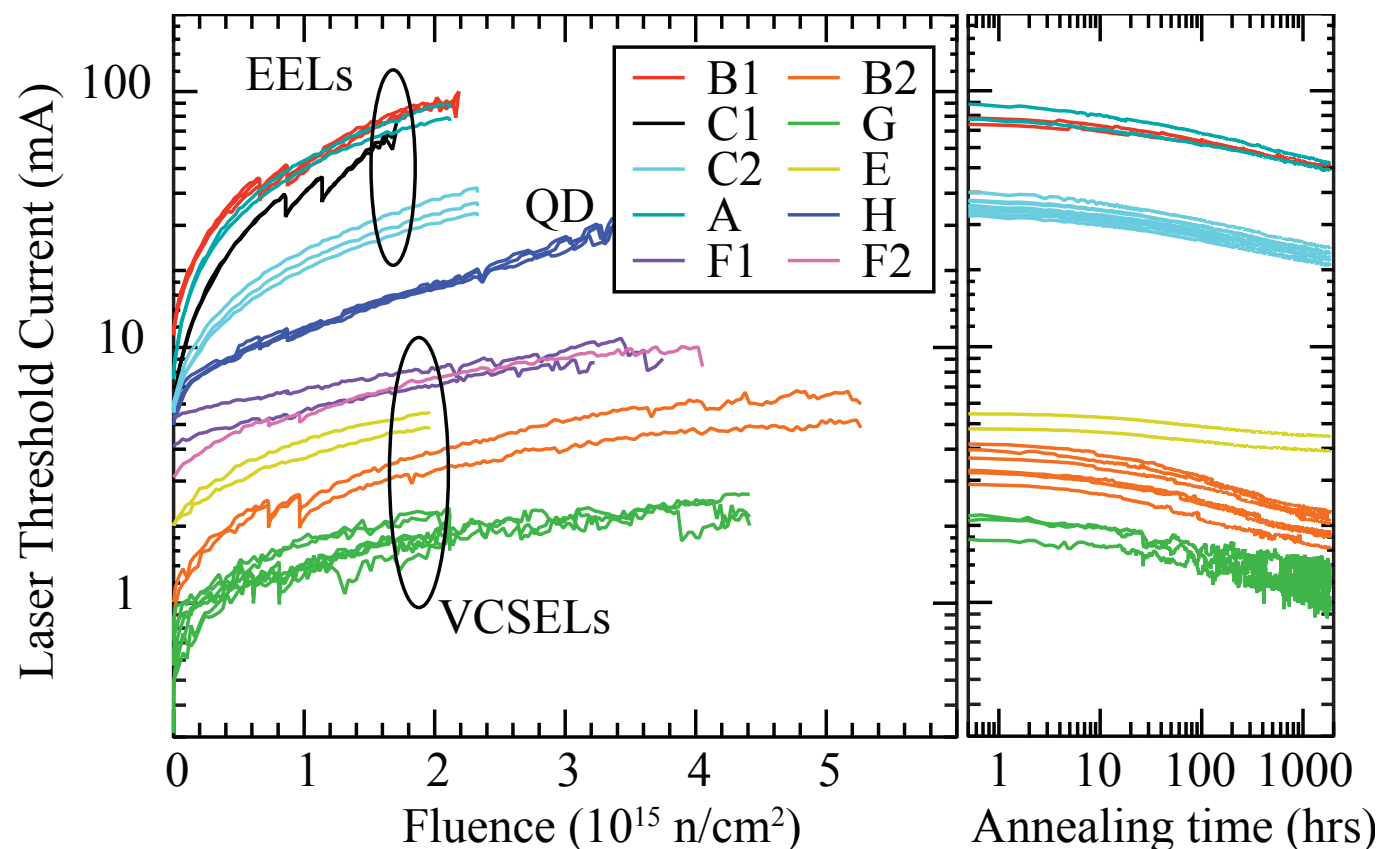

Laser damage modelling

- In-situ measurements and recording of annealing periods have allowed modelling of degradation
 - Laser model based on rate-equations with additional terms for defect introduction
- Allows extrapolation to lower fluxes
 - Predict factor of 2-3 reduction in damage vs. accelerated irradiation test

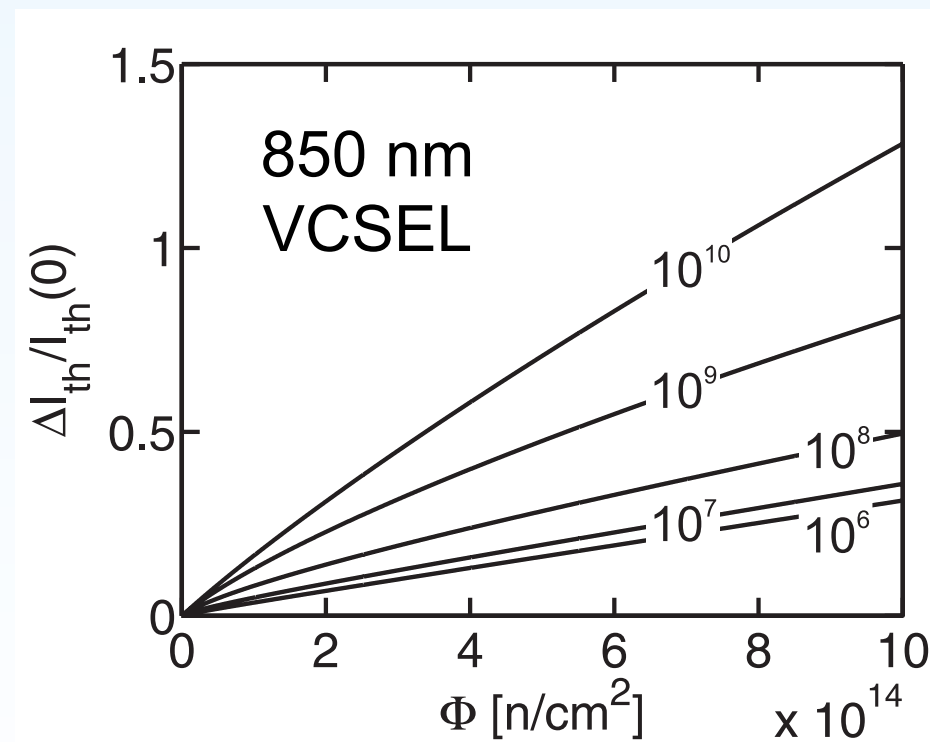
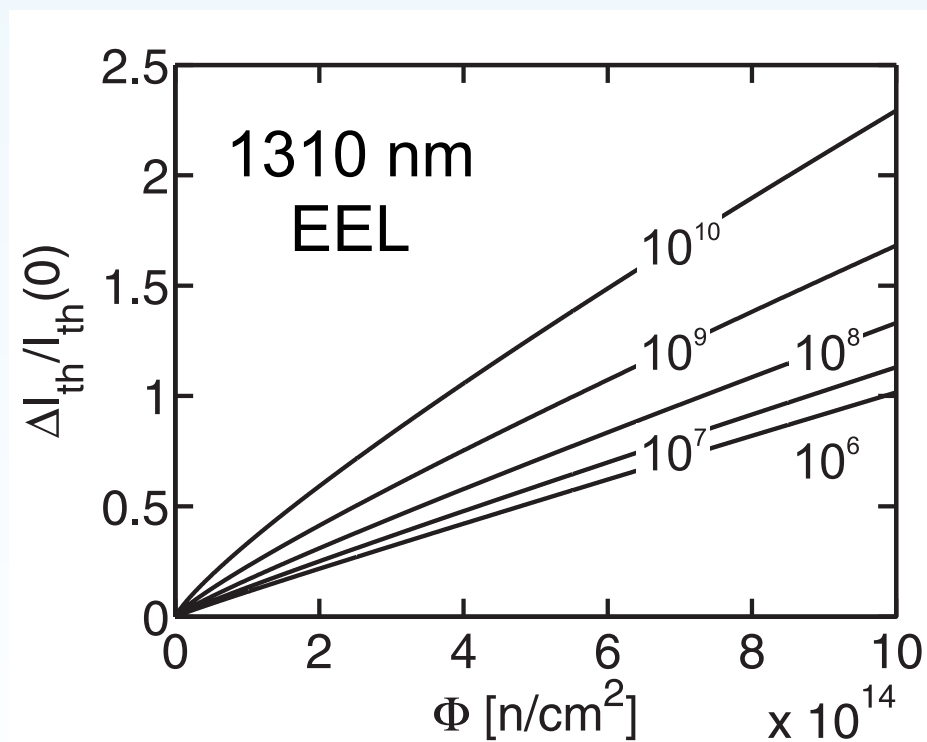

<http://cds.cern.ch/record/1596006/files/CERN-THESIS-2013-115.pdf>

Photodiode testing

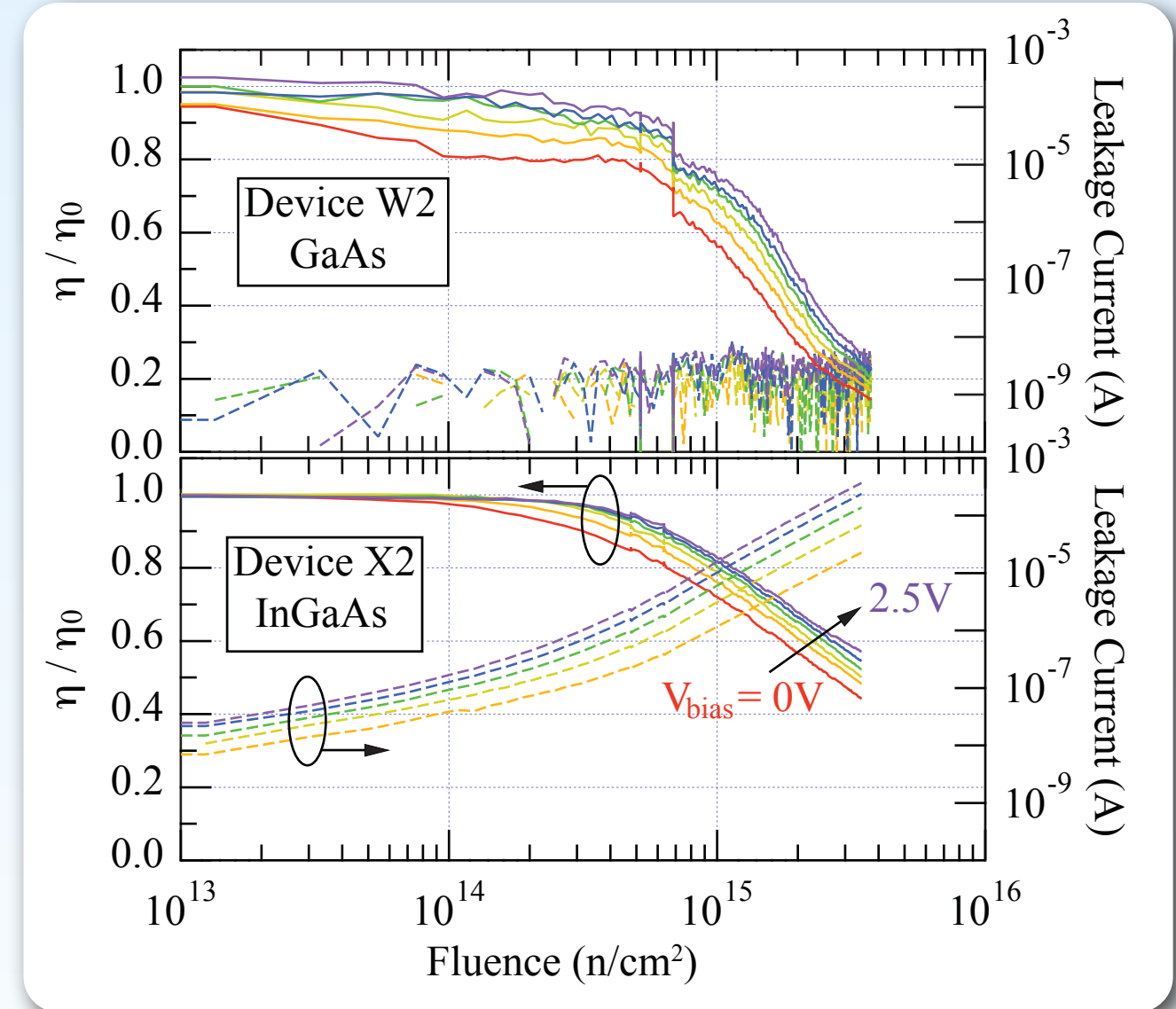
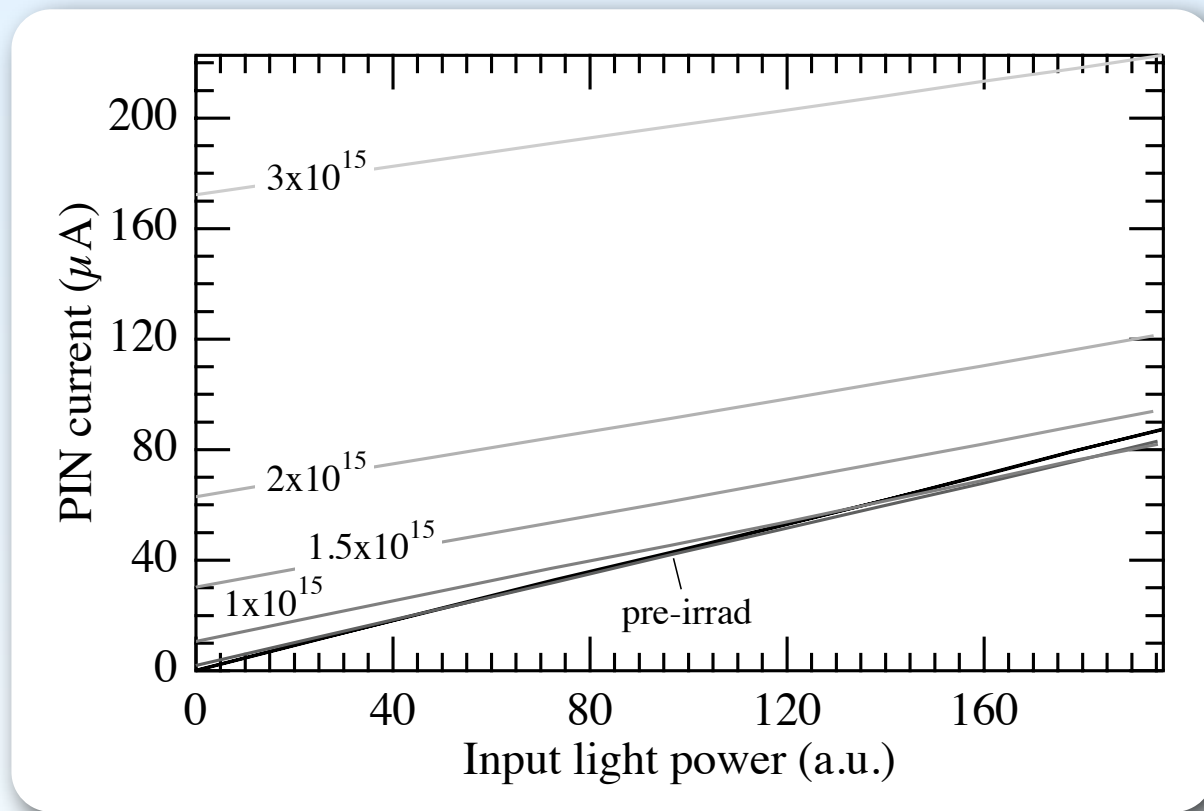

- Defects cause compensation of intrinsic region of p-i-n and consequently loss of detection efficiency
- Also leakage increase in InGaAs

Photodiode device survey

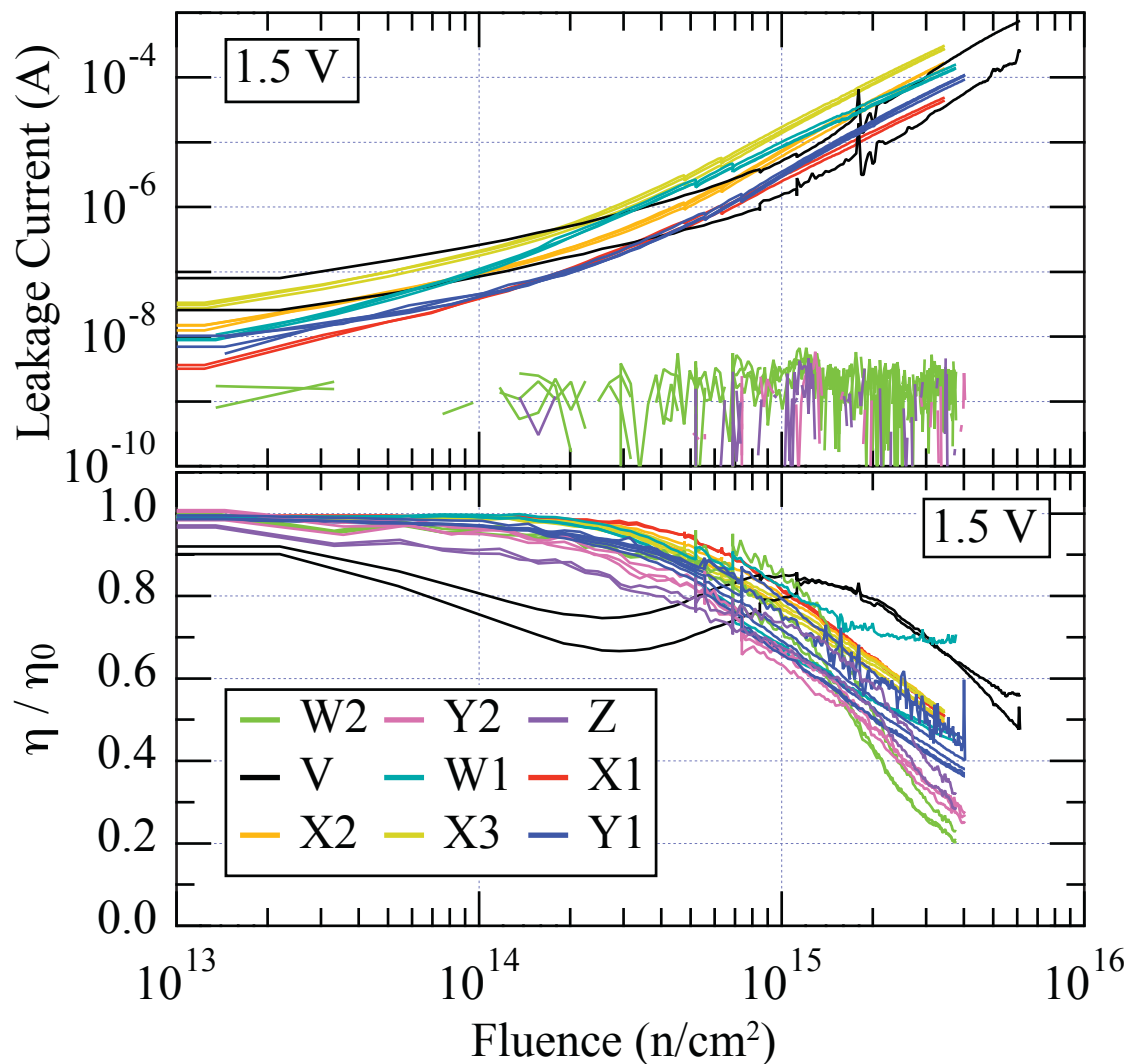

Pions 2.2x more damaging

- Similar response from all vendors of modern high-speed photodiode that we have tested
 - InGaAs devices survive to higher fluences in terms of responsivity
 - GaAs devices show no significant increase in leakage current
- As there is basically no annealing in photodiodes the damage observed at the target fluence is the one that counts

Assessment of radiation effects

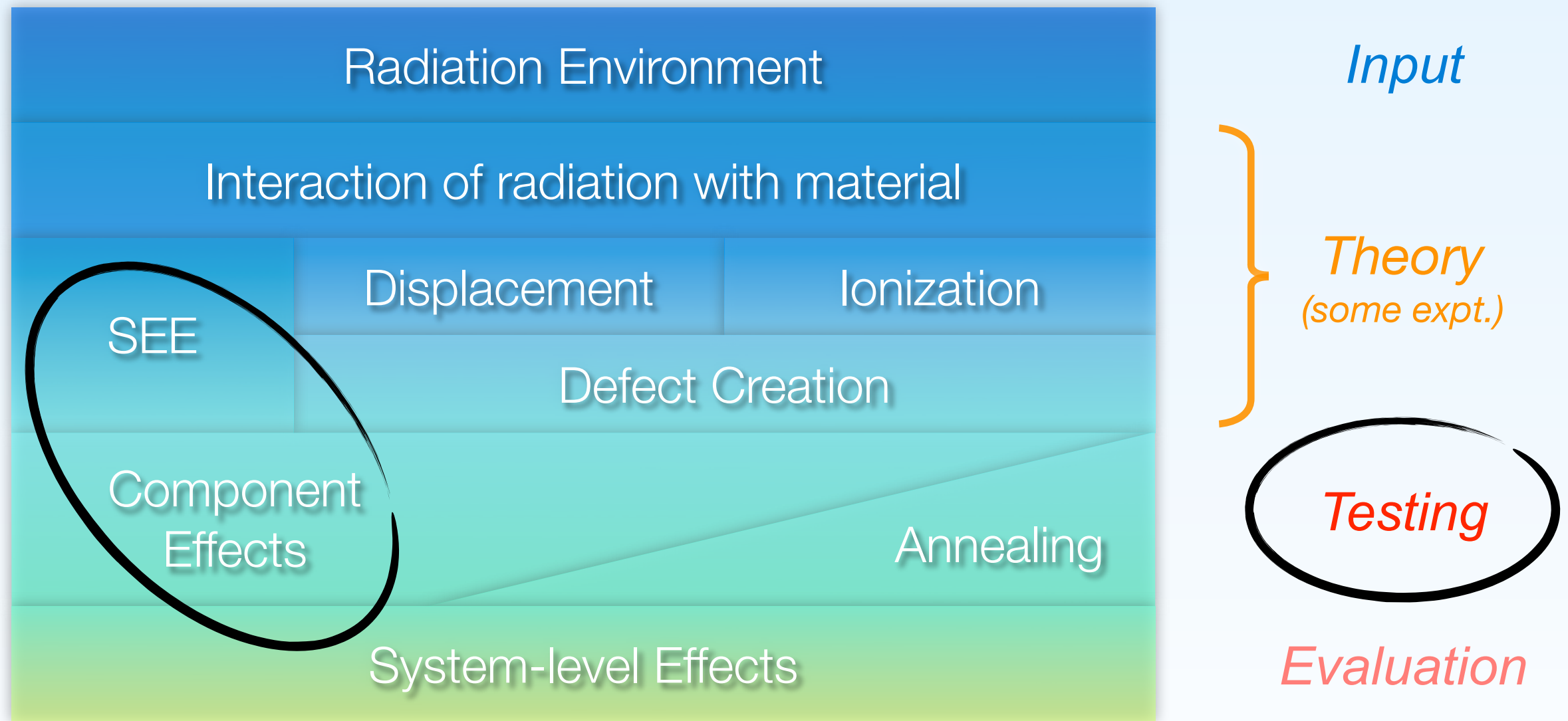

Single-event upsets

- Photodiodes are good particle detectors
 - Passage of particles can create data-like signals

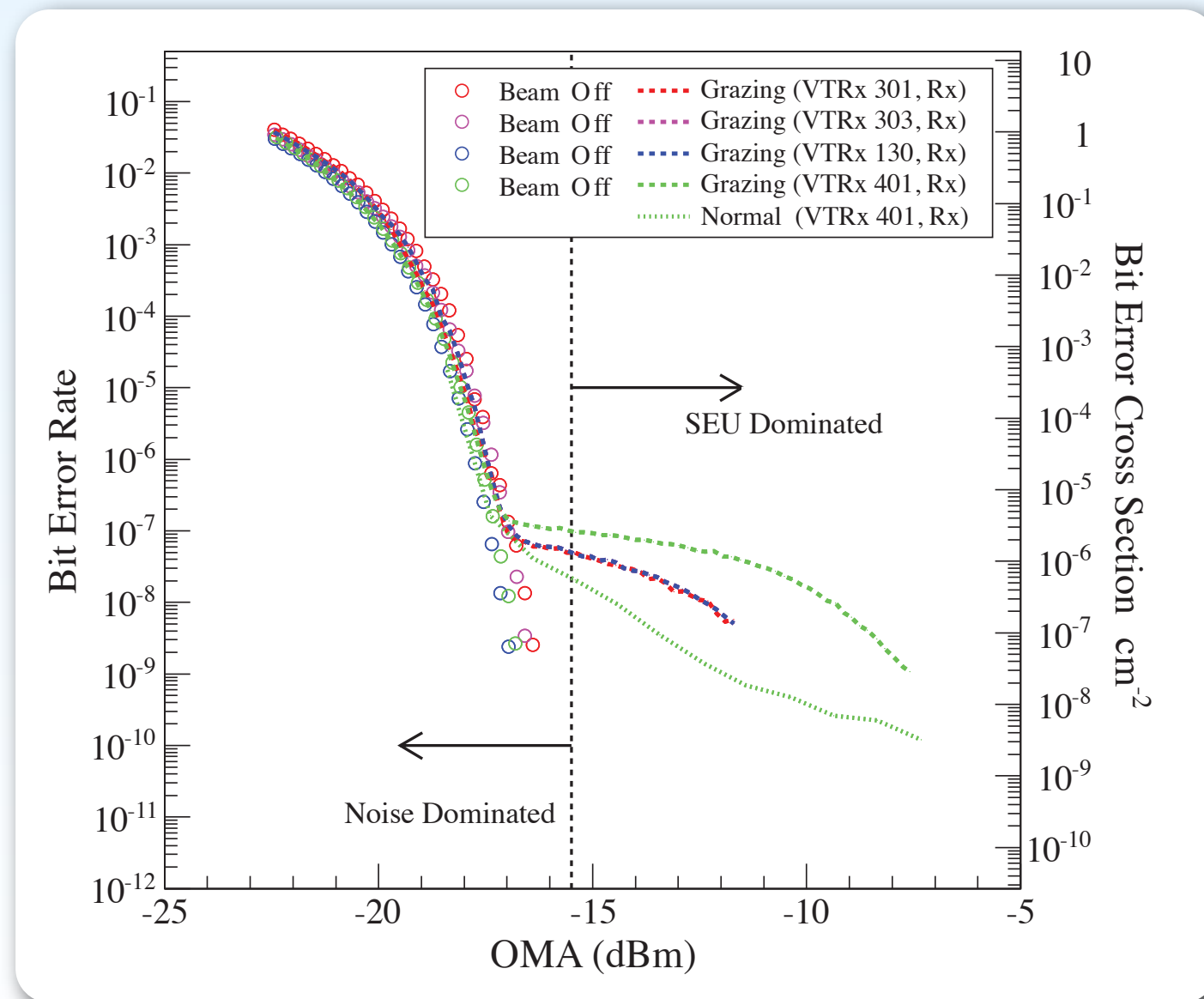

- Before the work carried out in the radiation qualification of the Versatile Link components, only single-bit errors were considered in the literature
 - Multi-bit errors depend critically on the behaviour of the TIA circuit response to overload
 - One-to-Zero errors observed as well as the expected Zero-to-One

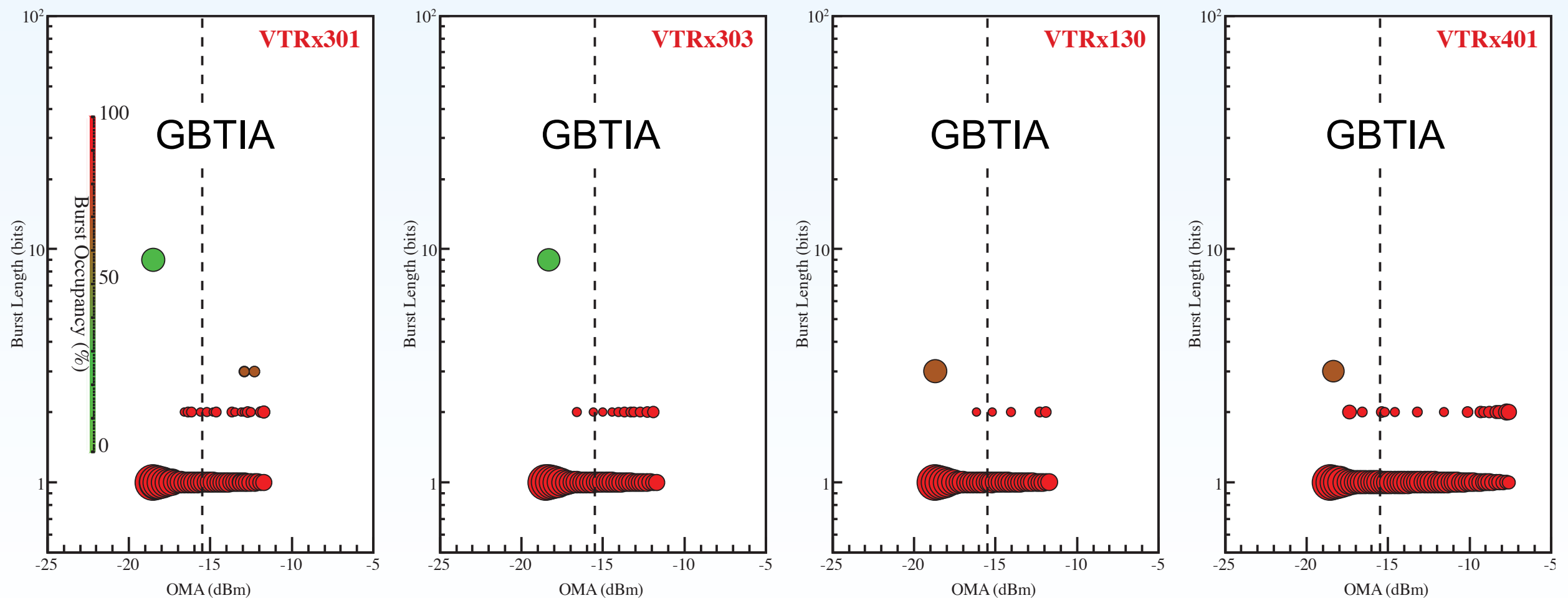

Assessment of radiation effects

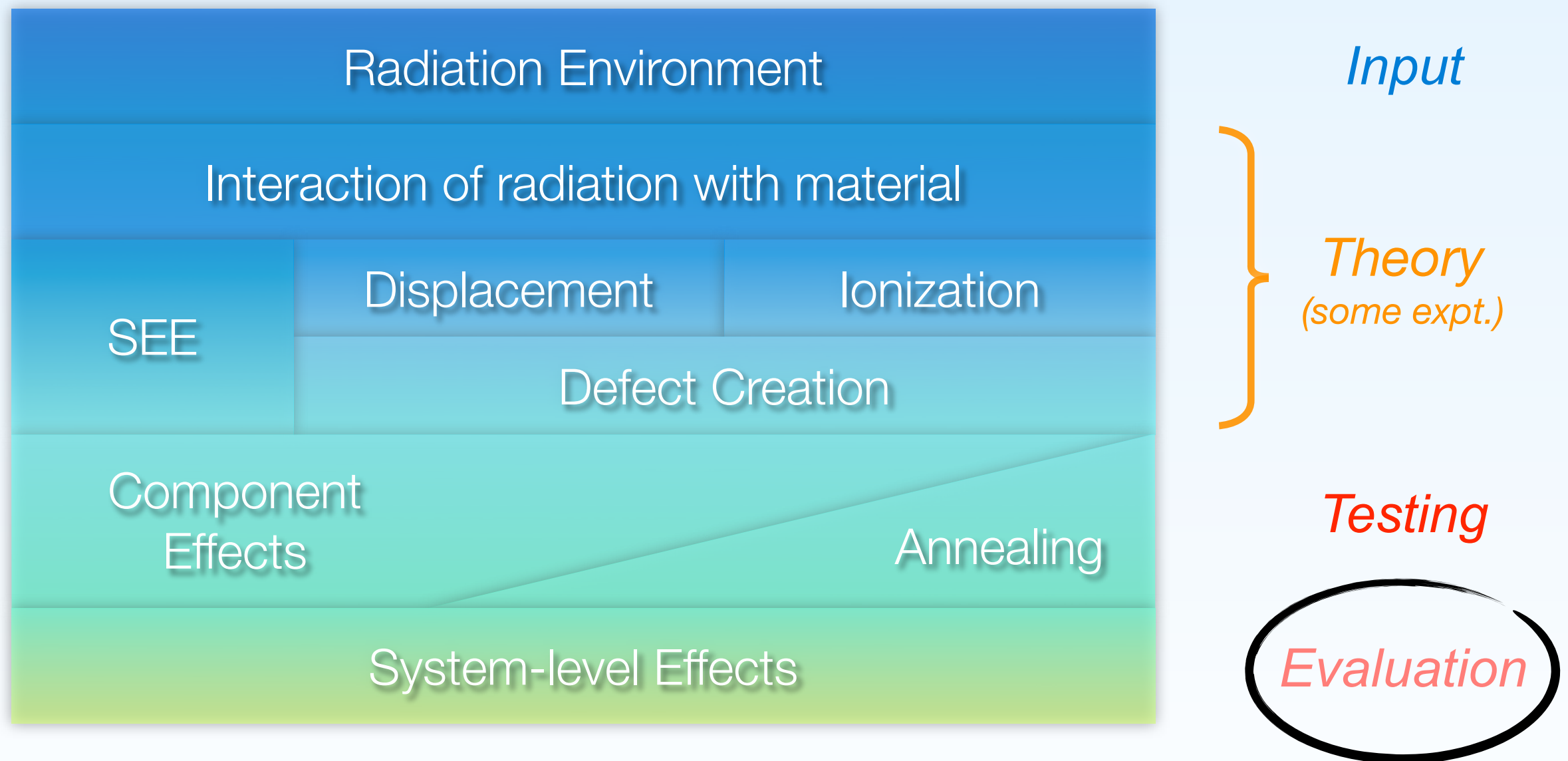

Radiation penalties in Link Budget

Calorimeter Grade

	MM_VTx_Rx	MM_Tx_VRx	SM_VTx_Rx	SM_Tx_VRx
Min. Tx OMA	-5.2 dBm	-3.2 dBm	-5.2 dBm	-5.2 dBm
Max. Rx sensitivity	-11.1 dBm	-13.1 dBm	-12.6 dBm	-15.4 dBm
Power budget	5.9 dB	9.9 dB	7.4 dB	10.2 dB
Fiber attenuation	0.6 dB	0.6 dB	0.1 dB	0.1 dB
Insertion loss	1.5 dB	1.5 dB	2.0 dB	2.0 dB
Link penalties	1.0 dB	1.0 dB	1.5 dB	1.5 dB
Tx radiation penalty		-		-
Rx radiation penalty	-		-	
Fiber radiation penalty	0.1 dB	0.1 dB	0 dB	0 dB
Margin				

VCSEL voltage headroom

- The concern is that already pre-irradiation we hit the headroom limit of the forward voltage with some VCSELs

LI-curve using GBT v4 bias

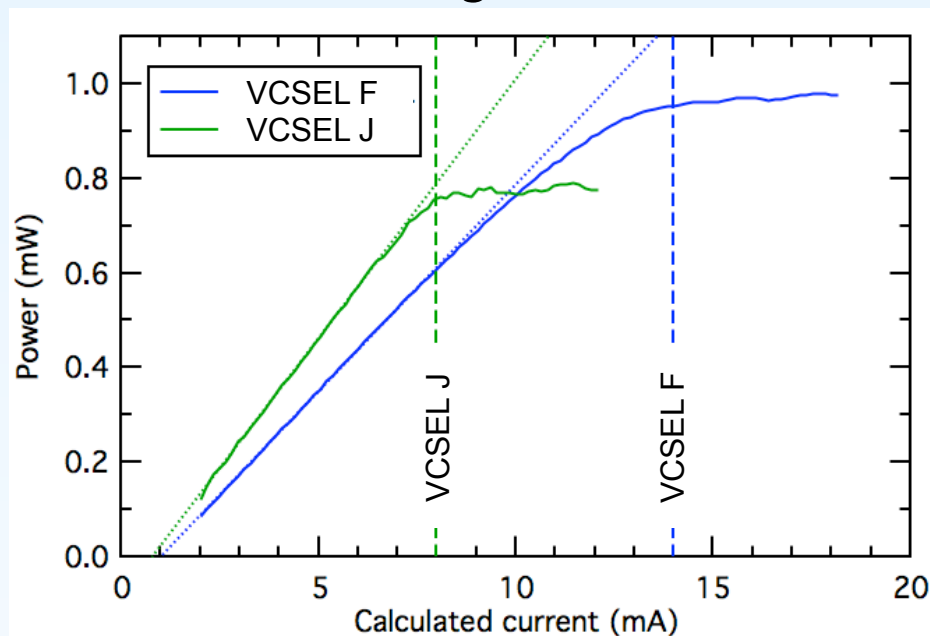

Data taken during pion irradiation

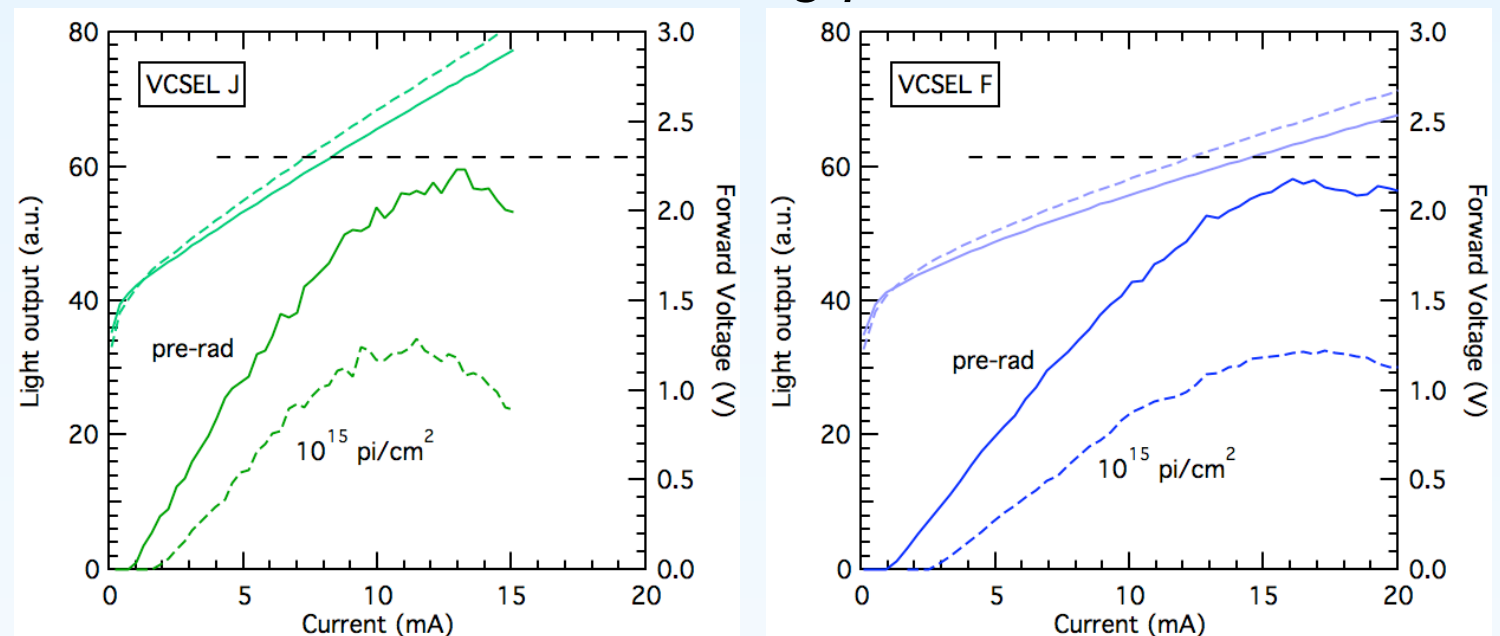

Solid & Dashed lines remain separate
Headroom exists for both tested types

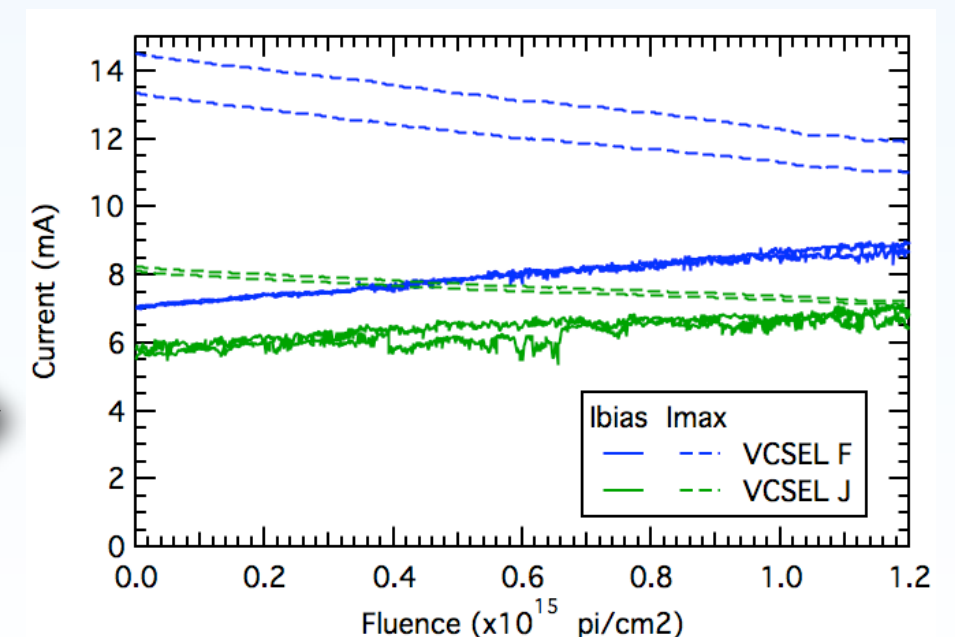
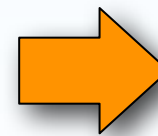

VCSEL efficiency drop

- Does the drop in efficiency put the output OMA below threshold?

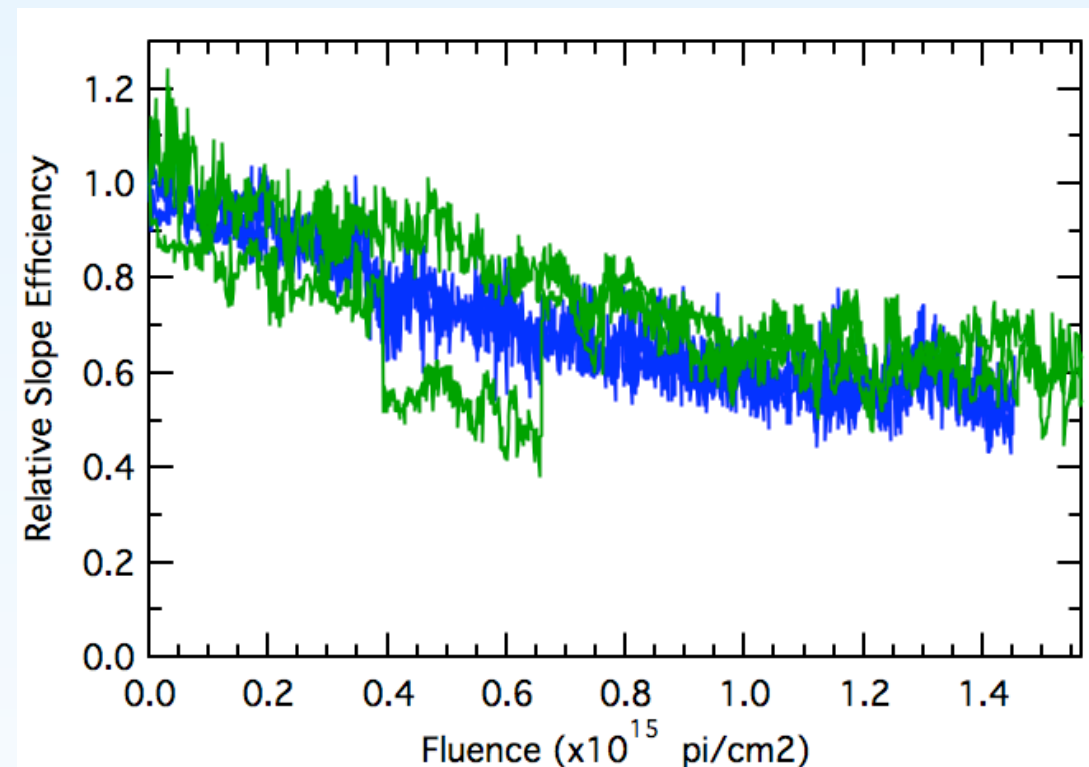

- Minimum Slope efficiency spec is 0.06 W/A
 - Min OMA is 300 μ W, require 5 mA modulation current out of 12 mA available from GBLD
 - 50% drop in slope efficiency can be fully compensated by increase in modulation current

Radiation penalties in Link Budget

Calorimeter Grade

	MM_VTx_Rx	MM_Tx_VRx	SM_VTx_Rx	SM_Tx_VRx
Min. Tx OMA	-5.2 dBm	-3.2 dBm	-5.2 dBm	-5.2 dBm
Max. Rx sensitivity	-11.1 dBm	-13.1 dBm	-12.6 dBm	-15.4 dBm
Power budget	5.9 dB	9.9 dB	7.4 dB	10.2 dB
Fiber attenuation	0.6 dB	0.6 dB	0.1 dB	0.1 dB
Insertion loss	1.5 dB	1.5 dB	2.0 dB	2.0 dB
Link penalties	1.0 dB	1.0 dB	1.5 dB	1.5 dB
Tx radiation penalty	0 dB	-	0 dB	-
Rx radiation penalty	-	-	-	-
Fiber radiation penalty	0.1 dB	0.1 dB	0 dB	0 dB
Margin				

Impact of PD Responsivity loss

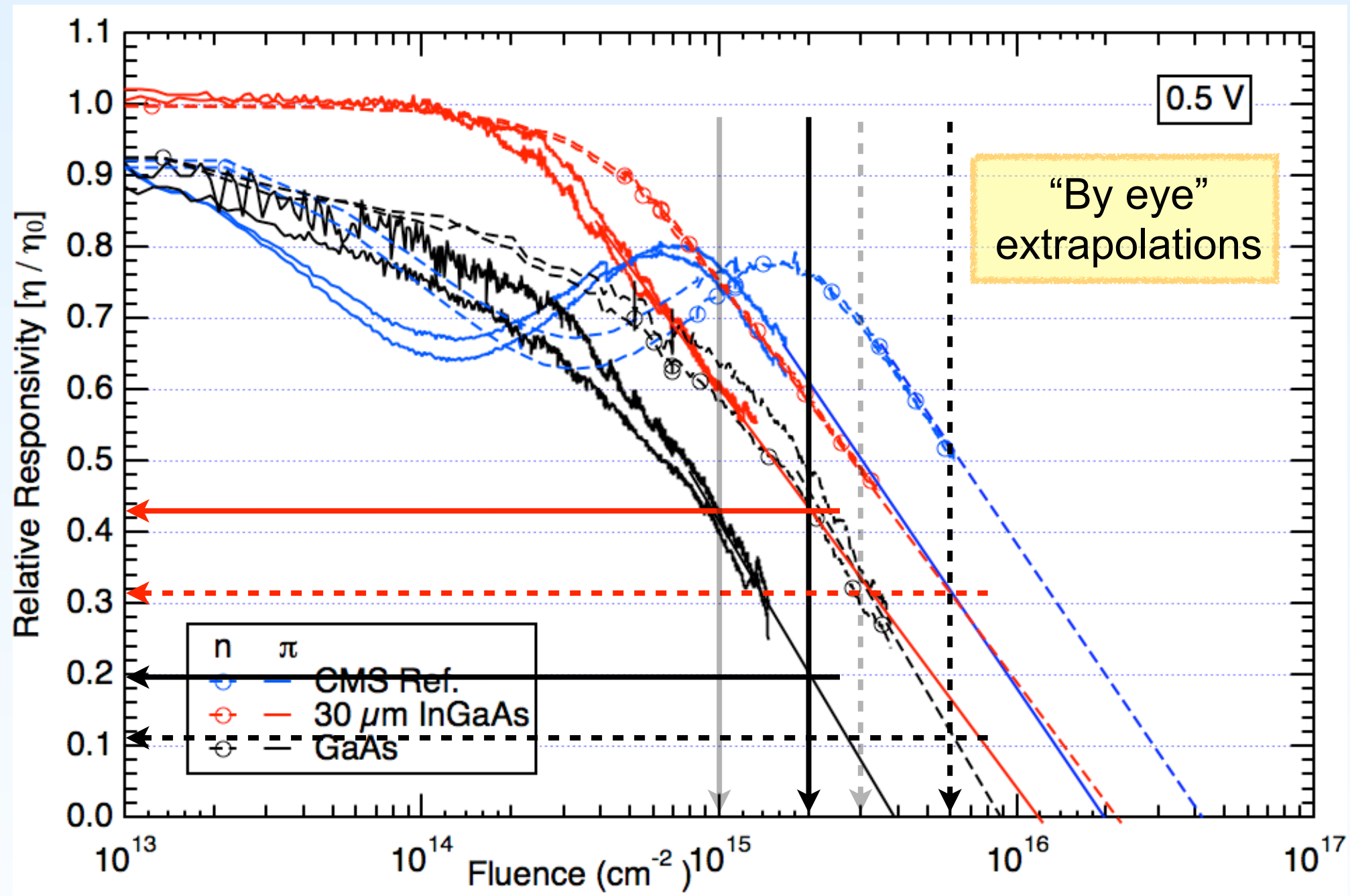

- Worst case at $6 \times 10^{15} \text{ cm}^{-2}$ neutron fluence
 - InGaAs penalty: -5.1 dB
 - GaAs penalty: -9.6 dB

Impact of PD Leakage Current

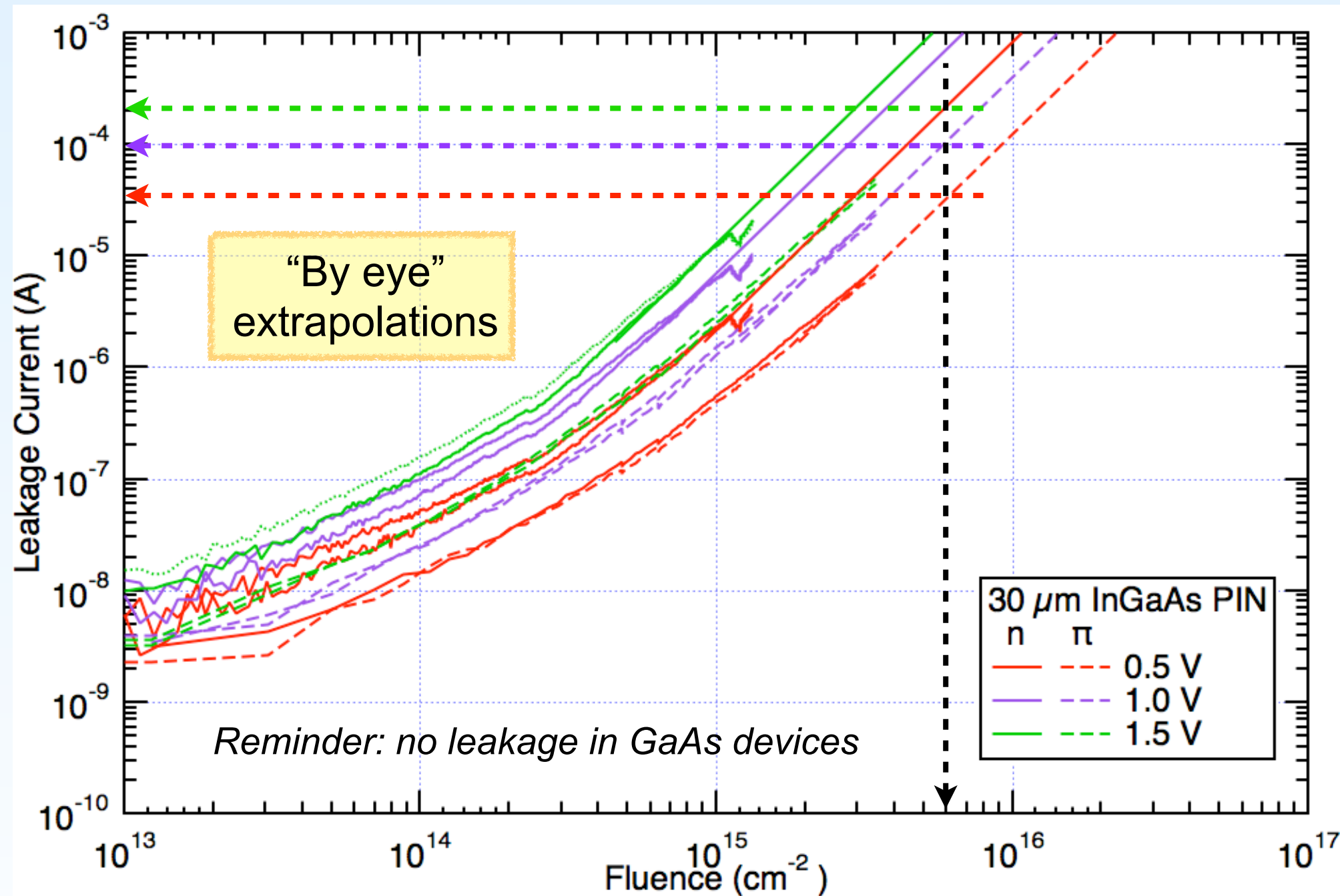

- Worst case at $6 \times 10^{15} \text{ cm}^{-2}$ neutron fluence
 - Around 100 μA leakage for 1.0V reverse bias (conservative GBTIA value)
 - 0.3 dB penalty from GBTIA DC current removal circuit

Radiation penalties in Link Budget

Calorimeter Grade

	MM_VTx_Rx	MM_Tx_VRx	SM_VTx_Rx	SM_Tx_VRx
Min. Tx OMA	-5.2 dBm	-3.2 dBm	-5.2 dBm	-5.2 dBm
Max. Rx sensitivity	-11.1 dBm	-13.1 dBm	-12.6 dBm	-15.4 dBm
Power budget	5.9 dB	9.9 dB	7.4 dB	10.2 dB
Fiber attenuation	0.6 dB	0.6 dB	0.1 dB	0.1 dB
Insertion loss	1.5 dB	1.5 dB	2.0 dB	2.0 dB
Link penalties	1.0 dB	1.0 dB	1.5 dB	1.5 dB
Tx radiation penalty	0 dB	-	0 dB	-
Rx radiation penalty	-	2.5 dB	-	2.5 dB
Fiber radiation penalty	0.1 dB	0.1 dB	0 dB	0 dB
Margin	2.7 dB	4.2 dB	3.8 dB	4.1 dB

Radiation penalties in Link Budget

Tracker Grade

	MM_VTx_Rx	MM_Tx_VRx	SM_VTx_Rx	SM_Tx_VRx
Min. Tx OMA	-5.2 dBm	-1.6 dBm	-5.2 dBm	-3.6 dBm
Max. Rx sensitivity	-11.1 dBm	-13.1 dBm	-12.6 dBm	-15.4 dBm
Power budget	5.9 dB	11.5 dB	7.4 dB	11.8 dB
Fiber attenuation	0.6 dB	0.6 dB	0.1 dB	0.1 dB
Insertion loss	1.5 dB	1.5 dB	2.0 dB	2.0 dB
Link penalties	1.0 dB	1.0 dB	1.5 dB	1.5 dB
Tx radiation penalty	0 dB	-	0 dB	-
Rx radiation penalty	-	5.4 dB	-	5.4 dB
Fiber radiation penalty	1.0 dB	1.0 dB	1.0 dB	1.0 dB
Margin	1.8 dB	2.0 dB	2.8 dB	1.8 dB

SEU mitigation with GBT protocol

- SEUs in the photodiode are unavoidable
 - GBT implements an interleaved Reed-Solomon Forward Error Correction (FEC) scheme to mitigate the induced errors

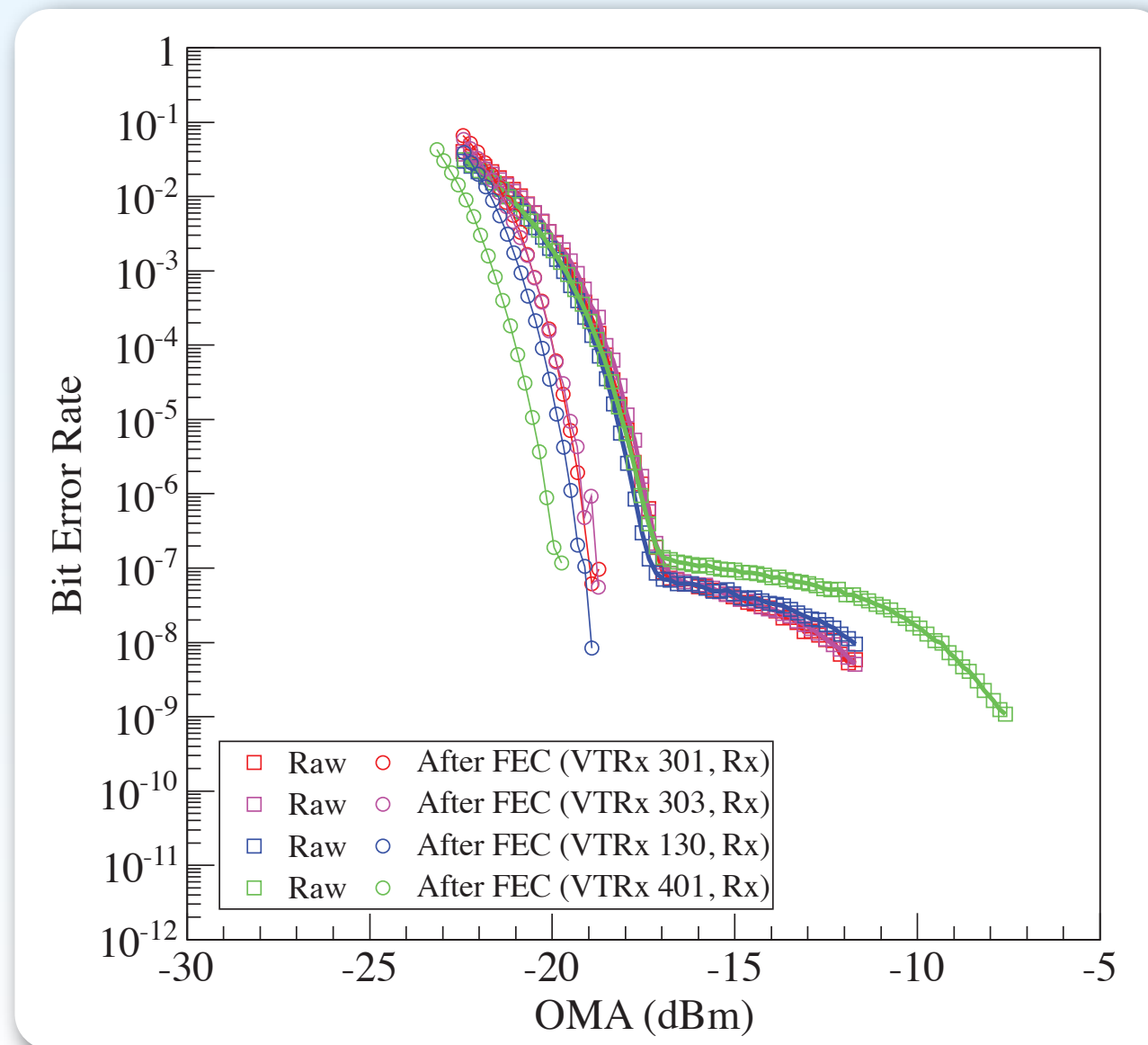

Final validation: VTRx in n-beam

- Final prototype VTRx (SM & MM) exposed to neutron beam at UC Louvain cyclotron facility in Nov. 2013
 - Complex test
 - VTRx in addition to lasers/pins
- Direct comparison between devices irradiated with DC measurements and AC measurements on VTRx
 - Large dataset still being evaluated
- Early results show devices on VTRx behave as expected from static testing

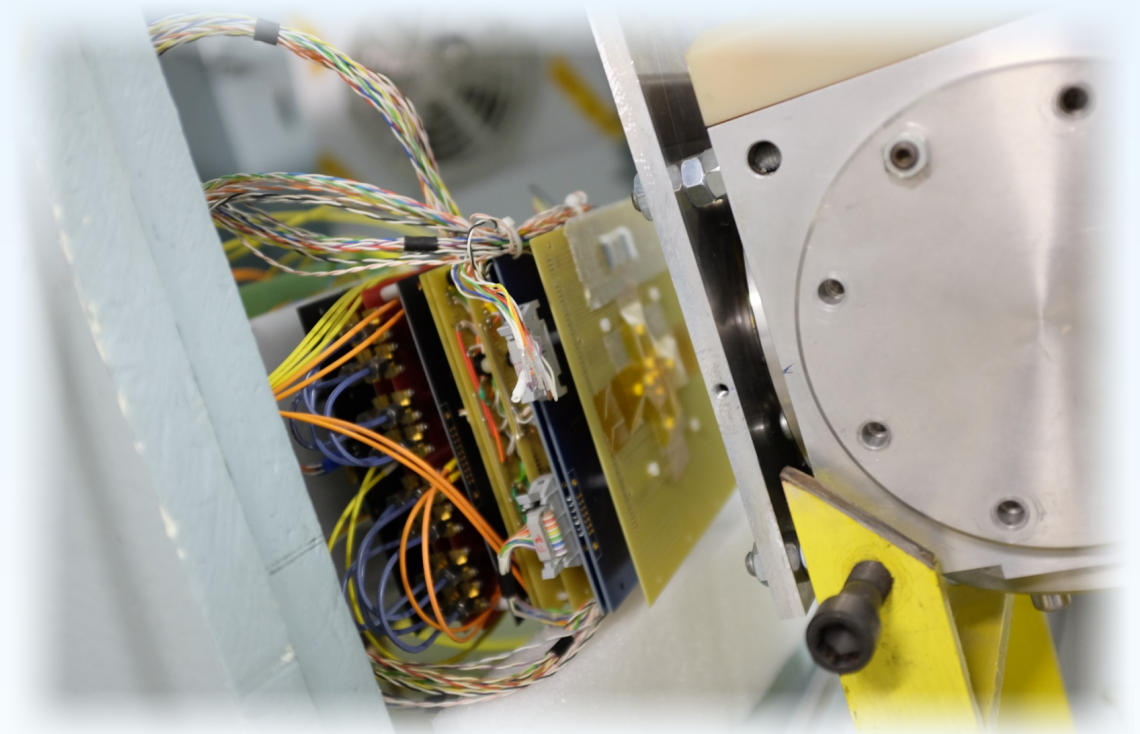

Final validation: VTRx in n-beam (2)

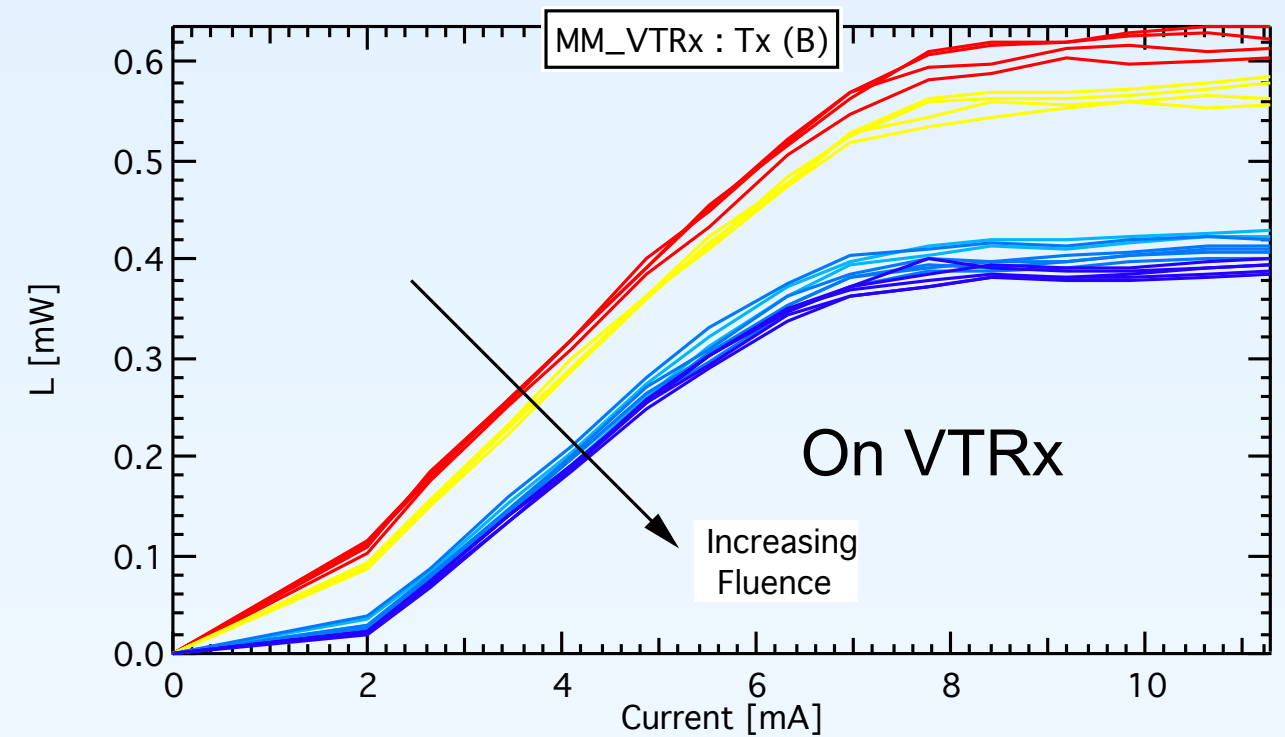
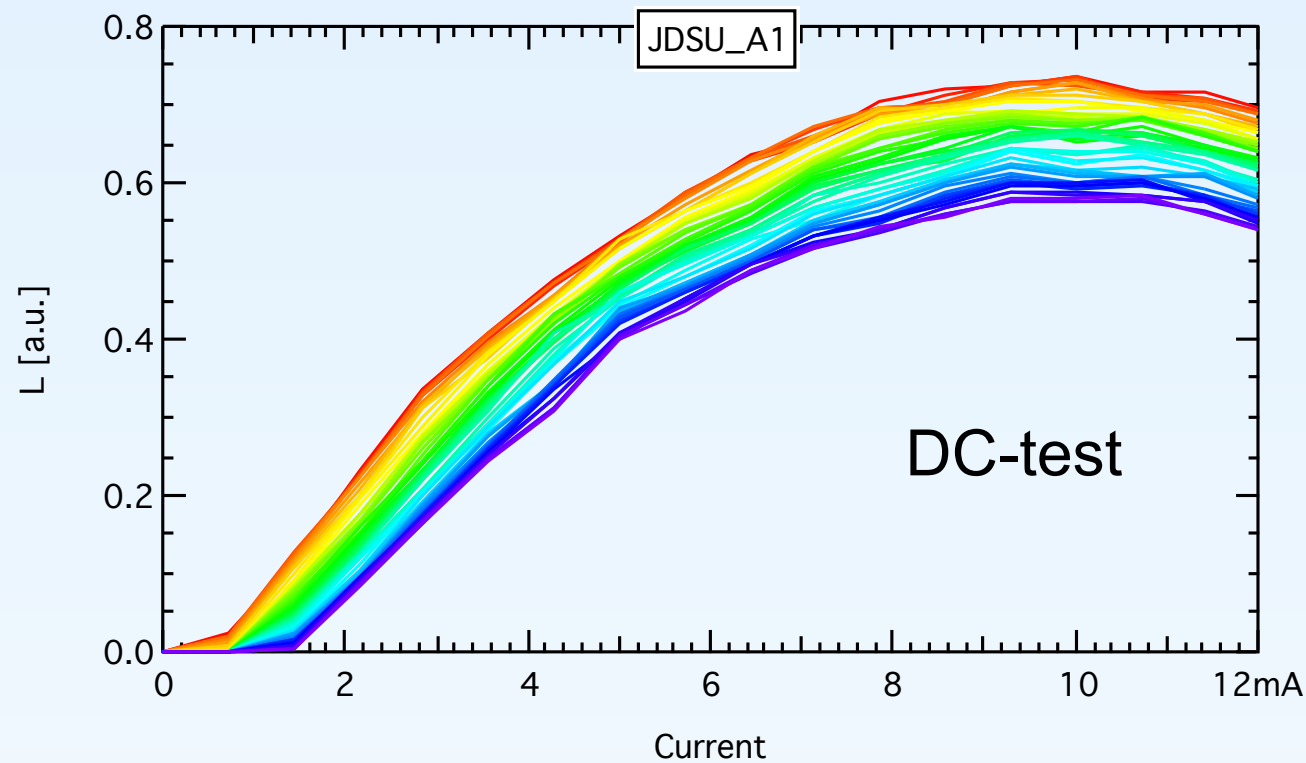

- Qualitatively similar results for intrinsic laser behaviour
- Also true for responsivity drop and leakage current increase in photodiodes
- Detailed analysis still ongoing

Final validation: VTRx in n-beam (3)

- Dynamic performance of lasers unchanged at 4.8 Gb/s

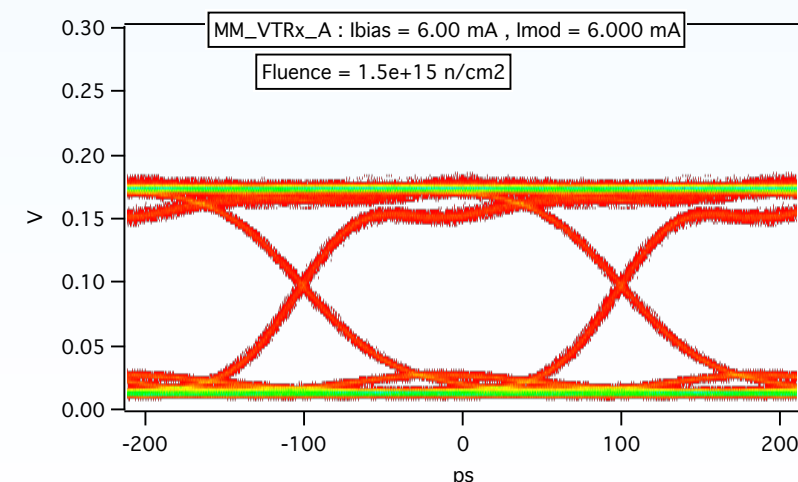
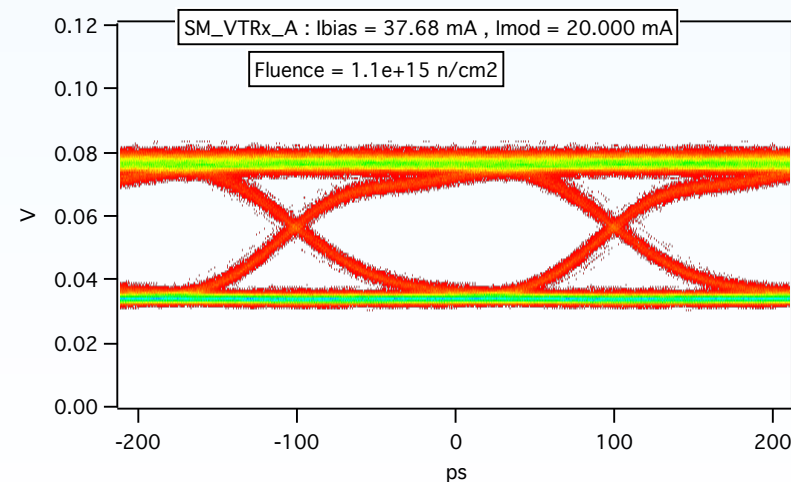
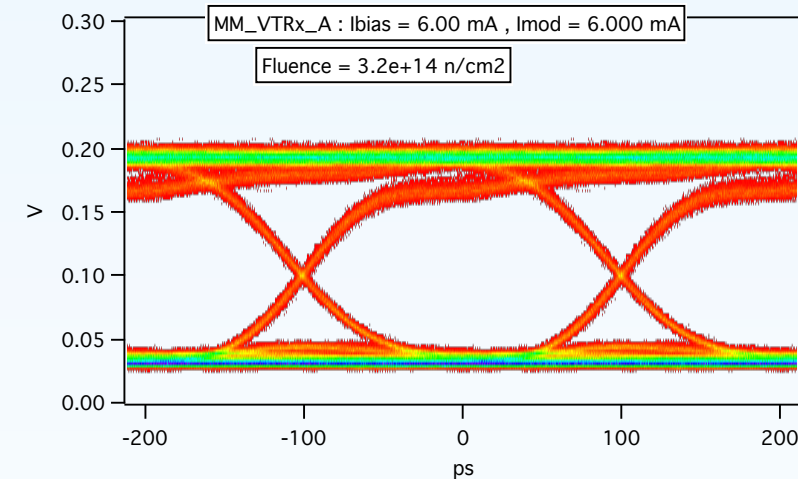
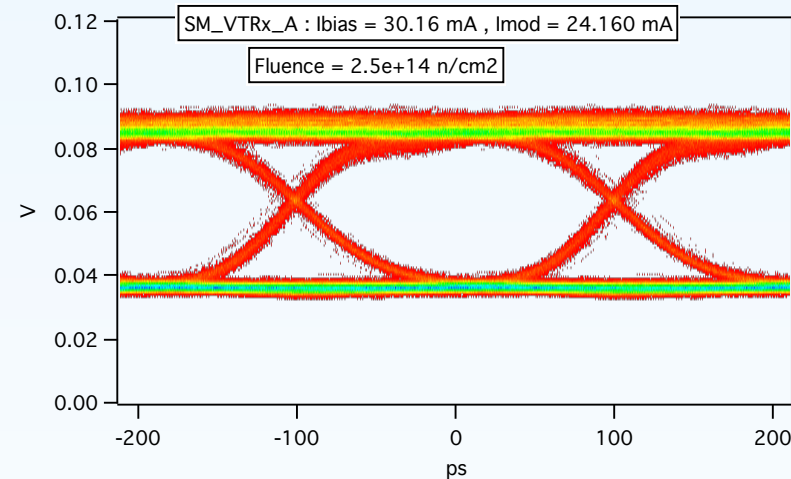
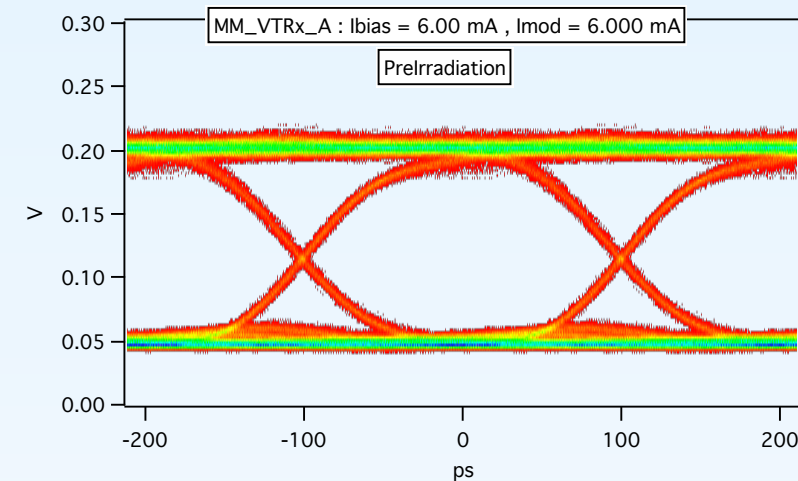
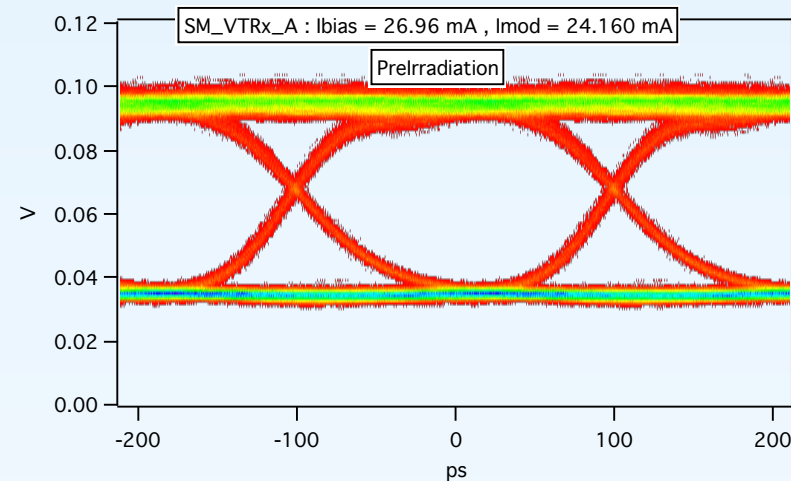

Final validation: VTRx in n-beam (4)

- Single-event upsets observed in GBLD registers
 - Not seen previously in proton testing at PSI
 - Flux in Louvain was 3×10^{10} n/cm²/s (two orders of magnitude higher than at PSI)
- Observed single bit errors in the control registers
 - Cross-section is 1.2×10^{-14} errors/n/cm²
- In a system of 10000 links operating at a luminosity of 10^{35} , this would be equivalent to
 - 1 error every 8 seconds at the level of the Trackers
 - 1 error every 14 minutes at the level of the Calorimeters
- Most likely due to the circuit topology of a reset line in the control registers
 - To be fixed in final submission (low-risk change)

Summary: VTRx/VTTx qualification

- Components selected and shown to be radiation tolerant
 - Gamma testing also carried out for verification, no significant effects observed
- Module design completed and performance verified
 - Including performance over operating temperature range 10-60 °C
 - Including magnetic field tolerance
- Final irradiation test of full module allows qualification for use in Calorimeter-level radiation fields

- Versatile Link Project
- Radiation effects assessment
- Survivability outlook for Phase 2 upgrades

Future prospects

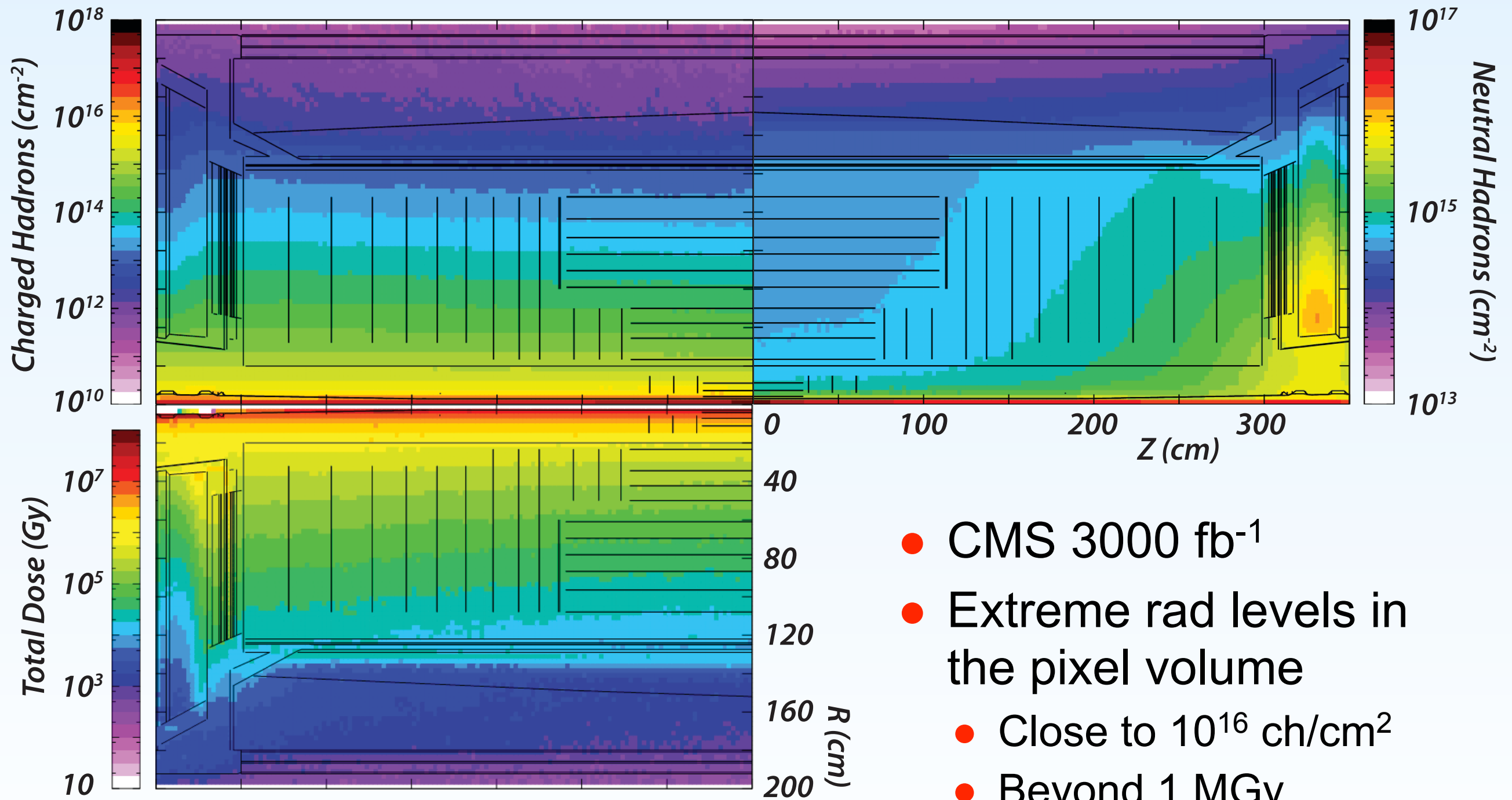

- CMS 3000 fb^{-1}
- Extreme rad levels in the pixel volume
 - Close to 10^{16} ch/cm^2
 - Beyond 1 MGy
 - Several 10^{15} n/cm^2

Beyond Tracker-Grade rad. tol.

- Have shown already that we have qualified the existing parts to Tracker levels for total dose/fluence
 - How much more would the o-e devices survive?
 - Can they be used in the Pixel detectors?
 - Can we find another more resistant technology?

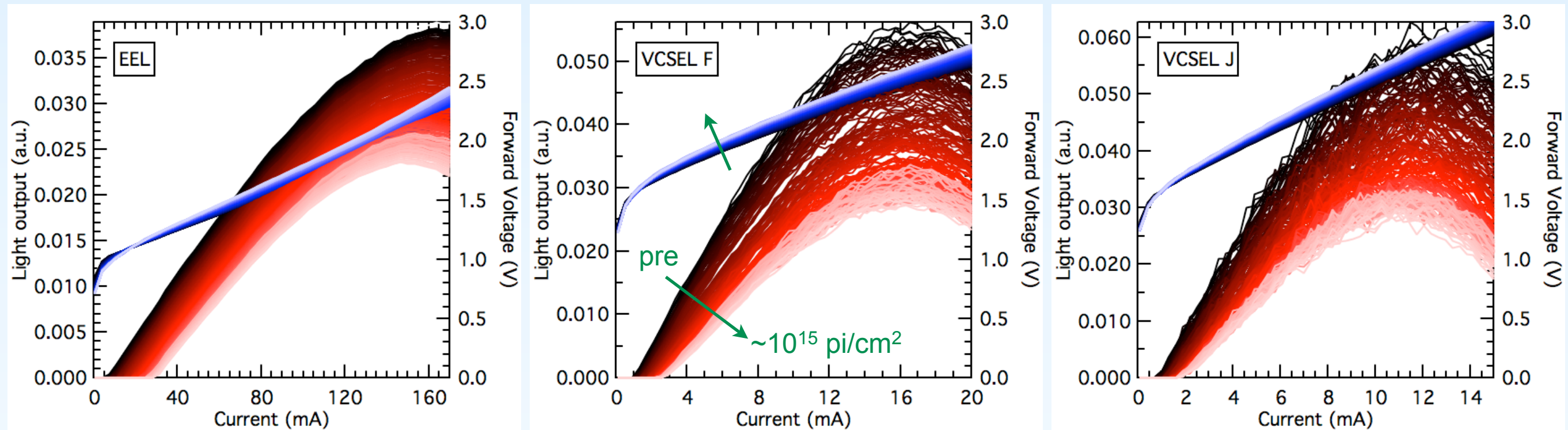

- By eye, might assume lasers could survive “a few” $10^{15} /\text{cm}^2$
 - Need to be able to track threshold changes
 - Deal with output amplitude degradation in link budget
- Annealing helps a bit
 - Gain a factor of two in reduction of damage at SLHC fluxes

Impact of PD Responsivity loss

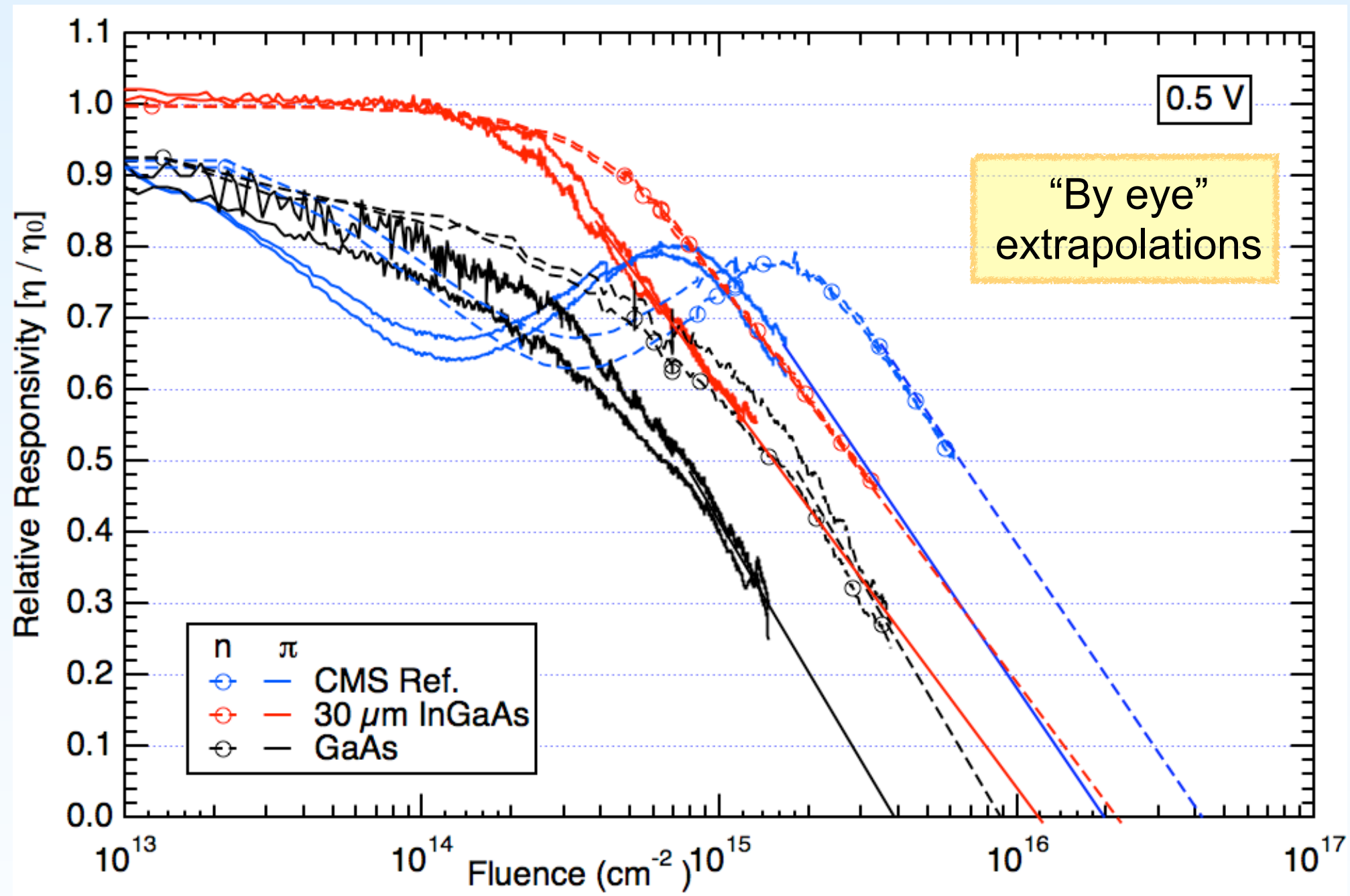

- GaAs non-functional after around 4×10^{15} pi/cm²
- InGaAs non-functional after around 10^{16} pi/cm²
- No annealing

Little safety margin!

Impact of PD Leakage Current

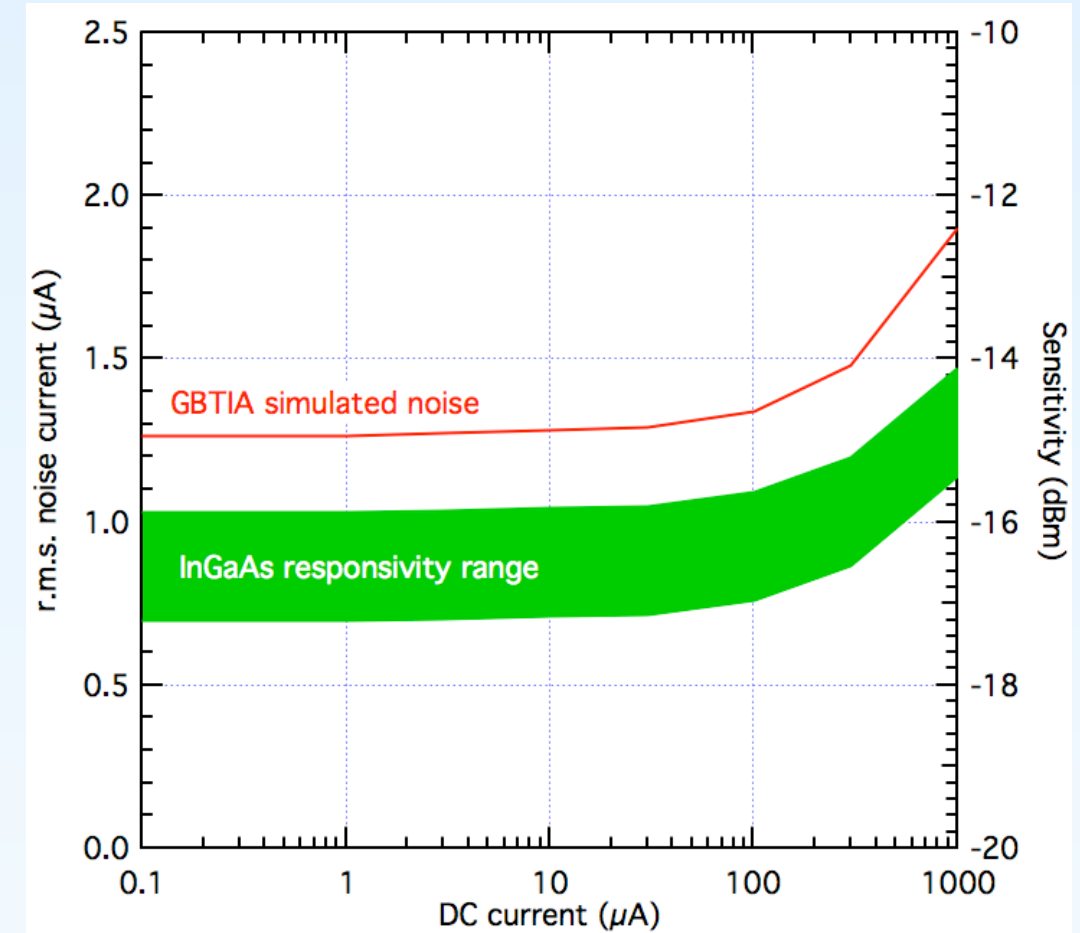
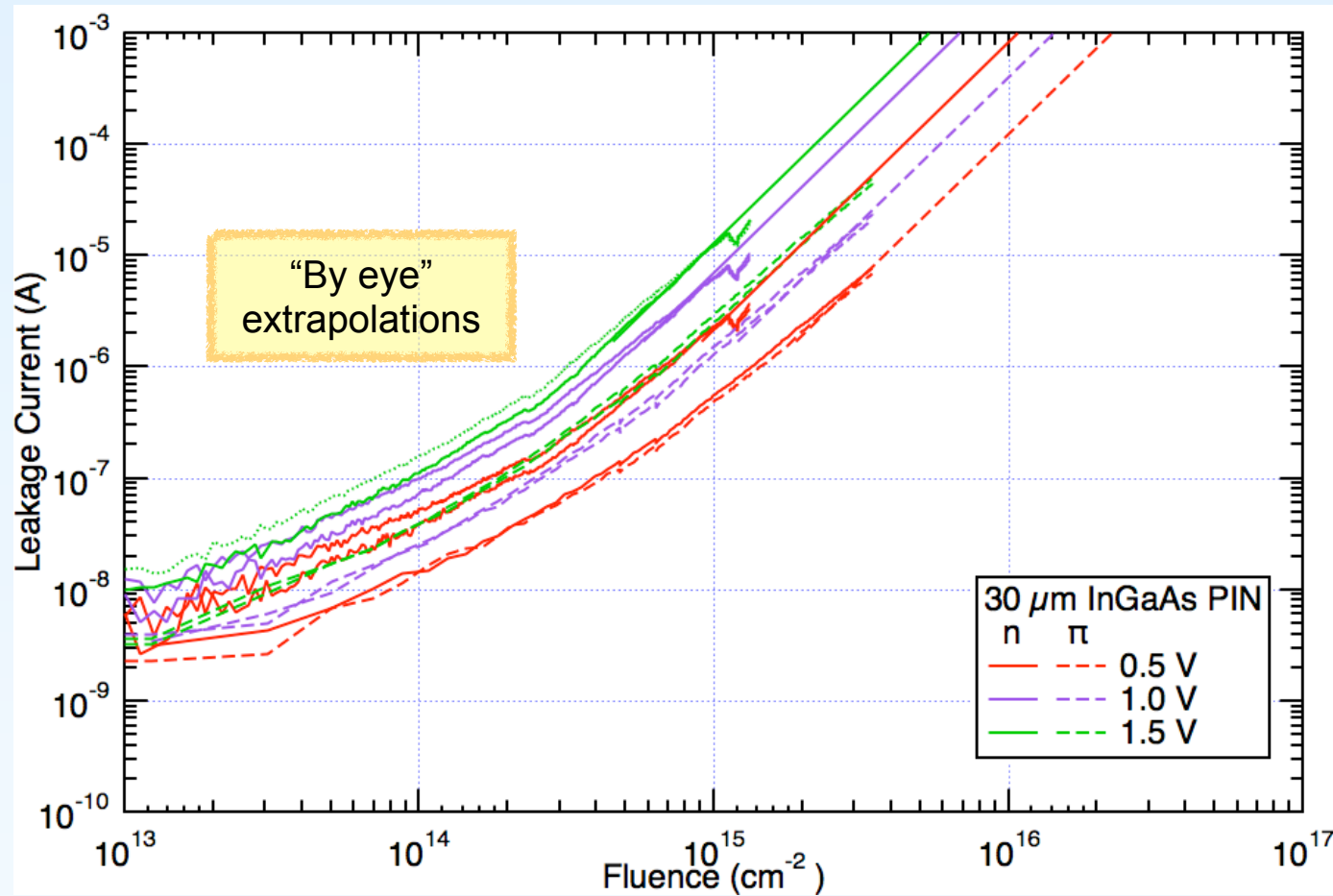

Reminder: no leakage in GaAs devices

- 1 mA leakage current adds 1.7 dB sensitivity penalty
- Not clear that removal of DC-current is possible beyond this?

- Have investigated optical modulators again (c.f. RD23)
- First came InP-based Reflective ElectroAbsorption Modulators (REAMs)
 - Similar structure to a PIN photodiode with quantum wells to be able to tune absorption edge

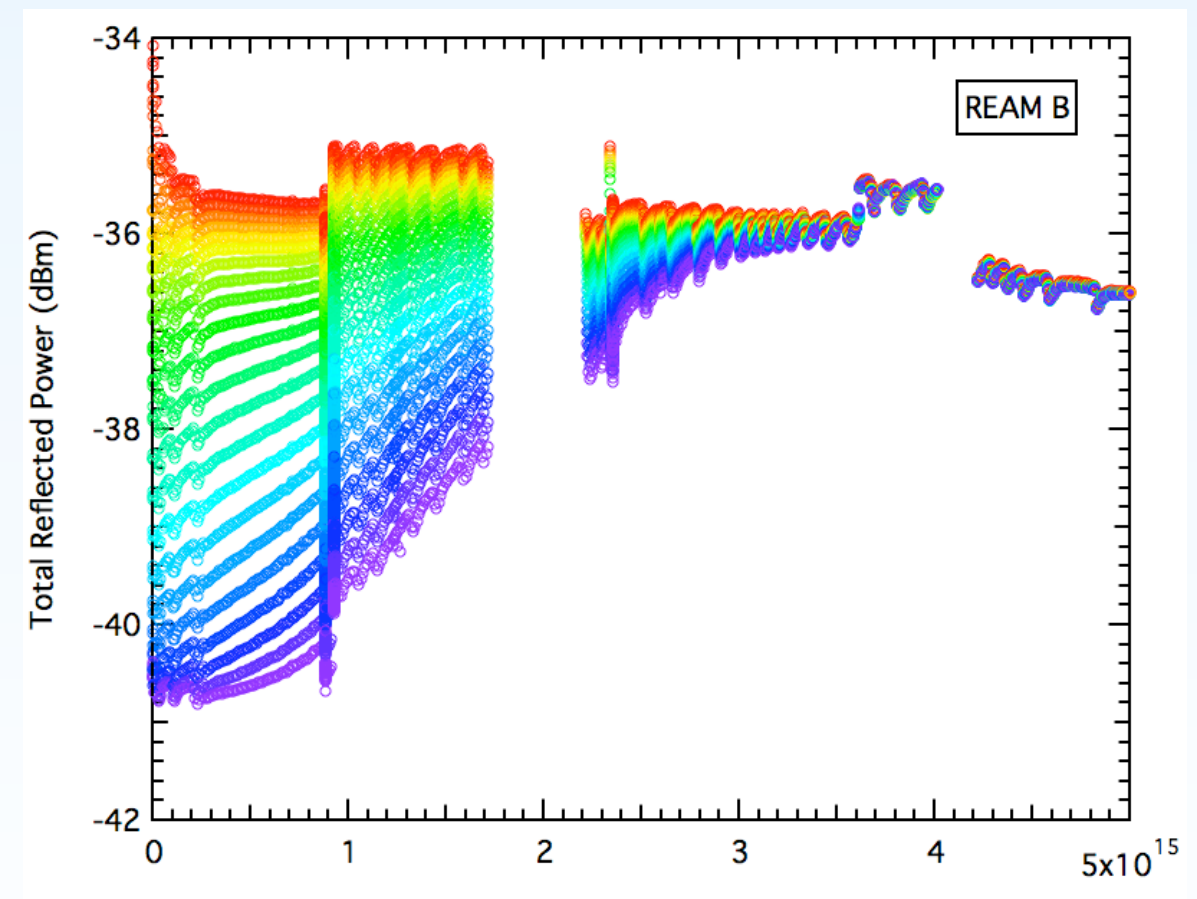
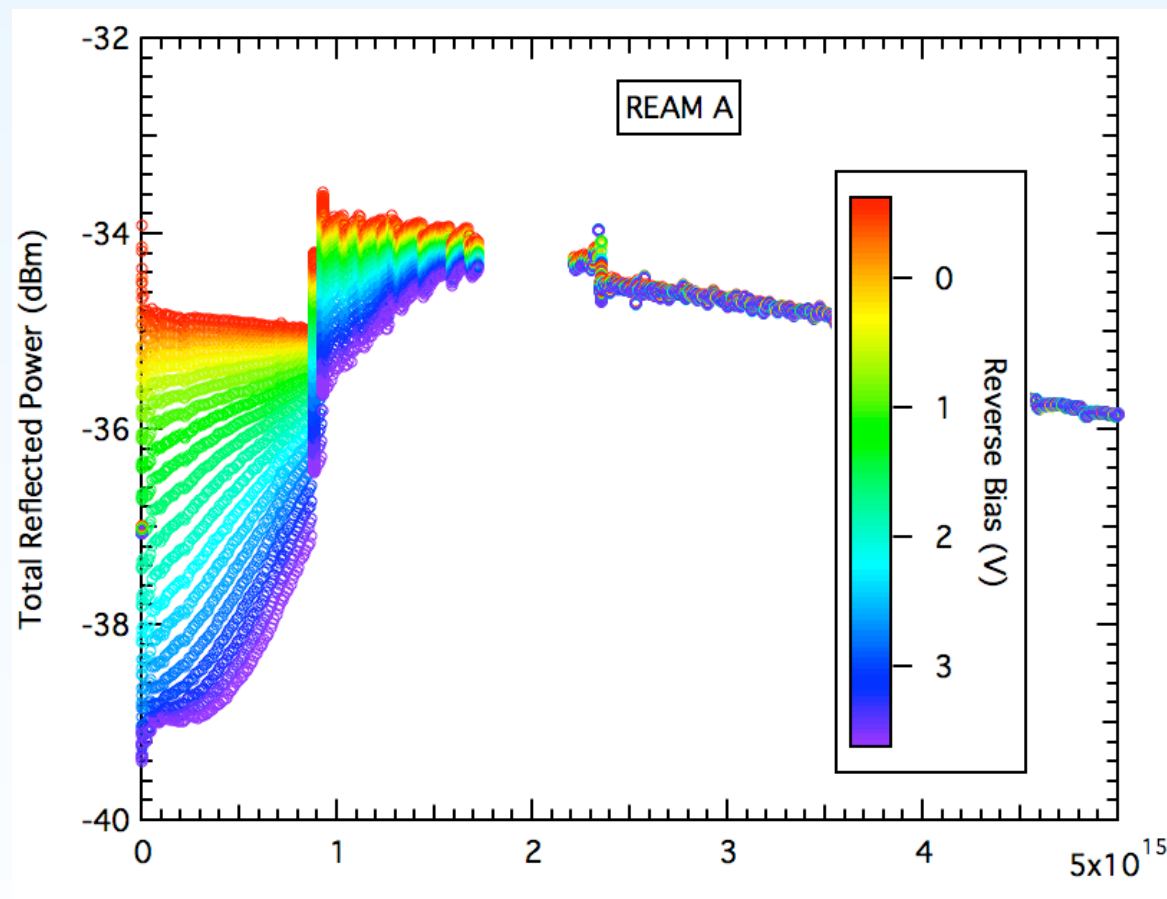

- Devices non-functional after few 10^{15} 24 GeV p/cm²

- Presently much interest in the telecom and datacom industry in silicon photonics
 - We are currently investigation the suitability of this technology for particle physics instrumentation
- First irradiations of silicon photonics samples have been carried out
 - Early indications are that the technology can survive up to fluences of 10^{15} cm^{-2}
 - Plan to go to higher fluences this year

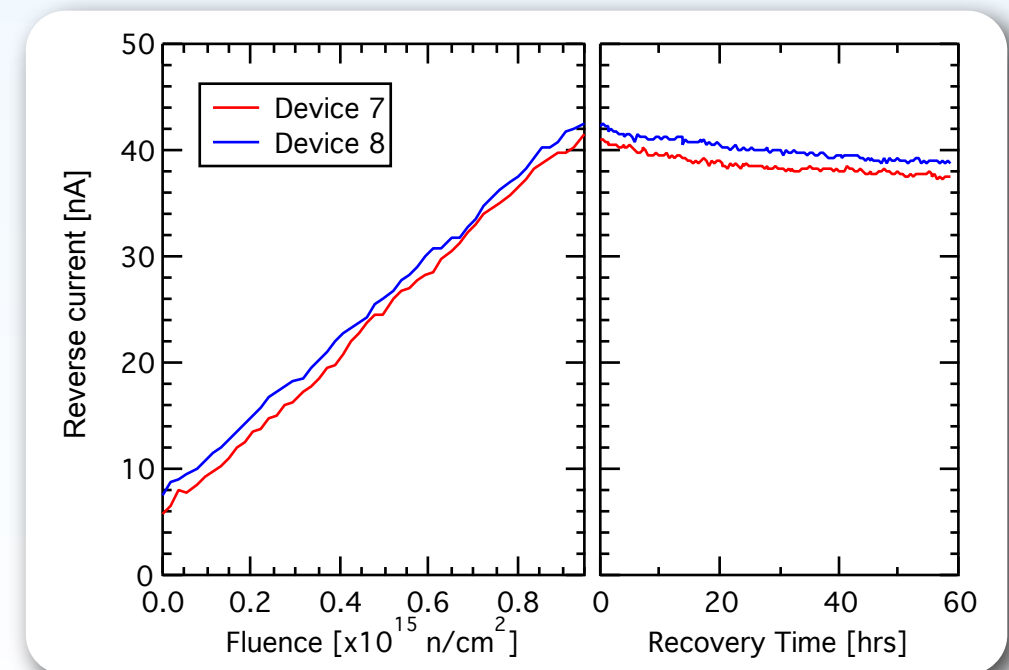
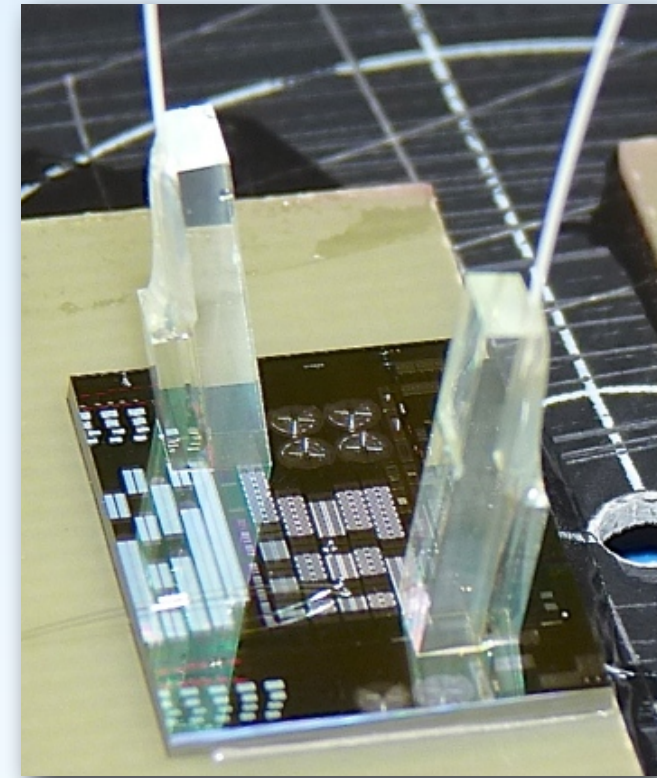

- We have qualified candidate components for the upcoming production of Versatile Link front-end modules
 - Will also verify wafer-wafer variations on production quantity
- Have measured the performance/degradation of a full module during neutron irradiation
 - O-E components behaved as expected, high-speed operation verified in-beam for the first time
 - SEU issue found with GBLD, to be fixed
- Investigating new technologies to be able to survive innermost regions of HL-LHC Phase 2 upgrades