

Muon Accelerators for the Next Generation of High Energy Physics Experiments

Mark A. Palmer

Director, U.S. Muon Accelerator Program

Sep 26, 2013



The Aims of the U.S. Muon Accelerator Program



Muon accelerator R&D is focused on developing a facility that can address critical questions spanning two frontiers...

The Intensity Frontier:

with a **Neutrino Factory** producing well-characterized ν beams for precise, high sensitivity studies



The Energy Frontier:

with a **Muon Collider** capable of reaching multi-TeV CoM energies
and
a **Higgs Factory** on the border between these Frontiers

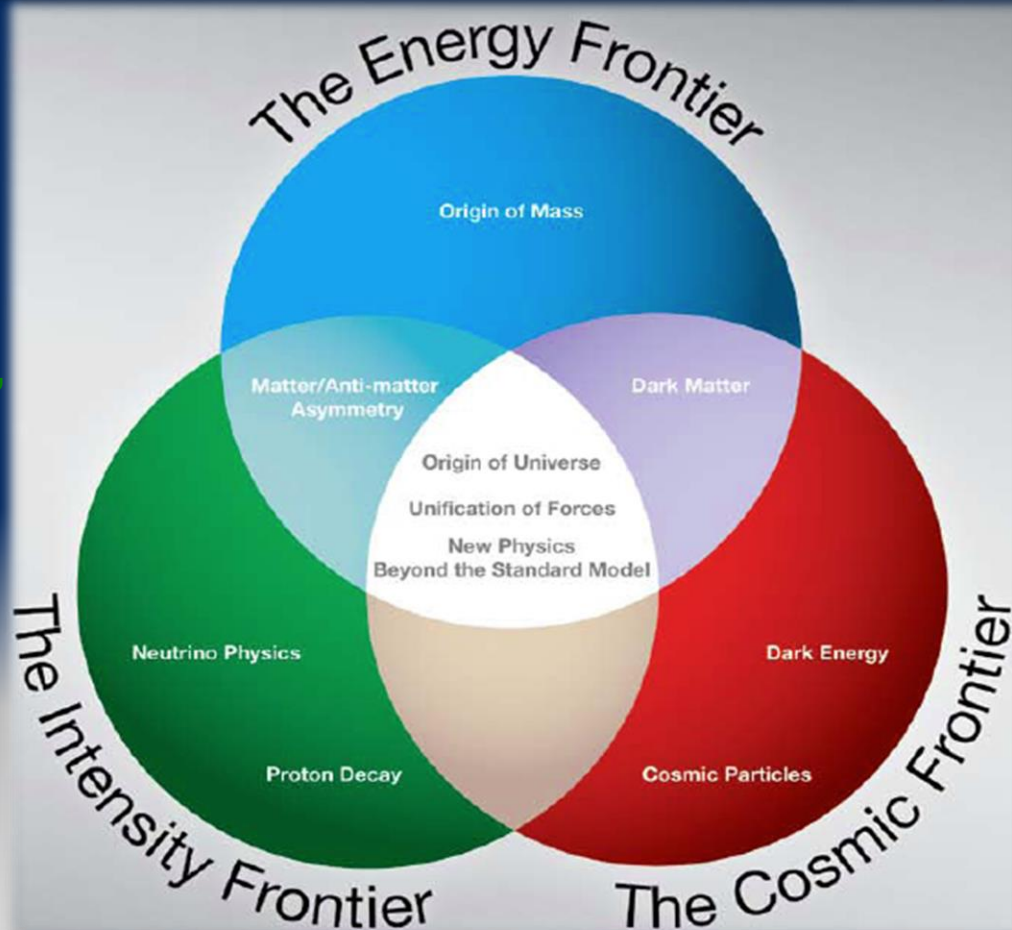

The unique potential of a facility based on muon accelerators is physics reach that SPANS 2 FRONTIERS

Outline



- Physics Motivations for a Neutrino Factory and Muon Collider
- Muon Collider and Neutrino Factory Synergies
- R&D Challenges and the MAP Feasibility Assessment
- Concluding Remarks



THE PHYSICS MOTIVATIONS

The Physics Motivations



- Physics potential for the HEP community using muon beams
 - Tests of Lepton Flavor Violation
 - Anomalous magnetic moment \Leftrightarrow hints of new physics (g-2)

- Can provide equal fractions of electron and muon neutrinos at high intensity for studies of neutrino oscillations – the Neutrino Factory concept

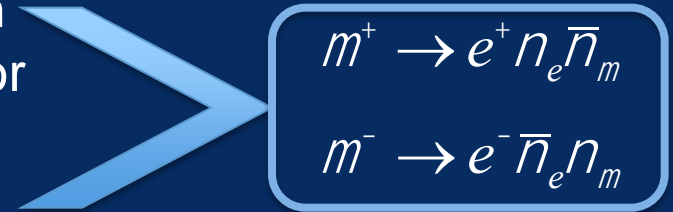

- Offers a large coupling to the “Higgs mechanism” $\sim \left(\frac{m_\mu^2}{m_e^2} \right) \cong 4 \times 10^4$
- As with an e^+e^- collider, a $\mu^+\mu^-$ collider would offer a precision probe of fundamental interactions – in contrast to hadron colliders

The Physics Needs: Neutrinos (I)

- In the neutrino sector it is critical to understand:

- δ_{CP}

- The mass hierarchy

- $\theta_{23} = \pi/4$, $\theta_{23} < \pi/4$
or $\theta_{23} > \pi/4$

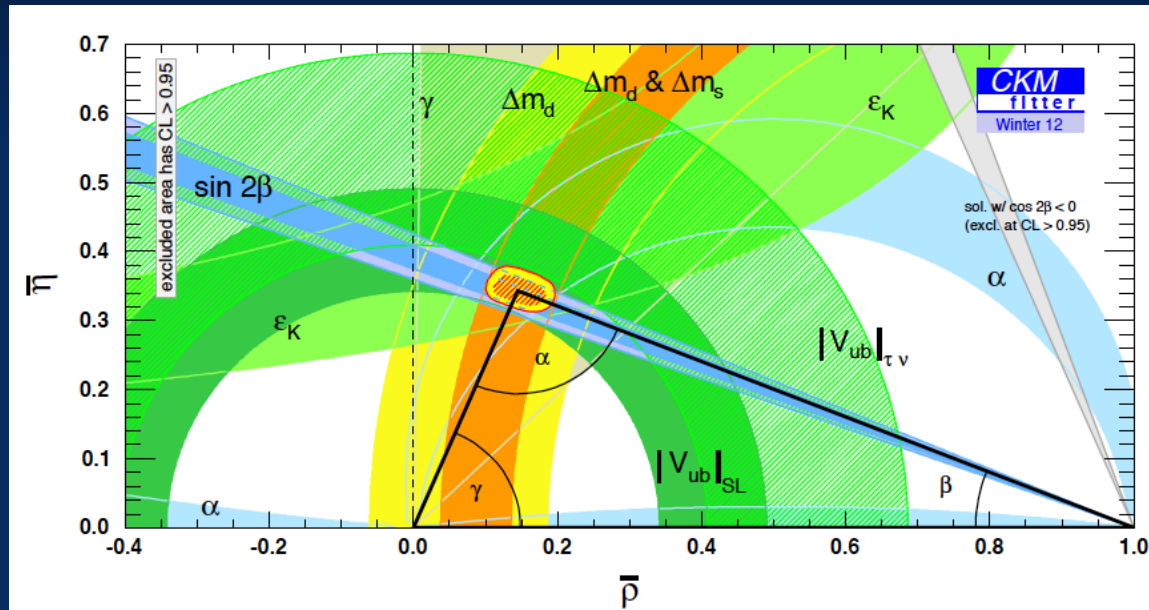

- Resolve the LSND and other short baseline experimental anomalies [perhaps using beams from a muon storage ring (**ν STORM**) in a short baseline experiment]

- And continue to probe for signs new physics

P. Huber

The Physics Needs: Neutrinos (II)

- CP violation physics reach of various facilities

Can we probe the CP violation in the neutrino sector at the same level as in the CKM Matrix?

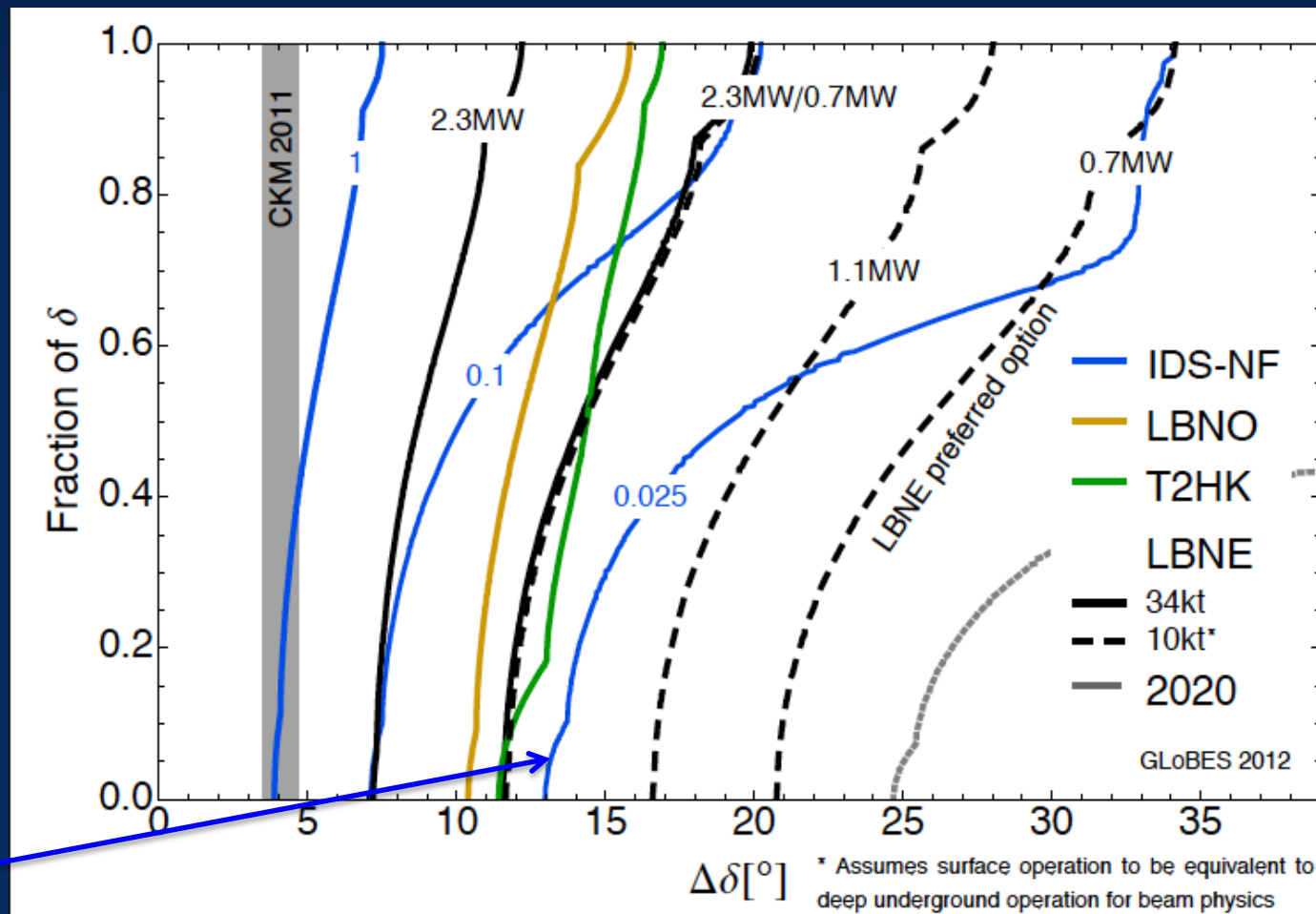

0.025 IDS-NF:
700kW target,
no cooling,
 2×10^8 s running time
10-15 kTon detector

P. Coloma, P. Huber, J. Kopp, W. Winter – article in preparation

The Physics Needs: Colliders

$\mu^+\mu^-$ Collider:

- Center of Mass energy: 1.5 - 6 TeV (3 TeV)
- Luminosity $> 10^{34} \text{ cm}^{-2} \text{ sec}^{-1}$ (350 fb⁻¹/yr)
- Compact facility
 - 3 TeV - ring circumference 3.8 km
 - 2 Detectors
- Superb Energy Resolution

Muon Collider Conceptual Layout

Project X
Accelerate hydrogen ions to 8 GeV using SRF technology.

Compressor Ring
Reduce size of beam.

Target
Collisions lead to muons with energy of about 200 MeV.

Muon Capture and Cooling
Capture, bunch and cool muons to create a tight beam.

Initial Acceleration
In a dozen turns, accelerate muons to 20 GeV.

Recirculating Linear Accelerator
In a number of turns, accelerate muons up to 2 TeV using SRF technology.

Collider Ring
Bring positive and negative muons into collision at two locations 100 meters underground.



E. Eichten

- MC: 95% luminosity in $dE/E \sim 0.1\%$
- CLIC: 35% luminosity in $dE/E \sim 1\%$

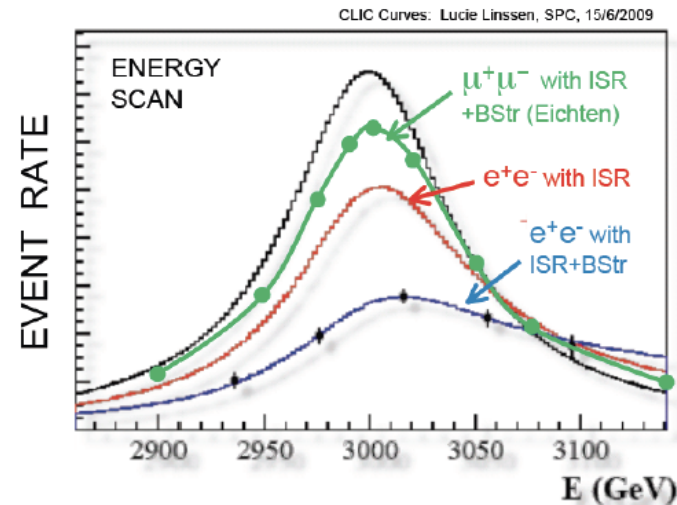
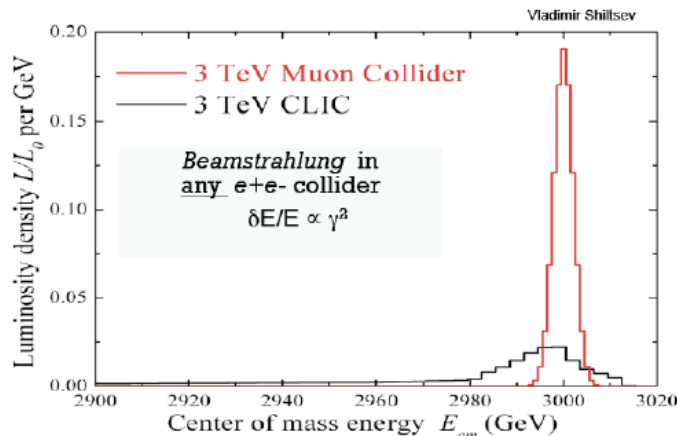

Muon Collider Reach

- For $\sqrt{s} < 500 \text{ GeV}$
 - SM thresholds: $Z^0h, W^+W^-, \text{top pairs}$
 - Higgs factory ($\sqrt{s} \approx 126 \text{ GeV}$) ✓
- For $\sqrt{s} > 500 \text{ GeV}$
 - Sensitive to possible Beyond SM physics.
 - High luminosity required. ✓
 - Cross sections for central ($|\theta| > 10^\circ$) pair production $\sim R \times 86.8 \text{ fb/s (in TeV}^2)$ ($R \approx 1$)
 - At $\sqrt{s} = 3 \text{ TeV}$ for $100 \text{ fb}^{-1} \sim 1000 \text{ events/(unit of R)}$
- For $\sqrt{s} > 1 \text{ TeV}$
 - Fusion processes important at multi-TeV MC

$$\sigma(s) = C \ln\left(\frac{s}{M_X^2}\right) + \dots$$

An Electroweak Boson Collider ✓

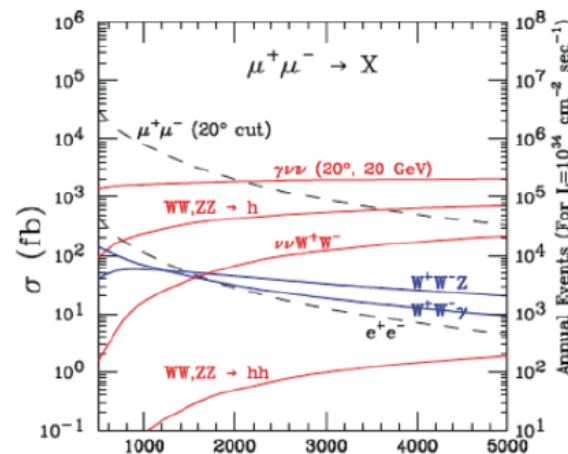
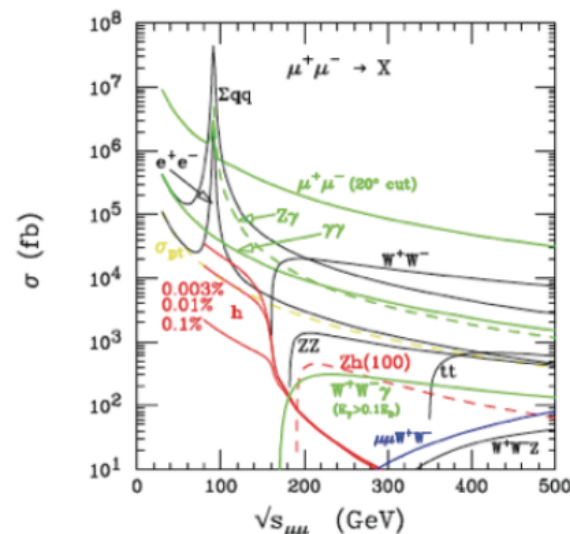
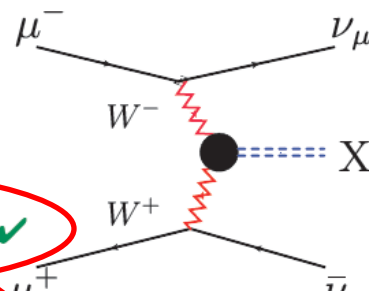

E. Eichten

A 10 TeV $\mu^+\mu^-$ collider has similar discovery reach as a 100 TeV pp machine!

Challenges for a $\mu^+\mu^-$ Collider

- Create pions from a MW-scale proton beam striking a target
- To avoid excessive power requirements, must efficiently capture the produced pions
 - Capture of both forward and backward produced pions loses polarization
- The phase space of the created pions is ***very large!***
 - Transverse: 20π mm-rad
 - Longitudinal: 2π m-rad
- Emittances must be cooled by factors of 10^6 - 10^7 to be suitable for multi-TeV collider operation
 - ~1000x in the transverse dimensions
 - ~40x in the longitudinal dimension
- The muon lifetime is 2.2 μ s lifetime at rest

Cooling Options

- Electron/Positron cooling: use synchrotron radiation
 - ⇒ For muons $\Delta E \sim 1/m^3$ (*too small!*)
- Proton Cooling: use
 - A co-moving cold e- beam
 - ⇒ For muons this is too slow
 - Stochastic cooling
 - ⇒ For muons this is also too slow
- Muon Cooling: use
 - Ionization Cooling
 - ⇒ Likely the only viable option!
 - Optical stochastic cooling
 - ⇒ Maybe, but far from clear

Muon Collider Concept

Muon Collider Block Diagram

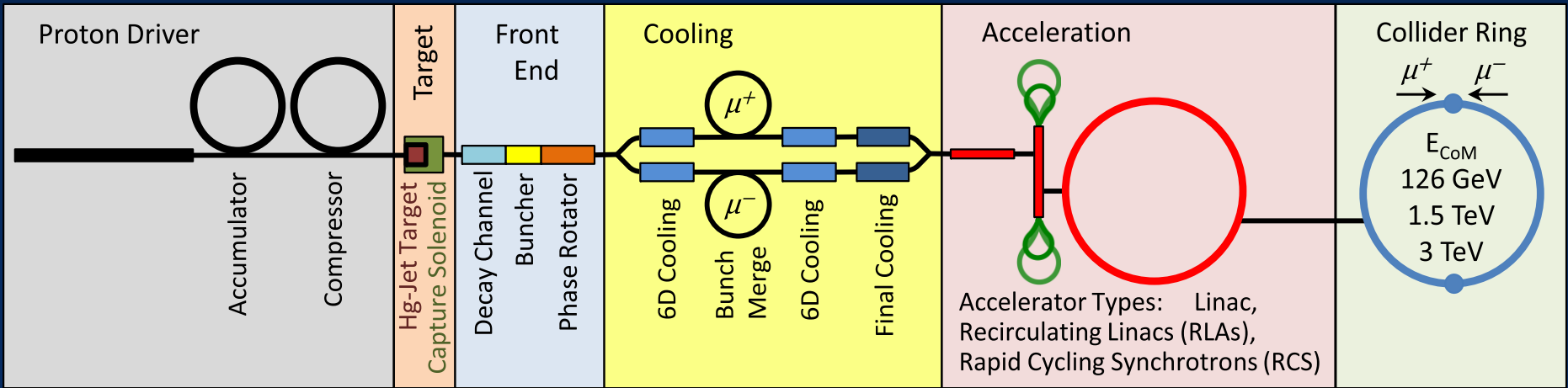

Proton source:
For example PROJECT X
at 4 MW, with 2 ± 1 ns long
bunches

Goal:
Produce a high intensity
 μ beam whose 6D phase
space is reduced by a
factor of $\sim 10^6$ from its
value at the production
target

Collider: $\sqrt{s} = 3$ TeV
Circumference 4.5km
 $L = 3 \times 10^{34} \text{ cm}^{-2}\text{s}^{-1}$
 $\mu/\text{bunch} = 2 \times 10^{12}$
 $\sigma(p)/p = 0.1\%$
 $\epsilon_{\perp N} = 25 \text{ } \mu\text{m}$, $\epsilon_{\parallel N} = 72 \text{ mm}$
 $\beta^* = 5\text{mm}$
Rep. Rate = 12 Hz



MUON COLLIDER AND NEUTRINO FACTORY SYNERGIES

The U.S. Muon Accelerator Program



Neutrino Factory

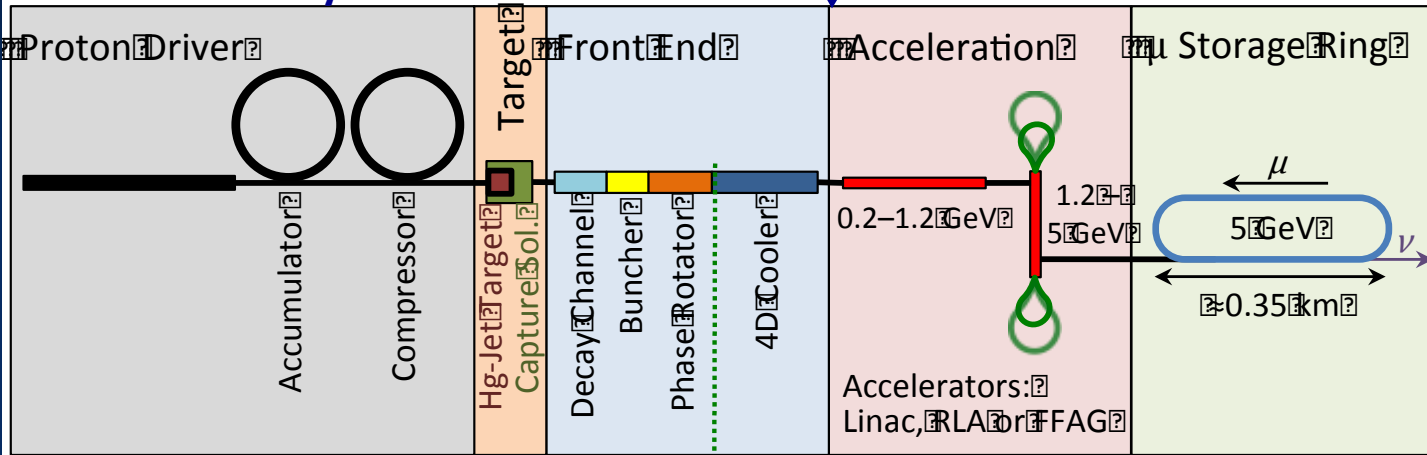

Share same complex

Muon Collider

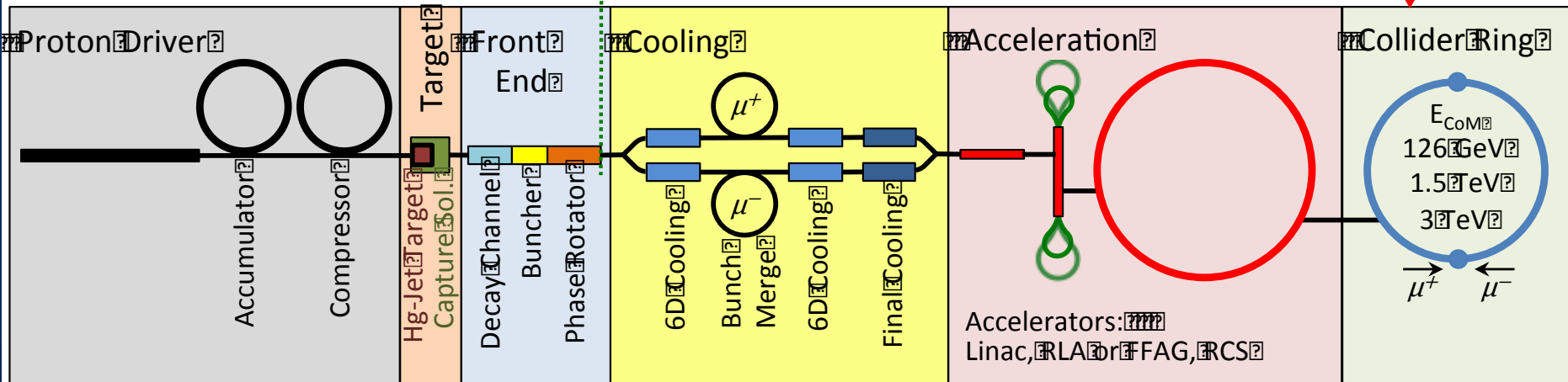

A Staged Muon-Based Neutrino and Collider Physics Program



The plan is conceived in four stages, whose exact order remains to be worked out:

- The “entry point” for the plan is the ν STORM facility proposed at Fermilab, which can advance short-baseline physics by making definitive observations or exclusions of sterile neutrinos. Secondly, it can make key measurements to reduce systematic uncertainties in long-baseline neutrino experiments. Finally, it can serve as an R&D platform for demonstration of accelerator capabilities pre-requisite to the later stages.
- A stored-muon-beam Neutrino Factory can take advantage of the large value of θ_{13} recently measured in reactor-antineutrino experiments to make definitive measurements of neutrino oscillations and their possible violation of CP symmetry.
- Thanks to suppression of radiative effects by the muon mass and the m_{lepton}^2 proportionality of the s -channel Higgs coupling, a “Higgs Factory” Muon Collider can make uniquely precise measurements of the 126 GeV boson recently discovered at the LHC.
- An energy-frontier Muon Collider can perform unique measurements of Terascale physics, offering both precision and discovery reach.

An entry-level NF?

DOES NOT
Require the
Development of
ANY
New Technology

A.Bross
NuFACT12

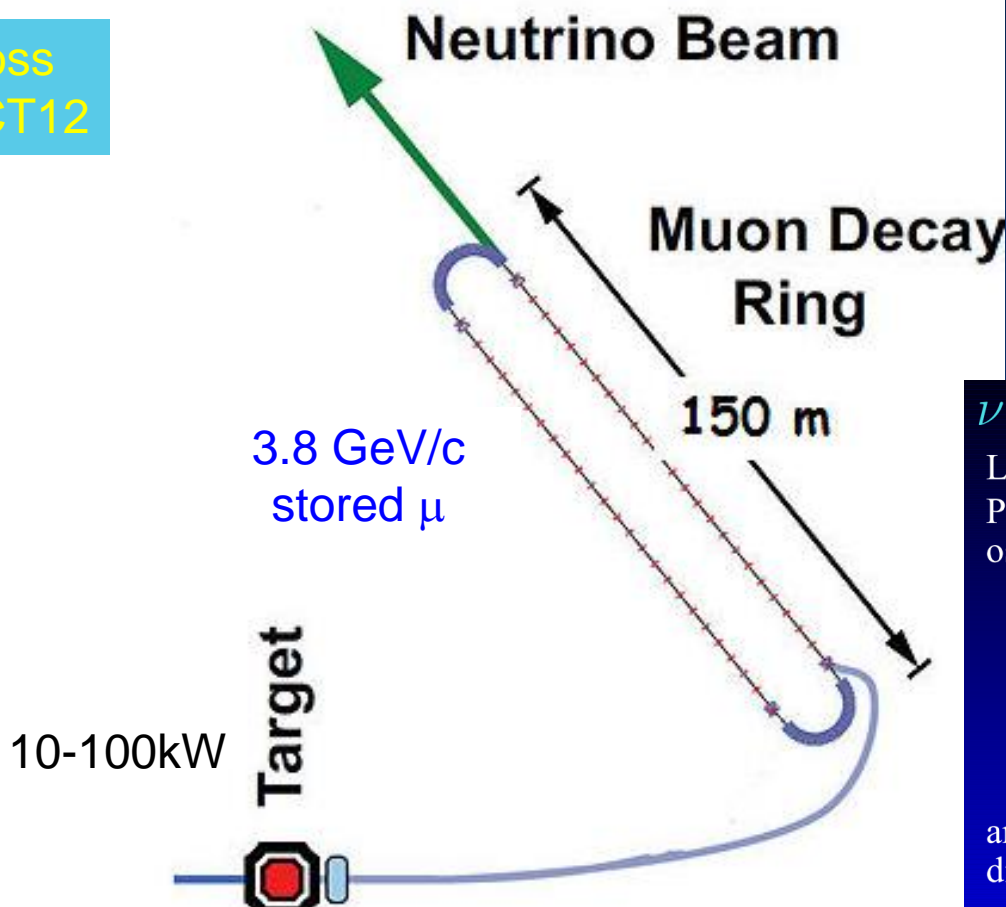

ν STORM

Low energy, low luminosity muon storage ring.
Provides with $1.7 \times 10^{18} \mu^+$ stored, the following
oscillated event numbers

$\nu_e \rightarrow \nu_\mu$ CC	330
$\bar{\nu}_\mu \rightarrow \bar{\nu}_\mu$ NC	47000
$\nu_e \rightarrow \nu_e$ NC	74000
$\bar{\nu}_\mu \rightarrow \bar{\nu}_\mu$ CC	122000
$\nu_e \rightarrow \nu_e$ CC	217000

and each of these channels has a more than 10σ
difference from no oscillations

With more than 200 000 ν_e CC events a %-level ν_e
cross section measurement should be possible

nuStorm Proposal: <http://arxiv.org/abs/1308.6822>

ν Storm as an R&D Platform

- A high-intensity pulsed muon source
- $100 < p_{\mu} < 300$ MeV/c muons
 - Using extracted beam from ring
 - 10^{10} muons per 1 μ sec pulse
- Beam available simultaneously with physics operation
 - Sterile ν search
 - ν cross section measurements needed for ultimate precision in long baseline measurements
- ν STORM also provides the opportunity to design, build and test decay ring instrumentation (BCT, momentum spectrometer, polarimeter) to measure and characterize the circulating muon flux.

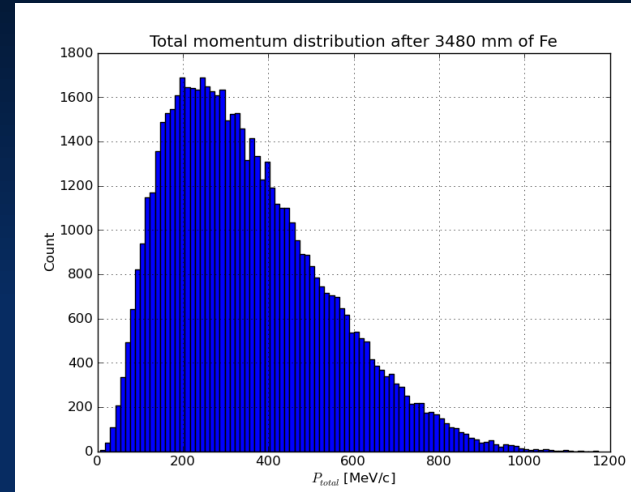

IDS-NF baseline Neutrino Factory

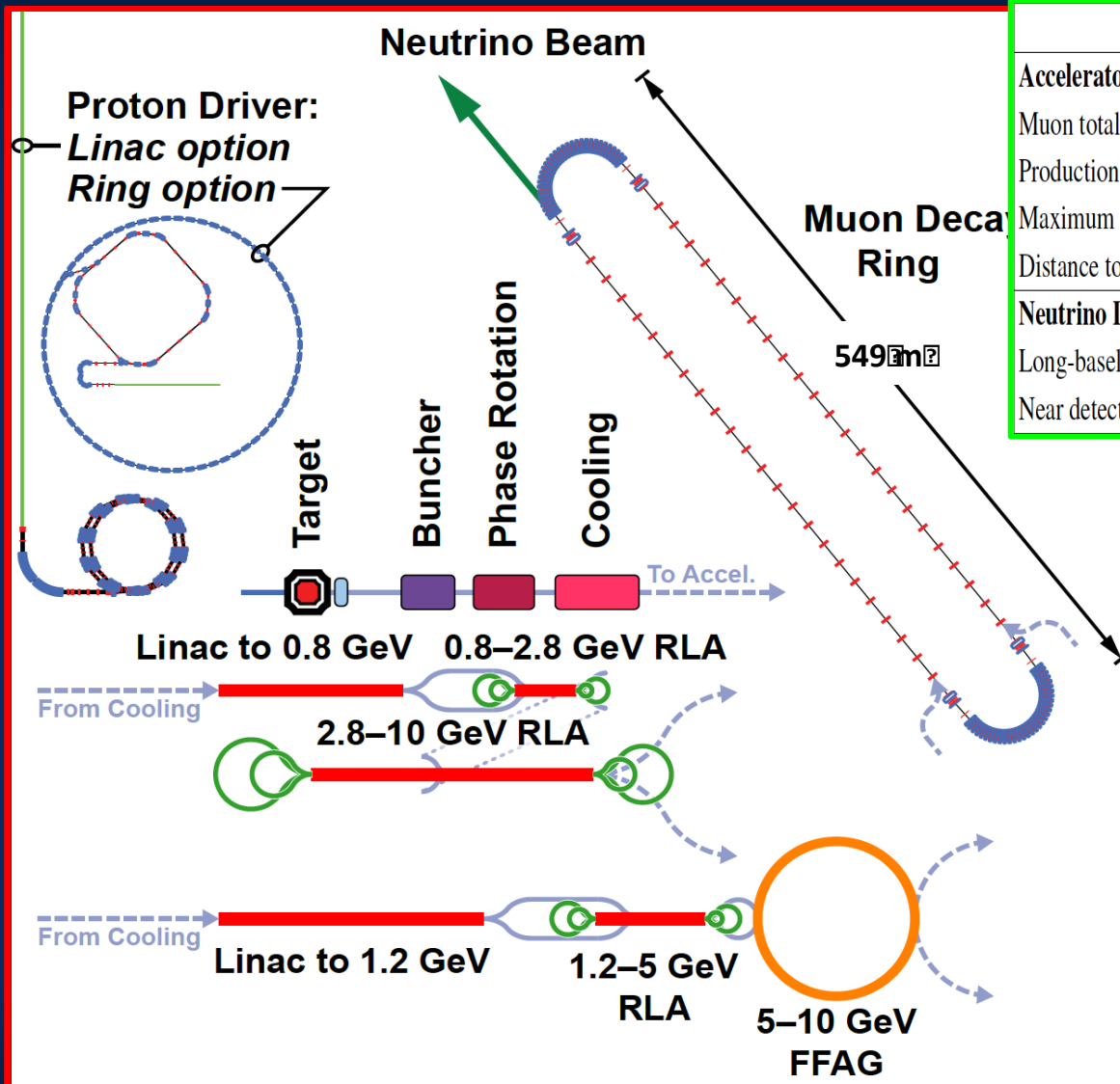

	Value
Accelerator facility	
Muon total energy	10 GeV
Production straight muon decays in 10^7 s	10^{21}
Maximum RMS angular divergence of muons in production straight	$0.1/\gamma$
Distance to intermediate baseline detector	1 500–2 500 km
Neutrino Detectors	
Long-baseline Magnetised Iron Detector (MIND)	100kT
Near detectors, magnetised, high-resolution spectrometers	2

K.Long
NuFACT12

How Could a Staged ν Factory (NuMAX) to SURF Perform?

What if we send beam from a $\sim 5\text{GeV}$ muon storage ring to LBNE?

- 1 MW, no muon cooling
- ⇒ 3 MW, w/cooling
- ⇒ 4 MW, w/cooling

What if we were able to have a magnetized LAr detector?
Or a MIND detector w/3 \times the

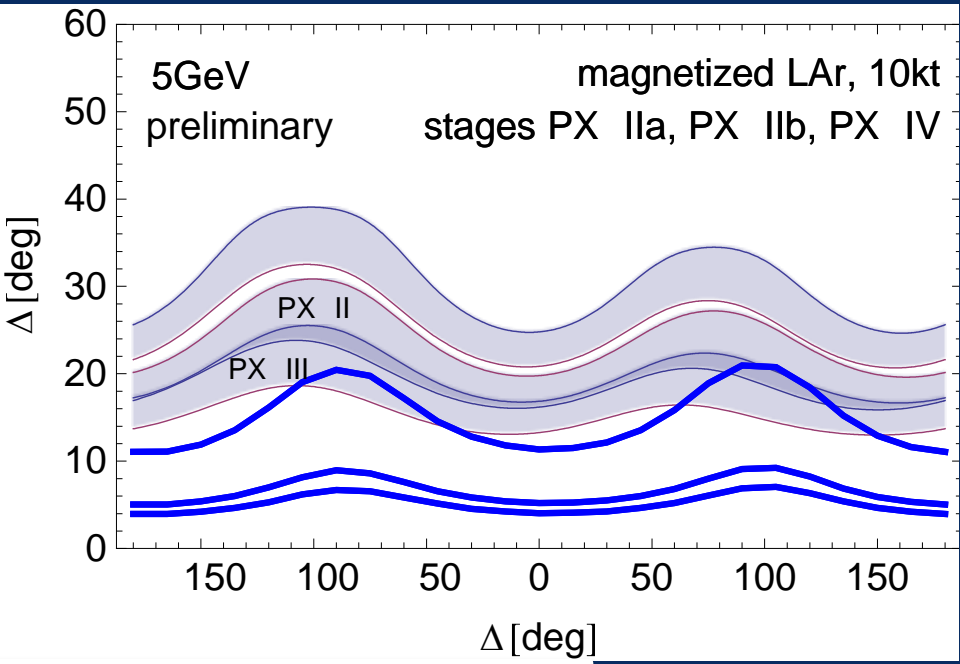
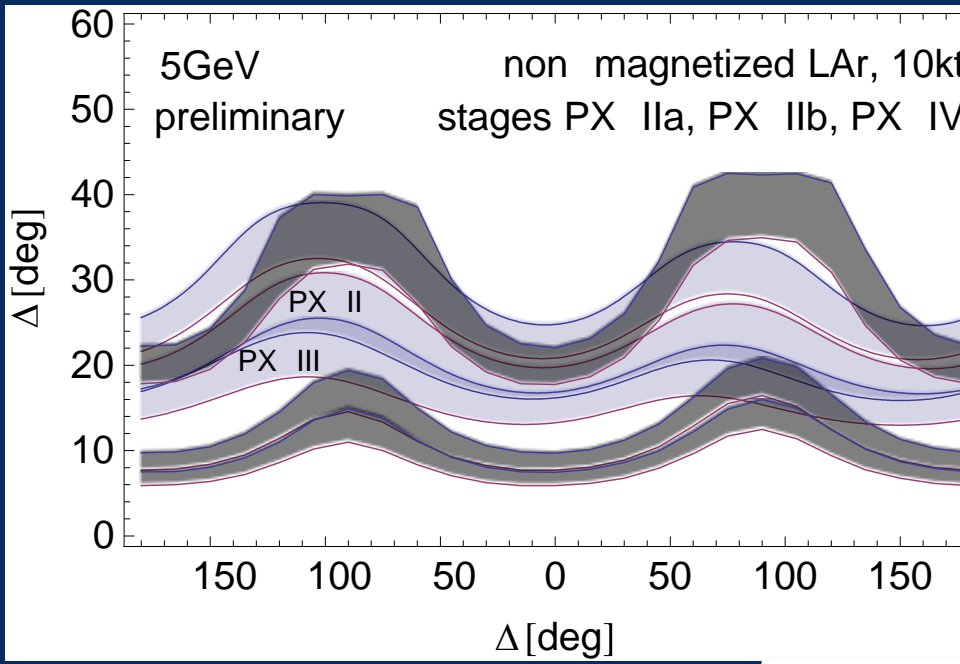

Gray bands represent range of possible detector performance per arXiv:0805.2019

Plots courtesy of P. Huber

Plots assume 100 kt-years

A Staged Plan with NuMAX at Fermilab



We want to provide the option to get here

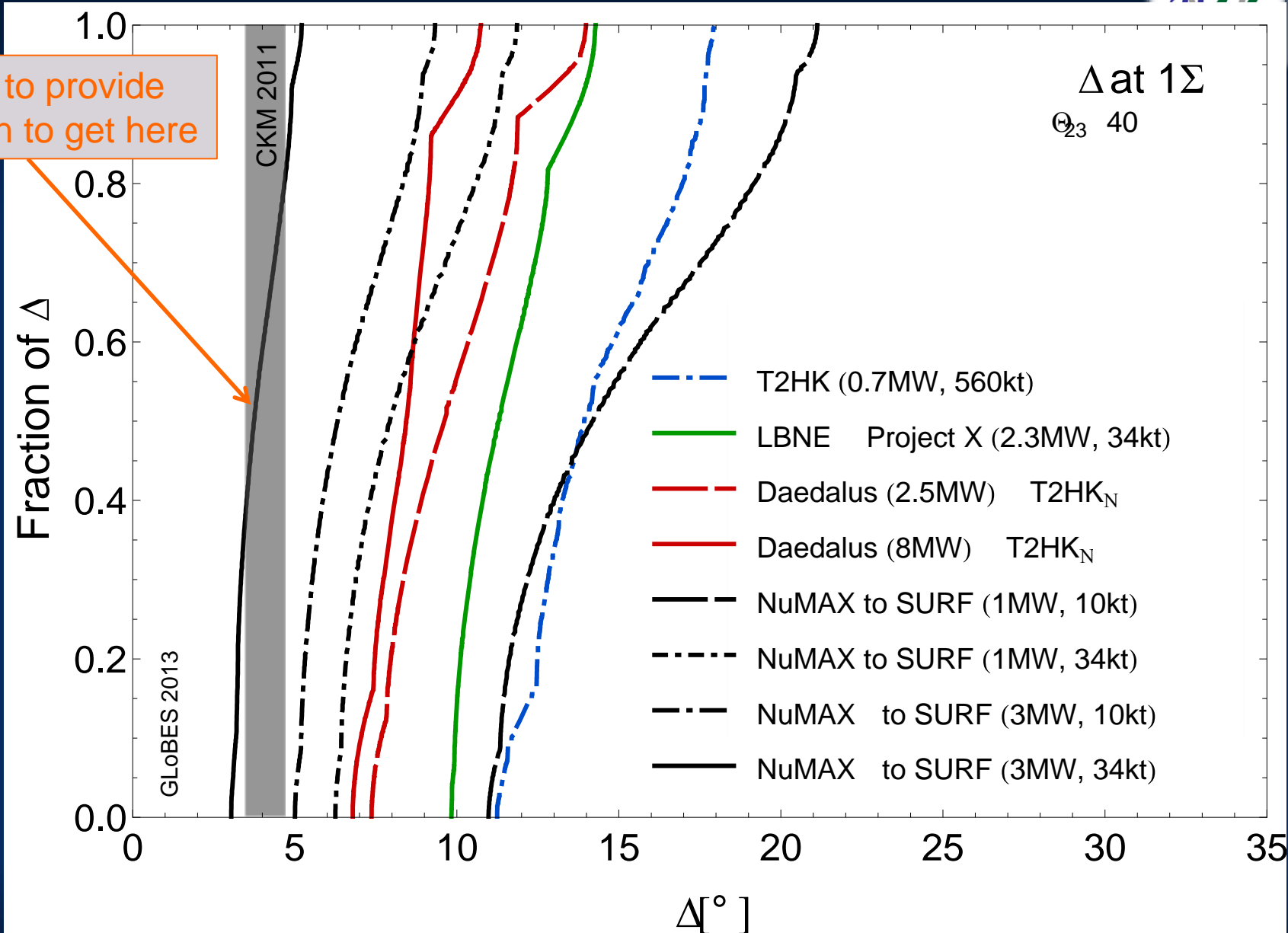

Neutrino Factory Staging (MASS)



Preliminary Staging Plan Based on Project X Stage 2

System	Parameters	Unit	nuSTORM	NuMAX	NuMAX+	IDS-NF	
Performance	Stored μ^+ or μ^- /year		8×10^{17}	2×10^{20}	1.2×10^{21}	1×10^{21}	
	ν_e or ν_μ to detectors/yr		3×10^{17}	8×10^{19}	5×10^{20}	5×10^{20}	
Detector	Far Detector:	Type	SuperBIND	MIND / Mag LAr	MIND / Mag LAr	MIND	
	Distance from Ring	km	1.9	1300	1300	2000	
	Mass	kT	1.3	30 / 10	100 / 30	100	
	Magnetic Field	T	2	0.5-2	0.5-2	1-2	
	Near Detector:	Type	SuperBIND	Suite	Suite	Suite	
	Distance from Ring	m	50	100	100	100	
	Mass	kT	0.1	1	2.7	2.7	
	Magnetic Field	T	Yes	Yes	Yes	Yes	
Neutrino Ring	Ring Momentum (P_μ)	GeV/c	3.8	5	5	10	
	Circumference (C)	m	480	600	600	1190	
	Straight section	m	185	235	235	470	
	Arc Length	m	50	65	65	125	
Acceleration	Initial Momentum	GeV/c	-	0.22	0.22	0.22	
	Single-pass Linac	GeV/pass	-	0.95	0.95	0.56	
		MHz	-	325	325	201	
	4.5-pass RLA	RLA I	GeV/pass	-	0.85	0.85	0.45
			MHz	-	325	325	201
		RLA II	GeV/pass	-	-	-	1.6
			MHz	-	-	-	201
Cooling			No	No	4D	4D	
Proton Source	Proton Beam Power	MW	0.2	1	3	4	
	Proton Beam Energy	GeV	120	3	3	10	
	Protons/year	1×10^{21}	0.1	41	125	25	
	Repetition Frequency	Hz	0.75	70	70	50	

For reference

126 GeV Higgs Factory

s-channel coupling of Muons to HIGGS with high cross sections:
Muon Collider of with $L = 10^{32} \text{ cm}^{-2}\text{s}^{-1}$ @ 63 GeV/beam (~15,000 Higgs/year)
Competitive with e+/e- Linear Collider with $L = 2 \cdot 10^{34} \text{ cm}^{-2}\text{s}^{-1}$ @ 126 GeV/beam
Sharp resonance: momentum spread of a few $\times 10^{-5}$

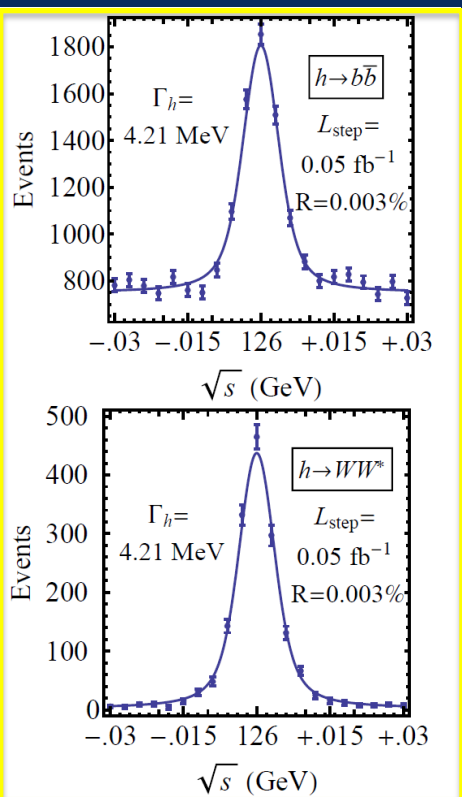

Precision energy measurement provided by g-2 effect and residual polarization in muon beams

Han and Liu
 hep-ph 1210.7803

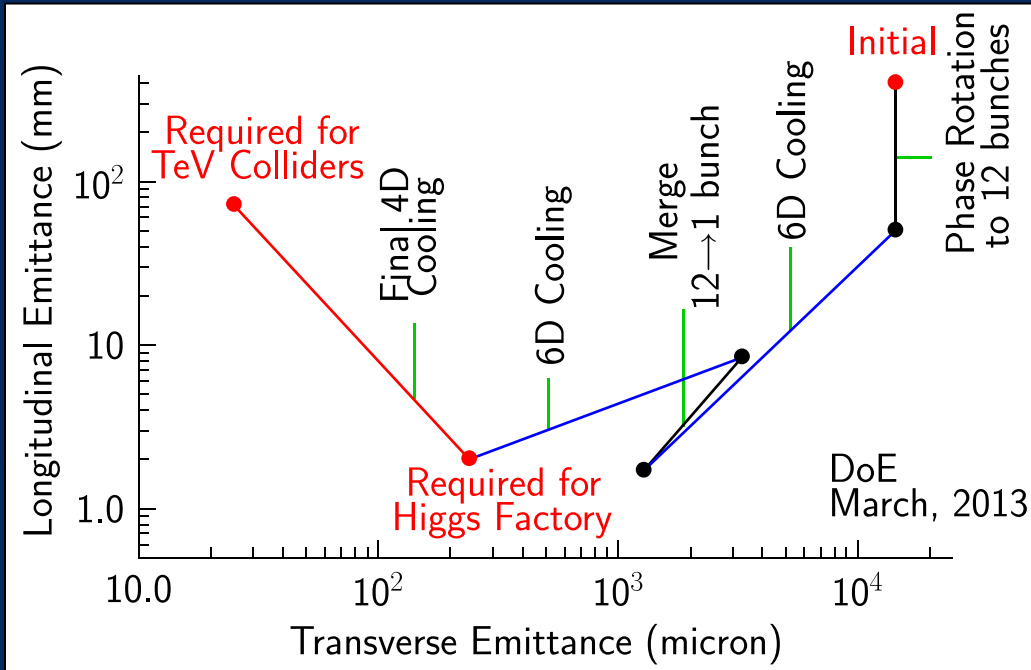

Reduced cooling:
 $\epsilon_{\perp N} = 0.3\pi \cdot \text{mm} \cdot \text{rad}$,
 $\epsilon_{\parallel N} = 1\pi \cdot \text{mm} \cdot \text{rad}$

Major advantage for Physics of a $\mu^+\mu^-$ Higgs Factory: possibility of direct measurement of the Higgs boson width ($\Gamma \sim 4 \text{ MeV}$ FWHM expected)

Updated 63 x 63 GeV Lattice

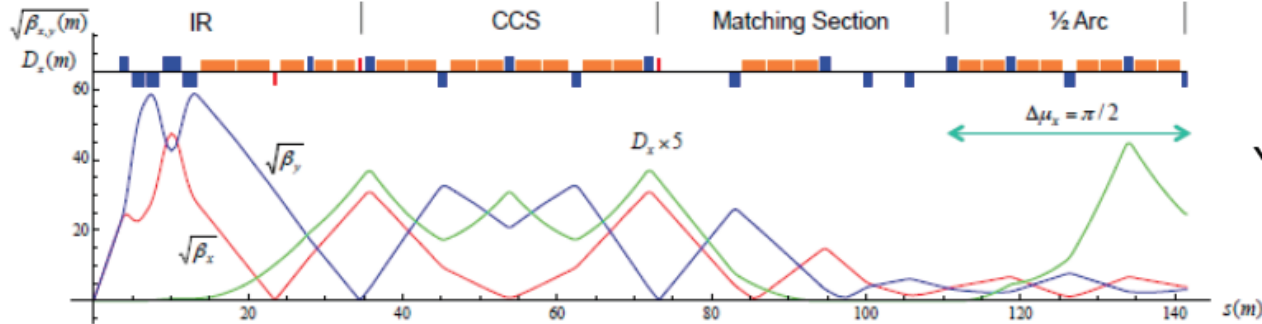

Y. Alexahin

Optics functions in half ring for $\beta^*=2.5\text{cm}$

Parameter

Beam energy	GeV	63	63
Average luminosity	$10^{31}/\text{cm}^2/\text{s}$	1.7	8.0
Collision energy spread	MeV	3	4
Circumference, C	m	300	300
Number of IPs	-	1	1
β^*	cm	3.3	1.7
Number of muons / bunch	10^{12}	2	4
Number of bunches / beam	-	1	1
Beam energy spread	%	0.003	0.004
Normalized emittance, $\epsilon_{\perp N}$	$\pi\text{-mm-rad}$	0.4	0.2
Longitudinal emittance, $\epsilon_{\parallel N}$	$\pi\text{-mm}$	1.0	1.5
Bunch length, σ_s	cm	5.6	6.3
Beam size at IP, r.m.s.	mm	0.15	0.075
Beam size in IR quads, r.m.s.	cm	4	4
Beam-beam parameter	-	0.005	0.02
Repetition rate	Hz	30	15
Proton driver power	MW	4	4

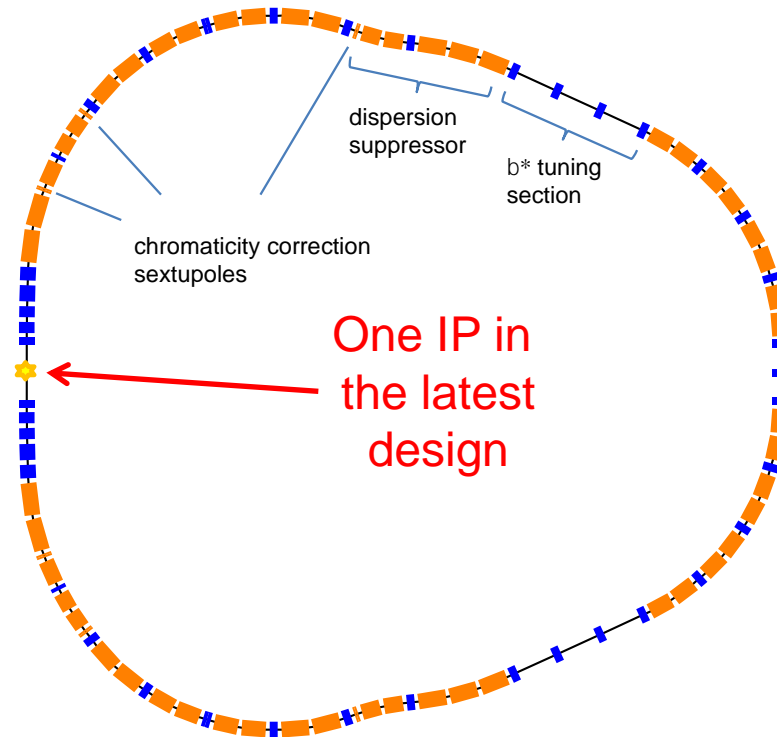

Multi-TeV Collider – 1.5 TeV Baseline



Y. Alexahin

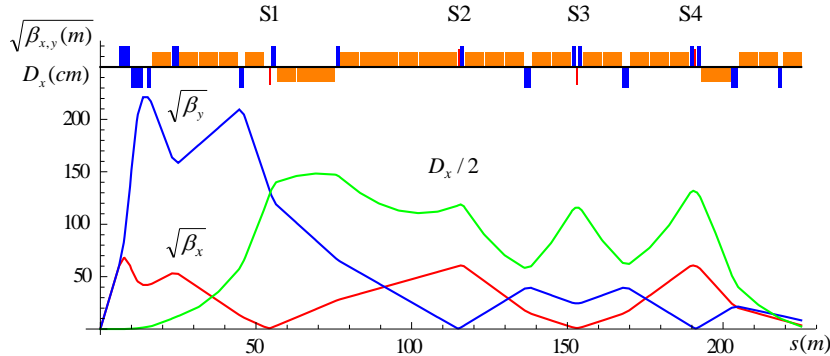

Larger chromatic function (W_y) is corrected first with a single sextupole S1, W_x is corrected with two sextupoles S2, S4 separated by 180° phase advance.

Parameter	Unit	Value
Beam energy	TeV	0.75
Repetition rate	Hz	15
Average luminosity / IP	$10^{34}/\text{cm}^2/\text{s}$	1.1
Number of IPs, N_{IP}	-	2
Circumference, C	km	2.73
β^*	cm	1 (0.5-2)
Momentum compaction, α_p	10^{-5}	-1.3
Normalized r.m.s. emittance, $\varepsilon_{\perp N}$	$\pi \cdot \text{mm} \cdot \text{mrad}$	25
Momentum spread, σ_p/p	%	0.1
Bunch length, σ_s	cm	1
Number of muons / bunch	10^{12}	2
Number of bunches / beam	-	1
Beam-beam parameter / IP, ξ	-	0.09
RF voltage at 800 MHz	MV	16

Wall Plug Power Estimates



Lepton Colliders: Wall Plug Power

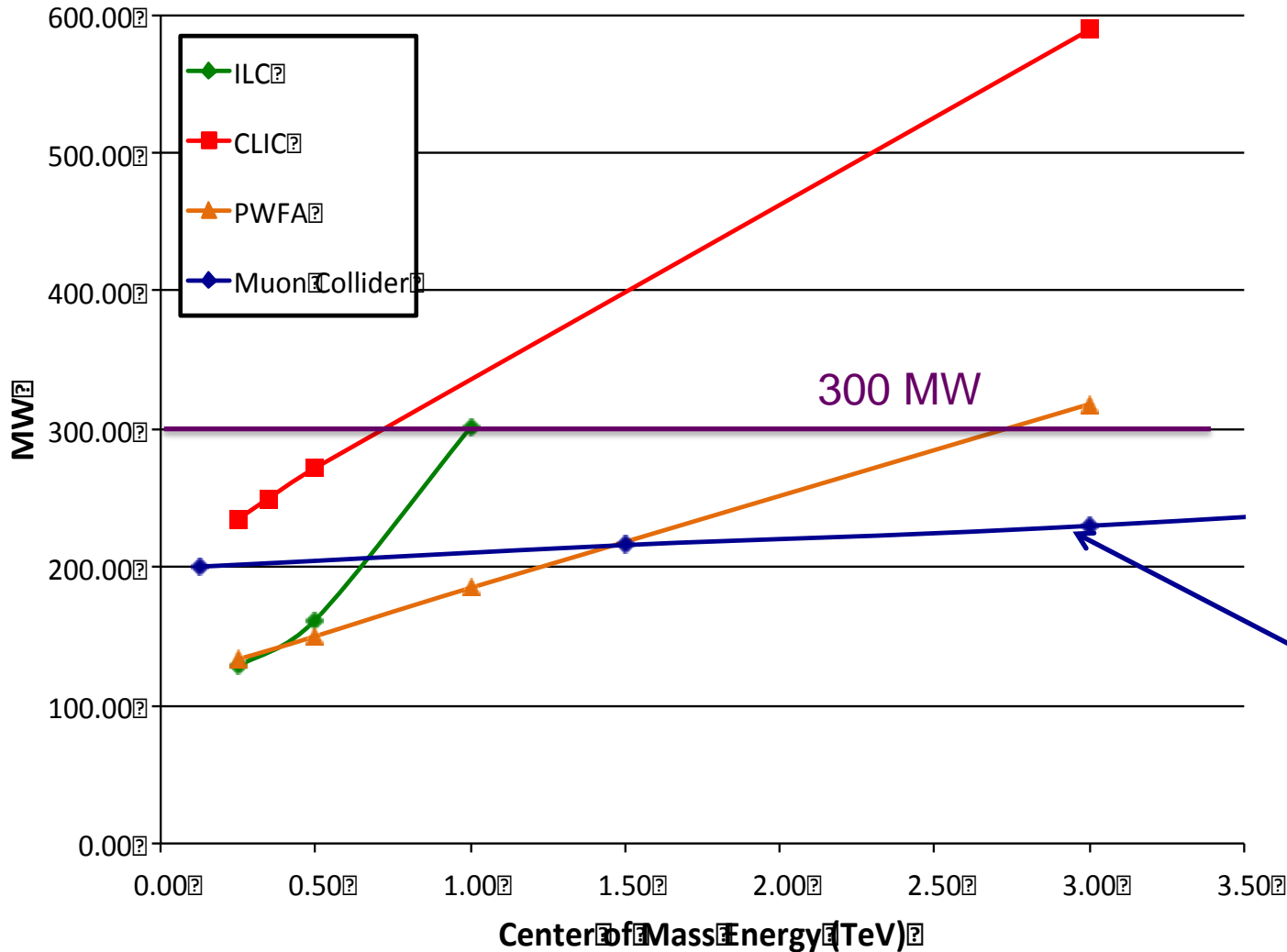

Estimate assumes a base 70MW Facility Power requirement as in LC analyses.

Muon Collider

Luminosity Production Metric



Lepton Colliders Figure of Merit: Luminosity/Wall Power

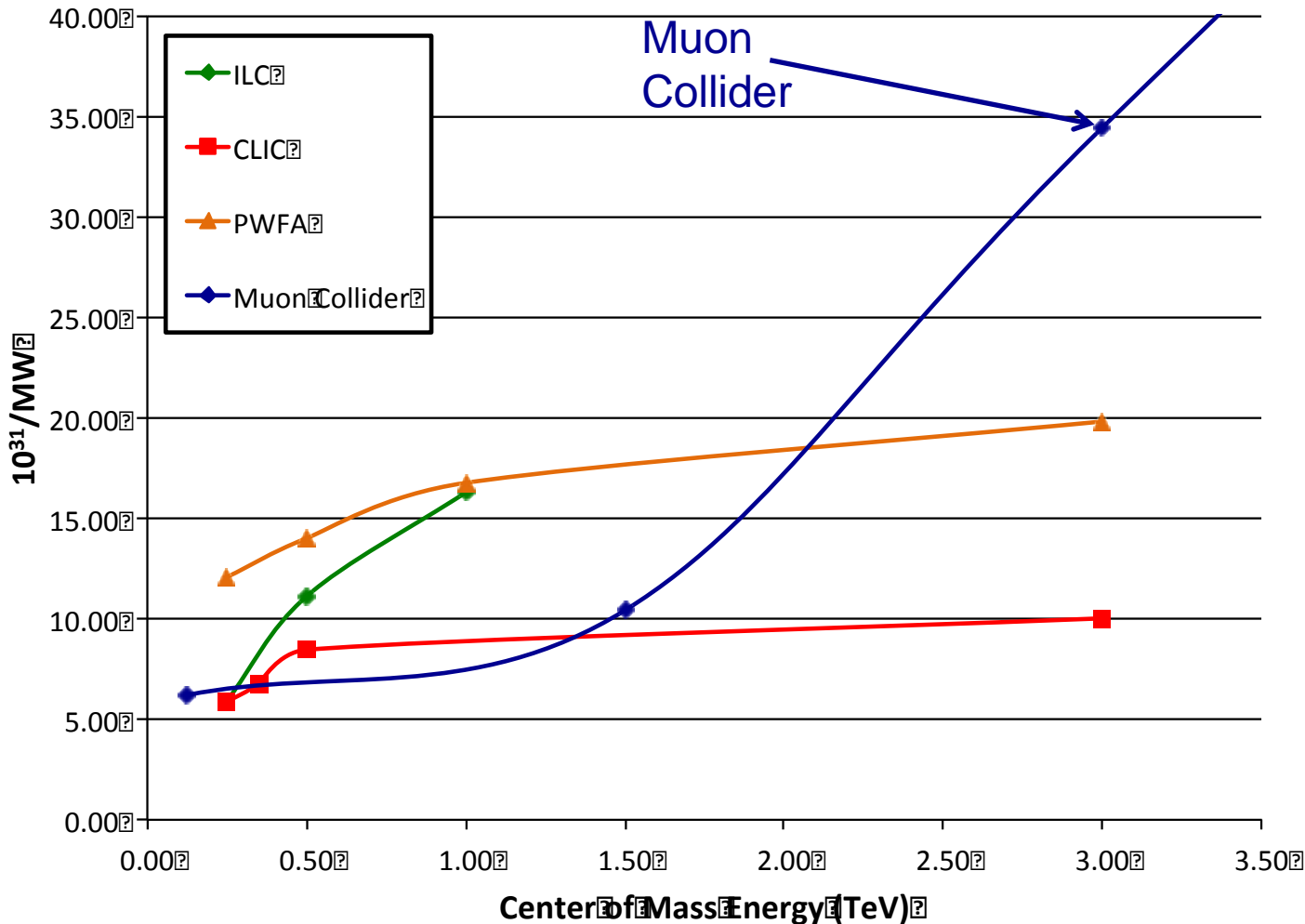

Luminosity Metric:

$$N_{\text{det}} \times L_{\text{avg}} / P_{\text{tot}}$$

Muon Collider Parameters



Muon Collider Parameters

Parameter	Units	Higgs Factory		Top Threshold Options		Multi-TeV Baselines		Accounts for Site Radiation Mitigation
		Startup Operation	Production Operation	High Resolution	High Luminosity			
CoM Energy	TeV	0.126	0.126	0.35	0.35	1.5	3.0	6.0
Avg. Luminosity	$10^{34} \text{ cm}^{-2} \text{ s}^{-1}$	0.0017	0.008	0.07	0.6	1.25	4.4	12
Beam Energy Spread	%	0.003	0.004	0.01	0.1	0.1	0.1	0.1
Higgs* or Top* Production/ 10^7 sec		3,500*	13,500*	7,000*	60,000*	37,500*	200,000*	820,000*
Circumference	km	0.3	0.3	0.7	0.7	2.5	4.5	6
No. of IPs		1	1	1	1	2	2	2
Repetition Rate	Hz	30	15	15	15	15	12	6
b*	cm	3.3	1.7	1.5	0.5	1(0.5-2)	0.5(0.3-3)	2.5
No. muons/bunch	10^{12}	2	4	4	3	2	2	2
No. bunches/beam		1	1	1	1	1	1	1
Norm. Trans. Emittance, ϵ_{TN}	$\mu \text{ mm-rad}$	0.4	0.2	0.2	0.05	0.025	0.025	0.025
Norm. Long. Emittance, ϵ_{LN}	$\mu \text{ mm-rad}$	1	1.5	1.5	10	70	70	70
Bunch Length, ϵ_s	cm	5.6	6.3	0.9	0.5	1	0.5	2
Proton Driver Power	MW	4 [#]	4	4	4	4	4	1.6

Could begin operation with Project X Stage 1 beam

Exquisite Energy Resolution Allows Direct Measurement of Higgs Width

Success of advanced cooling concepts \Rightarrow several $\leq 10^{32}$

Site Radiation mitigation with depth and lattice design: ≤ 10 TeV

A Muon Accelerator Facility for Cutting Edge Physics on the Intensity and Energy Frontiers Based on Project X Stage II

A TeV-scale Collider at Fermilab

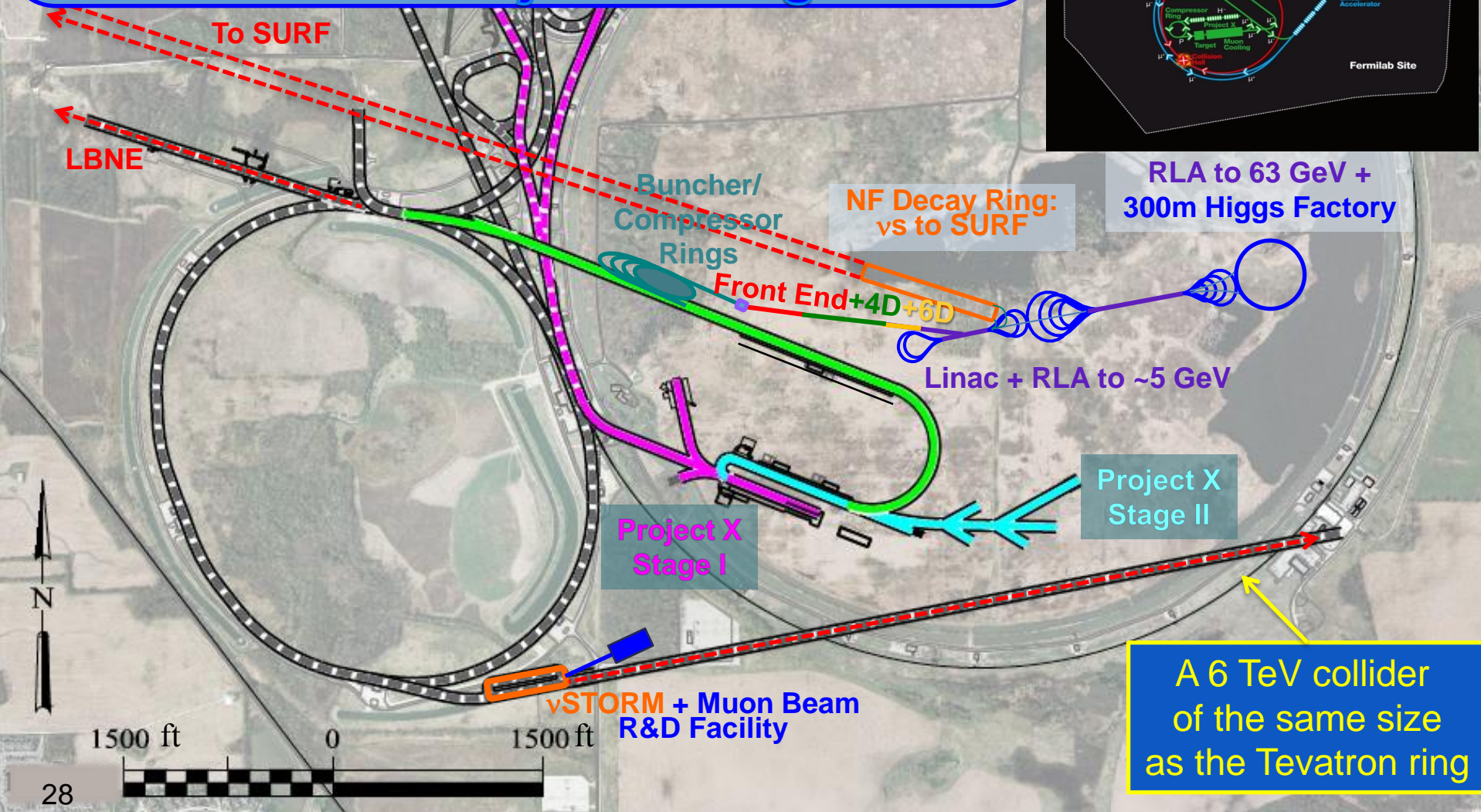
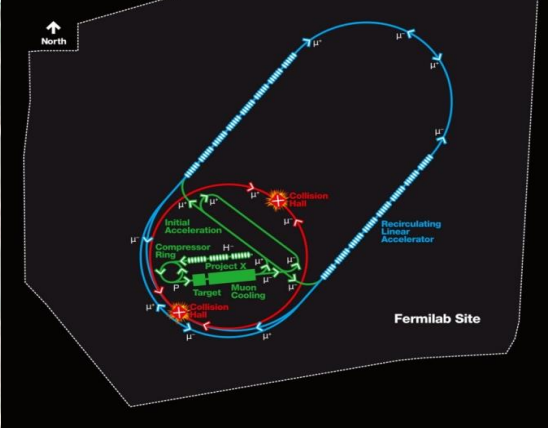

MAP Timeline ⇒ Provide Informed Decision Points

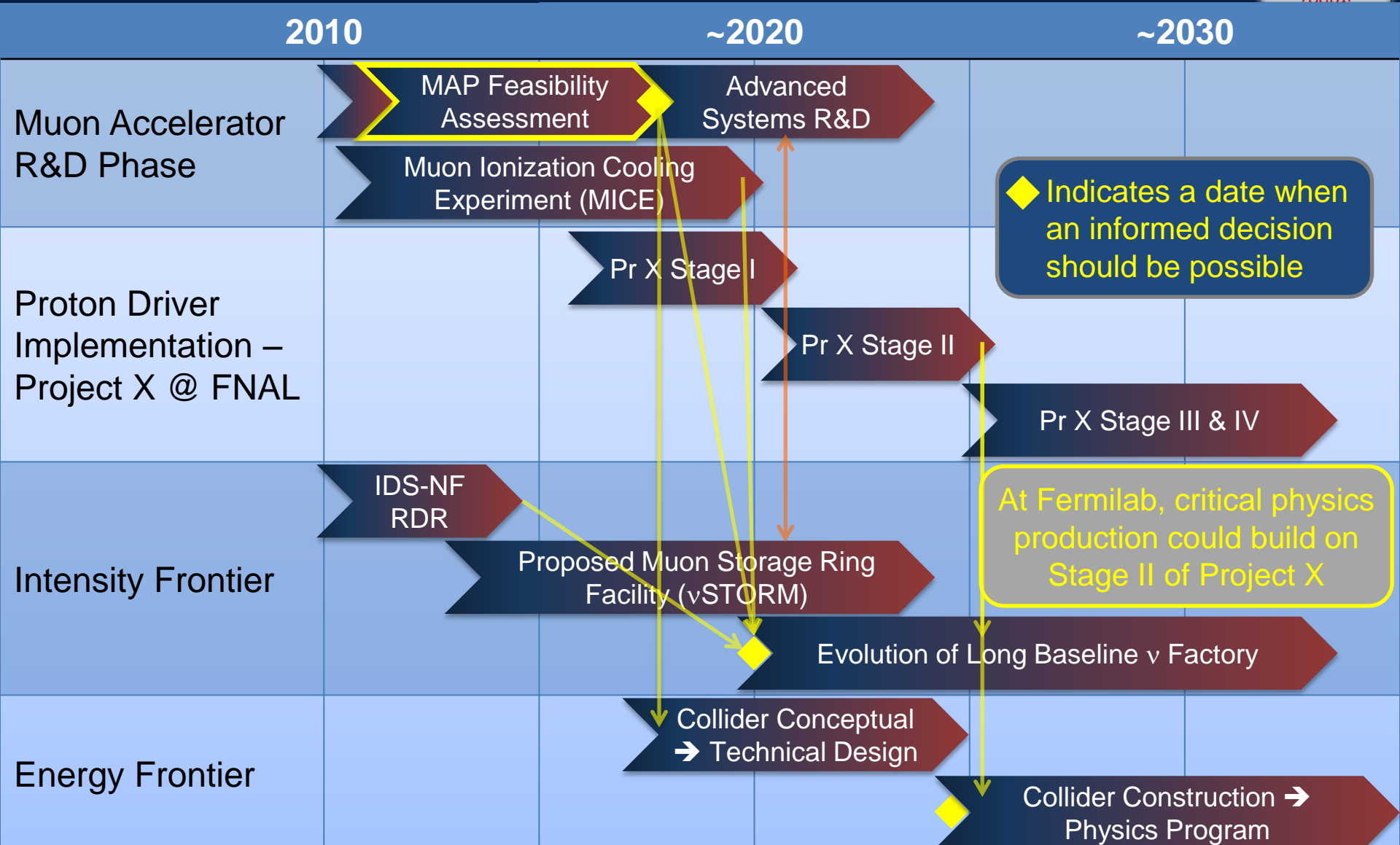



THE R&D CHALLENGES AND THE MAP FEASIBILITY ASSESSMENT

Technology Challenges – Tertiary Production

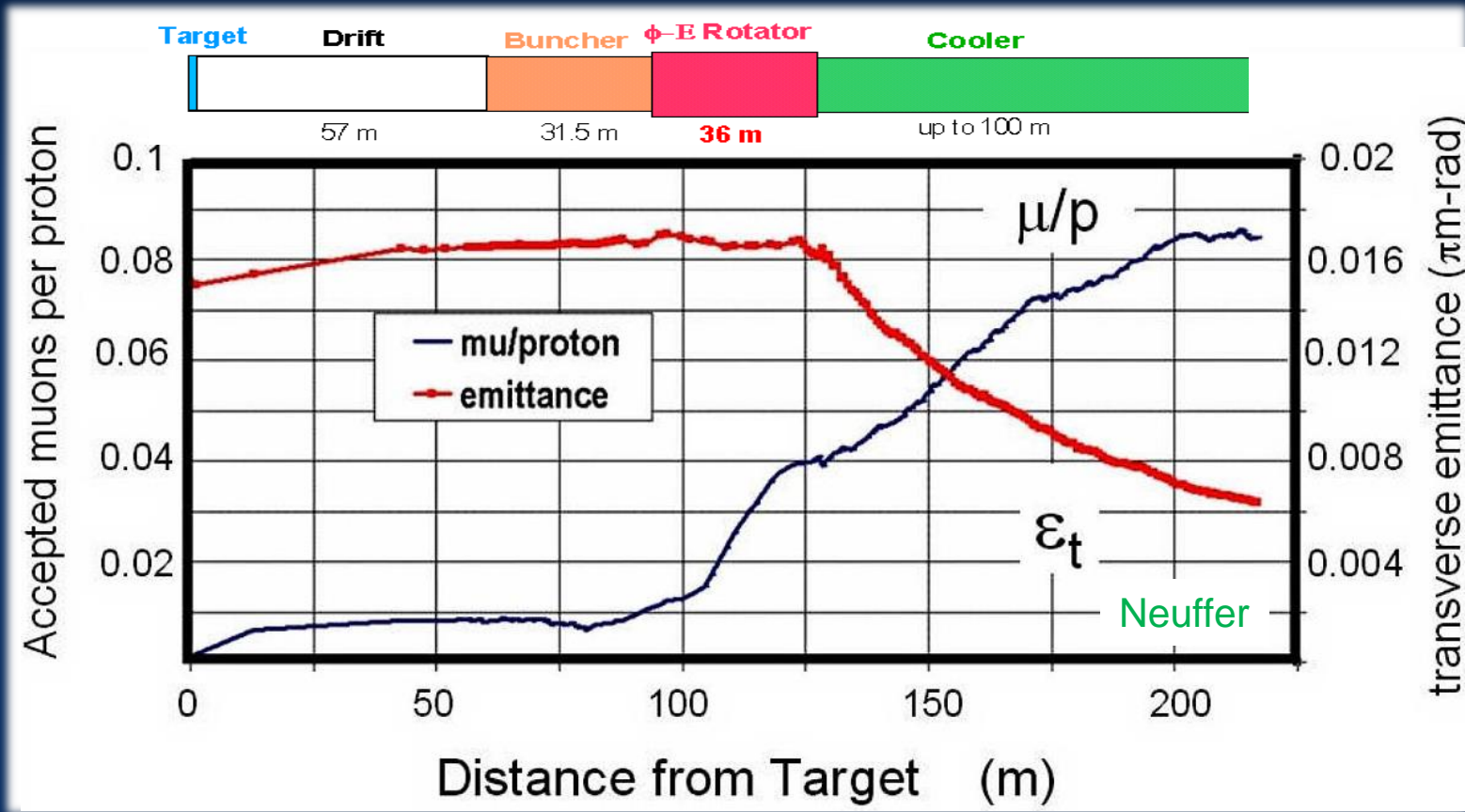

- A multi-MW proton source, e.g., Project X, will enable $O(10^{21})$ muons/year to be produced, bunched and cooled to fit within the acceptance of an accelerator.

Key Technologies - Target

- The MERIT Experiment at the CERN PS
 - Demonstrated a 20m/s liquid Hg jet injected into a 15 T solenoid and hit with a 115 KJ/pulse beam!
 - ⇒ Jets could operate with beam powers up to **8 MW** with a repetition rate of 70 Hz
- MAP staging aimed at initial 1 MW target

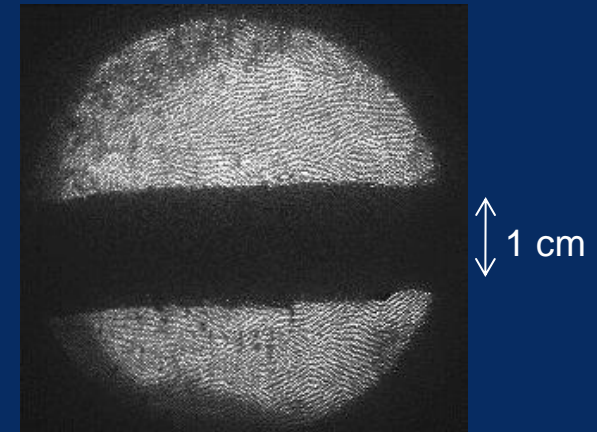
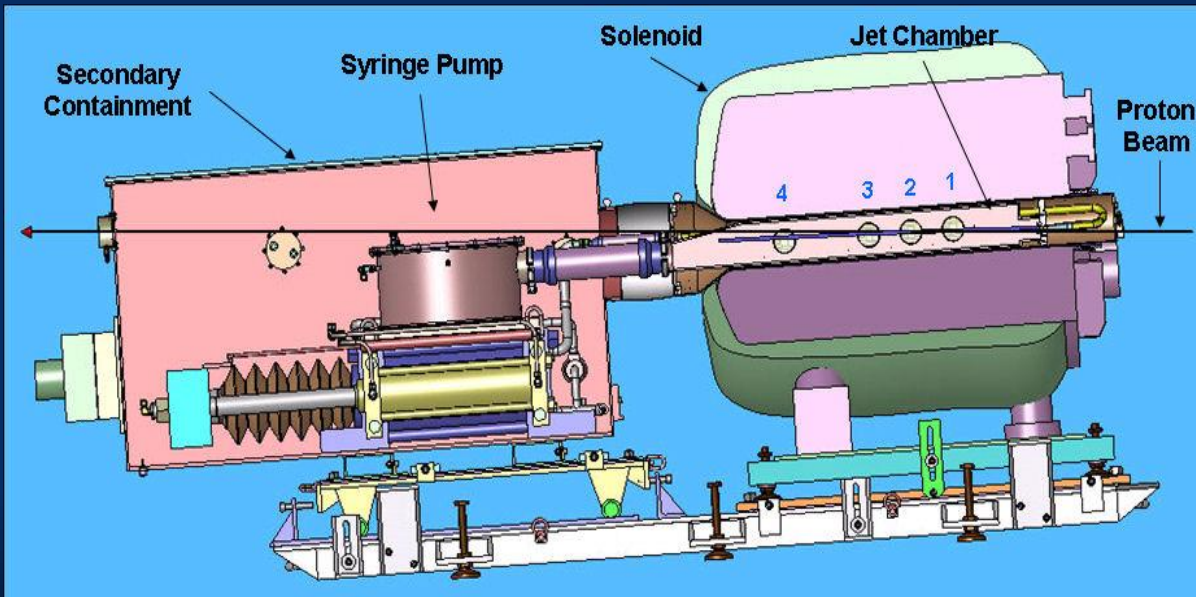

Hg jet in a 15 T solenoid with measured disruption length ~ 28 cm

Technology Challenges – Capture Solenoid

- A Neutrino Factory and/or Muon Collider Facility requires challenging magnet design in several areas:
 - Target Capture Solenoid (15-20T with large aperture)

$E_{\text{stored}} \sim 3 \text{ GJ}$

O(10MW) resistive coil in high radiation environment

Possible application for High Temperature Superconducting magnet technology

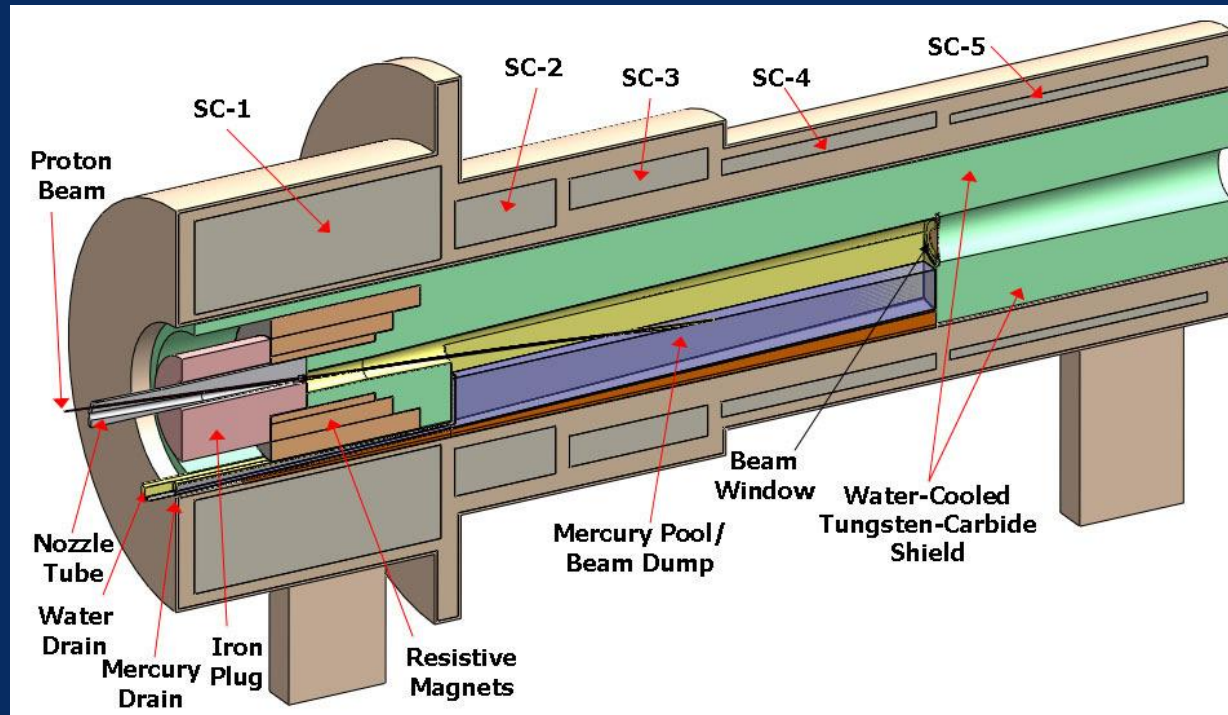

Technology Challenges - Cooling



Development of a cooling channel design to reduce the 6D phase space by a factor of $O(10^6)$ → MC luminosity of $O(10^{34}) \text{ cm}^{-2} \text{ s}^{-1}$

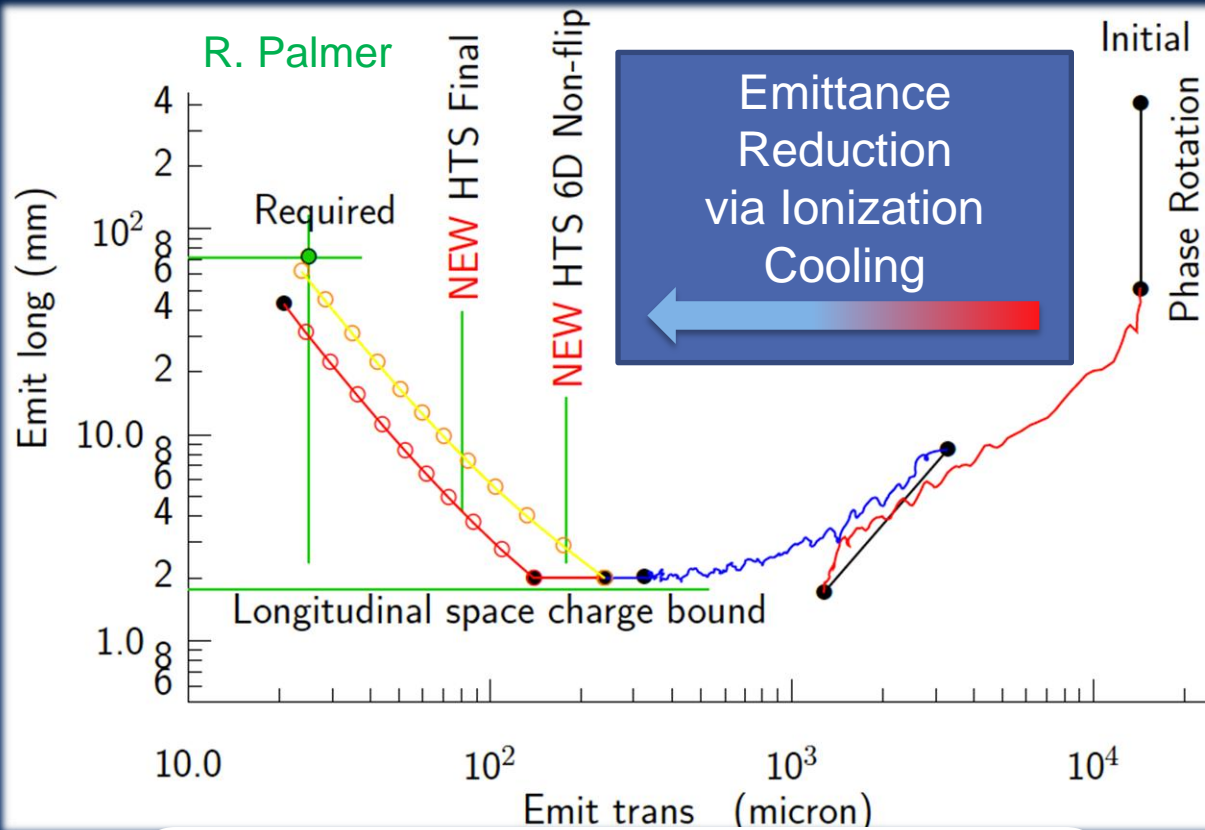

- Some components beyond state-of-art:
 - Very high field HTS solenoids ($\geq 30 \text{ T}$)
 - High gradient RF cavities operating in multi-Tesla fields

The program targets critical magnet and cooling cell technology demonstrations within its feasibility phase.

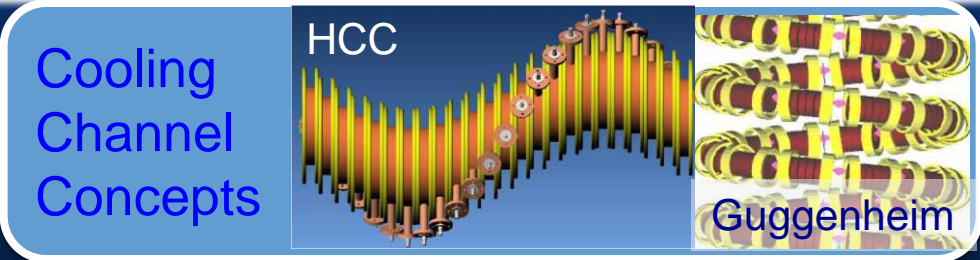

Technology Challenges - Cooling

- Tertiary production of muon beams
 - Initial beam emittance intrinsically large
 - Cooling mechanism required, but no radiation damping
- Muon Cooling \Rightarrow Ionization Cooling
 - dE/dx energy loss in materials
 - RF to replace ρ_{long}

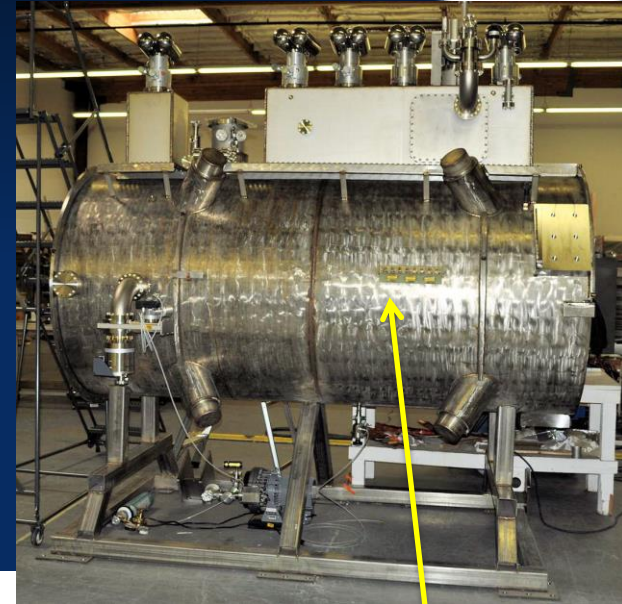

The Muon Ionization Cooling Experiment: Demonstrate the method and validate our simulations

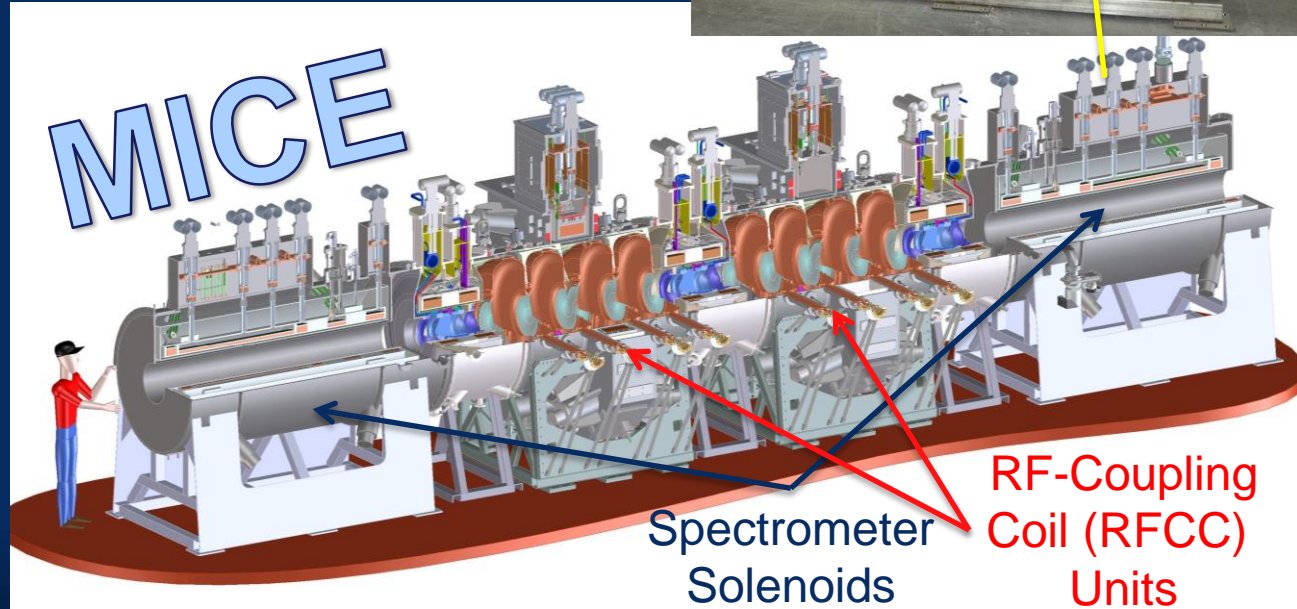

Elements of the R&D Program



MuCool Test Area



Entrance of MTA exp. hall

Compressor + refrigerator room

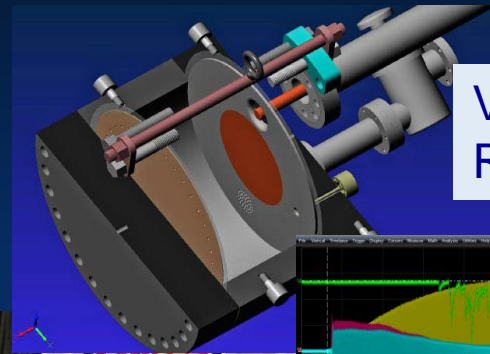

Vacuum RF Cavity

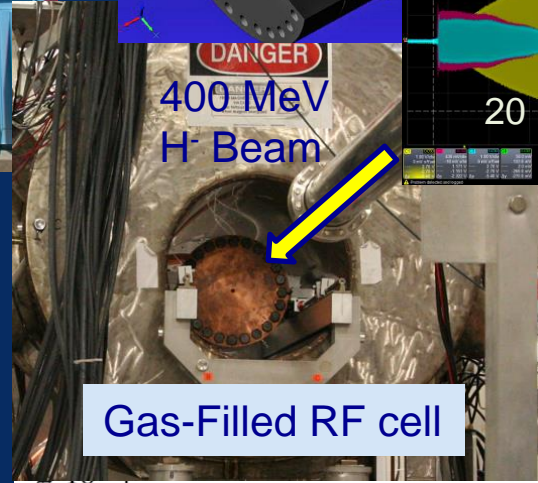
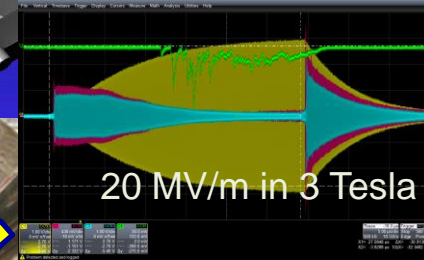

MTA Hall

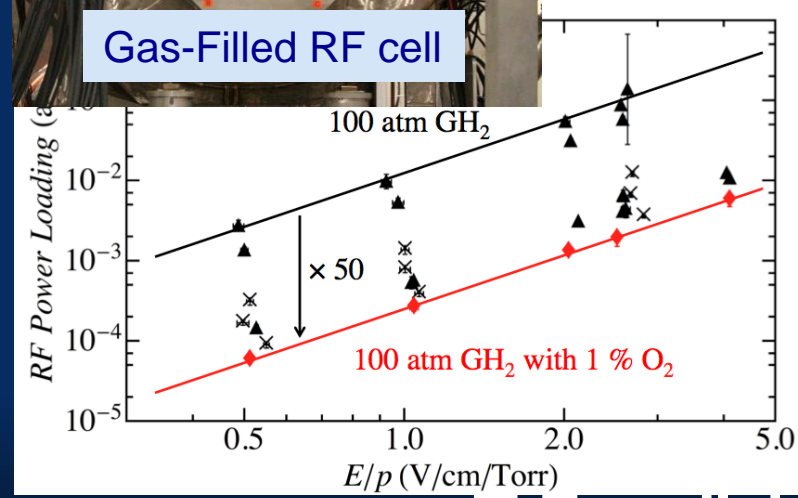
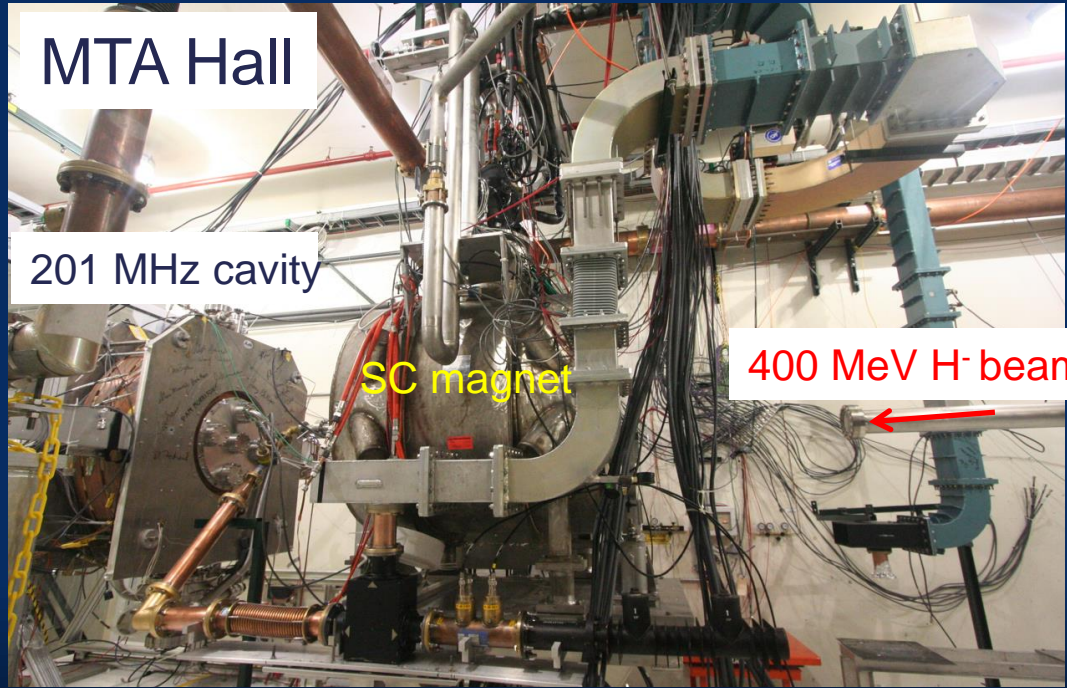

Recent Progress – Vacuum RF

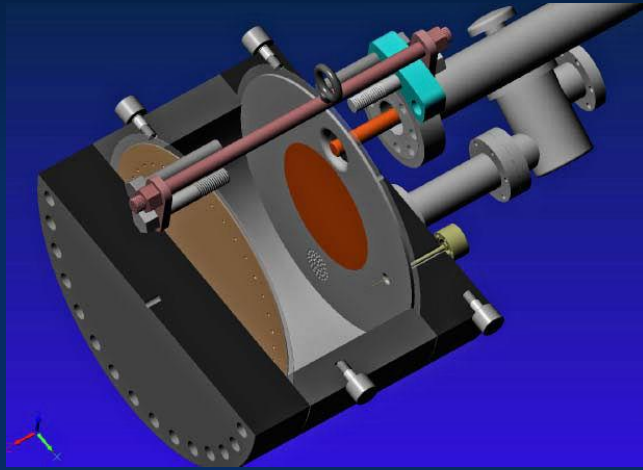

All-Seasons Cavity

(designed for both vacuum and high pressure operation)

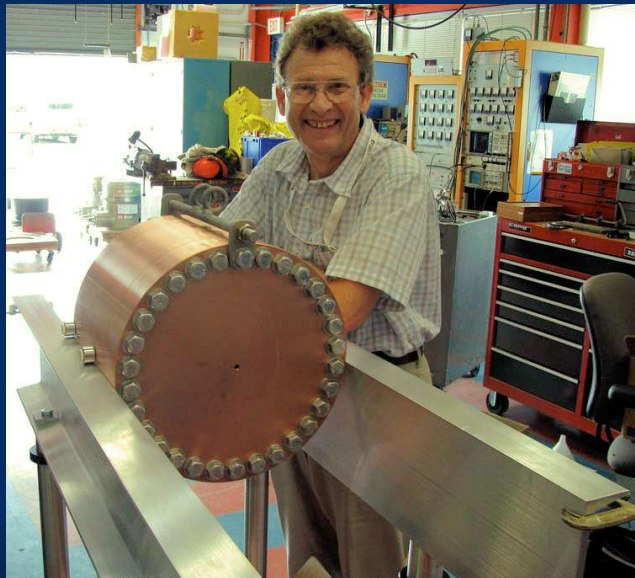
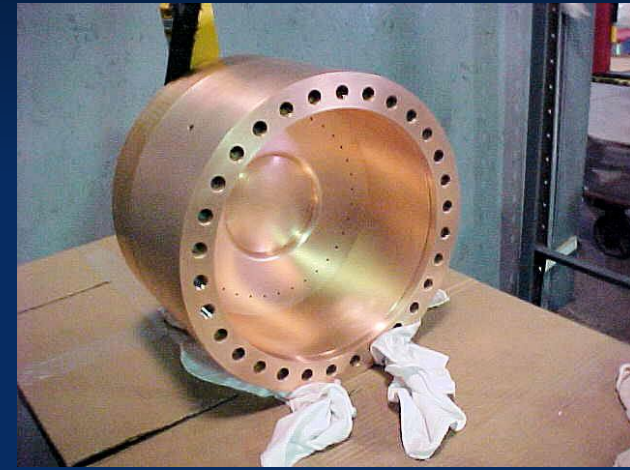

- Vacuum Tests at $B = 0$ T & $B = 3$ T
 - Two cycles: $B_0 \Rightarrow B_3 \Rightarrow B_0 \Rightarrow B_3$
- No difference in maximum stable operating gradient
 - Gradient ≈ 25 MV/m
- Demonstrates possibility of successful operation of vacuum cavities in magnetic fields with careful design
- *Also progress on alternative cavity materials*

Recent Progress - High Pressure RF



- Gas-filled cavity
 - Can moderate dark current and breakdown currents in magnetic fields
 - Can contribute to cooling
 - Is loaded, however, by beam-induced plasma

- Electronegative Species
 - Dope primary gas
 - Can moderate the loading effects of beam-induced plasma by scavenging the relatively mobile electrons

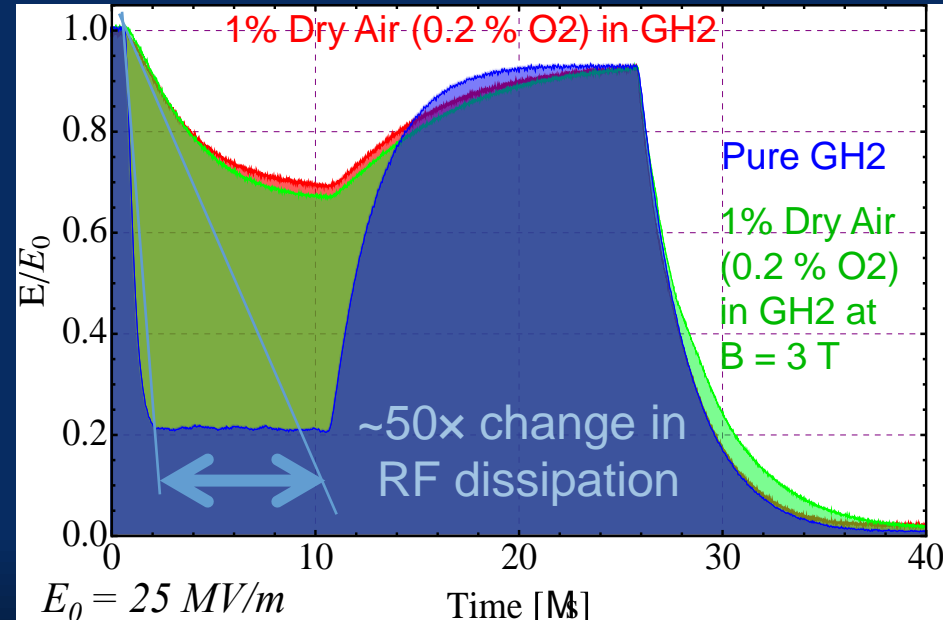
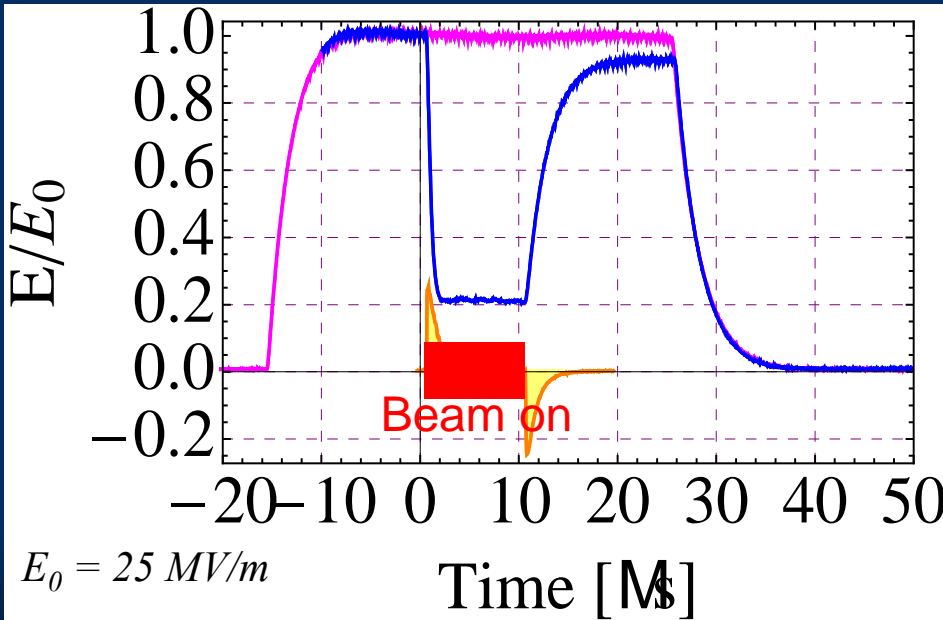

Recent Progress - High Field Magnets



Progress towards a demonstration of a final stage cooling solenoid:

- Demonstrated 15+ T (16+ T on coil)
 - ~25 mm insert HTS solenoid
 - BNL/PBL YBCO Design
 - Highest field ever in HTS-only solenoid (by a factor of ~1.5)
- Developing a test program for operating HTS insert + mid-sert in an external solenoid \Rightarrow >30 T



BSCCO-2212 -

- New cable fabrication methods with demonstrated J_E
- Hyperbaric processing to avoid strand damage

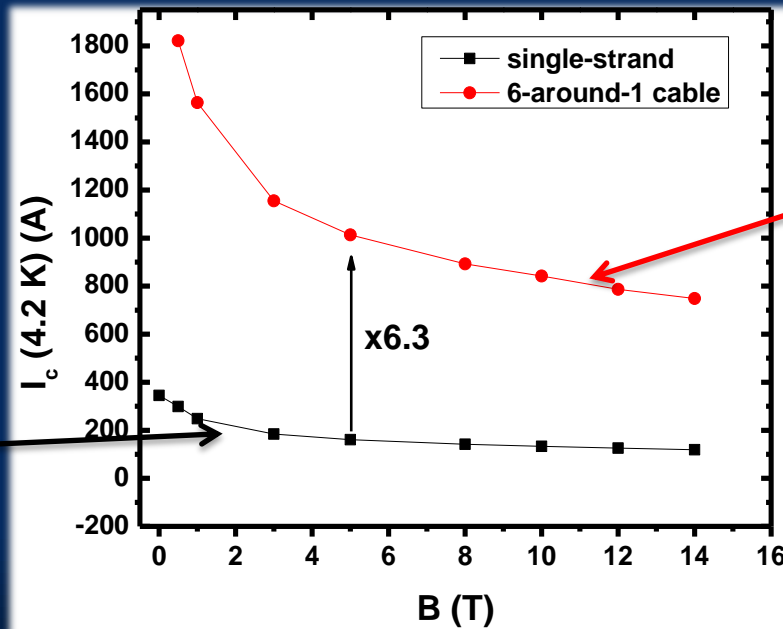

Multi-strand cable utilizing chemically compatible alloy and oxide layer to minimize cracks



Cooling Channel R&D Effort

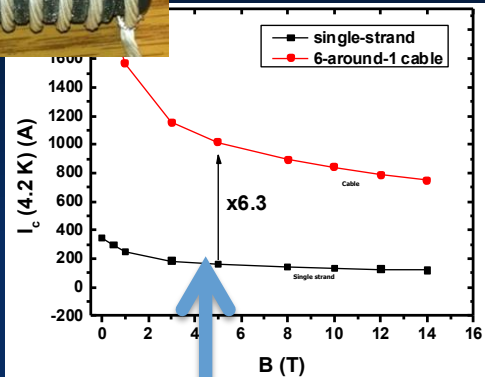

Successful Operation of 805 MHz “All Seasons” Cavity in 3T Magnetic Field under Vacuum

MuCool Test Area/Muons Inc

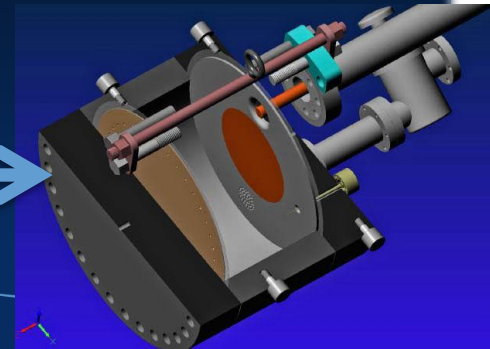

Breakthrough in HTS Cable Performance with Cables Matching Strand Performance

FNAL-Tech Div
T. Shen-Early Career Award

The Path to a Viable Muon Ionization Cooling Channel

World Record HTS-only Coil

15T on-axis field
16T on coil
PBL/BNL

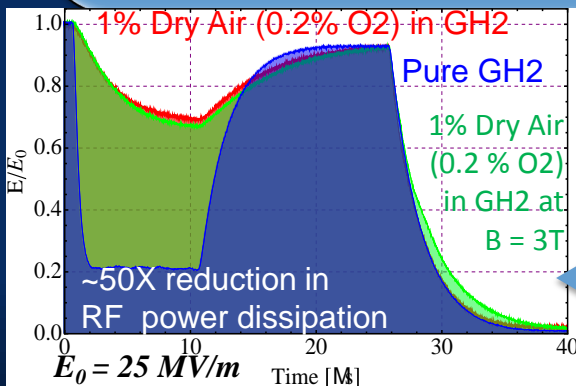

Demonstration of High Pressure RF Cavity in 3T Magnetic Field with Beam

Extrapolates to μ -Collider Parameters

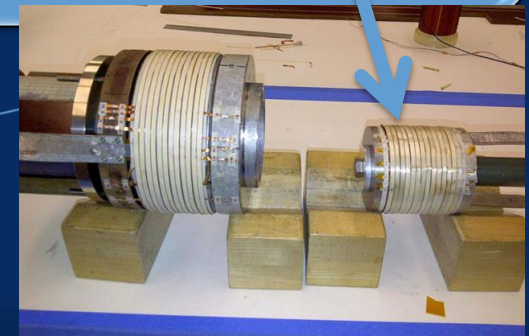

Technology Challenges - Acceleration

- Muons require an ultrafast accelerator chain
 ⇒ *Beyond the capability of most machines*
- Solutions include:

- Superconducting Linacs
- Recirculating Linear Accelerators (RLAs)
- Fixed-Field Alternating-Gradient (FFAG) Machines
- Rapid Cycling Synchrotrons (RCS)

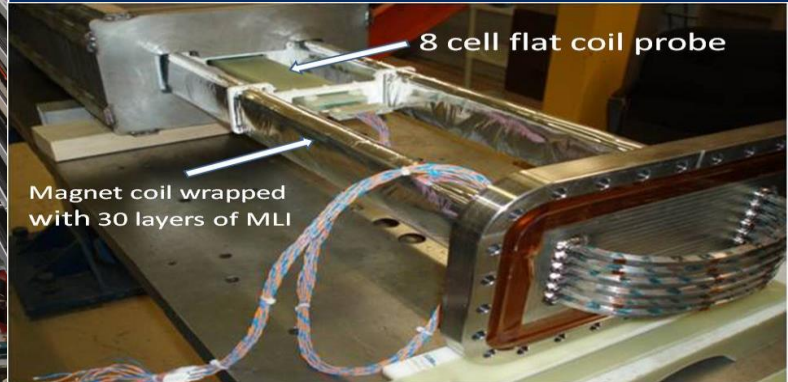
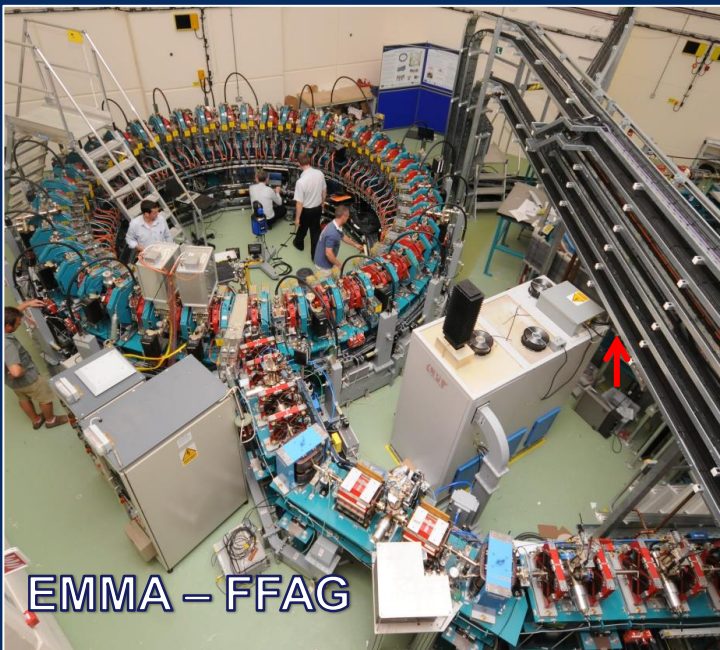

RCS requires
 2 T p-p magnets
 at $f = 400$ Hz
 (U Miss & FNAL)

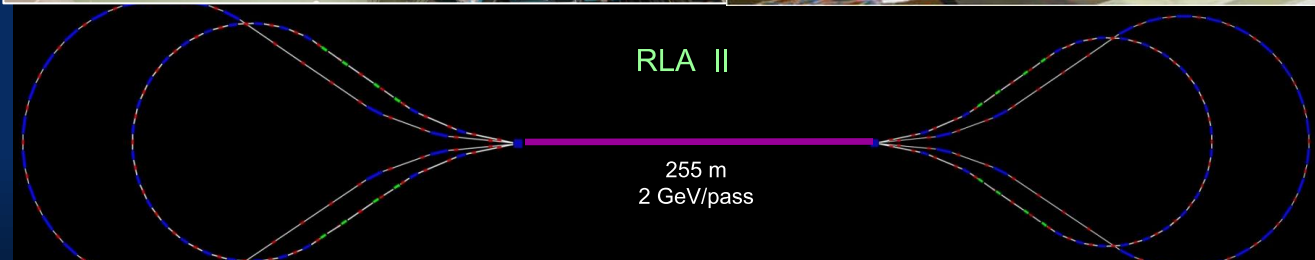

JEMMRLA Proposal:
 JLAB Electron Model of
 Muon RLA with Multi-pass
 Arcs

Superconducting RF Development



201 MHz SCRF R&D

Major dia.: 1.4 m

Cavity going into test pit
in Newman basement
(Cornell University)

400mm BT

Cavity length: 2 m

Pit: 5m deep X 2.5m dia.

Technology & Design Challenges – Ring, Magnets, Detector

- Emittances are relatively large, but muons circulate for ~ 1000 turns before decaying
 - Lattice studies for 126 GeV, 1.5 & 3 TeV CoM
- High field dipoles and quadrupoles must operate in high-rate muon decay backgrounds
 - Magnet designs under study
- Detector shielding & performance
 - Initial studies for 1.5 TeV, then 3 TeV and now 126 GeV
 - Shielding configuration
 - MARS background simulations

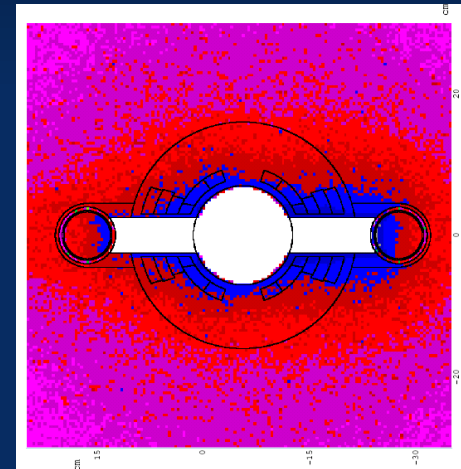

MARS energy deposition map for 1.5 TeV collider dipole

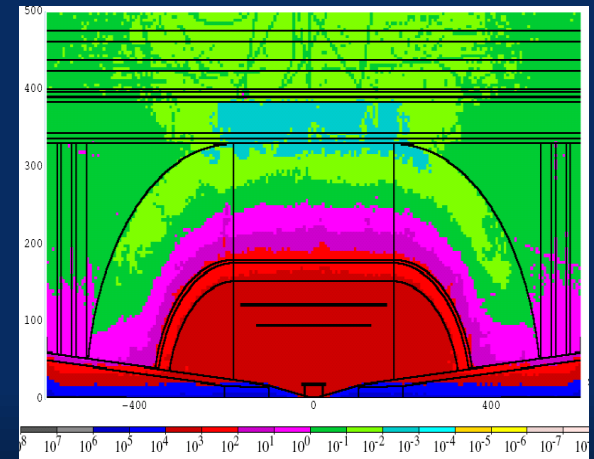

Backgrounds and Detector



Much of the background is soft and out of time

- Nanosecond time resolution can reduce backgrounds by three orders of magnitude

Requires a fast, pixelated tracker and calorimeter.

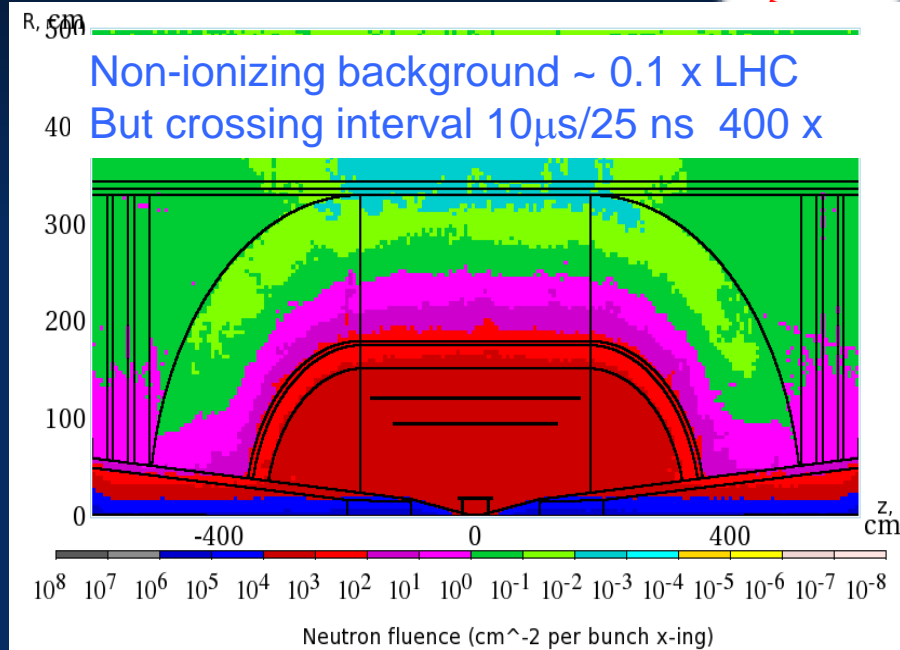

	Cut	Rejection
Tracker hits	1 ns, dedx	9×10^{-4}
Calorimeter neutrons	2 ns	2.4×10^{-3}
Calorimeter photons	2 ns	2.2×10^{-3}

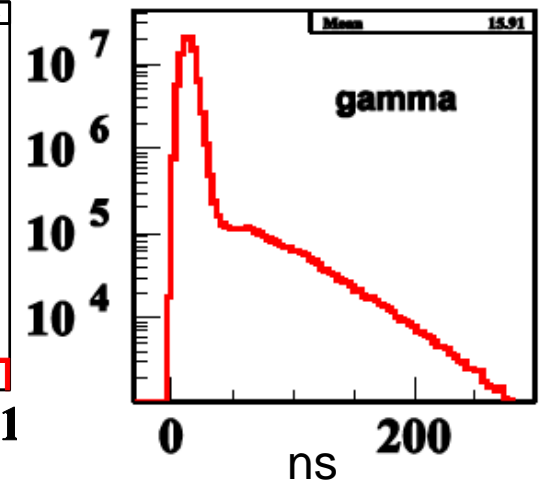
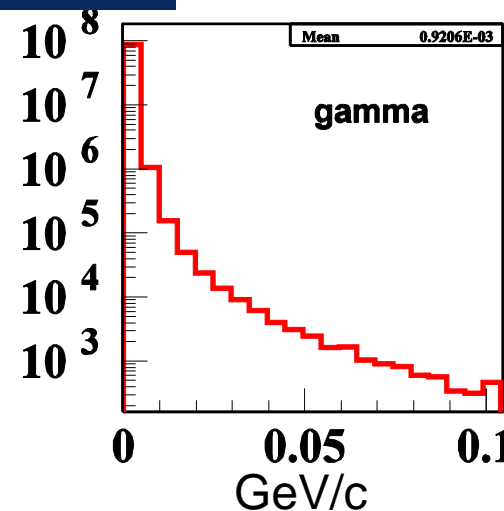



CONCLUDING REMARKS



Some Thoughts...

- The unique feature of muon accelerators is the ability to provide cutting edge performance on both the Intensity and Energy Frontiers
 - This is well-matched to the direction specified by the P5 panel for Fermilab
 - The possibilities for a staged approach make this particularly appealing in a time of constrained budgets
 - ν STORM would represent a critical first step in providing a muon-based accelerator complex
- World leading Intensity Frontier performance could be provided with a Neutrino Factory based on Project X Phase II
 - This would also provide the necessary foundation for a return to the Energy Frontier with a muon collider on U.S. soil
- **A Muon Collider Higgs Factory**
 - Would provide exquisite energy resolution to directly measure the width of the Higgs. This capability would be of crucial importance in the MSSM doublet scenario.

The first collider on the path to a multi-TeV Energy Frontier machine?

Conclusion

- Through the end of this decade, the primary goal of MAP is demonstrating the feasibility of key concepts needed for a neutrino factory and muon collider
- ⇒ Thus enabling an informed decision on the path forward for the HEP community

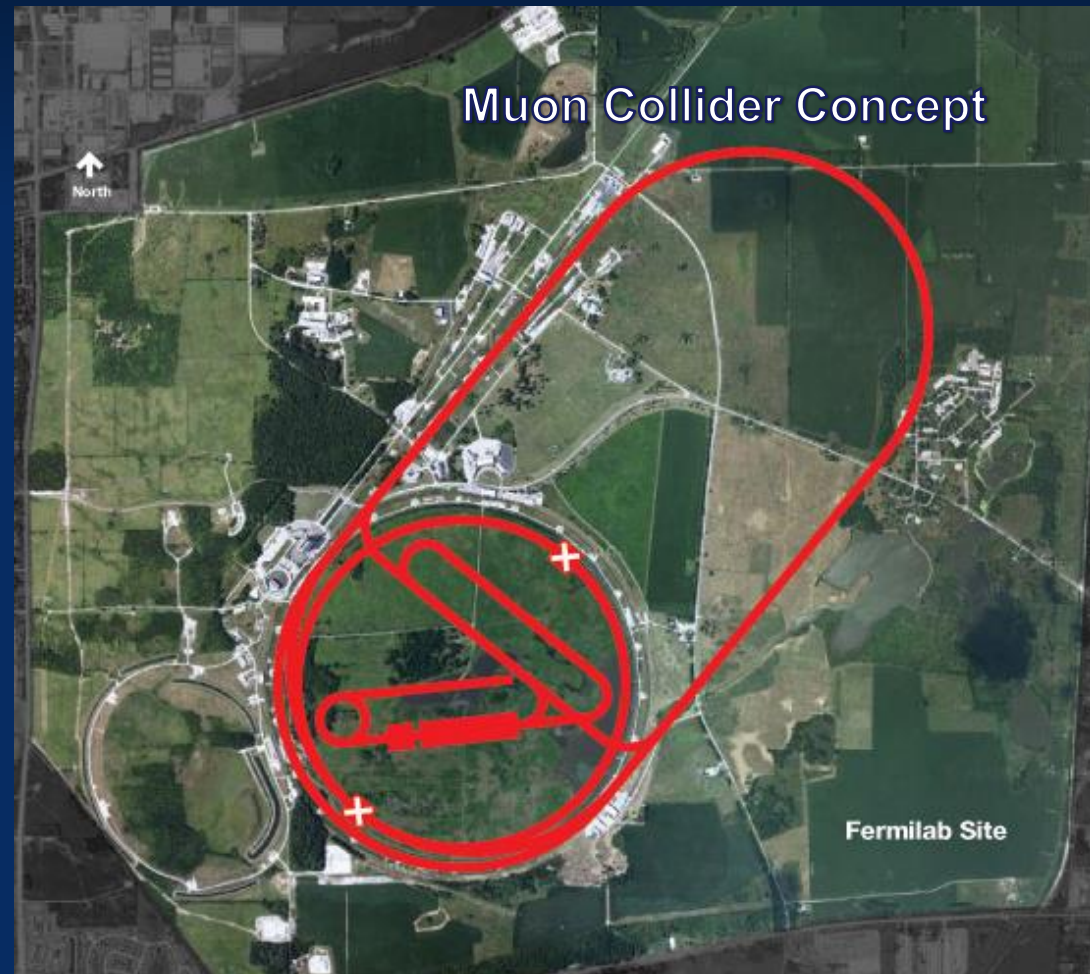

A challenging, but promising, R&D program is underway!

Muon Accelerator Program Contacts



- MAP Web-Site: <http://map.fnal.gov/>
- MAP Management Team:
 - Mark Palmer, Director: mapalmer@fnal.gov
 - Robert Ryne, L1 Manager for Design and Simulation: rdryne@lbl.gov
 - Alan Bross, L1 Manager for Technology Development: bross@fnal.gov
 - Daniel Kaplan, L1 Manager for Systems Demonstrations: kaplan@iit.edu
 - Ron Lipton, L1 Manager for Detectors and Physics: lipton@fnal.gov
- US HEP Community Planning Effort
 - Jean-Pierre Delahaye, Muon Accelerator Staging Study jpd@slac.stanford.edu

Acknowledgments



I would personally like to thank Steve Geer, Mike Zisman, Bob Palmer as well as the MAP L1 & L2 managers for their help in familiarizing me with the program since I took over as director a year ago

The MAP Effort -

- Labs: ANL, BNL, FNAL, JLAB, LBNL, ORNL, SLAC, IHEP-Beijing
- Universities: CMU, Chicago, Cornell, ICL, IIT, Princeton, SUNY-Stony Brook, UC-Berkeley, UCLA, UC-Riverside, UMiss, VT
- Companies: Muons, Inc; Particle Beam Lasers



BACKUPS



INTRODUCTION

Why a Muon Collider?



- First – why a lepton collider?
 - In proton (or proton-antiproton) collisions, composite particles (hadrons), made up of quarks and gluons, collide
 - The fundamental interactions that take place are between individual components in the hadrons
 - These components carry only a fraction of the total energy of the particles
 - For p-p collisions, the effective interaction energies are $O(10\%)$ of the total center-of-mass (CoM) energy of the colliding protons
 - Thus a 14 TeV CoM energy at the LHC probes an energy scale $E < 2$ TeV
 - Electrons (and positrons) as well as muons are fundamental particles (leptons)
 - Leptons are point-like particles
 - Their energy and quantum state are well understood during the collision
 - When the leptons and anti-leptons collide, the reaction products probe the full CoM energy
 - Thus a few TeV lepton collider can provide a precision probe of the full energy range of fundamental processes that are discovered at the LHC

Muon ($\mu^+\mu^-$) Colliders vs Electron-Positron Colliders (I)



- Now – why a muon collider?
- s-Channel Production
 - When 2 particles annihilate with the correct quantum numbers to produce a single final state. Examples:
 $e^+e^- \rightarrow Higgs$ **OR** $\mu^+\mu^- \rightarrow Higgs$
 - The cross section for this process scales as m^2 of the colliding particles, so:
$$\mathcal{S}(m^+m^- \rightarrow H) = \left(\frac{m_m}{m_e}\right)^2 \times \mathcal{S}(e^+e^- \rightarrow H) = \left(\frac{105.7 MeV}{0.511 MeV}\right)^2 \times \mathcal{S}(e^+e^- \rightarrow H)$$

$$\mathcal{S}(m^+m^- \rightarrow H) = 4.28 \times 10^4 \mathcal{S}(e^+e^- \rightarrow H)$$
 - Thus a muon collider offers the potential to probe the Higgs resonance directly
 - The luminosity required is not so large
 - A precision scan capability is particularly interesting in the case of a richer Higgs structure (eg, a Higgs doublet)

Muon ($\mu^+\mu^-$) Colliders vs Electron-Positron Colliders (II)



- Synchrotron Radiation

- In a circular machine, the energy loss per turn due to synchrotron radiation can be written as:

$$DE_{turn} = \left(\frac{4\rho mc^2}{3} \right) \left(\frac{r_0}{r} \right) b^3 g^4$$

where ρ is the bending radius

$$r \propto \frac{bg}{B} \Rightarrow DE_{turn} \propto Bg^3$$

- If we are interested in reaching the TeV scale, an e^+e^- circular machine is not feasible due to the large energy losses

Solution 1: e^+e^- linear collider

Solution 2: Use a heavier lepton – eg, the muon

Muon ($\mu^+\mu^-$) Colliders vs Electron-Positron Colliders (III)



• Beamstrahlung

- When electrons and positrons collide, the interaction of the particles in one beam with the electromagnetic fields of the other beam results in the radiation of photons (synchrotron radiation) \Rightarrow *beamstrahlung*
- This broadens the energy distribution of colliding particles and lowers the fraction of collisions that are near the nominal center-of-mass (CoM) energy
- The beamstrahlung effect is essentially negligible for a muon collider
 \Rightarrow most luminosity is produced near the nominal CoM energy

• Implications for a Higgs Factory

- With negligible beamstrahlung, it may be possible to directly probe the width of the Higgs
- Expected width of a standard Higgs is ~ 4.5 MeV
- 126 GeV muon collider lattices with $\Delta E/E \sim 3 \times 10^{-5}$ (3.8 MeV) have been designed

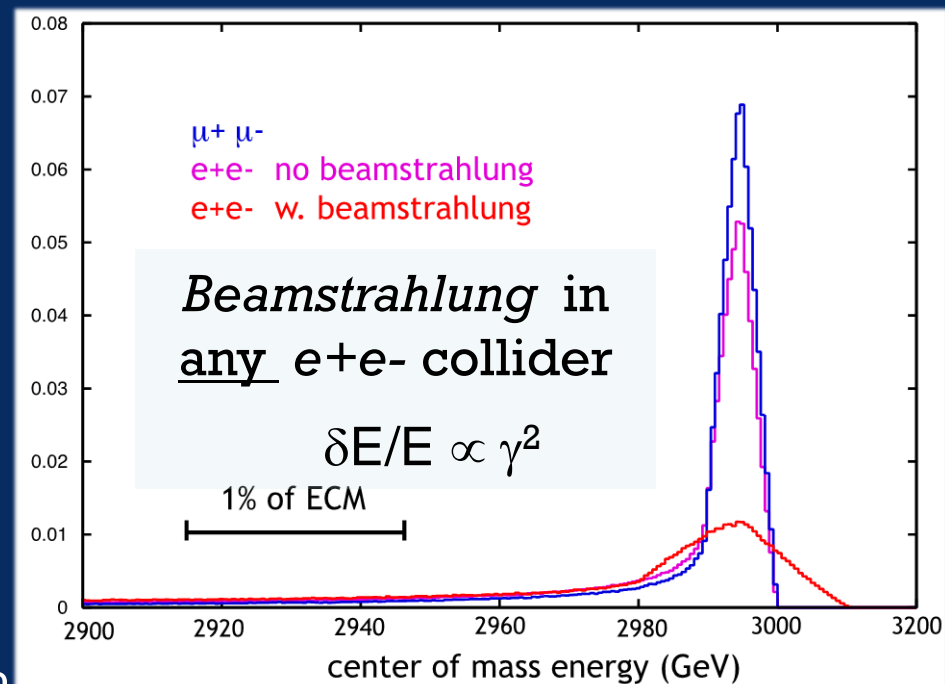

Circular Colliders vs Linear Colliders



- Circular machines offer a number of advantages
 - Many crossings at an interaction point
 - Luminosity multiplier
 - For a TeV-scale muon collider, expect to have $O(1000)$ crossings for each bunch
 - Multiple detectors can be used
 - Luminosity multiplier
 - Improved systematics understanding of the detectors
 - The additional integrated luminosity from multiple crossings allows larger transverse emittances than are needed for a linear collider. Machine tolerances become much easier
 - Acceleration can utilize multiple passes through the RF system
 - Overall, the beam and wall power for a circular machine can be significantly less than that for a linear collider

Ionization Cooling

- Muons cool via dE/dx in low- Z medium

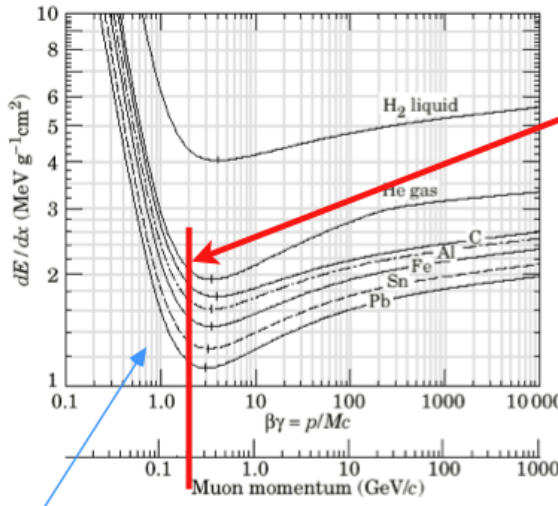
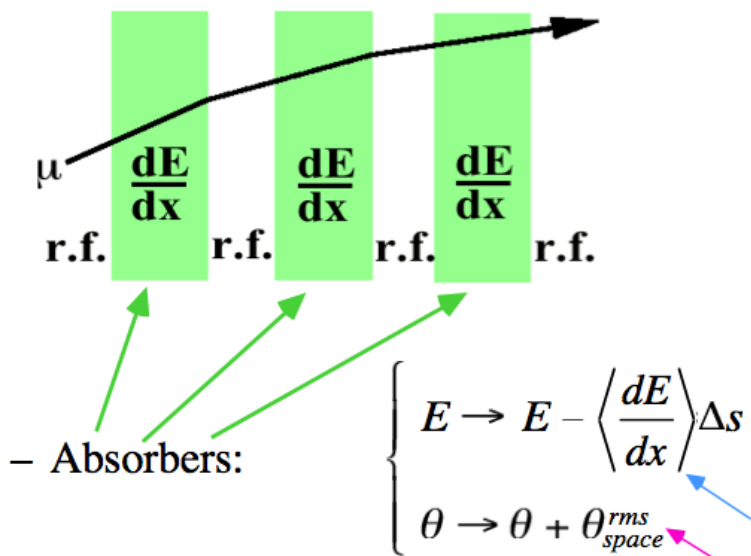

- ionization minimum is \approx optimal working point:
 - ▶ longitudinal +ive feedback at lower p
 - ▶ straggling & expense of reacceleration at higher p
- 2 competing effects \Rightarrow \exists equilibrium emittance

- Absorbers:
- RF cavities between absorbers replace ΔE
- Net effect: reduction in p_{\perp} at constant p_{\parallel} , i.e., transverse cooling

$$\frac{d\epsilon_N}{ds} \approx -\frac{1}{\beta^2} \left\langle \frac{dE_{\mu}}{ds} \right\rangle \frac{\epsilon_N}{E_{\mu}} + \frac{\beta_{\perp} (0.014 \text{ GeV})^2}{2\beta^3 E_{\mu} m_{\mu} X_0} \quad (\text{emittance change per unit length})$$

Facility Scales



- The footprint of a muon collider can be much smaller than other facilities
 - Provides for a more flexible site choice
 - Has the potential to provide cost savings in a fully engineered design

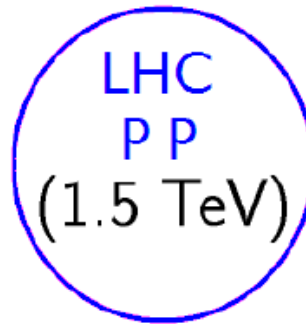

ILC e^+e^- (.5 TeV)

CLIC e^+e^- (3TeV)



10 km

Luminosity

- The principle parameter driver is the production of luminosity at a single collision point

$$\mathcal{L} = \frac{N^2 f_{coll}}{4\rho\sigma_x\sigma_y} \mathcal{H}_D \quad \text{Linear Collider Form}$$

- where

N is the number of particles per bunch (*assumed equal for all bunches*)

f_{coll} is the overall collision rate at the interaction point (IP)

σ_x and σ_y are the horizontal and vertical beam sizes (*assumed equal for all bunches*)

\mathcal{H}_D is the luminosity enhancement factor

- Ideally we want:
 - High intensity bunches
 - High repetition rate
 - Small transverse beam sizes

ILC Parameters at the Interaction Point

- The parameters at the interaction point have been chosen to provide a nominal luminosity of $2 \times 10^{34} \text{ cm}^{-2}\text{s}^{-1}$. With

$$N = 2 \times 10^{10} \text{ particles/bunch}$$

$$\sigma_x \sim 640 \text{ nm} \Leftrightarrow \beta_x^* = 20 \text{ mm}, \varepsilon_x = 20 \text{ pm-rad}$$

$$\sigma_y \sim 5.7 \text{ nm} \Leftrightarrow \beta_y^* = 0.4 \text{ mm}, \varepsilon_y = 0.08 \text{ pm-rad}$$

$$\mathcal{H}_D \sim 1.7$$

$$\mathcal{L} = \frac{N^2 f_{coll}}{4\rho S_x S_y} \mathcal{H}_D = \left(1.4 \times 10^{30} \text{ cm}^{-2}\right) f_{coll}$$

- An average collision rate of $\sim 14\text{kHz}$ is required.
- Beam sizes at the IP are determined by the strength of the final focus magnets and the emittance (phase space volume) of the incoming bunches.

A number of issues impact the choice of the final focus parameters. For example, the beam-beam interaction as two bunches pass through each other can enhance the luminosity, however, it also disrupts the bunches. If the beams are too badly disrupted, safely transporting them out of the detector to the beam dumps becomes quite difficult. Another effect is that of beamstrahlung which leads to significant energy losses by the particles in the bunches and can lead to unacceptable detector backgrounds. Thus the above parameter choices represent a complicated optimization.

Muon Collider Luminosity

- For a muon collider, we can write the luminosity as:

$$\mathcal{L} = \frac{N^2 f_{coll}}{4\rho s_x s_y} = \frac{\langle N^2 \rangle n_{turns} f_{bunch}}{4\rho s_{\wedge}^2}$$

- For the 1.5 TeV muon collider design, we have
 - $N = 2 \times 10^{12}$ particles/bunch
 - $\sigma_{x,y} \sim 5.9 \mu\text{m}$ \square $\beta^* = 10 \text{ mm}$, $\varepsilon_{x,y}(norm) = 25 \mu\text{m-rad}$
 - $n_{turns} \sim 1000$
 - $f_{bunch} = 15 \text{ Hz}$ (rate at which new bunches are injected)

$$\mathcal{L} \gg \frac{N_0^2 n_{turns} f_{bunch}}{4\rho s_{\wedge}^2} \gg 1.4 \cdot 10^{34} \text{ cm}^{-2} \text{ s}^{-1}$$

- But this is optimistic since we've assumed N is constant for ~ 1000 turns when it's actually decreasing. The anticipated luminosity for this case is $\sim 1.2 \times 10^{34} \text{ cm}^{-2} \text{ s}^{-1}$.

Challenges for a $\mu^+\mu^-$ Collider

- Create pions from a MW-scale proton beam striking a target
- To avoid excessive power requirements, must efficiently capture the produced pions
 - Capture of both forward and backward produced pions loses polarization
- The phase space of the created pions is ***very large!***
 - Transverse: 20π mm-rad
 - Longitudinal: 2π m-rad
- Emittances must be cooled by factors of 10^6 - 10^7 to be suitable for multi-TeV collider operation
 - ~1000x in the transverse dimensions
 - ~40x in the longitudinal dimension
- The muon lifetime is 2.2 μ s lifetime at rest

Cooling Options

- Electron/Positron cooling: use synchrotron radiation
 - ⇒ For muons $\Delta E \sim 1/m^3$ (*too small!*)
- Proton Cooling: use
 - A co-moving cold e- beam
 - ⇒ For muons this is too slow
 - Stochastic cooling
 - ⇒ For muons this is also too slow
- Muon Cooling: use
 - Use Ionization Cooling
 - ⇒ Likely the only viable option
 - Optical stochastic cooling
 - ⇒ Maybe, but far from clear

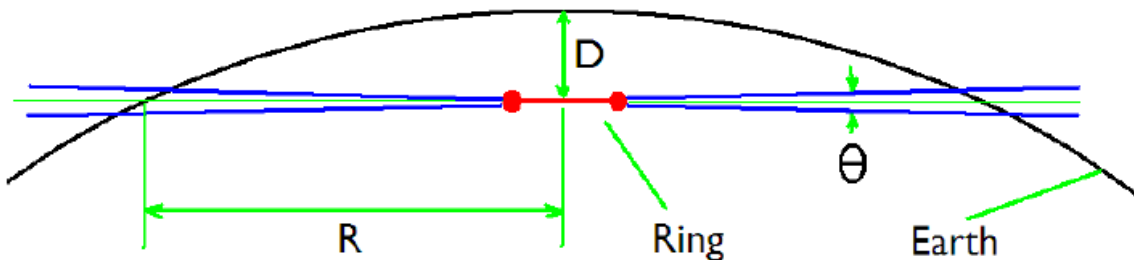

$$\text{Radiation} \propto \frac{E_{\mu} I_{\mu} \sigma_{\nu}}{\theta R^2} \propto \frac{I_{\mu} \gamma^3}{D}$$

$$\text{Radiation} \propto \frac{\mathcal{L} \beta_{\perp}}{\Delta\nu \langle B \rangle} \frac{\gamma^2}{D} \quad (6)$$

For fixed $\Delta\nu$, β_{\perp} and $\langle B \rangle$; and $\mathcal{L} \propto \gamma^2$:

$$\text{Radiation} \propto \frac{\beta_{\perp}}{\Delta\nu \langle B \rangle D} \gamma^4 \quad (7)$$

For 3 TeV: $D=135$ m $R=40$ Km $\beta_{\perp}=5$ mm

R. Palmer