

STAR Upgrade Program and Future Physics

The 30th Winter Workshop on Nuclear Dynamics, April 6-12 2014

Yaping Wang
for the STAR Collaboration
(University of Illinois at Chicago)

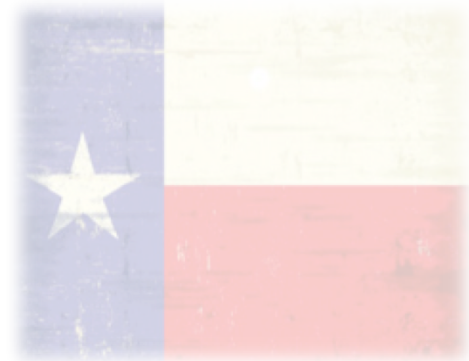



Outline

- Introduction
- Ongoing Upgrades and Physics Goals
 - Heavy Flavor Tracker (2014+)
 - Muon Telescope Detector (2014+)
- Upgrade Program and Future Physics
 - Inner TPC Sector Upgrade for BES II Program (2018-19)
 - Forward Upgrade for $p_{\uparrow}p_{\uparrow}$ and $p_{\uparrow}A$ Program (2021-22)
 - Forward Upgrade for eSTAR Program (2025+)
- Summary

STAR Physics Focus

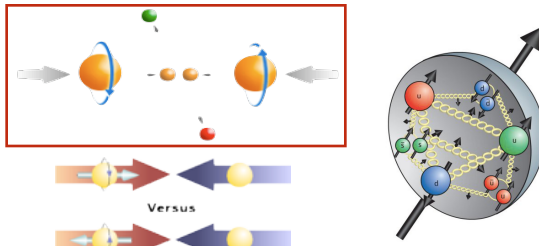

Polarized $p+p$ program

- Study *proton intrinsic properties*
- **QCD**

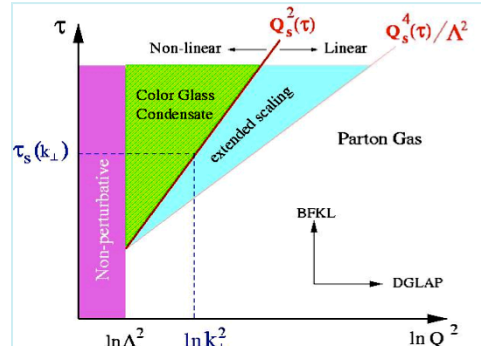

Forward program

- Study low-x properties, initial condition, search for **CGC**
- Study elastic and inelastic processes in pp2pp

2025 -
eRHIC

(eSTAR)

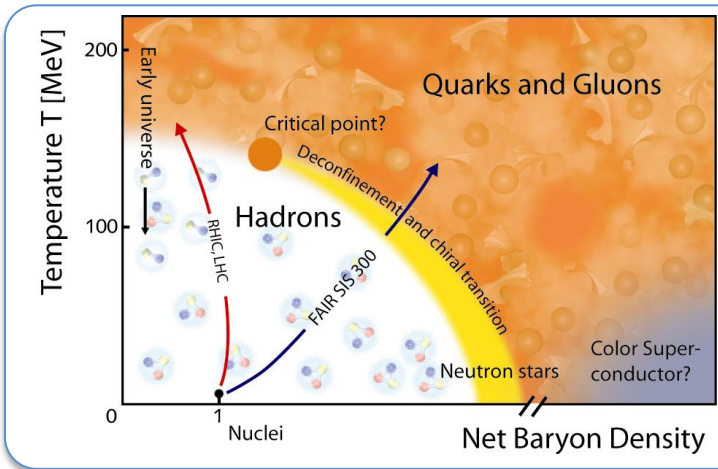

1) At 200 GeV at RHIC

- Study *medium properties, EoS*
- pQCD in hot and dense medium

2) RHIC beam energy scan (BES)

- Search for the **QCD critical point**
- Chiral symmetry restoration



The STAR Experiment (2014+)

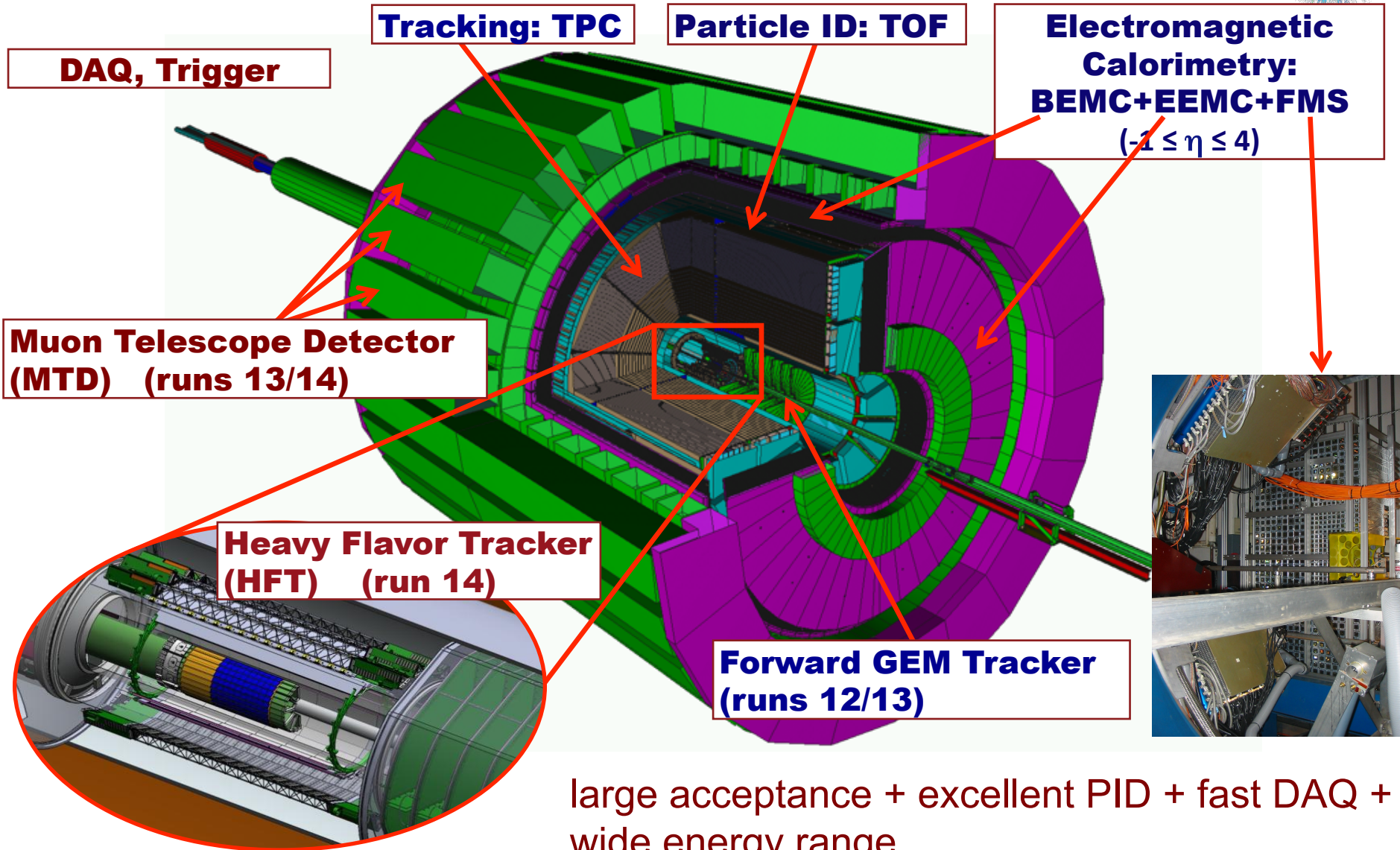

HFT Design and Physics Motivation

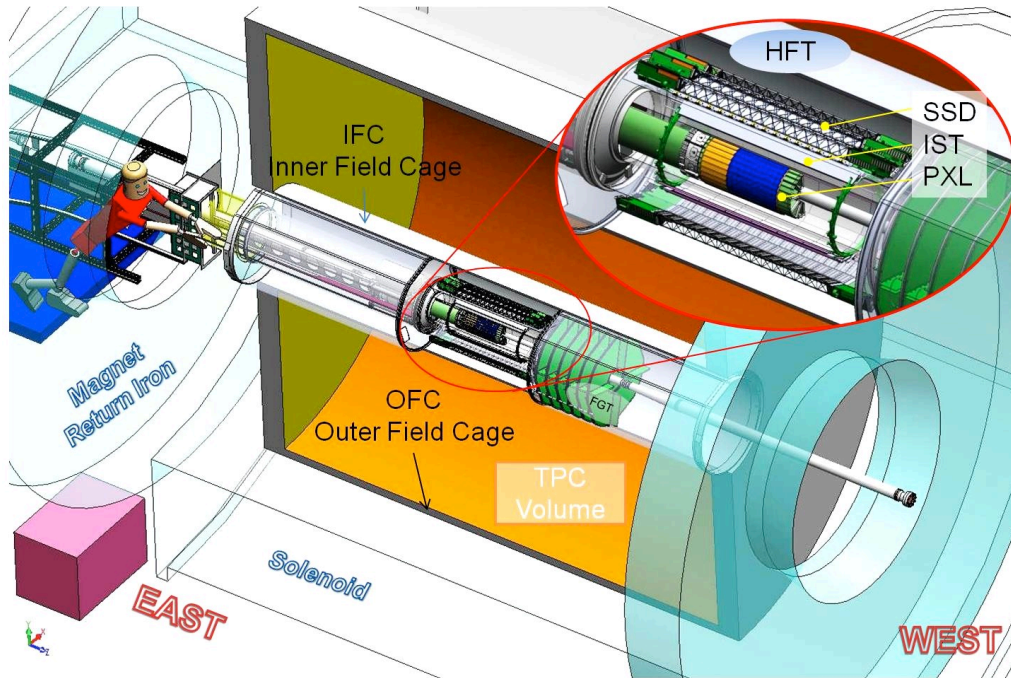

Detector	Radius (cm)	Hit Resolution $R/\varphi - Z$ ($\mu\text{m} - \mu\text{m}$)	Radiation length
SSD	22	20 / 740	1% X_0
IST	14	170 / 1800	<1.5% X_0
PIXEL	8	12 / 12	0.6% X_0
	2.7	12 / 12	0.4% X_0

PXL: MAPS, 360M pixels

IST+SSD: Silicon strip detector, guiding track from TPC to PXL

HFT will greatly enhance the capability of STAR for heavy flavor studies (**energy loss mechanism, partonic thermalization**), allowing identification of displaced vertices and direct topological reconstruction of open charm hadrons.

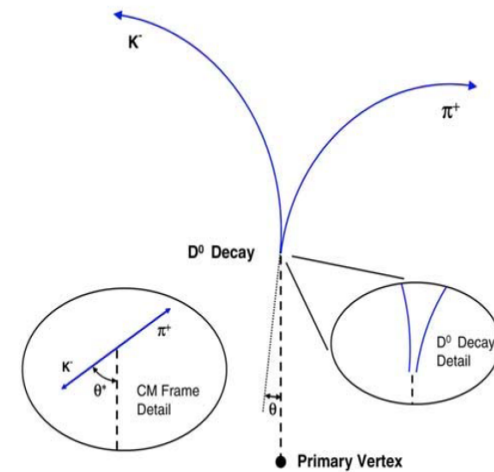

$$D^0 \rightarrow K^- \pi^+, \tau \sim 120 \mu\text{m}$$

Charm Quark Energy Loss (Run 14+)

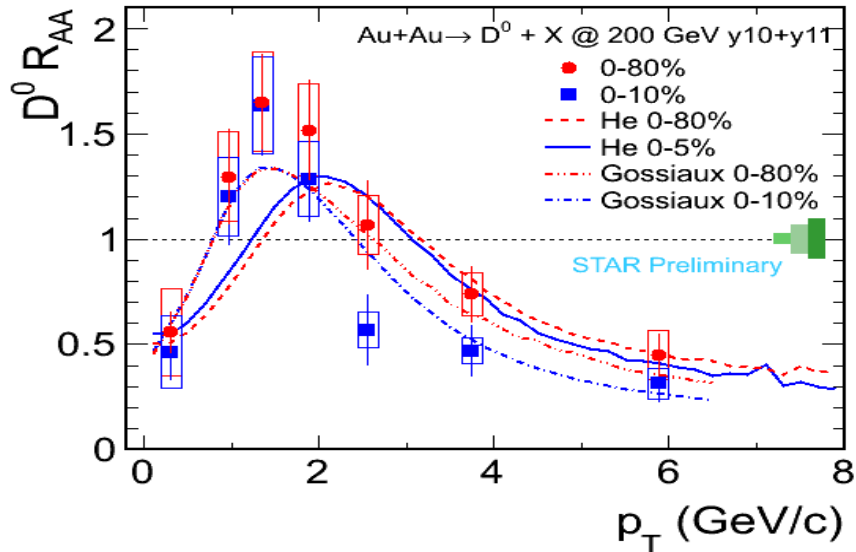

- Suppression at high p_T in central and mid-central collisions
- Much better precision with HFT than current STAR measurement

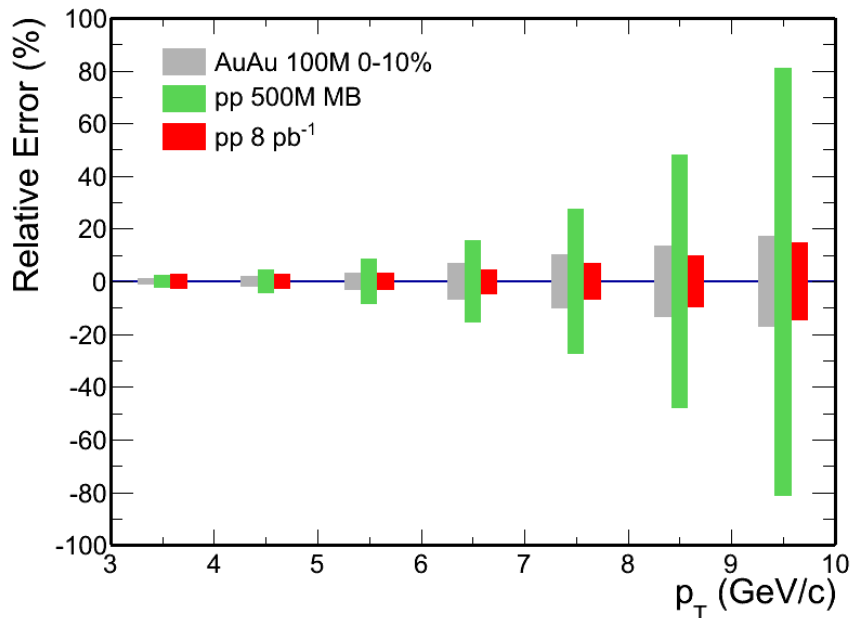

Assuming $D^0 R_{AA}$ distribution as charged hadron.

100M Au+Au 0-10% events at 200 GeV.

- Charm $R_{AA} \Rightarrow$

Energy loss mechanism!

Color charge effect!

Interaction with QCD matter!

STAR projection with HFT

Charm Flow (R14/15)

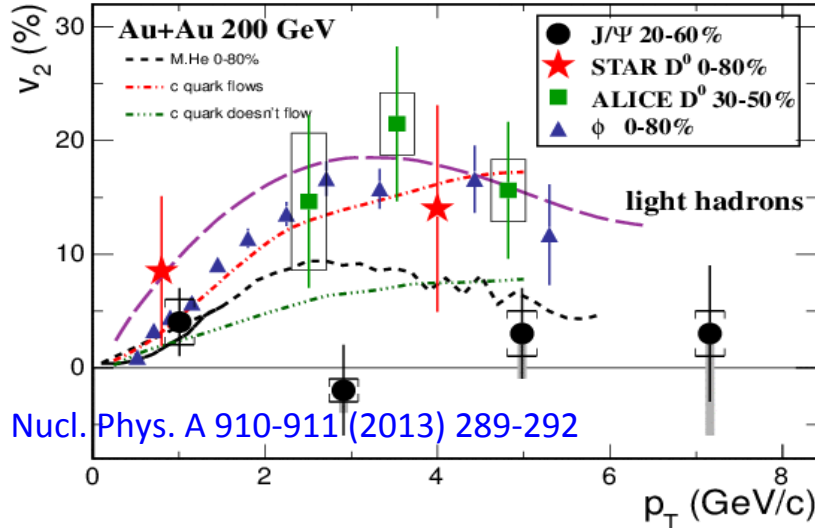

- Finite v_2 observed with large errors
- Much better precision with HFT than current STAR measurement. This helps one to confirm:
 - ◆ The coalescence scenarios
 - ◆ The energy dependence

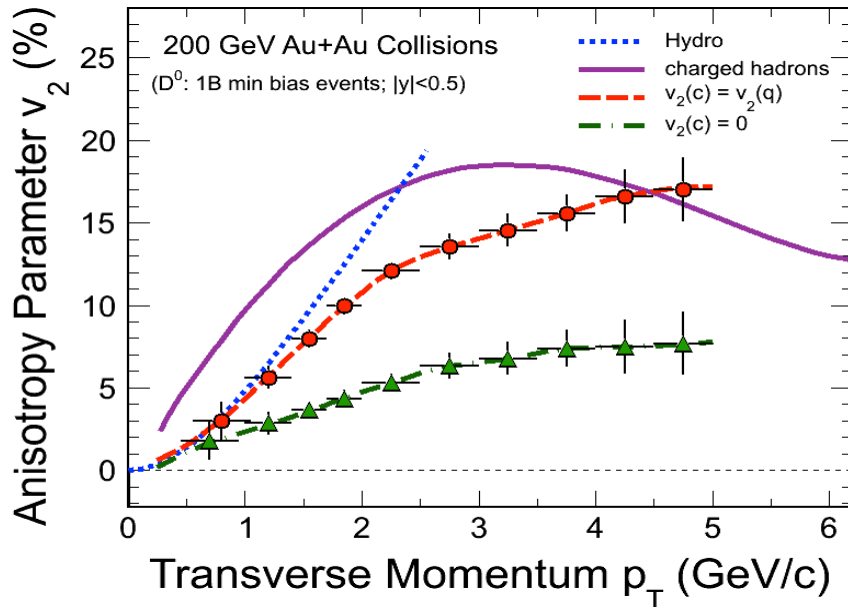

Assuming D⁰ v_2 distribution from quark coalescence.

1B Au+Au m.b. events at 200 GeV.

- Charm v_2 ⇒

Medium thermalization degree

Drag coefficients!

STAR projection with HFT

B Meson (Run 14/15)

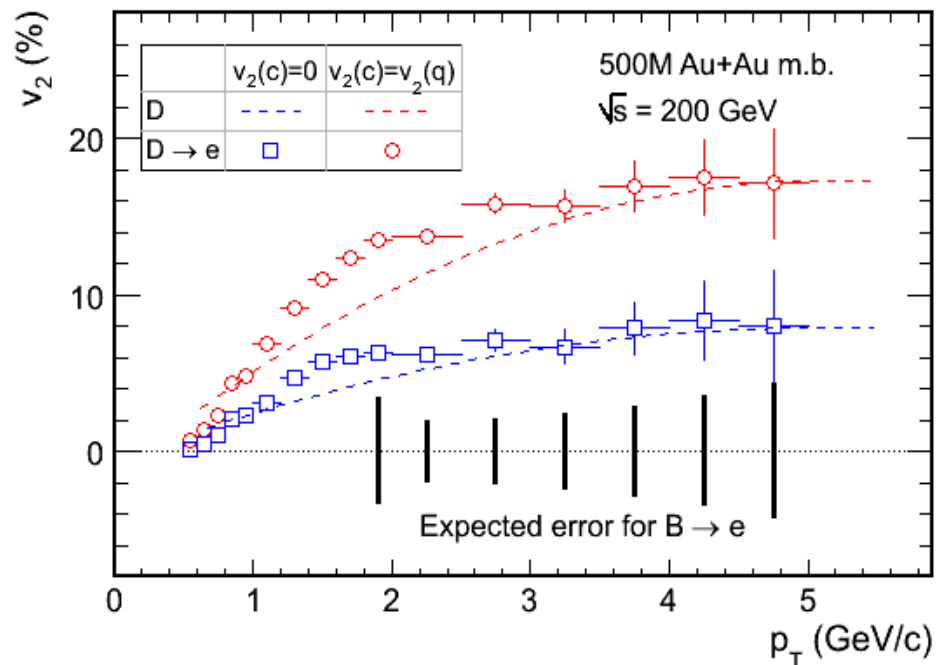
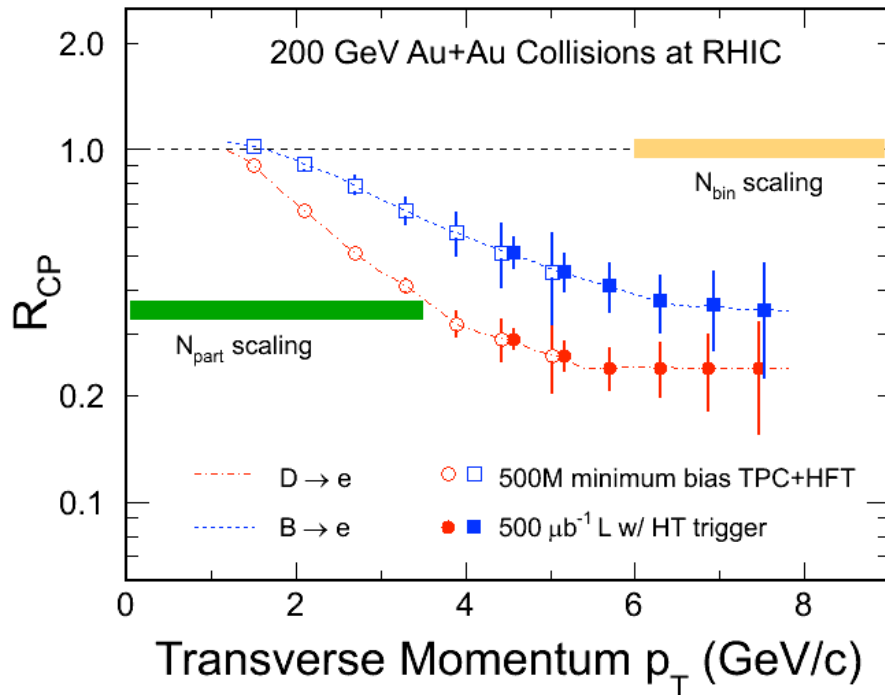

STAR projection with HFT

- (B \rightarrow e) spectra obtained via the subtraction of charm decay electrons from inclusive Non-Photonic Electrons:
 - **no model dependence, reduced systematic errors.**
- Unique opportunity for bottom e-loss and flow.
 - **Charm may not be heavy enough at RHIC, but how is bottom?**

HFT Installation in 2013/2014

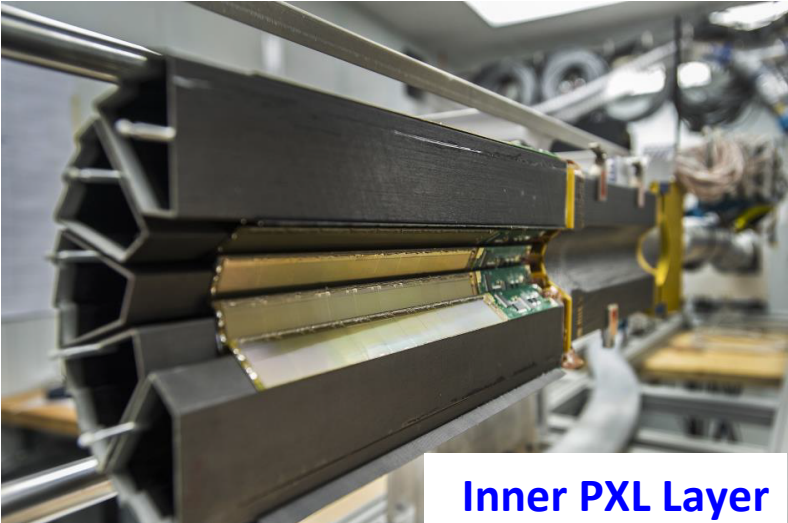

Inner PXL Layer

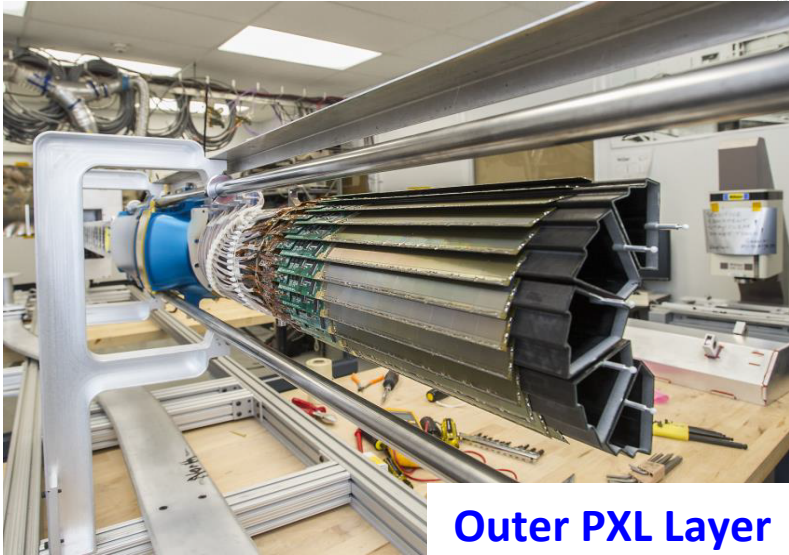

Outer PXL Layer

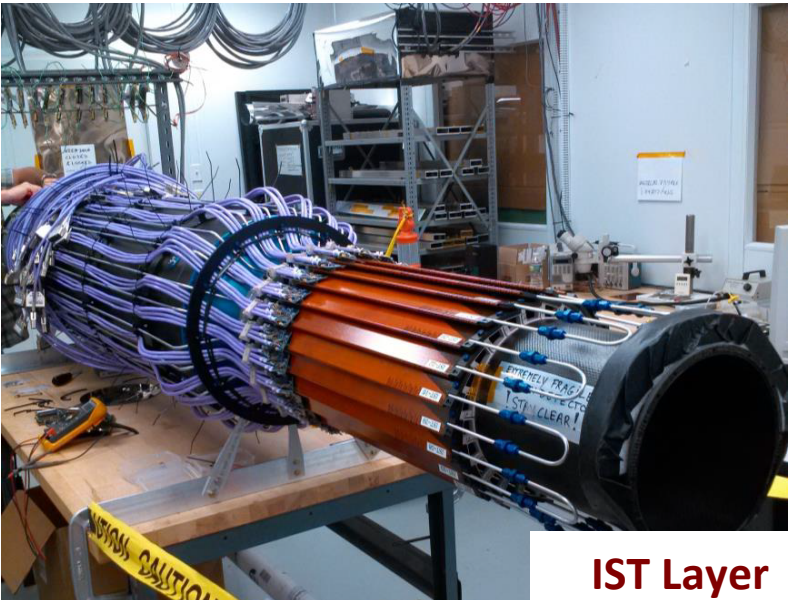

IST Layer



SSD Layer

HFT Commissioning in 2014

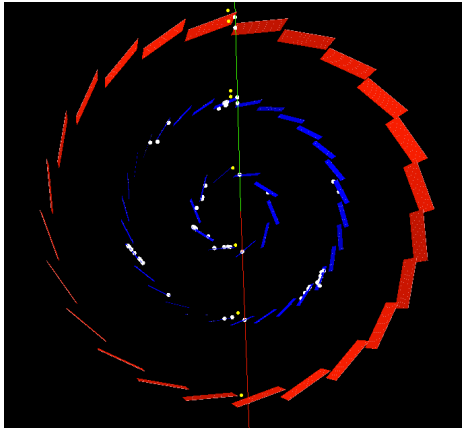

Cosmic run

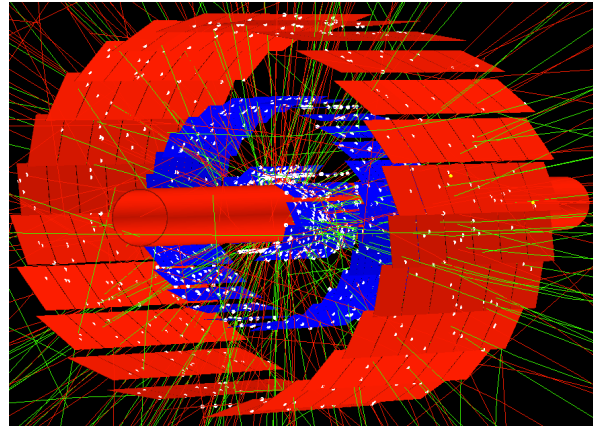

Au+Au @ 15 GeV

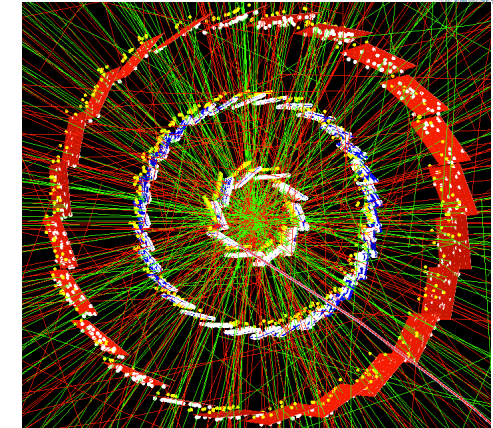

Au+Au @ 200 GeV

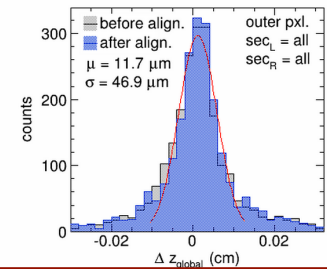
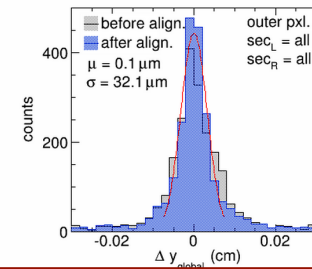
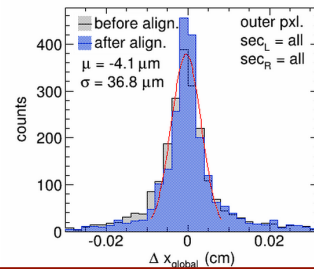
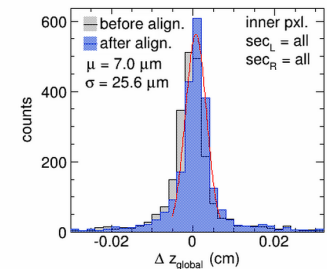
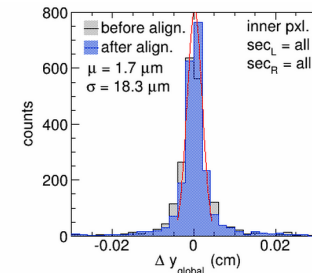
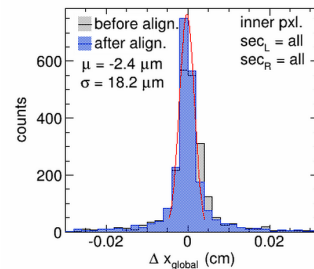
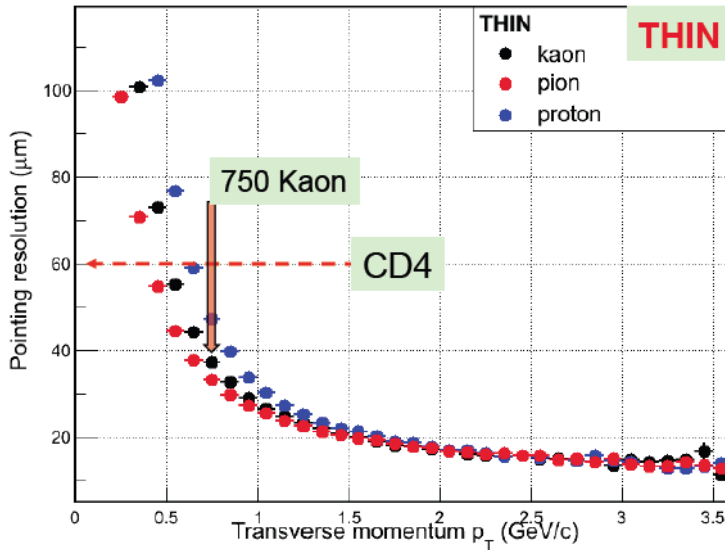

Using alignment deduced from cosmic data sector half pointing resolution of 20/40 μm was observed

MTD Design and Physics Motivation

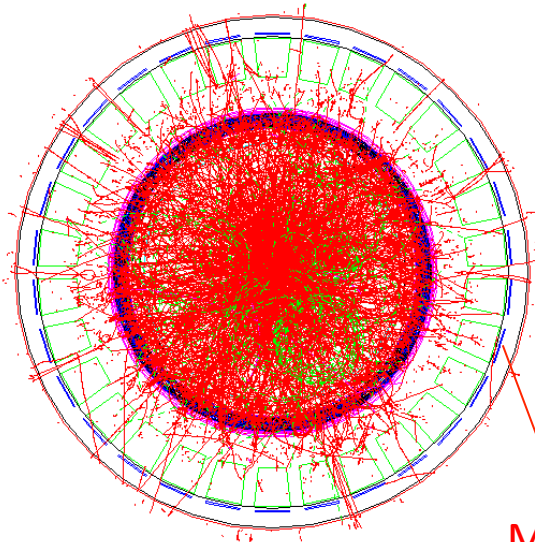

MTD

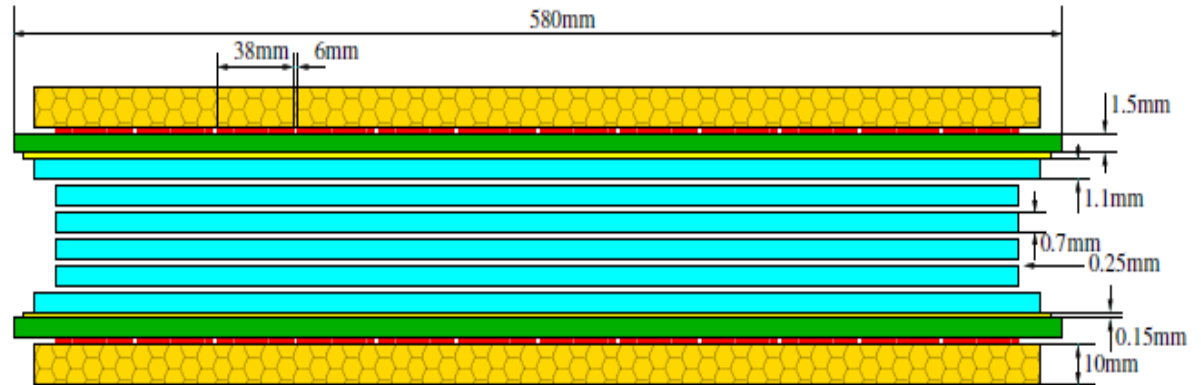

- Multi-gap Resistive Plate Chamber (MRPC)
 - Gas detector, avalanche mode
- Acceptance: 45% at $|\eta| < 0.5$
- Electronics same as used in STAR-TOF

MTD enables the detection of and online triggering of muons over a large phase space:

- **Di-muon pairs:** quarkonia, light vector mesons
- **Single muon:** semi-leptonic decays of heavy flavor hadrons



Trigger capability for low p_T J/ψ in central Au+Au collisions

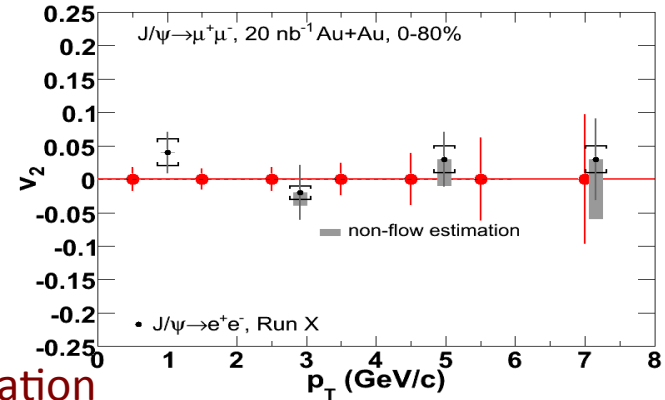
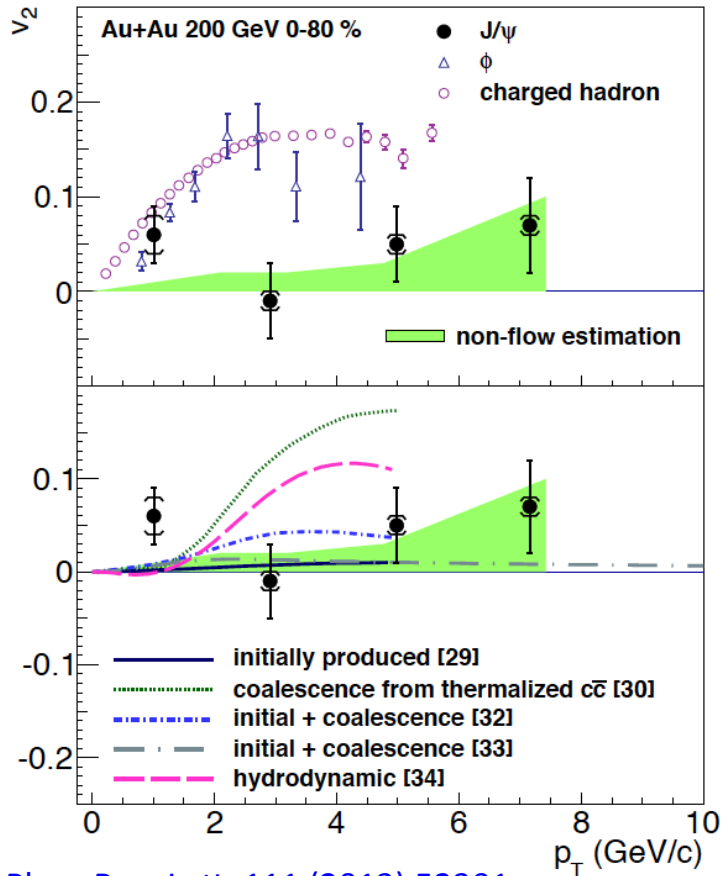

Simulation
with MTD

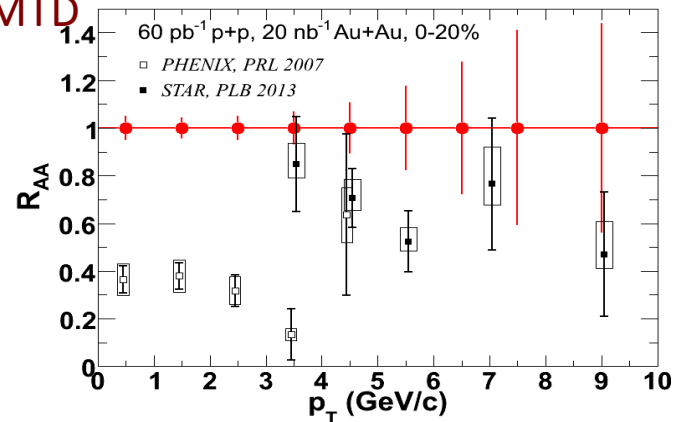

Phys. Rev. Lett. 111 (2013) 52301

Much better precision with MTD via di-muon channel than current STAR measurements

Quarkonia from MTD

Excellent mass resolution, separate different upsilon states

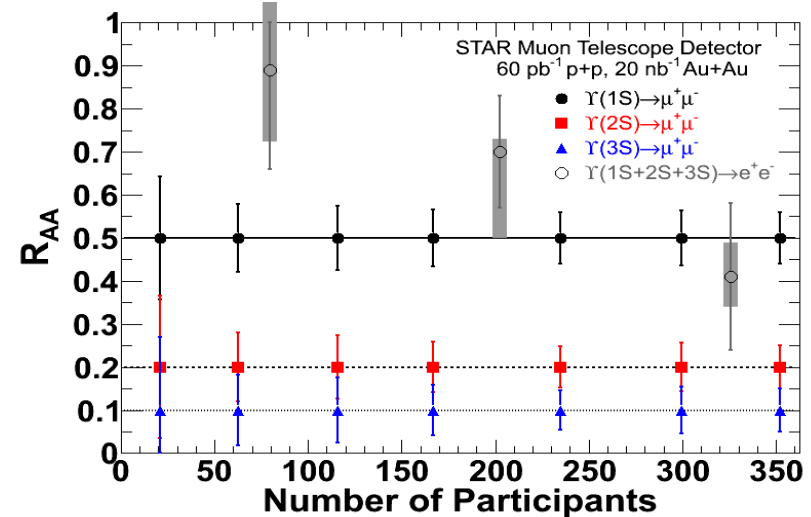
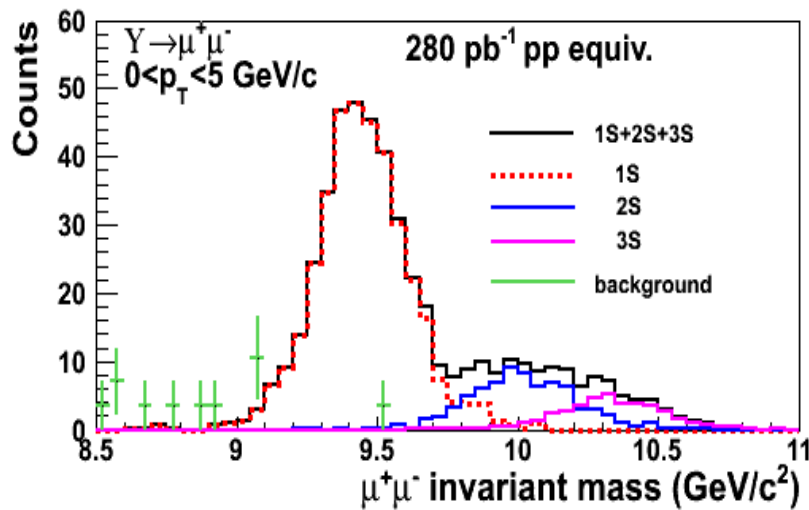

Simulation with MTD

- Sequential suppression of different Υ states can be used as a QGP thermometer
- Di-muon channel with MTD is less affected by bremsstrahlung energy losses, enabling separating different Υ states.

e- μ correlation from MTD

e- μ correlation to distinguish heavy flavor production from initial lepton pair production

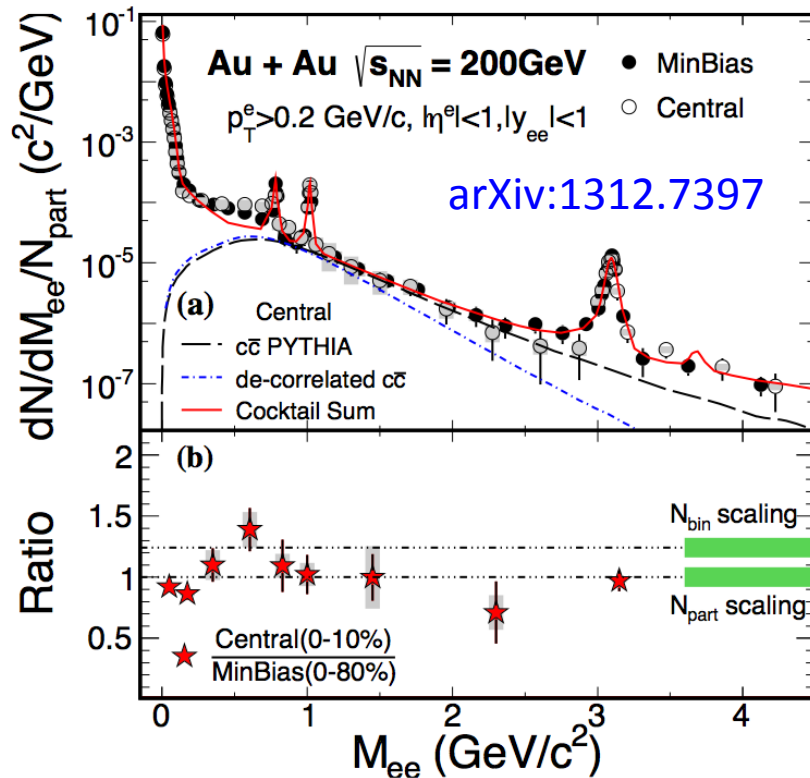

This measurements allow us to access the QGP thermal radiation contribution in the intermediate mass region (IMR).

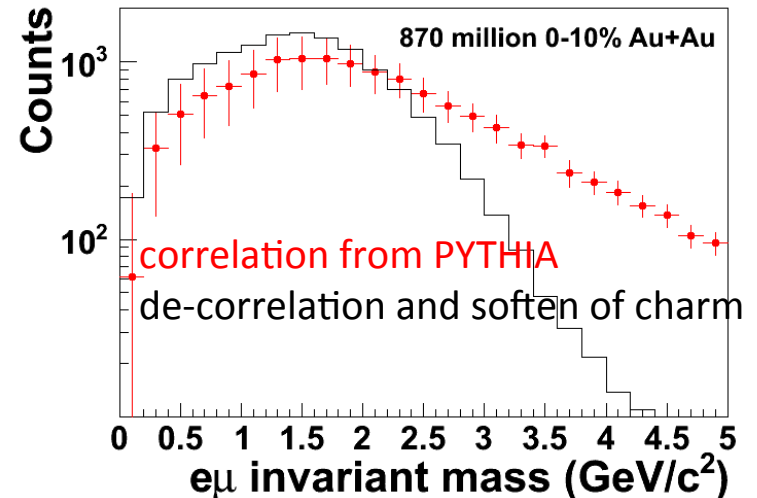
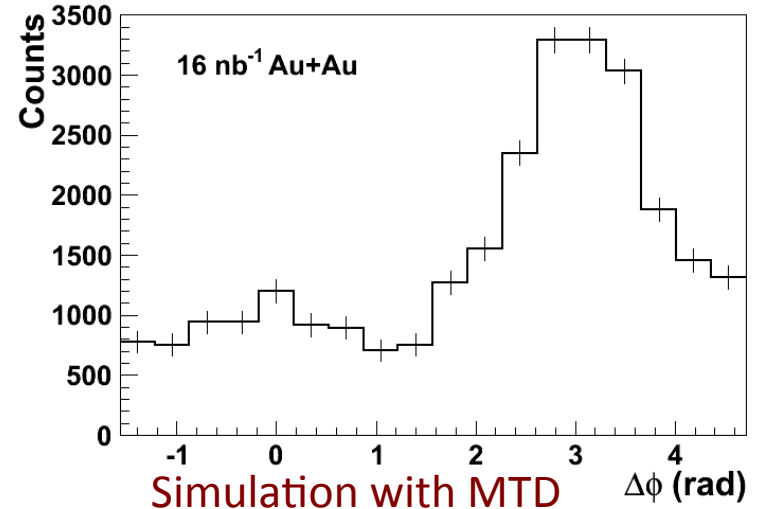

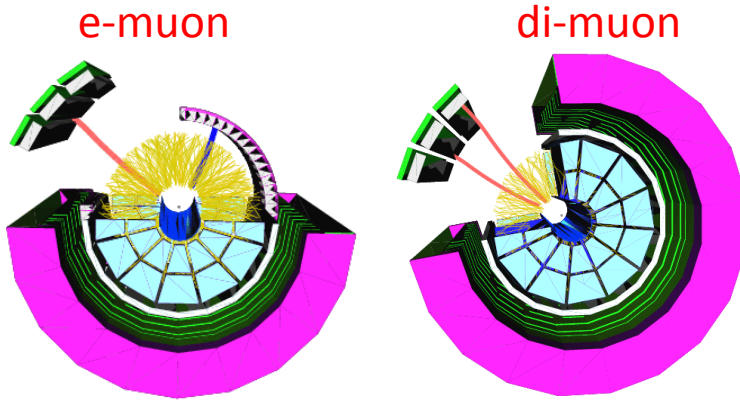

- Commissioned single muon, e-muon and di-muon triggers (event display for Cu+Au collisions in 2012)
- Intrinsic timing resolution: < 100 ps
- Status:
2012 – 10%, 2013 – 63%, 2014 – 96-100%

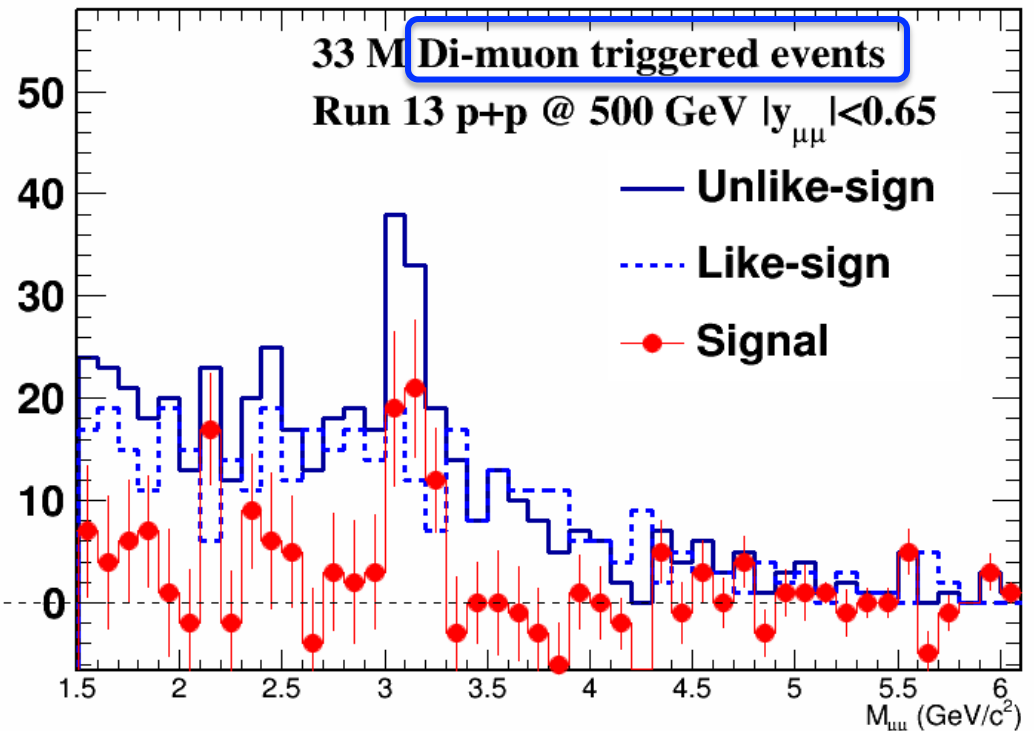
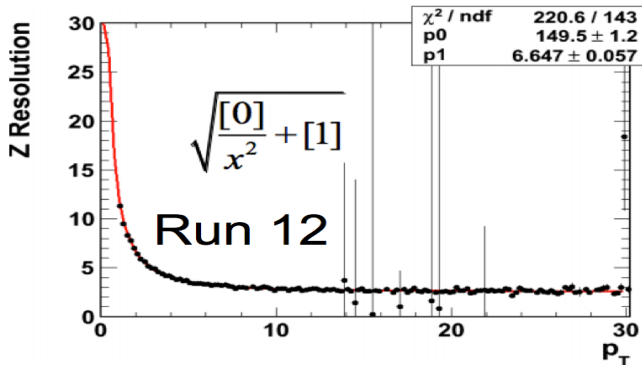
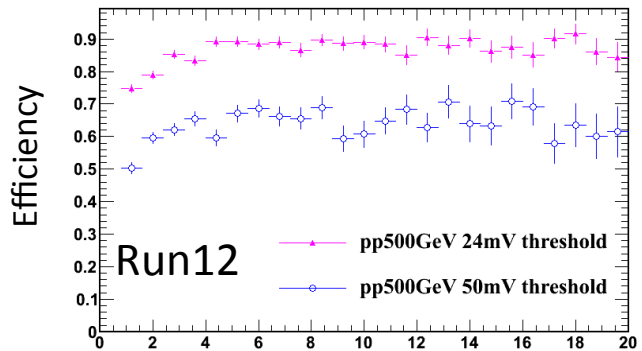

Beam Energy Scan II (2018-19)

Heavy-ion collisions allow one to explore QCD phase structure by varying collision energy. **Three Goals of BES program:**

- Turn-off of QGP signatures
- Find QCD critical point
- First order phase transition

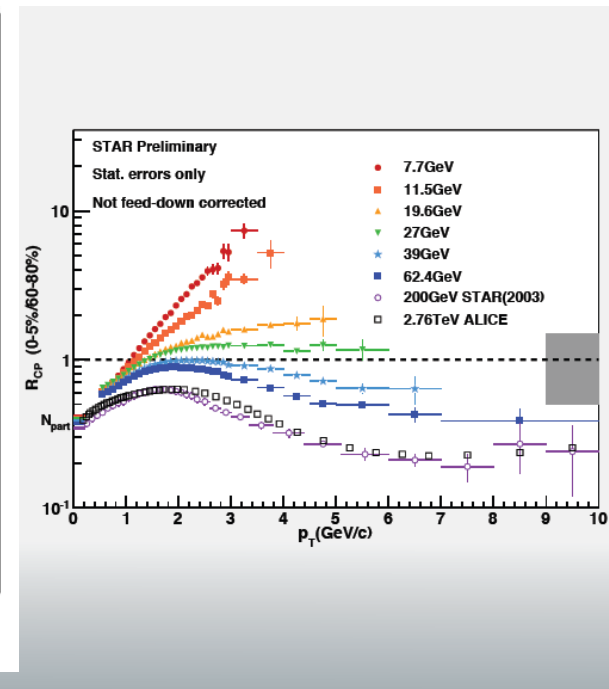
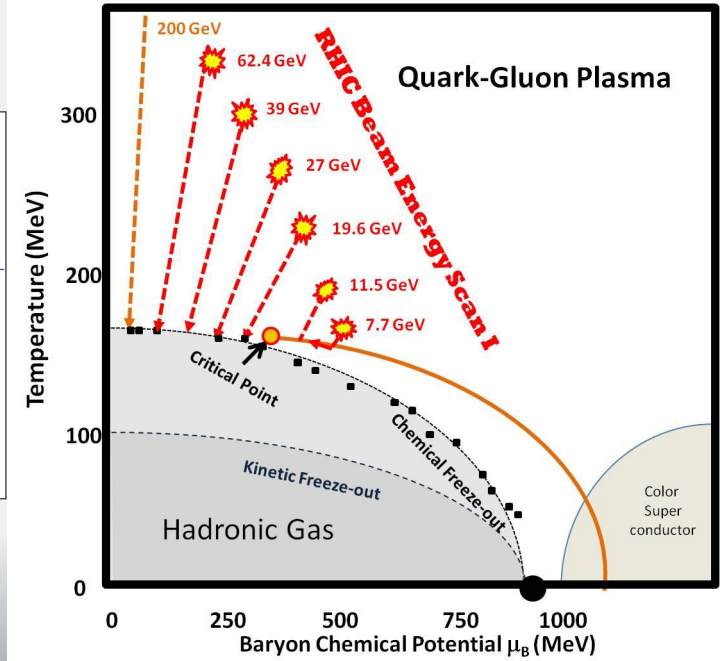
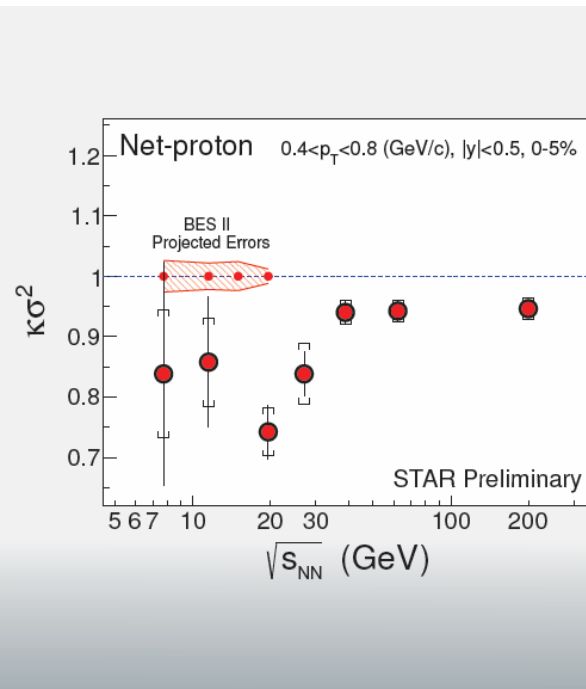

BES II requires upgrade for current TPC to have a better acceptance in η and p_T

iTPC Upgrade for BES II

Current Inner sector limitations:

- Current pad plane layout with 13 rows and gaps
 - ✧ only 13 maximum possible points
 - ✧ only reads ~20% of possible gas path length
 - Inner sectors essentially not used in dE/dx
- Essentially limits effective acceptance to $|\eta| < 1$

Upgrade:

- Fill all inner sector with active pads
- renew the inner sector wires which are showing signs of ageing
- Need ~ 85000 channels
- Ready for physics in Dec. 2017

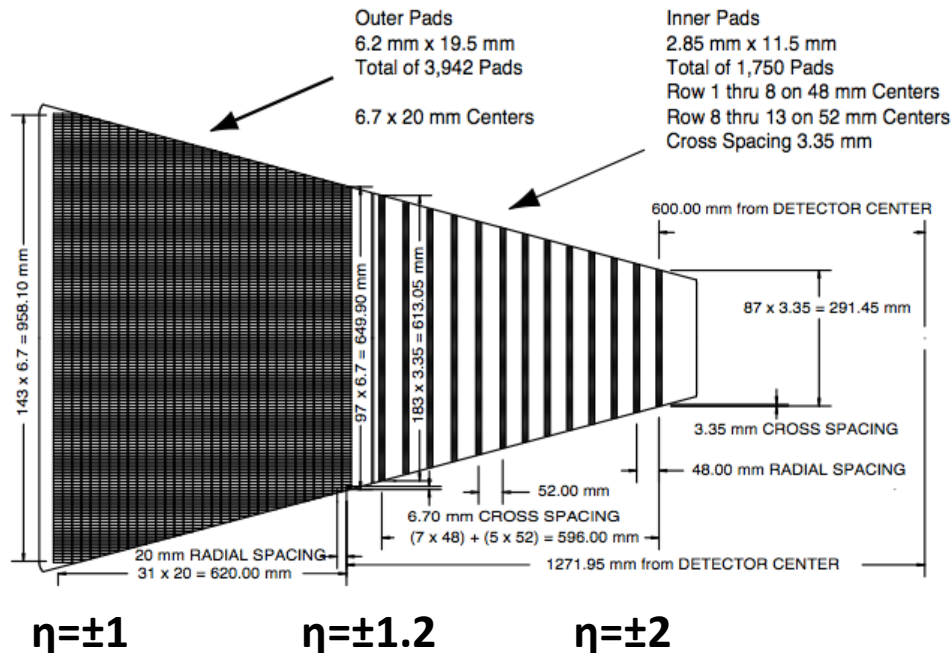

The iTPC will provide **better momentum resolution, better dE/dx resolution, higher track reconstruction efficiency and improved acceptance at high η region.**

This upgrade is essential to BES II program, and will benefit STAR's future program with pp/pA and ep/eA collisions.

iTPC Upgrade for BES II

Simulation of improved acceptance in p_T and η for reconstructed pion, kaon and protons

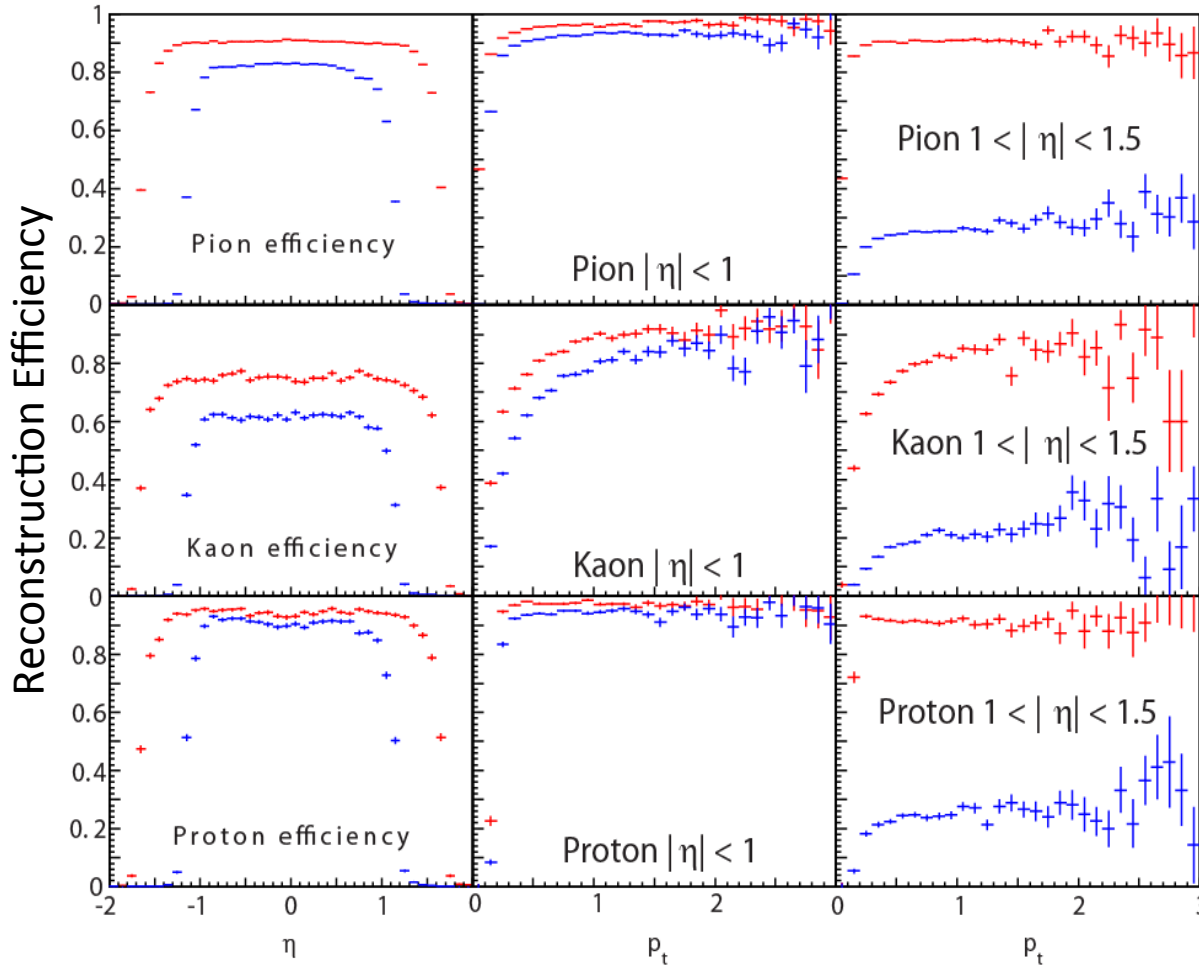

Red points: iTPC Blue points: TPC

Simulation of improved dE/dx resolution

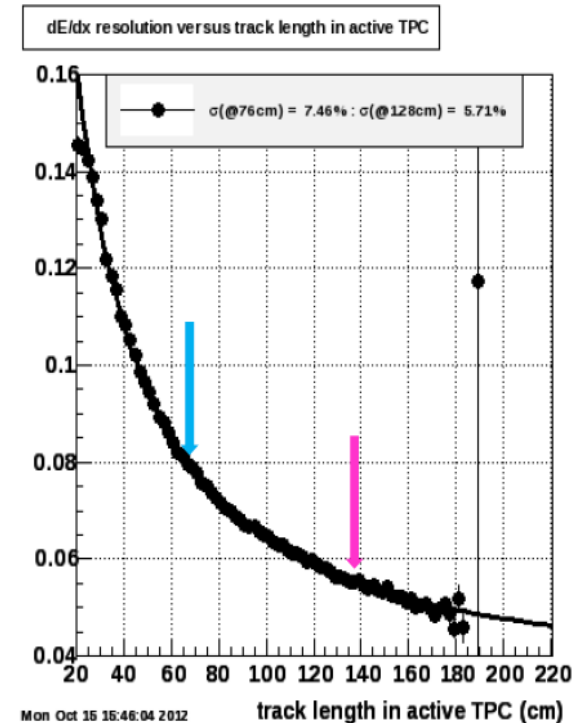



STAR $p_{\uparrow}p_{\uparrow}/p_{\uparrow}A$ Program (2021-22)

Planned $p_{\uparrow}p_{\uparrow}/p_{\uparrow}A$ measurements:

- Forward photon/electron/jet/leading hadron (energy loss in cold nuclear matter)
- Forward transverse spin dynamics (transversity function and Collins FF, twist-3) and longitudinal spin physics (ΔG)
- Drell-Yan and forward-forward correlations via h-h, Y-h and jet-jet (initial conditions, gluon saturation)

$p_{\uparrow}p_{\uparrow}/p_{\uparrow}A$ program requires upgrade at forward region:

- Uniquely address physics near/cross the saturation region/boundary
- Full azimuthal angle coverage
- e/h identification
- Charged hadron and jet reconstruction
- Prompt photons
- Polarized beam

Forward Upgrade for $p \uparrow p \uparrow / p \uparrow A$ Program

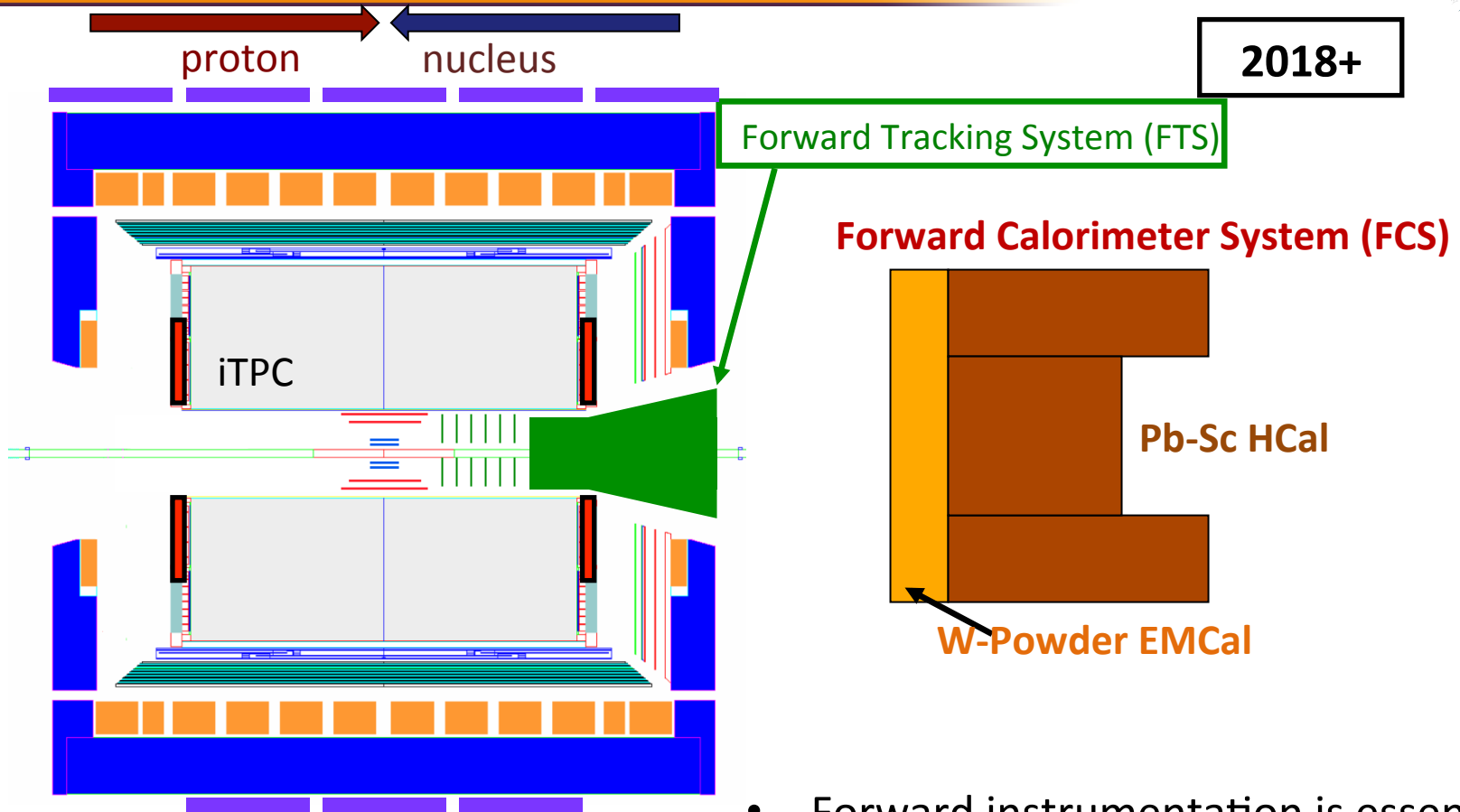

2018+

pA specific upgrades:

- Forward EM+Had Calorimeter System (FCS)
- Forward GEM or Si Tracking System (FTS)

- Forward instrumentation is essential for $p \uparrow p \uparrow$ and $p \uparrow A$ physics
 - Charged-particle tracking
 - e/h and γ/π^0 discrimination

Forward Upgrade for $p \uparrow p \uparrow / p \uparrow A$ Program

Schedule: Ready for data 2017 at the earliest

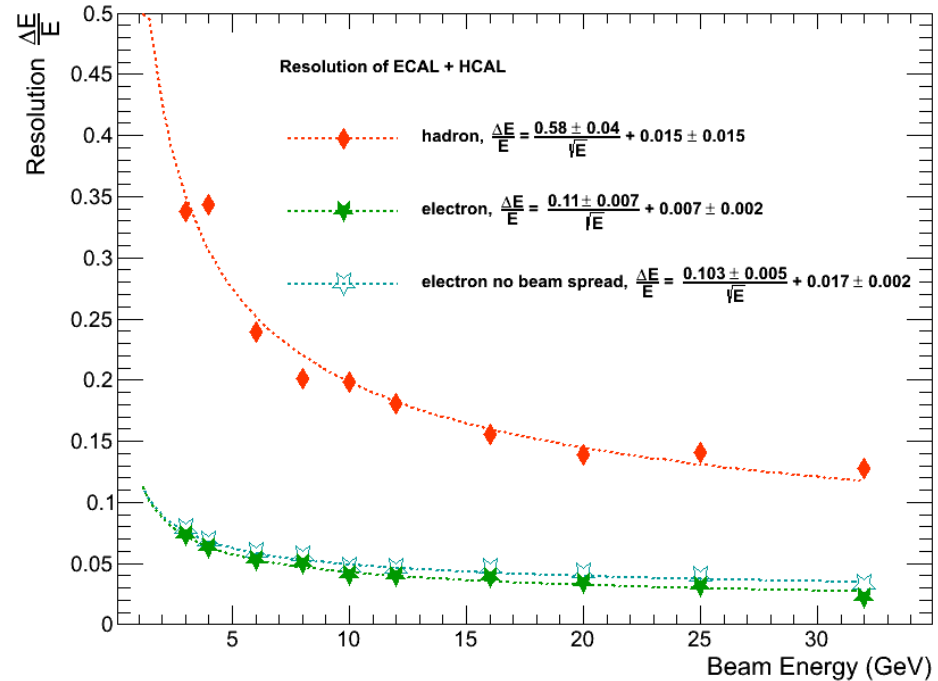
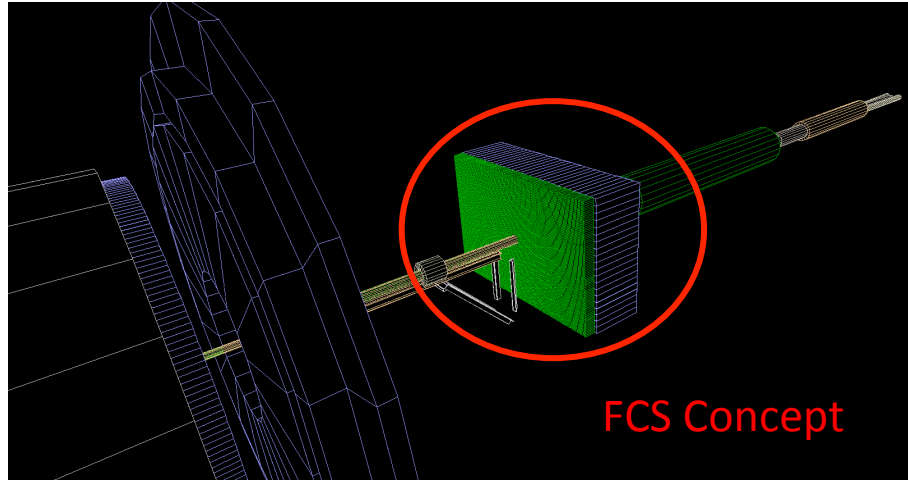

https://drupal.star.bnl.gov/STAR/system/files/STAR_pA_03282014.pdf

Measured the resolution of the combined ECAL and HCAL system for beam energies between 3 GeV and 32 GeV.

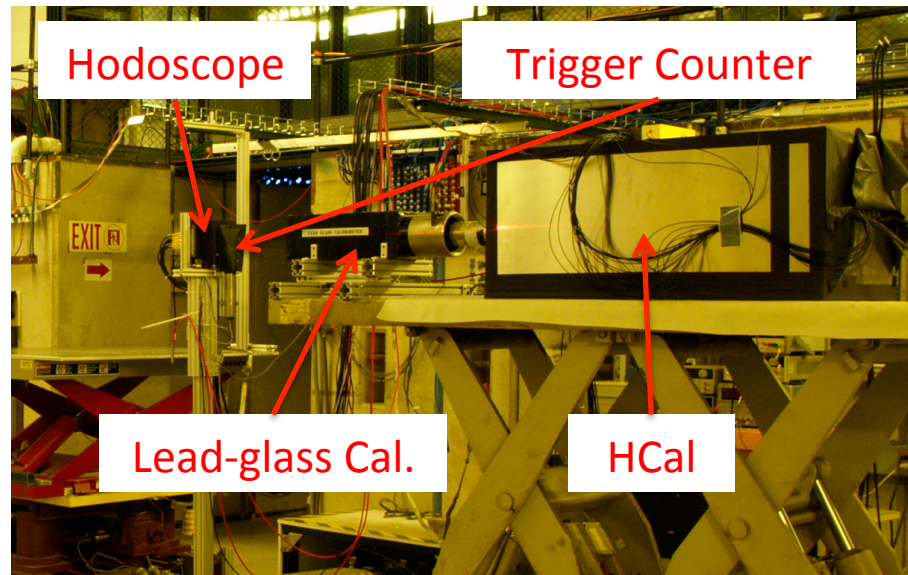

Physics Deliverables (EIC white paper)

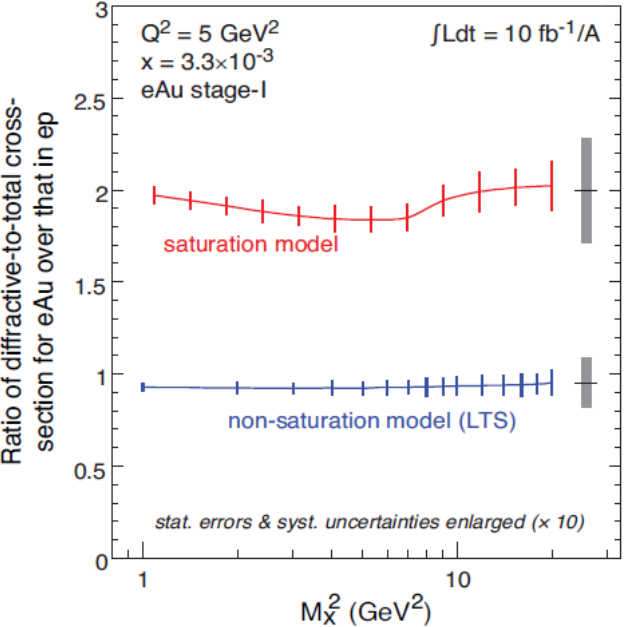
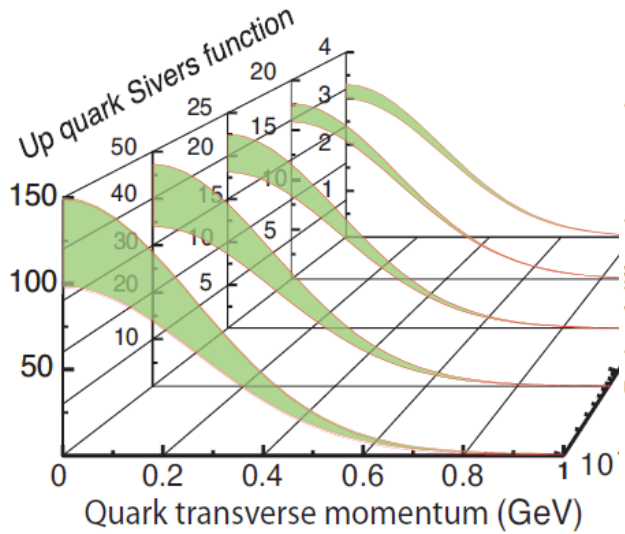
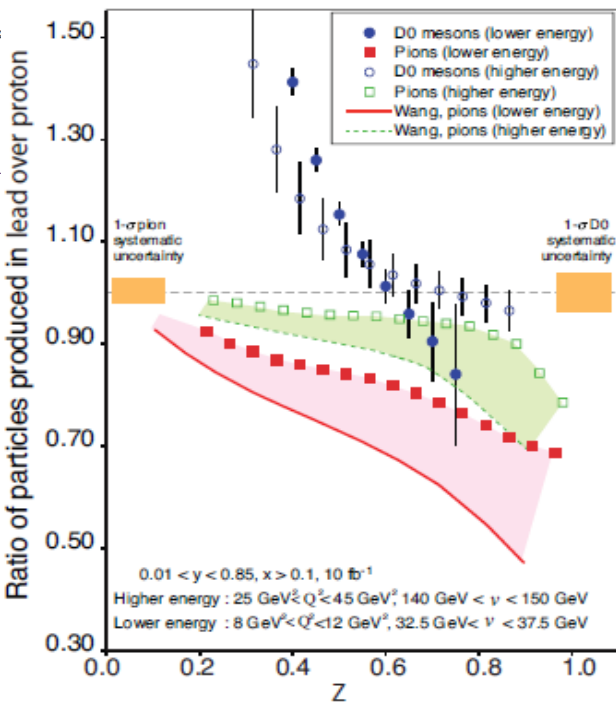
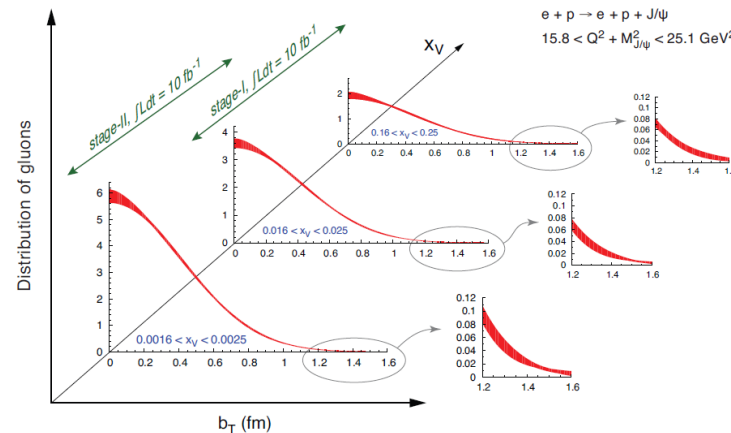
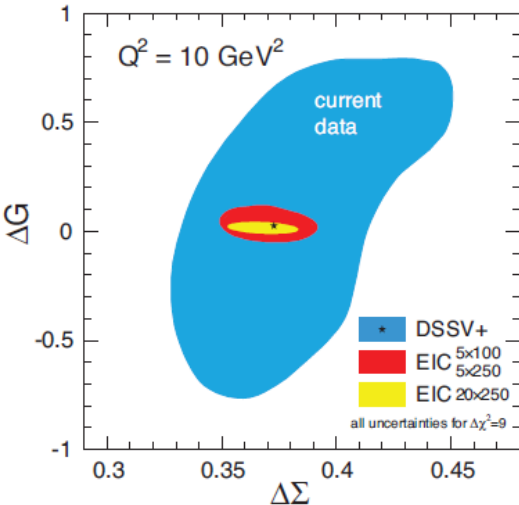

1. Proton Spin
2. Motion of partons
3. Imaging nuclei
4. Dense Gluonic QCD matter
5. Quark Hadronization

Map the physics cases from EIC whitepaper to eSTAR (details in eSTAR LOI)!

Forward Instrumentation Upgrade for eSTAR

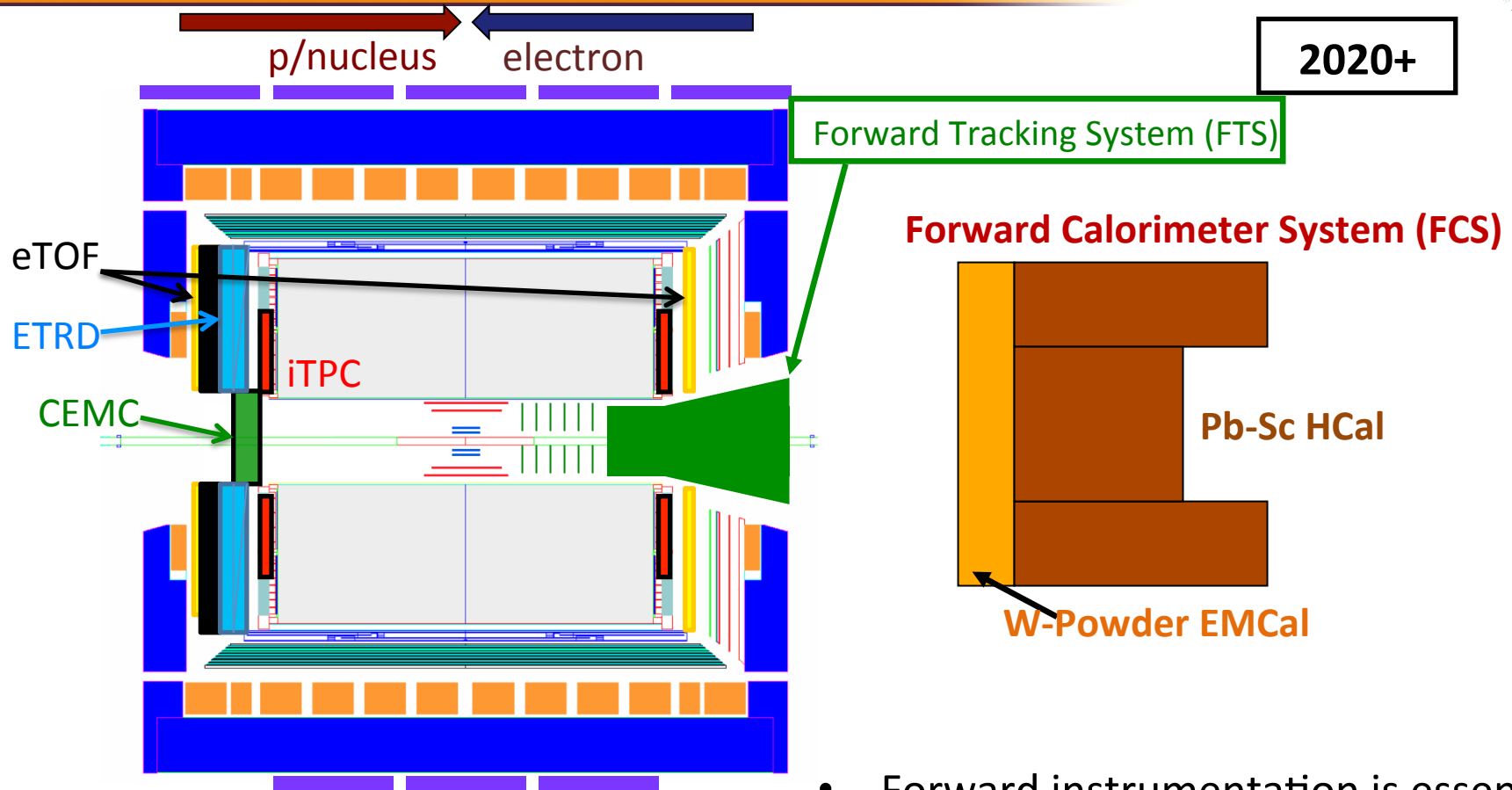

eSTAR specific upgrades (electron side):

- **Endcap TOF:** e, π , K identification
- **ETRD:** electron ID and hadron tracking
- **CEMC:** 5 GeV, 10 GeV electron beams

- Forward instrumentation is essential for $p_{\uparrow}+p_{\uparrow}$ and $p_{\uparrow}+A$ physics
 - Charged-particle tracking
 - e/h and γ/π^0 discrimination

Forward Instrumentation Upgrade for eSTAR

R&D status of specific upgrades for eSTAR:

ETTIE: Endcap TOF and TRD for Identifying electrons at EIC

- GEM detector with Xe+CO₂ for detection of transition radiation
- Multi-gap resistive plate chamber as TOF detector
- At Forward direction ($-3 < \eta < -1$)
- dE/dx resolution with Xe+CO₂ gas in 2-4 cm ionization chamber

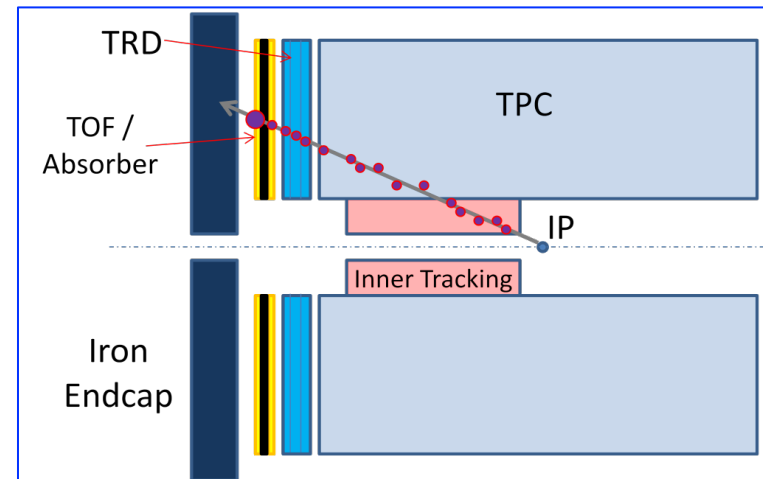

CEMC: BSO based crystal calorimeter

- Very Forward Electron Detection ($\eta < -2.5$)
- BSO is produced by replacing Ge in BGO with Si, the material cost for BSO reduced by factor of 3-4.
- Collaborators: USTC, SINAP, THU
- Vendor: Shanghai SICCAS High Technology Cooperation
- R&D proposal partially funded by BNL/DOE

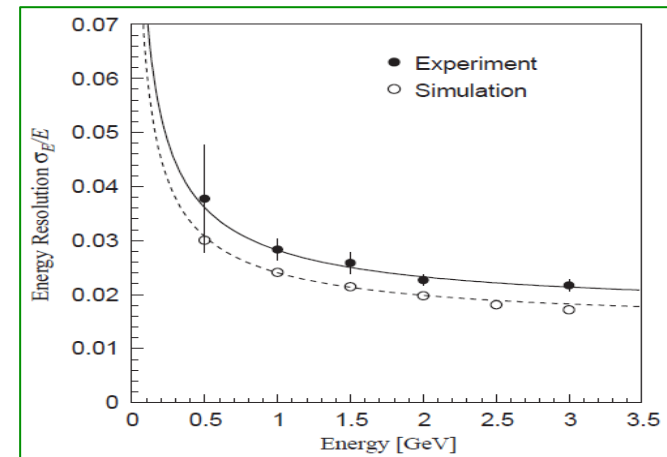
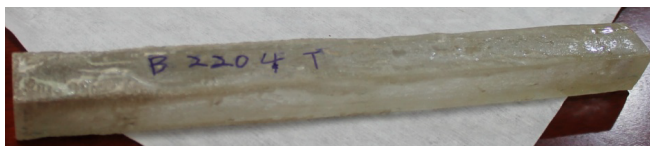



Summary

- 1) STAR at RHIC: Dedicated facility/Detector for studying matter with QCD degrees of freedom:
 - Properties of QGP
 - Sea quark and gluon contributions to nucleon spin
- 2) Ongoing: HFT, MTD
 - Heavy flavor production, collectivity and energy loss
 - Resonance-Medium interaction, Chiral symmetry restoration
- 3) Middle term: BES-II, forward upgrades for pp/pA program
 - QCD critical point, phase boundary, transition to eSTAR
- 4) Longer term: eSTAR
 - Partonic structures of nucleon and nuclei
 - Dynamical evolution from cold nuclear matter to hot QGP



Backup



The STAR Experiment



STAR Latest Results

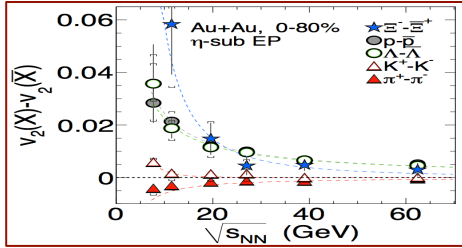

PRL 110 (2013) 142301

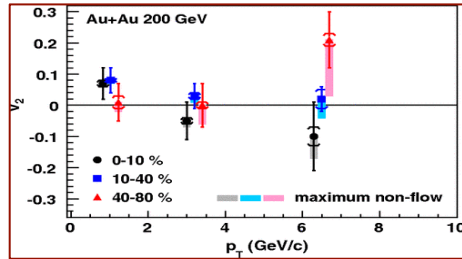

PRL 111 (2013) 052301

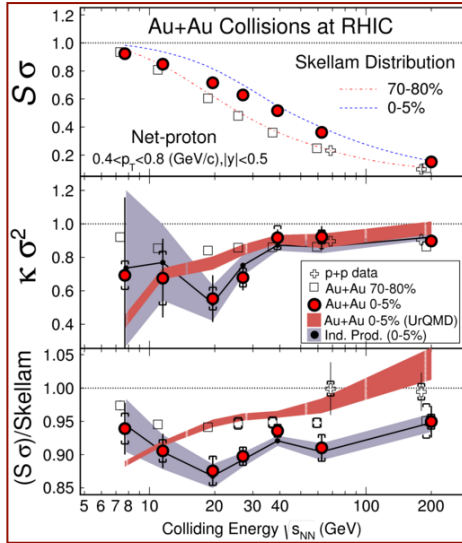

PRL 112 (2014) 032302

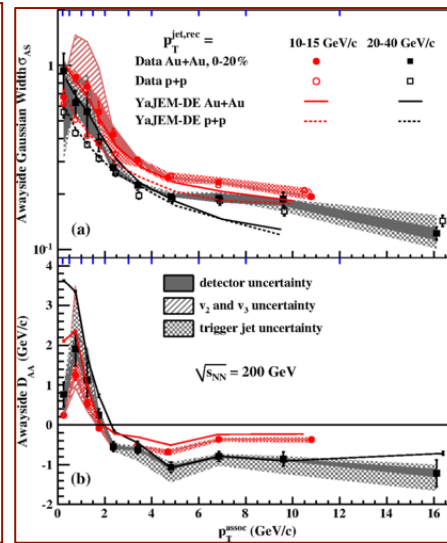

PRL 112 (2014) 122301

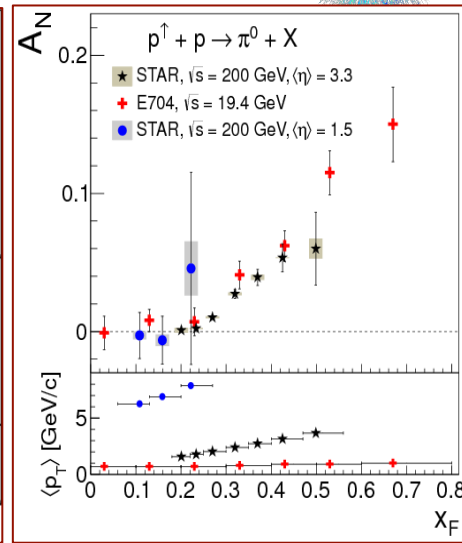

PRD 89 (2014) 012001

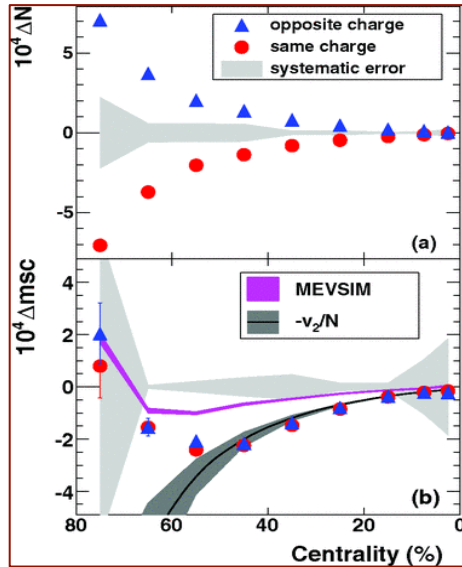

PRC 88 (2013) 064911

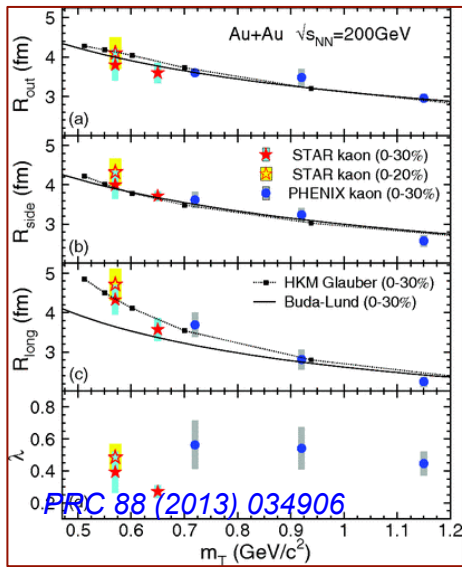

PRC 88 (2013) 034906

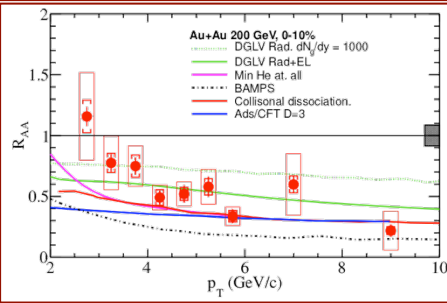
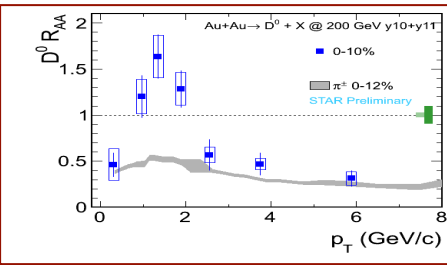

STAR Preliminary results

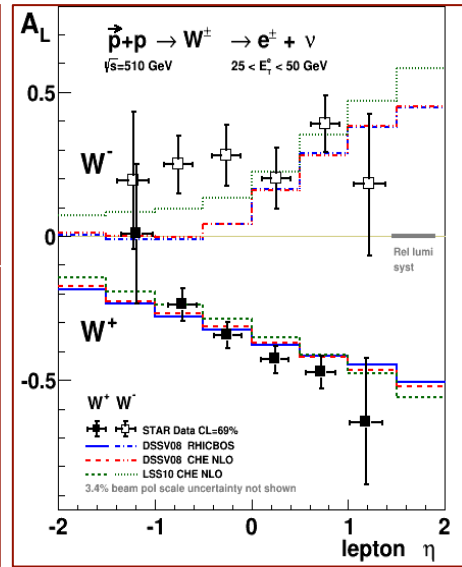

STAR Preliminary results

Upgrade Plan – STAR's Future is Bright!

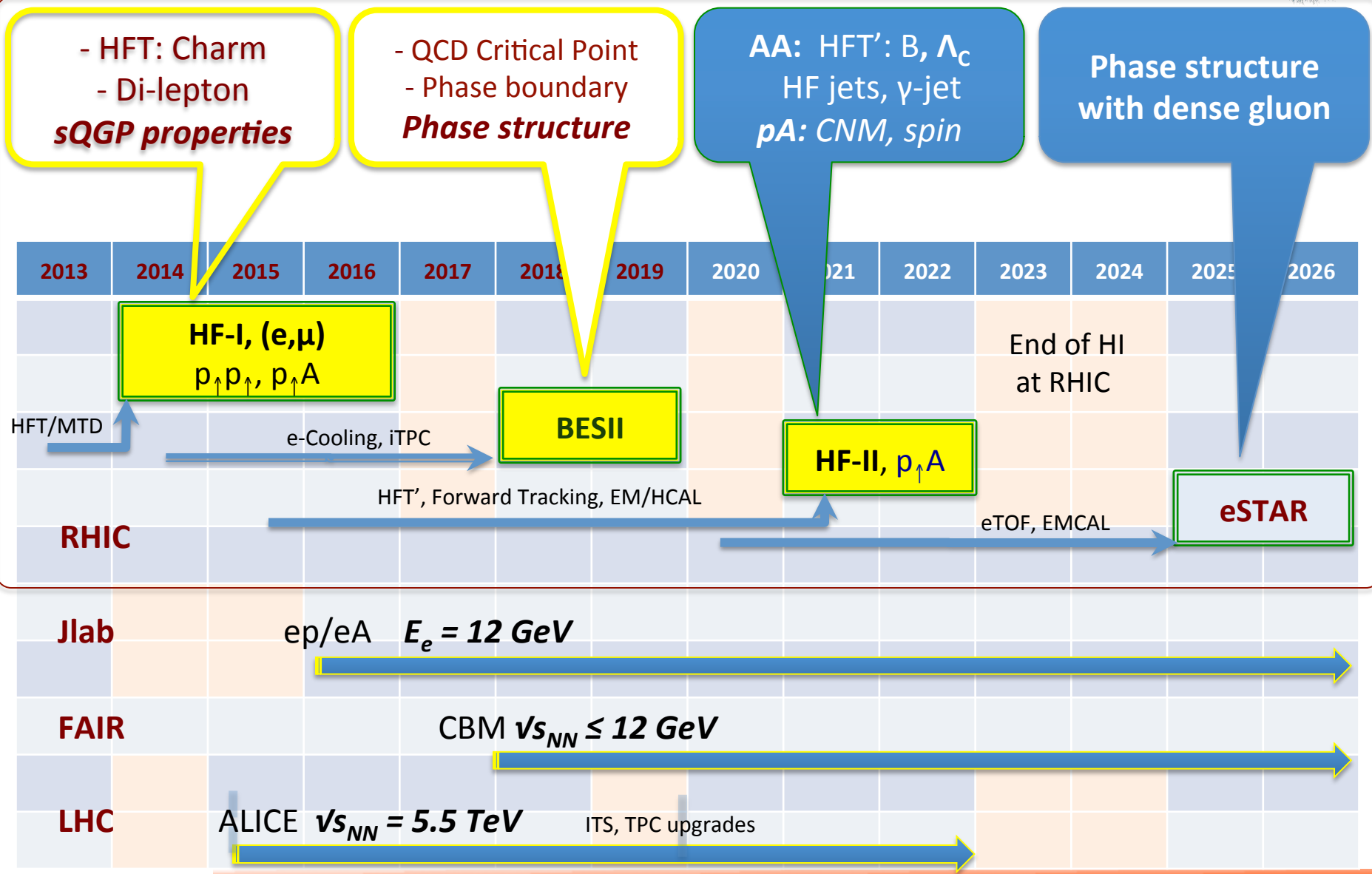

Particle Identification in 2014+

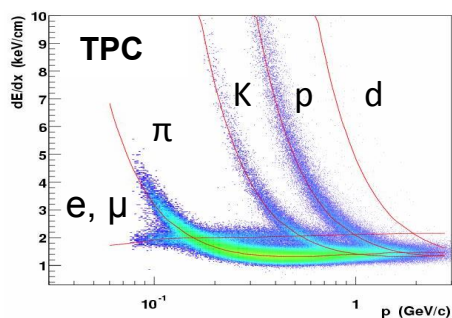

Charged hadrons

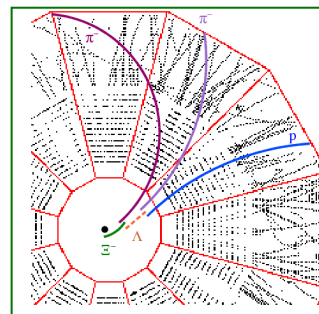
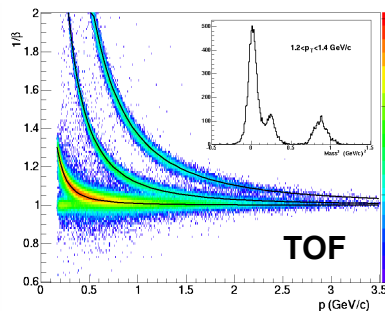

Hyperons & Hyper-nuclei

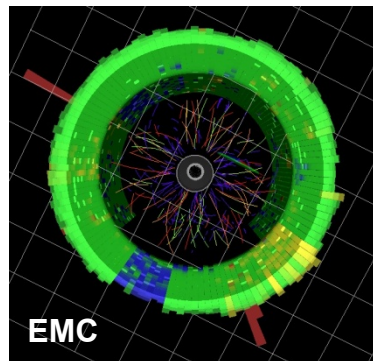
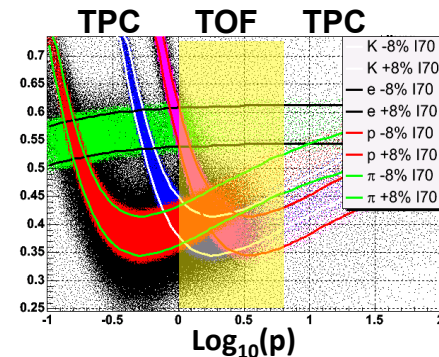

Neutral particles

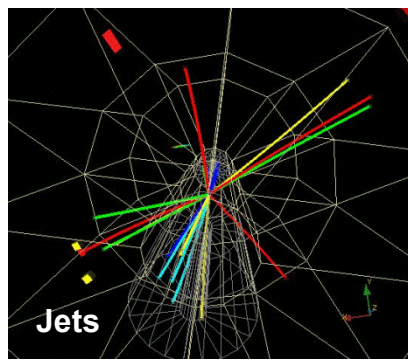

Jets & Correlations

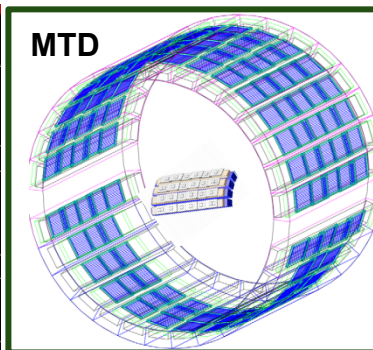

High p_T muons

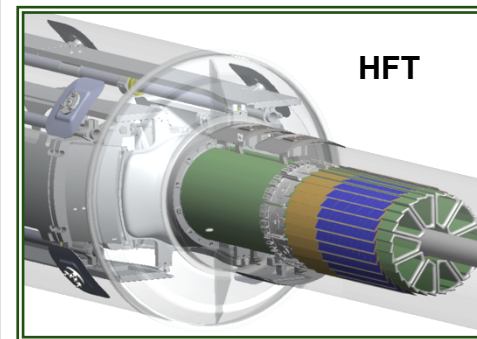

Heavy-flavor hadrons

**Multiple-fold correlations among the identified particles!
 Nearly perfect coverage at mid-rapidity**

HFT Design

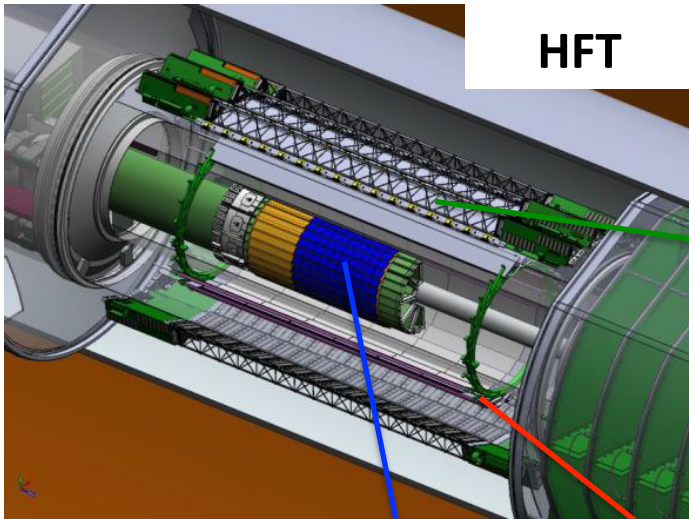

HFT

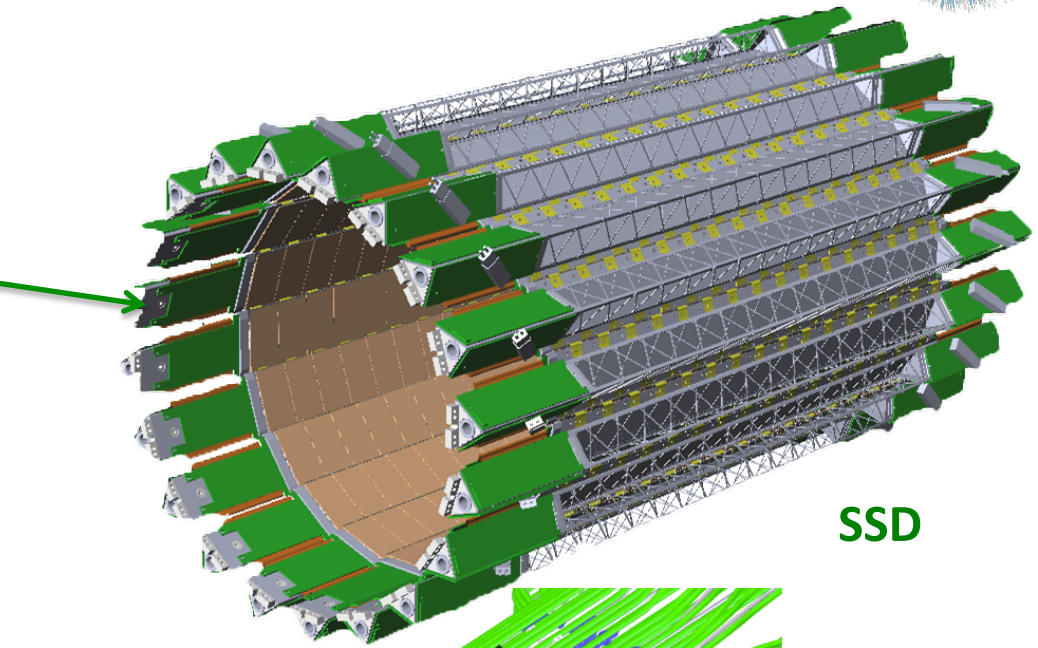

SSD

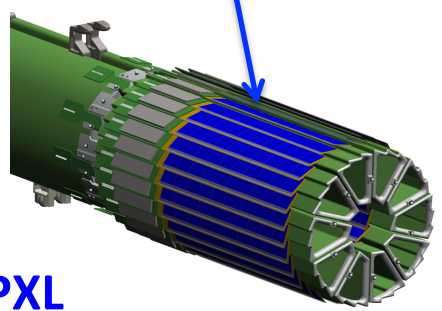

PXL

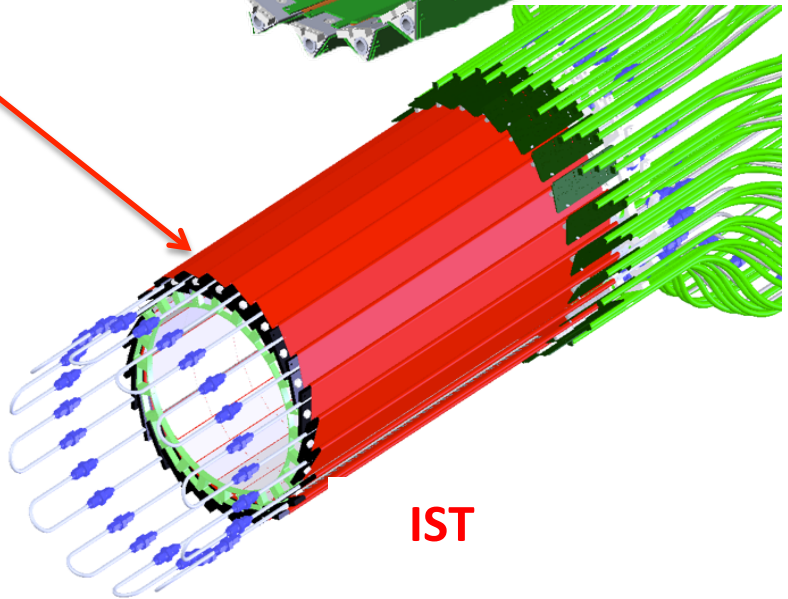

IST

B tagged J/ψ (Run 14/15)

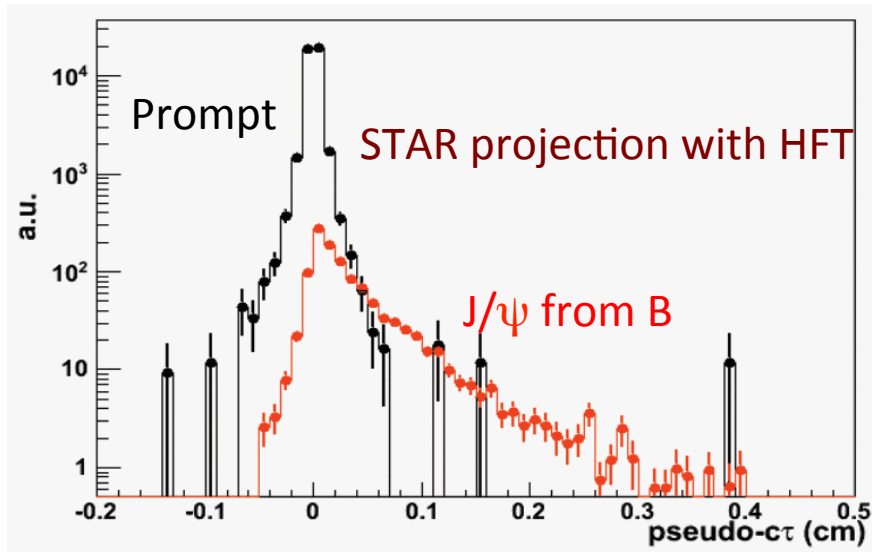
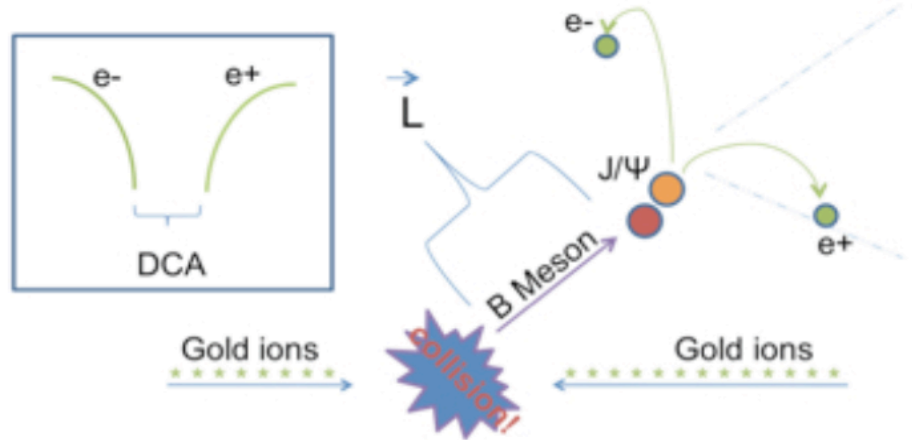
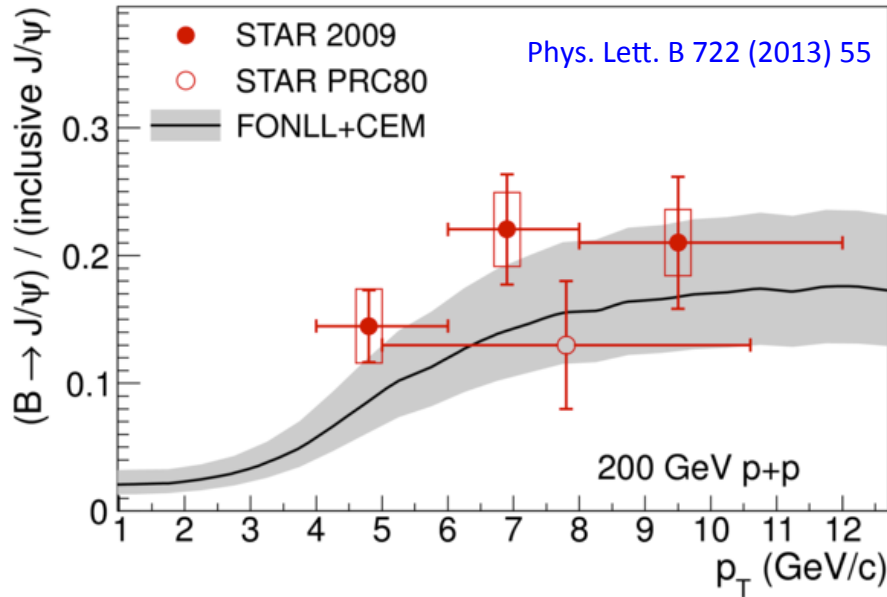

- Current measurement via J/ψ -hadron correlation have large uncertainties and only in p+p collisions.
- With HFT can be measured by displaced vertex
- With MTD can be measured via di-muon channels

iTPC Upgrade for BES II

A Proposal for STAR Inner TPC Sector Upgrade (iTPC)

The STAR Collaboration
February 25, 2014

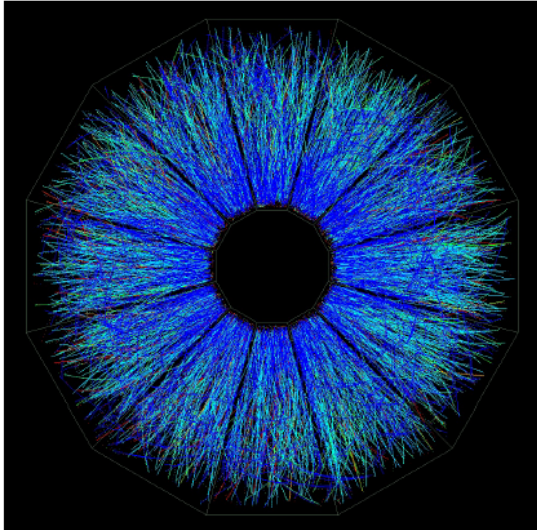

In preparation ...

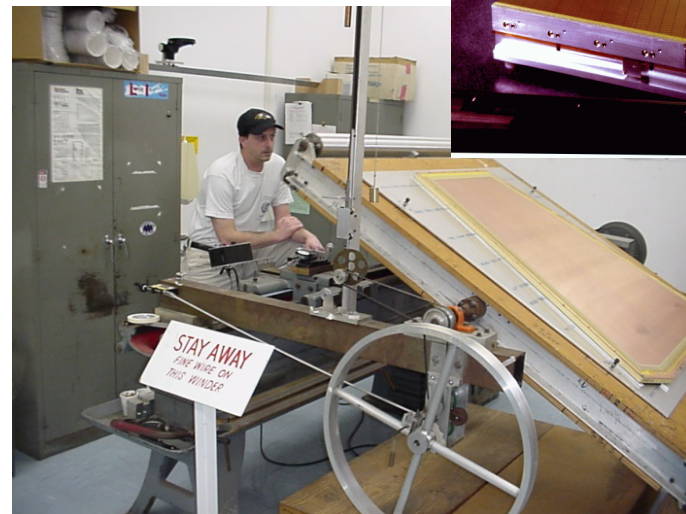
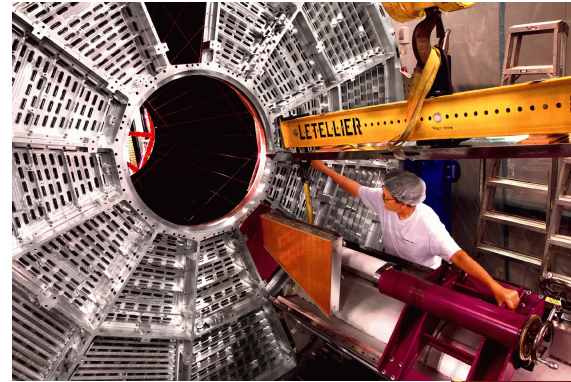



Golden Probes in eA with eSTAR (2025+)



Golden Probes in eA

Physics	eSTAR	Measurements	requirements
Structure functions of heavy nuclei (F2,FL)		Scattered electron (Q^2, x)	Precise electron p and PID
Semi-inclusive final-state correlation		Scattered electron (Q^2, x) and hadrons	Electron ID and hadron spectra
Exclusive Vector Meson		J/ψ and other vector meson	Electron/muon ID and full coverage detector
Cold Nuclear Energy Loss		Jets and leading hadrons	Electron and Hadron PID
Heavy-Flavor Energy Loss		Charm PID	Secondly vertex detector
Exotics		Heavy-flavor hypernuclei	Forward Secondly vertex detector

<http://www.indiana.edu/~ntceic/Talks/Xu.pdf>