

Collective Effect I

Giuliano Franchetti, GSI
CERN Accelerator – School
Prague

Type of fields

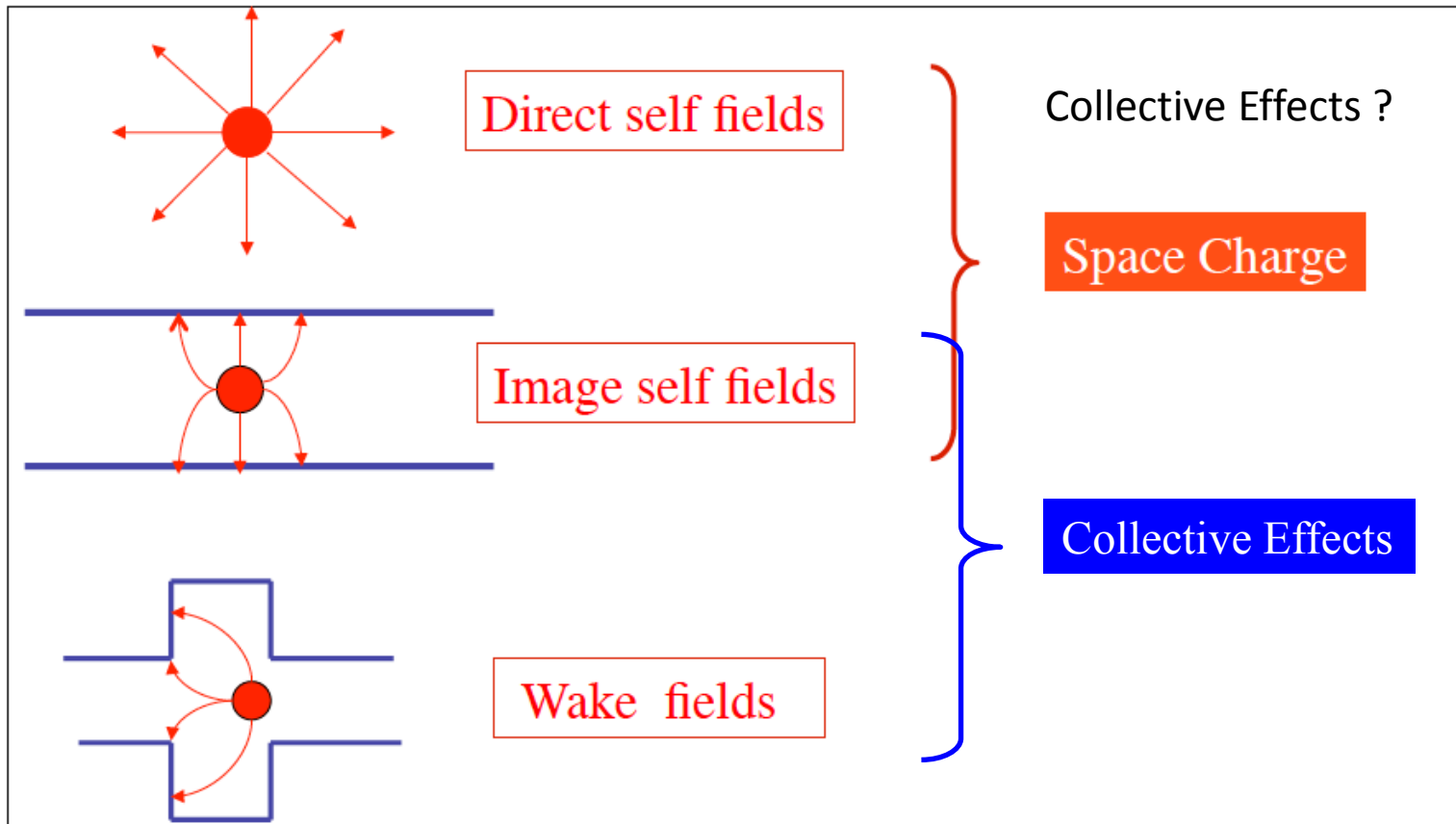
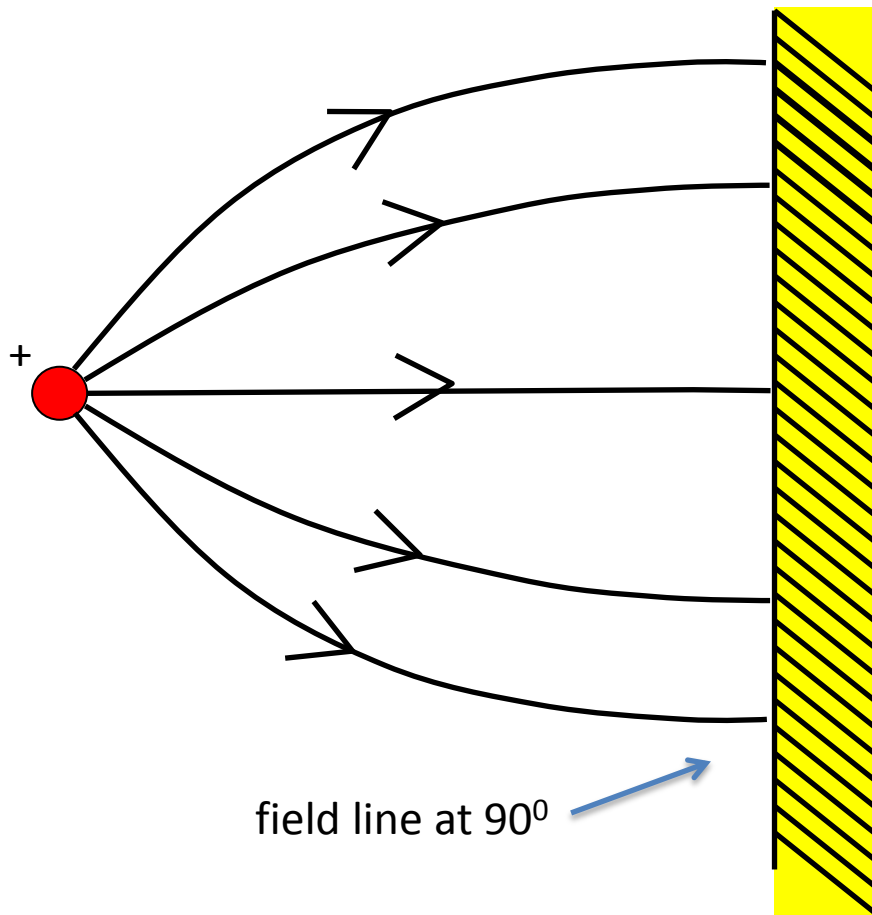

Image charges

Influence of the chamber wall



the electron in the metal quickly travel on the surface of the metal until the electric field parallel to the surface is zero

Image charge

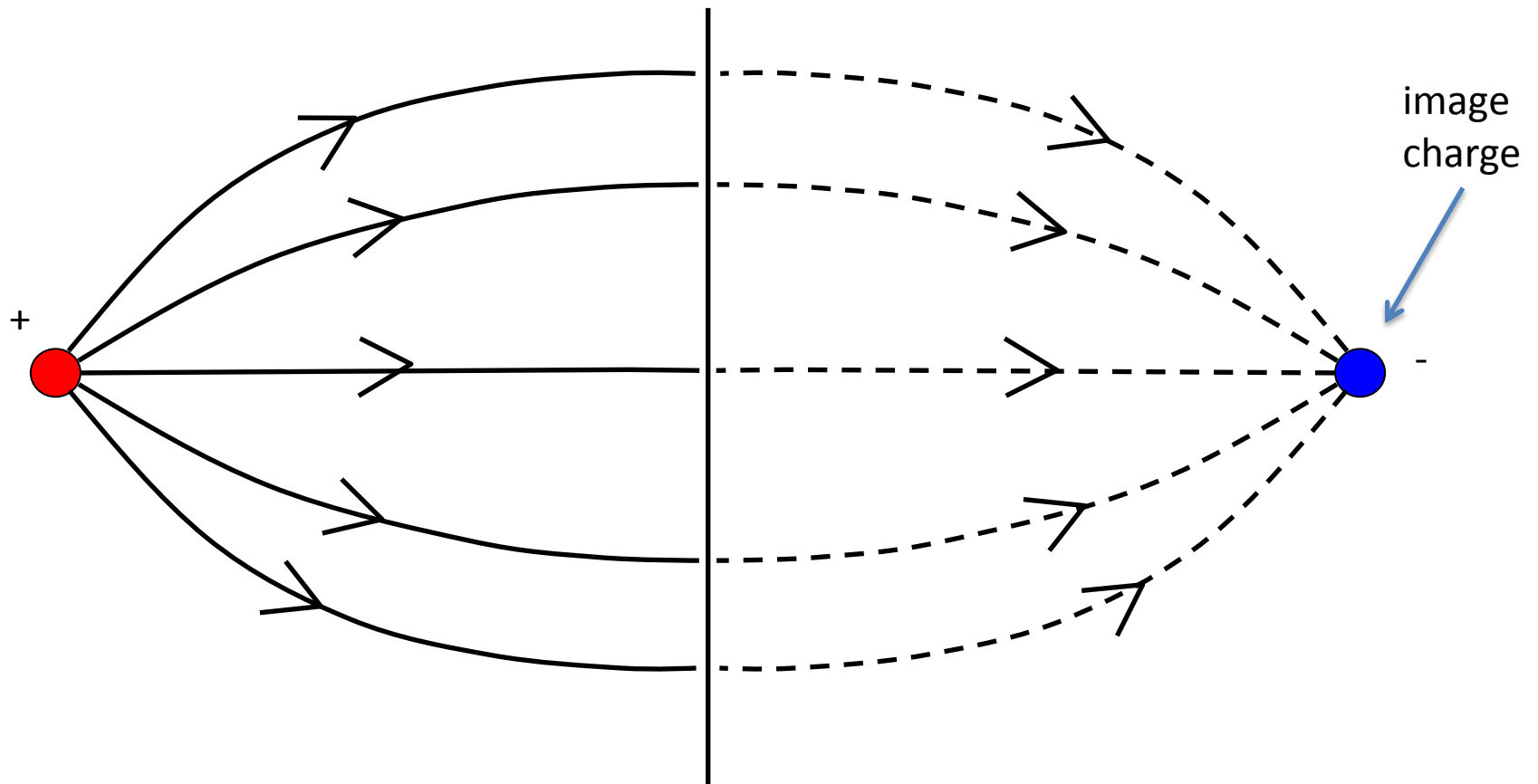

the image charge is a reflection of the particle with exchanged sign

Image charge

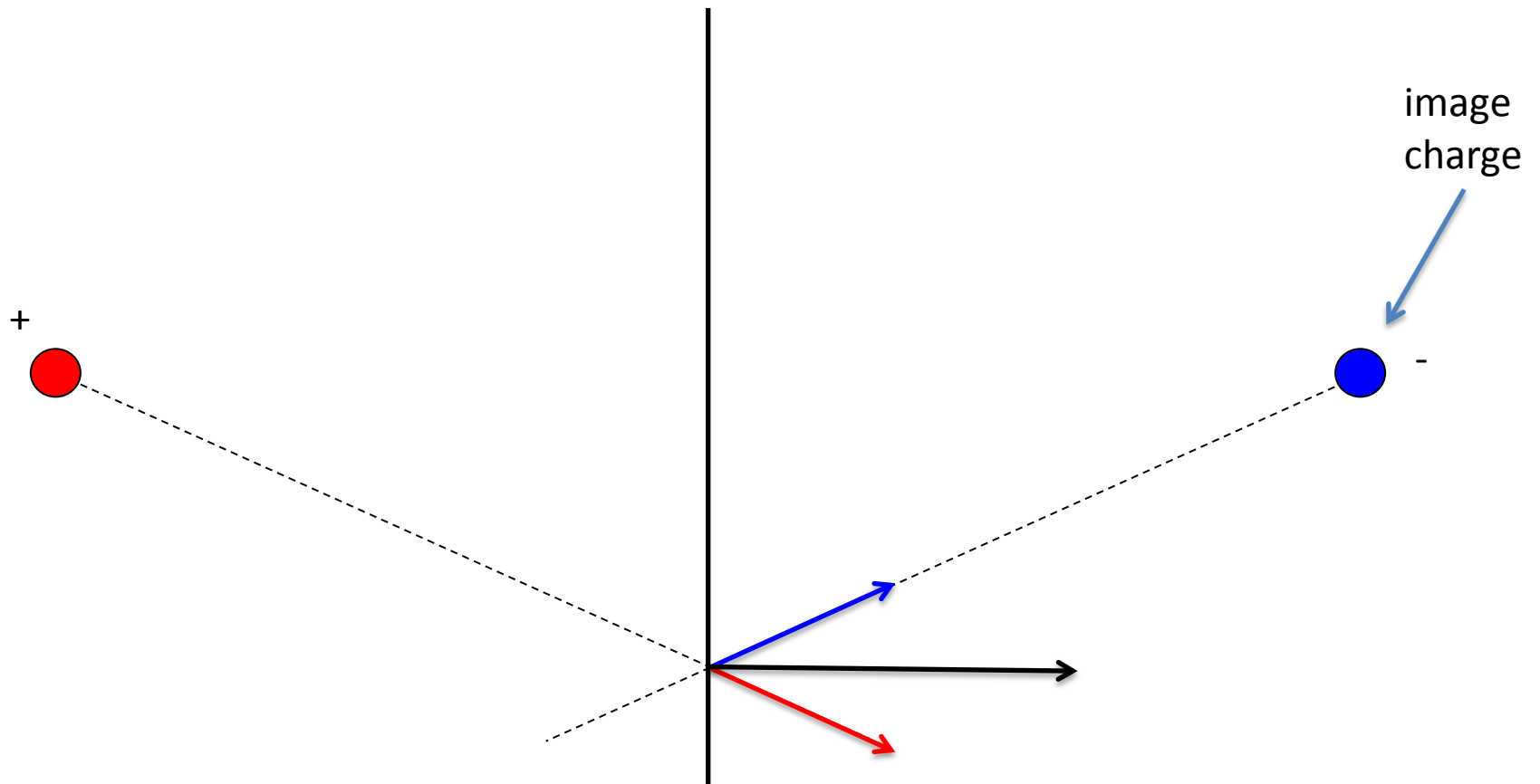

the image charge is a reflection of the particle with exchanged sign

Conducting plates

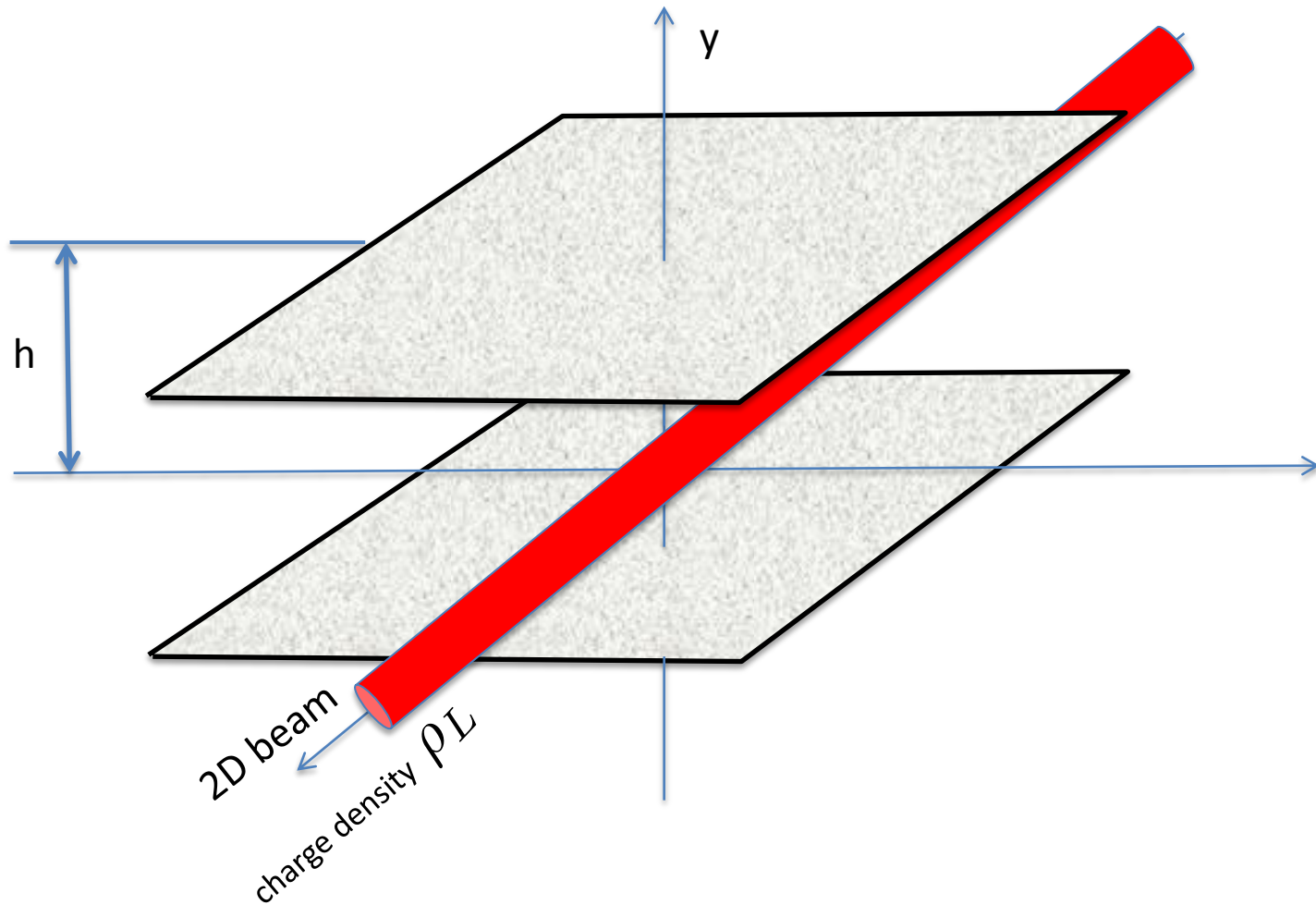

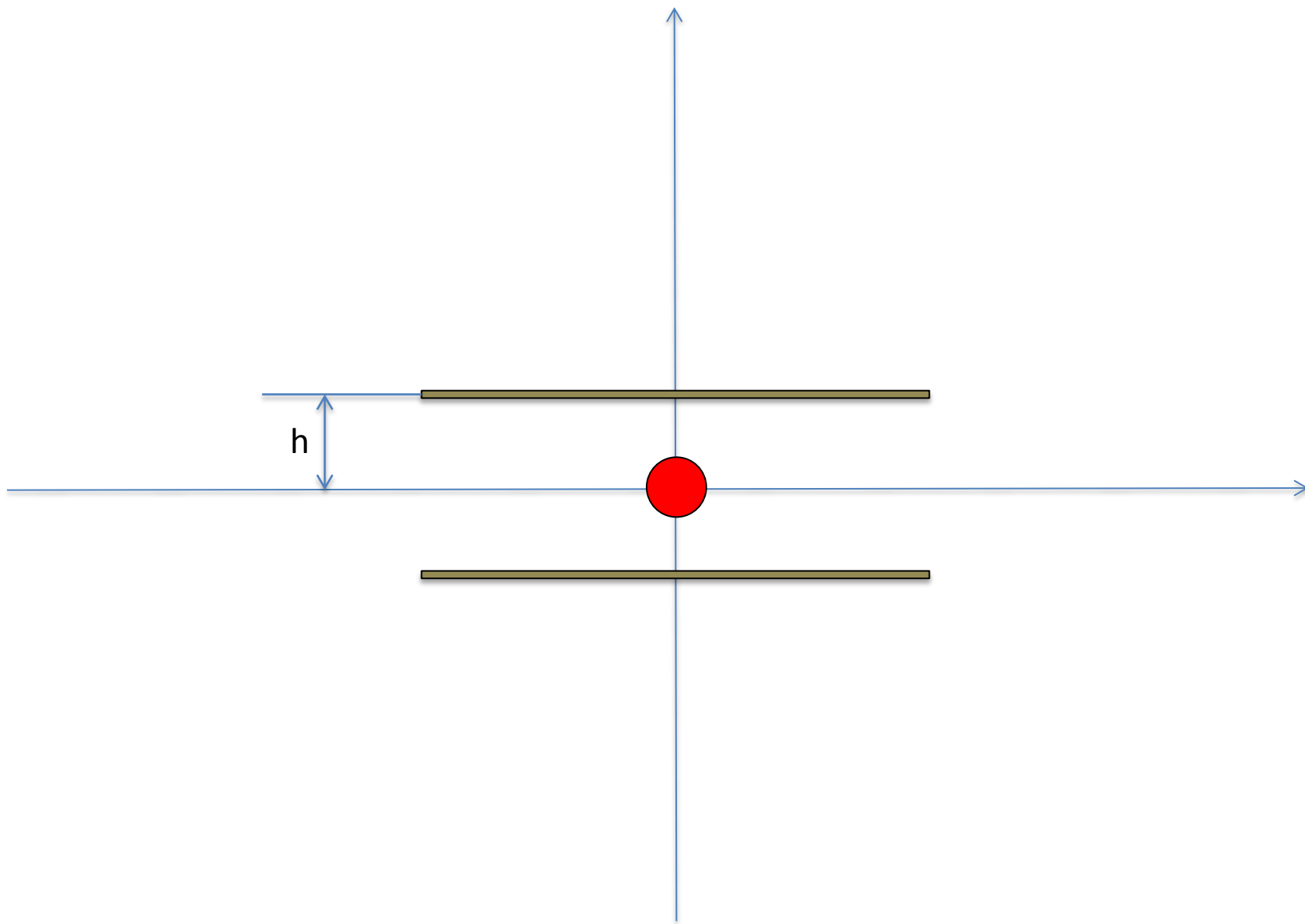

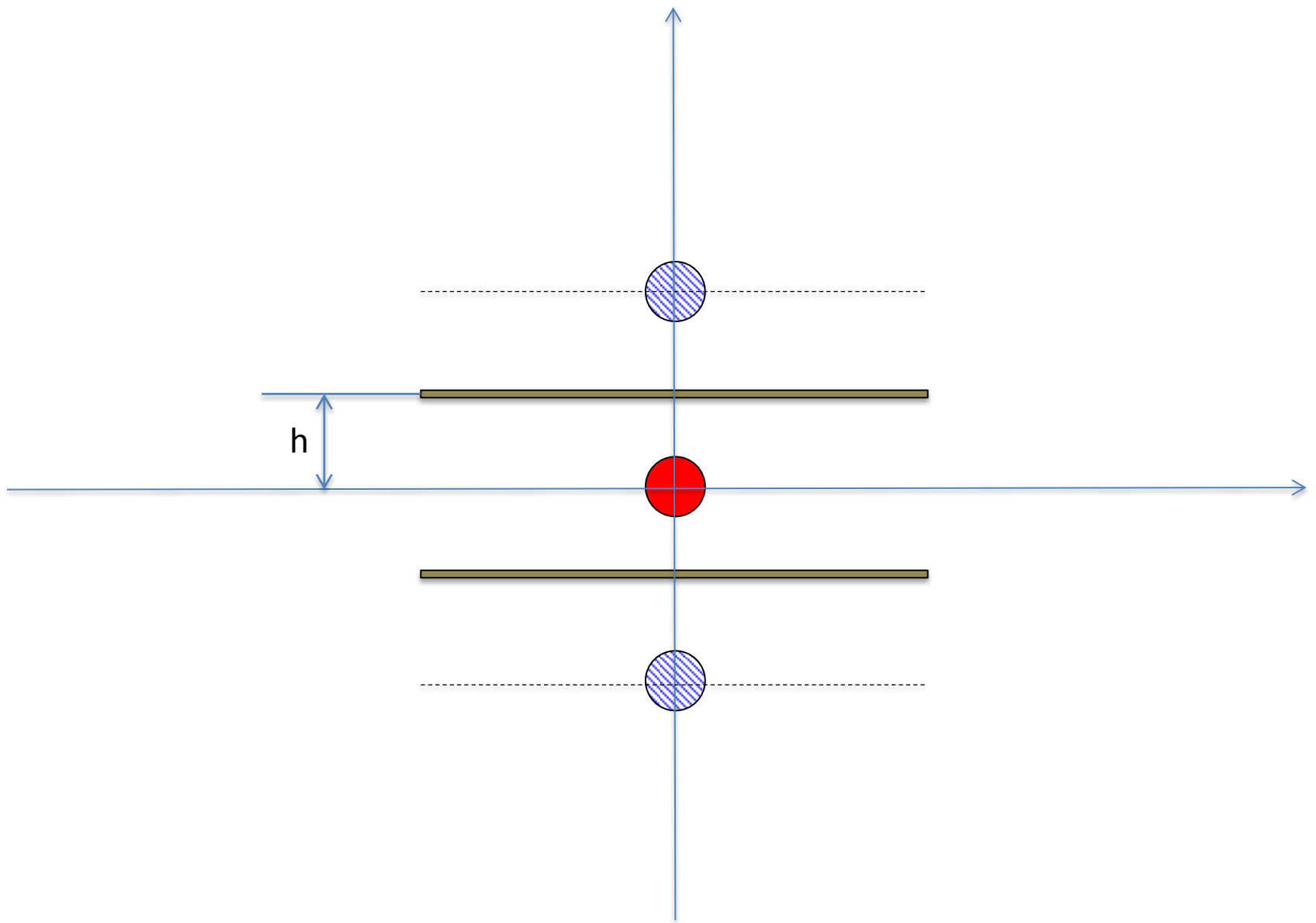

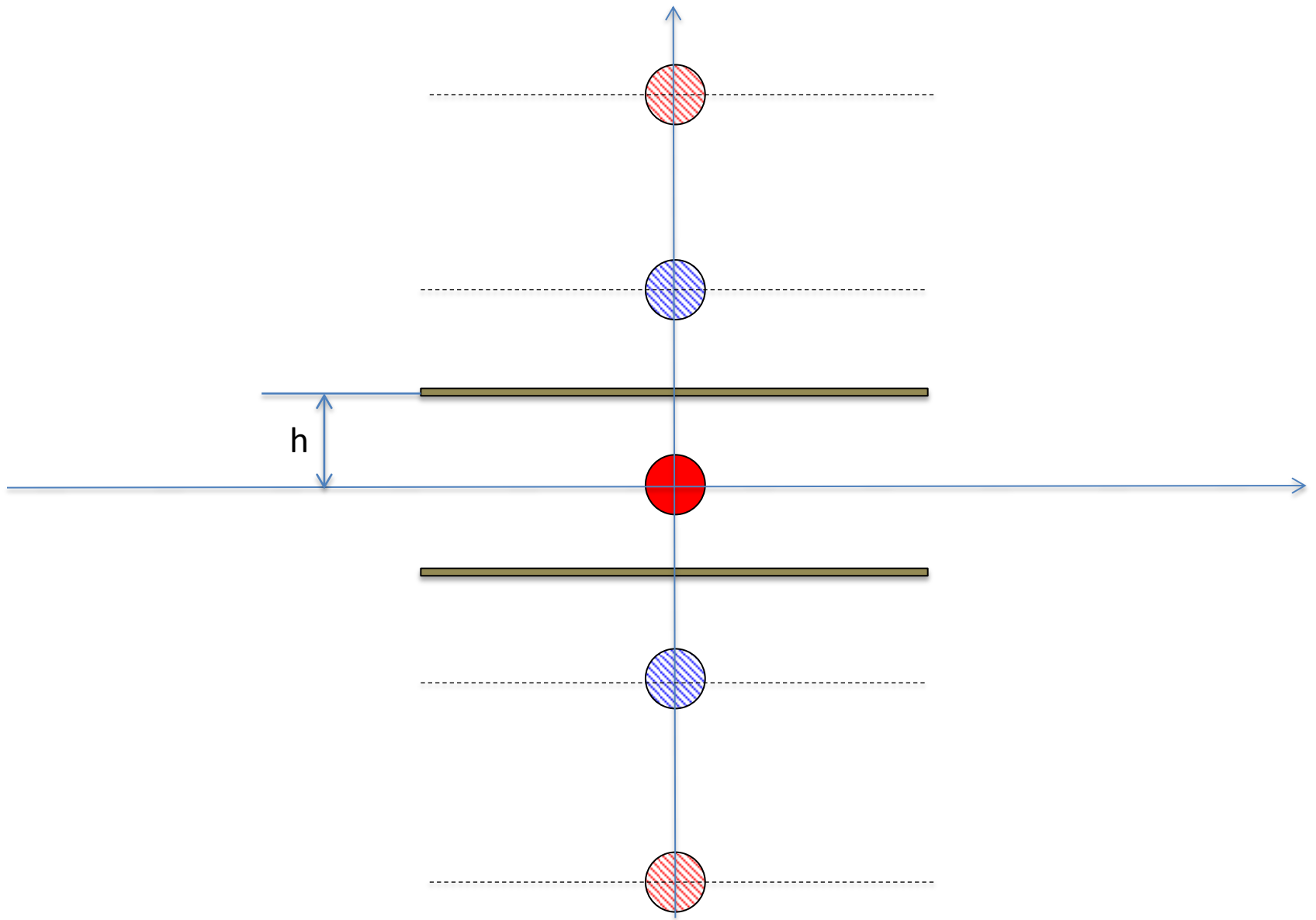

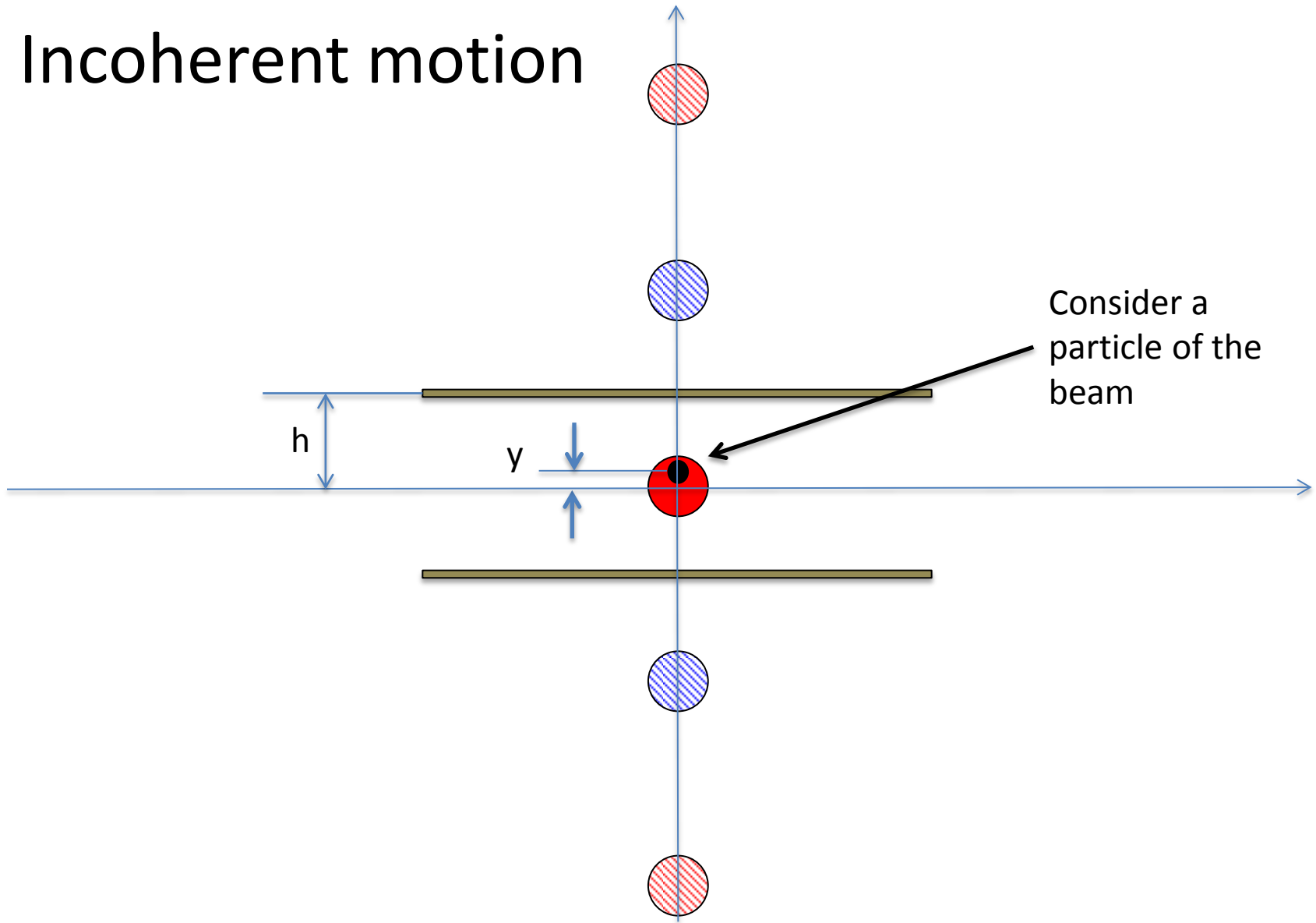

Incoherent motion

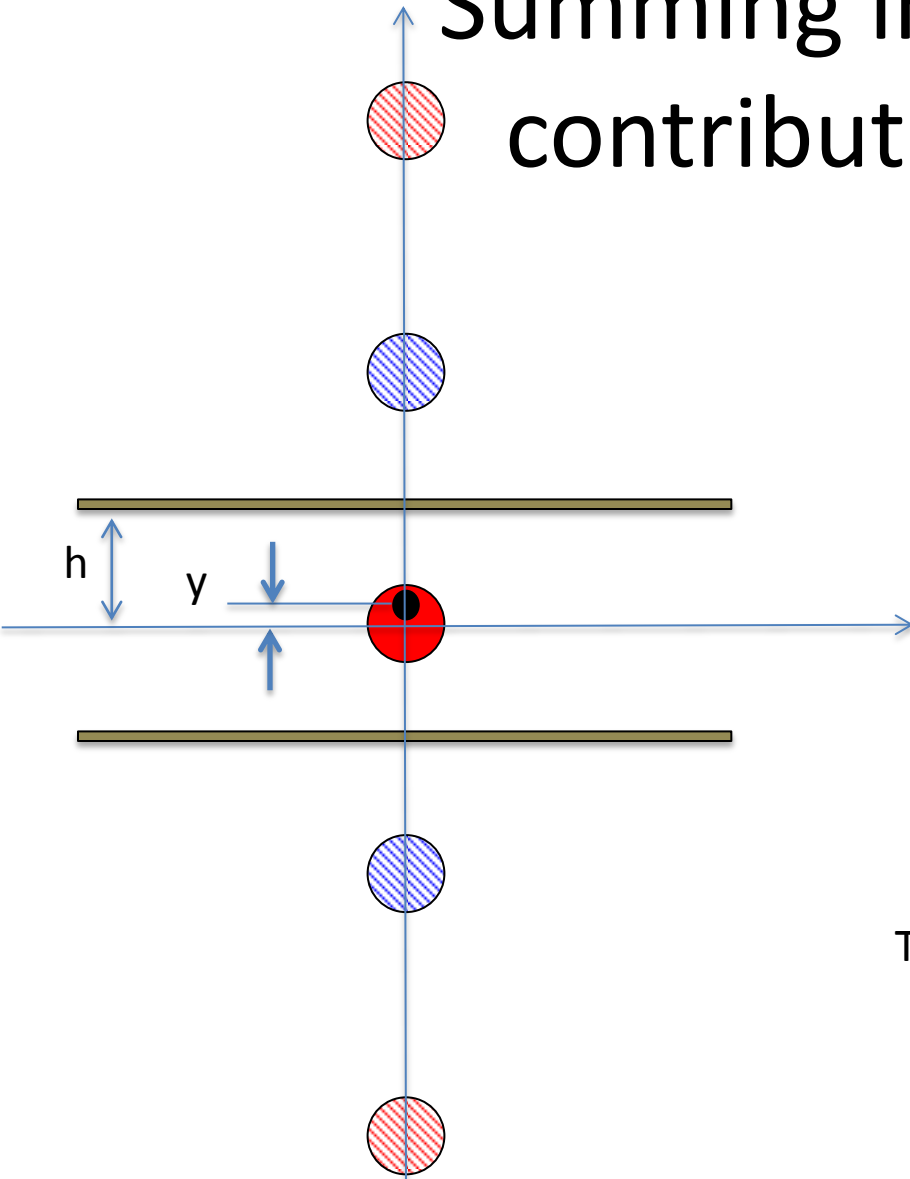

Summing image charge contribution in pairs



$$E_{y,n} = \frac{\rho_L}{2\pi\epsilon_0} (-1)^n \left(\frac{1}{2nh + y} - \frac{1}{2nh - y} \right)$$

 $h \gg y$

$$E_{y,n} = -\frac{\rho_L y}{4\pi\epsilon_0 h^2} \frac{(-1)^n}{n^2}$$

Total electric field

$$E_y = \sum_{n=1}^{\infty} E_{y,n} = \frac{\rho_L y}{\pi\epsilon_0} \frac{\pi^2}{48h^2}$$

Equation of motion

In the equation of motion

$$\frac{d^2y}{ds^2} + k_y y = \frac{e}{m\gamma^3 v_0^2} E_{b,y} + \frac{e}{m\gamma v_0^2} E_{i,y}$$

$$\frac{d^2y}{ds^2} + k_y y = \frac{2K}{Y(X+Y)} y + K\gamma^2 \frac{\pi^2}{24h^2} y$$

as $\nabla \cdot \vec{E} = 0 \quad \rightarrow \quad \frac{\partial E_x}{\partial x} = -\frac{\partial E_y}{\partial y}$

$$\frac{d^2 y}{ds^2} + k_y y - \frac{2K}{Y(X+Y)} \left[1 + \gamma^2 \frac{\pi^2}{48} \frac{Y(X+Y)}{h^2} \right] y = 0$$

$$\frac{d^2 x}{ds^2} + k_x x - \frac{2K}{X(X+Y)} \left[1 - \gamma^2 \frac{\pi^2}{48} \frac{X(X+Y)}{h^2} \right] x = 0$$

Laslett Tuneshift

$$\Delta Q_y \simeq -\frac{R_m^2}{Q_{y0}} \frac{K}{Y(X+Y)} \left[1 + \gamma^2 \frac{\pi^2}{48} \frac{Y(X+Y)}{h^2} \right]$$

$$\Delta Q_x \simeq -\frac{R_m^2}{Q_{x0}} \frac{K}{X(X+Y)} \left[1 - \gamma^2 \frac{\pi^2}{48} \frac{X(X+Y)}{h^2} \right]$$

Image currents

Ferromagnetic Boundaries

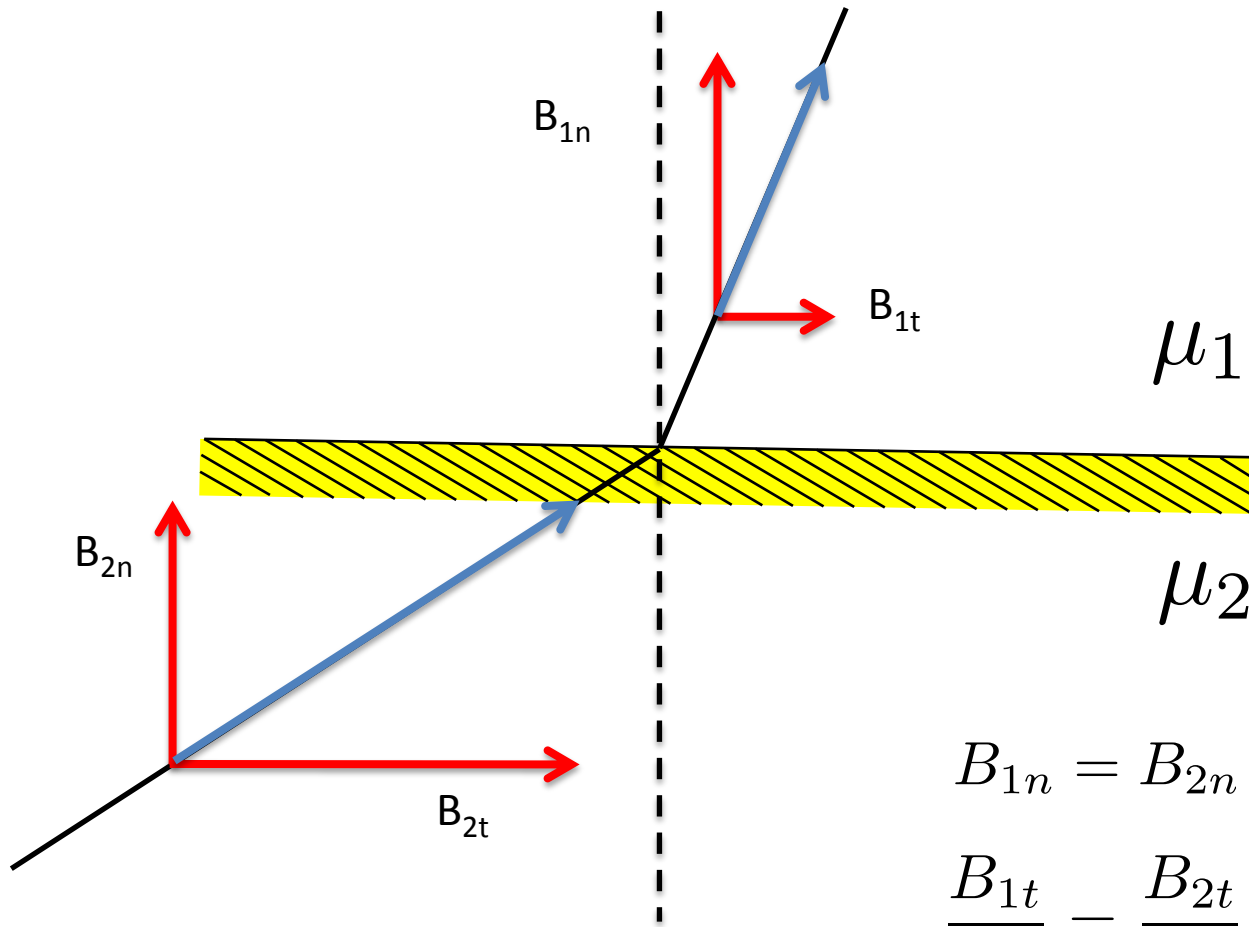

$$B_{1n} = B_{2n}$$

$$\mu_1 \ll \mu_2$$

$$\frac{B_{1t}}{\mu_1} = \frac{B_{2t}}{\mu_2}$$

$$B_{1,t} \simeq 0$$

Ferromagnetic Boundaries

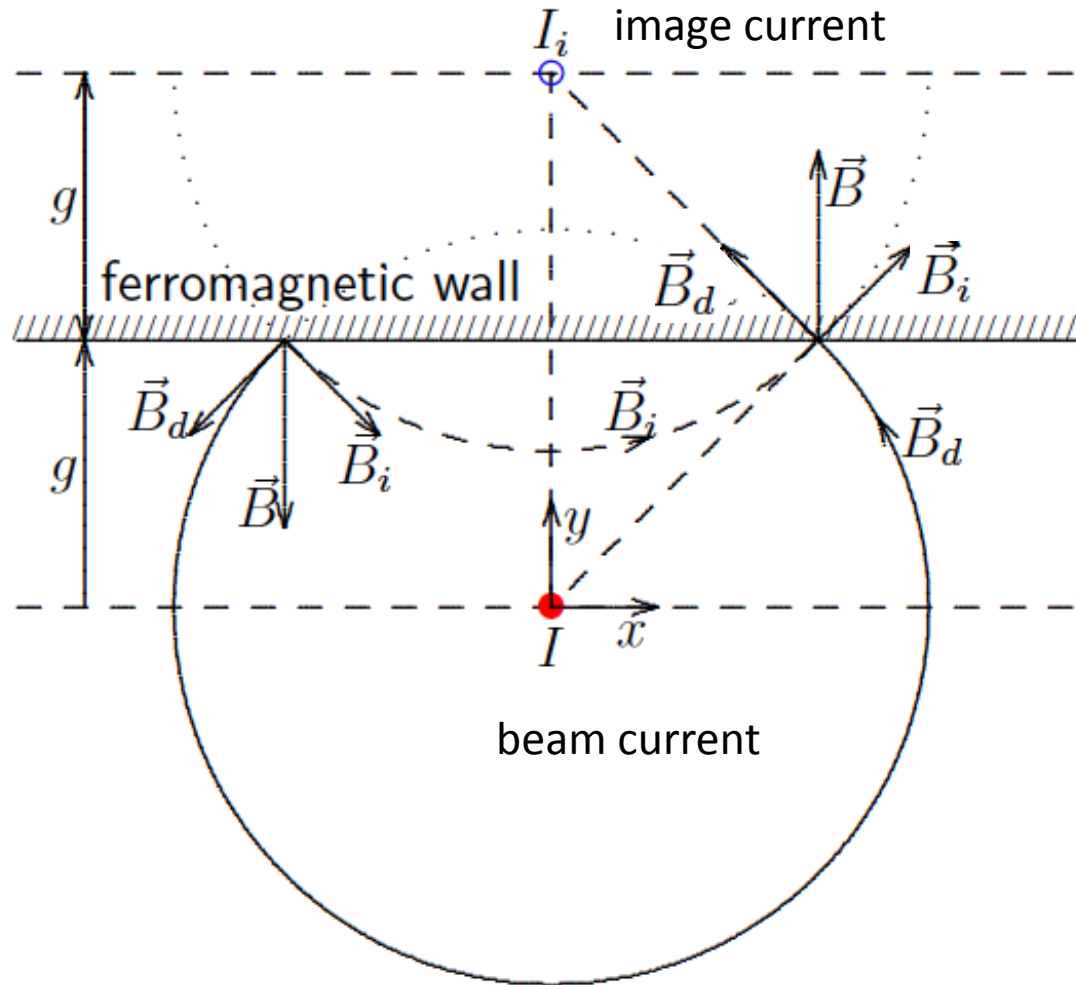

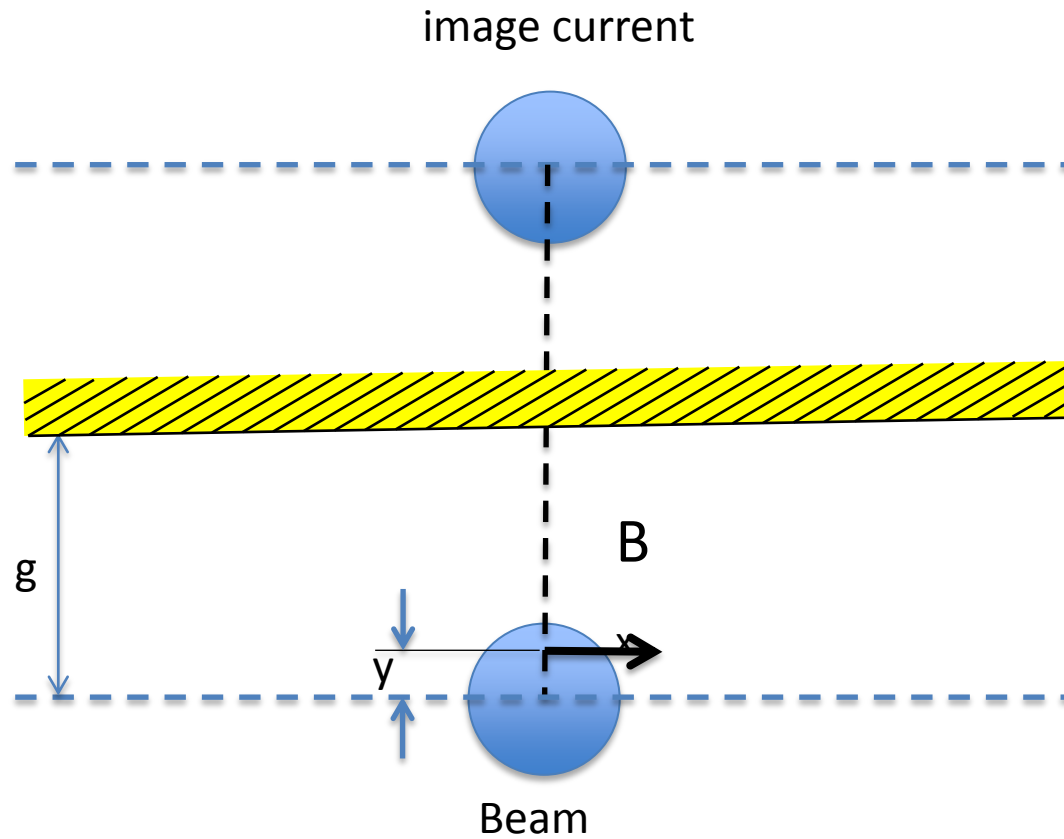

$$B_x = \frac{\mu_0 I}{2\pi} \frac{1}{2g - y}$$

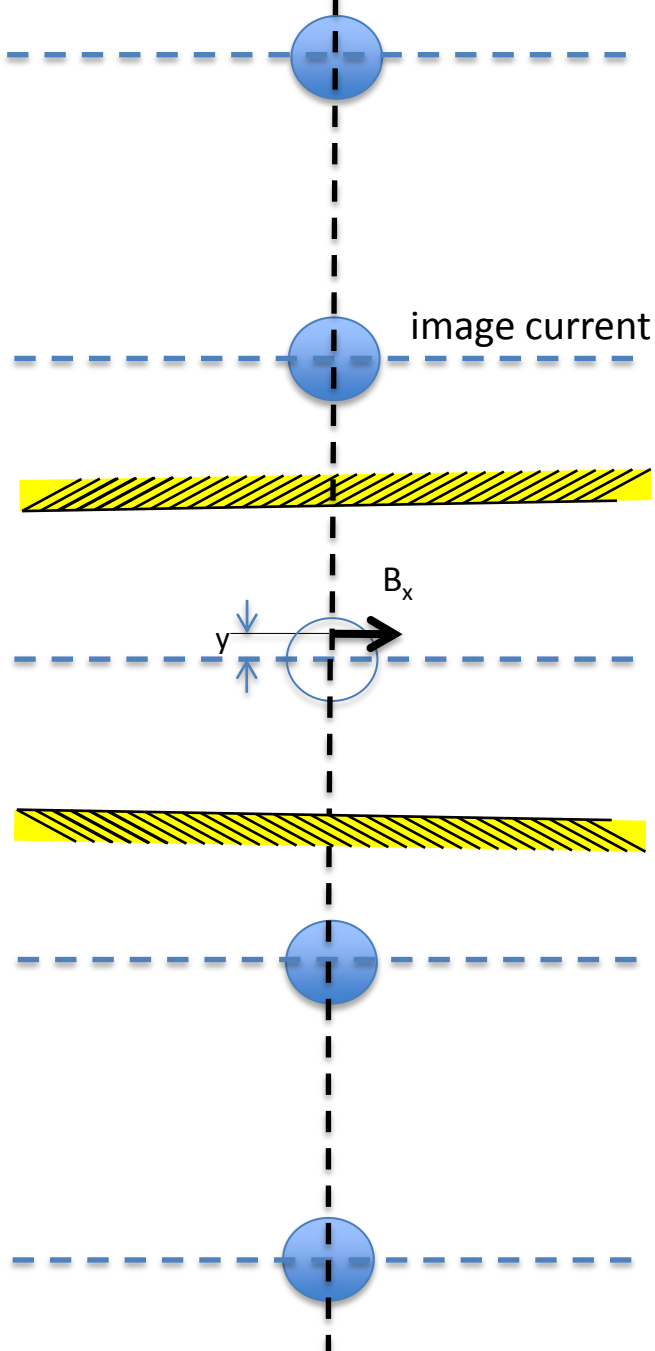

$$B_x = \frac{\mu_0 I}{2\pi} \sum_{n=1}^{\infty} \left(\frac{1}{2ng - y} - \frac{1}{2ng + y} \right)$$

for $g \gg y$

$$B_x = \frac{\mu_0 I y \pi^2}{4\pi g^2 6}$$

In the equation of motion

$$\frac{d^2 y}{ds^2} + k_y y = \frac{2K}{Y(X + Y)} y - \frac{1}{m\gamma v_0^2} v_z B_x$$

therefore

$$\frac{d^2y}{ds^2} + k_y y = \frac{2K}{Y(X+Y)} y + K \frac{2\gamma^2 \beta^2 \pi^2}{24g^2} y$$



incoherent
SC



ferromagnetic
induced image
current
(coherent force)

Tune-shift !

Coherent Motion

Coherent motion

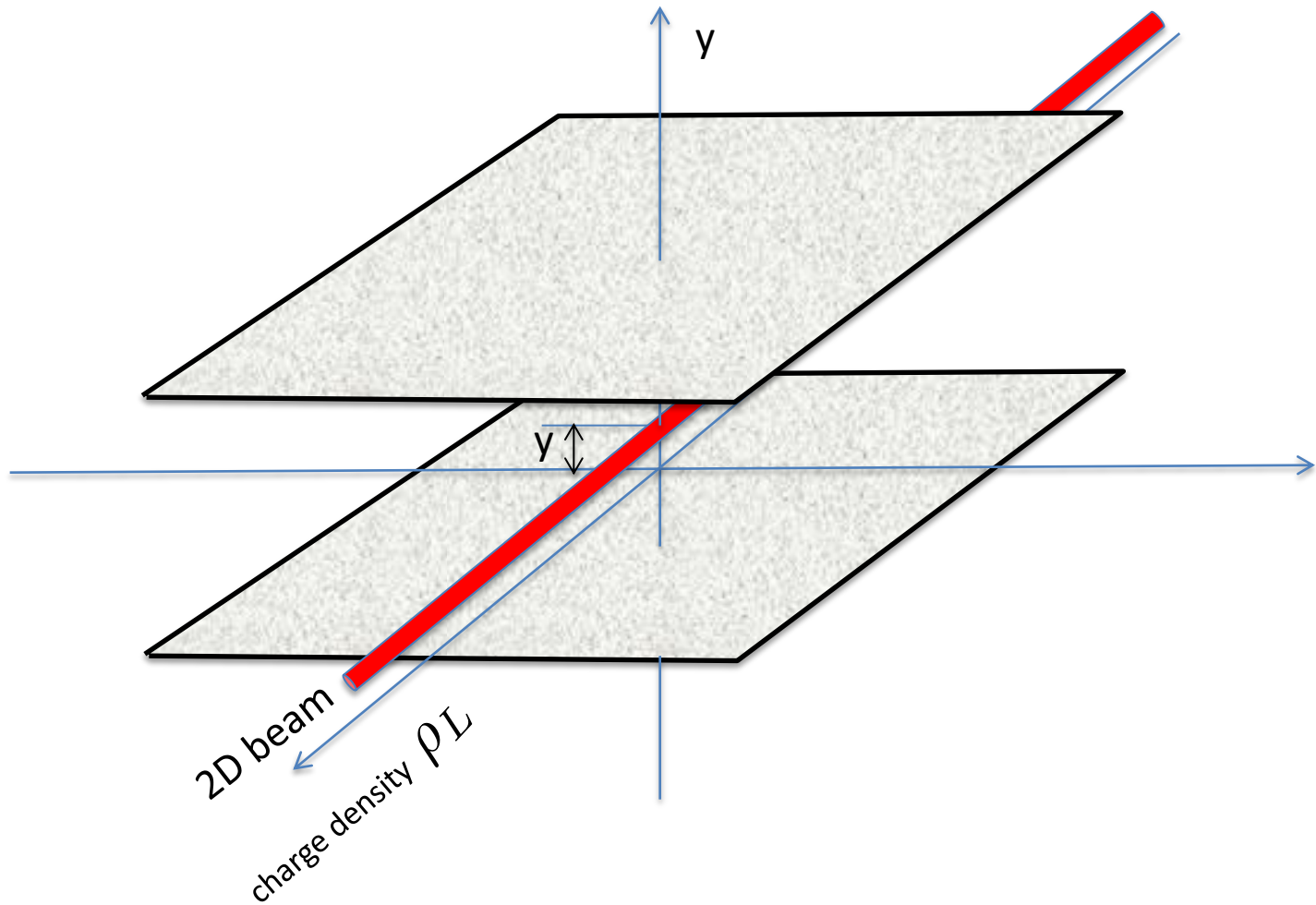

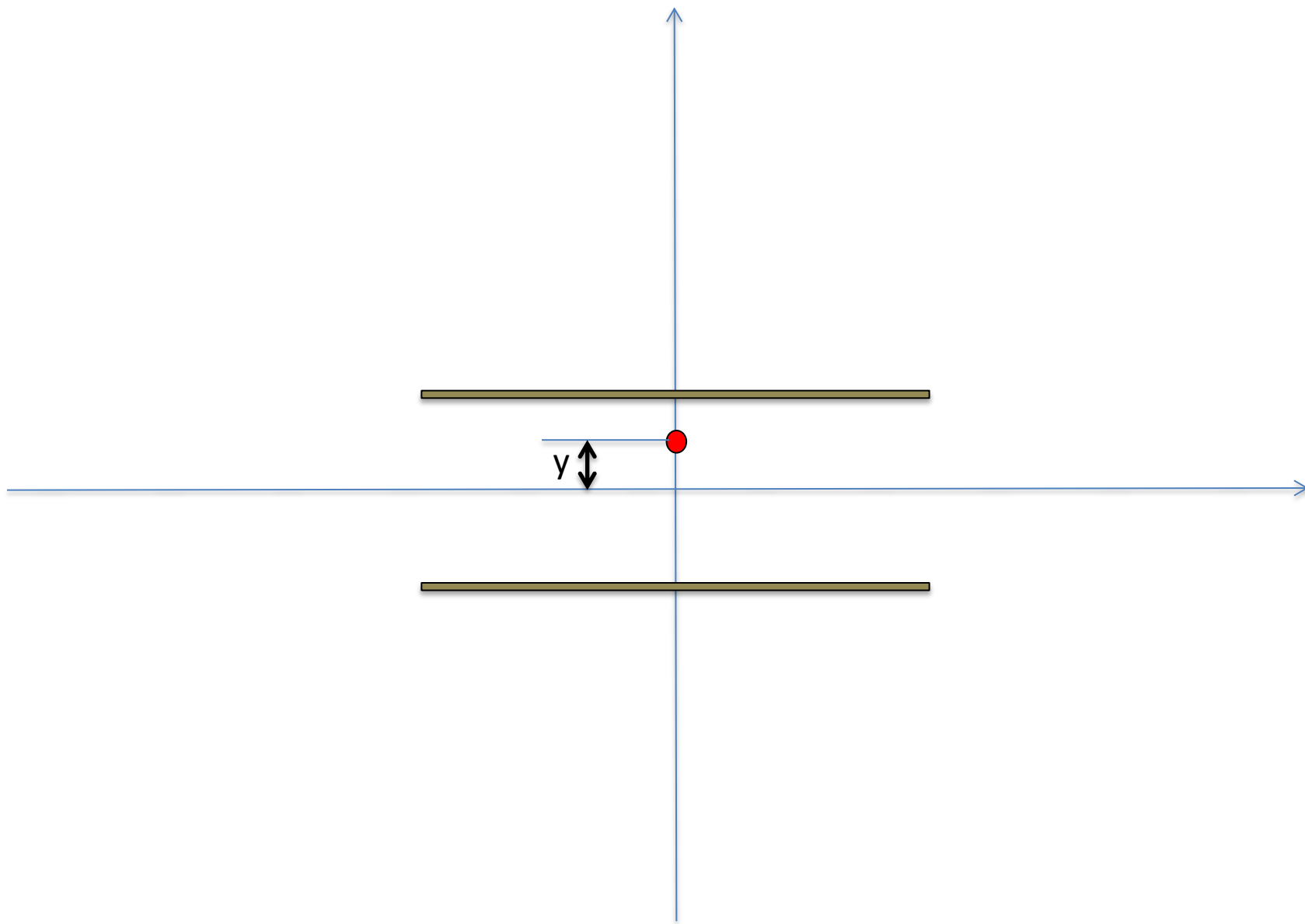

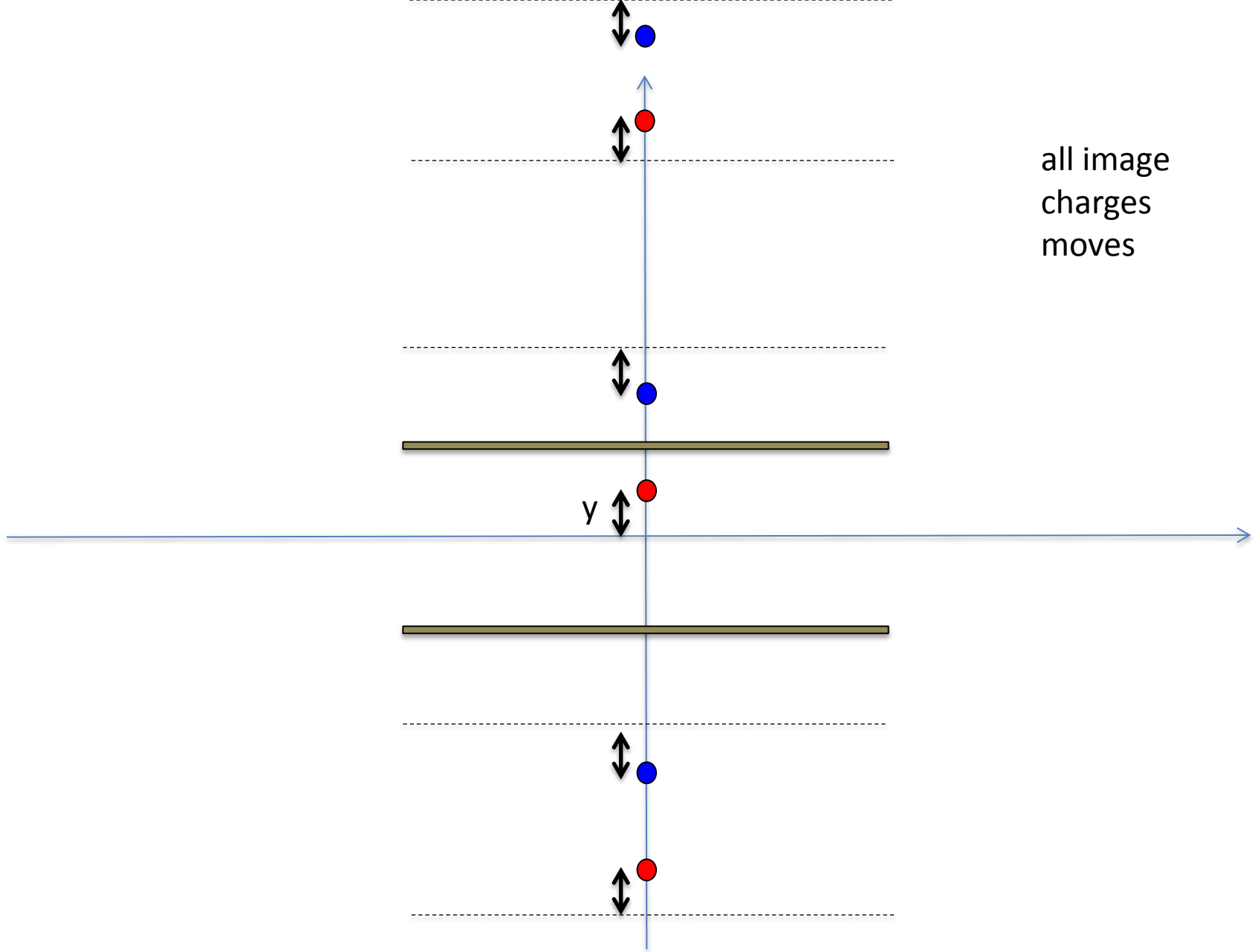

all image
charges
moves

Coherent motion

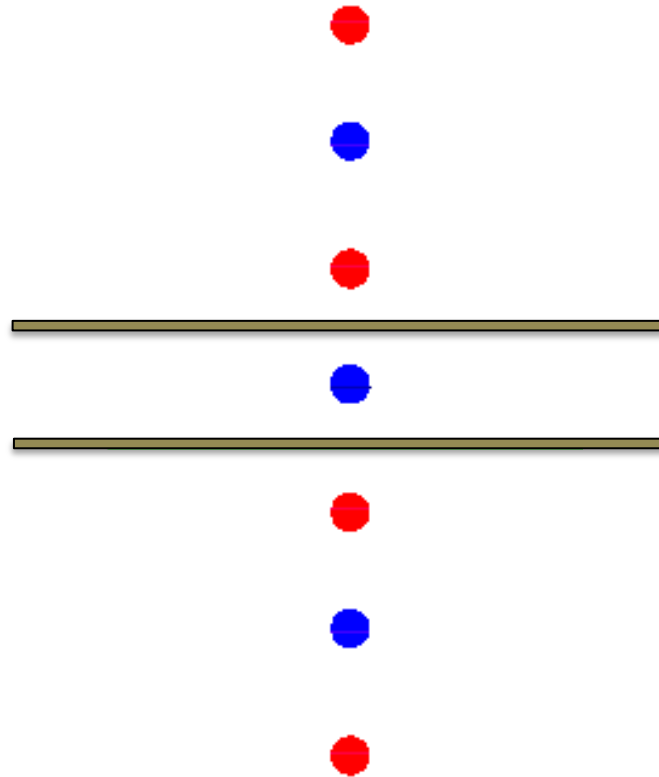

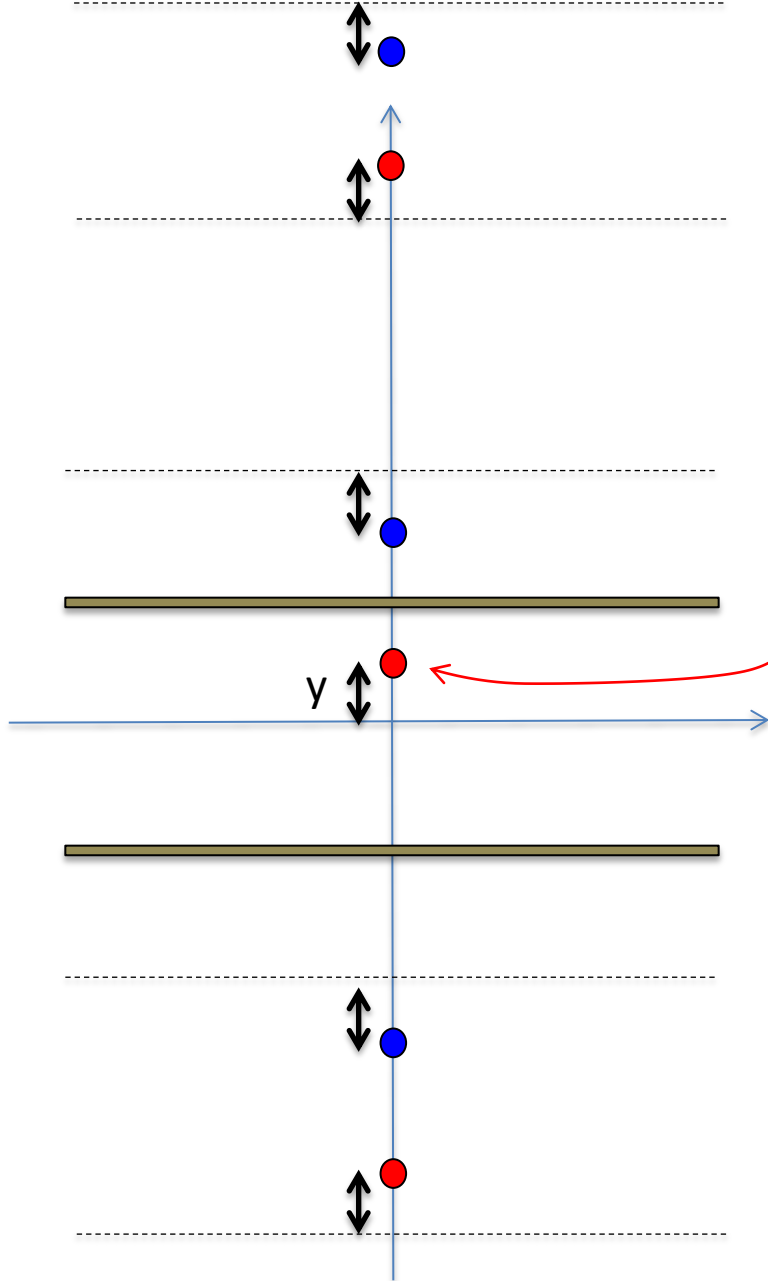

all image charges moves

Force on the beam

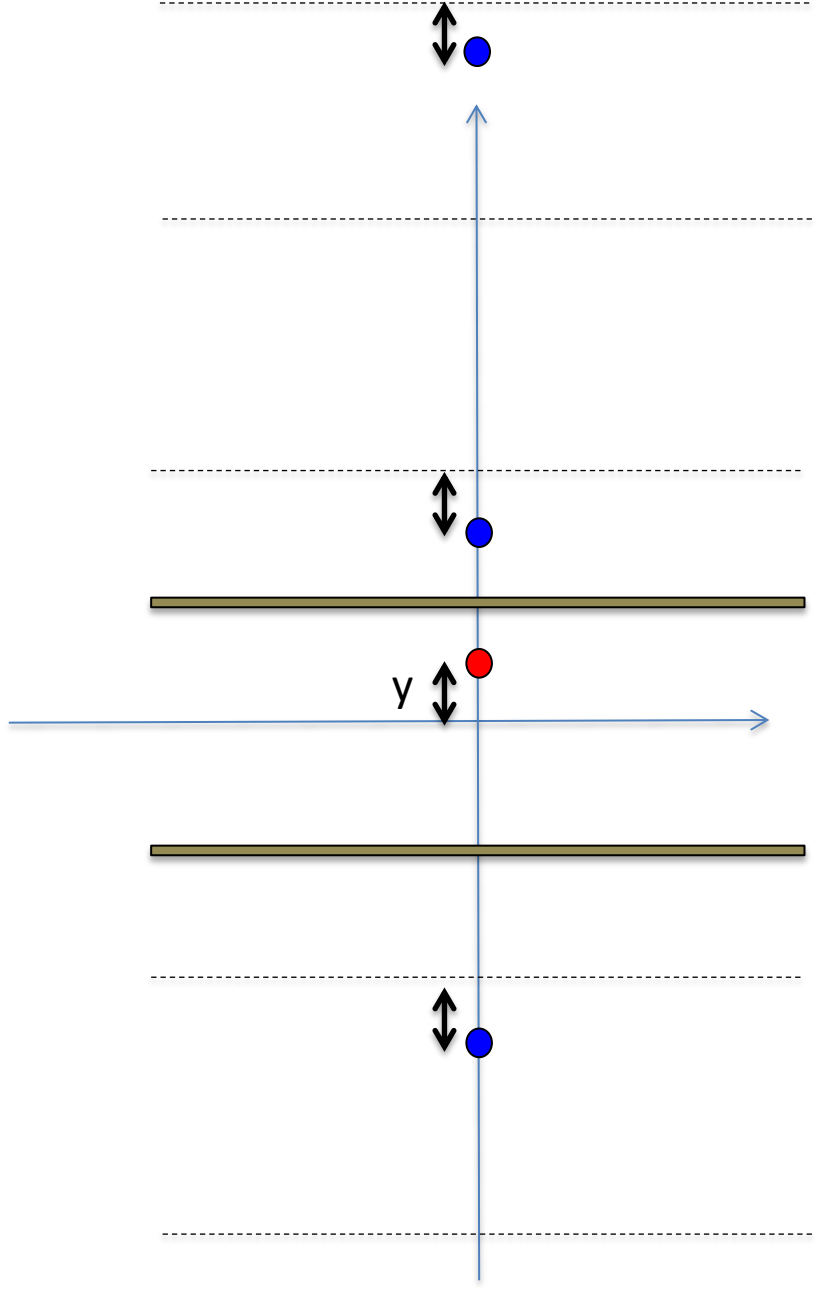

NO FORCE CREATES ON THE BEAM

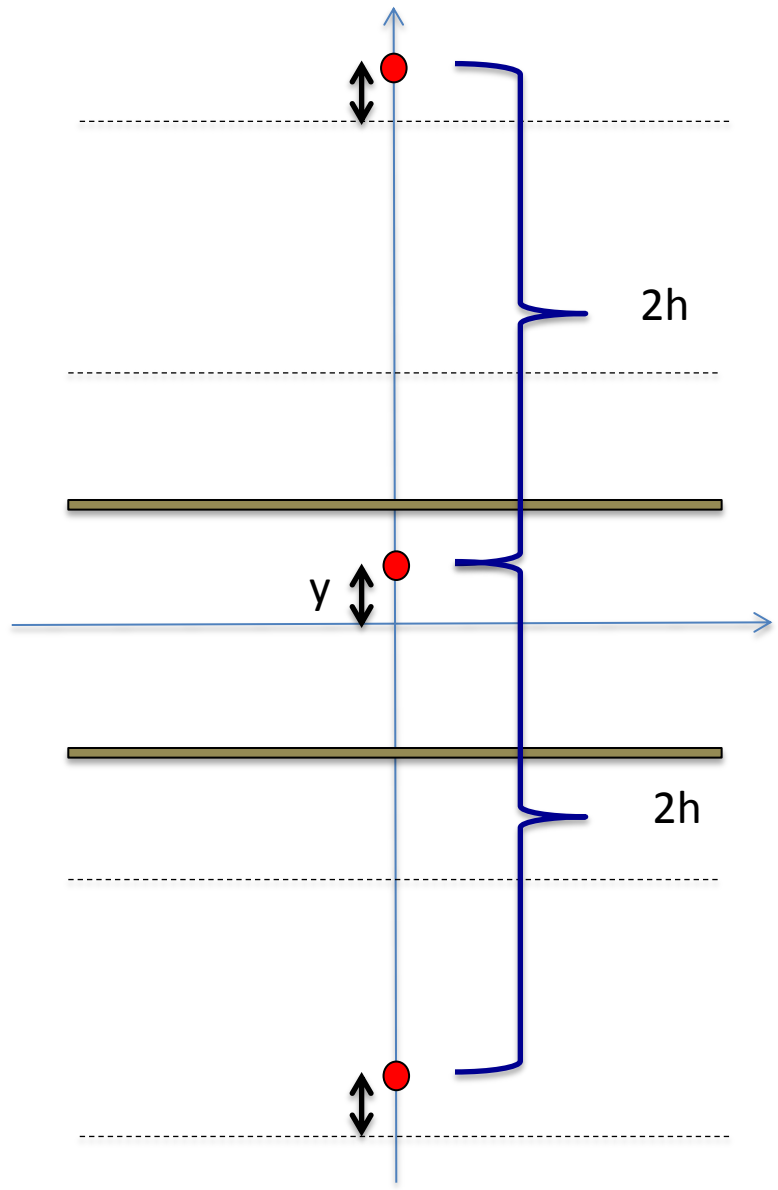

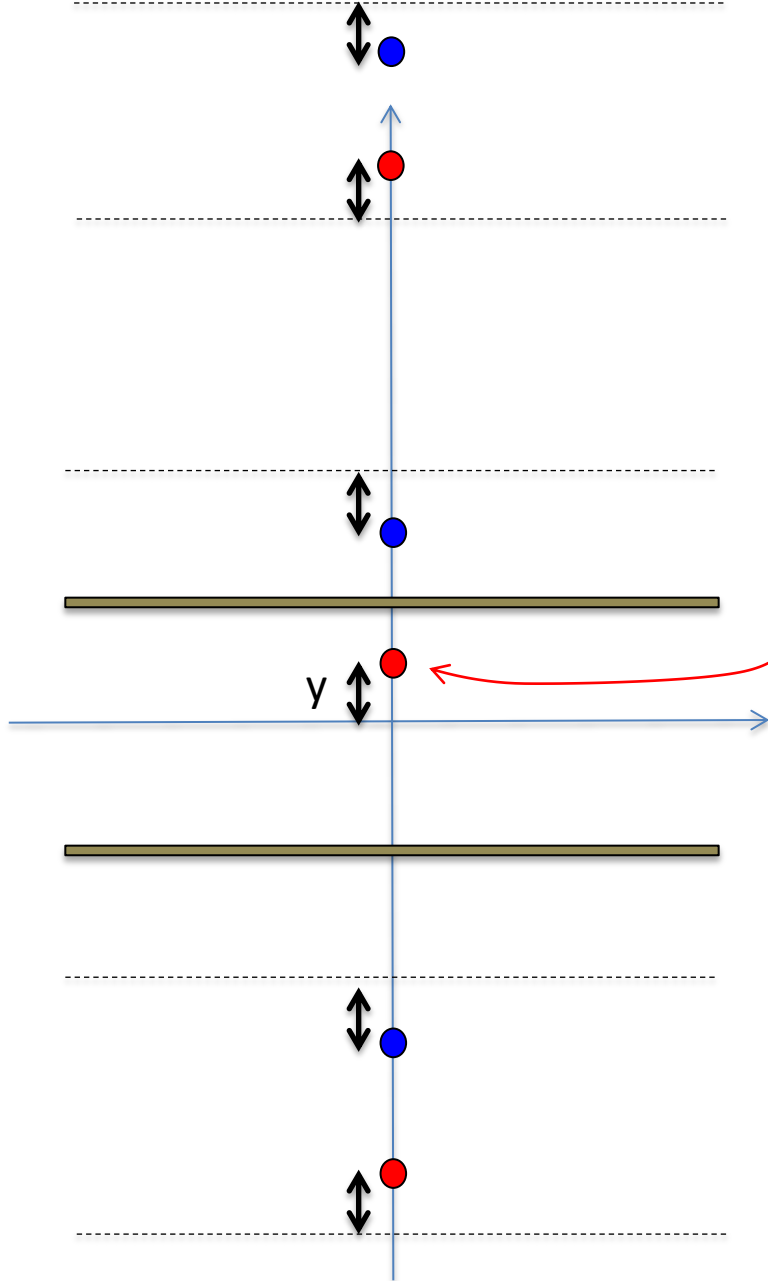

all image charges moves

Force on the beam

$$E_{y,n} = -\frac{\rho_L}{2\pi\epsilon_0} \left[\frac{1}{2nh + 2y} - \frac{1}{2nh - 2y} \right]$$

$$n = 1, 3, 5, 7, \dots$$

$$E_{y,n} = \frac{\rho_L}{2\pi\epsilon_0} \frac{4y}{(2nh)^2 - (2y)^2}$$

$$E_{y,n} = \frac{\rho_L}{2\pi\epsilon_0 h^2} y \frac{1}{n^2}$$

$$n = 1, 3, 5, 7, \dots$$

therefore

$$E_{y,n} = \frac{\rho_L}{4\pi\epsilon_0 h^2} y \left[\frac{1}{n^2} - \frac{(-1)^n}{n^2} \right] \quad (\text{trick!})$$

with $n = 1, 2, 3, 4, 5, 6, \dots$

$$E_y = \sum_{n=1}^{\infty} E_{y,n} = \frac{\rho_L}{4\pi\epsilon_0 h^2} y \left[\frac{\pi^2}{6} + \frac{\pi^2}{12} \right] = \frac{\rho_L}{16\pi\epsilon_0 h^2} \pi^2 y$$

The electric field E_x due to coherent shift is zero on the center of mass ☺

equation of motion

$$\frac{d^2 y_c}{ds^2} + k_y y_c = \frac{e}{m\gamma v_0^2} \frac{\rho_L}{16\pi\epsilon_0 h^2} \pi^2 y_c$$

but $I = v_z \rho_L \simeq v_0 \rho_L$

$$\frac{d^2 y_c}{ds^2} + k_y y_c = K \frac{\gamma^2 \pi^2}{8h^2} y_c$$

$$\frac{d^2 y_c}{ds^2} + \left(k_y - 2K \frac{\gamma^2 \pi^2}{16h^2} \right) y_c = 0$$

Coherent detuning

$$\Delta Q_{y,c} \simeq -\frac{R_m^2}{Q_y} K \frac{\gamma^2 \pi^2}{16h^2}$$

The Collective Effects

Thanks to Oliver Boine-Frankenheim, I. Hofmann, U. Niedermayer,
D. Brandt

Interaction of the beam with the environment

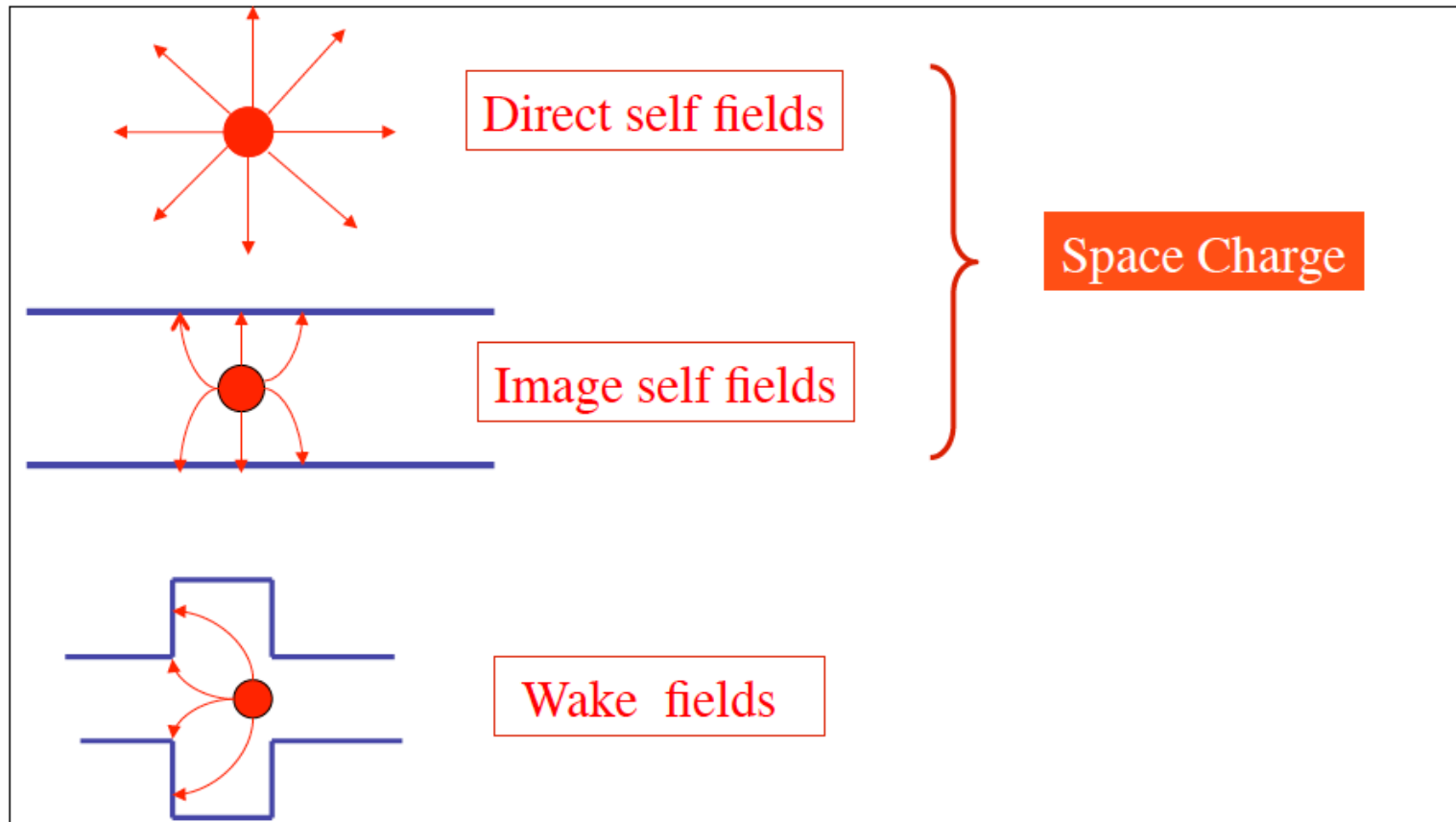

Effect on the dynamics

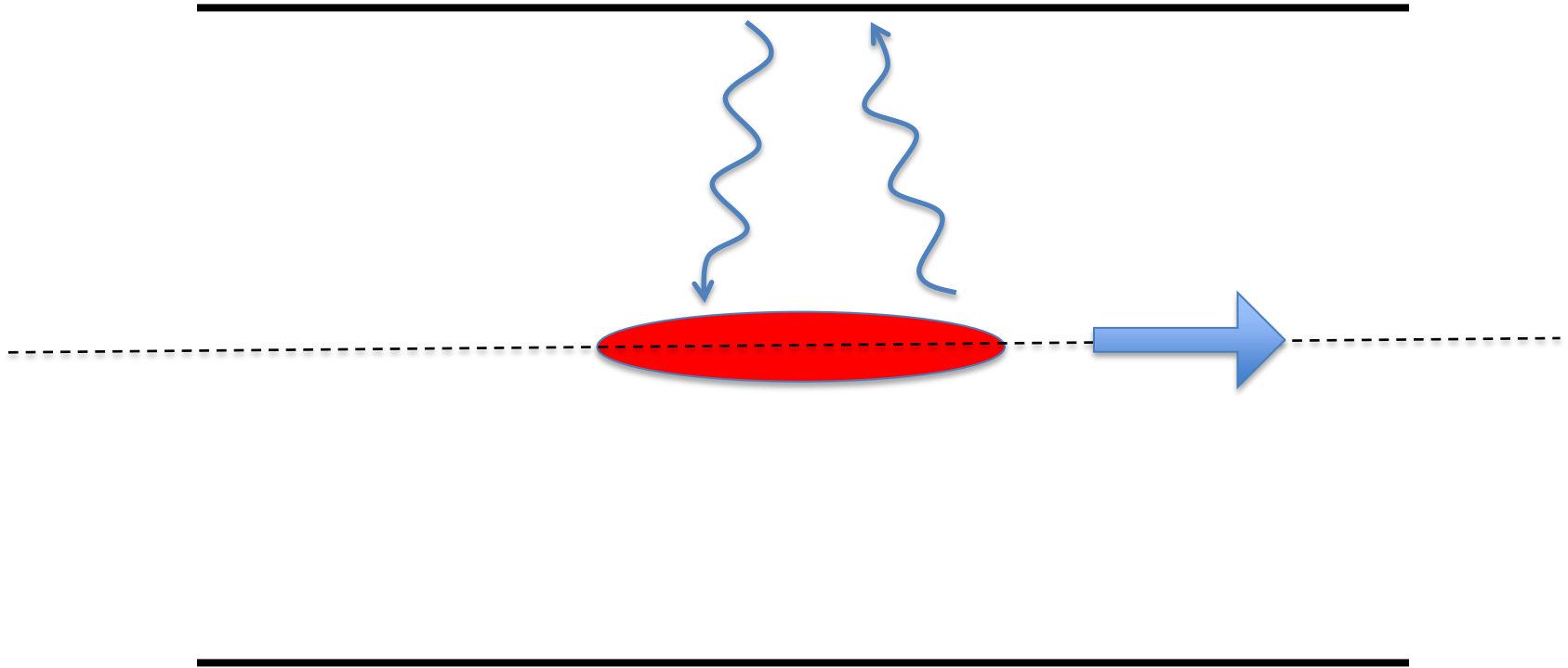

Resistive wall effect:
Finite conductivity



Narrow-band resonators:
Cavity-like objects

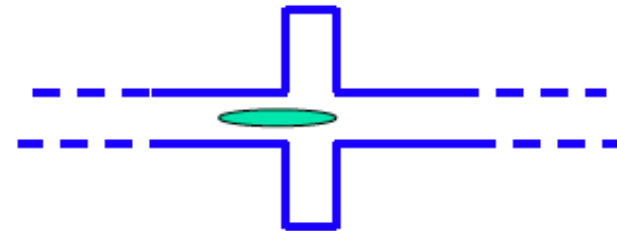

Broad-band resonators:
Tapers, other non-resonant structures



Wake Field

Cavities

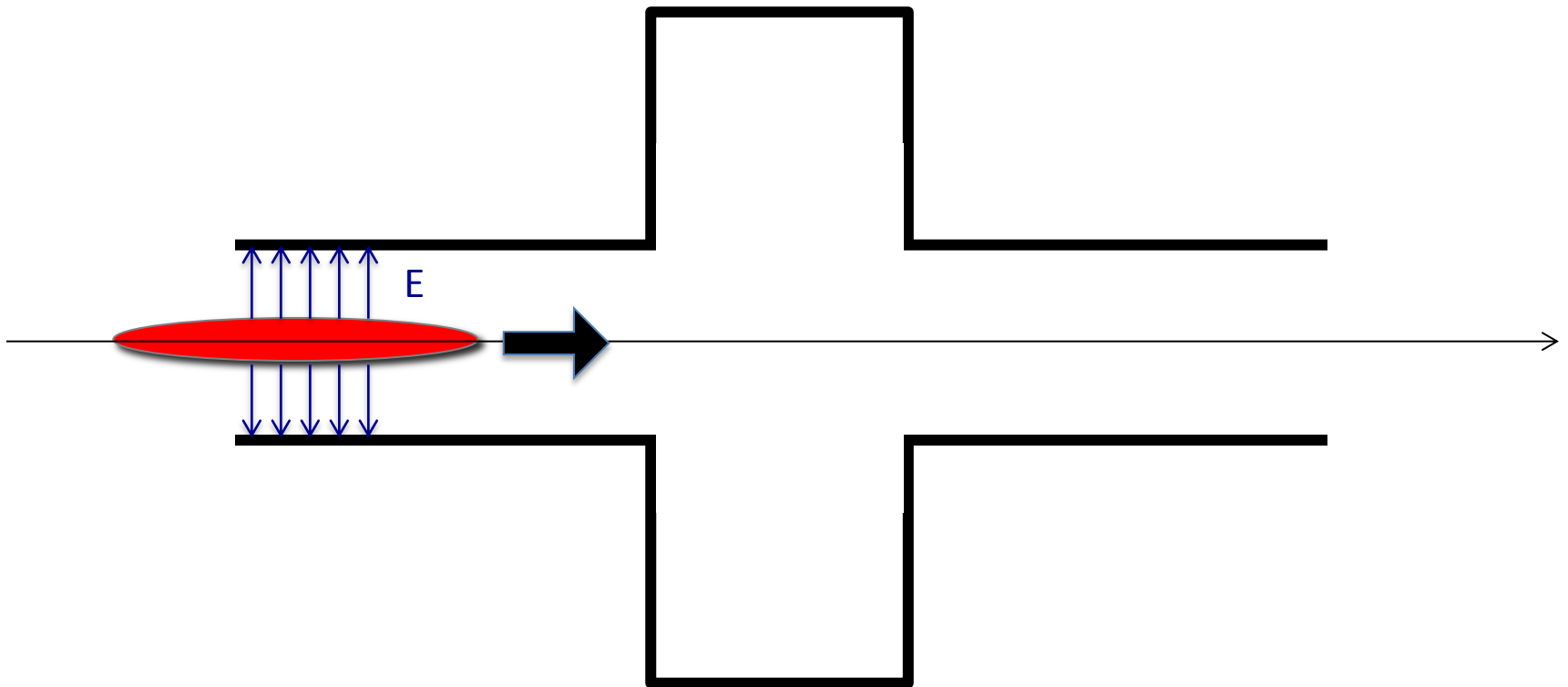

Cavities

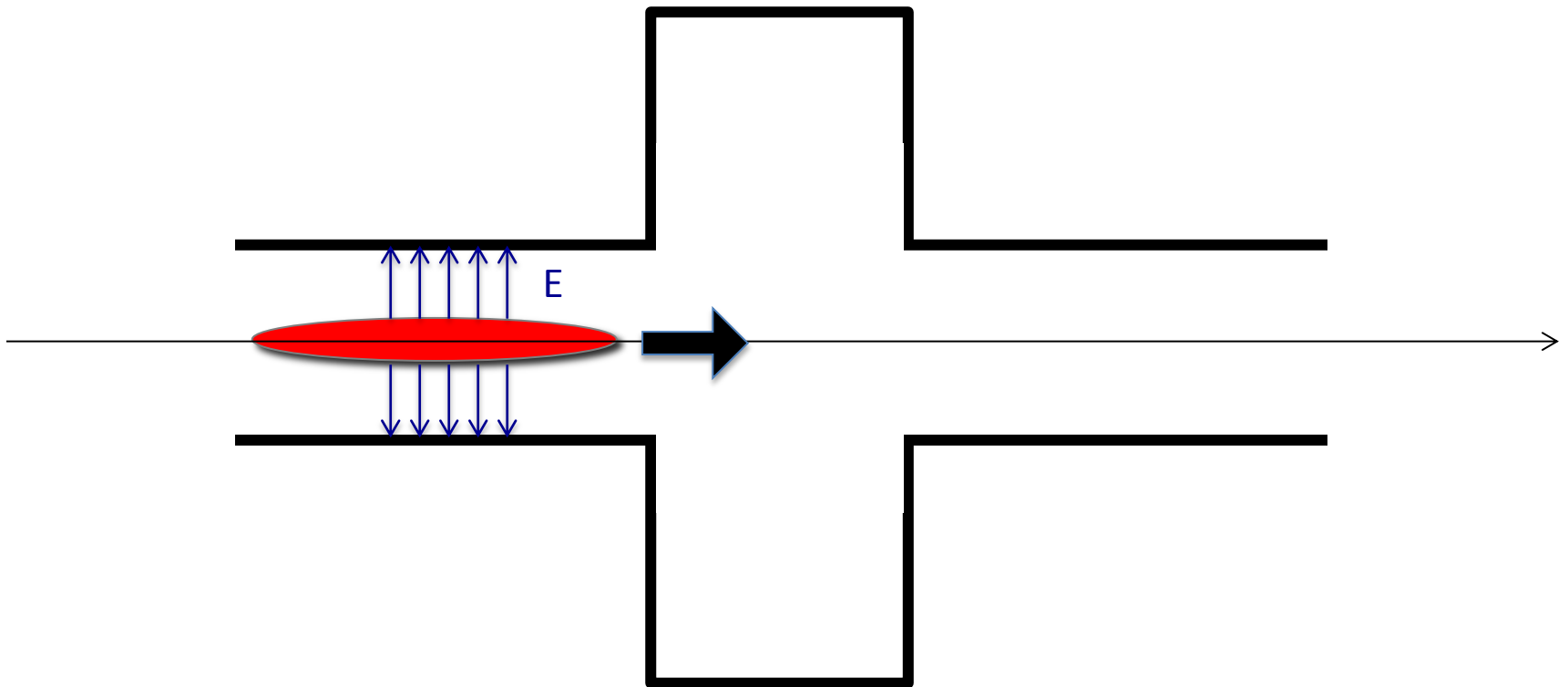

Cavities

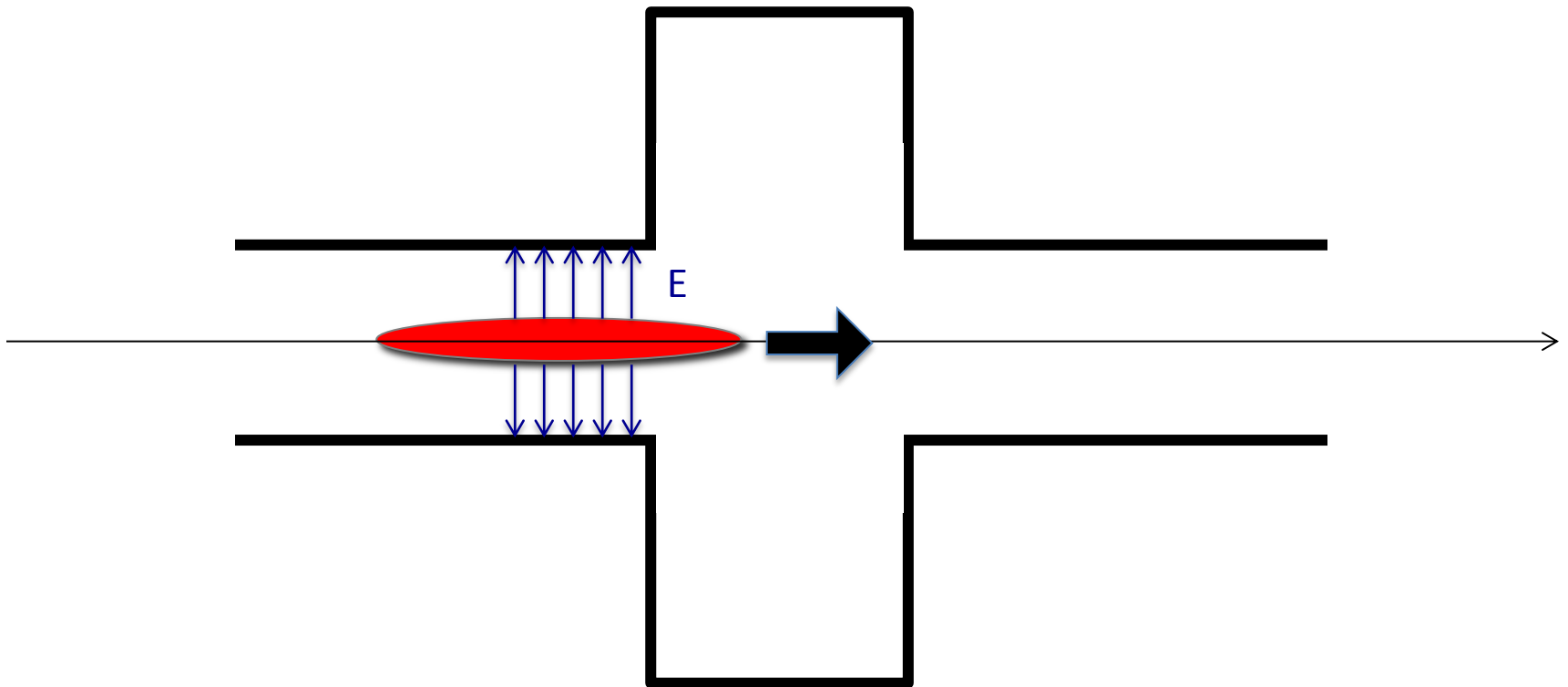

Cavities

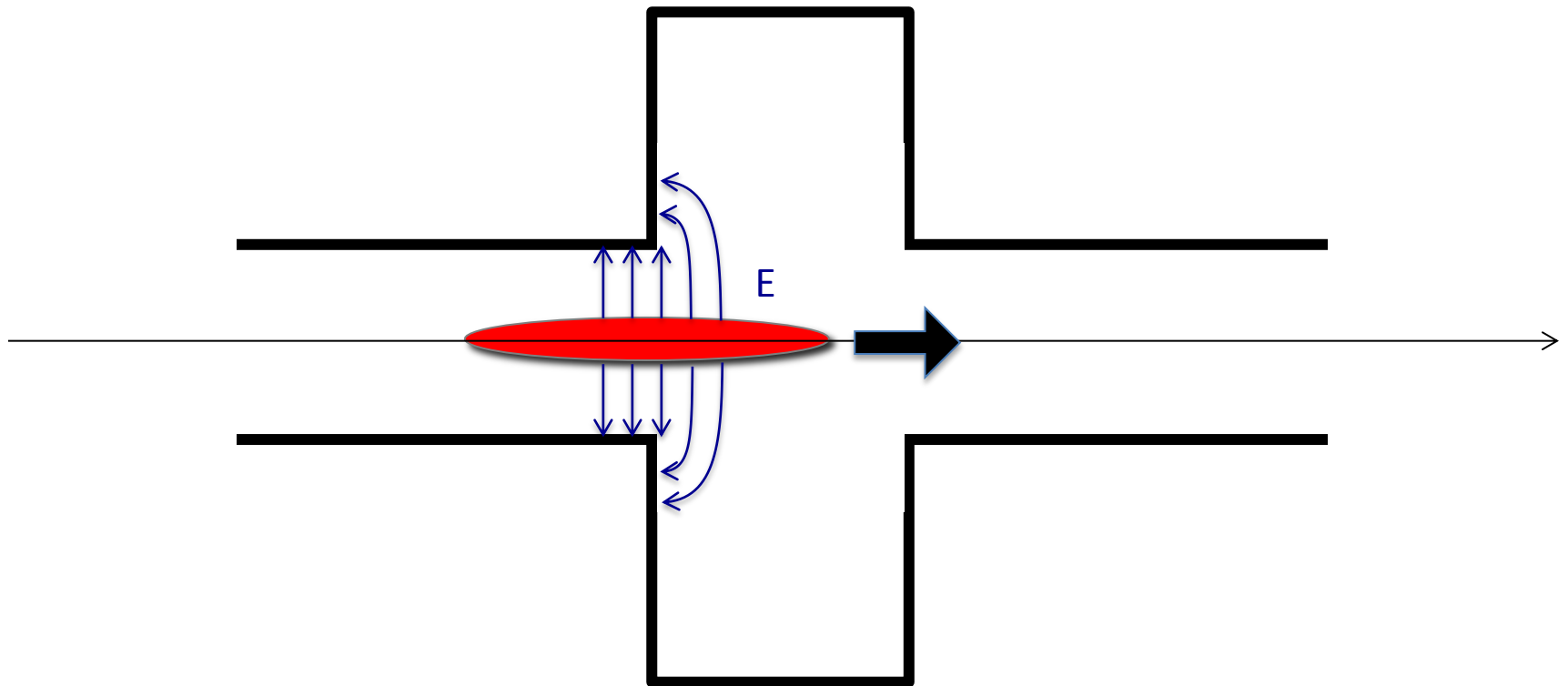

Cavities

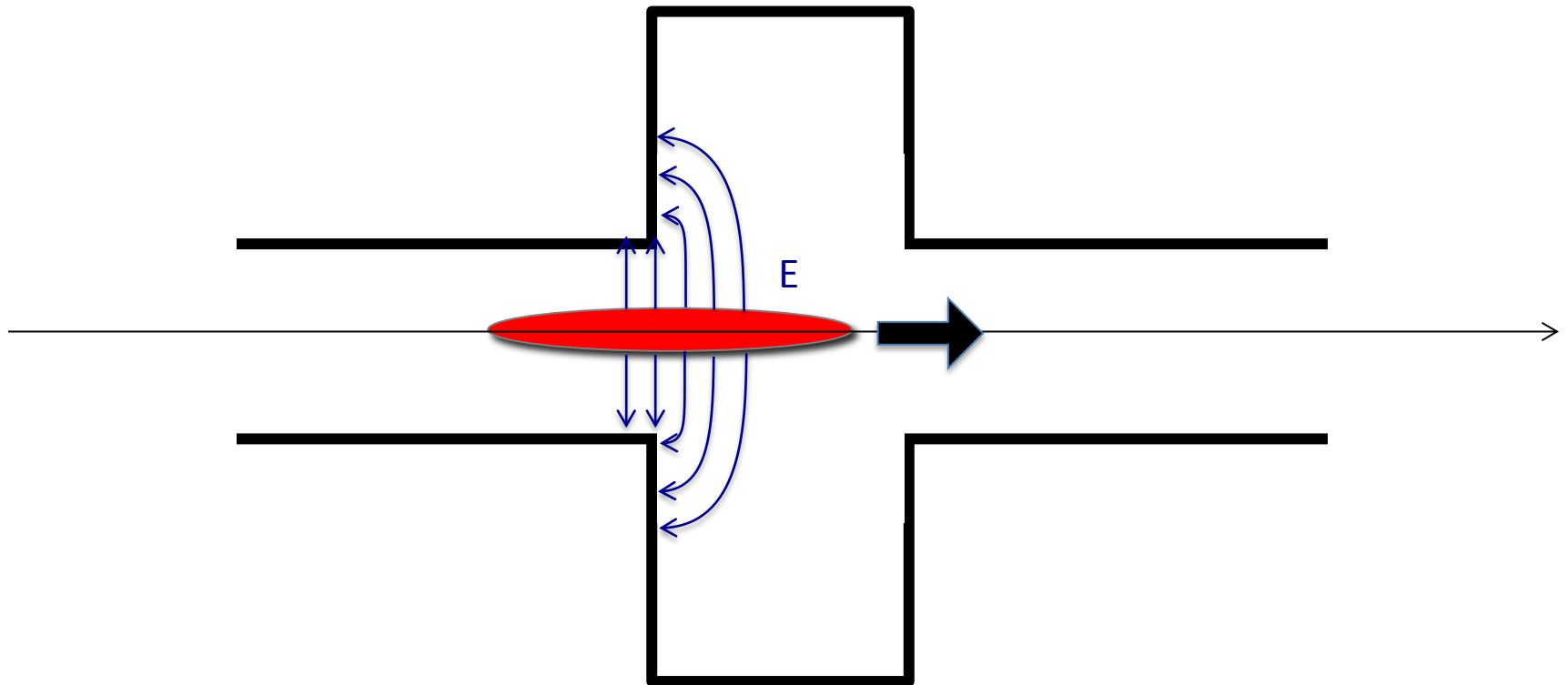

Cavities

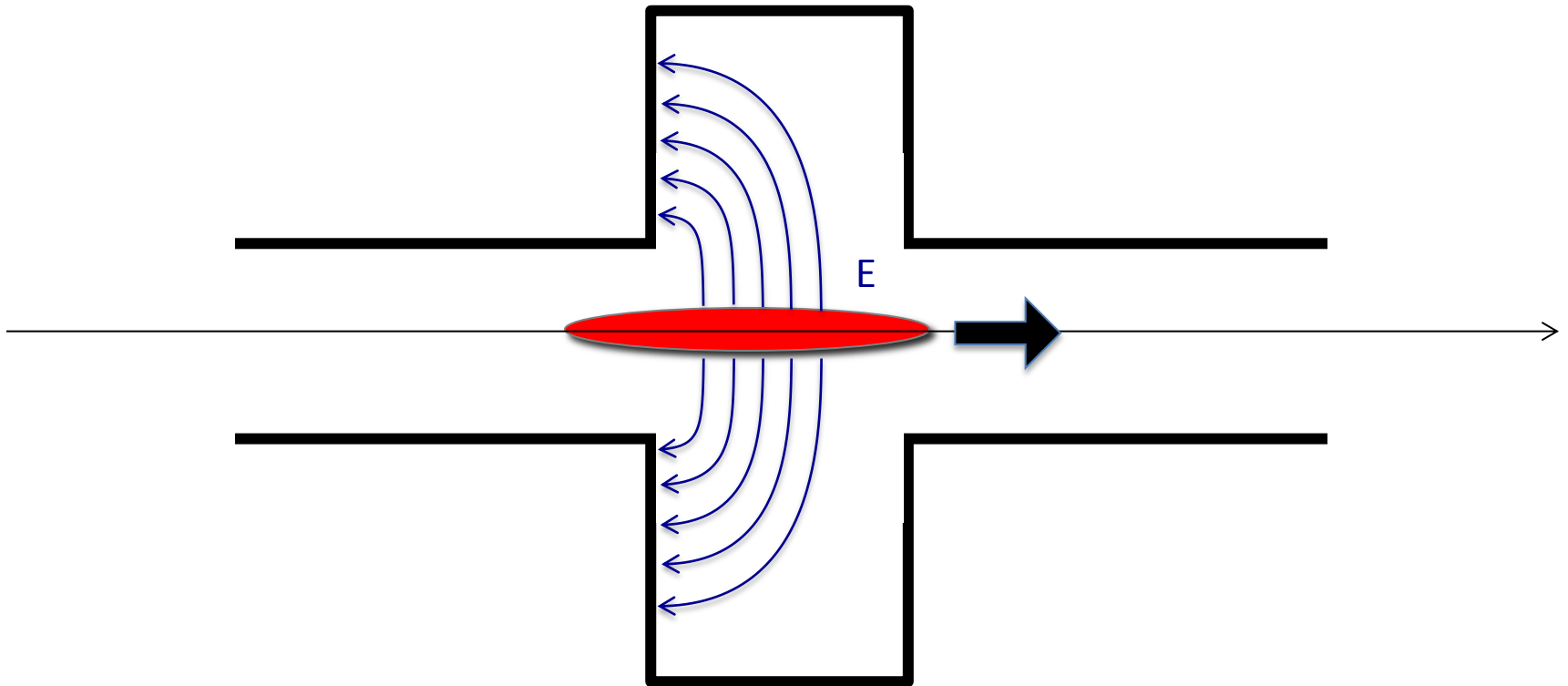

Cavities

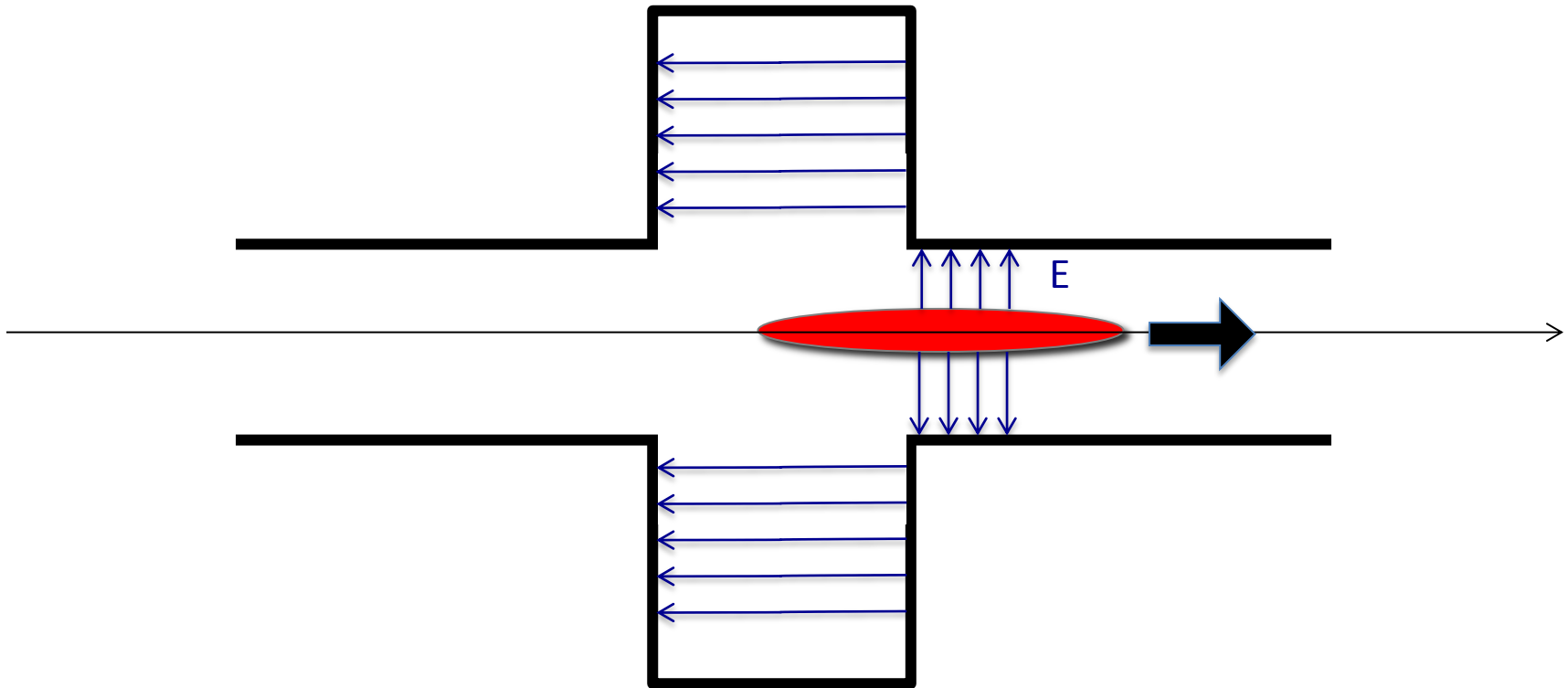

Cavities

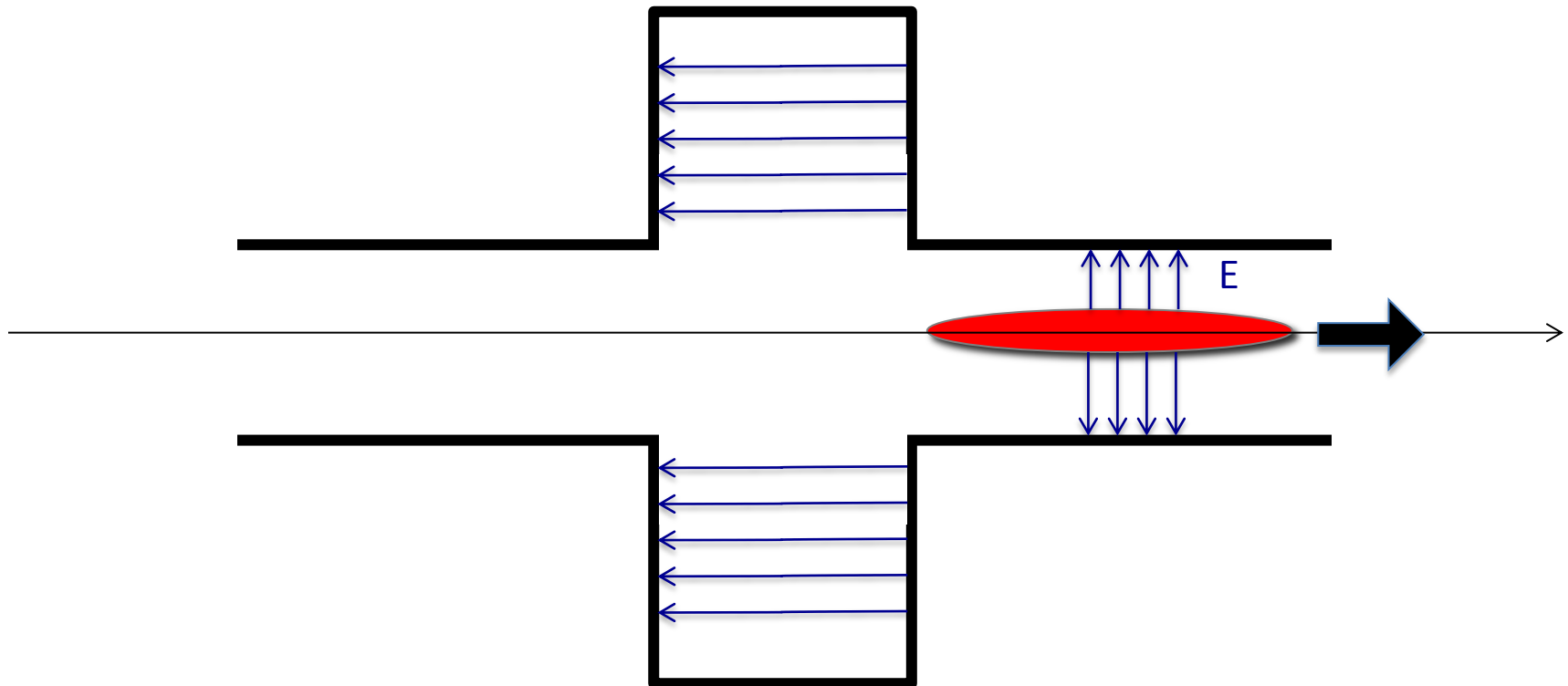

Cavities

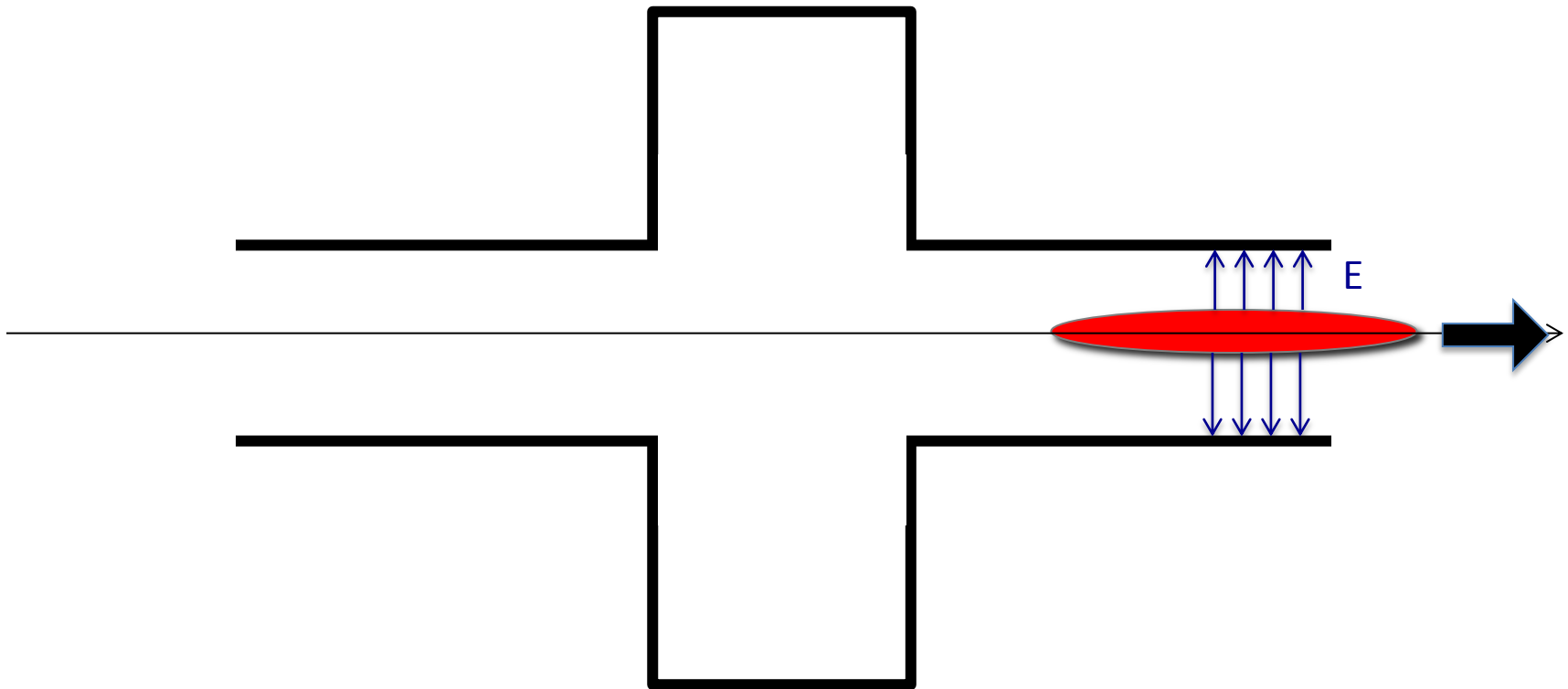

Cavities

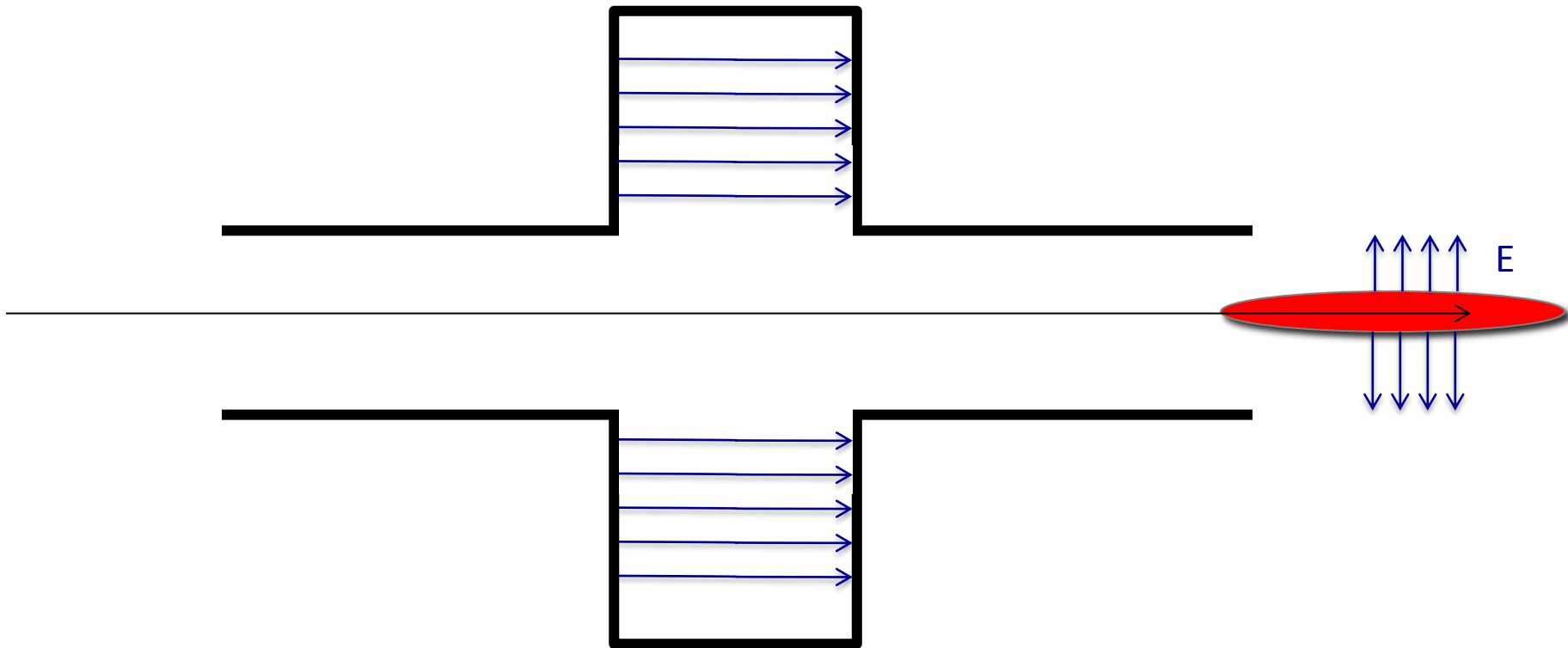

Cavities

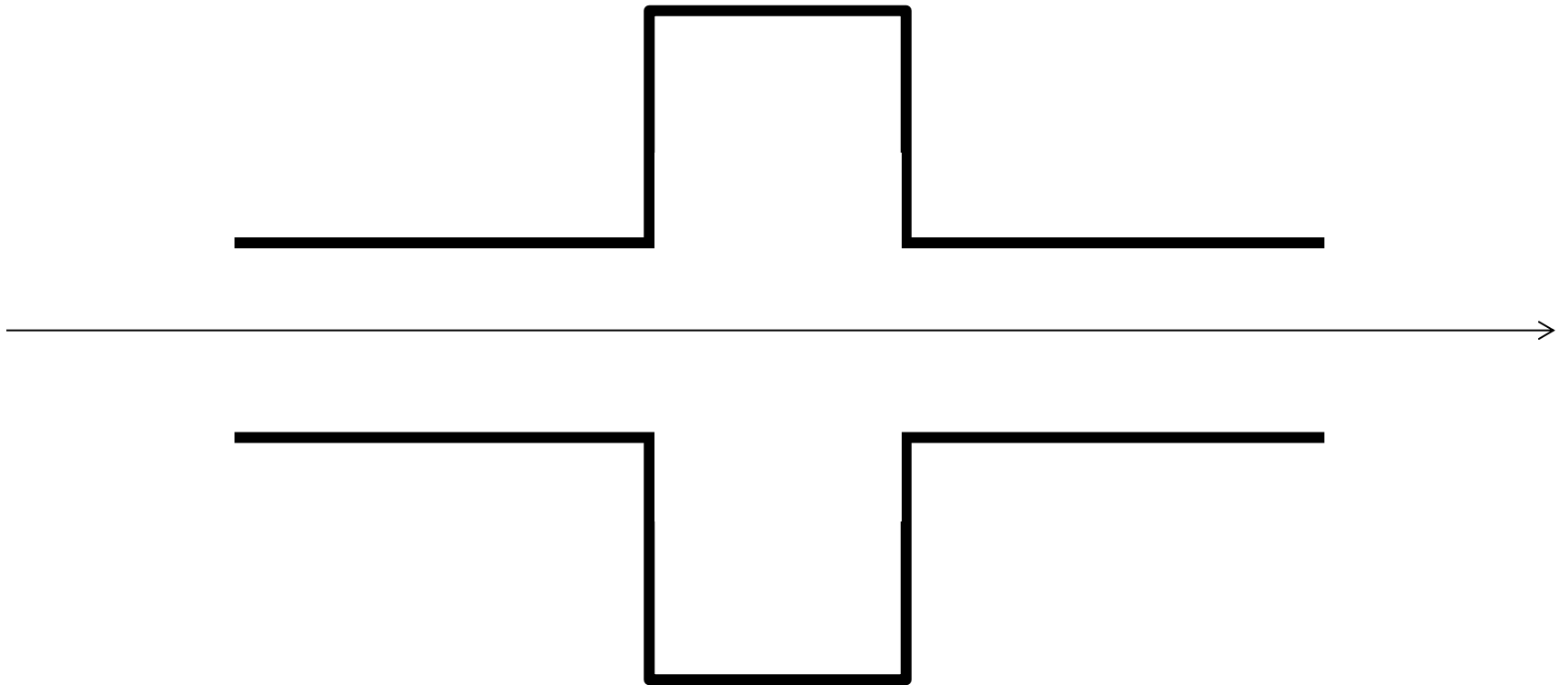

Cavities

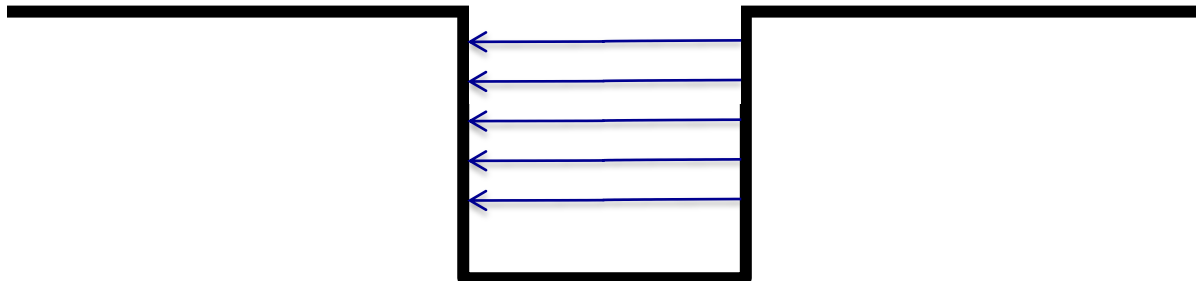
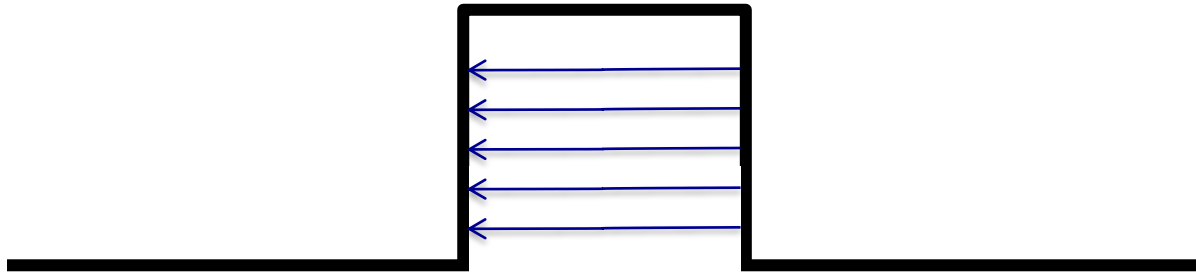

MODEL

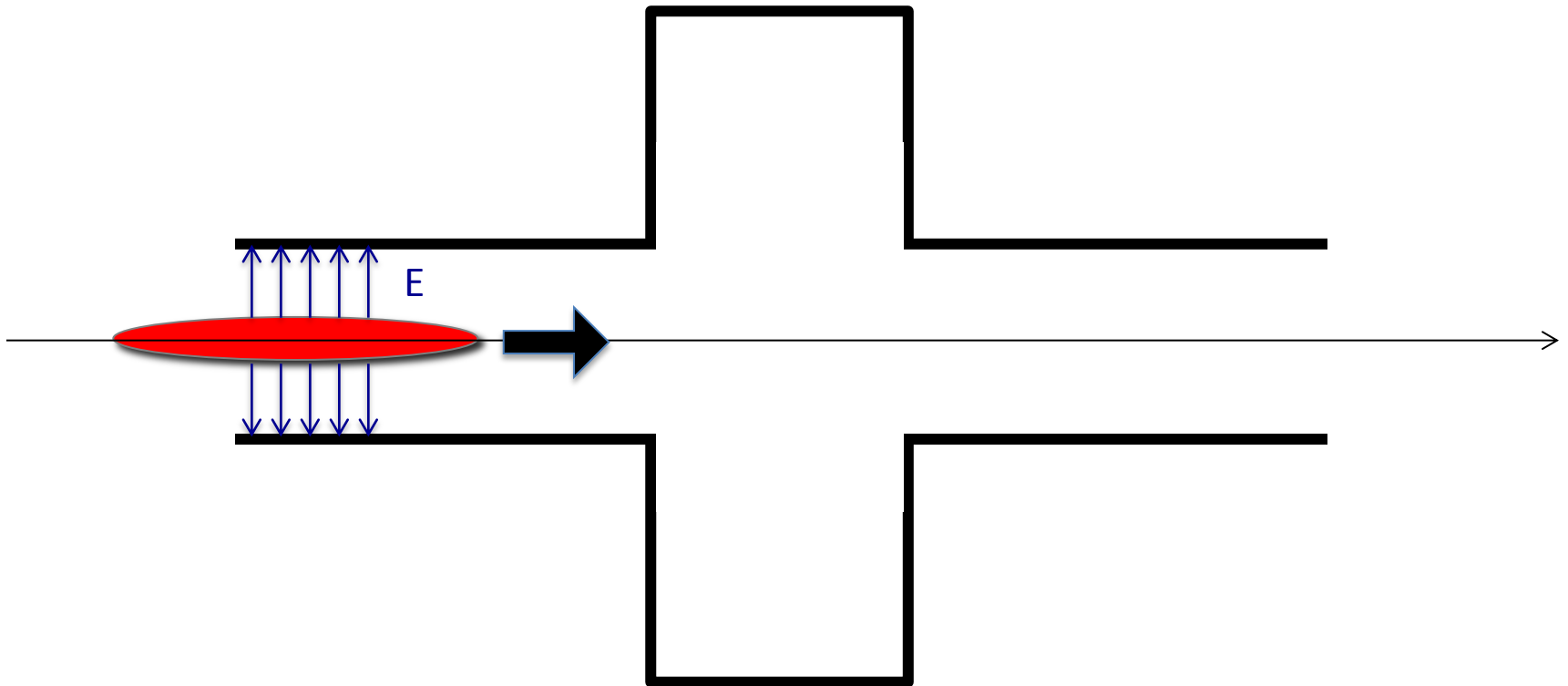

MODEL

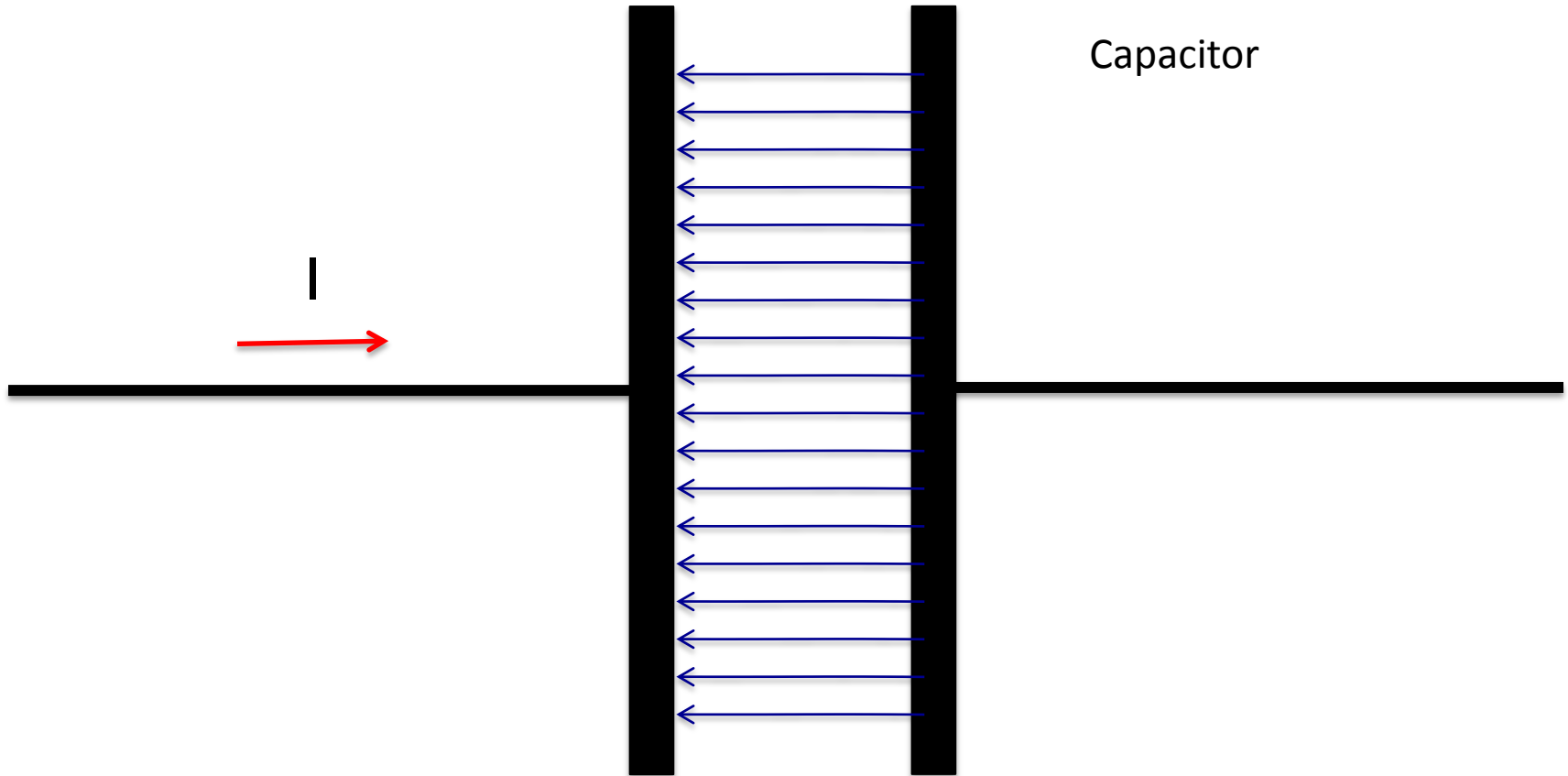

MODEL

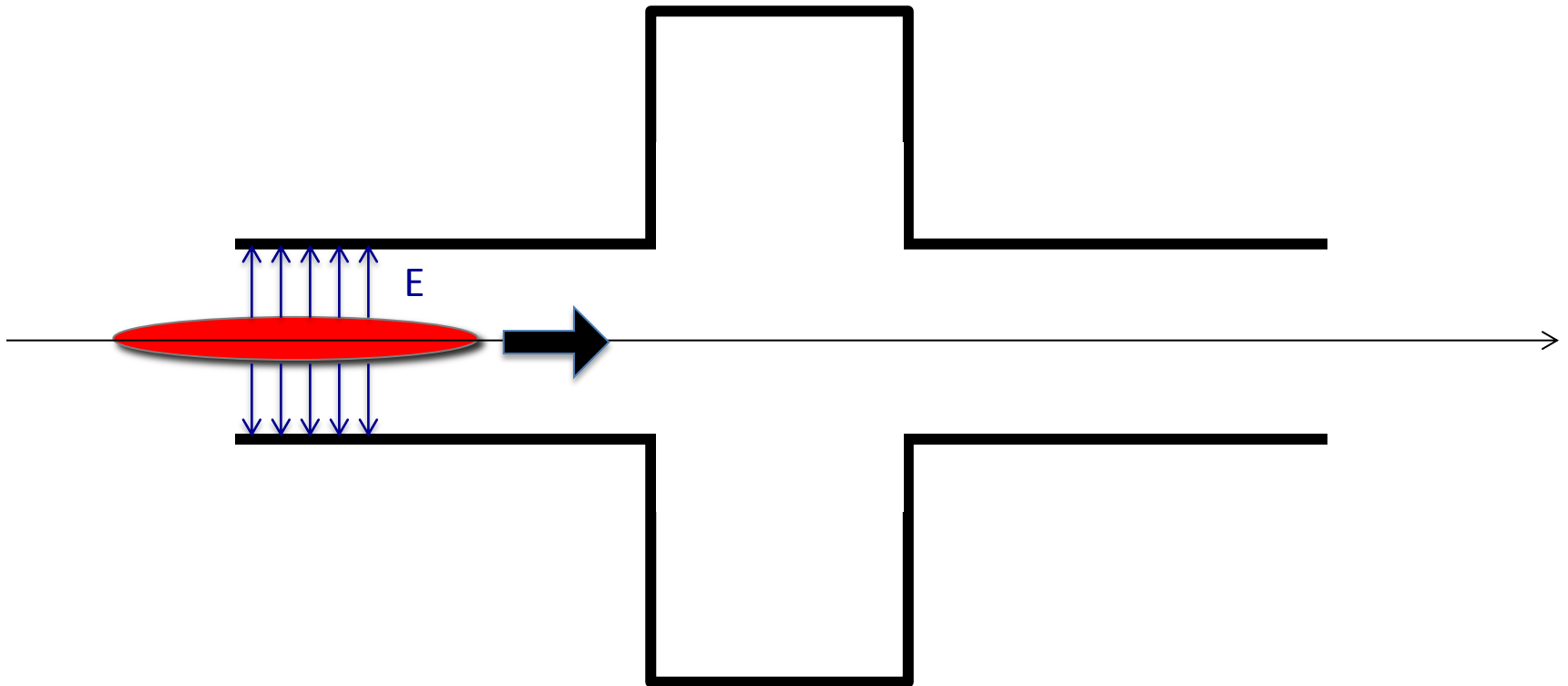

MODEL

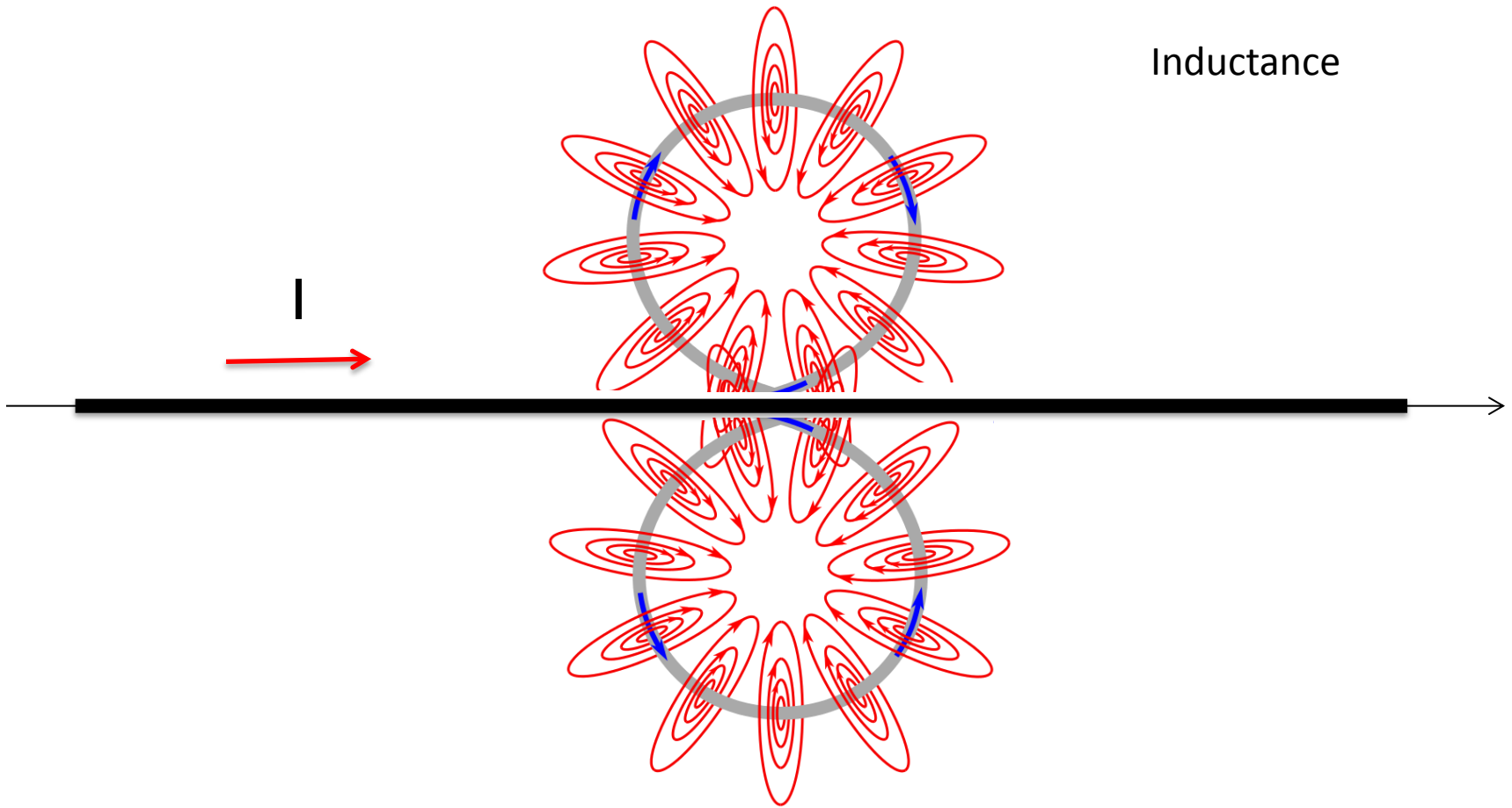

MODEL

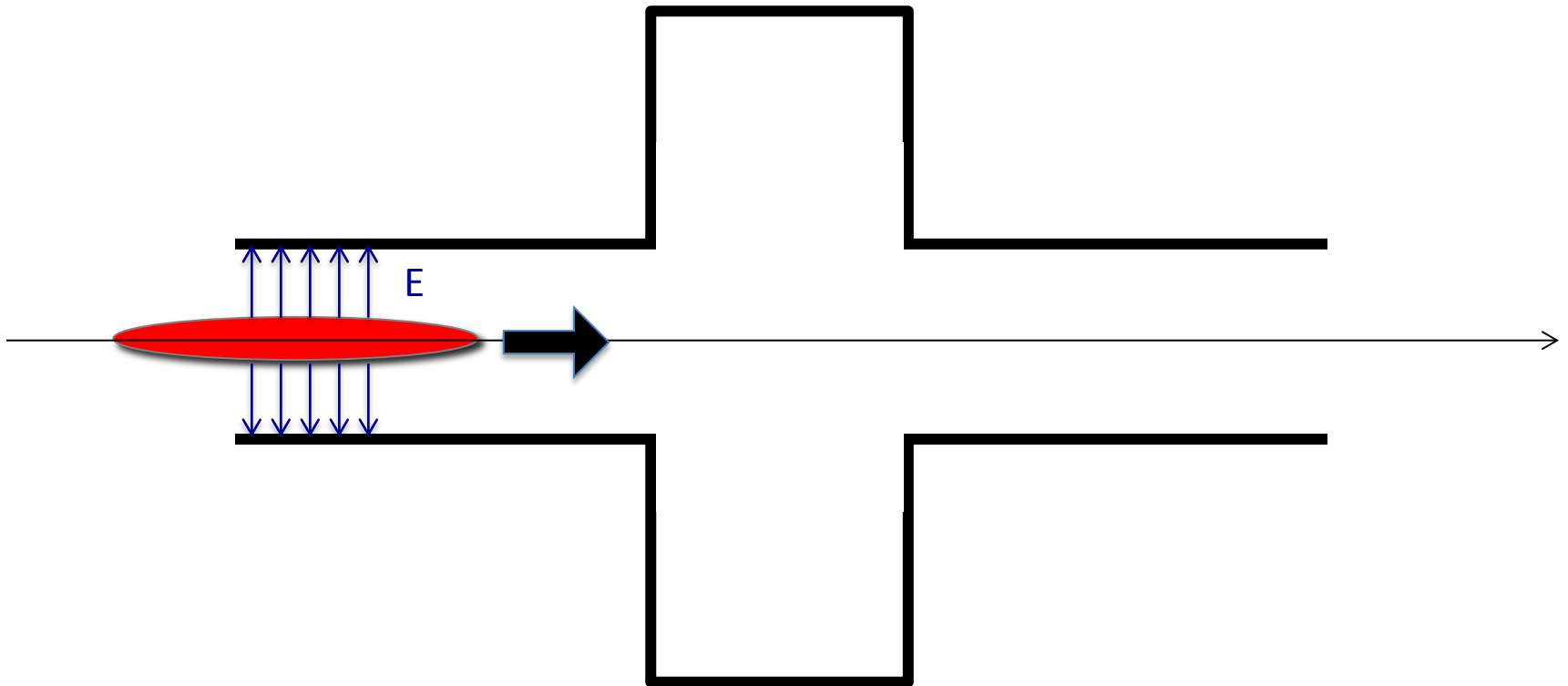

MODEL

Resistance

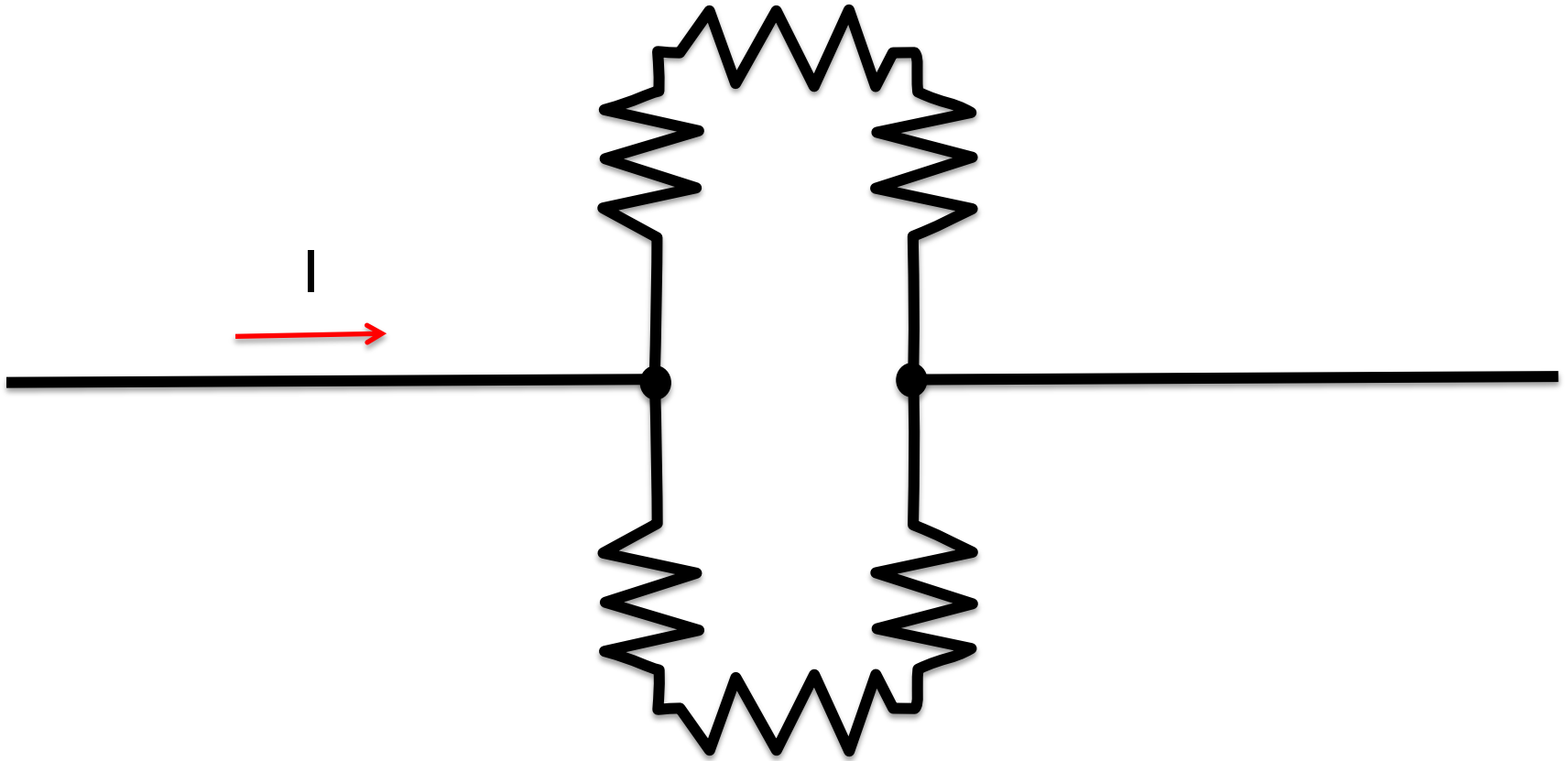

All together

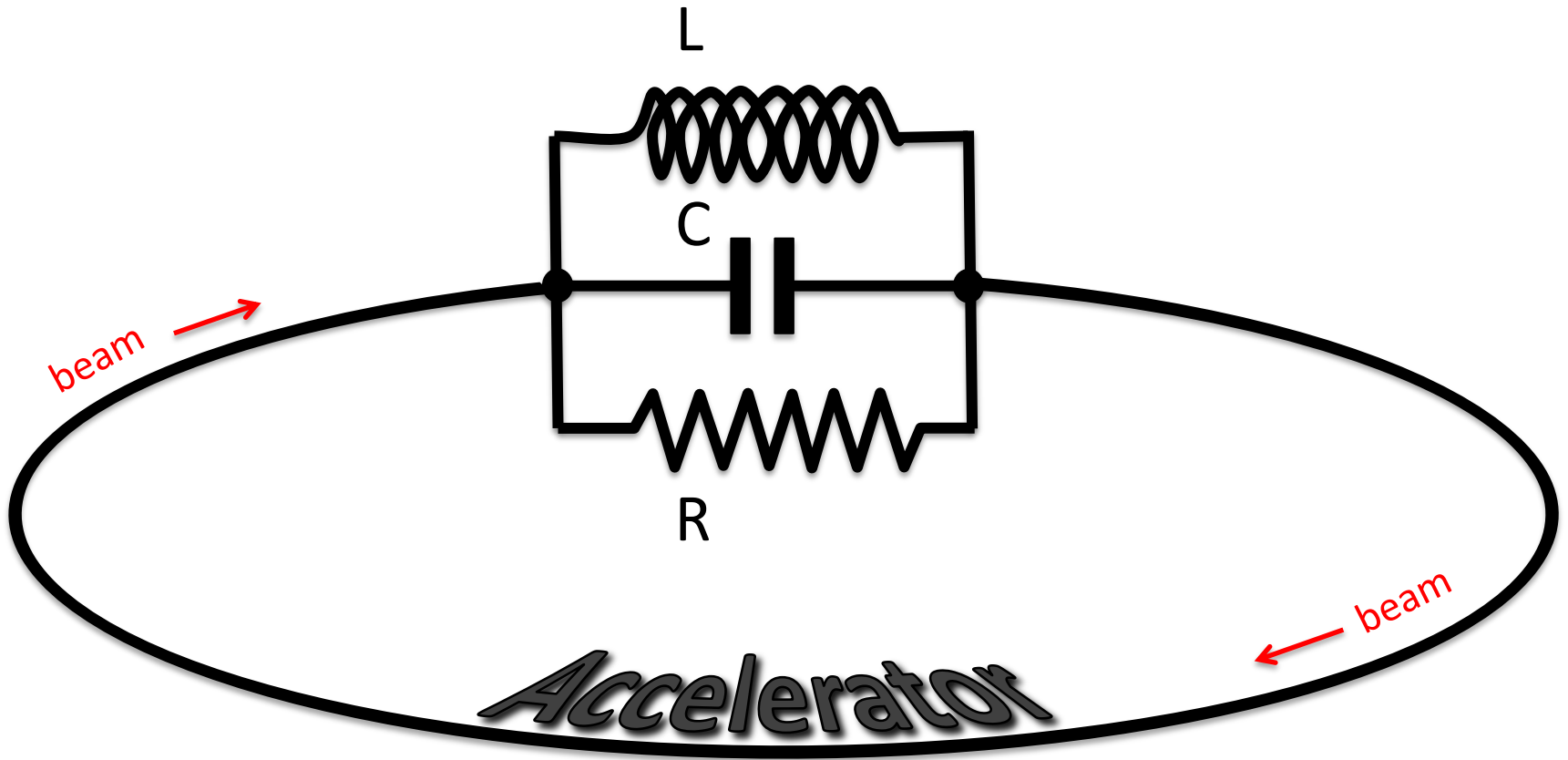

RLC Features

Isolated RLC

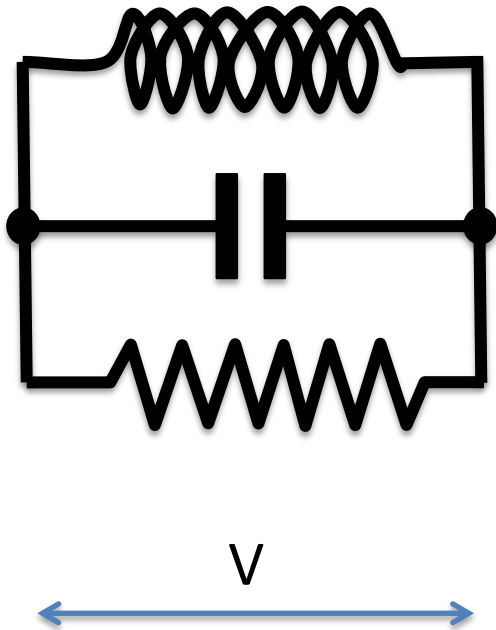

Resonance frequency

$$\omega_r = \frac{1}{\sqrt{LC}}$$

Quality factor

$$Q = R\sqrt{\frac{C}{L}}$$

Damping rate

$$\alpha = \frac{\omega_r}{2Q}$$

Meaning

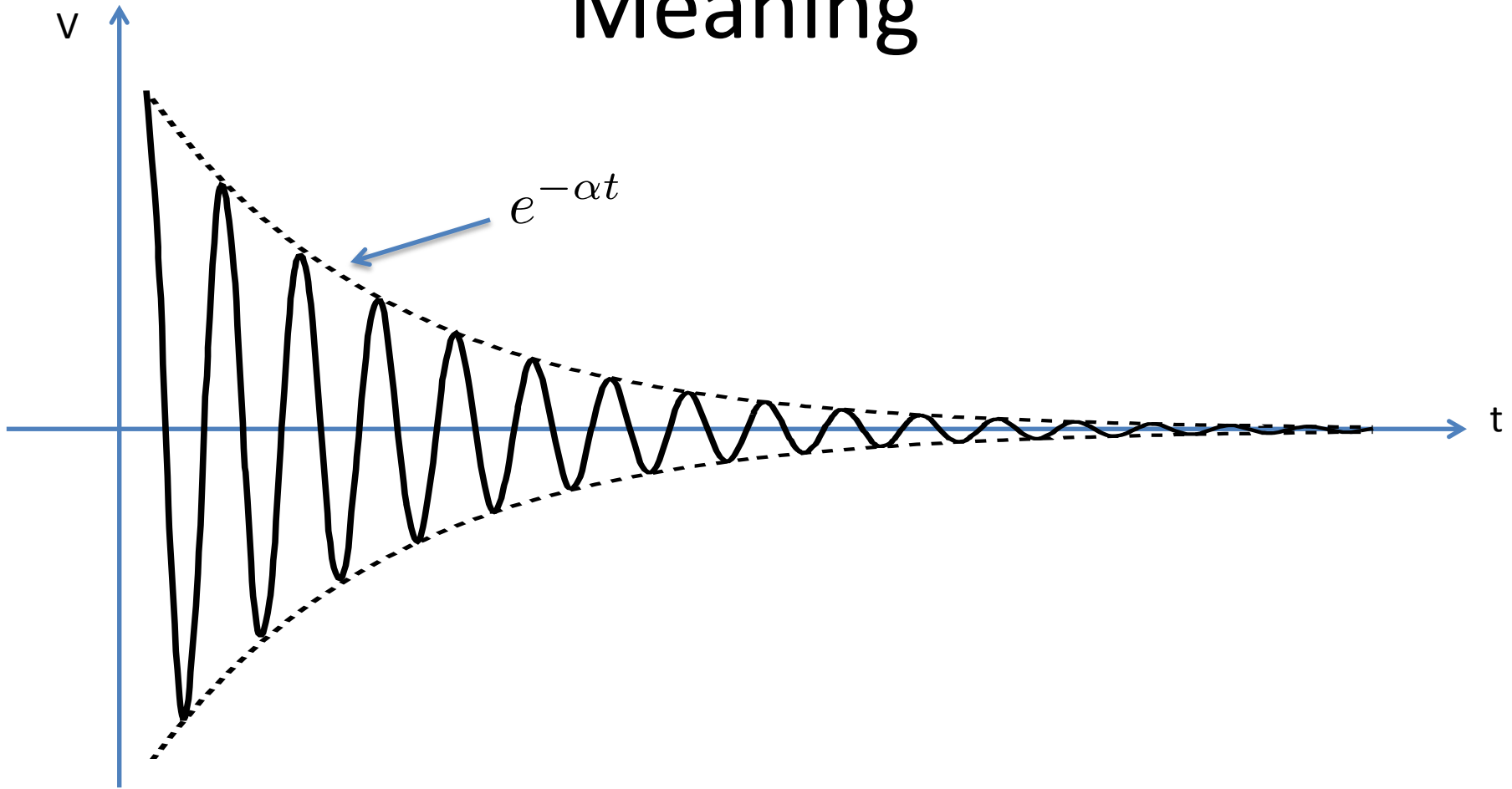

$$V(t) = e^{-\alpha t} \left[A \cos \left(\omega_r \sqrt{1 - \frac{1}{4Q^2}} t \right) + B \sin \left(\omega_r \sqrt{1 - \frac{1}{4Q^2}} t \right) \right]$$

Response to one particle

What happens when one particle goes through the cavity ?

Before

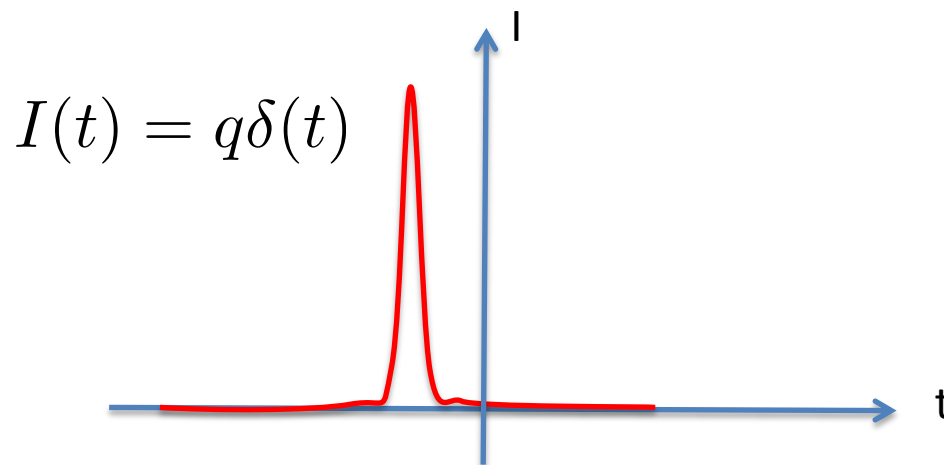

$$V(0^-) = 0$$

$$\dot{V}(0^-) = 0$$



Response to one particle

After

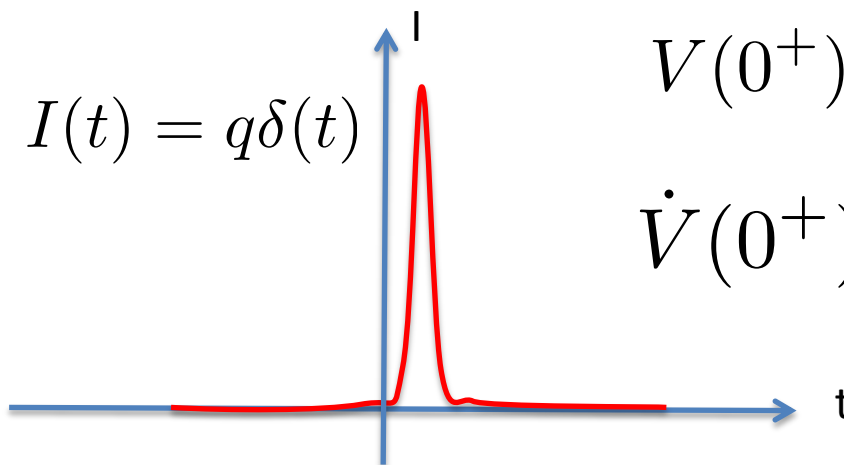

$$V(0^+) = \frac{q}{C}$$

$$\dot{V}(0^+) = -\frac{2\omega_r k_{pm}}{Q} q$$



Pulse Response

$$V(t) = 2qk_{pm}e^{-\alpha t} \left[\cos \left(\omega_r \sqrt{1 - \frac{1}{4Q^2}} t \right) - \frac{\sin \left(\omega_r \sqrt{1 - \frac{1}{4Q^2}} t \right)}{2Q \sqrt{1 - \frac{1}{4Q^2}}} \right]$$

This is the potential in the cavity

Green or wake function

$$G(t) = \frac{V(t)}{q}$$

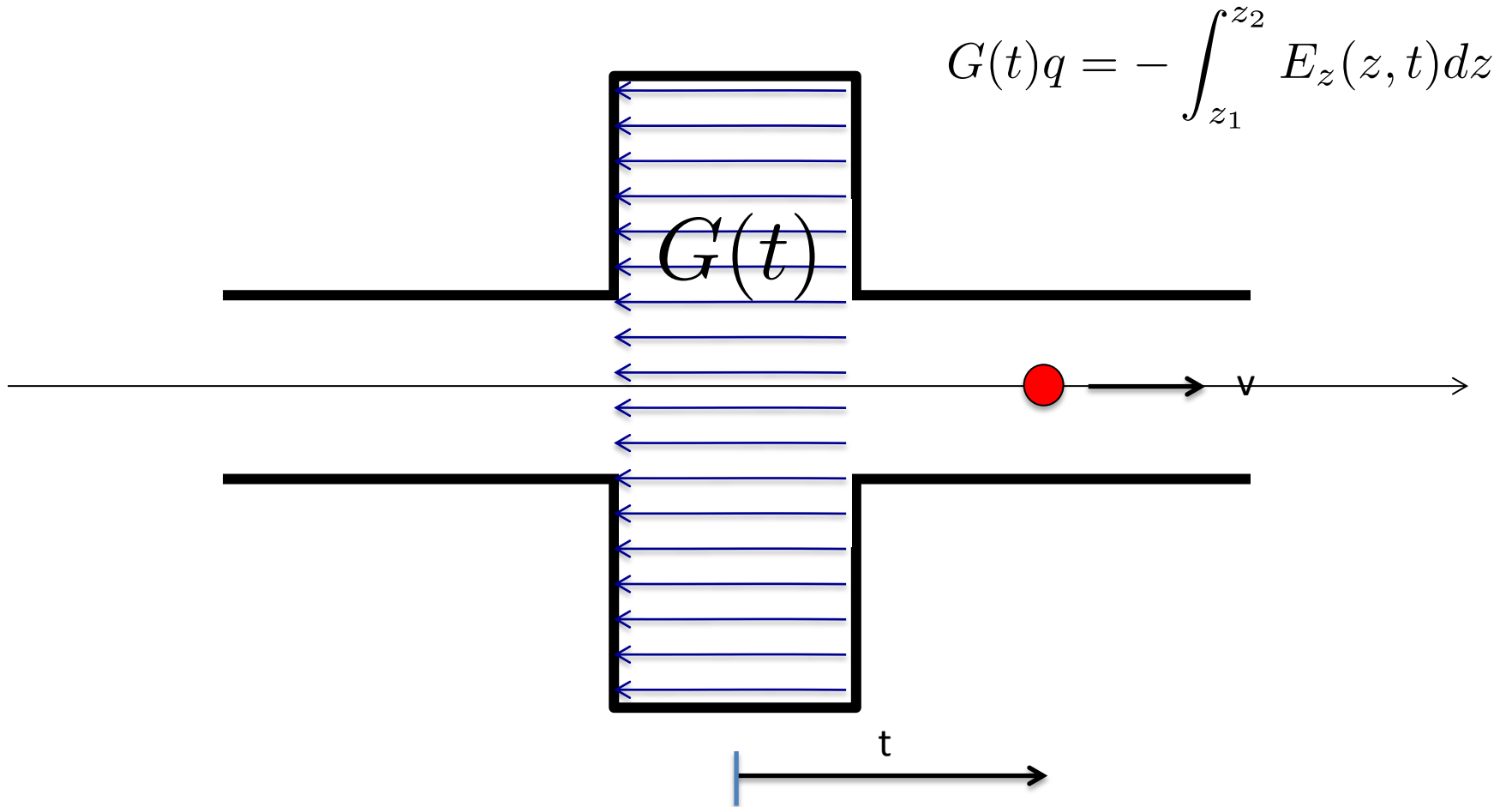

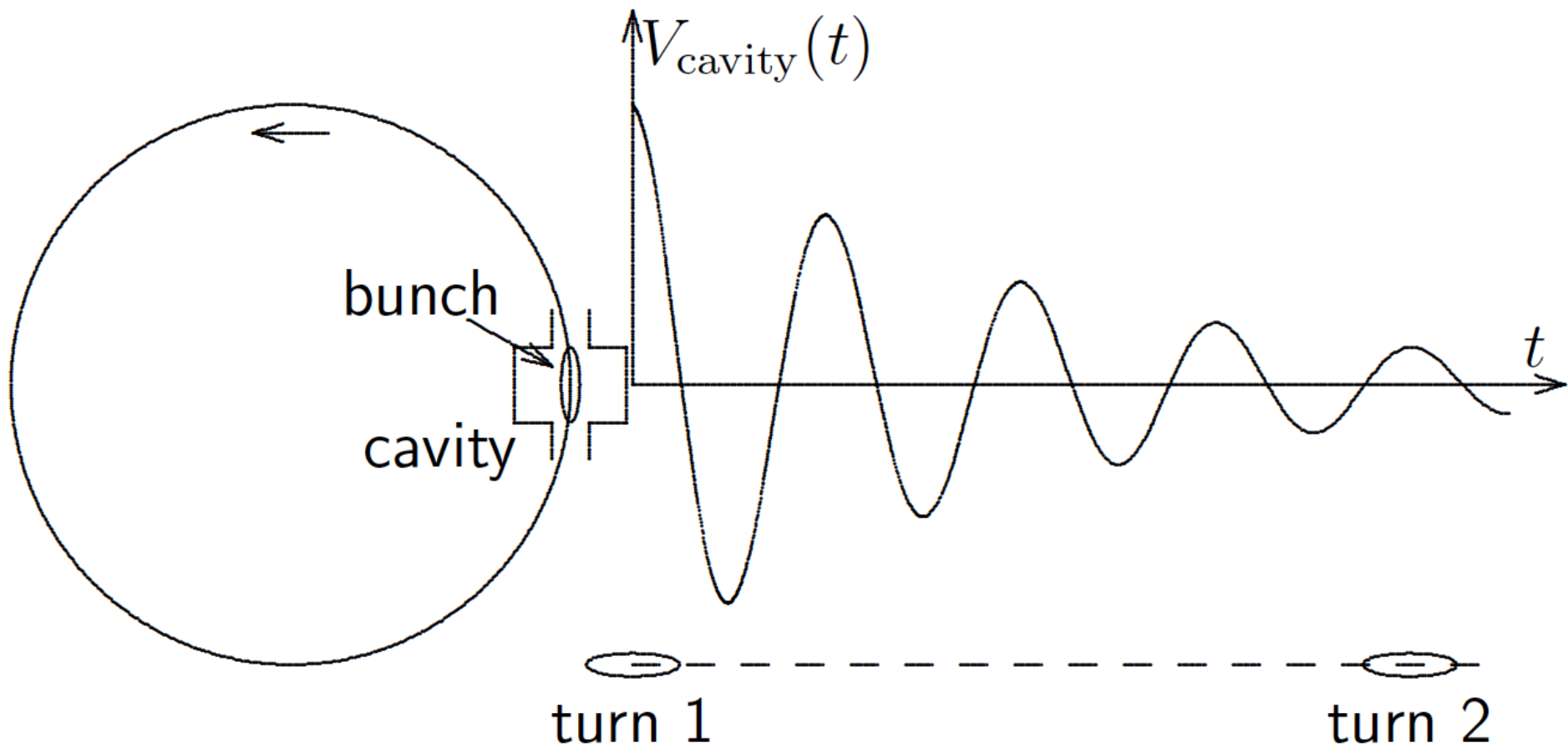

Summary

The wake function tells us what is the longitudinal field experienced by another particle passing through the cavity later

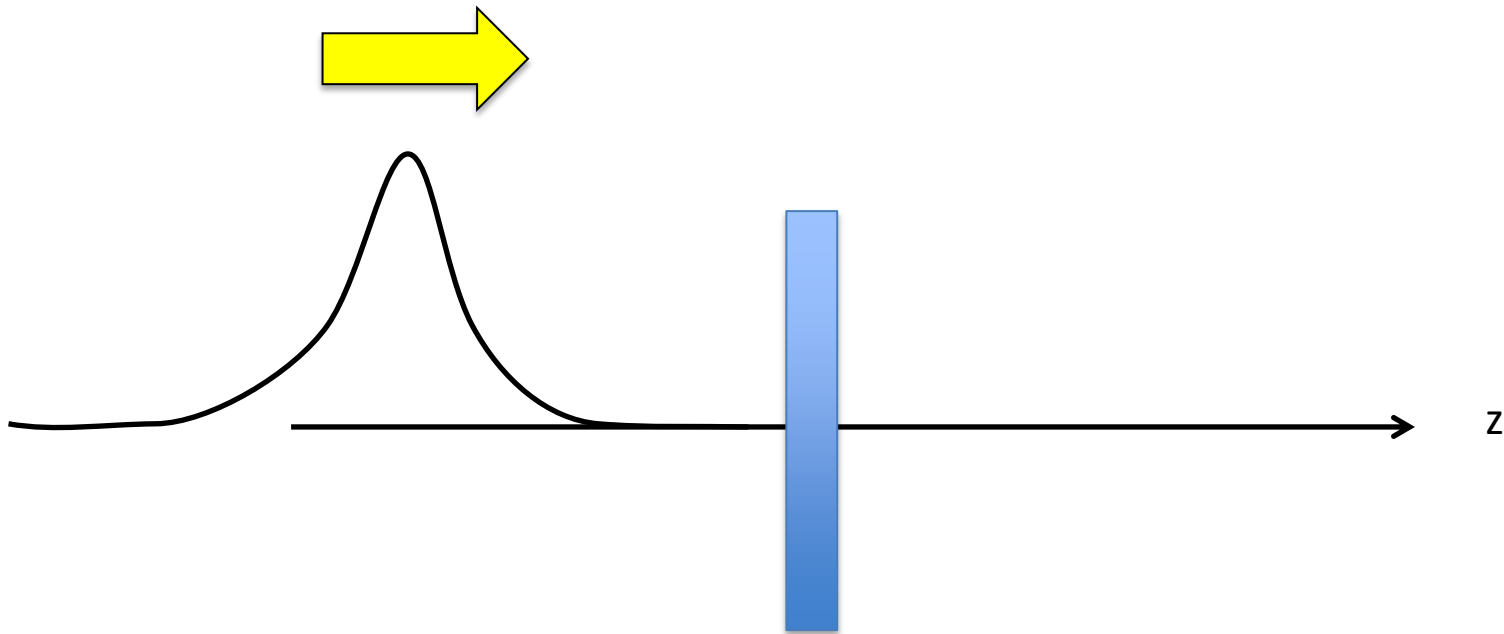

Summary

The wake function tells us what is the longitudinal field experienced by another particle passing through the cavity later

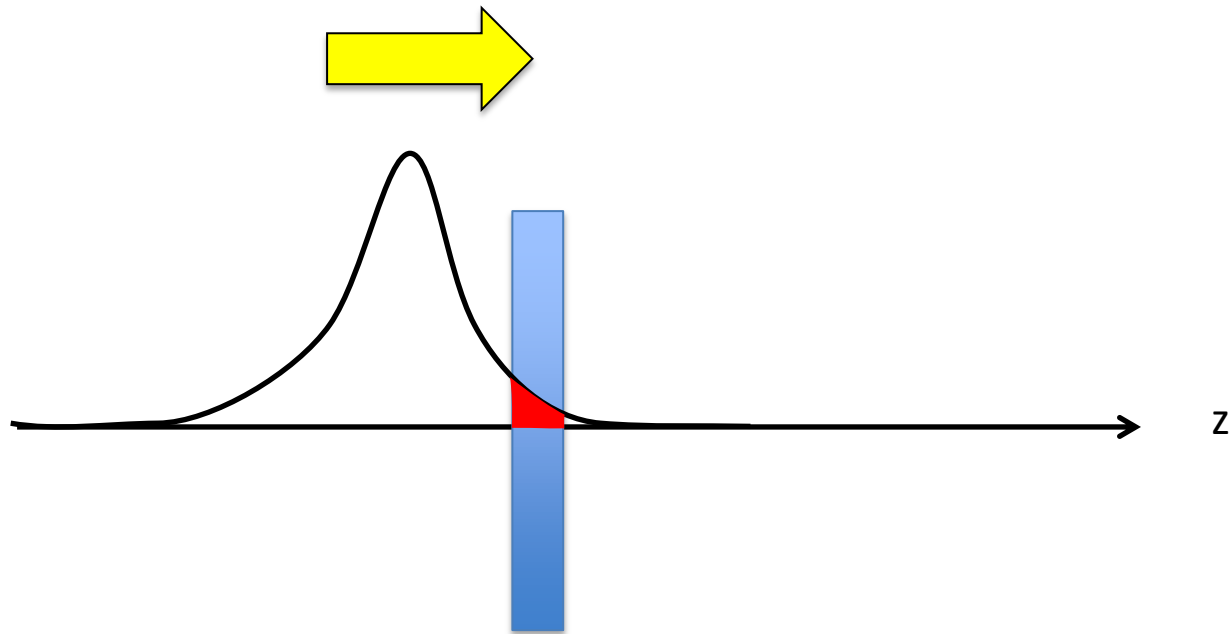

Summary

The wake function tells us what is the longitudinal field experienced by another particle passing through the cavity later

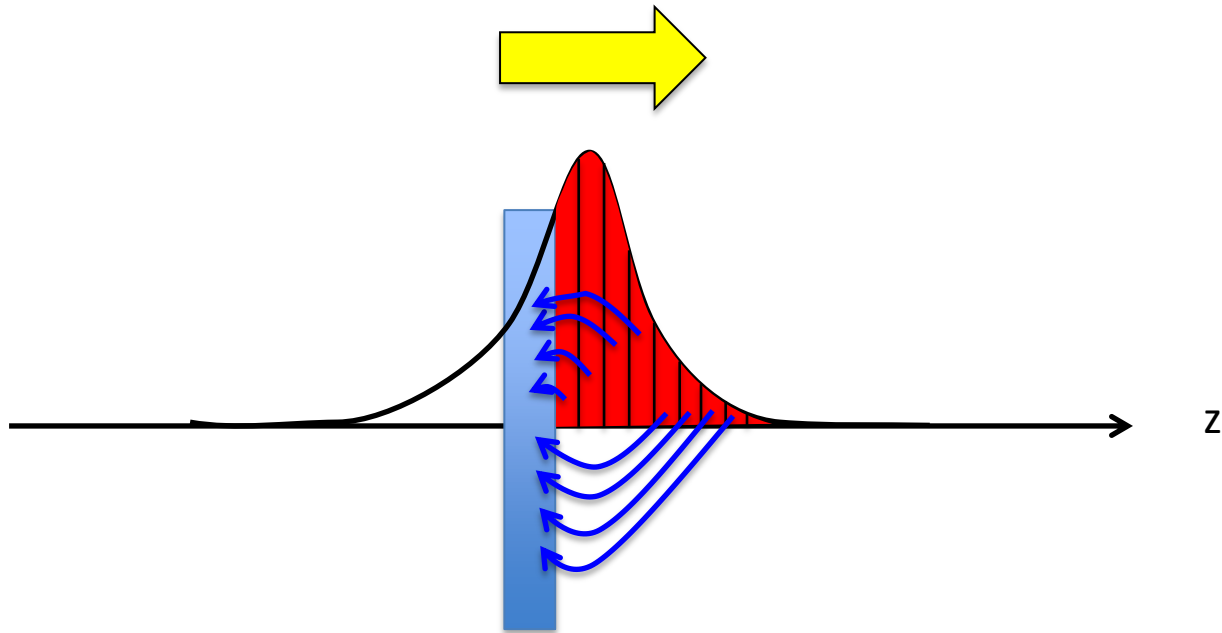

Summary

The wake function tells us what is the longitudinal field experienced by another particle passing through the cavity later

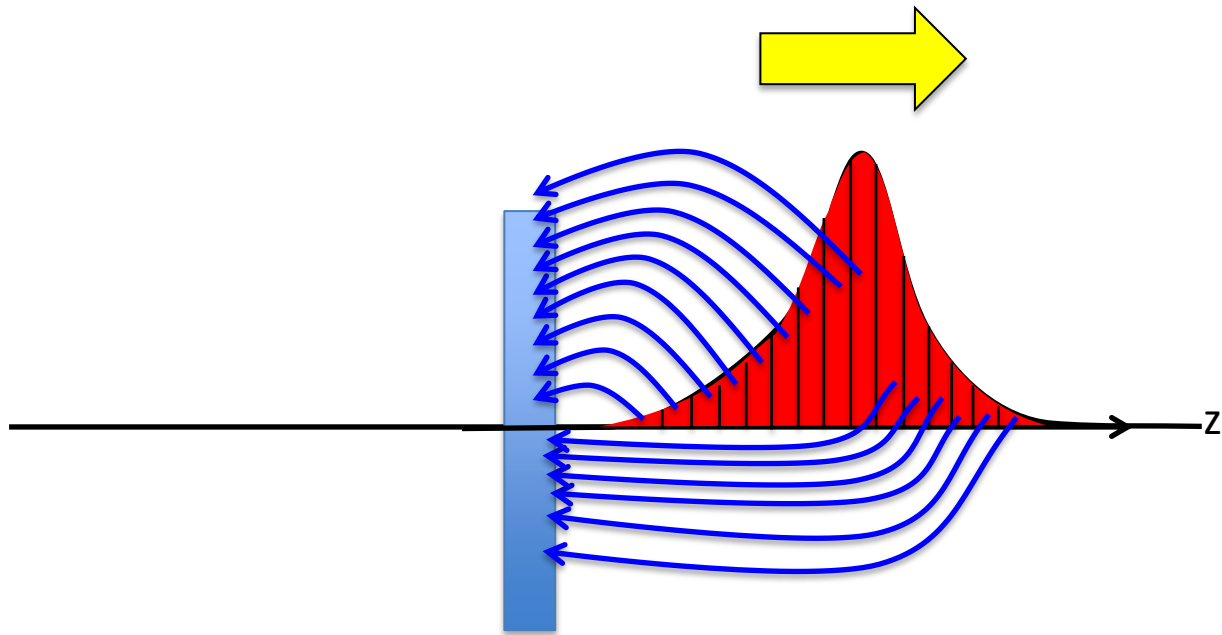

Impedance

Impedance

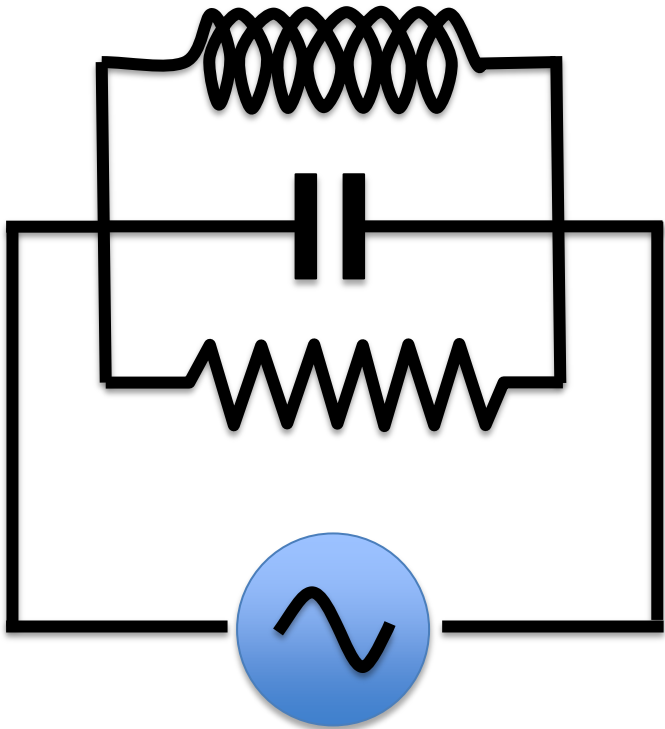

$$I = \hat{I} \cos(\omega t)$$

It is a quantity that relate V and I

$$\omega = 0 \quad \longrightarrow \quad V = RI$$

$$\omega > 0$$

$$V(t) = \hat{I}R \frac{\cos(\omega t) + Q \frac{\omega^2 - \omega_r^2}{\omega_r \omega} \sin(\omega t)}{1 + Q^2 \left(\frac{\omega^2 - \omega_r^2}{\omega_r \omega} \right)^2}$$

Impedance

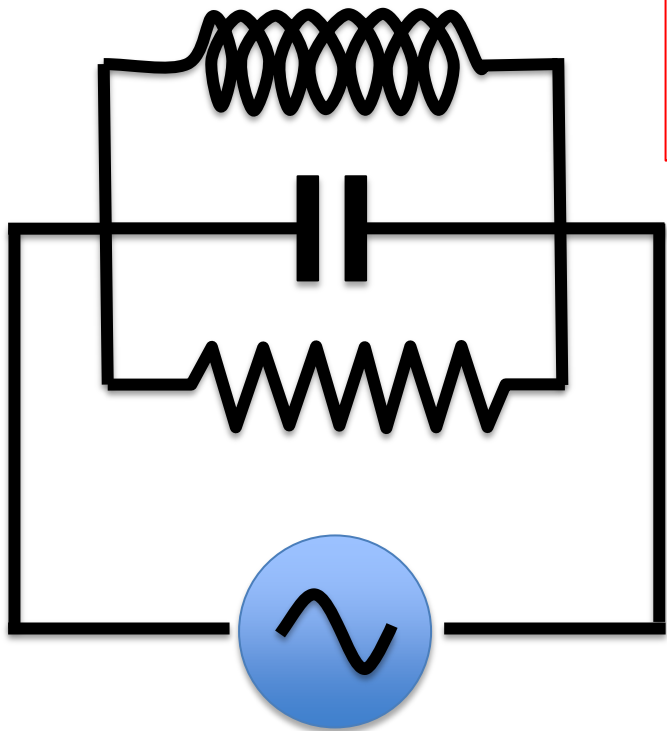

$$I = \hat{I} \cos(\omega t)$$

Impedance

$$V(t) = Z_r(\omega) \hat{I} \cos(\omega t) - Z_i(\omega) \hat{I} \sin(\omega t)$$

$$Z_r(\omega) = R \frac{1}{1 + Q^2 \left(\frac{\omega^2 - \omega_r^2}{\omega_r \omega} \right)^2}$$

$$Z_i(\omega) = -R \frac{Q \frac{\omega^2 - \omega_r^2}{\omega_r \omega}}{1 + Q^2 \left(\frac{\omega^2 - \omega_r^2}{\omega_r \omega} \right)^2}$$

Properties

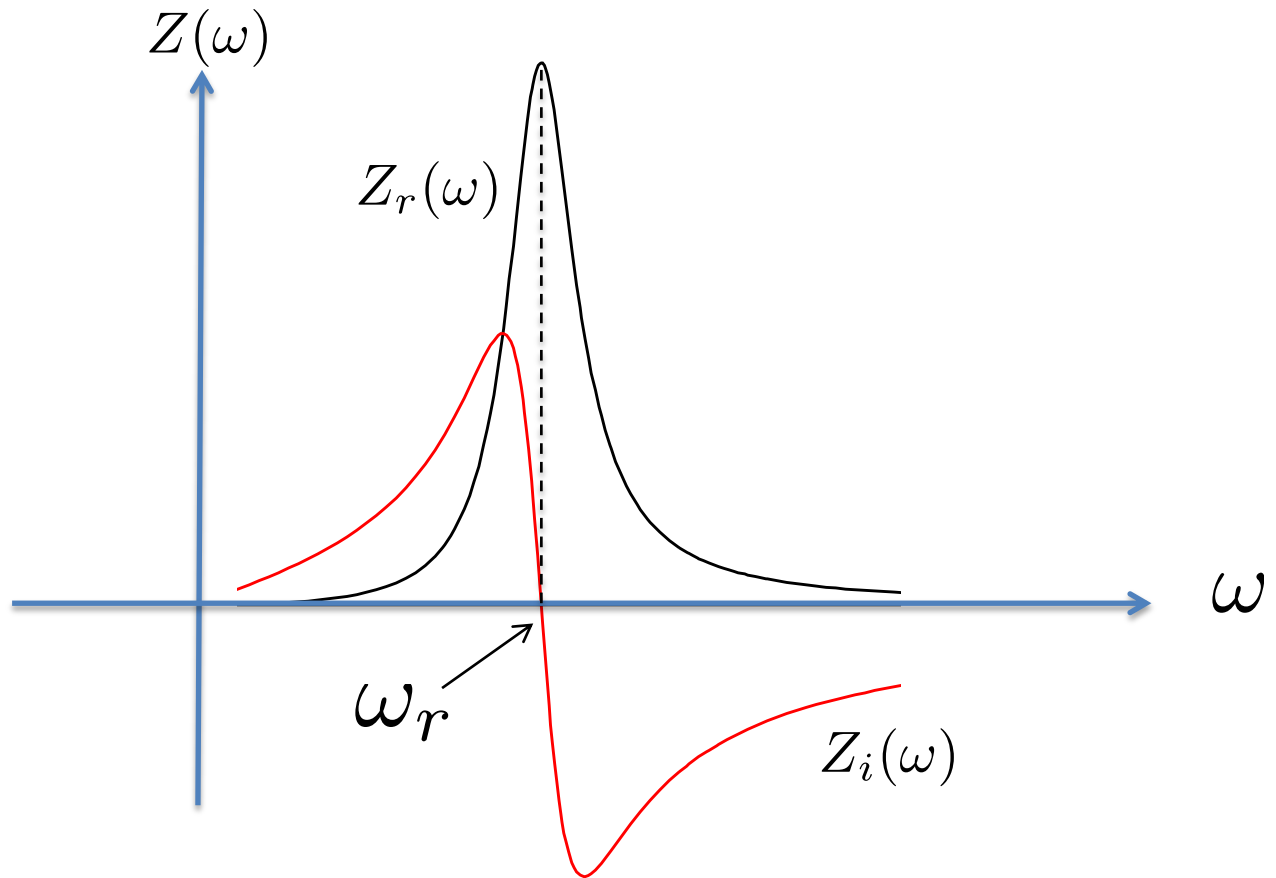

Properties

$$\text{At } \omega = \omega_r \quad \left\{ \begin{array}{l} Z_i(\omega_r) \quad \text{is zero} \\ Z_r(\omega_r) \quad \text{is maximum} \end{array} \right.$$

$$0 < \omega < \omega_r \quad \longrightarrow \quad Z_i(\omega) > 0 \quad \text{inductive}$$

$$\omega > \omega_r \quad \longrightarrow \quad Z_i(\omega) < 0 \quad \text{capacitive}$$

$$Z_r(\omega) = Z_r(-\omega) \quad Z_i(\omega) = -Z_i(-\omega)$$

Power dissipated

$$V(t)I(t) = \hat{I}^2 R \frac{\cos^2(\omega t) + Q \frac{\omega^2 - \omega_r^2}{\omega_r \omega} \sin(\omega t) \cos(\omega t)}{1 + Q^2 \left(\frac{\omega^2 - \omega_r^2}{\omega_r \omega} \right)^2}$$

$$V(t)I(t) = \hat{I}^2 Z_r(\omega) \cos^2(\omega t) + \hat{I}^2 Z_i(\omega) \sin(\omega t) \cos(\omega t)$$

The power dissipated depends on the resistive impedance

$$\langle V(t)I(t) \rangle_{cycle} = \frac{1}{2} \hat{I}^2 Z_r(\omega)$$

Complex notation

Complex notation $Z(\omega) = Z_r(\omega) + iZ_i(\omega)$

If Q is very large only for ω close to ω_r

$$\frac{\omega^2 - \omega_r^2}{\omega_r \omega} = \frac{(\omega - \omega_r)(\omega + \omega_r)}{\omega_r \omega} \simeq \frac{2\Delta\omega}{\omega_r}$$

$$Z(\omega) = R \frac{1 - iQ \frac{\omega^2 - \omega_r^2}{\omega_r \omega}}{1 + Q^2 \left(\frac{\omega^2 - \omega_r^2}{\omega_r \omega} \right)^2} = R \frac{1 - i2Q \frac{\Delta\omega}{\omega_r}}{1 + 4Q^2 \left(\frac{\Delta\omega}{\omega_r} \right)^2}$$

Green function

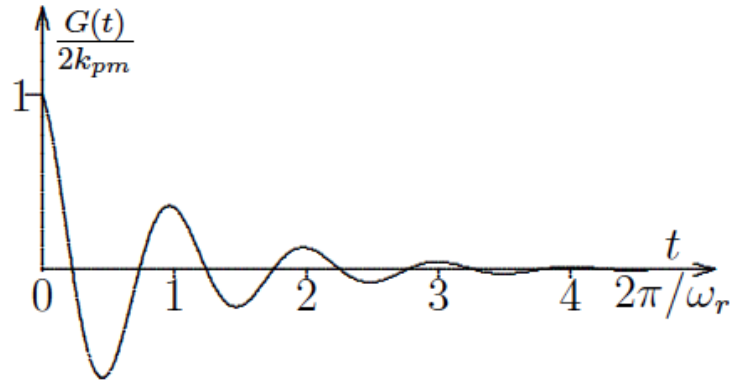

Green function

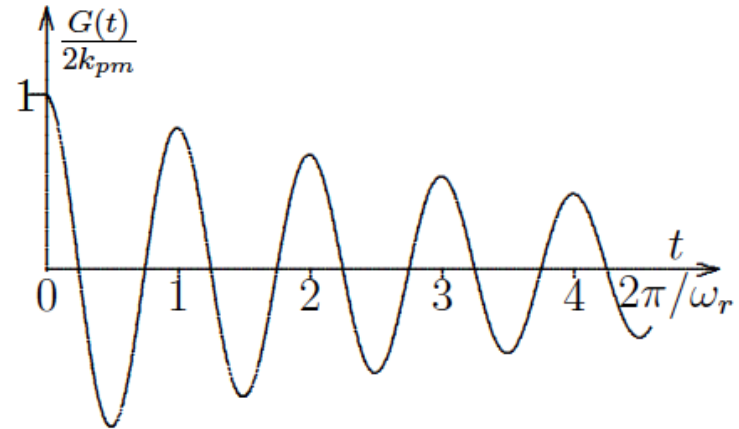

Impedance

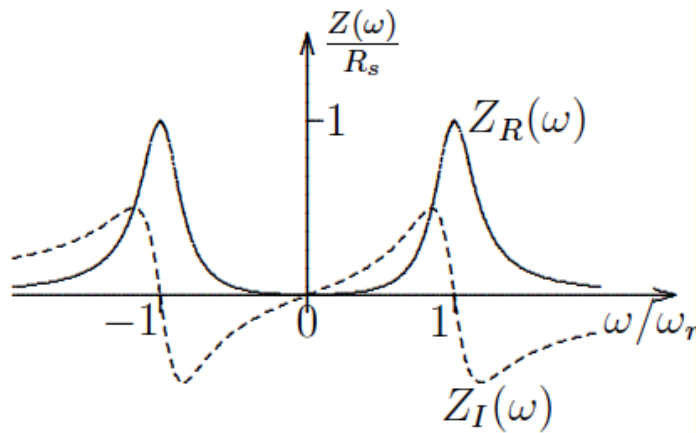

$Q = 3.0$

Impedance

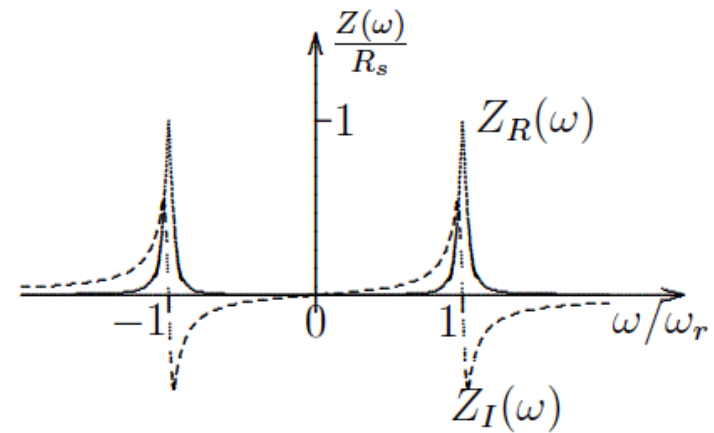

$Q = 15.0$

Wake potential \leftrightarrow Impedance

Charge through the cavity at t' $t > t' > 0$ $dq(t') = I(t')dt'$

The wake of that charge at time t is $G(t - t')$

The potential in the cavity at time t due to the charge passing at t' is

$$dq(t')G(t - t')$$

The total potential due to all charges passing through the cavity is

$$V(t) = \int_0^t dq(t')G(t - t')$$

If now the current I is $I(t') = \hat{I}e^{i\omega t'}$

then
$$V(t) = \int_0^t \hat{I}e^{i\omega t'} G(t - t') dt'$$

with some change of variable

$$V(t) = I(t) \int_0^t e^{-i\omega\tau} G(\tau) d\tau$$

We wait long enough that transient effect disappears, hence

$$Z(\omega) = \frac{V(t)}{I(t)} = \int_0^\infty e^{-i\omega\tau} G(\tau) d\tau$$

Complicated geometries of the vacuum chamber give an effect on the beam which is described by the impedance $Z(\omega)$

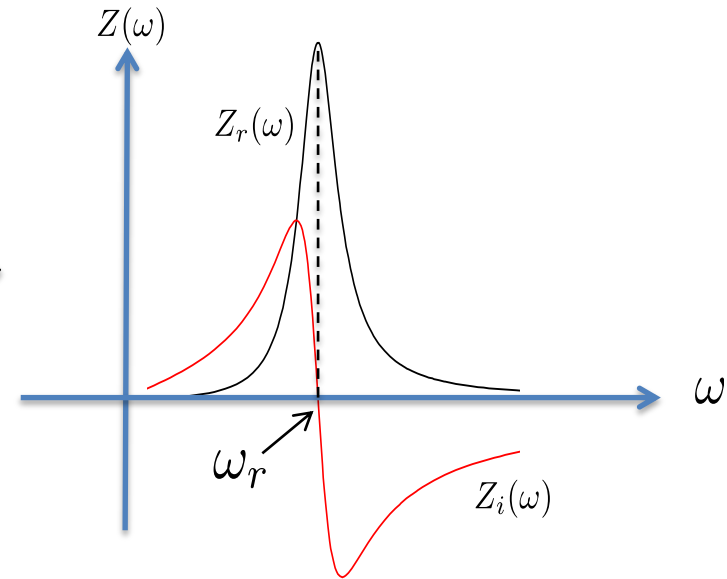
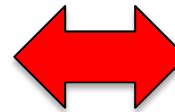
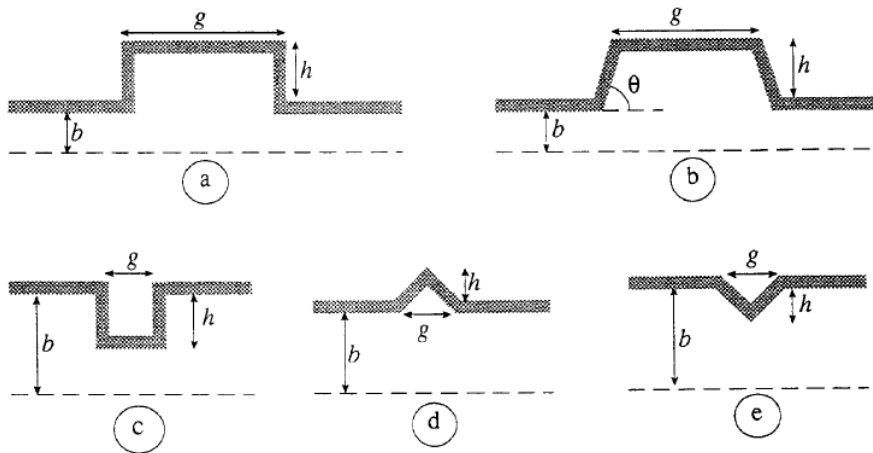

$$Z(\omega)$$

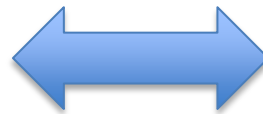

$$G(t)$$

Consequences of impedances

Energy loss on pipes → heating (important if you have a superconducting machine!)

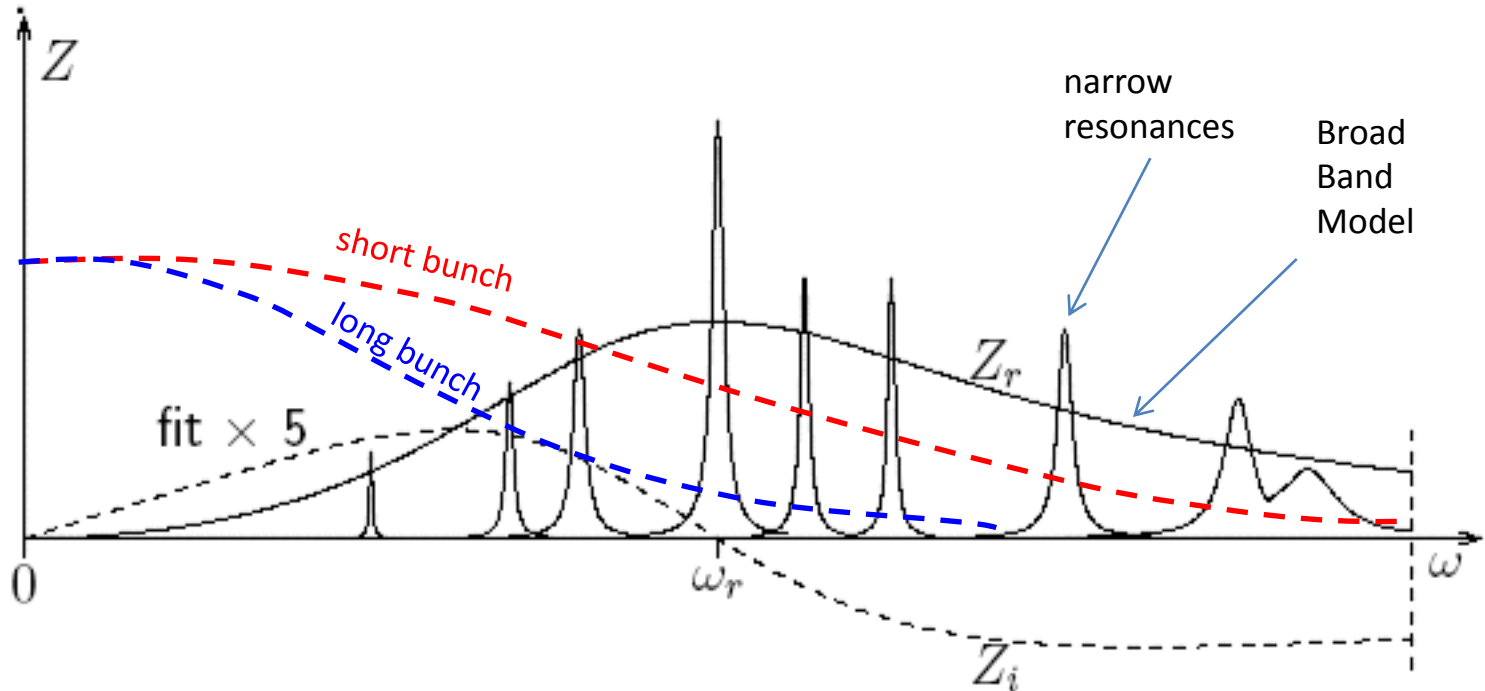

Consequences of impedances

Feed-back to the beam as a hole: collective effects

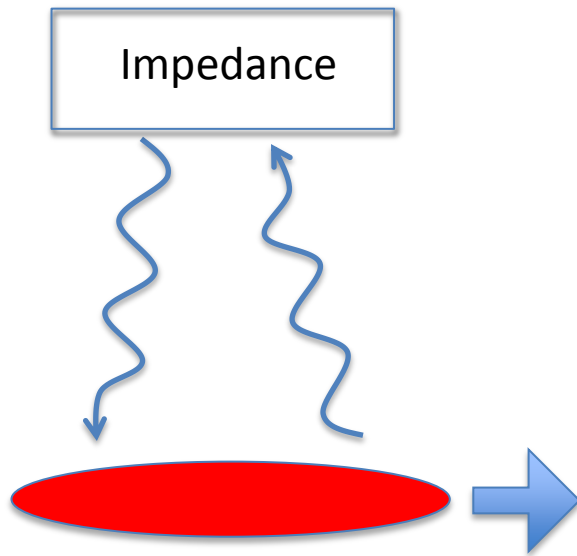

Dynamics of the
all beam is affected

We have seen the longitudinal
impedance in a cavity



More types of impedances ...

Longitudinal dynamics

Longitudinal dynamics

synchronous orbit

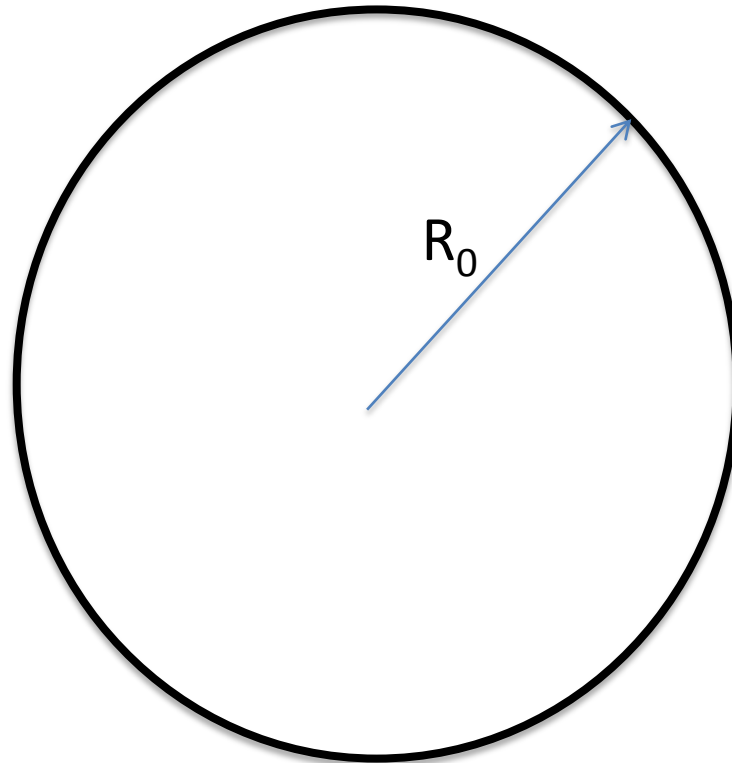

T_0
 ω_0
 p_0
 E_0

Longitudinal dynamics

synchronous orbit

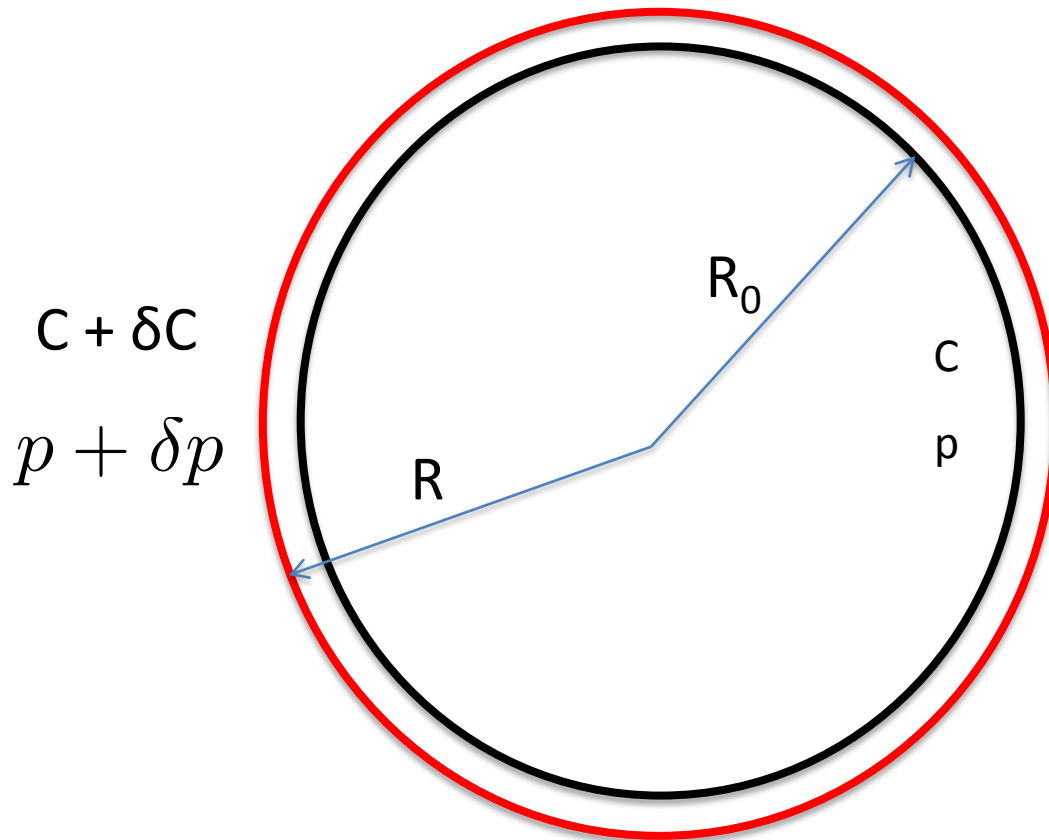

$$\frac{\delta C}{C} = \alpha_c \frac{\delta p}{p}$$

This property comes from the magnets

Longitudinal dynamics

revolution time

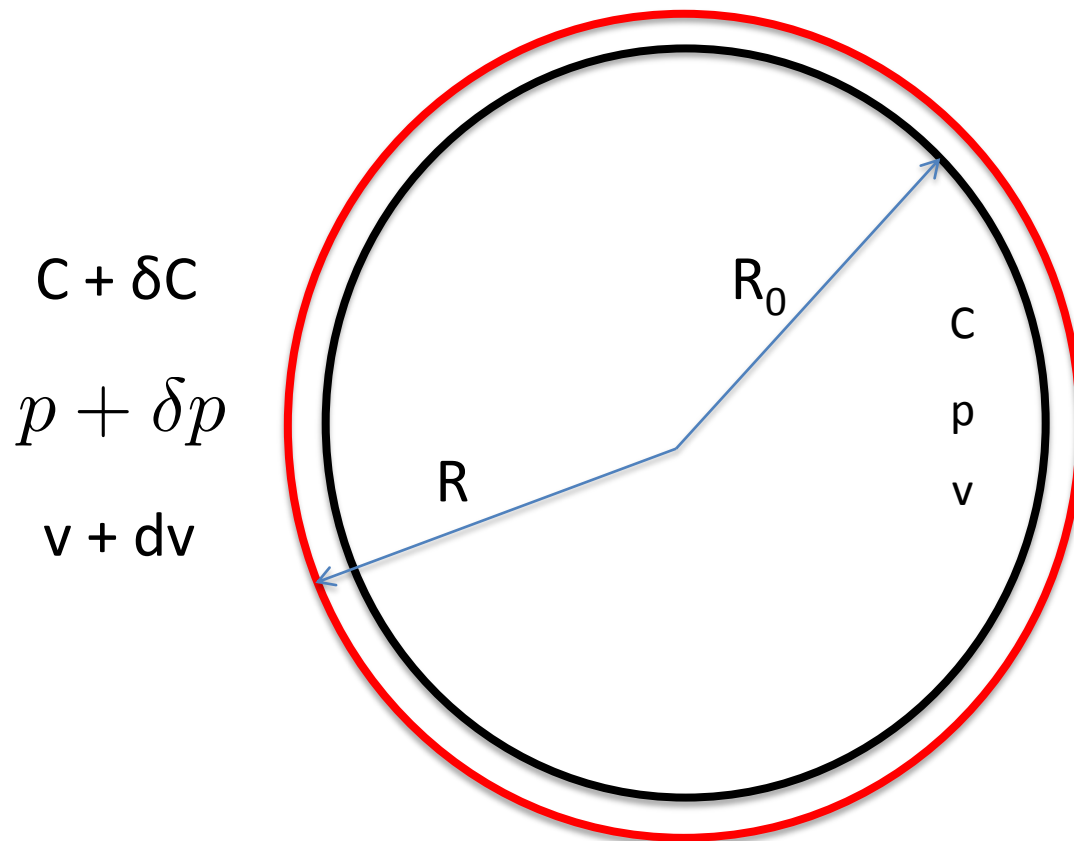

Nobody can go faster than light

revolution time

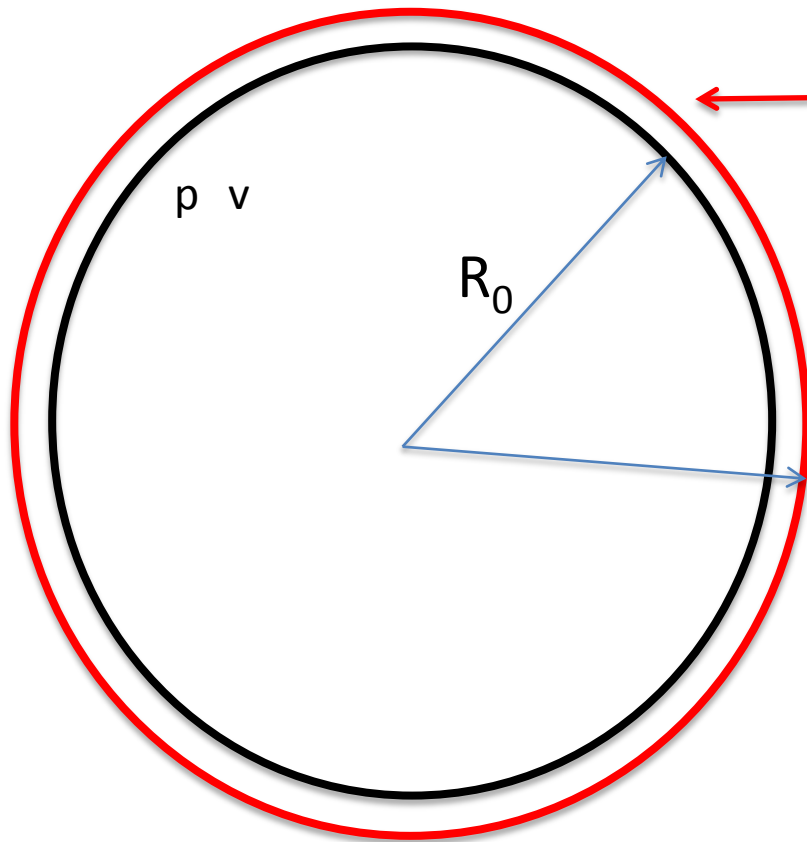

$$p + \delta p$$

If this is large

$$v + dv$$

this velocity will always be less than "c"





Therefore at a certain point the circumference growth but the particle speed remain "c"

It takes longer to make one turn !

$$\frac{\delta T}{T_0} = \frac{1}{T_0} \delta \left(\frac{L}{v} \right) = \left(\alpha_c - \frac{1}{\gamma^2} \right) \frac{\delta p}{p} = \eta \frac{\delta p}{p}$$

If $\alpha_c = \frac{1}{\gamma^2}$ we are at the transition energy E_T

If	$E < E_T$	increasing energy		revolution time shorter
If	$E > E_T$	increasing energy		revolution time longer !!

RF

synchronous orbit

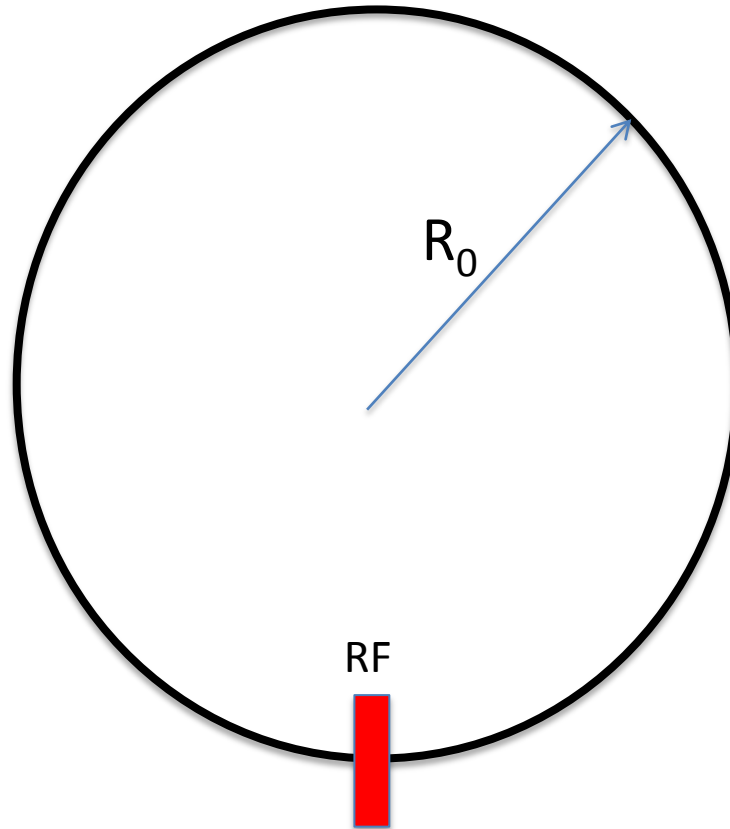

T_0

ω_0

p_0

E_0

The synchronous particle has energy E and goes through the cavity at time t_s

Voltage in the cavity $V = \hat{V} \sin(h\omega_0 t_s)$

$\phi_s = h\omega_0 t_s$ this is the phase of the synchronous particle

This is a phase we know each time the particle goes through the cavity

Non synchronous particle

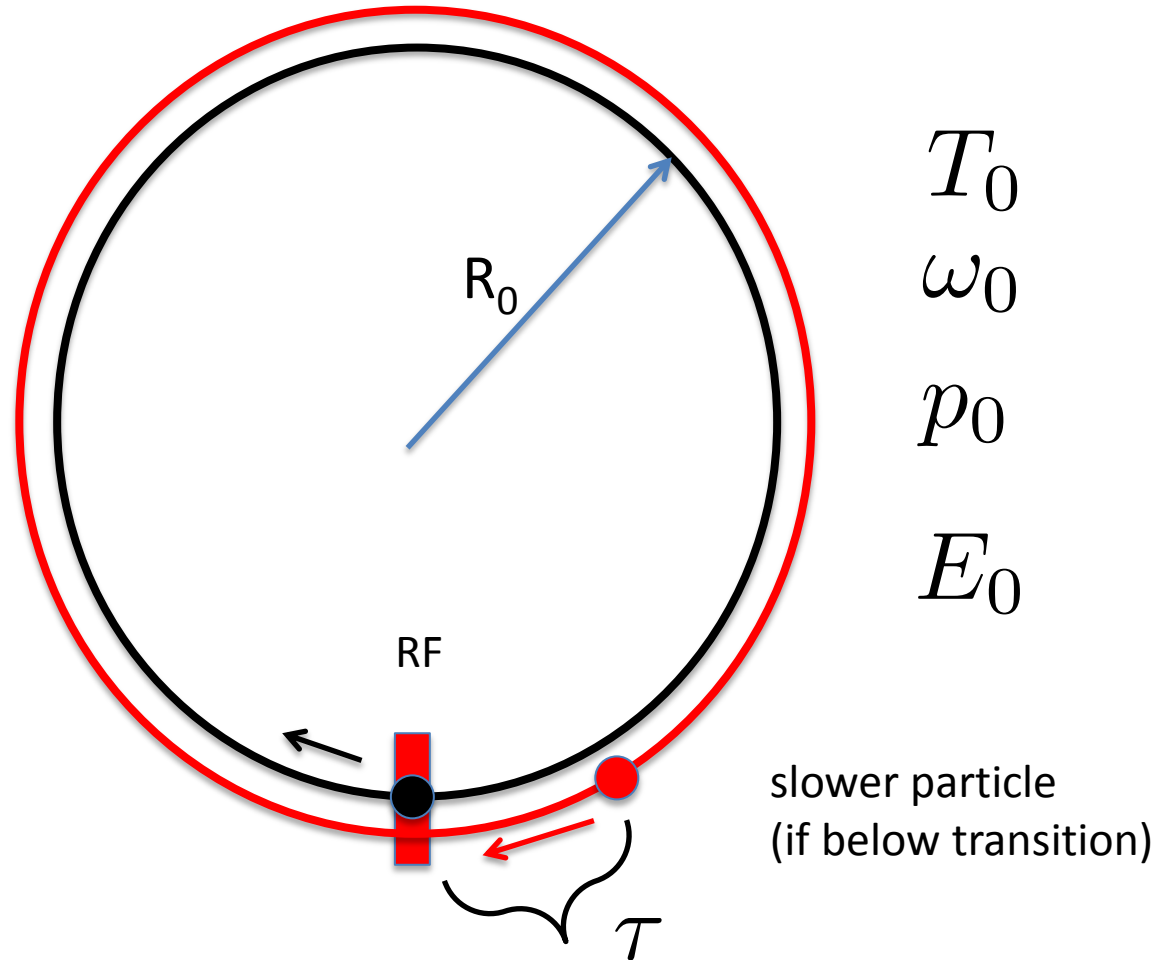

Voltage on the particle

$$V = \hat{V} \sin(\phi_s + h\omega_0\tau)$$

Gain of energy $\delta E = e\hat{V} \sin(\phi_s + h\omega_0\tau)$

Now we include an energy loss per turn and per particle U

$$\delta E = e\hat{V} \sin(\phi_s + h\omega_0\tau) - U$$

Define relative energy $\epsilon = \Delta E / E_0$

$$\delta\epsilon = \frac{e\hat{V}}{E_0} \sin(\phi_s + h\omega_0\tau) - \frac{U}{E_0}$$

$$\frac{\delta\epsilon}{T_0} = \frac{e\hat{V}}{T_0 E_0} \sin(\phi_s + h\omega_0\tau) - \frac{U}{T_0 E_0}$$

If $\frac{\delta\epsilon}{T_0}$ is small, than this term is equal to the time derivative of ϵ

$$\dot{\epsilon} = \frac{e\hat{V}\omega_0}{2\pi E_0} \sin(\phi_s + h\omega_0\tau) - \frac{\omega_0 U}{2\pi E_0}$$

but U, depends on ϵ , and τ  $U(\epsilon, \tau)$

If ϵ , and τ are small we can expand

$$\dot{\epsilon} = \frac{e\hat{V}\omega_0}{2\pi E_0} \sin(\phi_s) + \frac{e\hat{V}\omega_0}{2\pi E_0} \cos(\phi_s) h\omega_0\tau - \frac{\omega_0 U_0}{2\pi E_0} - \frac{\omega_0}{2\pi E_0} \frac{\partial U}{\partial E} \epsilon - \frac{\omega_0}{2\pi E_0} \frac{\partial U}{\partial t} \tau$$

These two terms are equal for the synchronous particle

We remain with the equation

$$\dot{\epsilon} = \frac{e\hat{V}h\omega_0^2}{2\pi E_0} \cos(\phi_s)\tau - \frac{\omega_0}{2\pi E_0} \frac{\partial U}{\partial E} \epsilon - \frac{\omega_0}{2\pi E_0} \frac{\partial U}{\partial t} \tau$$

In addition at high energy

$$\frac{\delta T}{T} \simeq \eta \frac{\delta E}{E} \quad \longrightarrow \quad \dot{\tau} = \eta \epsilon$$

$$\ddot{\tau} = \eta \frac{e\hat{V}h\omega_0^2}{2\pi E_0} \cos(\phi_s)\tau - \eta \frac{\omega_0}{2\pi E_0} \frac{\partial U}{\partial E} \epsilon - \eta \frac{\omega_0}{2\pi E_0} \frac{\partial U}{\partial t} \tau$$

$$\omega_{s0}^2 = -\eta \frac{e\hat{V}h\omega_0^2}{2\pi E_0} \cos(\phi_s) \quad \alpha_s = \frac{1}{2} \frac{\omega_0}{2\pi E} \frac{\partial U}{\partial E}$$

Final equation of motion (in tau)

$$\ddot{\tau} + 2\alpha_s \dot{\tau} + \left[\omega_{s0}^2 + \eta \frac{\omega_0}{2\pi E_0} \frac{\partial U}{\partial t} \right] \tau = 0$$

Solution

$$\tau \propto e^{\lambda t} \quad \longrightarrow \quad \lambda^2 + 2\alpha_s \lambda + \left[\omega_{s0}^2 + \eta \frac{\omega_0}{2\pi E_0} \frac{\partial U}{\partial t} \right] = 0$$

Solving for lambda: $\lambda = -\alpha_s \pm \sqrt{\alpha_s^2 - (\omega_{s0}^2 + \dots)}$

that is $\lambda = -\alpha_s \pm i\omega_{s1}$ with $\omega_{s1}^2 = \omega_{s0}^2 + \eta \frac{\omega_0}{2\pi E_0} \frac{\partial U}{\partial t} - \alpha_s^2$

$$\tau = \hat{\tau} e^{-\alpha_s t} \cos(\omega_{s1} t) \quad \longrightarrow \quad \text{if } \alpha_s > 0 \text{ Solution stable}$$

Interpretation

No Energy Loss

$$E < E_T$$

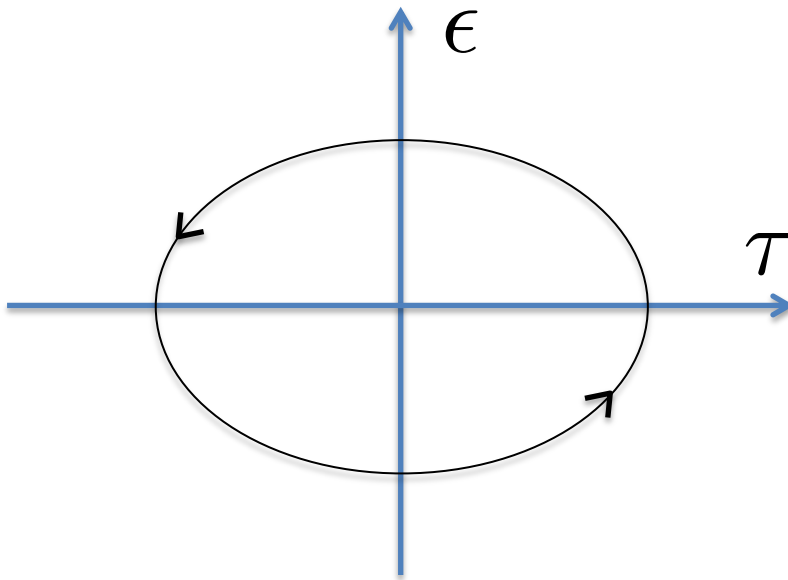

$$E > E_T$$

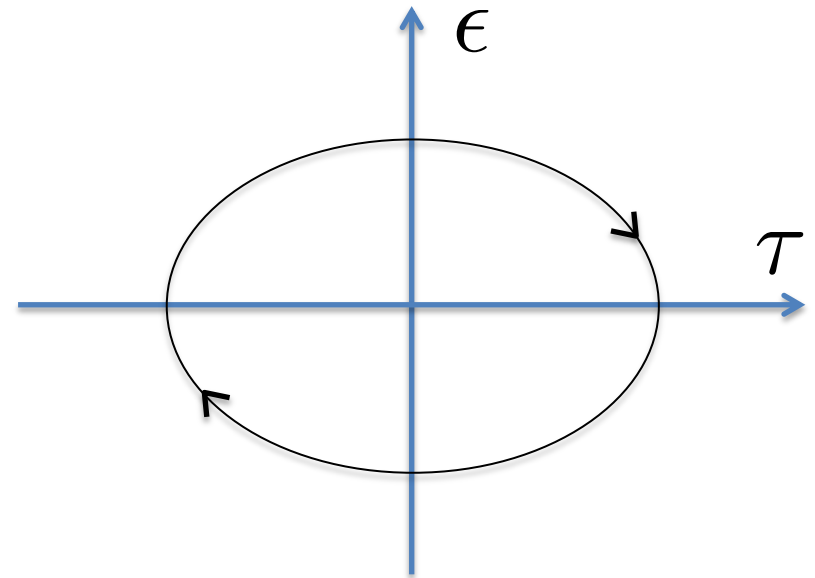

Interpretation

With Energy Loss

$$E < E_T$$

$$E > E_T$$

$$\frac{\partial U}{\partial E} \epsilon > 0$$

$$\frac{\partial U}{\partial E} \epsilon < 0$$

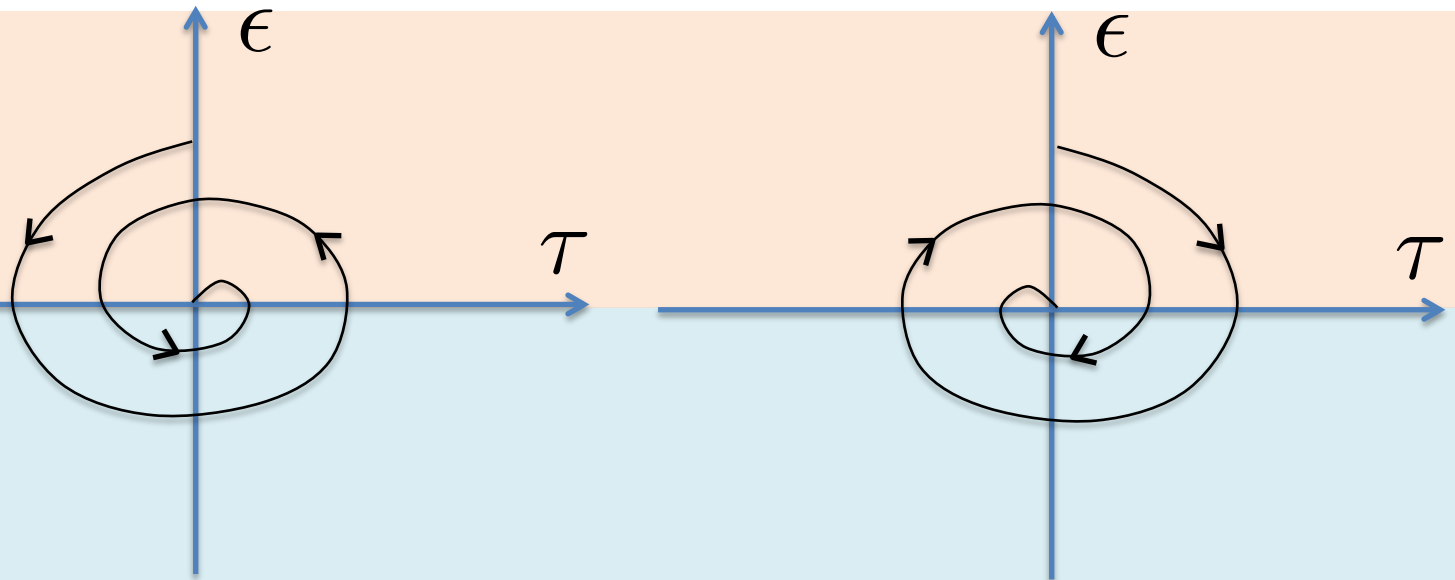

Bunch Lengthening

Bunch lengthening

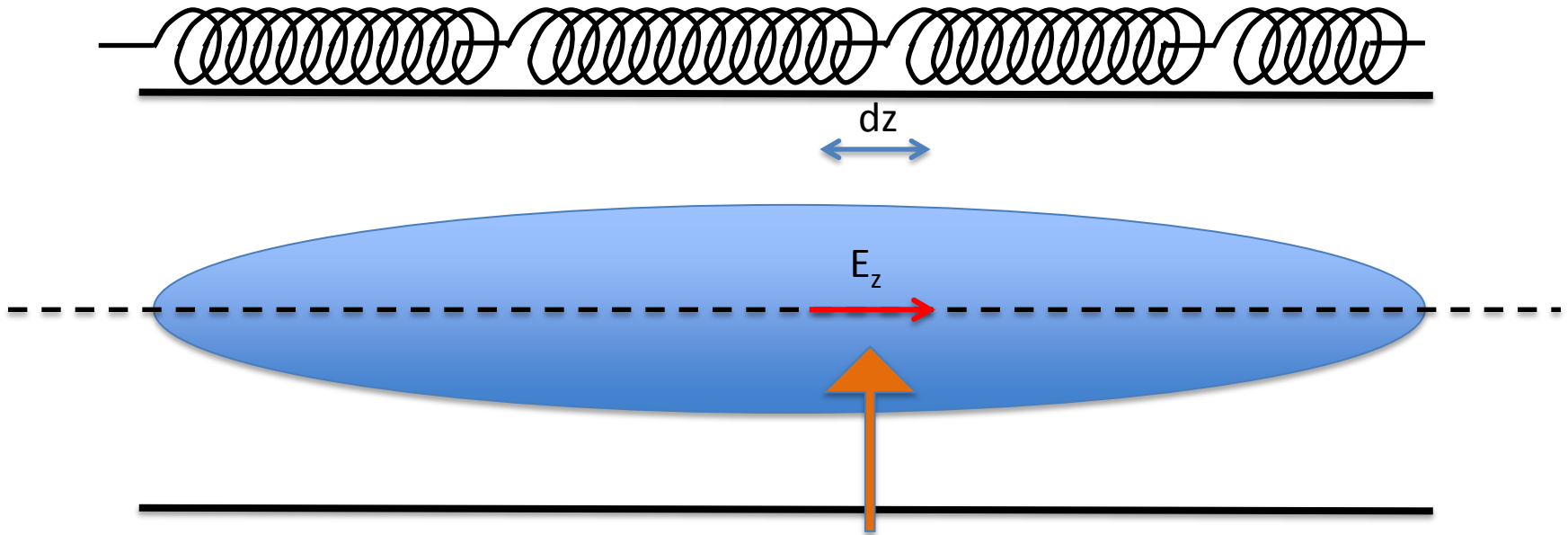

In one turn
change of energy
per charge

$$V = -L \frac{dI_b}{dz}$$

L is the integrated inductance

Parabolic bunch

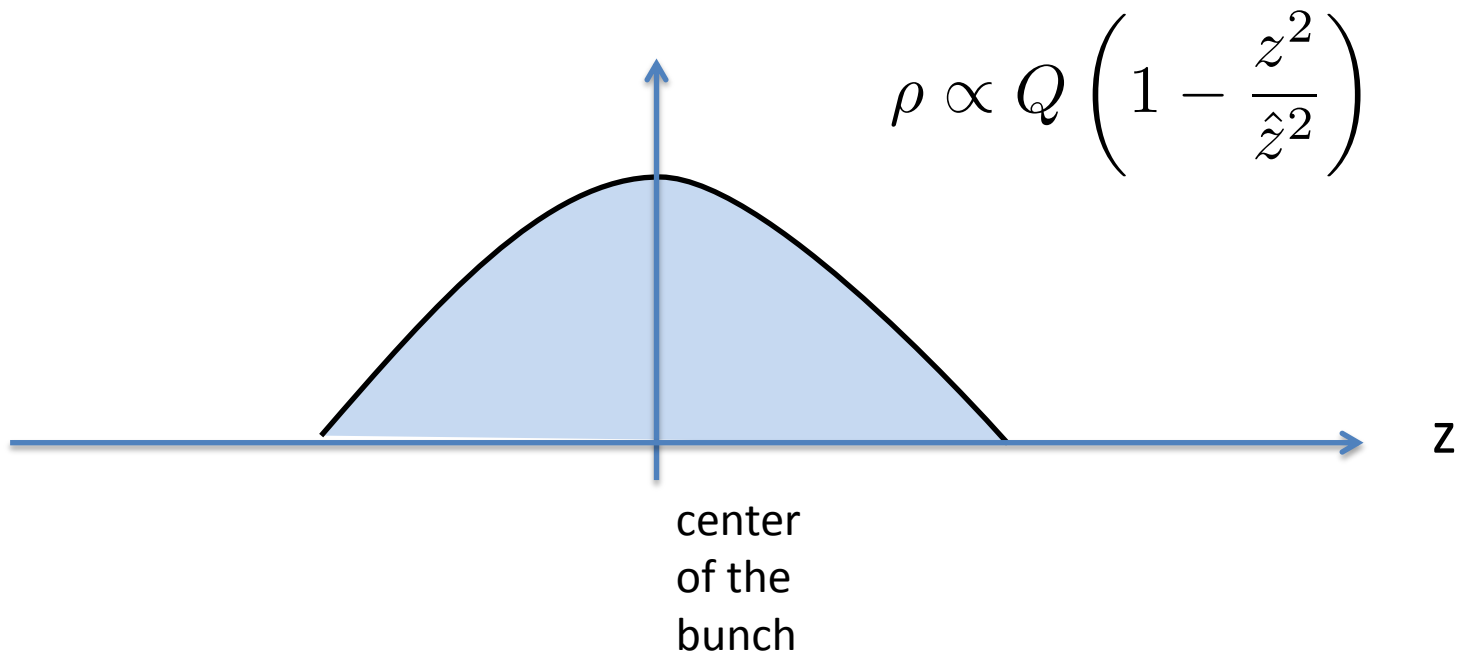

Parabolic bunch

$$I = \frac{3\pi I_0}{2\omega \hat{\tau}} \left(1 - \frac{\tau^2}{\hat{\tau}^2} \right)$$

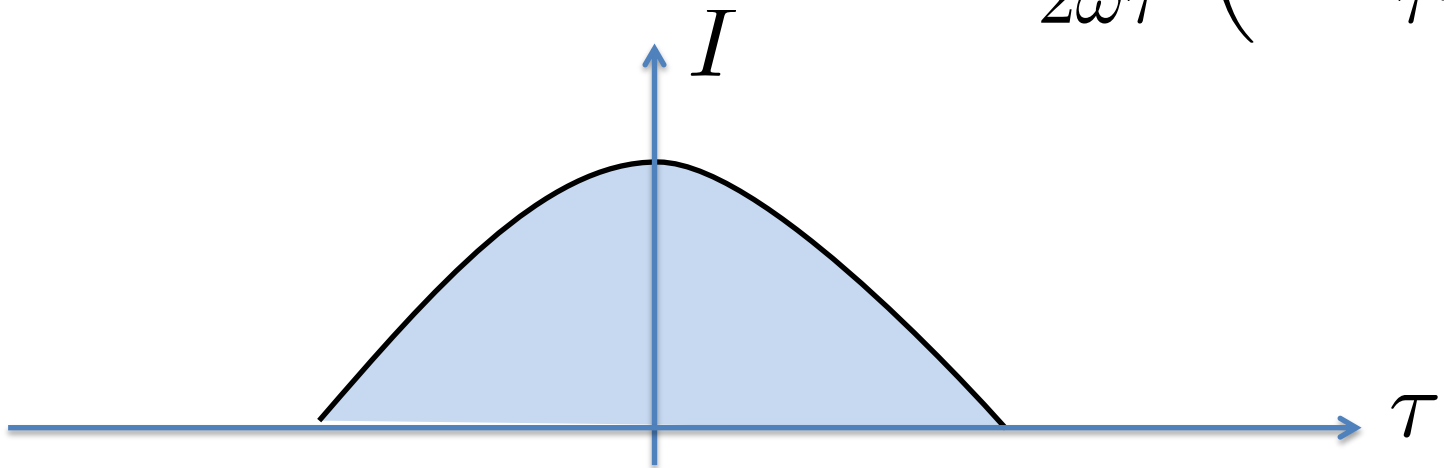

center
of the
bunch

Voltage induced

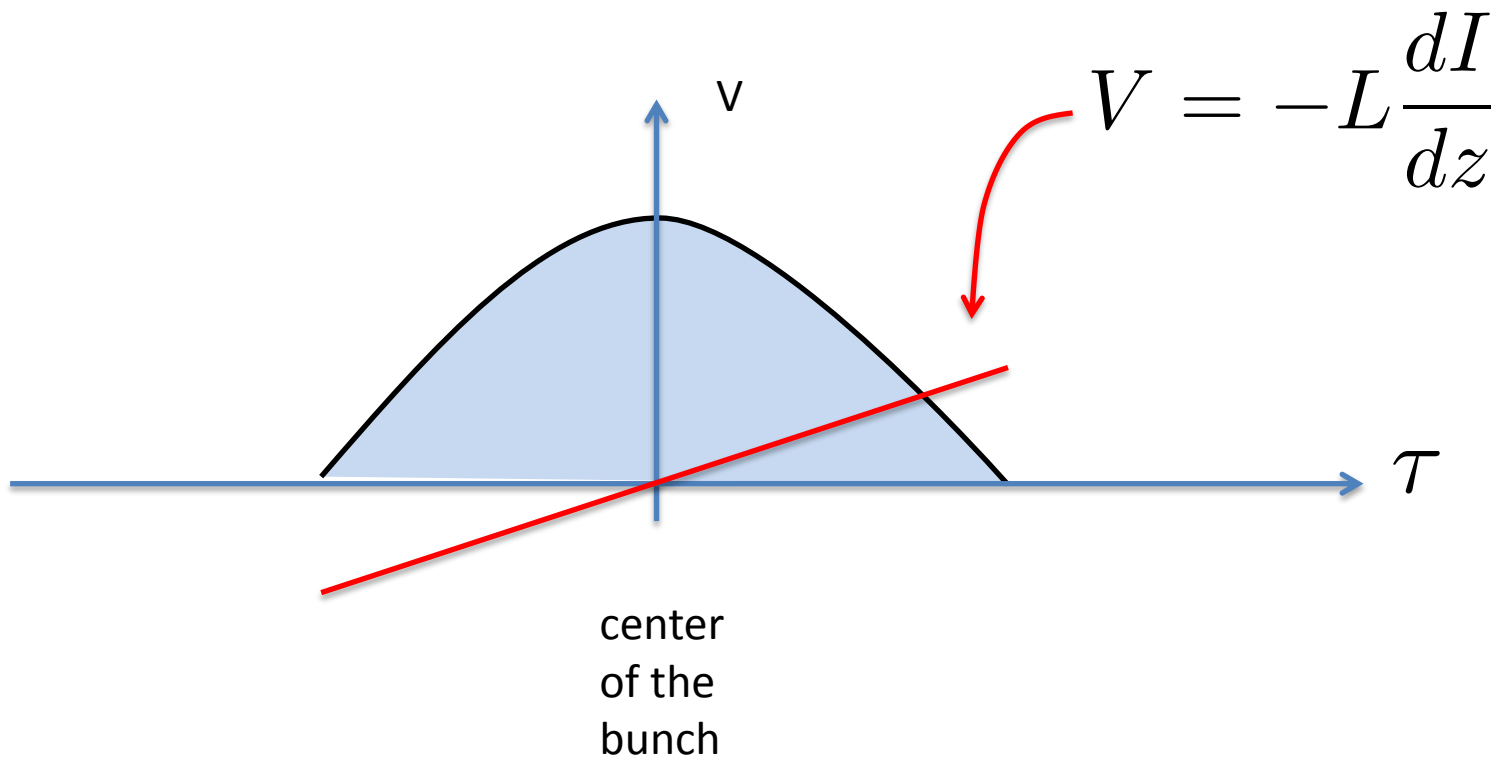

If we compare with RF

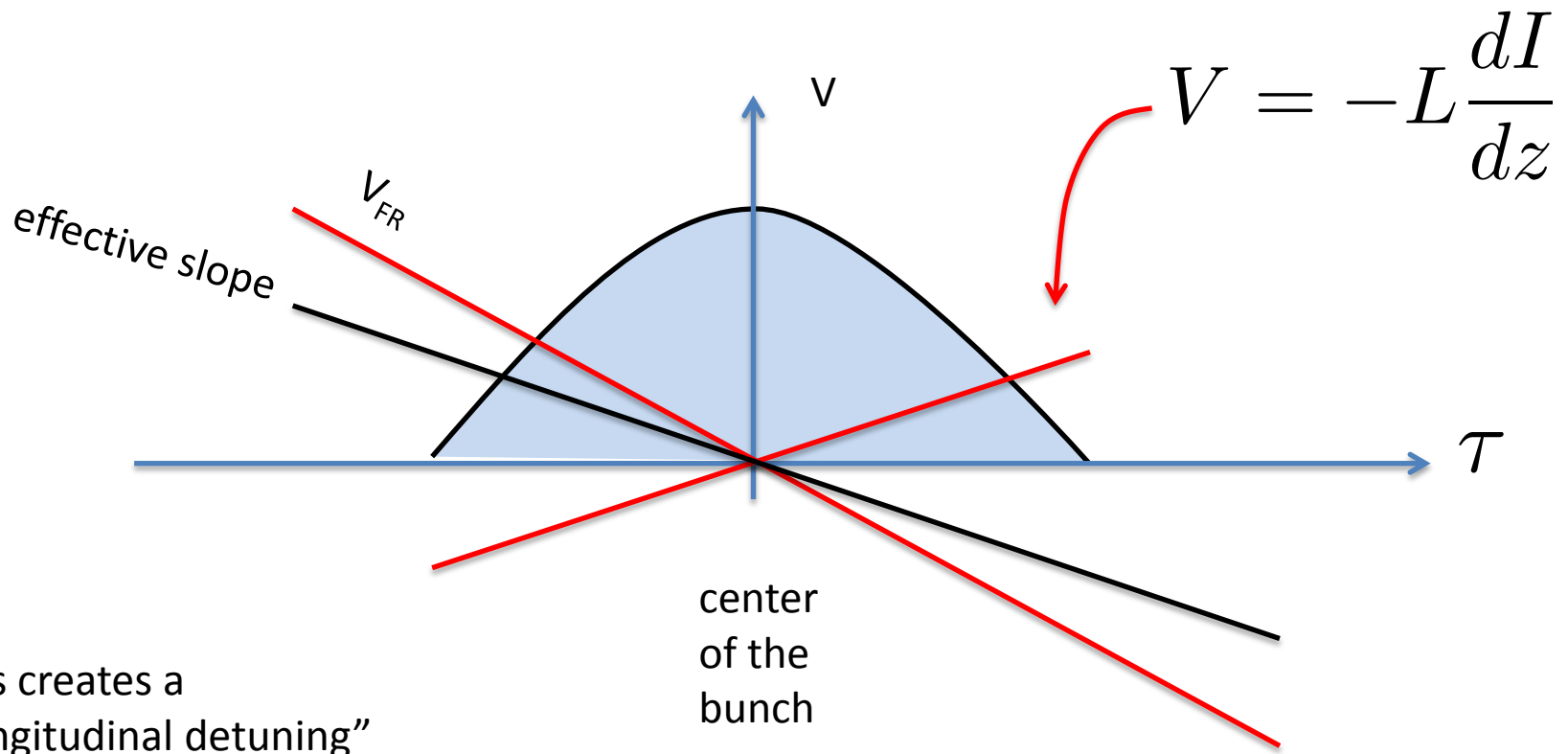

This creates a
"longitudinal detuning"

By using a bunch with the same longitudinal emittance a reduction of longitudinal focusing strength produces a bunch lengthening



The bunch becomes matched with the effective voltage slope

Effective voltage

$$V = \hat{V} \sin(\phi_s + h\omega_0\tau) + \frac{3\pi I_0 L}{\omega_0 \hat{\tau}^3} \tau$$



induced voltage

Linearizing in tau

$$V = \hat{V} \sin(\phi_s) + \hat{V} \cos(\phi_s) h\omega_0\tau + \frac{3\pi I_0 L}{\omega_0 \hat{\tau}^3} \tau$$



focusing from RF



defocusing from impedance

$$\dot{\epsilon} = \frac{e\hat{V}\omega_0}{2\pi E_0} \cos(\phi_s) h\omega_0\tau + e \frac{\omega_0}{2\pi E_0} \frac{3\pi I_0 L}{\omega_0 \hat{\tau}^3} \tau$$

But $\dot{\tau} = \eta\epsilon$ therefore

$$\ddot{\tau} = \frac{\eta e\hat{V}\omega_0}{2\pi E_0} \cos(\phi_s) h\omega_0\tau + e \frac{\eta\omega_0}{2\pi E_0} \frac{3\pi I_0 L}{\omega_0 \hat{\tau}^3} \tau$$

but $\left| \frac{Z}{n} \right|_0 = L\omega_0$

Therefore

$$\ddot{\tau} = \frac{\eta e h \hat{V} \omega_0^2}{2\pi E_0} \cos(\phi_s) \left[1 + \frac{1}{\hat{V} \cos(\phi_s)} \frac{3\pi I_0}{h\omega_0^3 \hat{\tau}^3} \left| \frac{Z}{n} \right|_0 \right] \tau$$

$$\omega_{s0}^2 = -\frac{\eta e h \hat{V} \omega_0^2}{2\pi E_0} \cos(\phi_s)$$

is the longitudinal strength
in absence of impedance

$$\omega_s^2 = \omega_{s0}^2 \left[1 + \frac{1}{\hat{V} \cos(\phi_s)} \frac{3\pi I_0}{h\omega_0^3 \hat{\tau}^3} \left| \frac{Z}{n} \right|_0 \right]$$

Therefore the relative change in omega is

$$\frac{\Delta\omega_s}{\omega_{s0}} = \frac{1}{2} \frac{1}{\hat{V} \cos(\phi_s)} \frac{3\pi I_0}{h\omega_0^3 \hat{\tau}^3} \left| \frac{Z}{n} \right|_0$$

For protons $\hat{\tau}\hat{\epsilon} = \text{constant}$

$$\frac{\Delta\hat{\tau}}{\tau} \simeq -\frac{\Delta\omega_s}{2\omega_s}$$

Observation

The effect of the impedance is local, hence the voltage induced by impedance do not effect the center of mass (like for the space charge)

Summary

- 1) Wall charges creates detuning \rightarrow incoherent tunes
- 2) Ferromagnetic material creates image currents:
Coherent motion \rightarrow coherent tunes
- 3) Concept of Wake field
- 4) Impedance of a cavity, Wake \leftrightarrow impedance
- 5) Energy loss
- 6) Longitudinal dynamics, effect of energy loss
- 7) Bunch lengthening