

Vacuum Systems

V. Baglin

CERN TE-VSC, Geneva



Outline

1. Vacuum Basis
2. Vacuum Components
3. Vacuum with Beams : LHC Example

1. Vacuum Basis



Units

- The pressure is the **force** exerted by a molecule per unit of surface : $1 \text{ Pa} = 1 \text{ N/m}^2$

|  Pa | Pa | kg/cm ² | Torr | mbar | bar | atm |
|--|-------------------|----------------------|---------------------|-----------|----------------------|----------------------|
| 1 Pa | 1 | $10.2 \cdot 10^{-6}$ | $7.5 \cdot 10^{-3}$ | 10^{-2} | 10^{-5} | $9.81 \cdot 10^{-6}$ |
| 1 kg/cm ² | $98.1 \cdot 10^3$ | 1 | 735.5 | 980 | 0.98 | 0.96 |
| 1 Torr | 133 | $1.35 \cdot 10^{-3}$ | 1 | 1.33 | $1.33 \cdot 10^{-3}$ | $1.31 \cdot 10^{-3}$ |
| 1 mbar | 101 | $1.02 \cdot 10^{-3}$ | 0.75 | 1 | 10^{-3} | $0.98 \cdot 10^{-3}$ |
| 1 bar | $1.01 \cdot 10^5$ | 1.02 | 750 | 10^3 | 1 | 0.98 |
| 1 atm | 101 300 | 1.03 | 760 | 1 013 | 1.01 | 1 |

As a consequence of the « vacuum force » ...

| | | | | | | | | |
|--------|----|----|----|----|-----|-----|-----|-----|
| □ (mm) | 16 | 35 | 63 | 80 | 100 | 130 | 150 | 212 |
| kg | 2 | 10 | 32 | 52 | 81 | 137 | 182 | 363 |

Ideal Gas Law

- Statistical treatment which concerns molecules submitted to thermal agitation (no interaction between molecules, random movement, the pressure is due to molecules hitting the surface)
- For such a gas, the pressure, P [Pa], is defined by the gas density, n [molecules.m⁻³], the temperature of the gas, T [K] and the Boltzman constant k , ($1.38 \cdot 10^{-23}$ J/K)

$$P = n k T$$

- The distribution of velocities, dn/dv , follows a Maxwell-Boltzmann function
- The average velocity is :

$$\bar{v} = \sqrt{\frac{8kT}{\pi m}} = 146 \sqrt{\frac{T}{M}}$$

- At room temperature (m/s) :

| He | Air | Ar |
|------|-----|-----|
| 1800 | 470 | 400 |

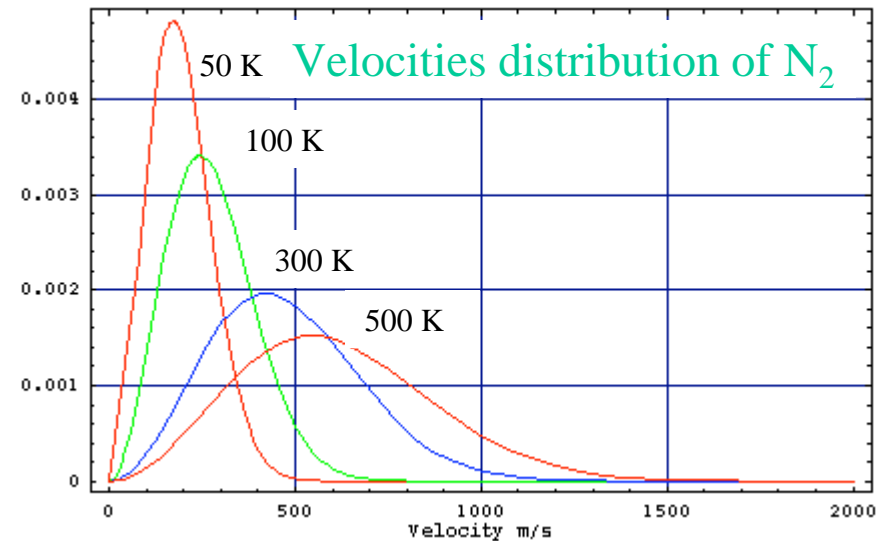

Total Pressure and Partial Pressure

- The gas is usually composed of several types of molecules (ex : air, residual gas in vacuum systems)
- The **total pressure**, P_{Tot} , is the sum of all the **partial pressure**, P_i (Dalton law)

$$P_{\text{Tot}} = \sum P_i = k T \sum n_i$$

Partial pressures for atmospheric air

| Gas | % | Pi (Pa) |
|-----------------|----------------------|----------------------|
| N ₂ | 78.1 | 7.9 10 ⁴ |
| O ₂ | 20.5 | 2.8 10 ³ |
| Ar | 0.93 | 1.2 10 ² |
| CO ₂ | 0.0033 | 4.4 |
| Ne | 1.8 10 ⁻³ | 2.4 10 ⁻¹ |
| He | 5.2 10 ⁻⁴ | 7 10 ⁻² |

Mean Free Path

- It is the path length that a molecules traverse between **two successive impacts with other molecules**. It depends of the pressure, of the temperature and of the molecular diameter.

- It increases linearly with temperature

- For air at room temperature :

$$\lambda_{air} [cm] = \frac{510^3}{P[Torr]}$$

- At atmospheric pressure, $\lambda = 70 \text{ nm}$

- At 1 Torr, $\lambda = 50 \text{ }\mu\text{m}$

- At 10^{-3} Torr, $\lambda = 5 \text{ cm}$

- At 10^{-7} Torr, $\lambda = 500 \text{ m}$

- At 10^{-10} Torr, $\lambda = 500 \text{ km}$

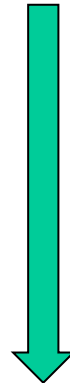

Increasing mean free path
when decreasing pressure

Turbulent and Viscous Flows

- When pumping down from atmospheric pressure, the physics is characterised by different flow regimes. It is a function of the pressure, of the mean free path and of the components dimensions.

- Reynold number, Re :

- if $Re > 2000$ the flow is turbulent
- it is viscous if $Re < 1000$

$$Re = \frac{Q[Torr.l/s]}{0.089D[cm]}$$

- The **turbulent** flow is established around the **atmospheric pressure**

- In the **low vacuum** (10^3 -1 mbar), the flow is **viscous**. The flow is determined by the interaction between the molecules themselves. The flow is **laminar**. The mean free path of the molecules is **small** compared to the diameter of the vacuum chamber

$$\text{Viscous flow : } \bar{P} D > 0.5 [Torr.cm]$$

Transition and Molecular Flows

- In the **medium vacuum** ($1-10^{-3}$ mbar), the flow is **transitional**. In every day work, this range is transited quickly when pumping down vacuum chambers. In this regime, the calculation of the conductance is complex. A simple estimation is obtained by adding laminar and molecular conductances.
- In the **high vacuum** ($10^{-3} - 10^{-7}$ mbar) and **ultra-high vacuum** ($10^{-7}-10^{-12}$ mbar), the flow is **molecular**. The mean free path is **much larger** than the vacuum chamber diameter. The molecular interactions do not longer occurs. Molecules interact **only** with the vacuum chamber walls

$$\text{Molecular flow : } \bar{P} D < 1.5 \cdot 10^{-2} [\text{Torr} \cdot \text{cm}]$$

Molecular flow is the main regime of flow to be used in vacuum technology

In this regime, the vacuum vessel has been evacuated from its volume. The pressure inside the vessel is dominated by the nature of **the surface**.

Conductance

- It is defined by the ratio of the molecular flux, Q , to the pressure drop along a vacuum vessel. It is a function of the shape of the vessel, the nature of the gas and its temperature.

$$C = \frac{Q}{(P_1 - P_2)}$$

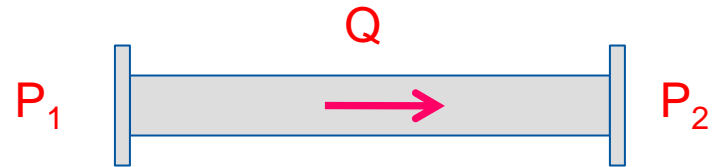

- Adding conductances in parallel

$$C = C_1 + C_2$$

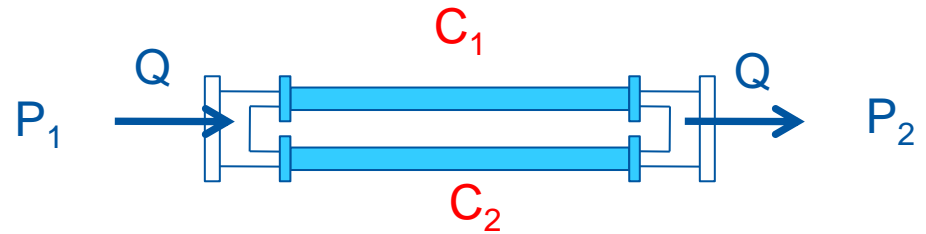

- Adding conductances in series

$$\frac{1}{C} = \frac{1}{C_1} + \frac{1}{C_2}$$

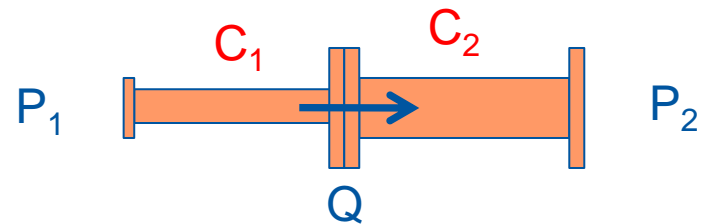

Conductance Calculus in Molecular Regime

- For an orifice :

$$C = \sqrt{\frac{kT}{2\pi m}} A; \quad C_{\text{air}, 20^\circ} [l/s] = 11.6 A [cm^2]$$

The conductance of an orifice of 10 cm diameter is 900 l/s

- For a tube :

$$C = \frac{1}{6} \sqrt{\frac{2\pi kT}{m}} \frac{D^3}{L}; \quad C_{\text{air}, 20^\circ} [l/s] = 12.1 \frac{D [cm]^3}{L [cm]}$$

The specific conductance of a tube of 10 cm diameter is 120 l/s.m

To increase the conductance of a vacuum system, it is better to have a vacuum chamber with large diameter and short length

Pumping Speed

- The pumping speed, S , is the ratio of the flux of molecules pumped to the pressure

$$S = \frac{Q}{P}$$

Diagram illustrating the pumping speed equation $S = \frac{Q}{P}$. The equation is enclosed in a red box. An arrow points from the text "l/s" to the variable S . An arrow points from the text "mbar.l/s" to the variable Q . An arrow points from the text "mbar" to the variable P .

- S range from 10 to 20 000 l/s
- Q range from 10^{-12} mbar.l/s for metallic tubes to $10^{-5} - 10^{-4}$ mbar.l/s for plastics

3 orders of magnitude for pumping

vs

8 orders of magnitude for outgassing

Outgassing MUST be optimised to achieve UHV

Outgassing

- The **outgassing rate**, q , of a surface is the number of molecules desorbed from a surface per unit of surface and per unit of time
- It is a function of the surface nature, of its cleanliness, of its temperature and of the pump down time.
- In all vacuum systems, the final pressure is **driven** by the outgassing rate : $P_{\text{final}} = Q/S = q A / S$

Metallic surfaces $q \sim q_0/t$

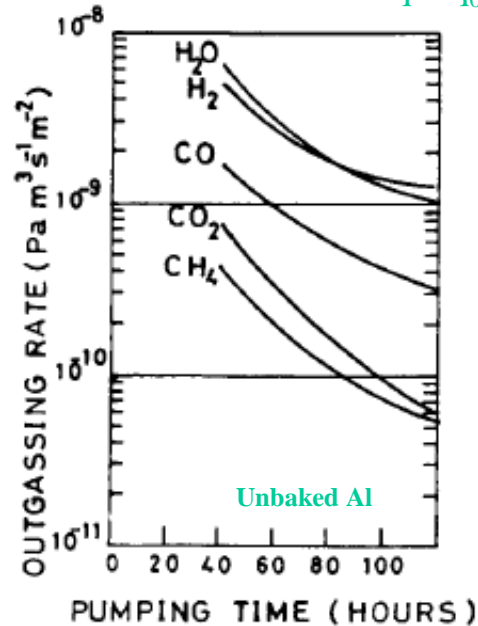

A.G. Mathewson *et al.*
J.Vac.Sci. 7(1), Jan/Fev 1989, 77-82

x 5 000



Plastic surfaces $q \sim q_0/\sqrt{t}$

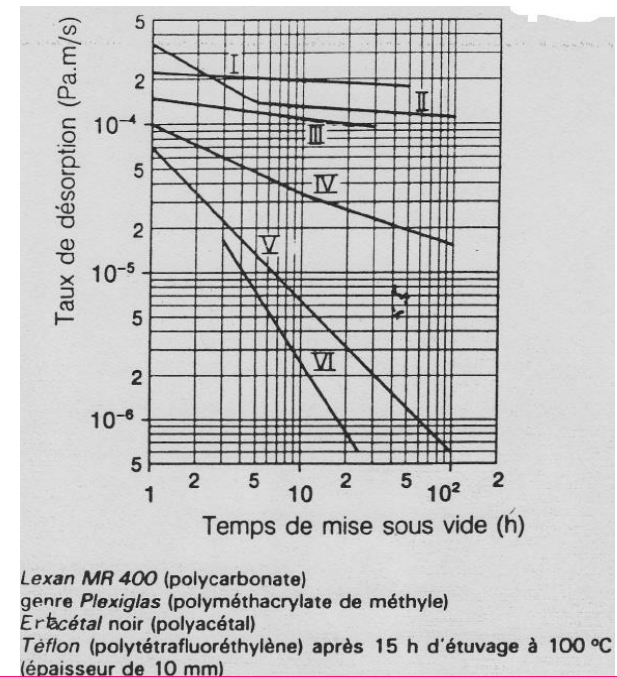

Good Vacuum Design :

Use ONLY metallic surfaces and reduce to ZERO the amount of plastics

Cleaning Methods

- Several means are used in vacuum technology to **reduce** the outgassing rates
- **Chemical cleaning** is used to remove gross contamination such as grease, oil, finger prints.
- Example of CERN LHC beam screens :

Degreasing with an alkaline detergent at 50°C in an ultrasonic bath

Running tap water rinse

Cold demineralised water rinse by immersion

Rinse with alcohol

Dry with ambient air

- **Vacuum firing** at 950°C is used to reduce the hydrogen content from stainless steel surface

Length: 6 m
Diameter: 1 m
Maximum charge weight: 1000 Kg
Ultimate pressure: $8 \cdot 10^{-8}$ Torr
Pressure at the end of the treatment: high 10^{-6} Torr



cuves for beam screens



- **Glow discharges** cleaning is used to remove by sputtering the adsorb gases and the metal atoms
- **Wear gloves to handle the material**

In Situ Bake Out

- The outgassing rate of unbaked surfaces is dominated by H₂O.
- A bake-out above 150 degrees increase the desorption rate of H₂O and reduce the H₂O sojourn time in such a way that H₂ become the dominant gas

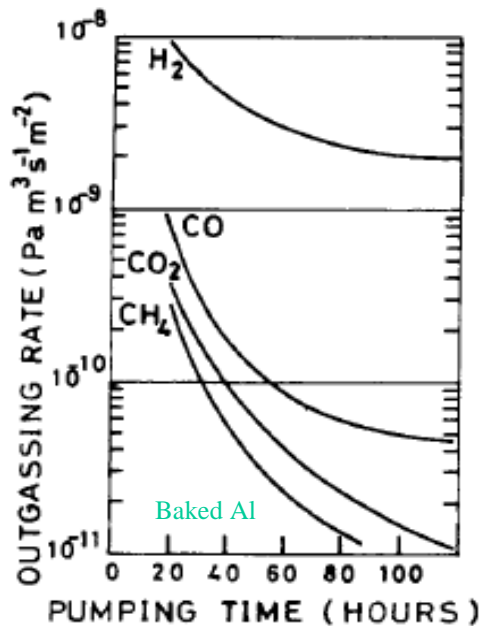

$$\tau = \frac{e^{\frac{E}{kT}}}{V_0}$$

Sojourn time of a molecule as a function of temperature

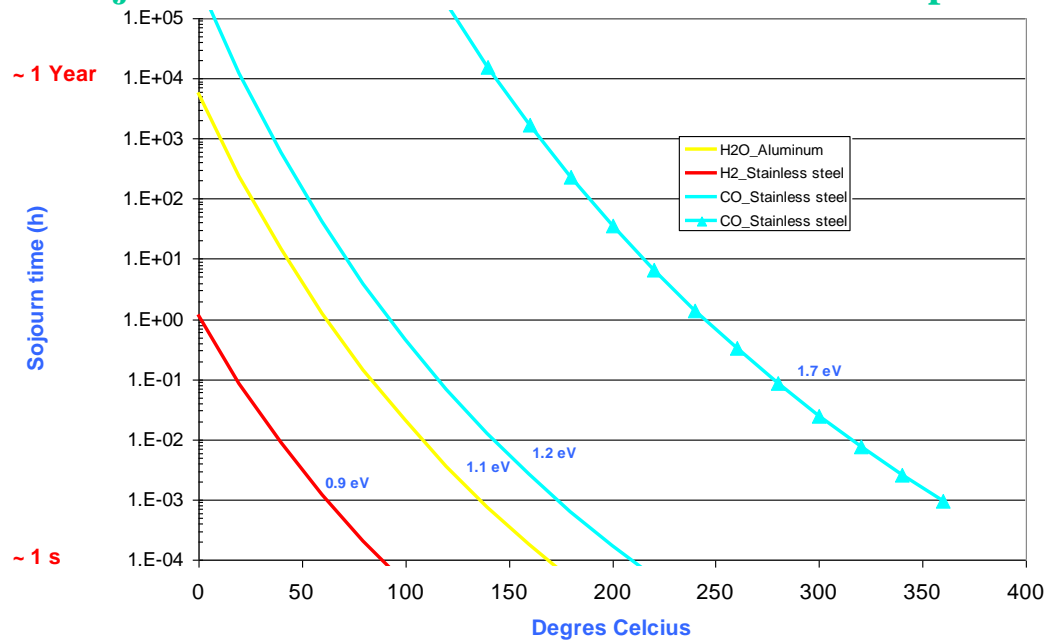

A.G. Mathewson *et al.*
J.Vac.Sci. 7(1), Jan/Fev 1989, 77-82

Stainless steel after 50 h of pumping (Torr.l/s/cm²)

| | H ₂ | CH ₄ | H ₂ O | CO | CO ₂ |
|---------|---------------------------|---------------------|---------------------------|---------------------|---------------------|
| Unbaked | 7 10 ⁻¹² | 5 10 ⁻¹³ | 3 10⁻¹⁰ | 5 10 ⁻¹² | 5 10 ⁻¹³ |
| Baked | 5 10⁻¹³ | 5 10 ⁻¹⁵ | 1 10 ⁻¹⁴ | 1 10 ⁻¹⁴ | 1 10 ⁻¹⁴ |

A.G. Mathewson *et al.* in Handbook of Accelerator Physics and Engineering, World Scientific, 1998

2. Vacuum Components

Pirani Gauge

- Pirani gauges are commonly used in the range 1 atm - 10^{-4} mbar.
- The operating principle is based on the variation of the thermal conductivity of the gases as a function of pressure. A resistor under vacuum is heated at a constant temperature ($\sim 120^\circ\text{C}$). The heating current required to keep the temperature constant is a measure of the pressure.
- In the viscous regime, the thermal conductivity is independent of the pressure. Therefore pressure readings given above 1 mbar are wrong !

True vs indicated pressure

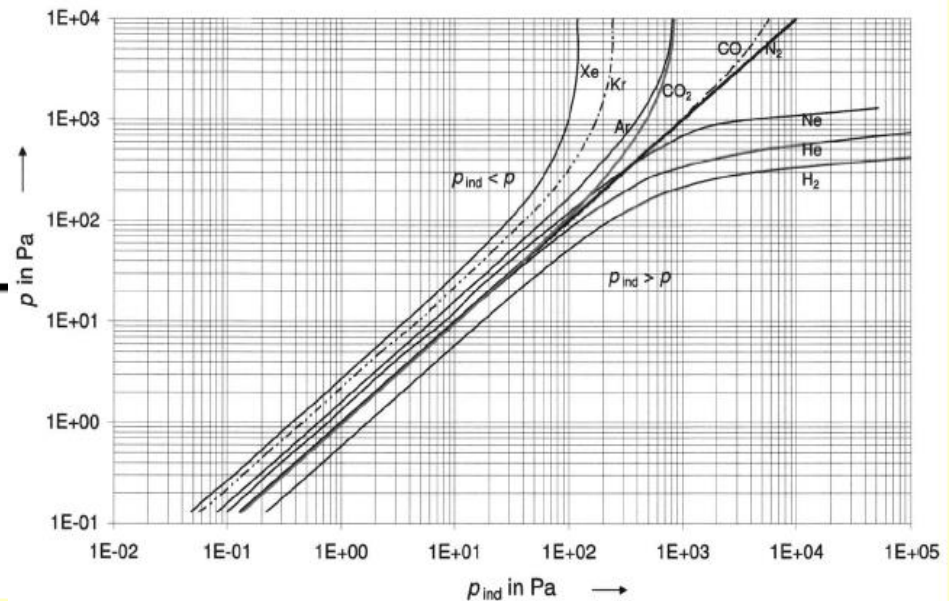
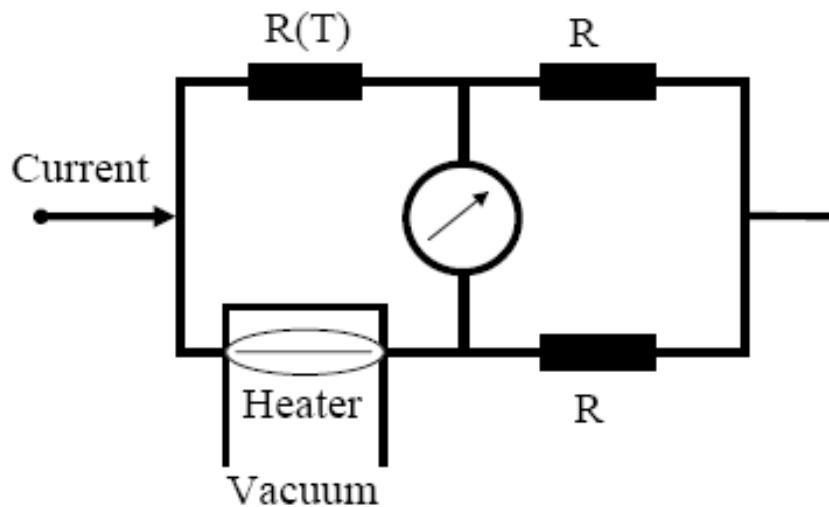

K. Jousten. J.Vac.Sci. 26(3), May/June 2008, 352-359

Penning Gauge

- Penning gauges are commonly used in the range 10^{-5} - 10^{-10} mbar. They are used for **interlocking** purposes
- It is a cold cathode ionisation gauge *i.e.* there are no hot filaments
- The operating principle is based on the **measurement of a discharge current** in a Penning cell which is a function of pressure : $I^+ = P^n$, n is close to 1
- At high pressure the discharge is unstable due to arcing.
- At low pressure, the discharge extinguishes which means zero pressure reading.
- Electrons are produced by field emission and perform oscillations due to the magnetic field
- Along the path length, molecules are ionised and ions are collected onto the **cathode**
- **WARNING** : leakage current on the HV cables simulates a higher pressure

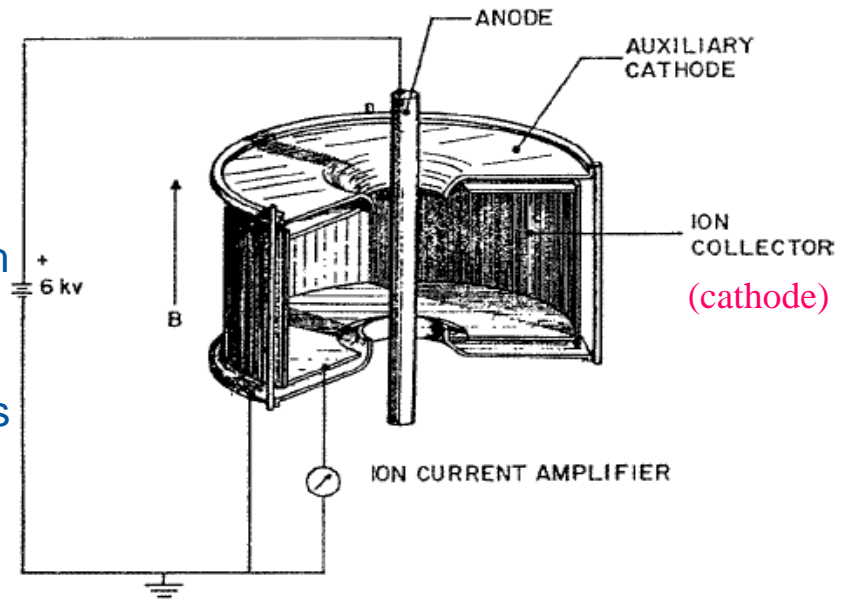

P. Redhead. J.Vac.Sci. 21(5), Sept/Oct 2003, S1-S5

Bayard-Alpert Gauge

- Bayard-Alpert gauges are used for vacuum **measurement** purposes in the range 10^{-5} - 10^{-12} mbar.
- It is a hot filament ionisation gauge. Electrons emitted by the filament perform oscillations inside the grid and ionise the molecules of the residual gas. Ions are then collected by an electrode.

$$I^+ = I^- \sigma n L$$

Where :

I^+ is the ion current

I^- is the filament current

σ is the ionisation cross section
 n the gas density

L the electron path length

- The gauge needs to be calibrated
- X-ray limit of a few 10^{-12} mbar

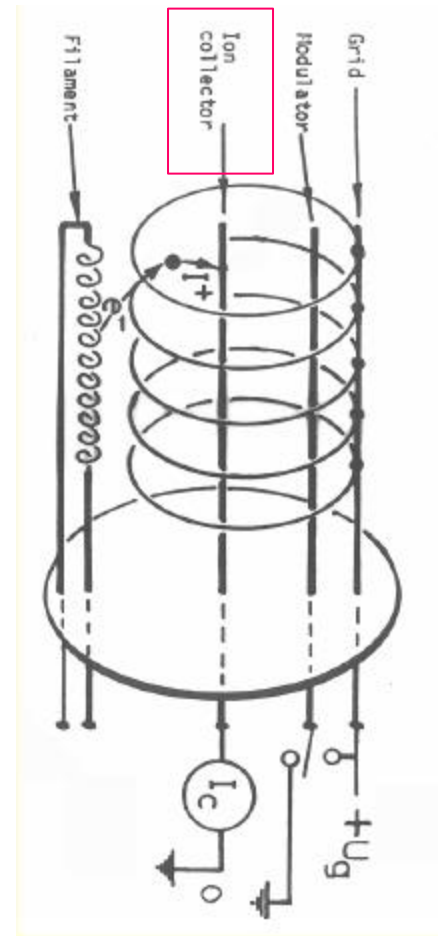
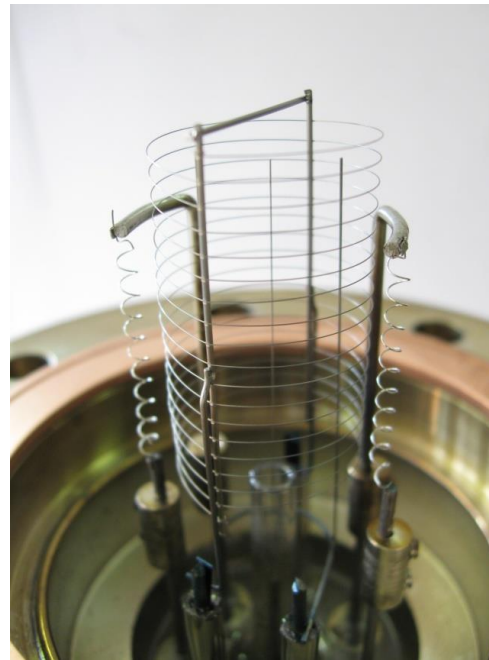

Residual Gas Analysers

- Residual Gas Analysers are used in the range 10^{-4} - 10^{-12} mbar. Their purpose is to do gas analysis
- A filament produces electrons which ionise the residual gas inside a grid. A mass filter is introduced between the grid and the ion collector. The ion current can be measured in Faraday mode or in secondary electron multiplier mode.
- It is a delicate instrument which produces spectrum sometimes difficult to analyse
- It can be also used to identified/find leaks (Ar, N₂)
- The RGA needs to be calibrated

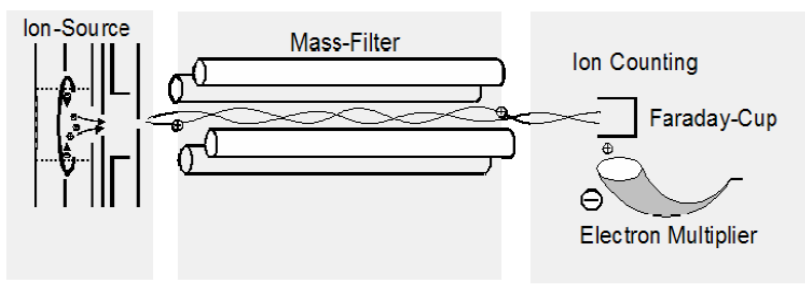

G.J. Peter, N. Müller. CAS Vacuum in accelerators CERN 2007-003

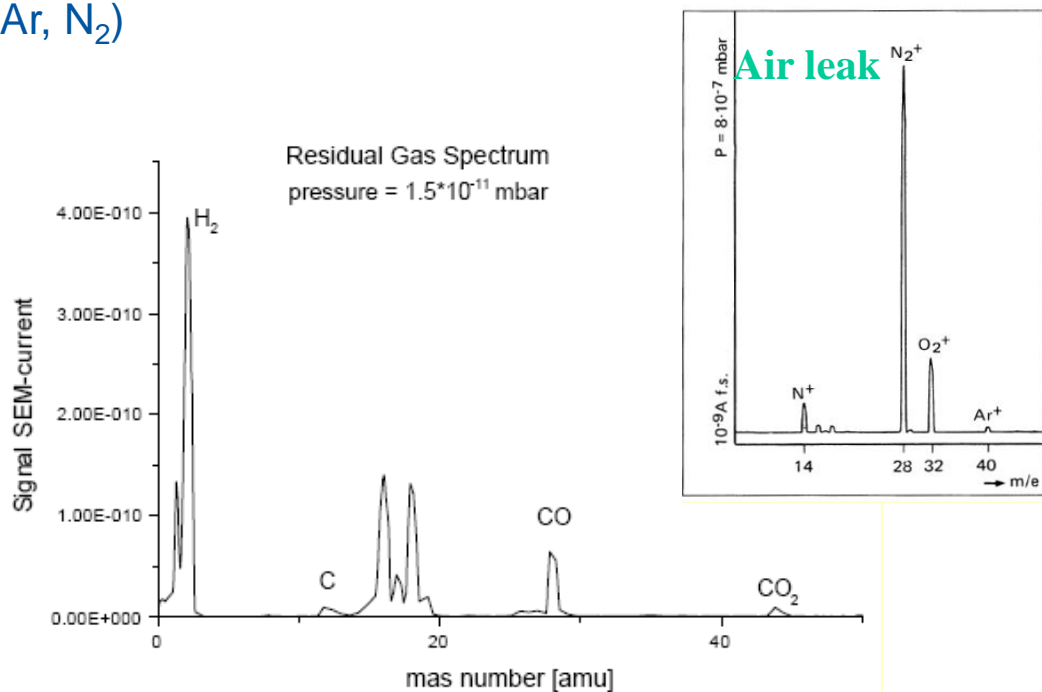

Primary Pumps

- Are used to pump down from atmosphere down to 10^{-2} mbar with a speed of a few m^3/h
- They are usually used as a **backing pump** of turbomolecular pumps
- Two categories : dry and wet pumps.
- Dry pumps are expensive and need additional cooling (water)
- Wet pumps are operating with oil which acts as a sealing, a lubricant, a heat exchanger and protects parts from rust and corrosion

Oil Sealed Rotary Vane Pump

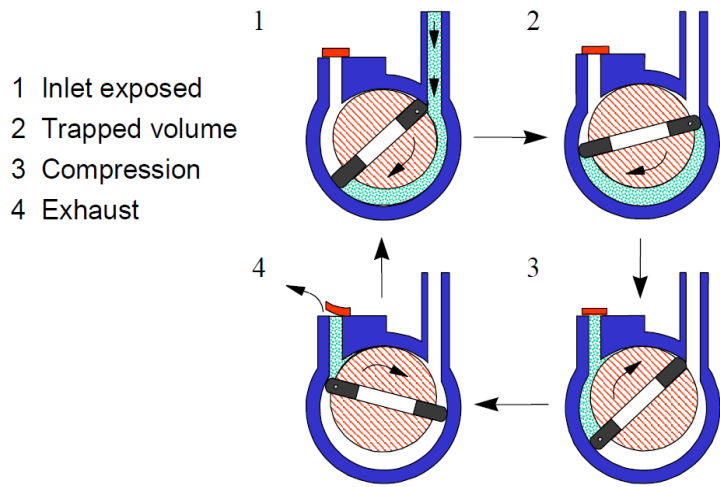

A.D. Chew. CAS Vacuum in accelerators CERN 2007-003

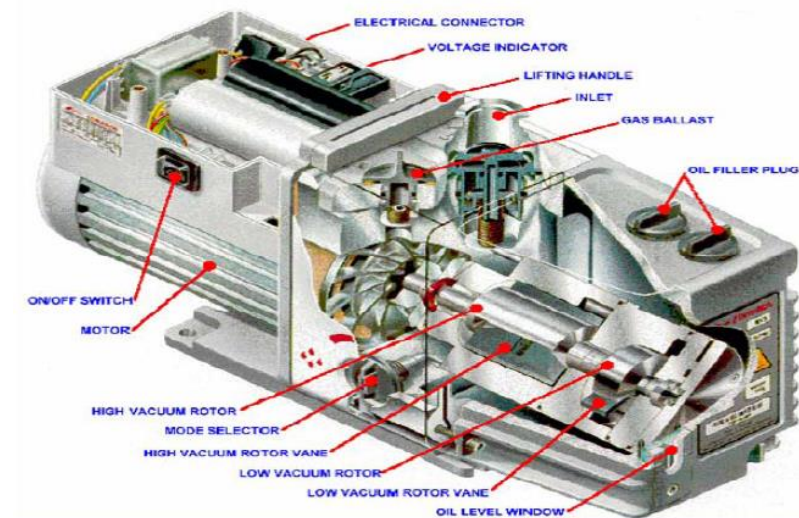

Turbomolecular Pump

- This pump operates in the molecular regime and is used to **pump down** an accelerator vacuum system. Usually, it is installed with its primary pump on a mobile trolley : it can be removed after valving off
- Its ultimate pressure can be very low : 10^{-11} mbar
- Its pumping speed range from 10 to 3 000 l/s

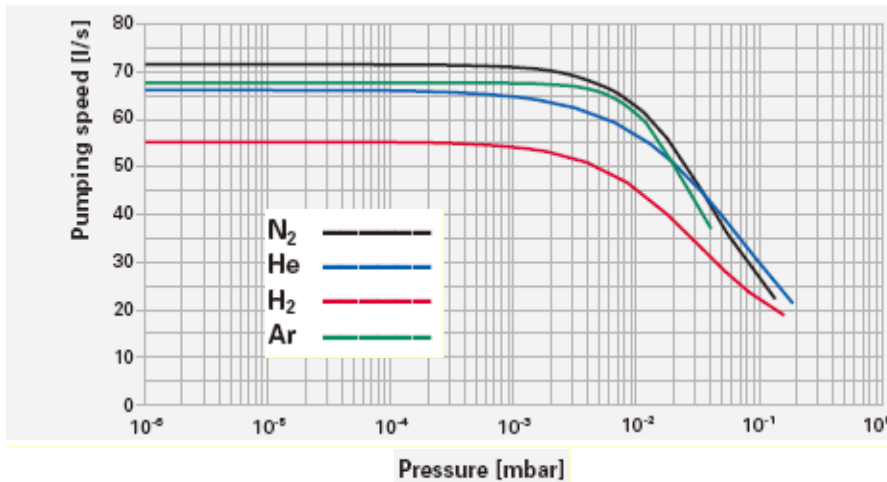

- The pumping mechanism is based on the **transfer of impulse**. When a molecule collides a blade, it is adsorbed for a certain length of time. After re-emission, the blade speed is added to the thermal speed of the molecules. To be significant, the blade speed must be comparable to the thermal speed hence it requires fast moving surfaces ($\sim 40\,000$ turns/min)

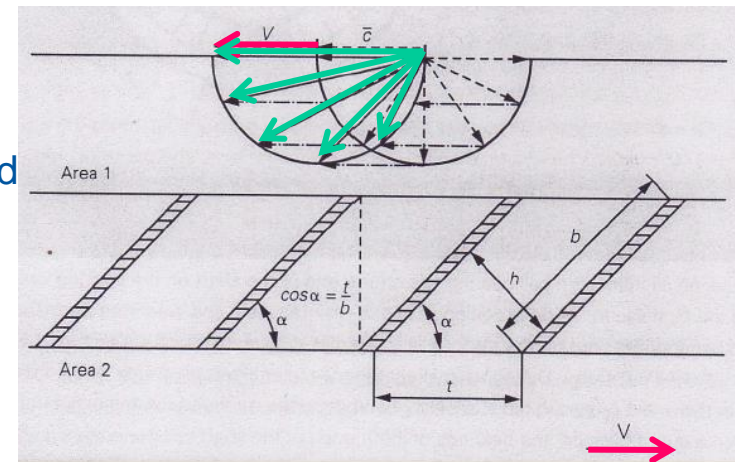

- The compression ratio (P_{inlet}/P_{outlet}) increase exponentially with \sqrt{M} : **“clean” vacuum without hydrocarbons**. So, the oil contamination from the primary pump is avoided

Sputter Ion Pump

- This pump operates in the range 10^{-5} - 10^{-11} mbar. It is used to maintain the pressure in the vacuum chamber of an accelerator.
- Their pumping speed ranges from 1 to 500 l/s
- When electrons spiral in the Penning cell, they ionize molecules. Ions are accelerated towards the cathode (few kV) and sputter Ti. Ti, which is deposited onto the surfaces, forms a chemical bonding with molecules from the residual gas. Noble gases and hydrocarbons, which do not react with Ti, are buried or implanted onto the cathode.
- **Advantage** : like for a Penning gauge, the collected current is proportional to the pressure. It is also used for interlock.

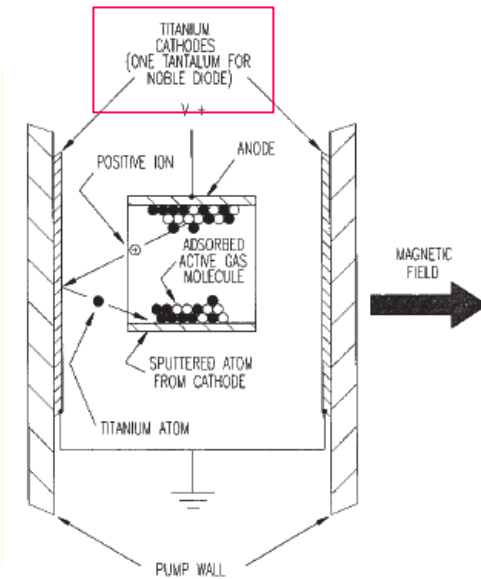
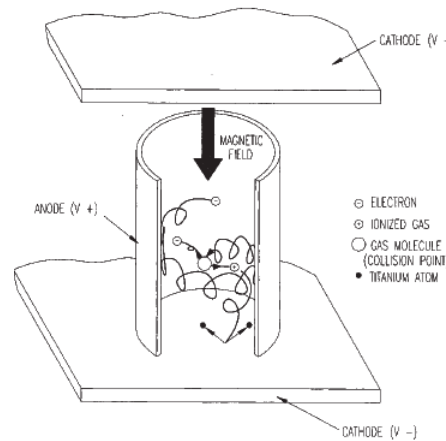
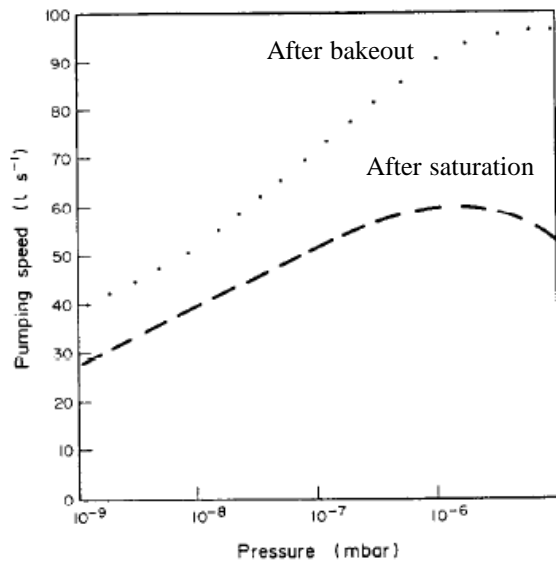

M. Audi. Vacuum 38 (1988) 669-671

Flanges and Gaskets

- For **primary vacuum**, elastomer seals and clamp flanges are used

- KF type components:

Many fittings (elbows, bellows, T, cross, flanges with short pipe, reductions, blank flanges ...)

ISO diameters

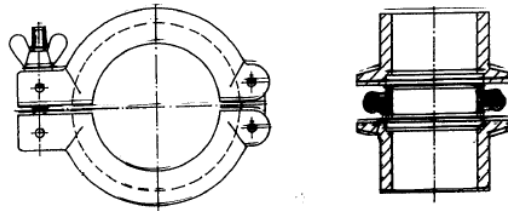

- For **ultra high vacuum**, metallic gaskets and bolts flanges are used

- Conflat® Type components :

Copper gaskets, blank flanges, rotatable flanges, welding flanges, elbows, T, crosses, adaptators, zero length double side flanges, windows ...

ISO diameters

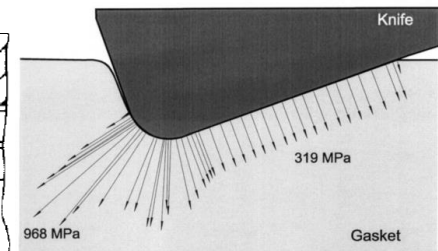
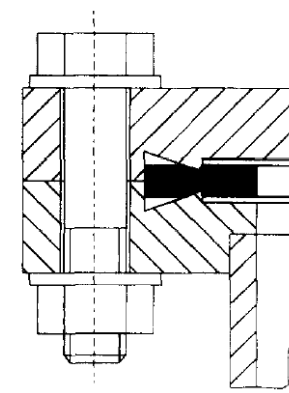

P. Lutkiewicz, C. Rathjen.
J.Vac.Sci. 26(3), May/Jun 2008, 537-544

Tubes, Bellows, Valves

- Metallic tubes are preferred (low outgassing rate)
- Stainless steel is appreciated for mechanical reason (machining, welding)



Copper tubes

- Bellows are equipped with RF fingers (impedance)



- Valves are used for roughing and sectorisation

Roughing
valve



Sector
valves



Leak Detection

- The vacuum system of an accelerator must be **leak tight** !
- All vacuum components must follow **acceptance tests** (leak detection, bake out, residual gas composition and outgassing rate) before installation in the tunnel
- **Virtual leaks**, due to a closed volume, must be eliminated during the **design phase**. Diagnostic can be made with a RGA by measuring the gas composition before and after venting with argon.
- Leaks could appear :
 - during components constructions at welds (cracks or porosity)
 - due to porosity of the material
 - during the assembly and the bake-out of the vacuum system (gaskets)
 - during beam operation due to thermal heating or corrosion
- Detection method : He is sprayed around the test piece and a helium leak detector (*i.e.* a RGA tune to He signal) is connected to the device under test.

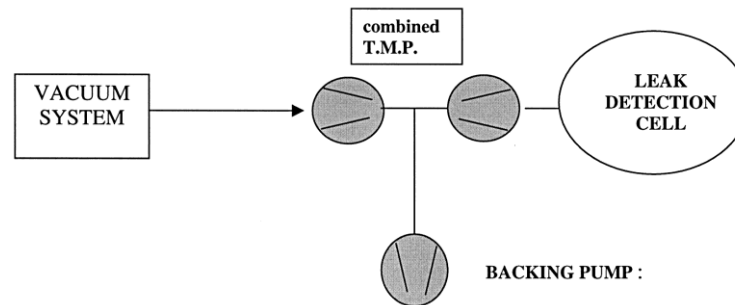

Counter flow method

3. Vacuum with Beams : LHC Example

More Work Required

- Despite all the precautions taken before ...
- More work is required from the vacuum scientist after the passage of the first (significant !) beam in his beautiful (and expensive) vacuum system

Why ?

- Because, the static pressure increases by several orders of magnitude due to dynamics effects related to the presence of a beam

HOW is it Possible ?

(next 6 slides are just a flavor of the main phenomena which are taking place in an accelerator)

3.1 Dynamic Effects

Photon Stimulated Desorption

- Synchrotron radiation induce gas desorption : SR machine, LEP, LHC
- Heat load and gas load
- η_{photon} is the photon desorption yield

Beam cleaning during the first period of LEP

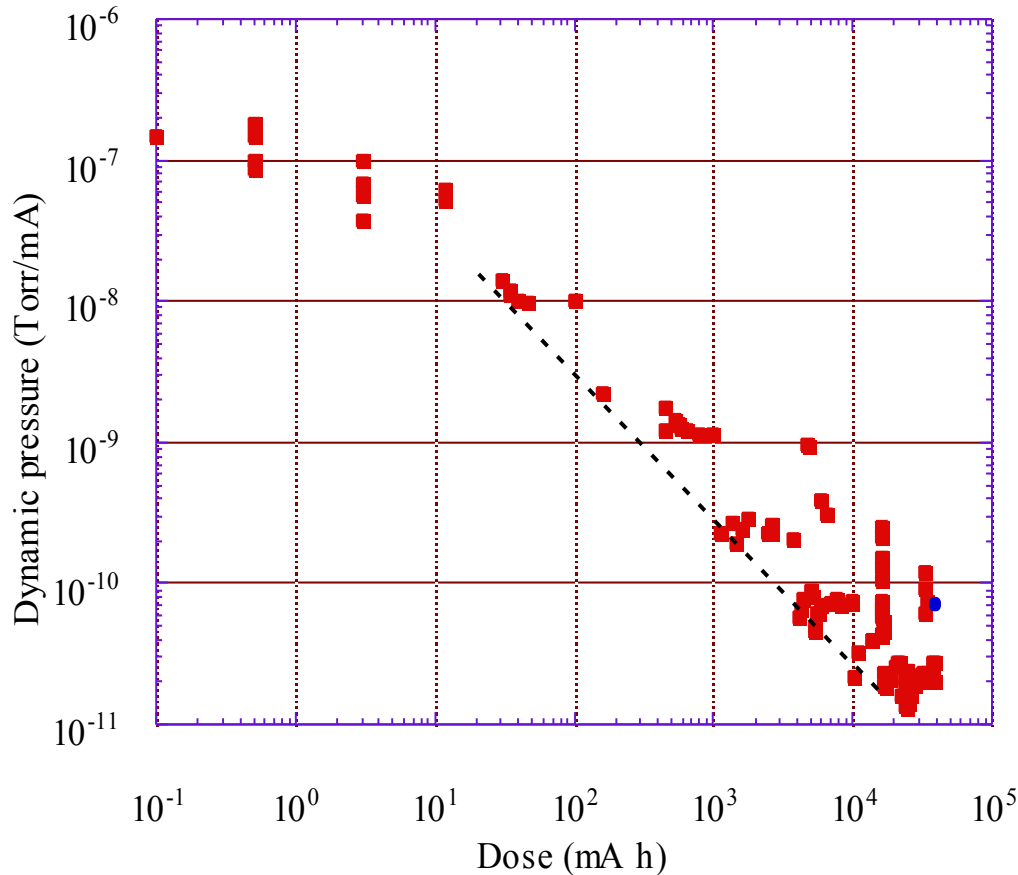

O. Gröbner. Vacuum 43 (1992) 27-30

$$P = \frac{Q + \eta_{\text{Photons}} \dot{\Gamma}_{\text{Photons}}}{S}$$

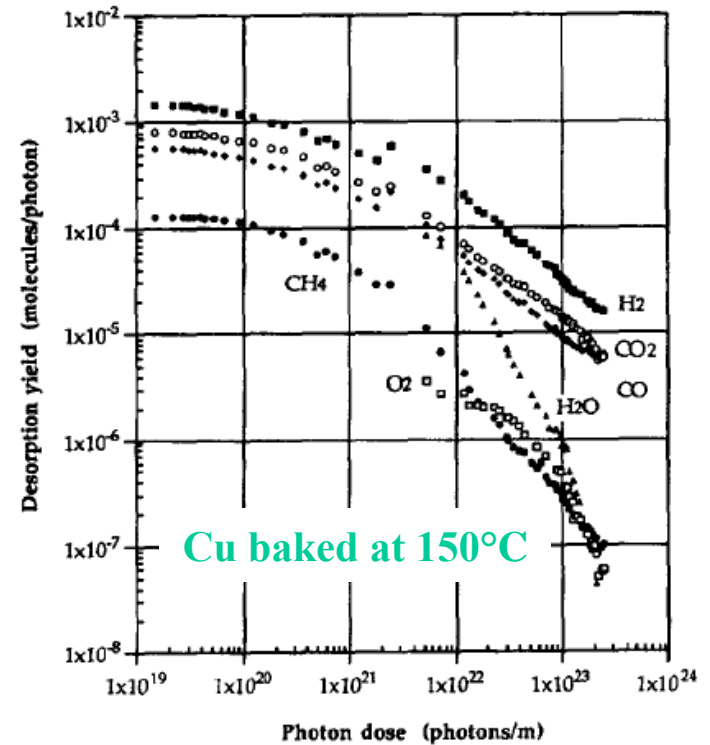

O. Gröbner *et al.*

J.Vac.Sci. 12(3), May/June 1994, 846-853

Vacuum Instability : the Effect

- In circular machine with large proton current : ISR, LHC

- Beam current stacking to 1 A
- Pressure increases to 10^{-6} Torr (x 50 in a minute)
- Beam losses

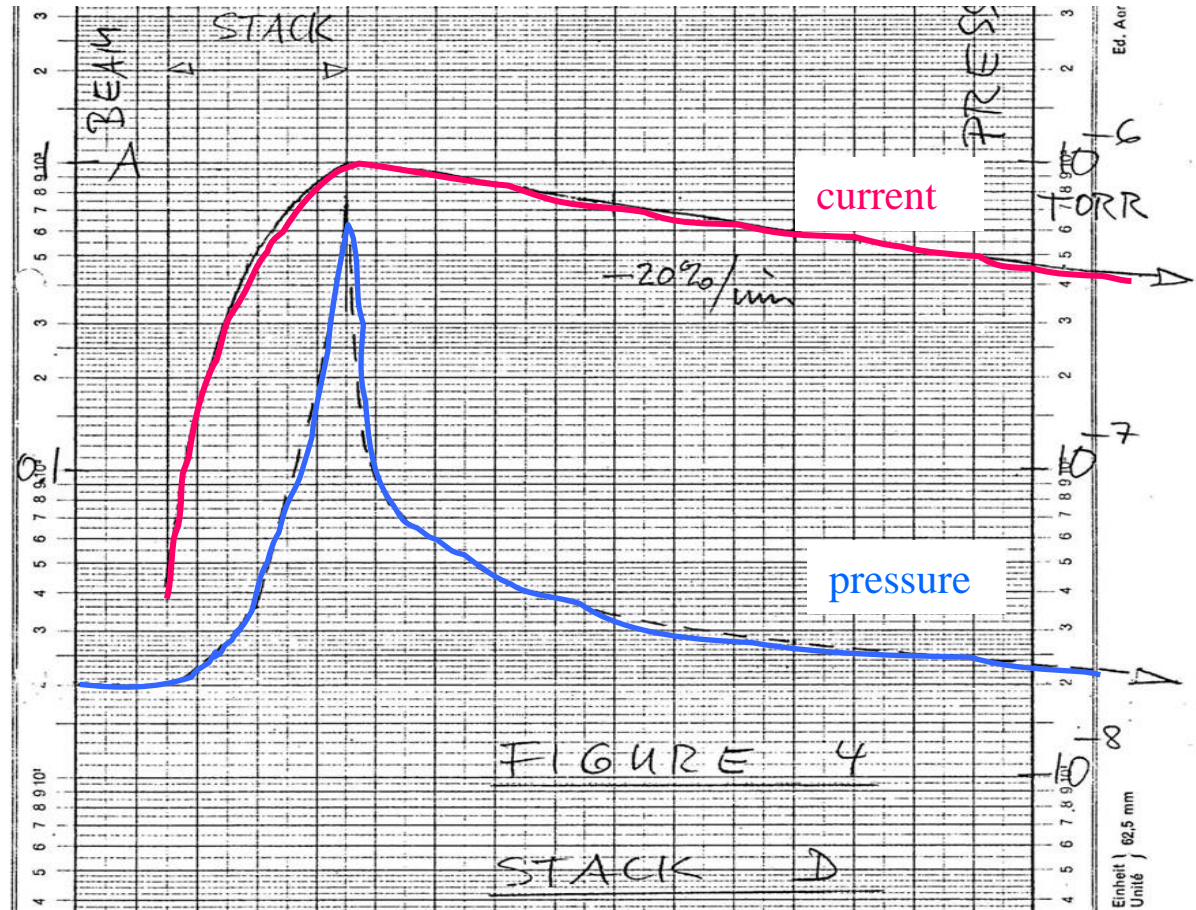

First documented pressure bump in the ISR

E. Fischer/O. Gröbner/E. Jones 18/11/1970

Vacuum Instability : Mechanism and Recipe

- Origin is ions produced by **beam ionisation**
- **Reduction** of the effective pumping speed, S_{eff}

$$P_{\text{eq}} = \frac{Q}{S_{\text{eff}}} = \frac{Q}{S \left(1 - \frac{\eta_{\text{ion}} I}{S} \sigma \frac{I}{e} \right)}$$

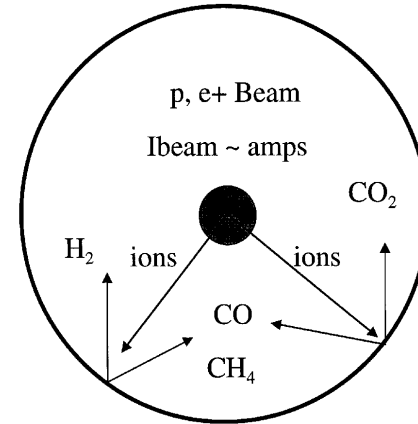

- When the beam current approach the **critical current**, the pressure increases to infinity

$$(\eta_{\text{ion}} I)_{\text{crit}} = \frac{e S_{\text{eff}}}{\sigma}$$

- Recipe:

Reduce η_{ion}
Increase pumping speed

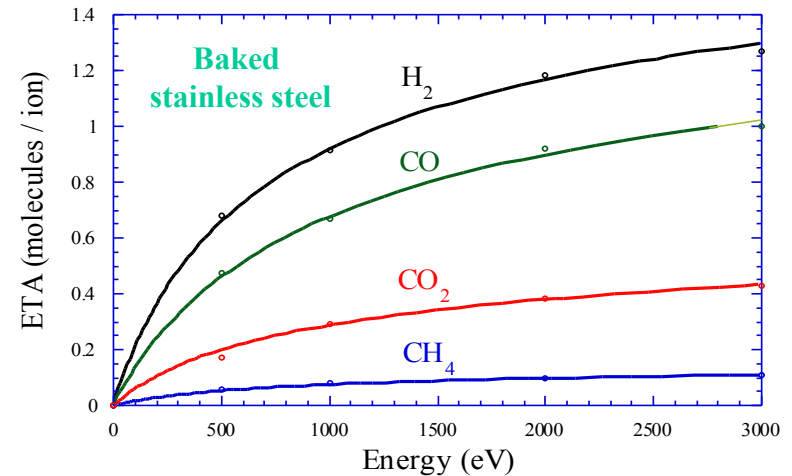

A.G. Mathewson, CERN ISR-VA/76-5

Electron Cloud : the Mechanism

- In modern machine with dense bunches and large positive current : KEK-B, PEP-II, SPS, RICH, LHC ...
- Emittance growth, gas desorption and heat load in cryogenic machine

- Key parameters :
 - bunch structure & current
 - vacuum chamber dimension
 - magnetic field
 - secondary electron yield
 - photon electron yield
 - electron and photon reflectivities

$$P = \frac{Q + \eta_{Electrons} \dot{\Gamma}_{Electrons}}{S}$$

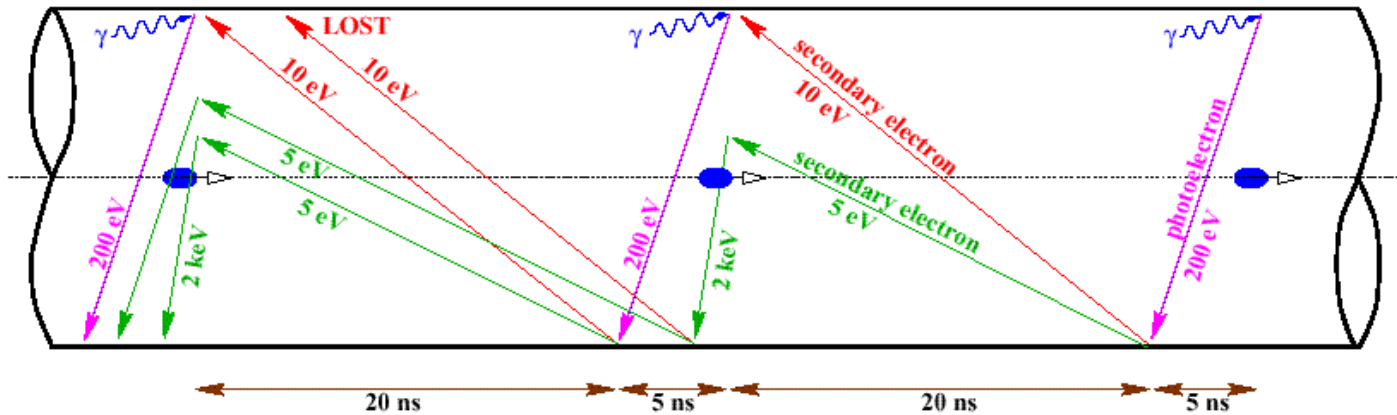

Schematic of **electron-cloud build up** in the LHC beam pipe.

F. Ruggiero *et al.*, LHC Project Report 188 1998, EPAC 98

Electron Cloud : the Recipes

- Play with the key parameters :
 - Reduce photoelectron yield (perpendicular vs grazing incidence)
 - Reduce secondary electron yields (scrubbing, TiZrV coatings, carbon coatings, geometry ..)
 - Reduce the amount of electrons in the system (solenoid magnetic field, clearing electrodes, material reflectivity ...)
 - Adapt the bunch structure or the chamber geometry to reduce multiplication
 - ...

Secondary Electron Yield

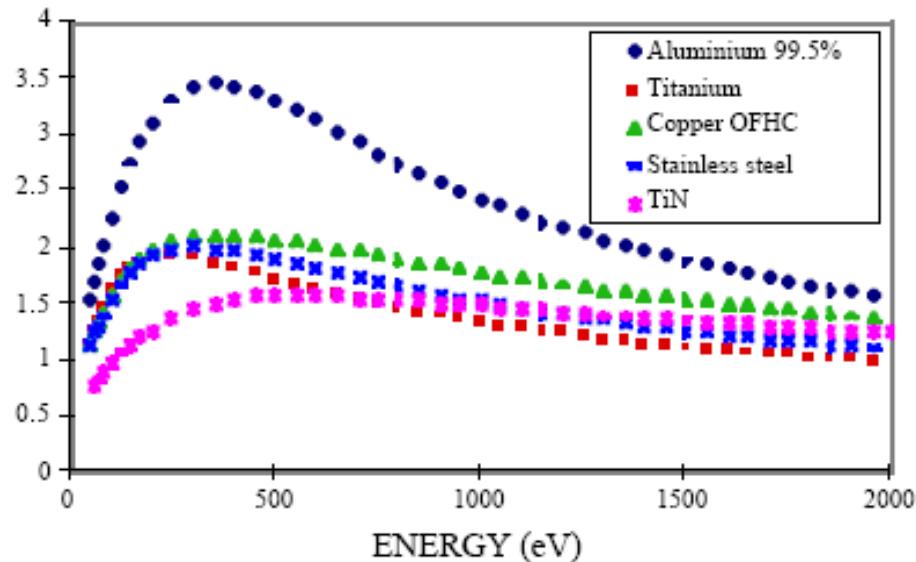

N. Hilleret *et al.*, LHC Project Report 433 2000, EPAC 00

Beam Induced Multipacting along the Beam Pipe

- Key parameters:

- beam structure
- bunch current
- vacuum chamber dimension
- secondary electron yield (SEY)
- photoelectron yield
- electron and photon reflectivities

Operational parameters

- Mitigations:

- NEG coating with low SEY (~ 1.1)
- **Beam scrubbing** to reduce SEY :
 Modification of C1s core level
 Conversion $sp^3 \Rightarrow sp^2$
 High energy electrons increase the number of graphitic like C-C bounds

- **Monitored** by ESD reduction

$$P = \frac{Q + \eta_{Electrons} \dot{\Gamma}_{Electrons}}{S}$$

R. Cimino *et al.* PRL 109, 064801(2012)

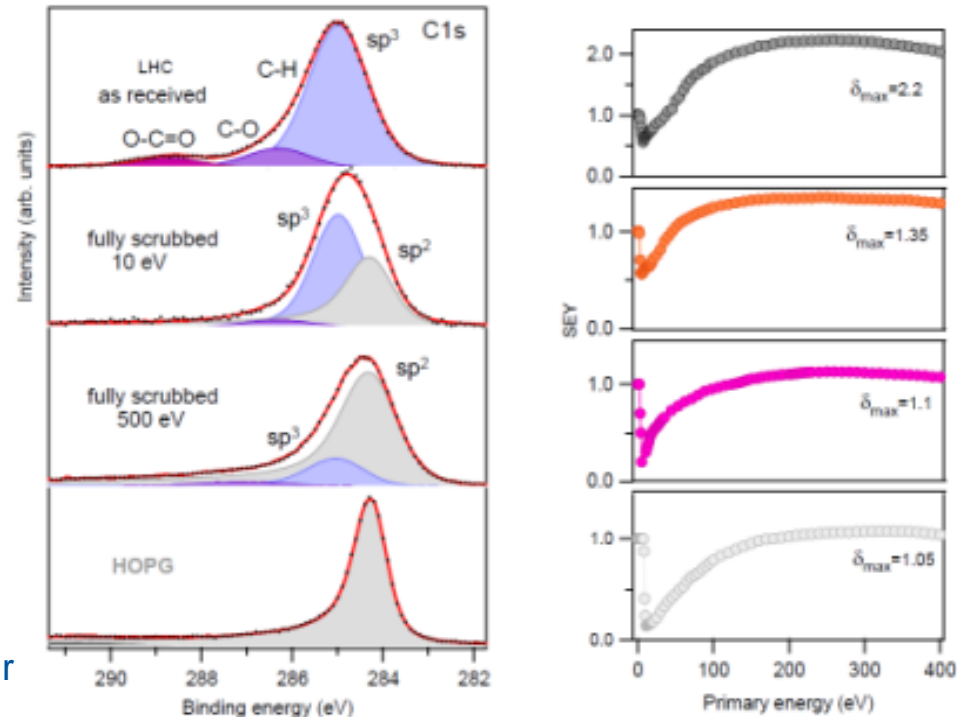

HOPG : highly oriented pyrolytic graphite

3.2 Arc Vacuum System

Cryogenic Beam Vacuum

2 independent beam pipes per arc:
8 arcs of 2.8 km each

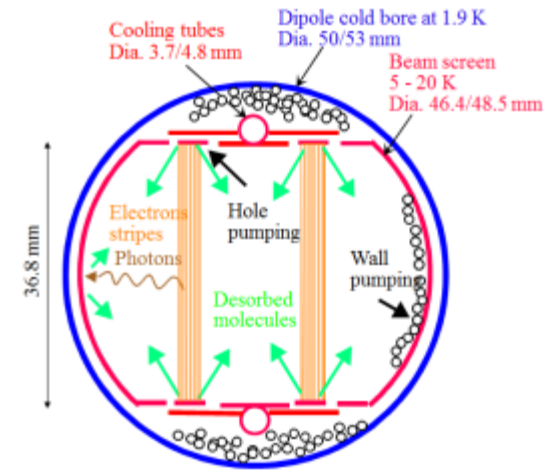
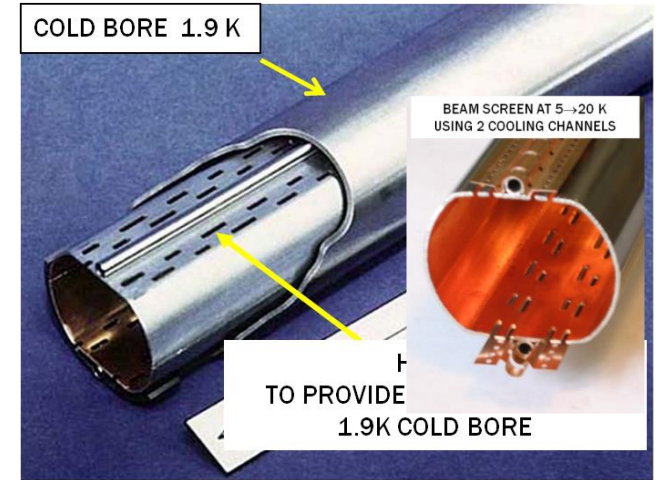
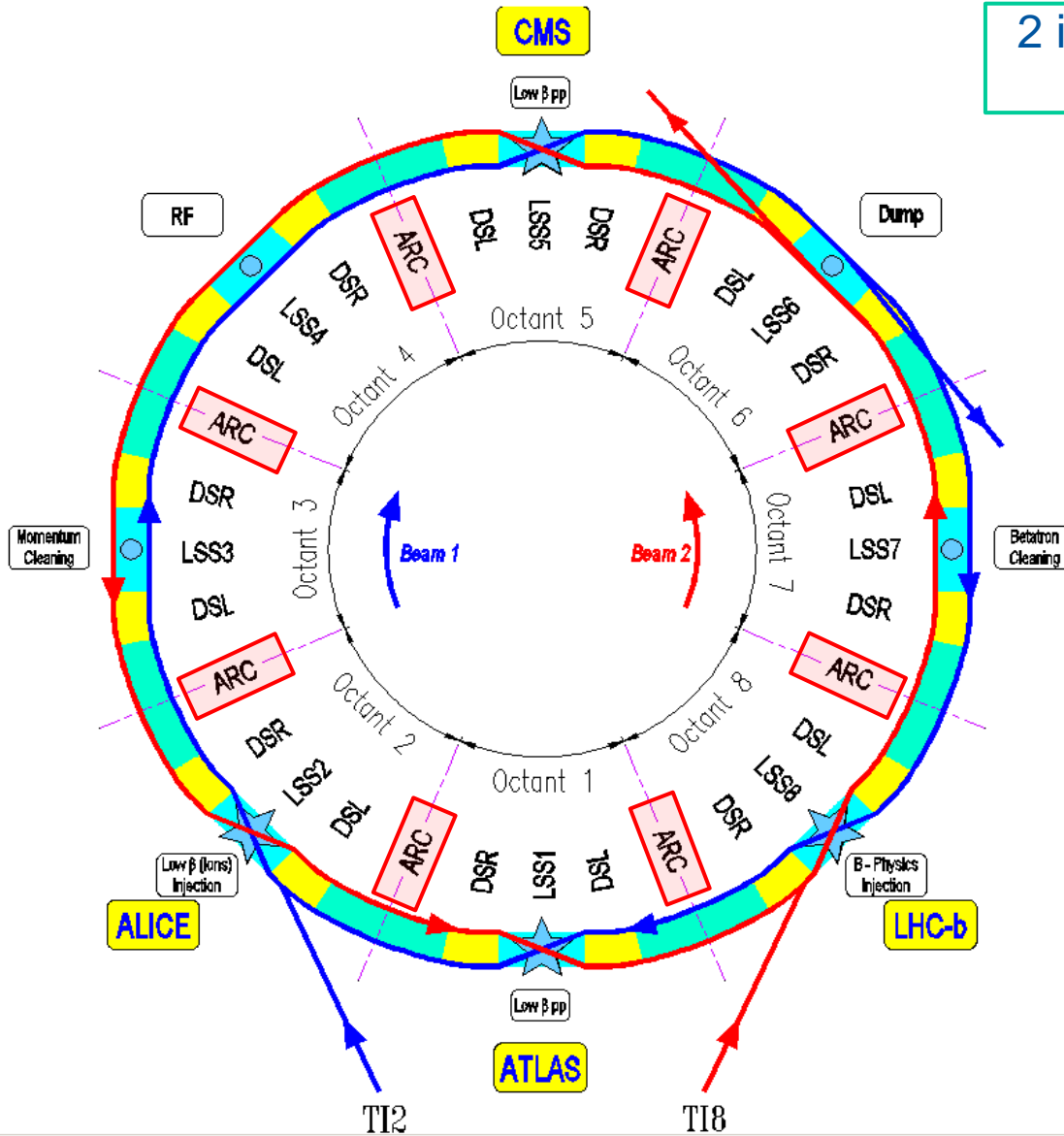

LHC Beam Screen Stability

- A minimum pumping speed is provided thanks to the beam screen's holes

$$(\eta_i I)_{\text{crit}} = \frac{e}{\sigma} S_{\text{eff}}$$

| | H ₂ | CH ₄ | CO | CO ₂ |
|------------------------------|----------------|-----------------|----|-----------------|
| $(\eta I)_{\text{crit}}$ [A] | 1300 | 80 | 70 | 35 |

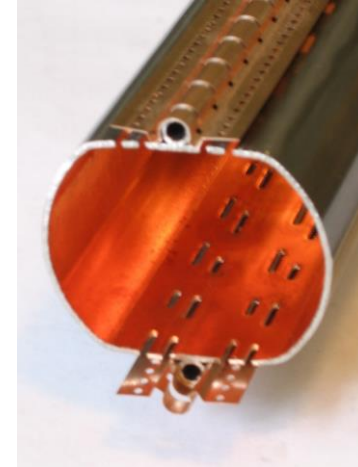

Courtesy N. Kos CERN TE/VSC

- Beam screen's holes provide **room for LHC upgrades**

- NB : In the long straight sections, vacuum stability is provided by TiZrV films and ion pumps which are less than 28 m apart

Beam Conditioning under SR

- Arc extremity's vacuum gauges : unbaked Cu and cryogenic beam screen
- Reduction by **2 orders of magnitude** since October 2010

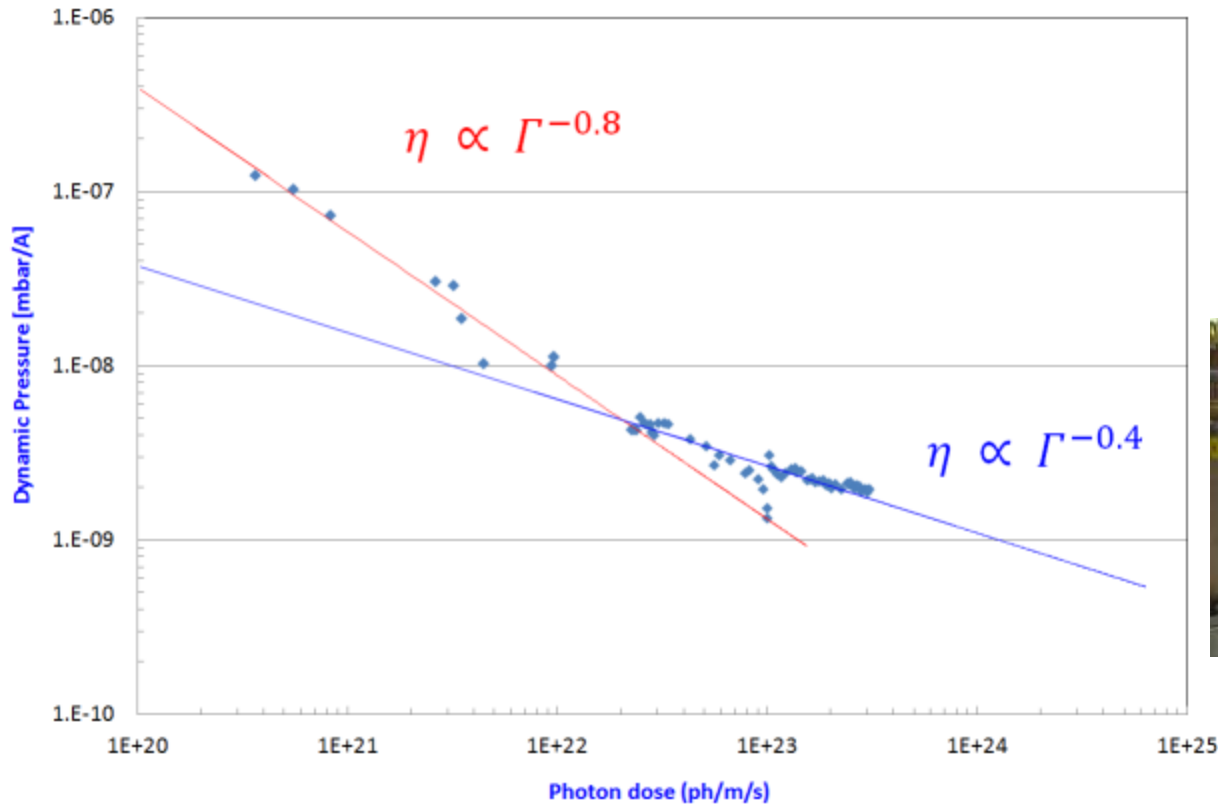

- 2 trends :
 - Room temperature
 - Cryogenic temperature

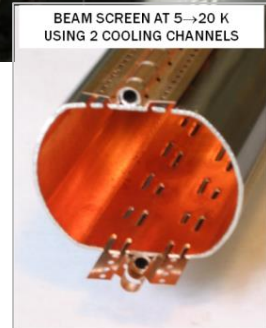

- Inside the arc, at 5-20 K, $\square P < 10^{-10}$ mbar (i.e. **below detection limit**)
- The photodesorption yield at **cryogenic temperature** is estimated to be $< 10^{-4}$ molecules/photon

Beam Scrubbing

- “Scrubbing” periods are required during LHC commissioning. Particularly during bunch spacing reduction and beam intensity increase

- Increase of beam life time with time
- Reduction of normalised heat load with time
- Strong pressure reduction in a short time

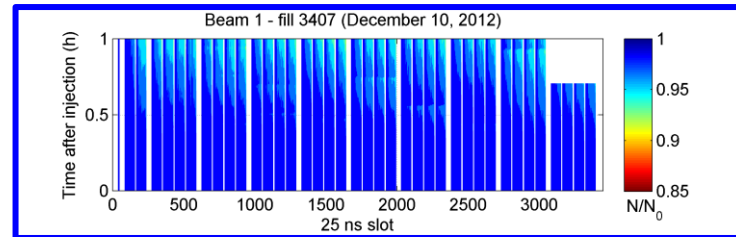
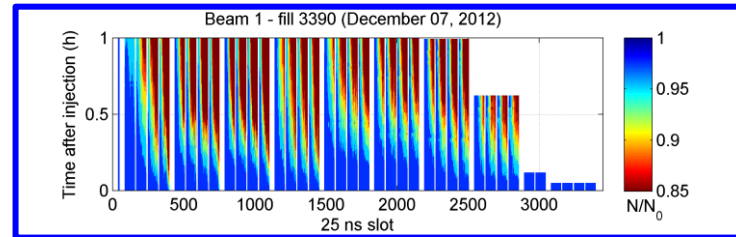

Courtesy G. Rumolo

27482748

| Date | Bunch spacing [ns] | Nb bunches | □P at 5-20 K [mbar] | Heat load on BS (W/m) | η_{electron} [molecule/e] |
|------------|--------------------|------------|----------------------|-----------------------|---------------------------------------|
| 9/4/2011 | 50 | 588 | $2 \cdot 10^{-9}$ | 0.08 | $1 \cdot 10^{-1}$ |
| 10/10/2011 | 50 | 804 | $1 \cdot 10^{-9}$ | 0.04 | $1 \cdot 10^{-1}$ |
| 14/10/2011 | 25 | 1092 | $1 \cdot 10^{-9}$ | 0.5 | $1 \cdot 10^{-2}$ |
| 7/12/2012 | 25 | 2748 | $< 1 \cdot 10^{-10}$ | 0.65 | $< 5 \cdot 10^{-4}$ |

- Observation of pressures increase inside the arc
=> Reduction with dose of electron desorption yield at cryogenic temperature

3.3 RT Vacuum System

Room Temperature Beam Vacuum

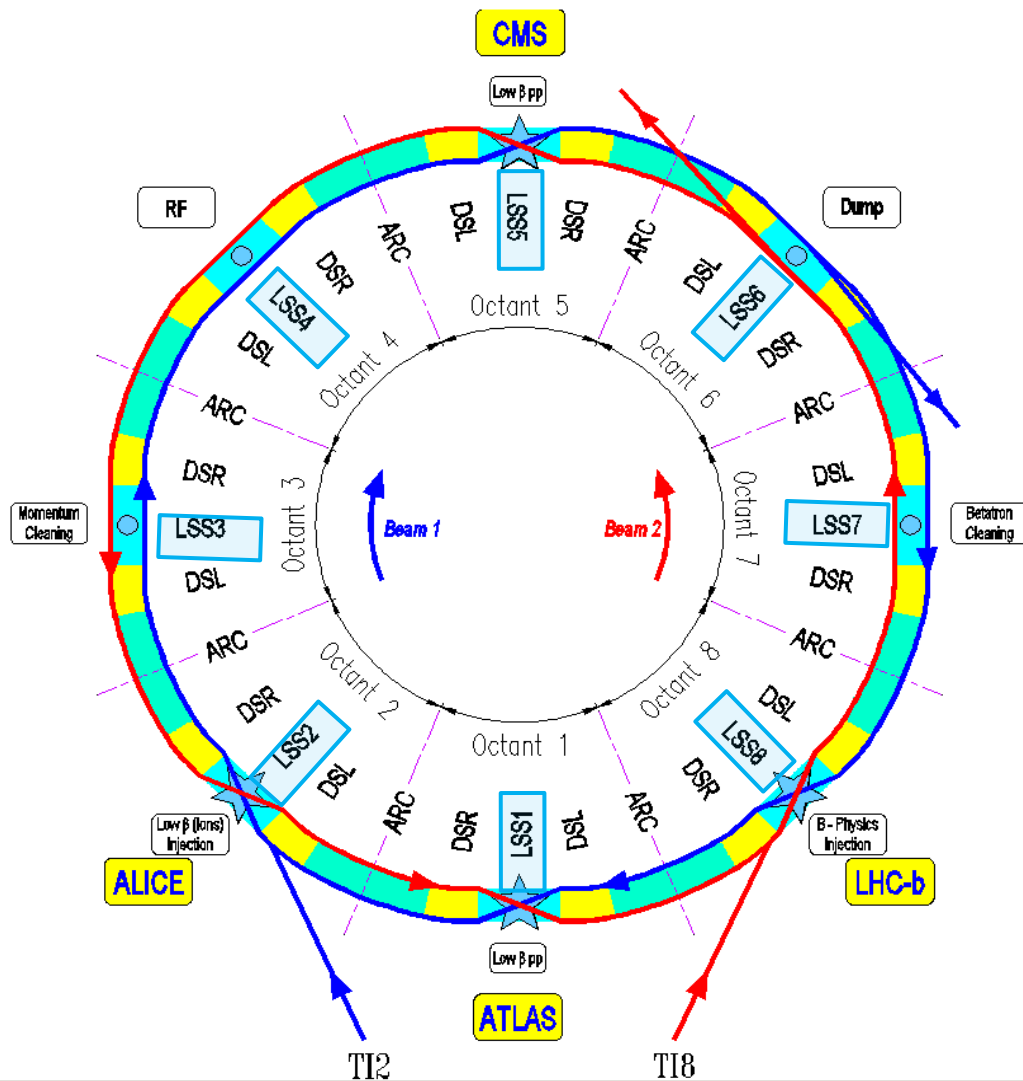

6 km of RT beam vacuum in the long straight sections

Extensive use of NEG coatings

Pressure $<10^{-11}$ mbar after vacuum activation

Standard Components Installed Inside LSS

- Warm magnets, kickers, septum, collimators, beam instrumentation ...

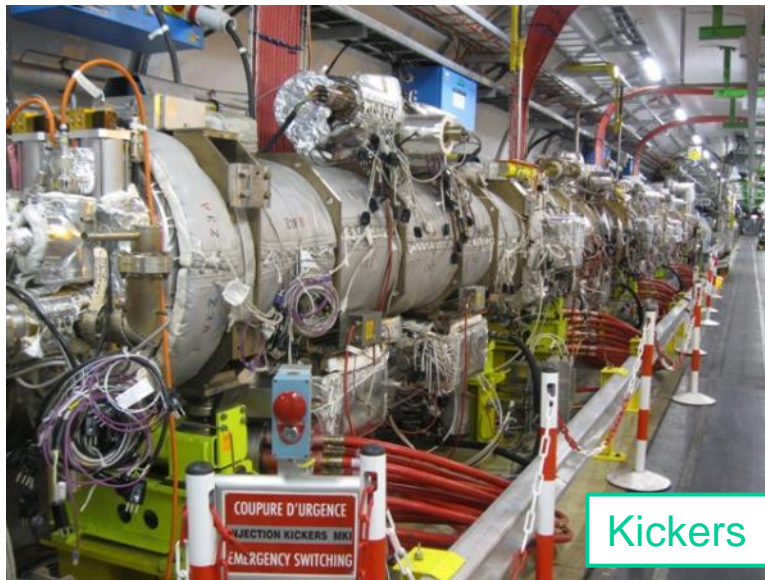
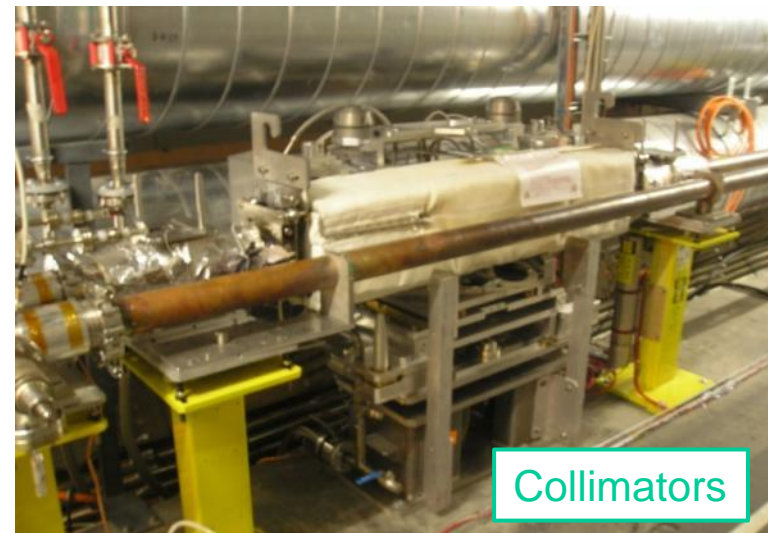

Vacuum Acceptance Tests

- Prior installation more than 2300 LSS's equipments have been baked and validated at the surface :

- leak detection
- residual gas composition
- total outgassing rate

- Example : studies for LHC collimators

- outgassing rate
- impact on getter coated vacuum chambers

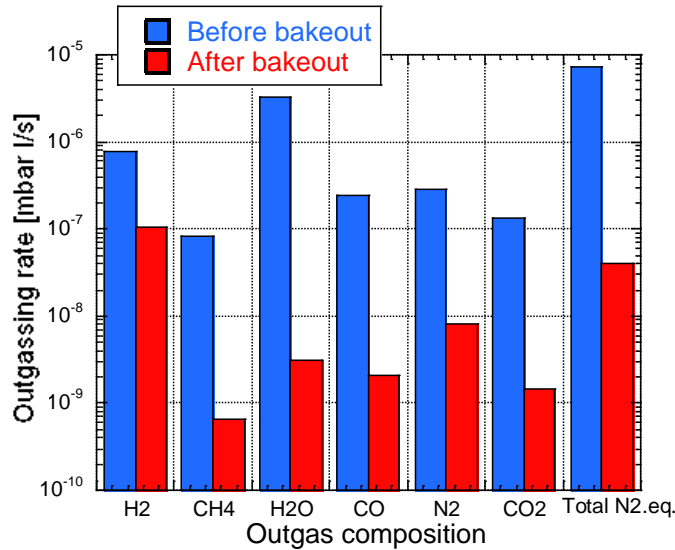

| Status | Q (mbar l / s) |
|--------------------------|--------------------|
| Unbaked | 7 10 ⁻⁶ |
| 1st bake-out | 7 10 ⁻⁸ |
| 2 nd bake-out | 5 10 ⁻⁸ |
| 3rd bake-out | 4 10 ⁻⁸ |

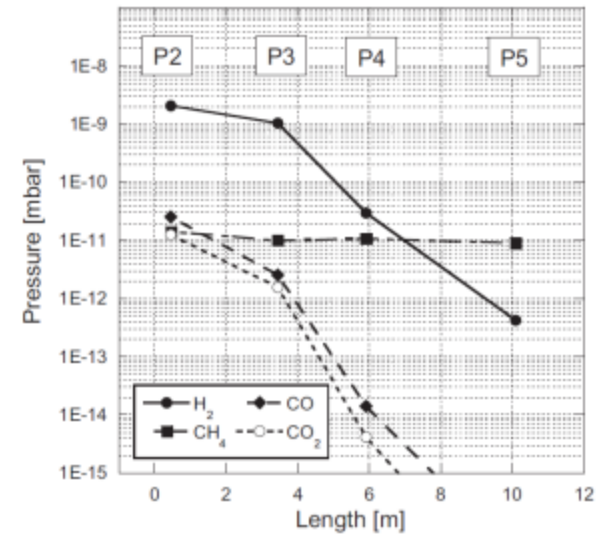

J. Kamiya *et al.* Vacuum 85 (2011) 1178-1181

Room Temperature Vacuum System

- ~ 1 μm thick, Non Evaporable Getter TiZrV coated vacuum chambers ensure the required vacuum performances for LHC
- Some vacuum chambers were constructed and getter coated ...



Courtesy R.Veness and P. Chiggiato TE-VSC

LSS Coating System

- Ti-Zr-V is coated by **magnetron sputtering** with Kr gas
- ~ 1 μm thick
- All room temperature vacuum chamber including the experimental beam pipe are coated with Ti-Zr-V

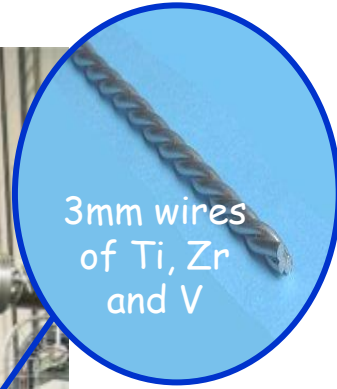
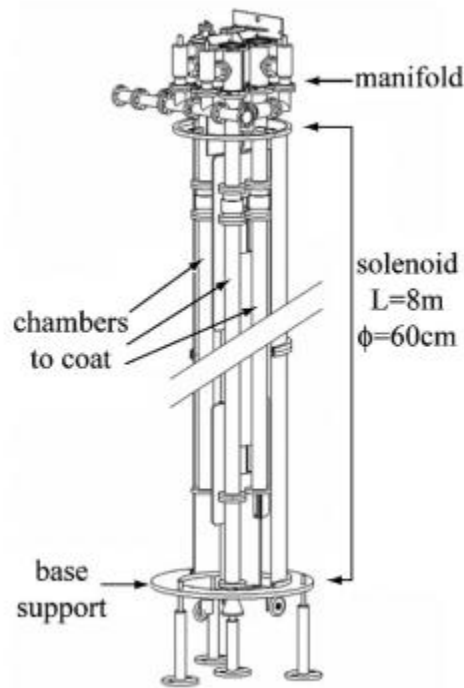
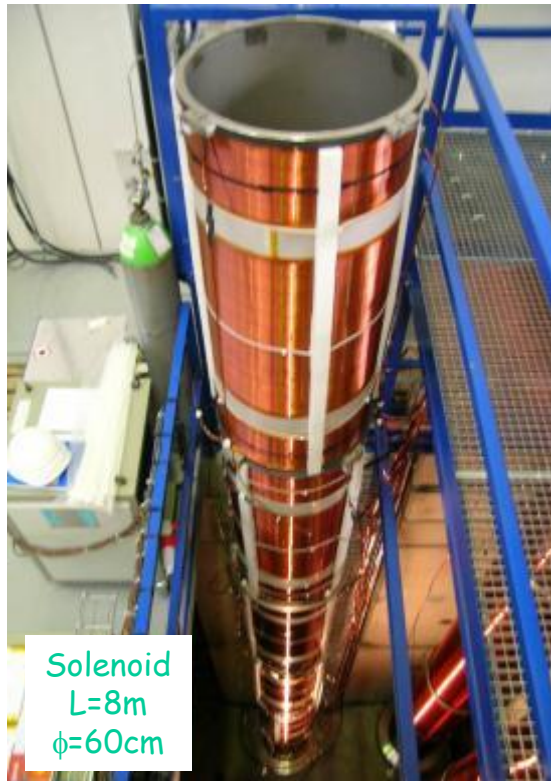

P. Costa Pinto, P. Chiggiato / Thin Solid Films 515 (2006) 382-388

Room Temperature Vacuum System

- and installed inside the LHC tunnel
- to bring the separated beams from the arcs into a single beam pipe for the experiments (held at room temperature !)

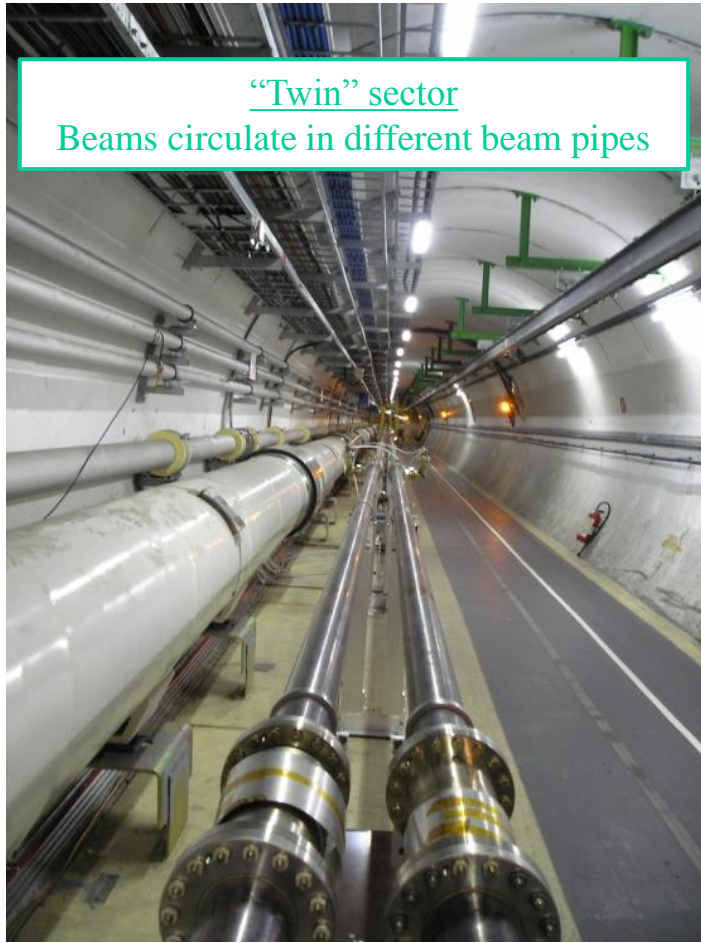

“Twin” sector
Beams circulate in different beam pipes

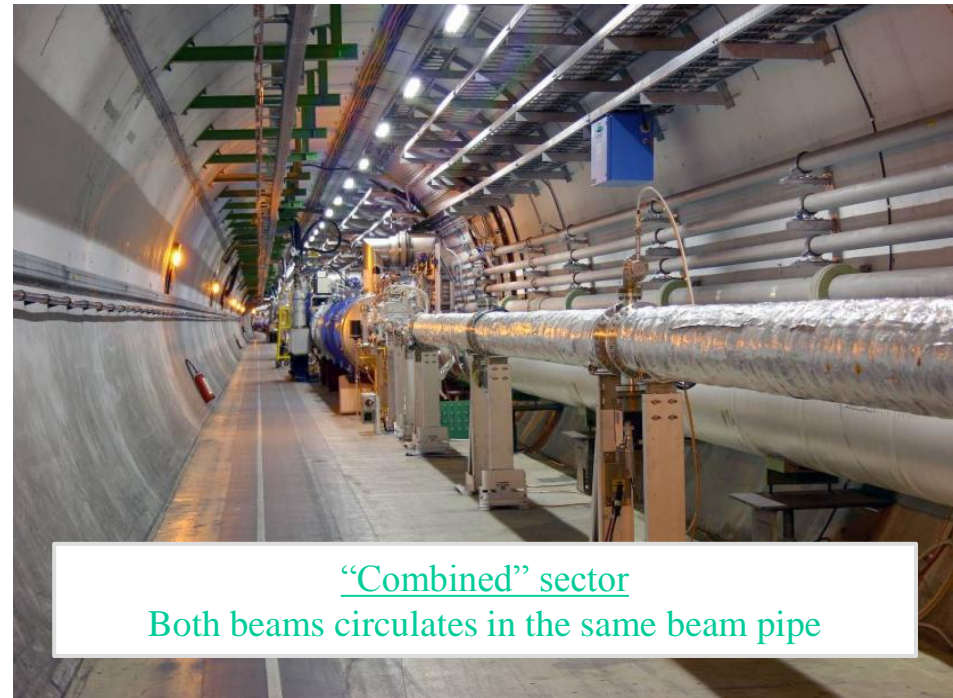

“Combined” sector
Both beams circulates in the same beam pipe

And of Course ... Through the LHC Experiments

CMS Ready to Close: Aug 2008

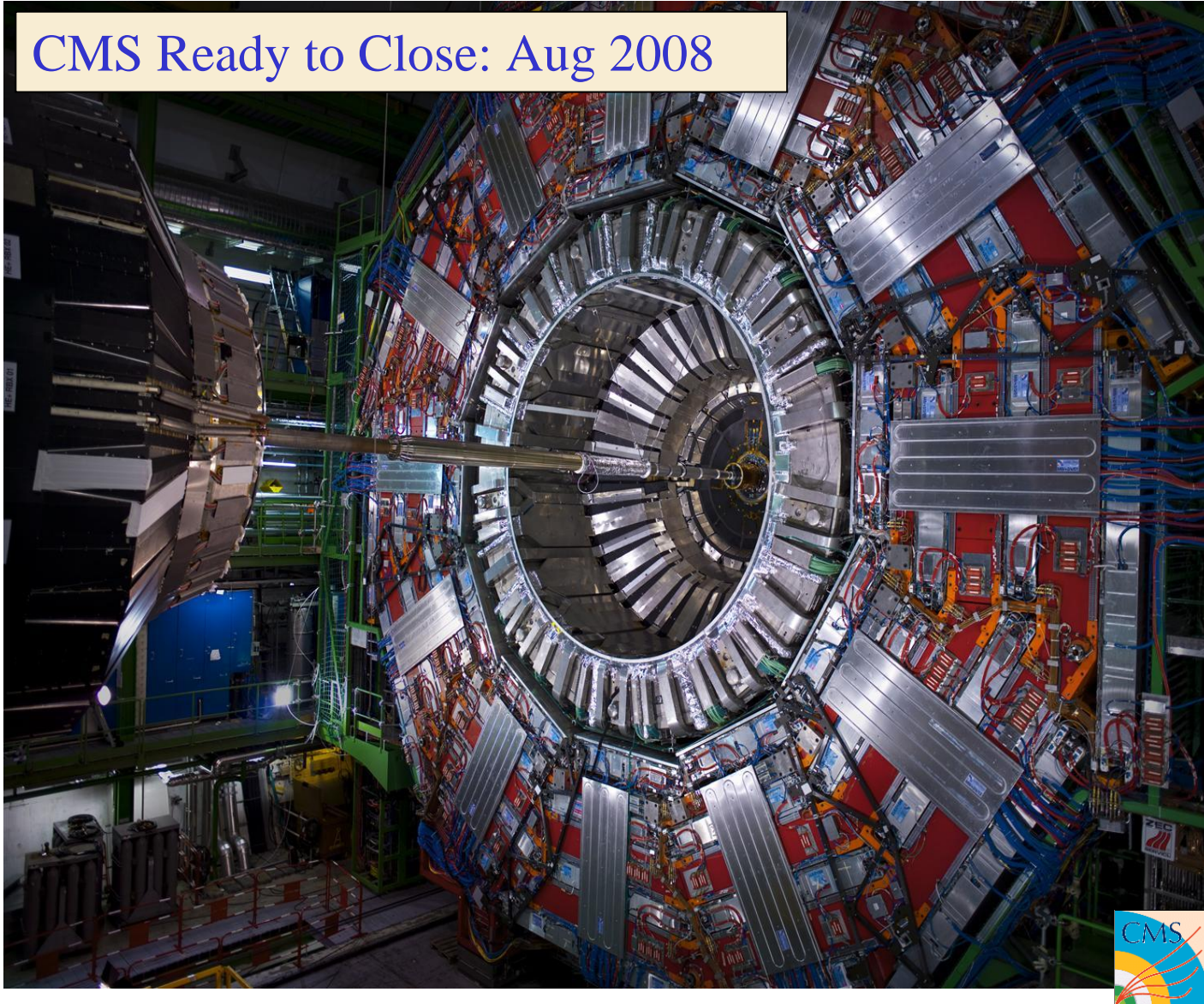

Beam Pipe Installation in ATLAS Before Closure



Non-Evaporable Getter (NEG)

- Getters are materials capable of chemically adsorbing gas molecules. To do so their surface must be clean. For Non-Evaporable Getters a clean surface is obtained by **heating to a temperature high enough** to dissolve the native oxide layer into the bulk.

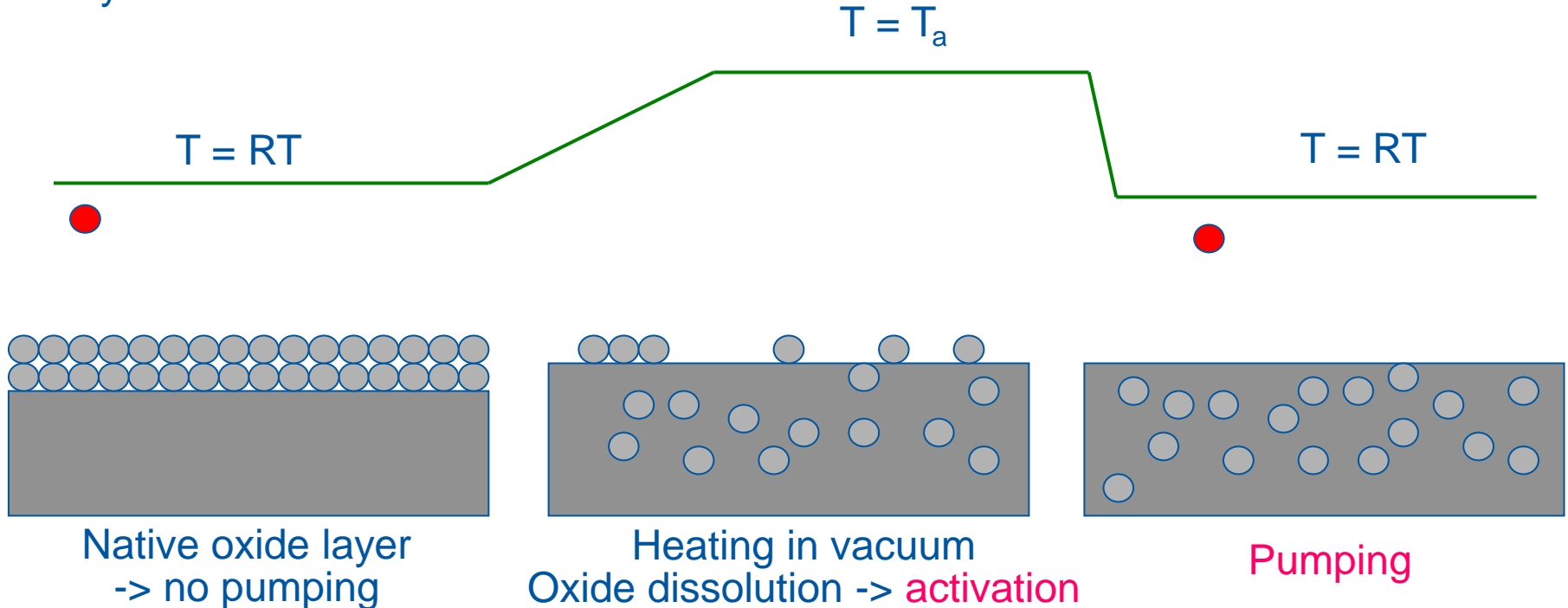

- NEGs pump most of the gas except rare gases and methane at room temperature

P. Chiggiato and P. Costa Pinto, Thin Solid Films, 515 (2006) 382-388

TiZrV Vacuum Performances

Pumping Speed

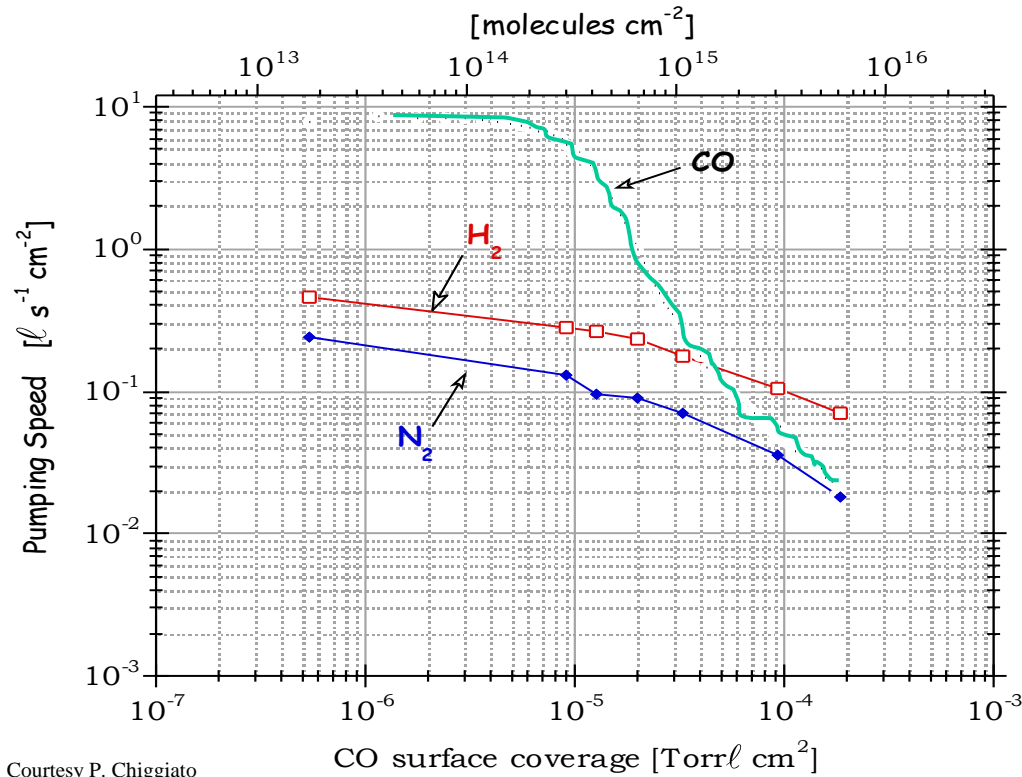

Courtesy P. Chiggiato

- Very large pumping speed : ~ 250 l/s/m for H₂, 20 000 l/s.m for CO
- Very low outgassing rate
- **But** : limited capacity and fragile coating sensitive to pollutant (hydrocarbons, Fluor ...)

Room Temperature Vacuum System : Static Pressure $< 10^{-11}$ mbar

Ultimate Vacuum Pressure Distribution after NEG Activation of the LHC Room Temperature Vacuum Sectors

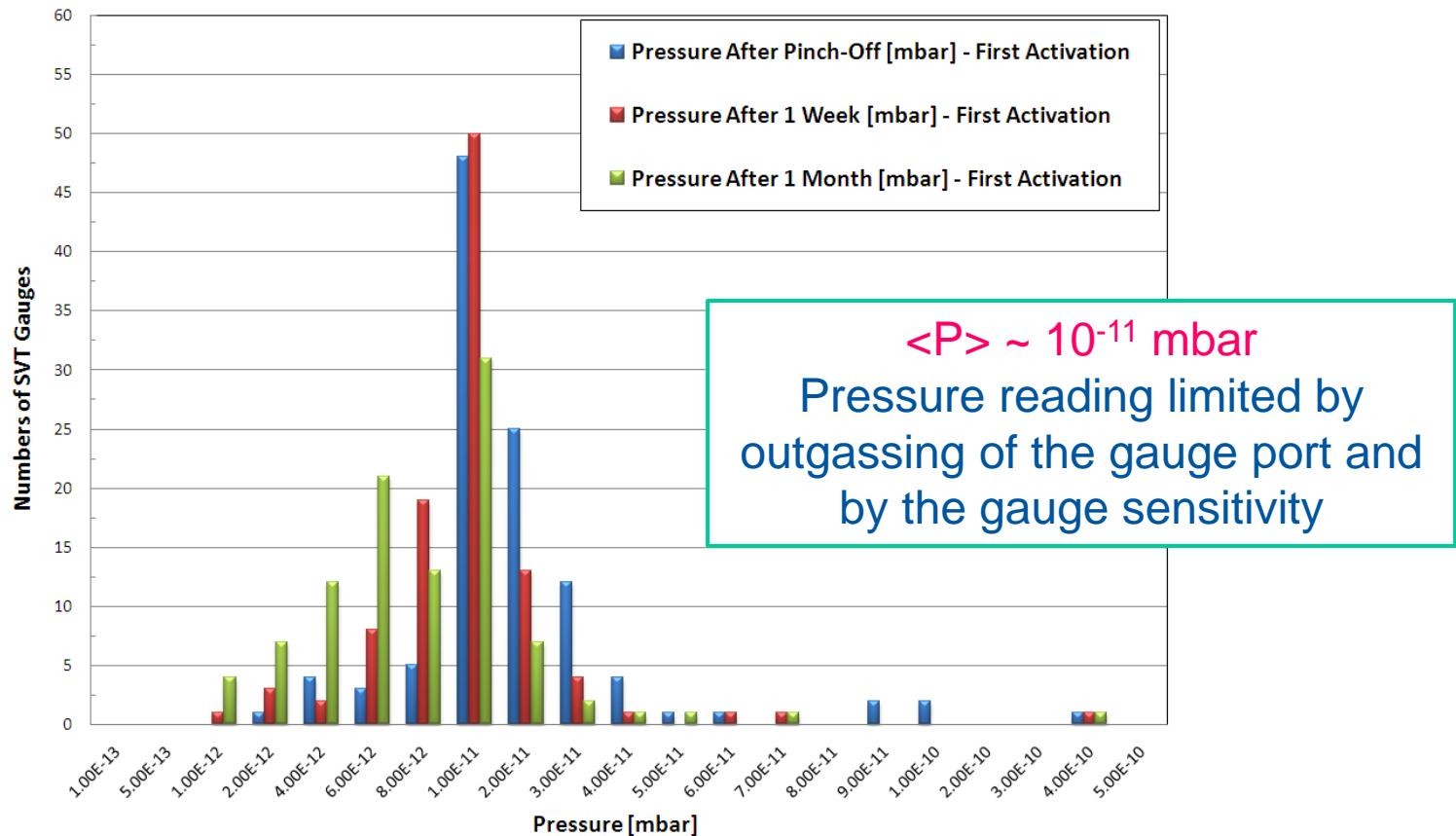

G. Bregliozzi *et al.* EPAC'08, Genoa 2008

TiZrV Vacuum Performances

- Very low stimulated desorption yield
- SEY $\sim 1.1 \Rightarrow$ very low multipacting
- **But** : limited capacity and fragile coating sensitive to pollutant (hydrocarbons, Fluor ...)

ESD Yields

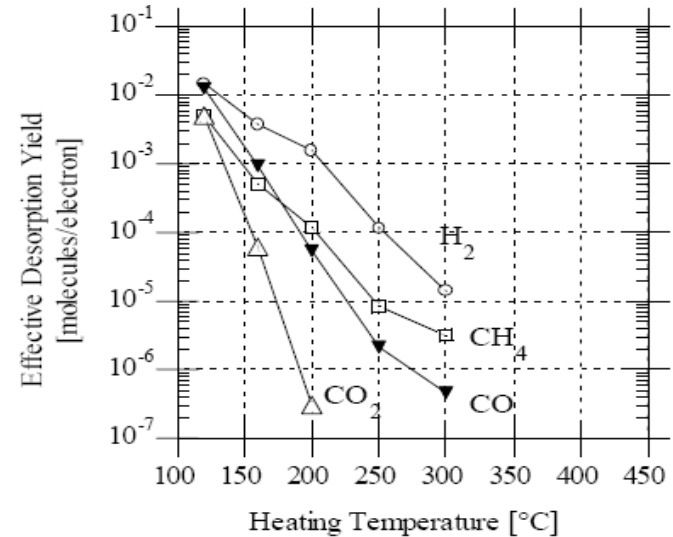

C. Benvenuti *et al.* J.Vac.Sci.Technol A 16(1) 1998

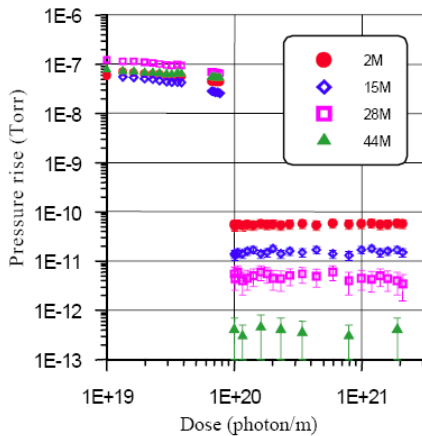

Figure 2: Pressure rise measured in the centre of the TiZrV coated test chamber before activation ($<1 \cdot 10^{20}$ photons/m) and after activation ($>1 \cdot 10^{20}$ photons/m).

PSD Yields

Table 2: Summary of results from the activated test chamber

| Gas | Sticking probability | Photodesorption yield (molecules/photon) |
|-----------------------------|----------------------|--|
| H_2 | ~ 0.007 | $\sim 1.5 \cdot 10^{-5}$ |
| CH_4 | 0 | $2 \cdot 10^{-7}$ |
| CO (28) | 0.5 | $< 1 \cdot 10^{-5}$ |
| C_xH_y (28) | 0 | $< 3 \cdot 10^{-8}$ |
| CO_2 | 0.5 | $< 2 \cdot 10^{-6}$ |

V. Anashin *et al.* EPAC 2002

Secondary Electron Yield

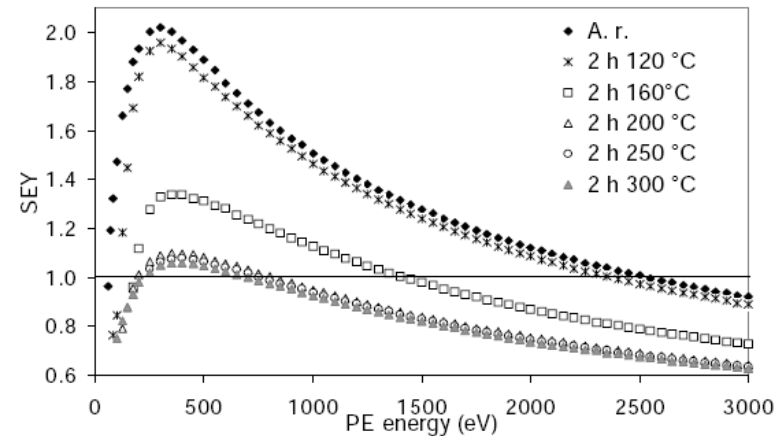

C. Scheuerlein *et al.* Appl.Surf.Sci 172(2001)

LHC Experimental Areas

- NEG coated vacuum system
=> Large pumping speeds, low SEY and desorption yields
- Almost constant pressure during the year
- $\langle P_{\text{LHC Experiments}} \rangle \sim 3 \cdot 10^{-11}$ mbar => within specifications

2012: LHC Experiments Average Pressure with Beam (IP only)

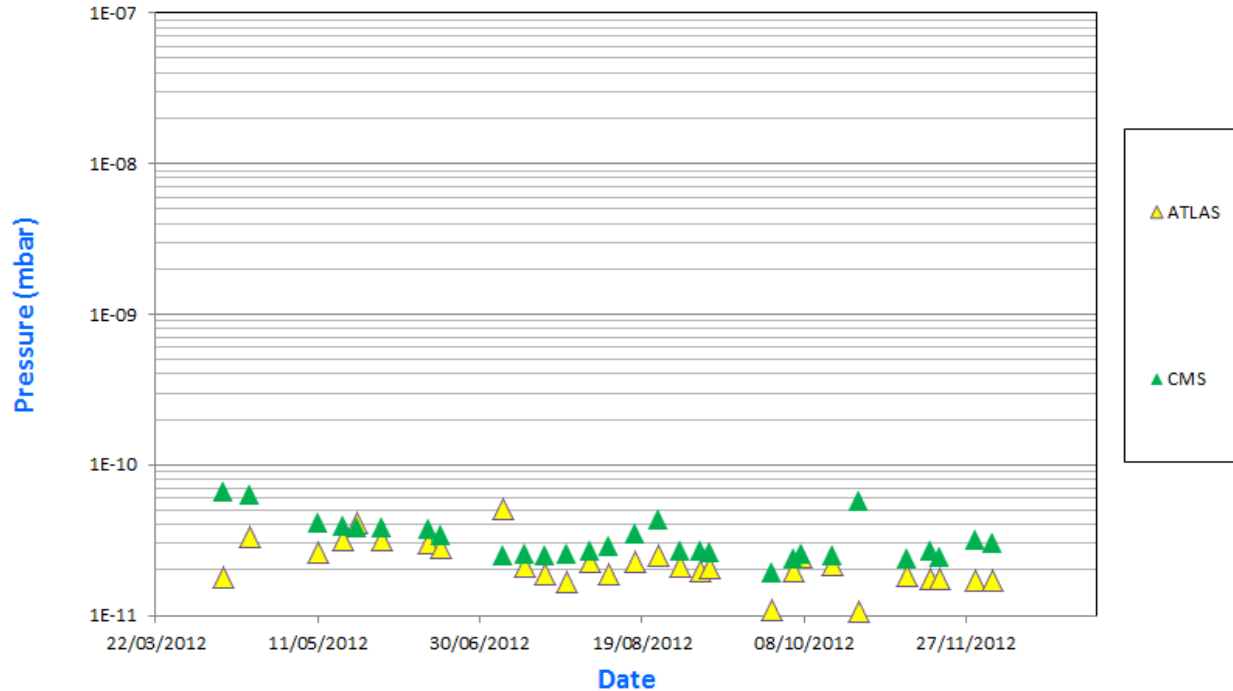

Conclusions

- The vacuum system is an **important** part of an accelerator machine
- Vacuum Physics / Engineering means:
 - definition of performances
 - understanding of physical phenomena *e.g.* particle-surface wall interactions :
 - computations
 - laboratory studies
 - development of new technologies *e.g.* beam screens, TiZrV coatings ..
 - design and production of complex components and systems
 - operation and upgrade of complex systems
- Many specialities are needed in this field and in particular **YOURS !**
- **Accelerators vacuum systems around the world need you as future experts !**

Some References

- Cern Accelerator School, Vacuum technology, CERN 99-05
- Cern Accelerator School, Vacuum in accelerators, CERN 2007-03
- The physical basis of ultra-high vacuum, P.A. Redhead, J.P. Hobson, E.V. Kornelsen. AVS.
- Scientific foundations of vacuum technique, S. Dushman, J.M Lafferty. J. Wiley & sons. Elsevier Science.
- Les calculs de la technique du vide, J. Delafosse, G. Mongodin, G.A. Boutry. Le vide.
- Vacuum Technology, A. Roth. Elsevier Science

Some Journals Related to Vacuum Technology

- Journal of vacuum science and technology
- Vacuum

Thank you for your attention !!!



