

# LHCb activities with DT2/CI involvement

Burkhard Schmidt

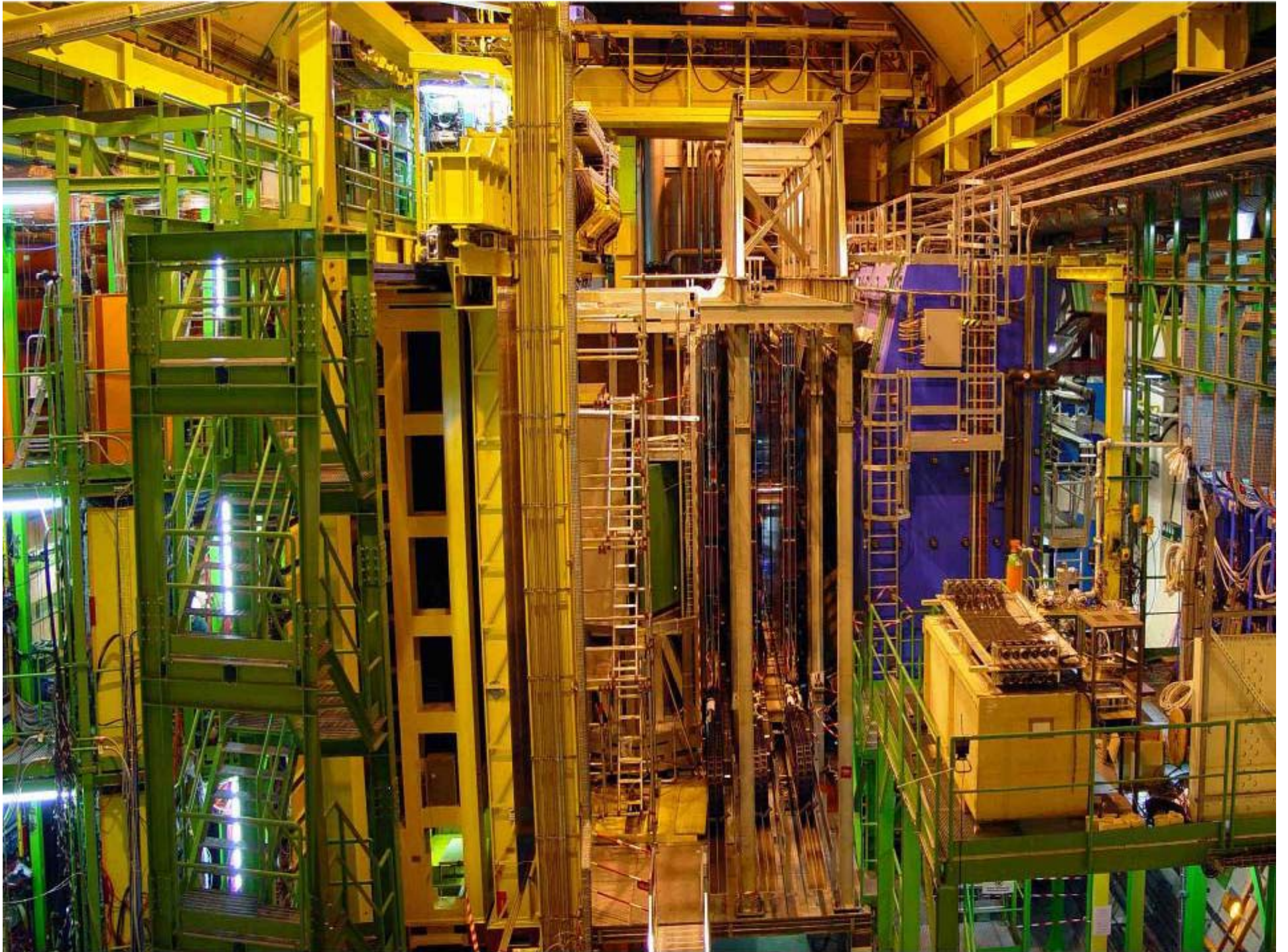



# VELO project

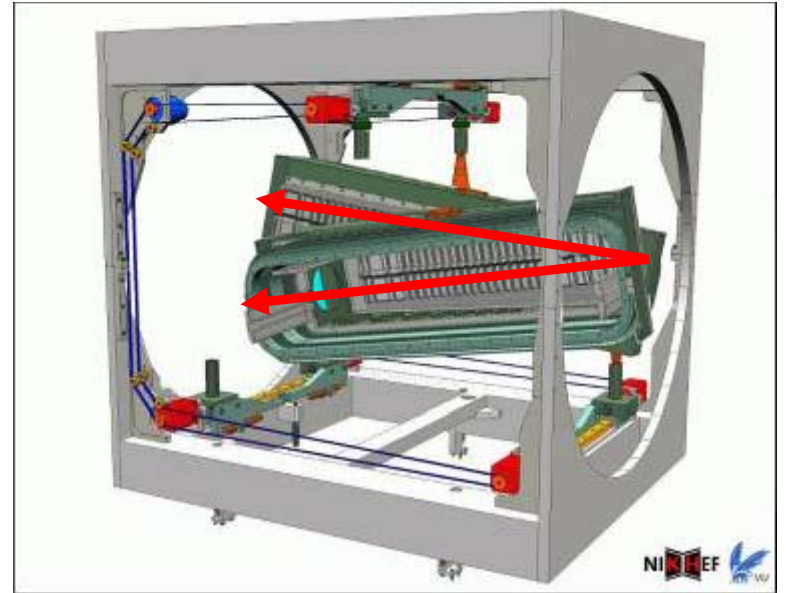
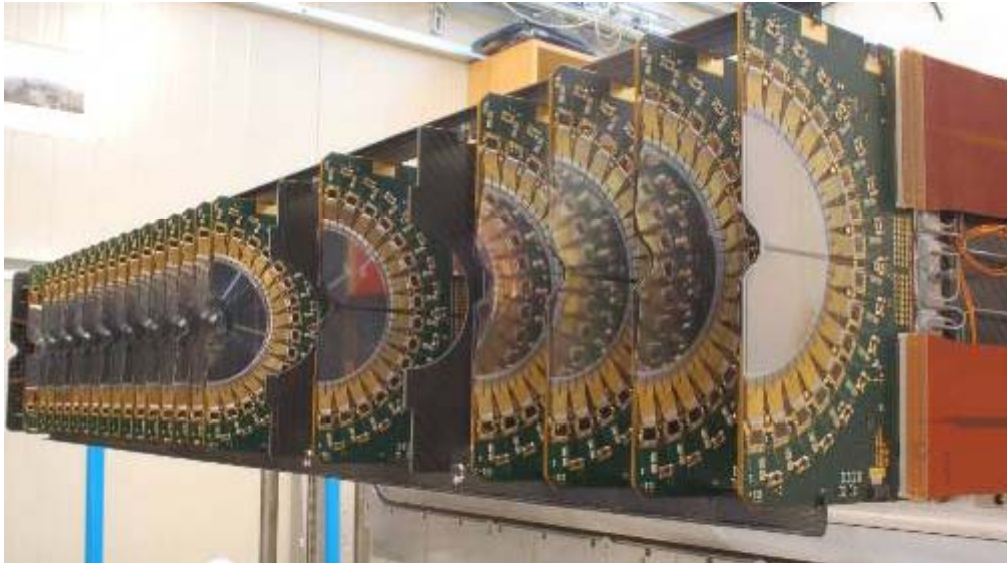



# VELO project



# RICH project

- Installation and commissioning of HPD columns





# HPD project

- HPDs have a very good quantum efficiency (QE)
- ALL 550 HPDs (484 + 66 spares) fully tested !

## HPD tests at PDTFs - Edinburgh & Glasgow

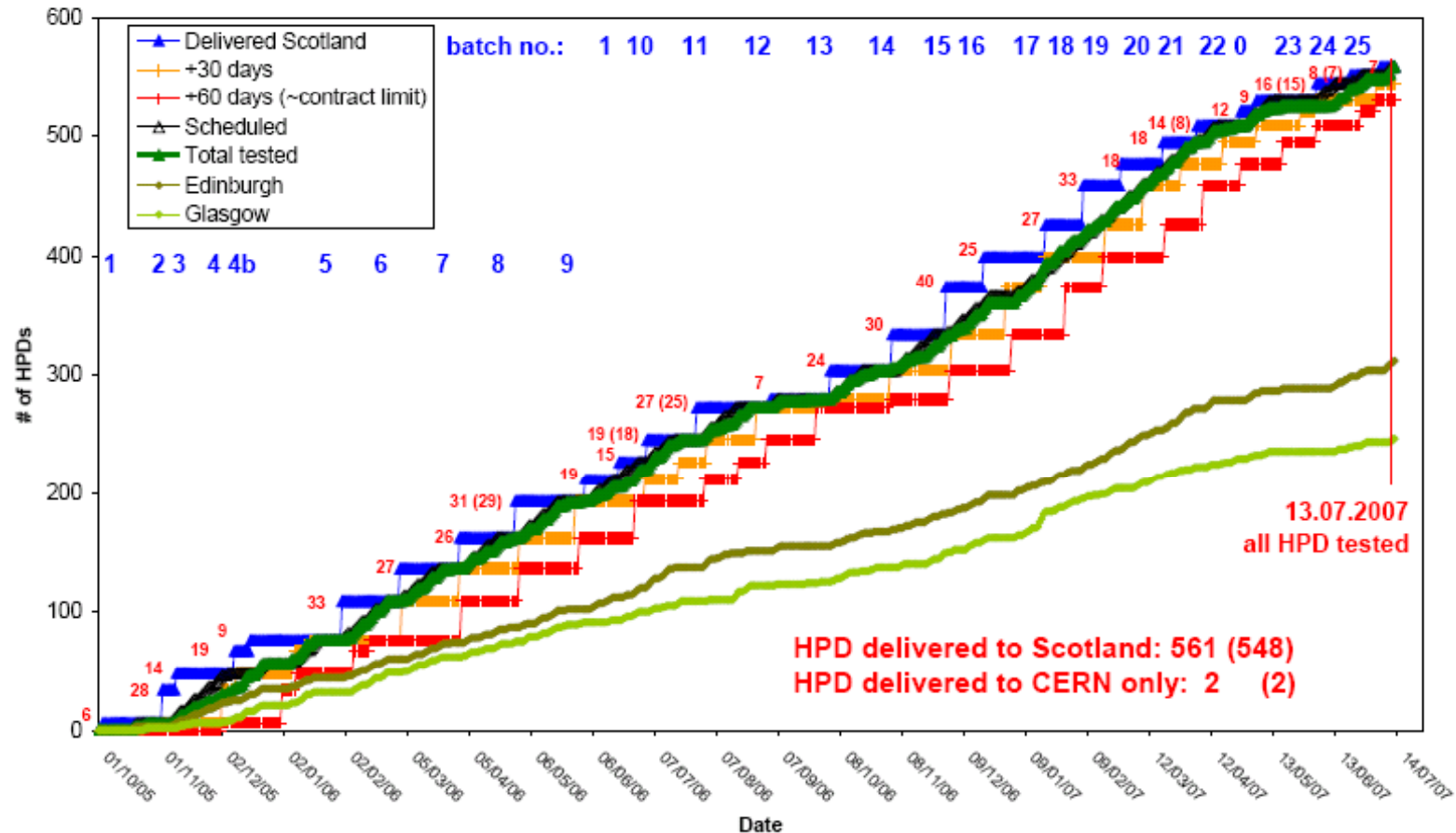

# RICH 2 commissioning

Run with pulsed laser on

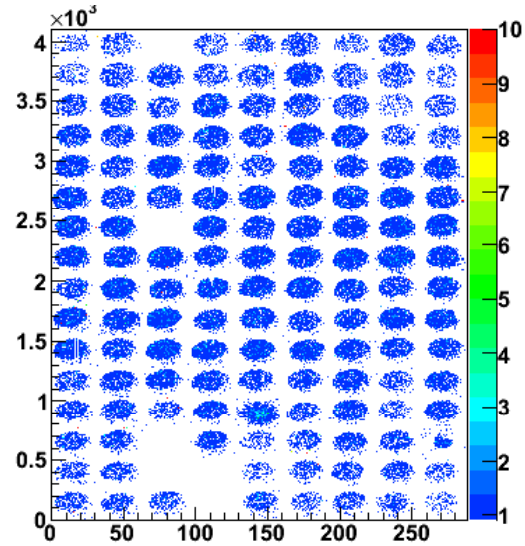
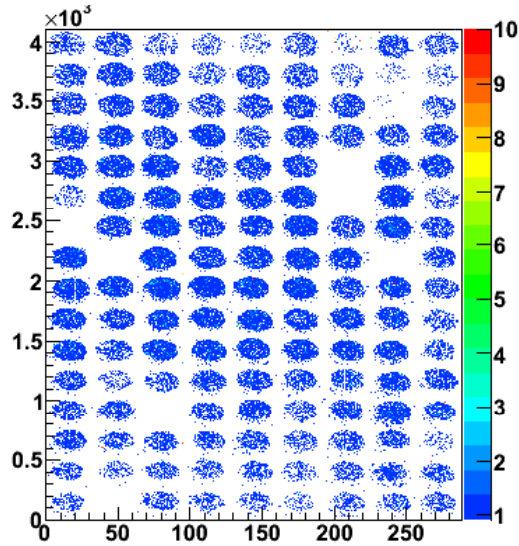

D/RichMonitor/ComMon/ALL-Inclusive

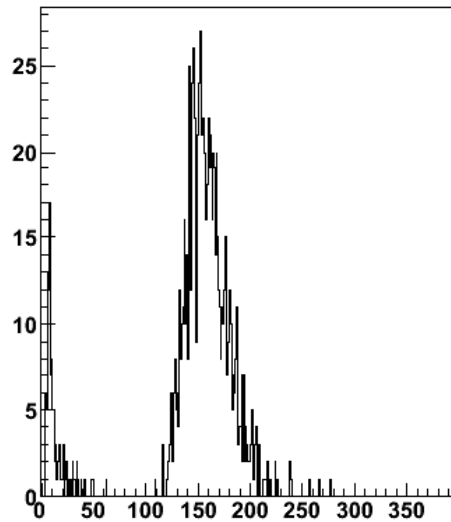

H1D/RichMonitor/ComMon/ALL-Trend

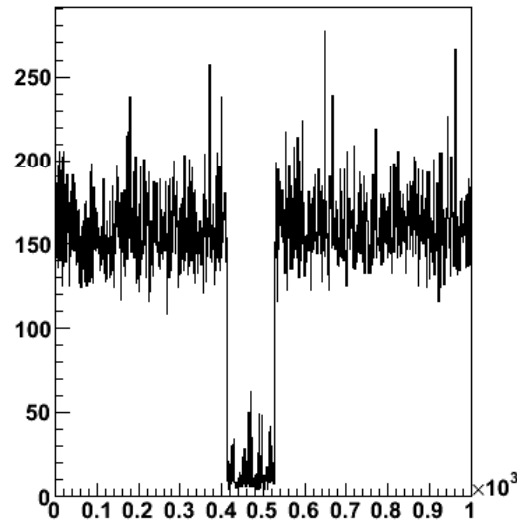

# RICH 1 project

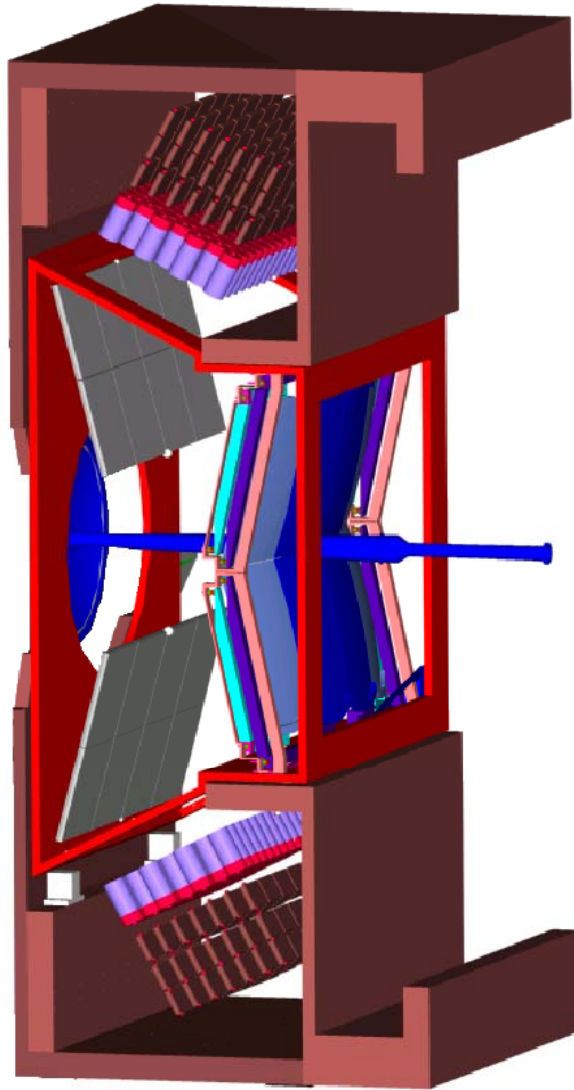

Mirrors



Columns





# Calorimeter project

Cable and cooling chains  
Moving of the Calo detectors





# Muon Project

- Chamber installation and alignment
- Cabling and HV system installation and commissioning





# Muon chamber Investigations

