

Overview of SLHC Experiment upgrades

High-Luminosity Upgrade kickoff – CERN 9 April 2008

Outline

- ▶ Upgrade Scenarios and Implications
- ▶ CMS Upgrade Requirements
- ▶ ATLAS Upgrade Requirements
- ▶ Upgrade Organization
- ▶ Upgrade R/D Projects

Prepared on behalf of ATLAS/CMS with help
from Nigel Hessey, and Steinar Stapnes

What integrated luminosity?

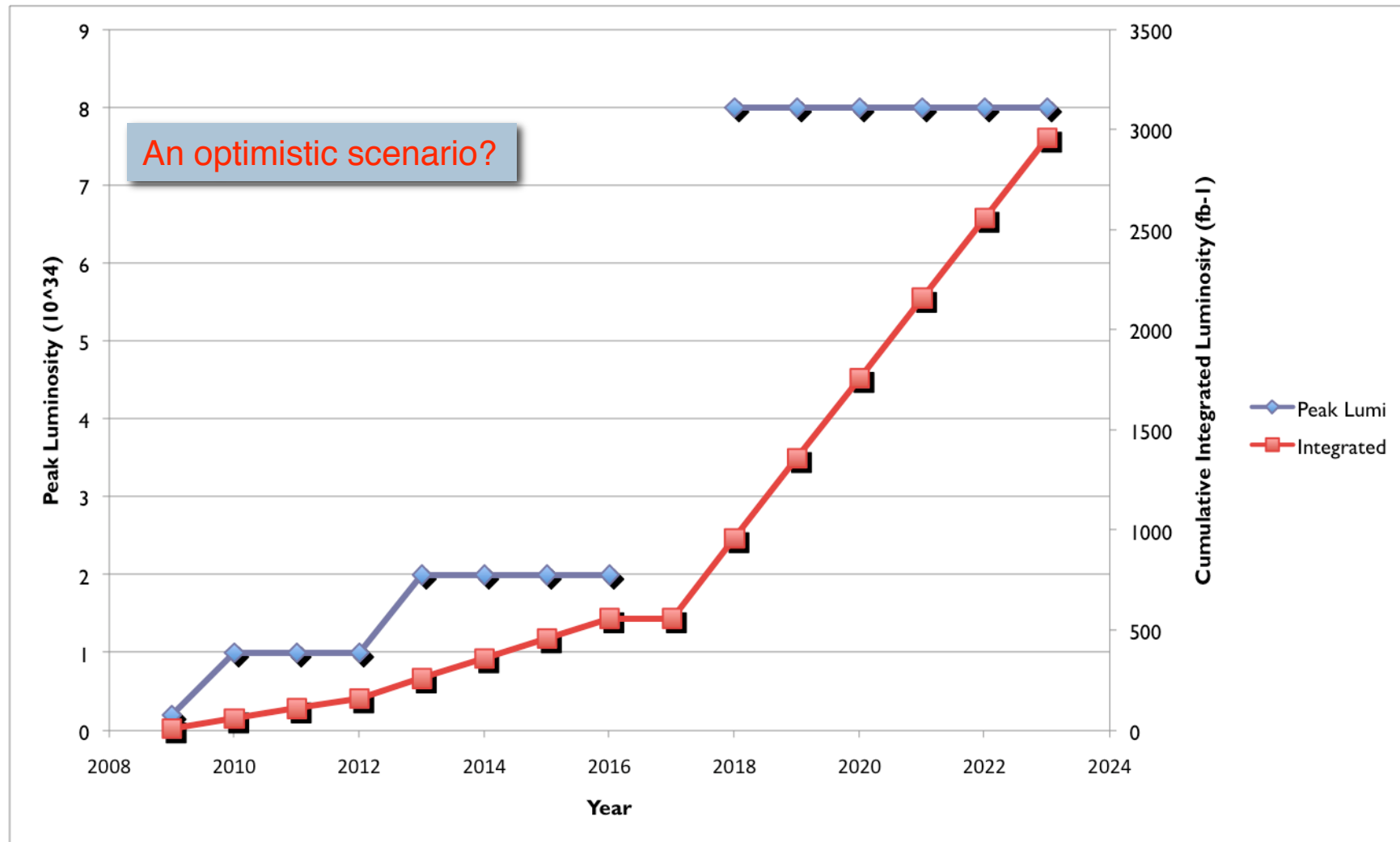

A more realistic scenario

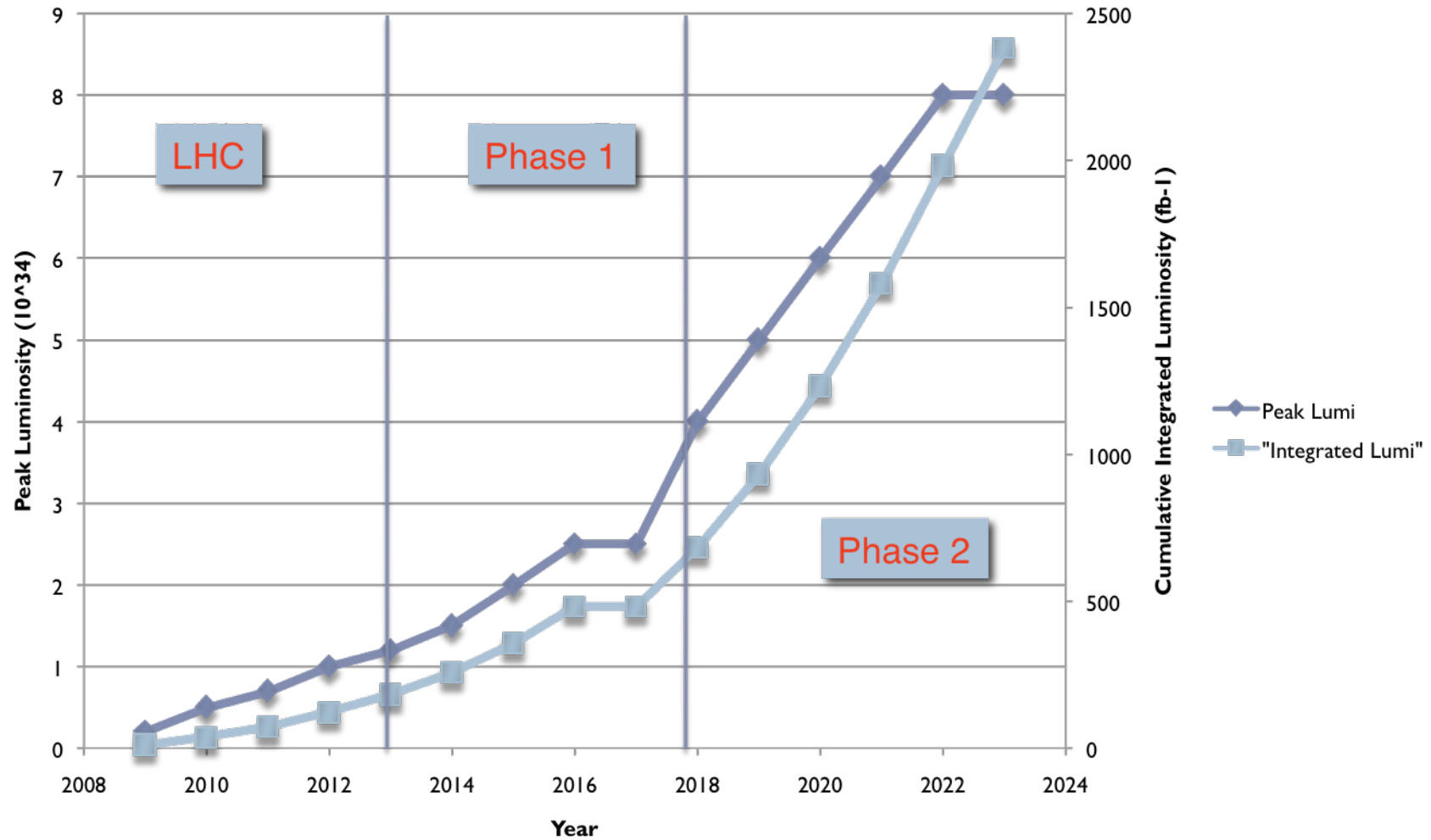

What are the key timescales/issues?

▶ Phase 1

- ▶ How well do detector components handle the increasing luminosity?
 - ▶ Both instantaneous and integrated effects
- ▶ What detector elements will need replacement/modification to cope?
 - ▶ Detectors will record 500 fb^{-1} , can they withstand this?

▶ Phase 2

- ▶ What detector elements will need replacement?
- ▶ Is there a requirement for a long shutdown?
 - ▶ How long – 18 Months? (1 Full calendar year without beam +)
 - ▶ When – sometime after the middle of the next decade
 - Building new tracking detectors will take many years
 - ▶ ATLAS/CMS must agree the dates
 - No sense in having two long shutdowns
 - Current planning
 - ATLAS earliest date around 2015, CMS not earlier than 2017

Conditions in Phase 2

- ▶ BX is 50ns or 25 ns
- ▶ Pile-up can be up to 400 events per crossing
- ▶ Physics will determine what are the detector requirements
 - ▶ Many of the physics goals demand detector performance at least as good as at the LHC
 - ▶ Very demanding to get this performance with so much pileup
 - ▶ Might require good jet tagging performance in the forward region (looking for WW scattering)
 - ▶ Will need tracking/triggering on High Pt leptons
- ▶ Will there be changes to the IR?

CMS from LHC to SLHC

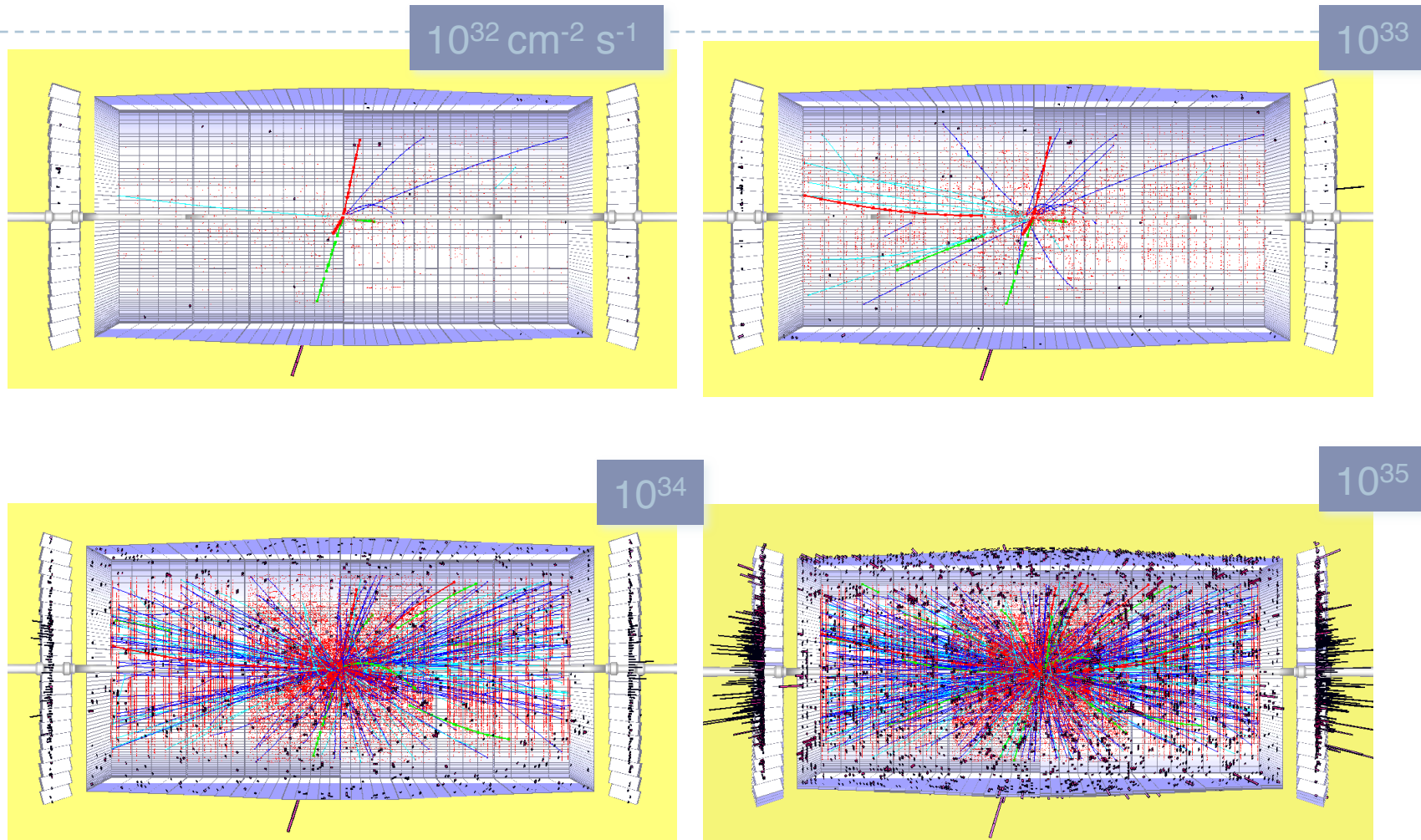

The tracker is the key detector which will require upgrading for SLHC Phase 2

I. Osborne

CMS - What stays, what goes...

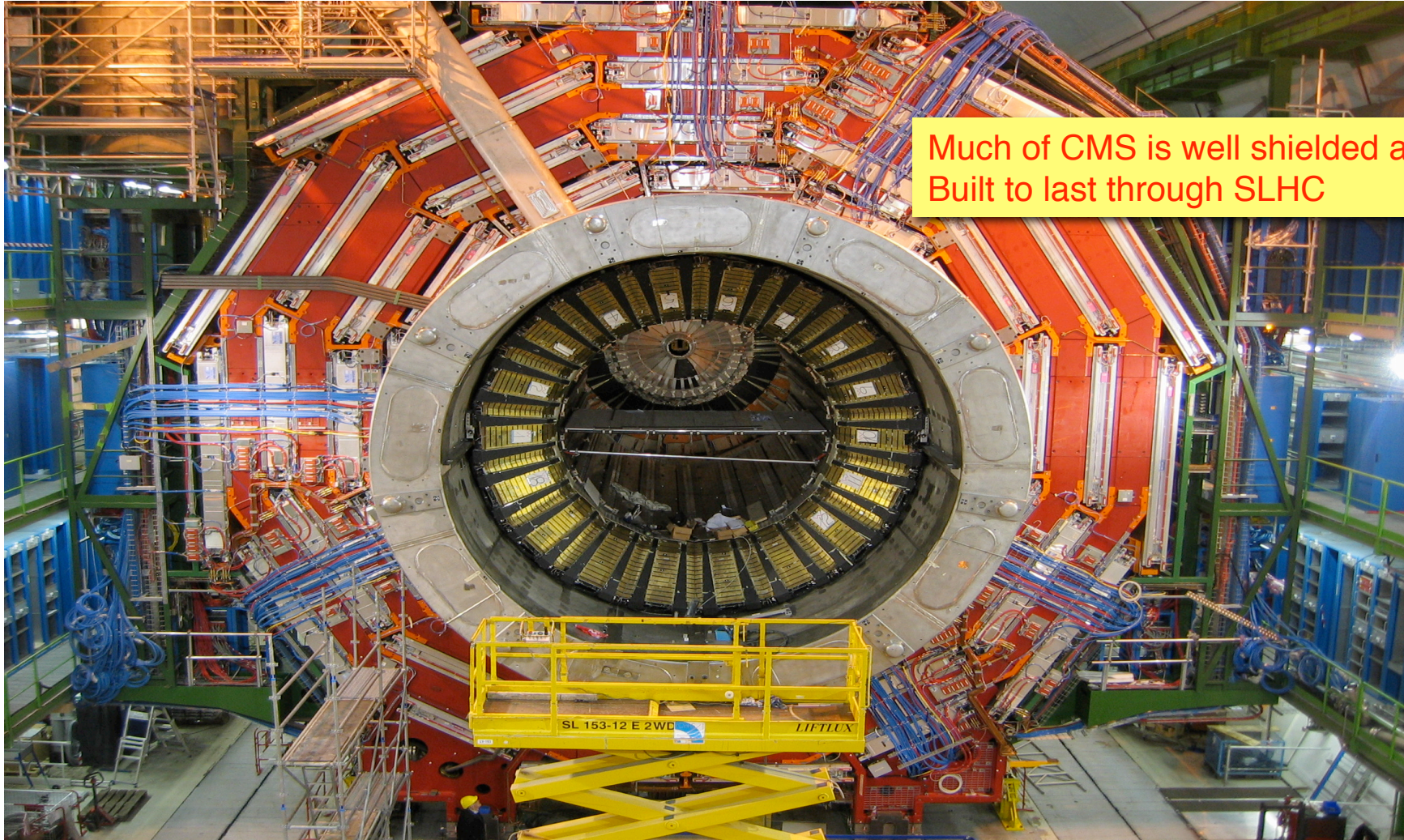

Much of CMS is well shielded and Built to last through SLHC

Reminder what CMS will need to upgrade

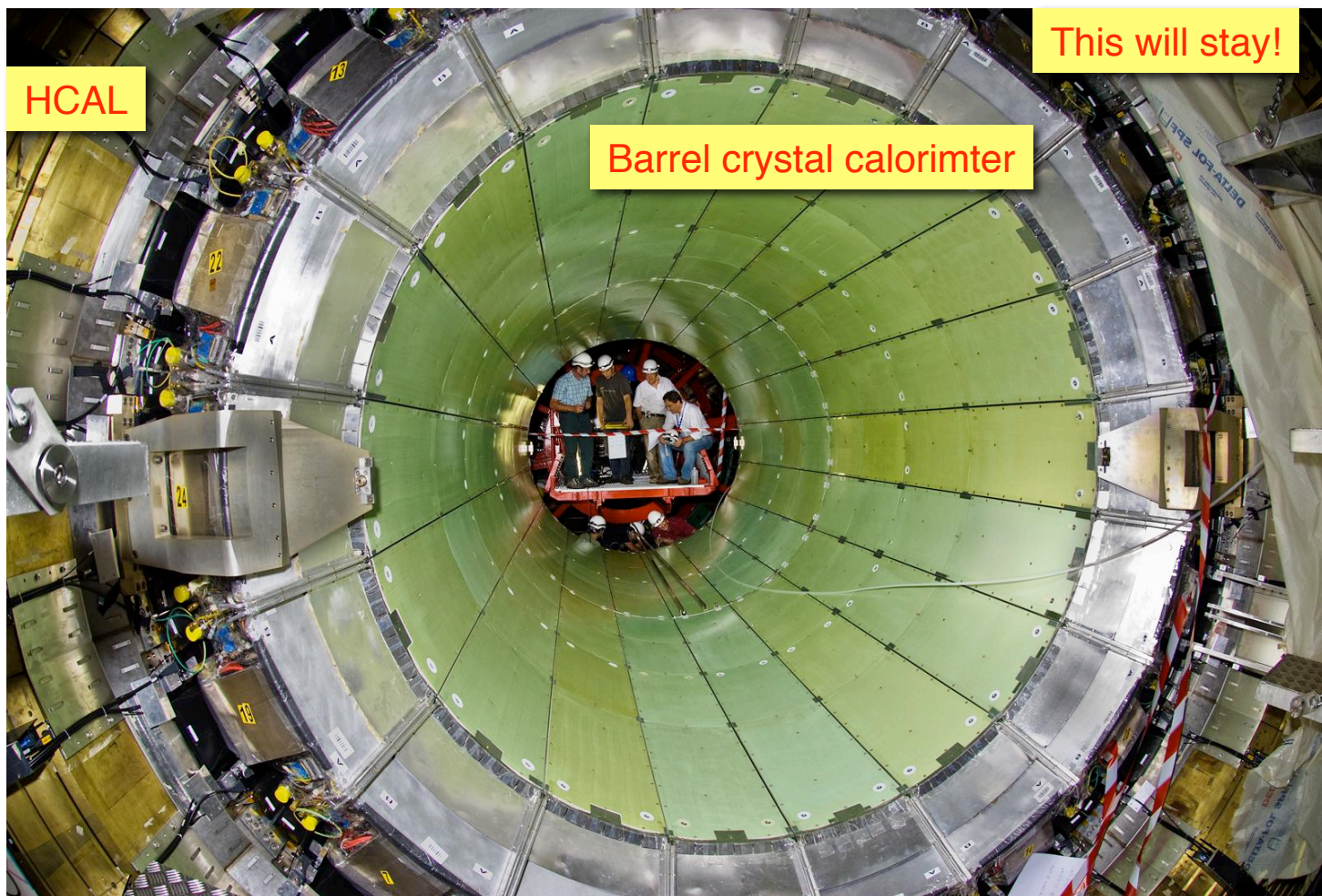

Tracker Readied for Transport to Pt5

This will be replaced

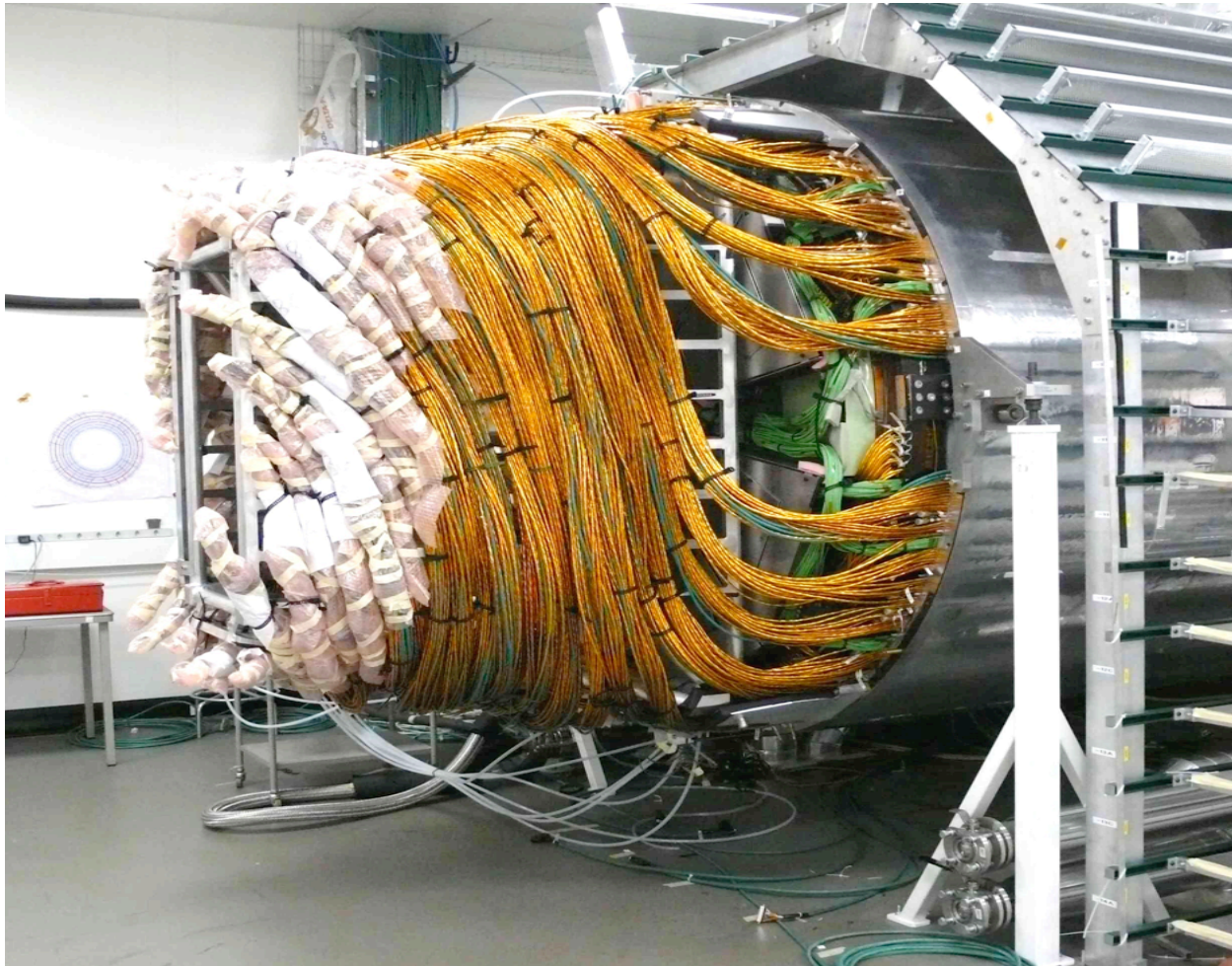

Key issues for tracker upgrades

- ▶ Power
 - ▶ How to get current needed to the electronics
 - ▶ More complicated front ends, more channels may want more power
 - ▶ DC-DC converters, Serial powering
- ▶ Material Budget
 - ▶ Can we build a better/lighter tracker?

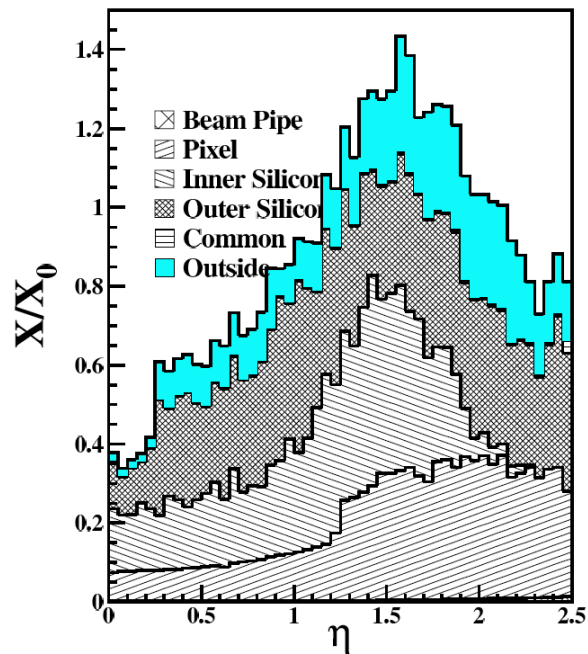

Tracker R&D focus

- Performance and detector layout
- Sensor material and operation
- Outer tracker readout system definition
- Pixel system and triggering
- Manufacture and material budget

From Physics TDR Vol 1 (LHCC 2006-001)

Radiation environment for trackers

Except for the very innermost layers current technologies should survive SLHC

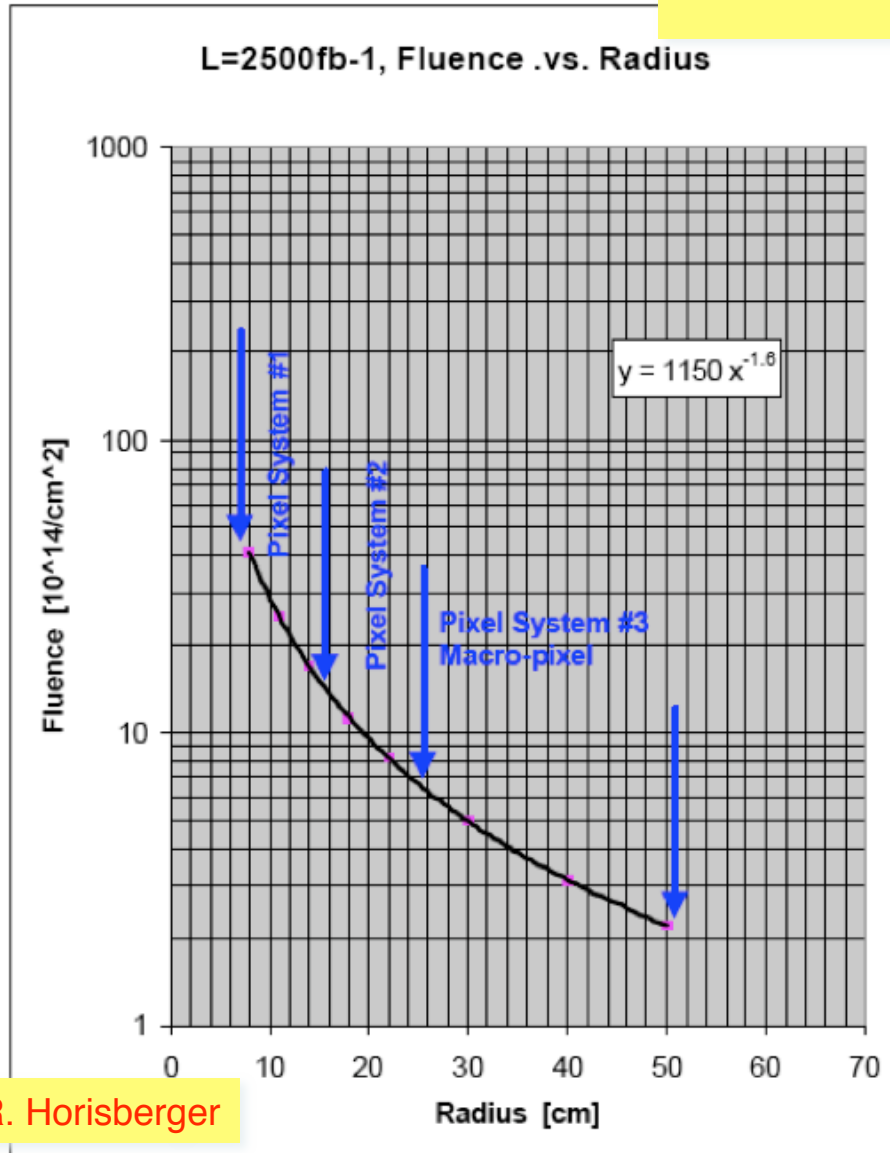

R. Horisberger

Radiation Dose in Inner Detectors

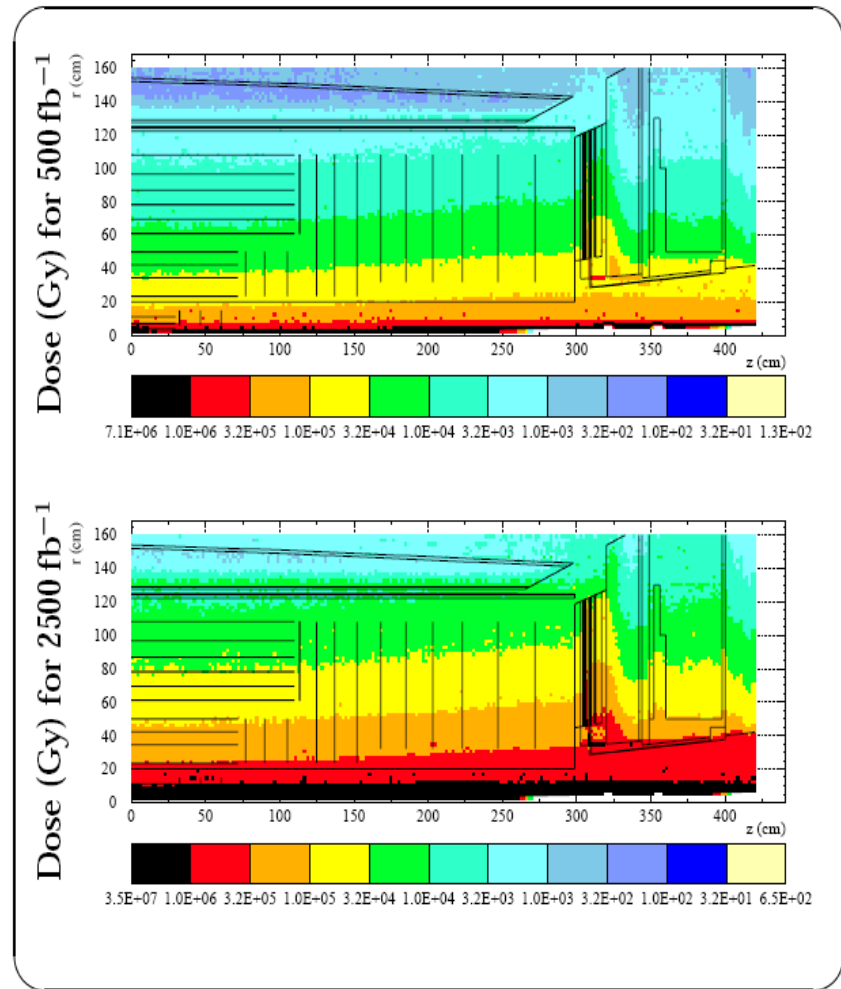

M. Huhtinen

SLHC Electronics Workshop 26 February 2004

3

The effect on physics of large pile-up

- ▶ We need to evaluate how well we can extract any physics at all in the presence of up to 400 pile-up events per crossing
- ▶ This is not a trivial study
 - ▶ Technically difficult
 - ▶ Also depends on geometry of a new tracking device
 - ▶ Timescale for full answers is more like years than months

Tracking with 500 min Bias events

- ▶ Study of current CMS tracker for Heavy Ion events
- ▶ Track density very similar to 50ns running
 - ▶ $dn^{ch}/d\eta/\text{crossing} \approx 3000$
 - ▶ Tracker occupancy very high
 - ▶ Need more pixel layers/shorter strips
- ▶ Tracking possible
 - ▶ When tracks are found they are well measured
 - ▶ Efficiency and fake rate suffer
 - ▶ CPU Intensive

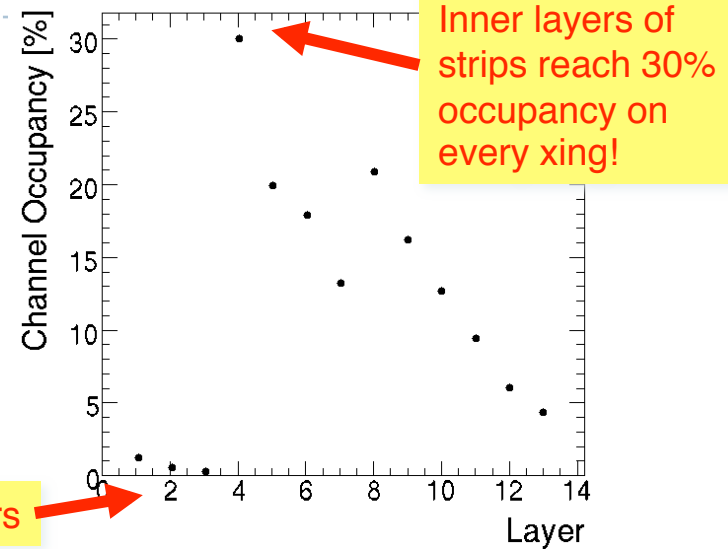

Momentum Resolution

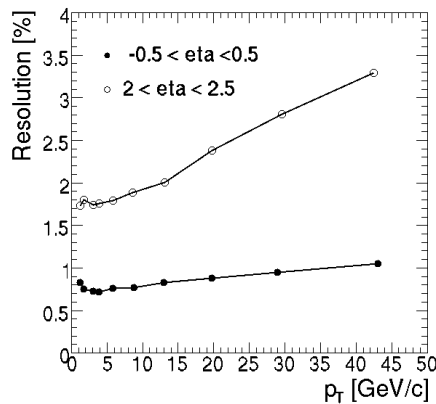

Transverse Impact Parameter Resolution

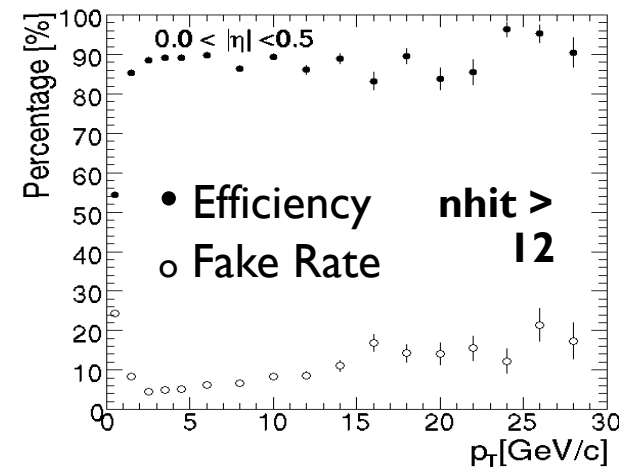
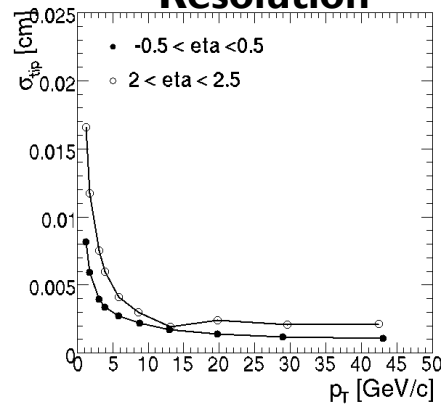

Level 1 Trigger

- ▶ The trigger/daq system of CMS will require an upgrade to cope with the higher occupancies and data rates at SLHC
- ▶ One of the key issues for CMS is the requirement to include some element of tracking in the Level 1 Trigger
 - ▶ There may not be enough rejection power using the muon and calorimeter triggers to handle the higher luminosity conditions at SLHC
- ▶ Adding tracking information at Level 1 gives the ability to adjust P_T thresholds
- ▶ Single electron trigger rate
 - ▶ *Isolation criteria are insufficient to reduce rate at $L = 10^{35} \text{ cm}^{-2} \cdot \text{s}^{-1}$*

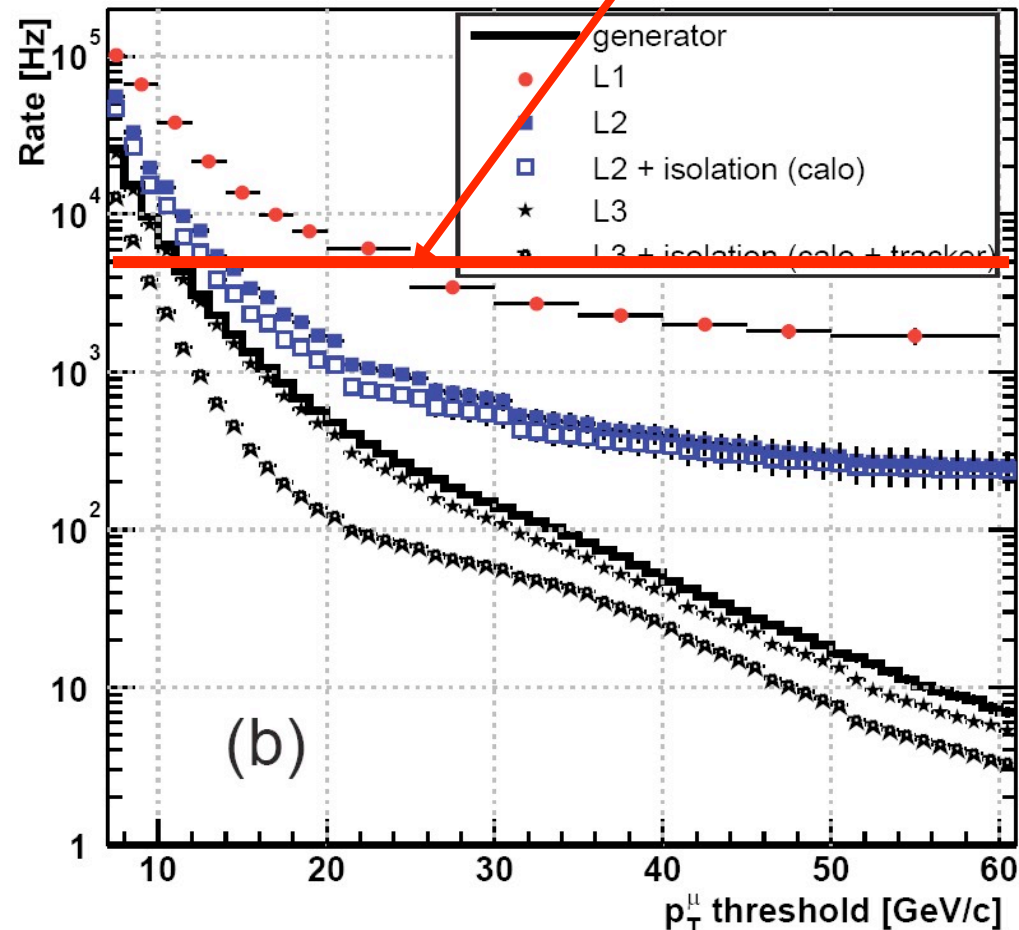

Concepts: Tracking Trigger

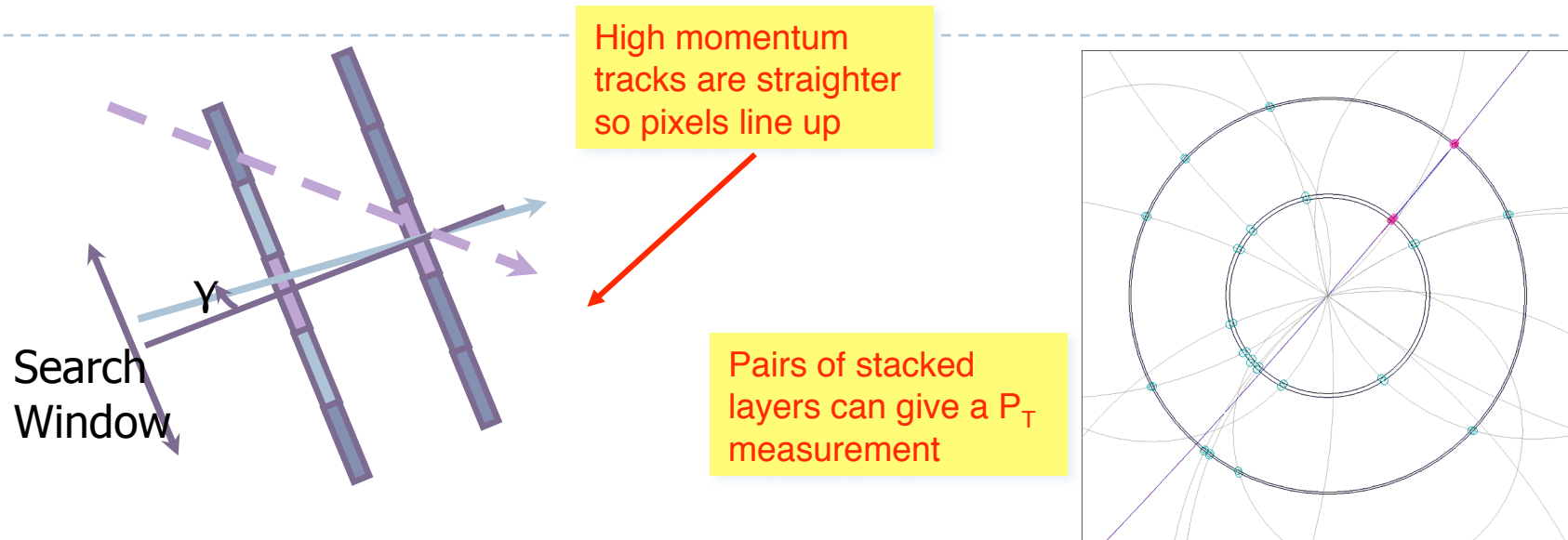

Geometrical p_T -cut - [J. Jones](#), [A. Rose](#), [C. Foudas](#) LECC 2005

- ▶ Why not use the inner tracking devices in the trigger?
 - ▶ Number of hits in tracking devices on each trigger is enormous
 - ▶ Impossible to get all the data out in order to form a trigger inside
 - ▶ How to correlate information internally in order to form segments?
- ▶ Topic requiring substantial R&D
 - ▶ “Stacked” layers which can measure p_T of track segments locally
 - ▶ Two layers about 1mm apart that could communicate
 - ▶ Cluster width may also be a handle

CMS HCALS

Had Barrel: HB
 Had Endcaps: HE
 Had Forward: HF

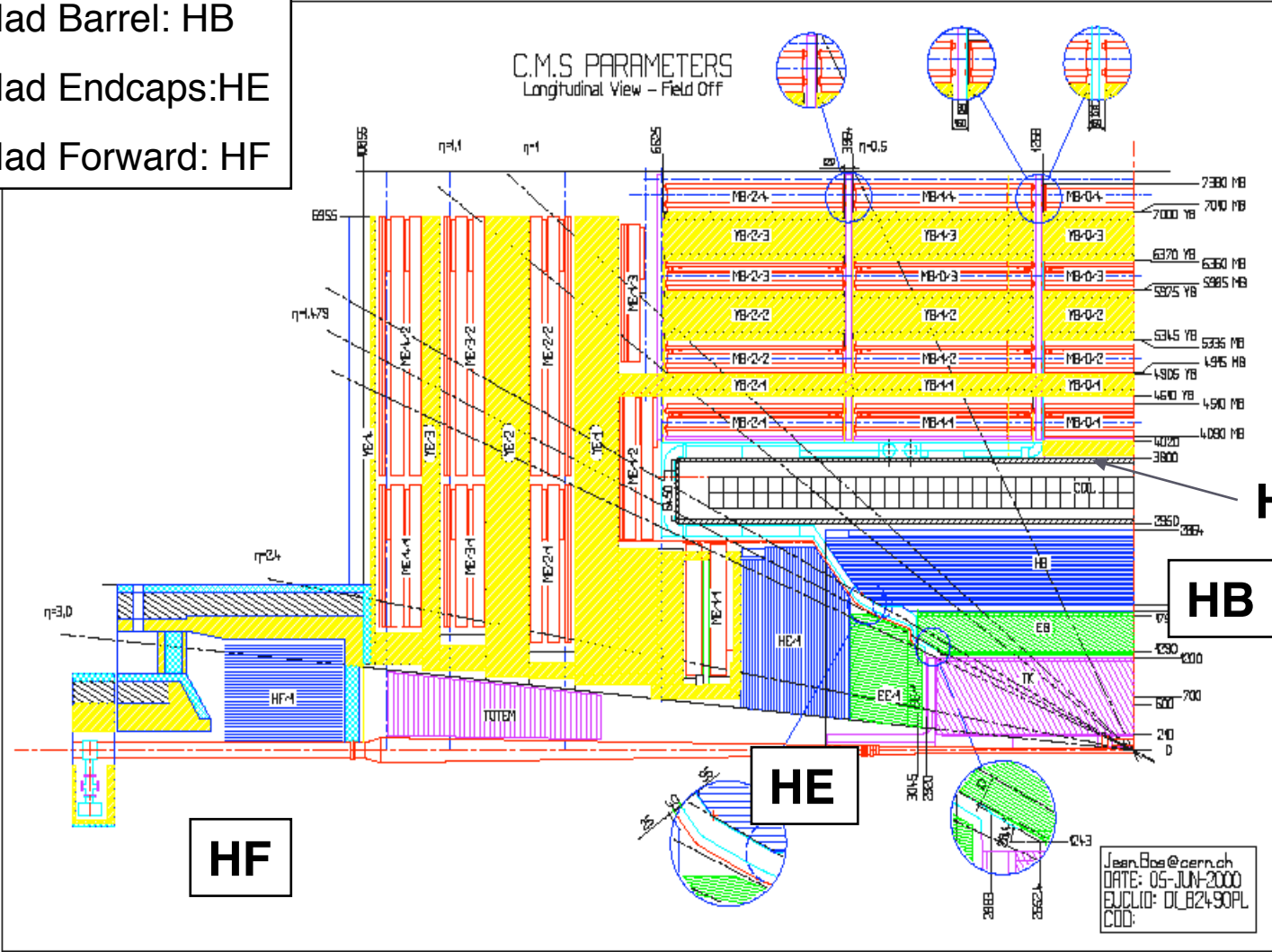

HF Damage

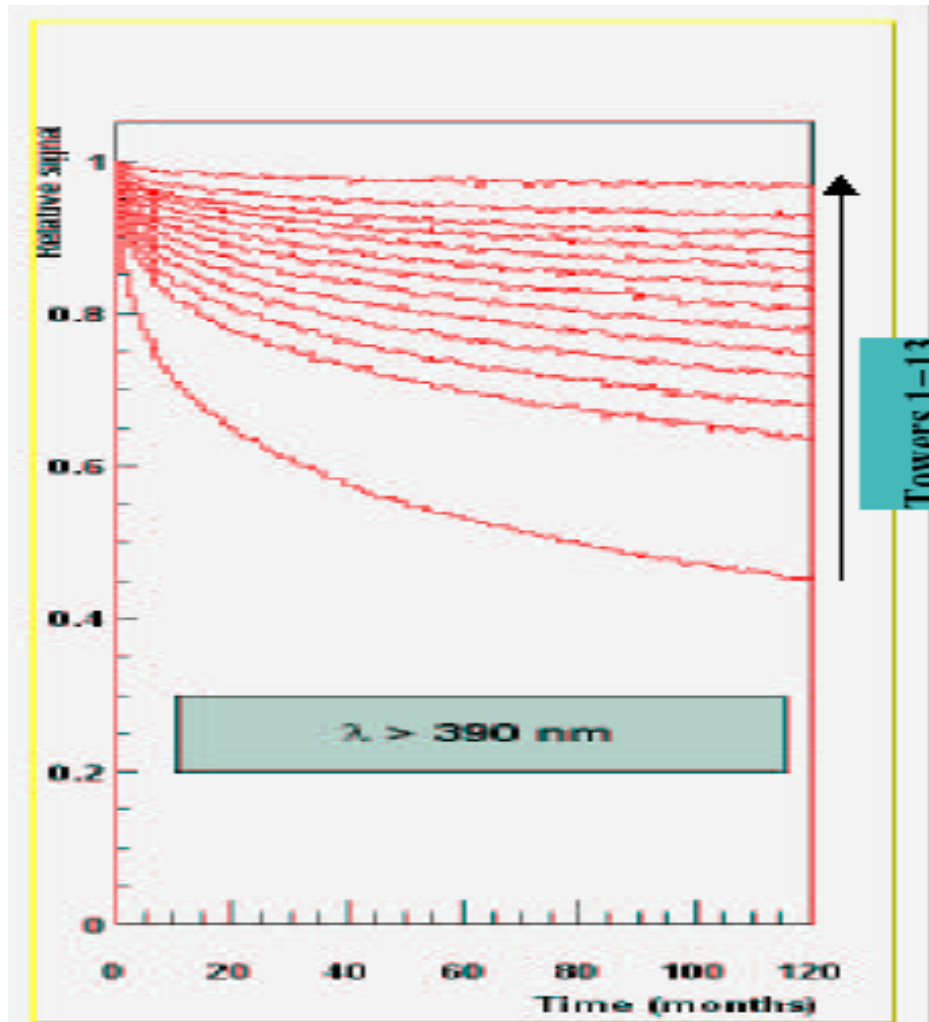

- Tower 1 loses 60% of light during LHC, down to 4% of original after SLHC.
- Tower 2 down to 23% after SLHC.
- SLHC “kills” a few high eta towers.

Andre Gribushin

Calorimeters / Muons

▶ ECAL

- ▶ Crystal calorimeter electronics designed to operate in SLHC conditions
- ▶ VPT in Endcap and Endcap crystals themselves may darken at SLHC
 - ▶ Very difficult to replace

▶ HCAL

- ▶ HF may be blocked by potential changes to the interaction region
- ▶ This has a direct impact mainly in the case of looking for WW scattering

▶ Both Calorimeters suffer degraded resolution at SLHC

- ▶ affects electron ID, Jet resolutions

• MUON

- system front end electronics look fairly robust at SLHC
 - Cathode Strip Chambers/RPC Forward : Drift Tubes /RPC Barrel

• Trigger electronics for the muon systems would most likely need to be replaced/updated

- Some Electronics is “less” radiation hard (FPGA)
- Coping with higher rate/different bunch crossing frequency
- May have to limit coverage in η ($\eta > 2$) due to radiation splash

- This effect will be known better after first data taking, potential additional cost of

chamber replacement

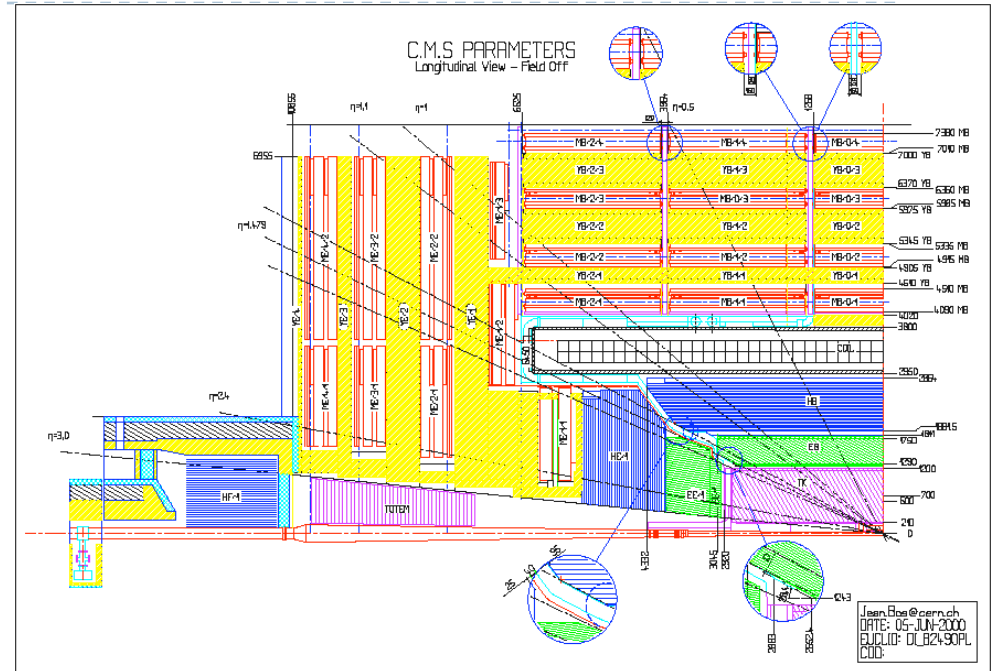

Infrastructure modifications: Yoke

- Reinforced Shielding inside forward muons:

- up to $\eta \sim 2$
- automatically implies replacement of inner CSC, RPC

- Supplement YE4 wall with borated polythene

- Improve shielding of HF PMT's

- possibility of increased YE1-YE2 separation to insert another detector layer?

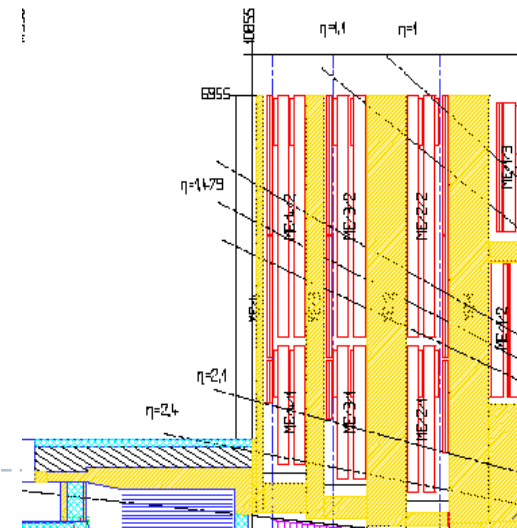
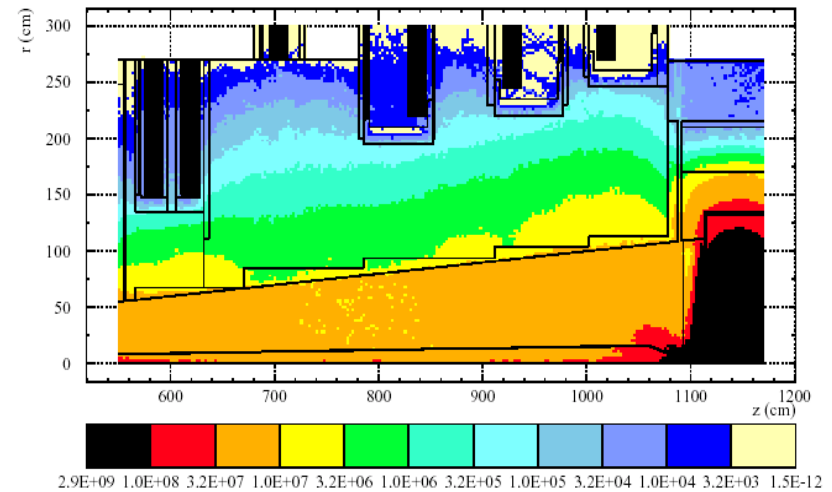

CMS May Upgrade Workshop

- ▶ The primary goals of the workshop will be
 - ▶ 1) To present the progress and plans of the approved R&D proposals on upgrades,
 - ▶ 2) To report on progress in sub-detectors on upgrade activities,
 - ▶ 3) To discuss issues involved in preparing for possible 'Phase I' upgrades of CMS
 - ▶ What components of the detector could/should we aim to replace during Phase I
 - Look at each system and see what options are
 - e.g. Pixel/HCAL/Trigger/Endcap Muons/...
 - Entire tracker impossible on this timescale, Pixel replacement may be possible
 - ▶ 4) To discuss and prepare Milestones for the upgrade project.

Discussions on Phase 1/2 Upgrades



Towards Strawman 0: Pixel Barrel

Example of studies required to understand different upgrade scenarios

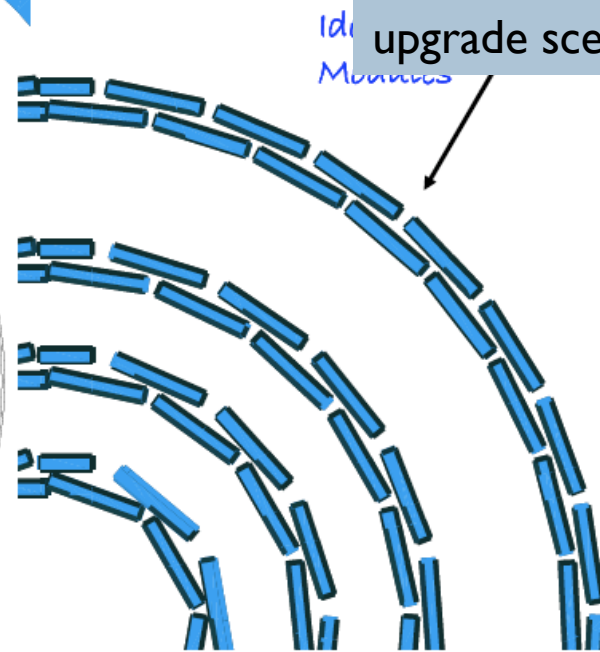
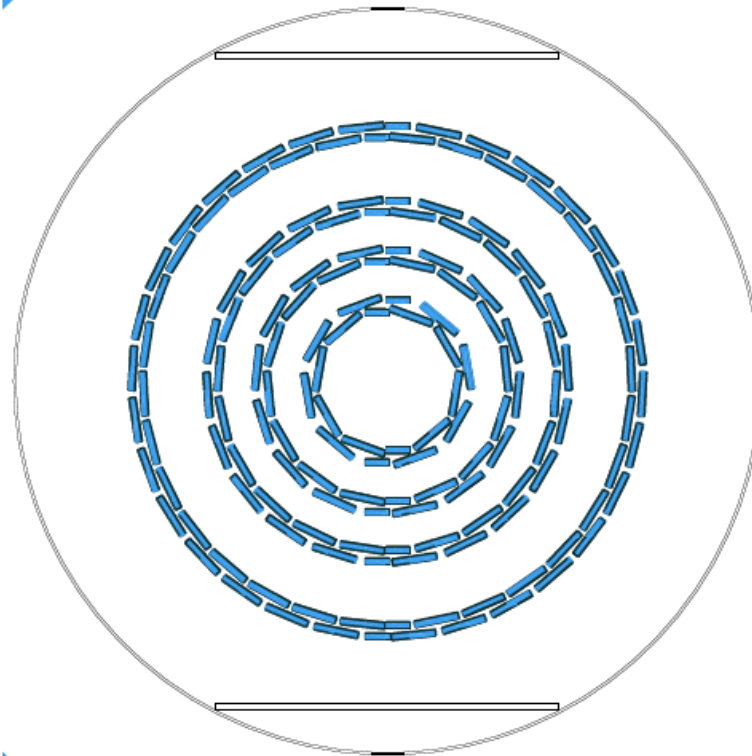

Layer	1	2	3	4
Radius	4.44 cm	7.33 cm	10.19 cm	14.55 cm

SLHC new ATLAS Inner Detector

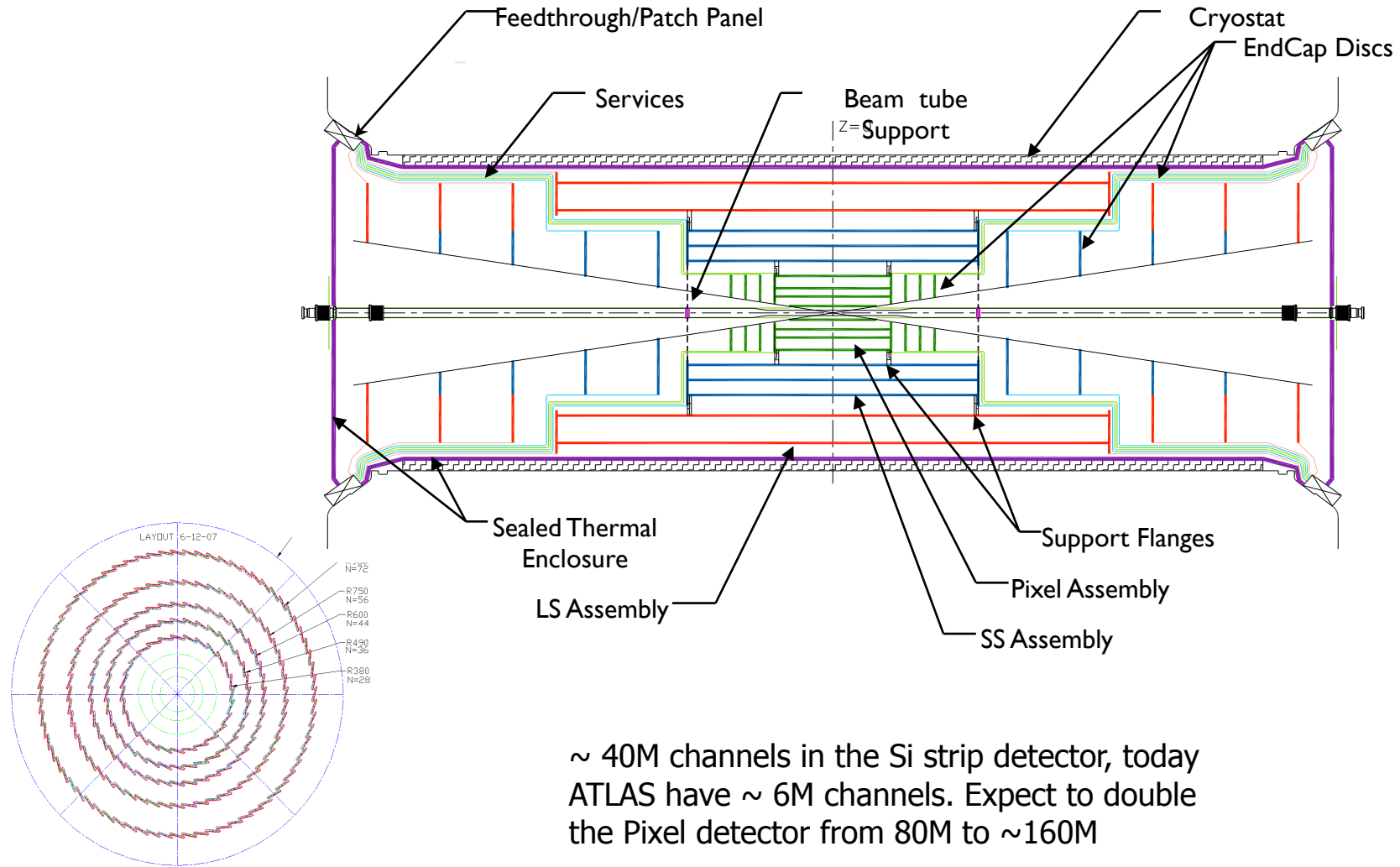

Silicon strip R&D

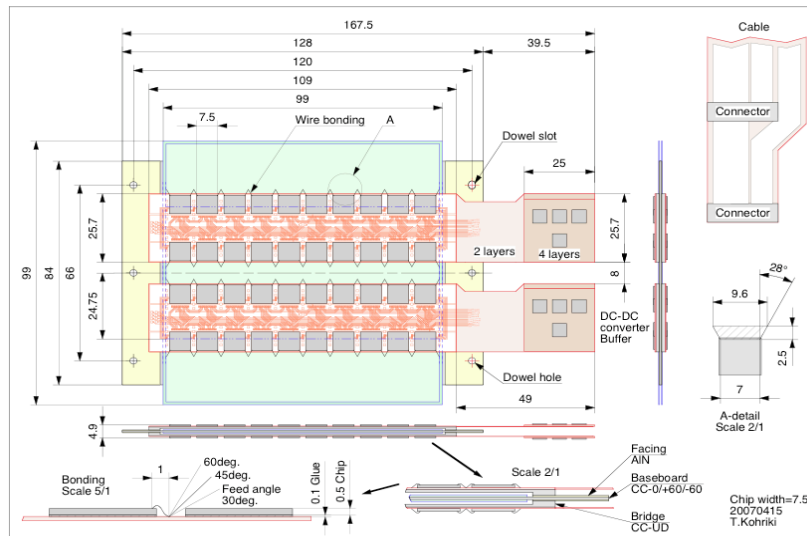

Example of silicon strip module

Crucial integration developments:

- Serial powering and DC-DC converters
- Cooling and thermal management
- Engineering layout (staves and structures)

Opto	Radiation Test Programme for the ATLAS Opto-Electronic Readout System for the SLHC for ATLAS upgrades
Staves	Development and Integration of Modular Assemblies with Reduced Services for the ATLAS Silicon Strip Tracking Layers
ABC-Next	Proposal to develop ABC-Next, a readout ASIC for the S-ATLAS Silicon Tracker Module Design
Radiation BG	Radiation background benchmarking at the LHC and simulations for an ATLAS upgrade at the SLHC
n-on-p sensors	Development of non-inverting Silicon strip detectors for the ATLAS ID upgrade
SiGe chips	Evaluation of Silicon-Germanium (SiGe) Bipolar Technologies for Use in an Upgraded ATLAS Detector
Modules	Research towards the Module and Services Structure Design for the ATLAS Inner Tracker at the Super LHC
Powering	Research and Development of power distribution schemes for the ATLAS Silicon Tracker Upgrade

- ◆ Workshop held at Valencia in December; ~100 people attended



- ◆ Main news:

- ◆ It looks possible (just) to fit ID in in one piece
 - ◆ Integration and full testing above ground, fast installation
- ◆ Electronics architecture becoming better understood
- ◆ Strips readout chip "ApsNext" FDR just held
- ◆ Strips Sensors "ATLAS07" first batch from Hamamatsu imminent
- ◆ Engineering group is being built up, with significant effort identified.
 - ◆ Meetings being held
 - ◆ First ideas on integration, mechanical supports, sizes allowed etc. discussed
 - ◆ Modelling of Strawman, supports etc. (Background picture)
- ◆ Pixel system simulation:
 - ◆ Initial results coming in (G3)
 - ◆ Results need to be better understood, but certainly show difficulties of tracking and vertexing at 150 pile-up events.
 - ◆ More pixels not less are indicated - to be further analysed

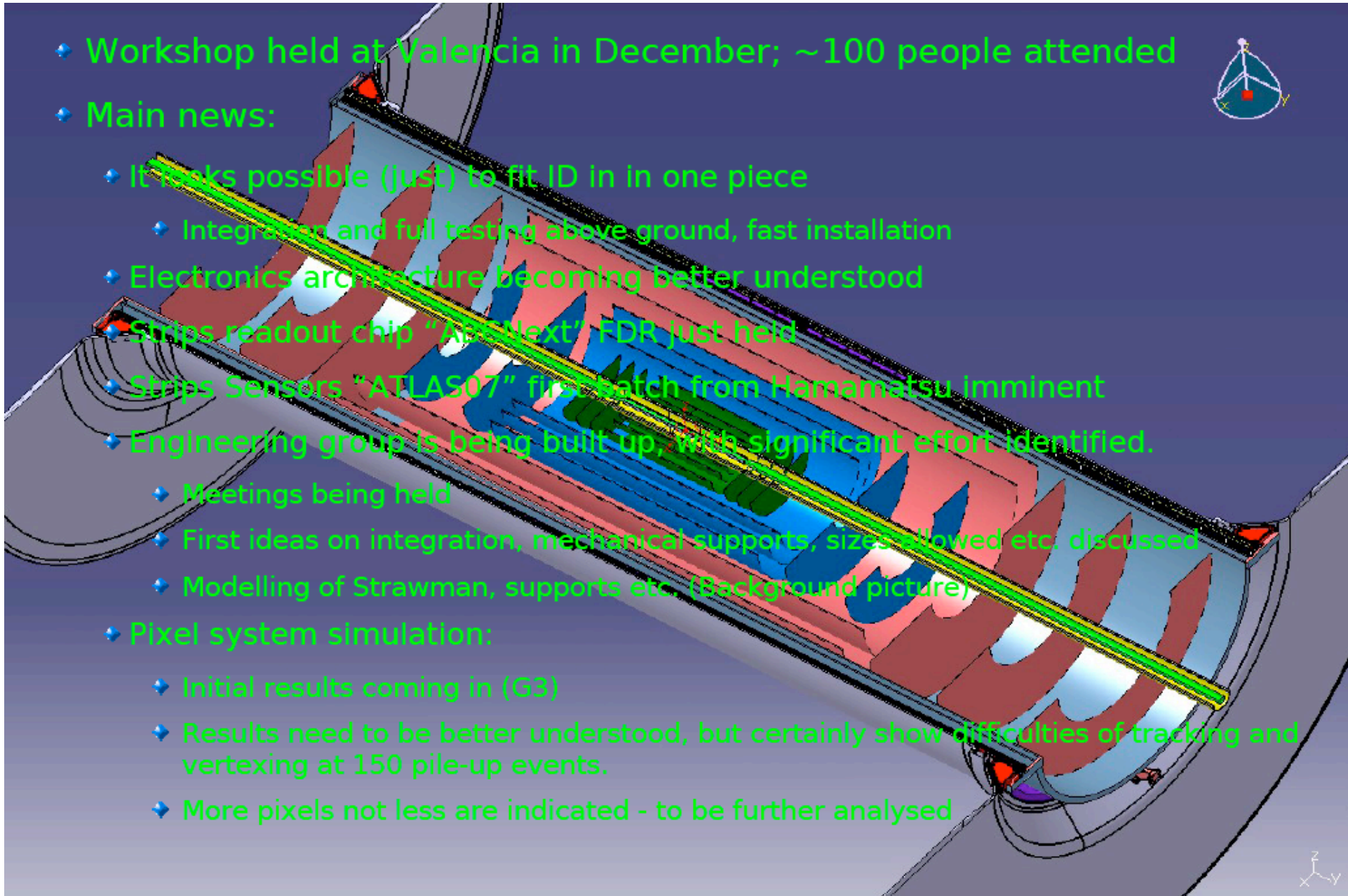

B-layer technologies

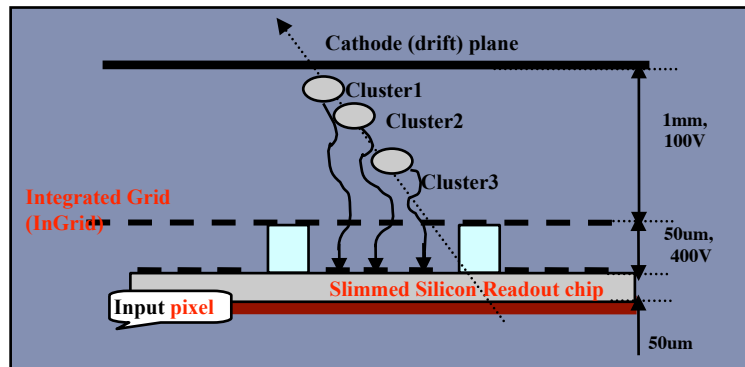
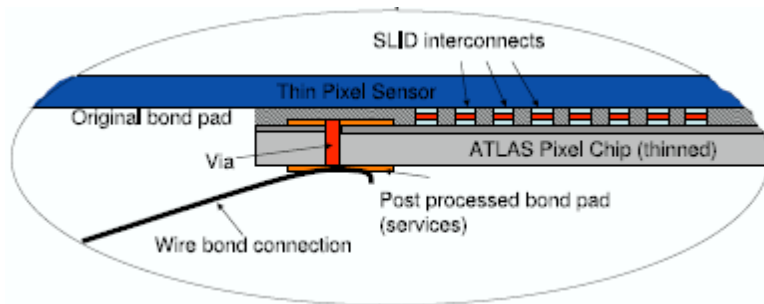
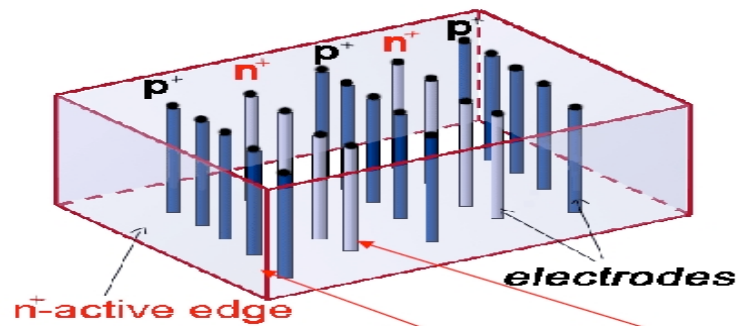

- ▶ Harshesht radiation environment for b-layer ($R \sim 4\text{cm}$) – investigate new technologies
- ▶ 3D Si (Parker, Da Via et al)
 - ▶ Rad tested
- ▶ Thin silicon + 3D interconnects (Nisius et al)
 - ▶ Low bias V, low C, low signal (still good S/N)
- ▶ Gas over thin pixel (GOSSIP) (van de Graaf et al)
- ▶ Diamond pixels (Kagan et al)
- ▶ May test in pre-SLHC b-layer replacement (~ 2012)

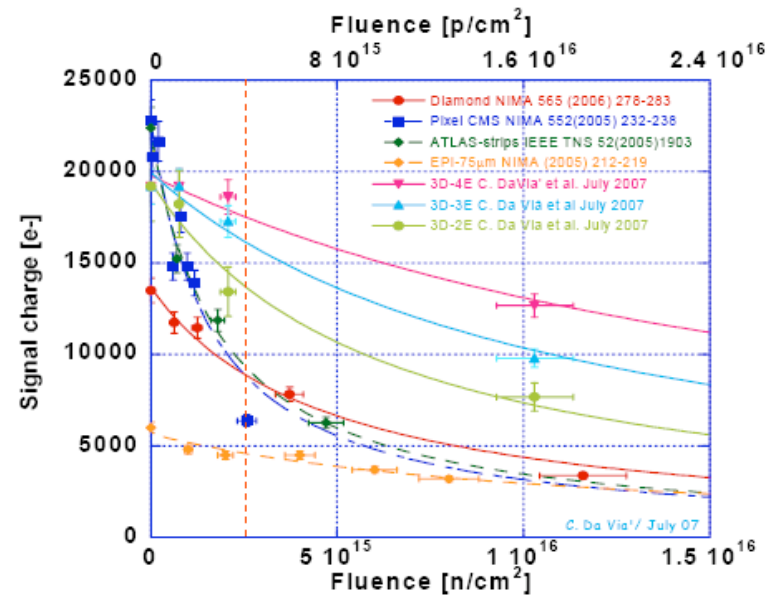

ID cont.

Powering:

- More modules, more power, lower voltage, fixed number of cables and space --> must supply higher V and convert locally
- Review held Mon 4th Feb
- Progress in several concepts: serial, dc-dc (various versions)
- Plans to test for basic performance on stave 1 m long, 20 sensors, 800 chips
- System aspects to be looked at:
 - Link to DCS: how do you know it is safe to turn on?
 - How do you leave broken items off?

Serial with shunt

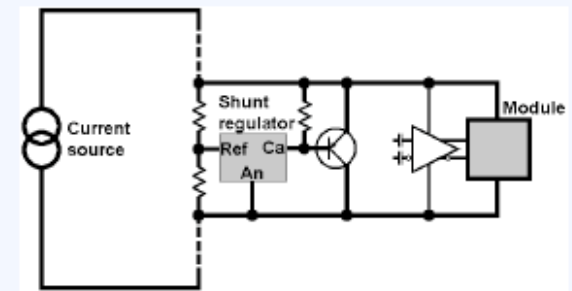

dc-dc buck convertor

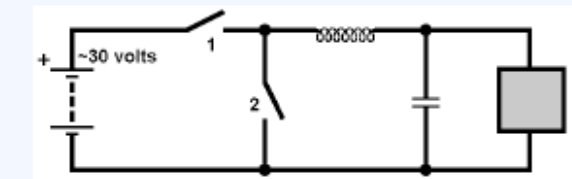

dc-dc charge pump

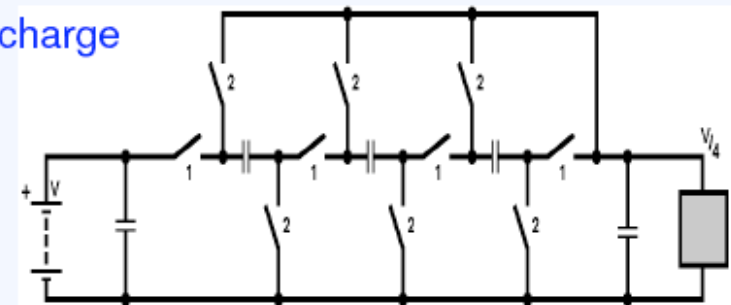

dc-dc with piezo electrics

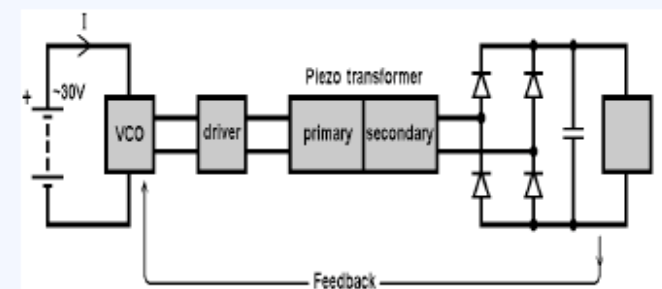

The ATLAS Shielding

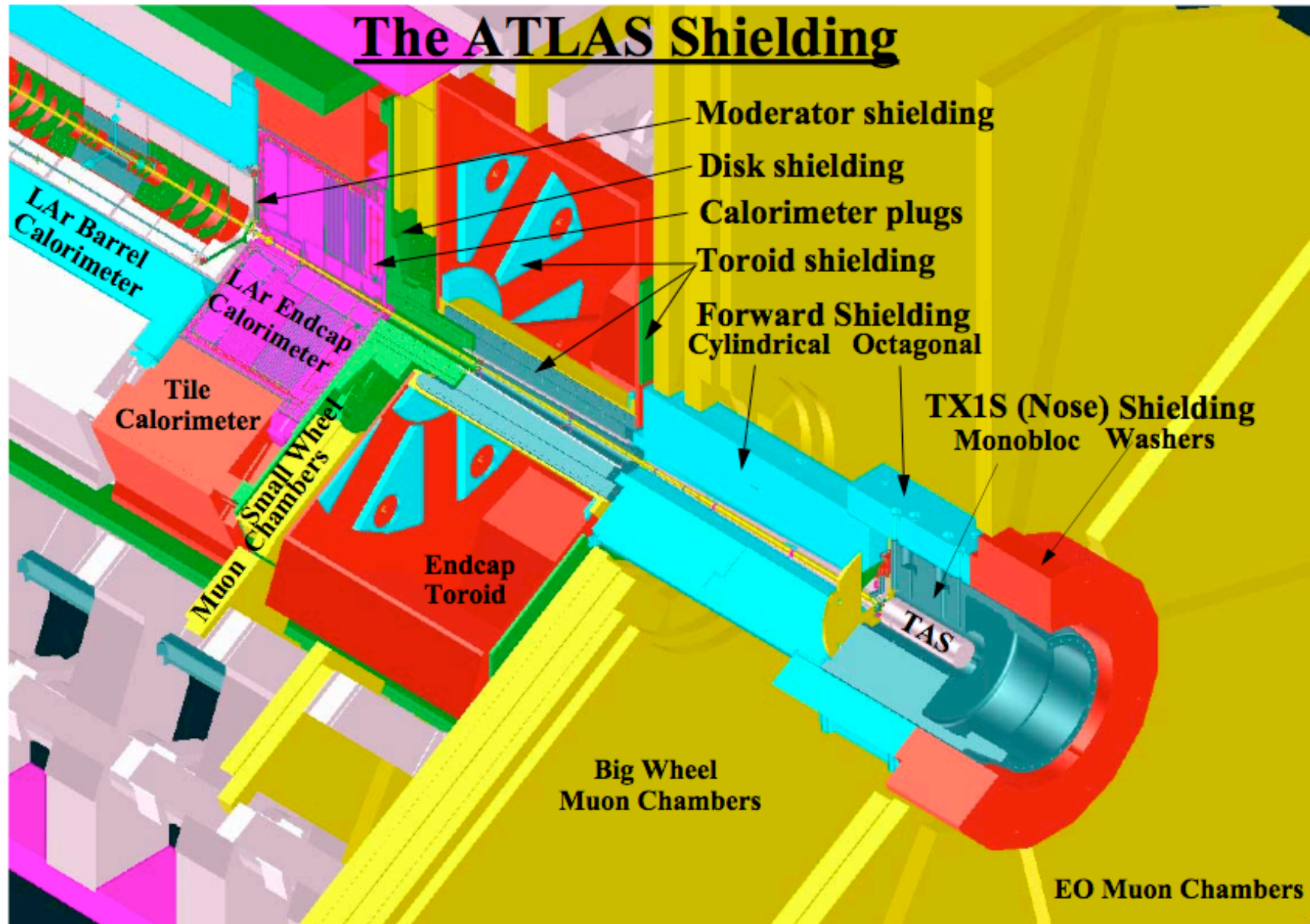

Backgrounds in muon area

A beryllium beampipe

A beryllium beampipe is also the only way of significantly reducing the background in the muon spectrometer.

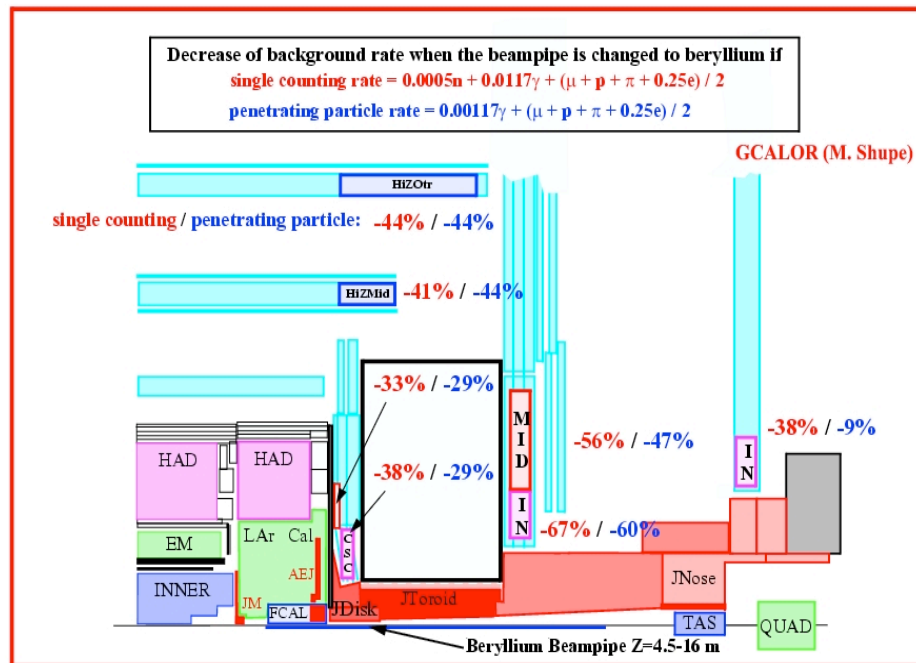

V. Hedberg - CERN / Lund

ATLAS Upgrade Workshop - 01.10.2006

7

- Factor 2 - 3 reduction
- Shielding improvements help, but only marginally
- Be pipe is very much cheaper than replacing a large area of muon chambers

ATLAS Muons

Limitations – occupancies of the chambers

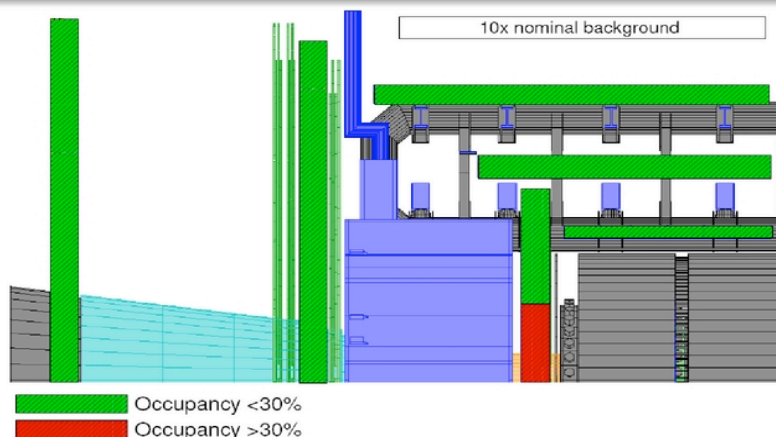

At least half of the chambers in the inner end-cap disk would have to be replaced by chambers with higher high rate capability.

Limitations – occupancies of the chambers

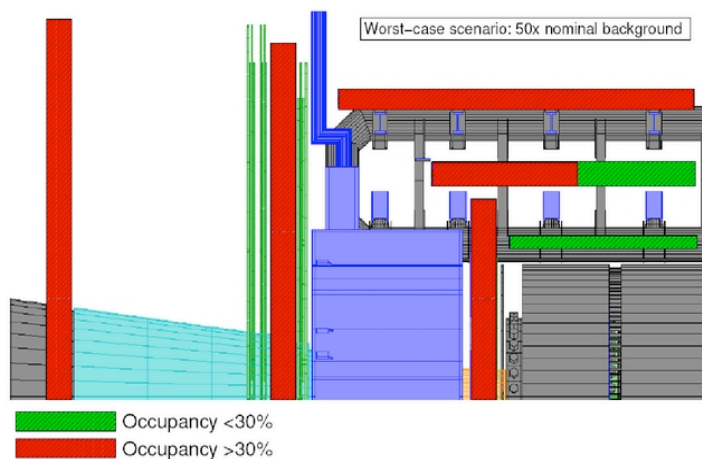

Almost all chamber would have to be replaced.

- ▶ Background rates very uncertain (~5x)
 - ▶ Need LHC experience
 - ▶ Effect of slim magnets?
- ▶ Start before LHC:
 - ▶ Aging studies
 - ▶ Rad hard electronics
 - ▶ Selective readout
 - ▶ High-rate chamber prototypes
- ▶ Use existing chambers as far as possible

Worst case

Calorimeters

General issues:

- ▶ Calorimeter performance with large pileup – reduced resolution – simulations needed
- ▶ Improved electronics is being studied (barrel and endcap)
- ▶ HEC calorimeter might have some problems with cold electronics (radhardness)

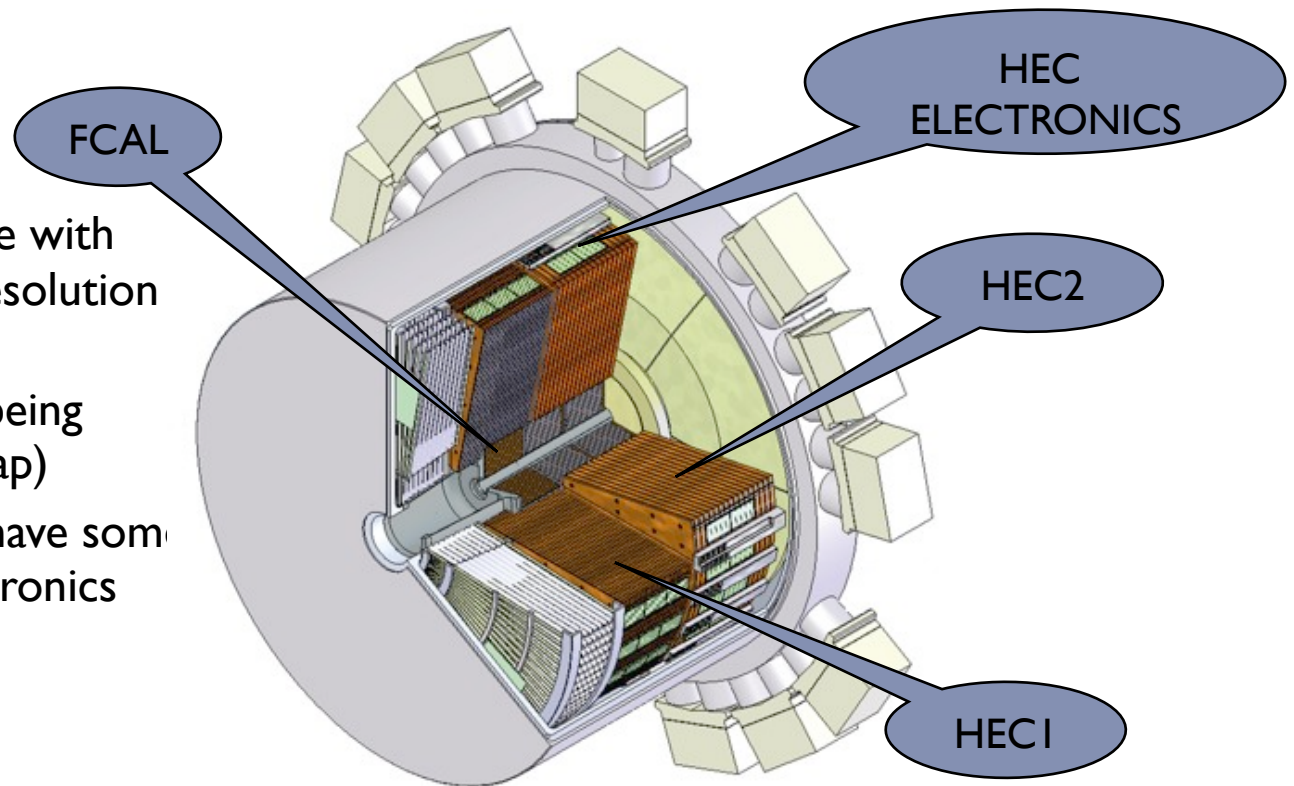

V Strickland

Forward calorimetry

- ▶ However, FCAL ($|\eta| > 3.1$) particularly subject to beam radiation
- ▶ Simulation of LAr FCAL beam heating (pessimistic case)
- ▶ Maximum temperature 93.8K – enough to boil LAr
- ▶ Uncertainties in heat load, convection could make things better or worse; other endcap calorimeters also implicated
 - Improve FCAL cooling (open endcap cryostat)
 - Big challenge
 - New “warm” FCAL plug?

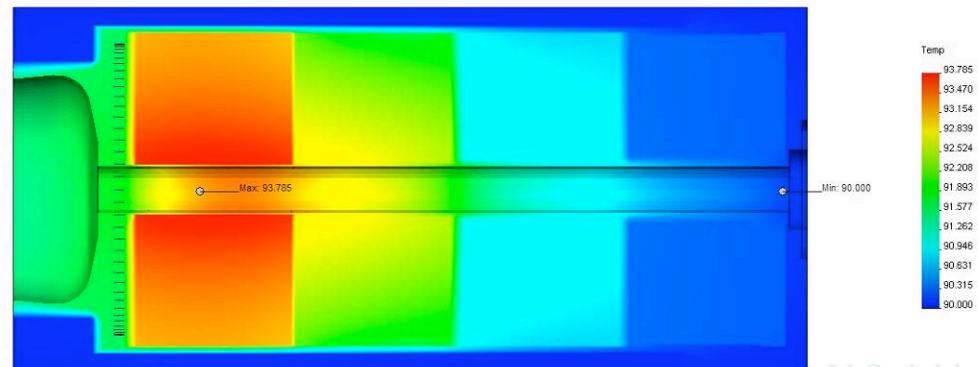
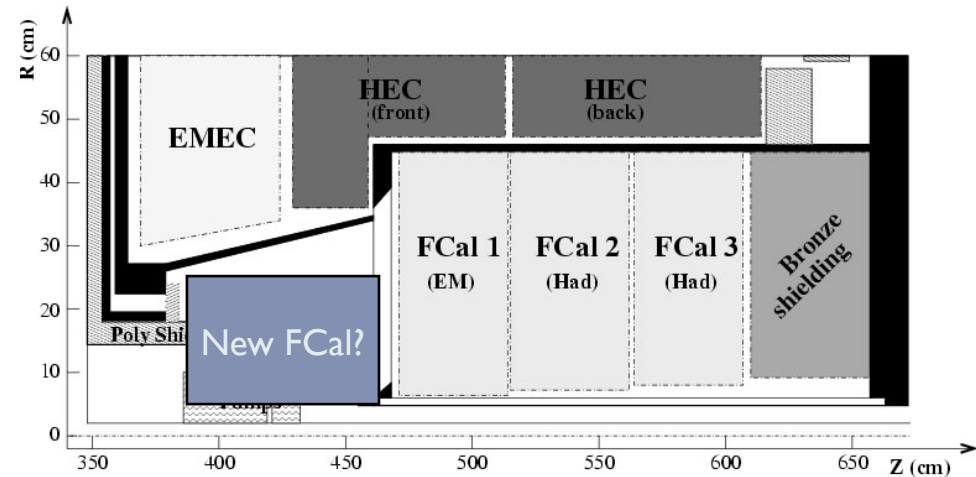

V Strickland

Mini-Cal in front of FCAL

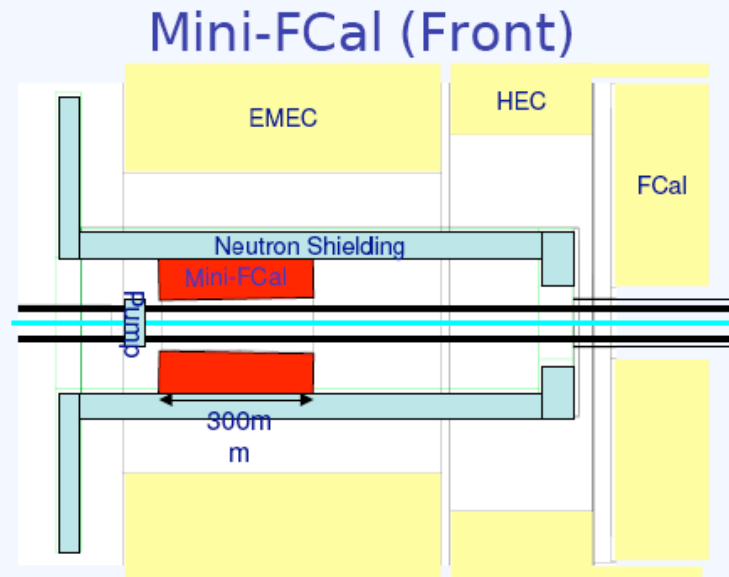

- ▶ Shields FCAL, reducing heating and ion build-up
 - ▶ Simulations show it halves heat flux to FCAL1
- ▶ Interesting because it potentially avoids FCAL replacement
- ▶ Work on-going at TRIUMF

ATLAS Phase 1 Discussions

B-layer Replacement Task Force

- Better knowledge of LHC plans including luminosity updates,
- Time needed to replace the b-layer (would probably mean no pixel for a year)
- Difficulties due to working in an activated area
- Also: realisation we need to be flexible to adapt to surprise problems
 - --> Not clear the base-line replacement of the b-layer is the optimum choice
- A task force of Pixel, Upgrade and Management people has been set up
 - To review the situation, evaluate the options and recommend an updated plan for the pixel system evolution
 - Report in 6 months
- Lead by Guiseppe Mornachie and Allan Clark
- Will consider:
 - Replace b-layer (current baseline)
 - Add new layer
 - Replace whole system as ambitious as possible
 - And keeping several options with a plan to guide decisions

12 Feb 2008

Nigel Hessey

ATLAS Week CERN

14

ATLAS upgrade organization

- ▶ **ATLAS has, in place and operational, a structure to steer its planning for future upgrades, in particular for R&D activities needed for possible luminosity upgrades of the LHC ('SLHC').**
- ▶ **This is already a rather large and broad activity...typically 100-150 people in ATLAS upgrade workshops, generally active part time in this**

- ▶ The main goals are to
 - ▶ - Develop a realistic and coherent upgrade plan addressing the physics potential
 - ▶ - Retain detector experts in ATLAS with challenging developments besides detector commissioning and running
 - ▶ - Cover also less attractive (but essential) aspects right from the beginning

- ▶ The organization has two major coordination bodies
 - ▶ Upgrade Steering Group (USG)
 - ▶ (Existing since three years, with representatives from systems, software, physics, and relevant Technical Coordination areas)
 - ▶ Project Office (UPO)
 - ▶ (Operates since more than a year, fully embedded within the Technical Coordination)

- ▶ Upgrade R&D proposals are reviewed and handled in a transparent way within the Collaboration
- ▶ There is a good and constructive synergy from common activities with CMS where appropriate

<http://atlas.web.cern.ch/Atlas/GROUPS/UPGRADES/>

ATLAS Upgrade Organisation

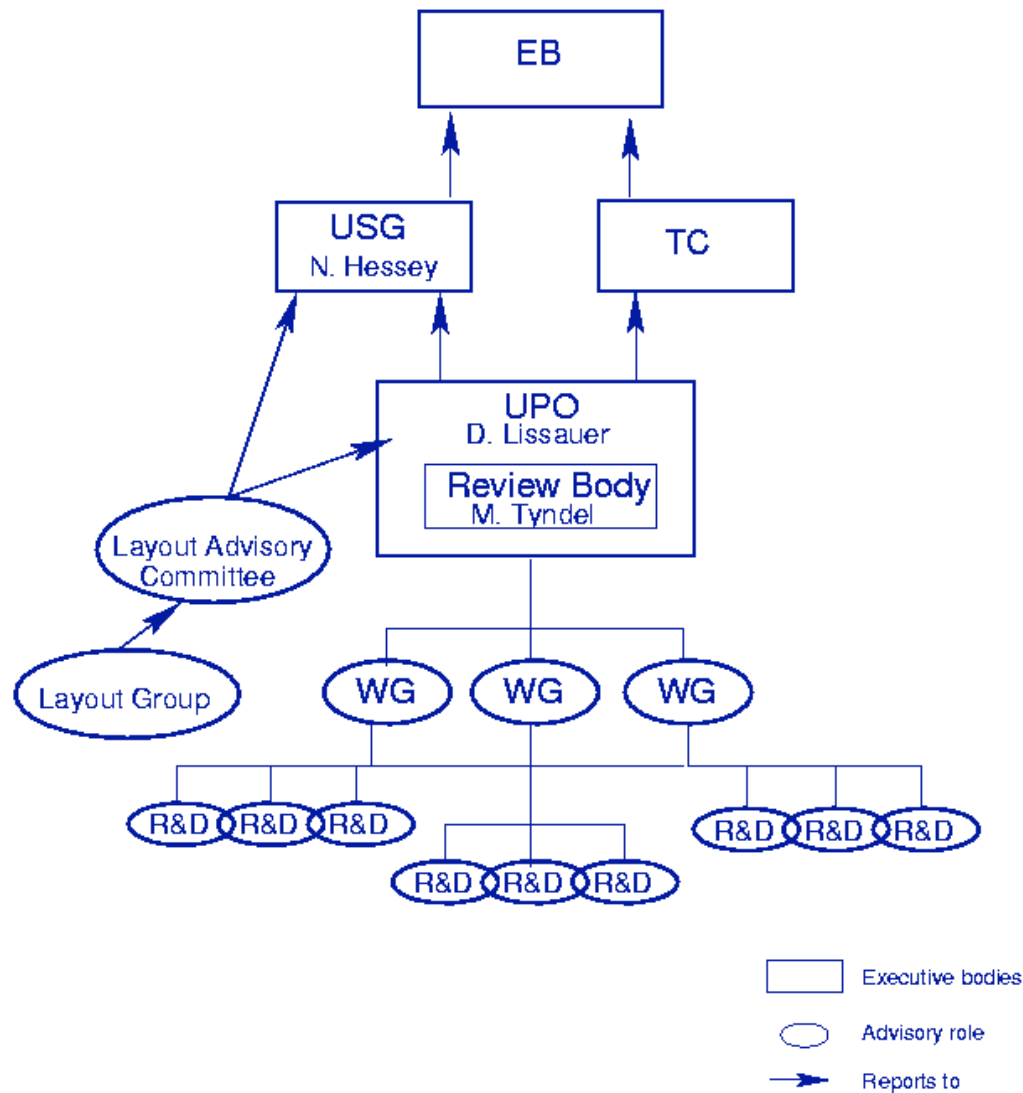

ATLAS Upgrade Project Office

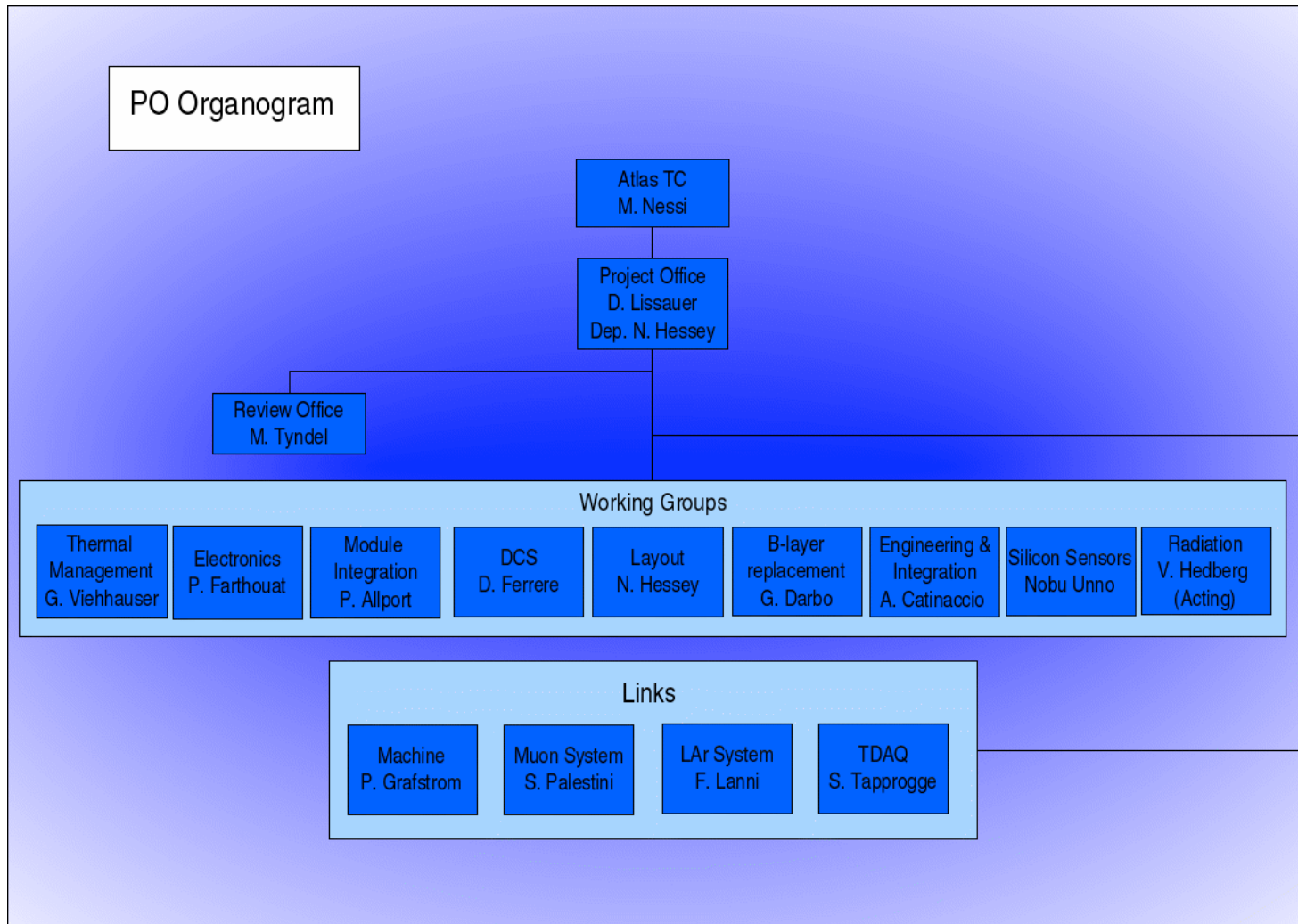

CMS Upgrade Management

CMS Upgrade Project

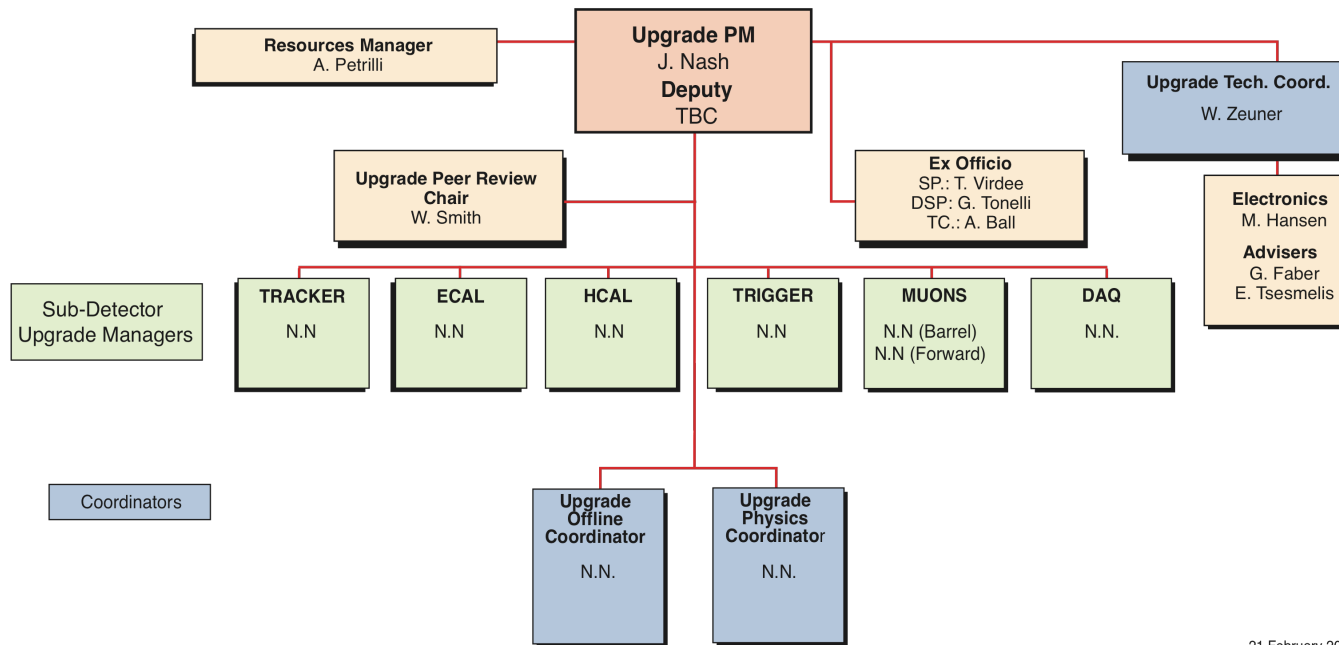

21 February 2008

R&D addresses the main changes foreseen for ATLAS:

- An all new inner tracker, more rad-hard and higher granularity than the current one and all-silicon. Power and cooling major issues.
- Forward LAr calorimeter (FCAL) is being studied in test beam to see how far it copes; it may need replacing. Also new readout electronics for higher data rate and rad-hardness.
- Tiles (had. cal) cope well, but will benefit from some electronics upgrade.
- Muons need to see how high the backgrounds are. If close to nominal predictions, most chambers will cope at SLHC but some in the forward region will need replacing with new higher-rate chambers. Readout electronics for higher data rates will be needed.
- Various improvements in the trigger are being investigated.
- Beam-pipe will change materials for less activation and backgrounds; shielding improvements will be investigated – integrated with machine elements. Radiation studies crucial.
- Magnets stay as is.

Some of the Identified R&D areas (CMS)

- ▶ Pixel technology
 - ▶ Hybrid - cheaper bonding
 - ▶ MAPS/SOI - need an answer now if it can be used
- ▶ Geometry
 - ▶ How many different sensors
 - ▶ Layout of inner/outer pixels
- ▶ Triggering layers
 - ▶ How many/Where
- ▶ Readout
 - ▶ Current ROC to 130 nm
 - ▶ New ROC to push Col hit info for stacks
 - ▶ Correlator Chip
- ▶ Link and Control technology
 - ▶ GBT?
 - ▶ Optical Links
- ▶ Radiation tolerance and robustness of 130nm/90nm
- ▶ Technology for a very inner layer
 - ▶ Different sensor
- ▶ Power/Material
 - ▶ DC-DC/Serial power

Request to CERN management:
Ask LHCC to Peer-Review common
electronic projects for SLHC

Many of these
topics lend
themselves to
Common R&D

A list of current ATLAS sLHC upgrade R&D activities

Short name	Title	Principle contacts	Status
Opto	Radiation Test Programme for the ATLAS Opto-Electronic Readout System for the SLHC for ATLAS upgrades	Cigdem Issever	Approved by EB
Staves	Development and Integration of Modular Assemblies with Reduced Services for the ATLAS Silicon Strip Tracking Layers	C. Haber, M. Gilchriese	Approved by EB
ABC-Next	Proposal to develop ABC-Next, a readout ASIC for the S-ATLAS Silicon Tracker Module Design	Francis Anghinolfi, Wladek Dabrowski	Approved by EB
Radiation BG	Radiation background benchmarking at the LHC and simulations for an ATLAS upgrade at the SLHC	Ian Dawson	Approved by EB
n-on-p sensors	Development of non-inverting Silicon strip detectors for the ATLAS ID upgrade	Hartmut Sadrozinski	Approved by EB
SiGe chips	Evaluation of Silicon-Germanium (SiGe) Bipolar Technologies for Use in an Upgraded ATLAS Detector	Alex Grillo, S. Rescia	Approved by EB
3D sensors	Development, Testing, and Industrialization of 3D Active-Edge Silicon Radiation Sensors with Extreme Radiation Hardness: Results, Plans	Sherwood Parker now Cinzia Da Via	Approved by EB
Modules	Research towards the Module and Services Structure Design for the ATLAS Inner Tracker at the Super LHC	Nobu Unno	Approved by EB
Powering	Research and Development of power distribution schemes for the ATLAS Silicon Tracker Upgrade	Marc Weber	Approved by EB
TRT	R&D of segmented straw tracker detector for the ATLAS Inner Detector Upgrade	Vladimir Peshekhonov	Not Approved

A list of current ATLAS sLHC upgrade R&D activities (page 2)

Gossip	R&D proposal to develop the gaseous pixel detector Gossip for the ATLAS Inner Tracker at the Super LHC	H van der Graaf	Expression of interest received
SoS	Expression of Interest: Evaluations on the Silicon on Sapphire 0.25 micron technology for ASIC developments in the ATLAS electronics readout upgrade	Ping Gui and Jingbo Ye	Approved by EB
Thin pixels	R&D on thin pixel sensors and a novel interconnection technology for 3D integration of sensors and electronics	H-G. Moser	Approved by EB
Muon Micromegas	R&D project on micropattern muon chambers	V. Polychronakos Joerg Wotschack	Approved by EB
TGC	R&D on optimizing a detector based on TGC technology to provide tracking and trigger capabilities in the MUON Small-Wheel region at SLHC	G. Mikenberg	Proposal Received
MDTReadout	Upgrade of the MDT Readout Chain for the SLHC	R. Richter	Expression of interest received
MDTGas	R&D for gas mixtures for the MDT detectors of the Muon Spectrometer	P. Branchini	Expression of interest received
Selective Readout	Upgrade of the MDT Electronics for SLHC using Selective Readout	R. Richter	Expression of interest received
High Rate MDT	R&D on Precision Drift-Tube Detectors for Very High Background Rates at SLHC	R. Richter	Expression of interest received
Diamond	Diamond Pixel Modules for the High Luminosity ATLAS Inner Detector Upgrade	M. Mikkuz	Approved by EB
ID Alignment	ID Alignment Using the Silicon Sensors	H. Kroha	EoI Received
Fast Track Trigger	FTK, a hardware track finder	M. Shochet	Approved by EB

A list of current ATLAS sLHC upgrade R&D activities (page 3)

Versatile link	The Versatile Link Common Project	Francois Vasey	Sent to CB for comments
Lar FE Electronics	R&D Towards the Replacement of the Liquid Argon Calorimeter Front End Electronics for the sLHC	G. Brooijmans	EoI Received
Lar Optolink	R and D of a radiation resistant high speed optical link for the ATLAS Liquid Argon Calorimeter readout	Jingbo Ye	EoI Received
Lar ROD	Research and Development of Readout Driver (ROD) for the upgrade of the Liquid Argon Calorimeter Front-End Readout	Hucheng Chen	EoI Received
FCAL Cold	Development of new ATLAS Forward Calorimeters for the Upgrade	J. Rutherford	EoI Received

CMS R/D Proposals

Proposal Name	Proposers	Submitted
R&D on Novel Powering Schemes for the SLHC CMS Tracker	RWTH Aachen, contact: Lutz Feld	September 2007
Research and Development for CMS tracker in SLHC era	<i>Lenny Spiegel (Fermilab), Jorma Tuominiemi, Jaakko Haerkoenen, Panja Luukka, Eija Tuominen, Sandor Czellar (Helsinki Institute of Physics, HIP), Martin Frey, Alexander Furgeri, Frank Hartmann, (Karlsruhe University), Vincent Lemaître (Louvain University), Alexander Kaminski, Dario Bisello (University of Padova), Regina Demina, Yuri Gotra, Sergey Korjenevski (University of Rochester)</i>	September 2006
Redesign of the Phi and Eta Trigger Track Finders for SLHC	Vienna and U. A. Madrid Groups	September 2007
Redesign of the Global Trigger and Global Muon Trigger for SLHC	Vienna Group	September 2007
SLHC Calorimeter Trigger R&D Program	University of Wisconsin	October 2007
CSC Level-1 Track-Finder Trigger upgrade	Florida, Rice, UCLA	October 2007
Study of suitability of magnetic Czochralski silicon for the SLHC CMS strip tracker	Contact persons: Panja Luukka, Jaakko Härkönen, Regina Demina, Leonard Spiegel	October 2007
R&D for Possible Replacement of Inner Pixel Layers With Aims for an SLHC Upgrade	Alice Bean , Timothy Bolton, Aaron Dominguez, Wolfram Erdmann, Cecilia Gerber, Roland Horisberger, Angel L'opez	October 2007
R&D in preparation for an upgrade of CMS for the Super-LHC	University of Bristol Brunel University Imperial College London Rutherford Appleton Laboratory	October 2007
Upgrade of CMS Barrel Muon Detector	CIEMAT, Universidad de Cantabria, Torino, Bologna, It Padova, Bari, Pavia, Napoli, RWTH Aachen, Madrid, Legnaro, Frascati	October 2007

CMS R/D (page 2)

CSC Endcap Muon Upgrades	Contact Person: Jay Hauser	October 2007
Reference Link Project For High Speed Optical Data Link R&Ds	SMU, Minnesota and OSU	October 2007
	Francois Vasey and Jan Troska, Physics Department, CERN, Geneva, Switzerland	
	Christian Olivetto and Jean-Marie Brom, Institut Pluridisciplinaire Hubert Curien, Strasbourg, France	
The Versatile Link Common Project	Cigdem Issever, Todd Huffman and Tony Weidberg, Department of Physics, Oxford University, United Kingdom	November 2007
	Jingbo Ye, Department of Physics, southern Methodist University, Dallas TX, USA	
3D detectors for inner pixel layers	Contact Person (Project Leader/responsible): Daniela Bortoletto/Simon Kwan	December 2007
CMS HCAL Calorimeter Electronics Upgrade	Contact Person: Drew Baden, University of Maryland	December 2007
Proposal for US CMS Pixel Mechanics R&D at Purdue and Fermilab in FY08	Daniela Bortoletto, Simon Kwan, Petra Merkel, Ian Shipsey, J.C. Yun	December 2007
R&D for Thin Single-Sided Sensors with HPK materials, technologies and simulations for silicon sensor modules at intermediate to large radii of a new CMS tracker for SLHC	Contact Person: Marcello Mannelli	January 2008
	Hamburg, Karlsruhe, Louvain, Vienna, Vilnius	March 2008

SLHC R&D:Next steps

- ▶ Expressions of Interest
 - ▶ Brief case for upgrade
 - ▶ Outlines scope of upgrade work
 - ▶ What detectors/Timescale
 - ▶ CMS Submitted to LHCC March 2007
 - ▶ Prepare funding agencies
- ▶ Written request from CMS/ATLAS to CSO for R&D Peer Review by the LHCC
- ▶ CERN FP7 EU Proposal
 - ▶ Starting with This week's kickoff meeting
 - ▶ Create upgrade management structures
 - ▶ for SLHC machine project
 - ▶ and CMS/ATLAS upgrade projects
 - ▶ Prepare Letter of Intent
 - ▶ Prepare Cost Books

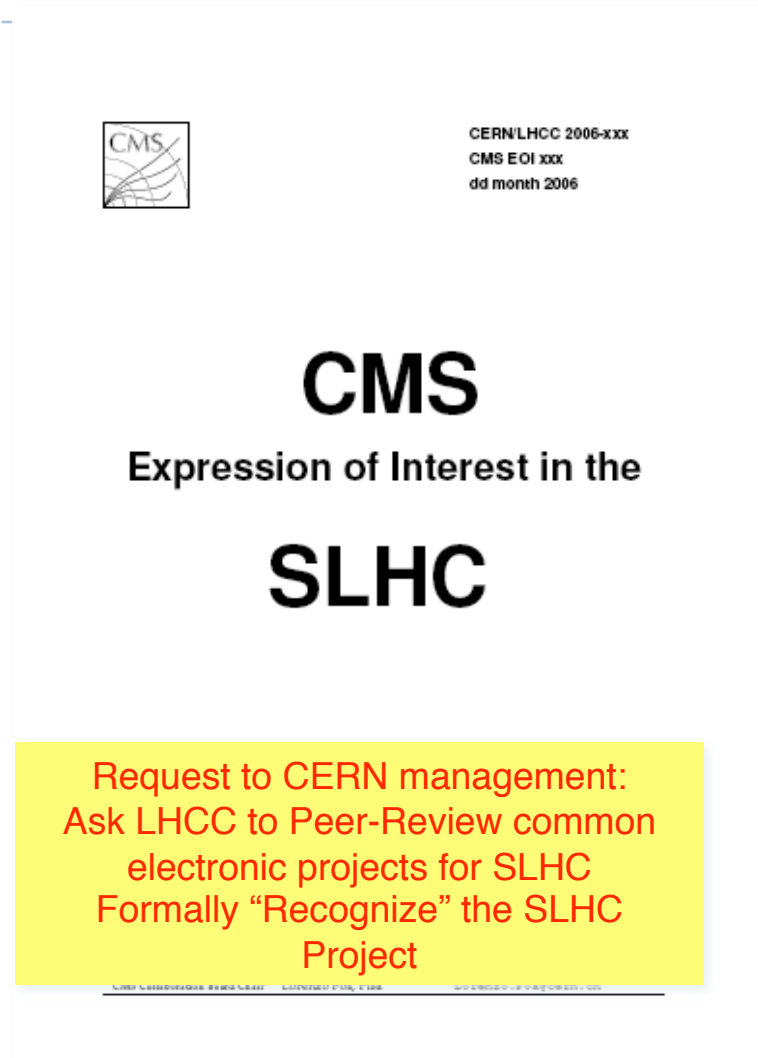

Common Projects

- ▶ There are many common R&D topics which must be pursued by ATLAS and CMS
 - ▶ Take advantage of this by identifying these areas early and encouraging common R&D efforts
- ▶ A Joint meeting was held last year to discuss possible joint R&D
 - ▶ ACES meeting - <http://aces.web.cern.ch/aces/>
 - ▶ More than 200 attended
 - ▶ Will repeat later this year
- ▶ Topics include
 - ▶ Link Technology
 - ▶ Joint working group active for some time
 - ▶ ASIC technology (e.g. 130nm)
 - ▶ Power distribution
 - ▶ Funding from EU
 - ▶ Meeting of working group earlier this week
 - ▶ Cooling
 - ▶ Radiation/shielding issues

Conclusions

- ▶ Considerable R&D is required for LHC detectors capable of delivering science in high luminosity running of the LHC
- ▶ The timescale for this R&D is relatively short
 - ▶ Long lead times to build new trackers
- ▶ Need to focus R&D and look at Common projects
- ▶ The R&D program is starting to ramp up now
 - ▶ Operation of the machine and detectors as well as physics results will help guide the decisions which need to be taken in the next few years on detector design.