



Enabling Grids for E-science

gLite Basic APIs

Christos Filippidis

(filippidis@inp.demokritos.gr)

Application Support Team

NCSR "Demokritos", Institute of Nuclear Physics

www.eu-egee.org



- Application definition
- Environment configuration
- Information discovery
- Data management
- Program definition
- Program execution
- Summary

- Application definition
- Environment configuration
- Information discovery
- Data management
- Program definition
- Program execution
- Summary

Image Compression



original image

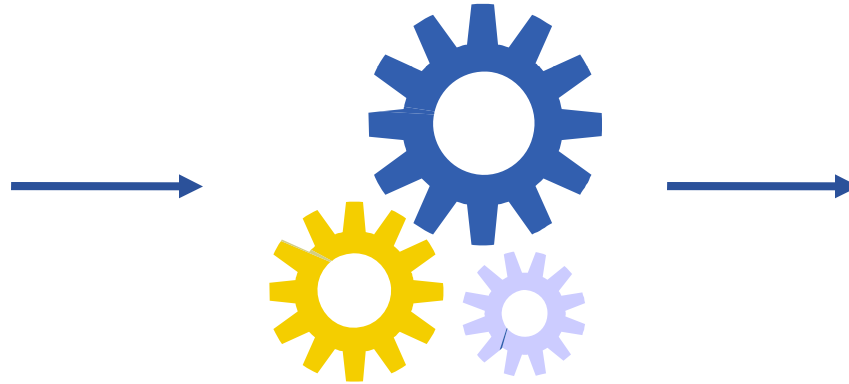

compression algorithm



compressed image

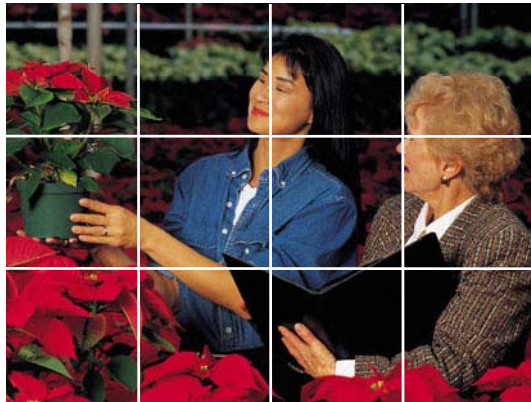

data
decomposition

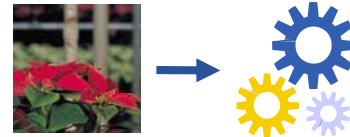

parallel
processing



data
composition

- Application definition
- Environment configuration
- Information discovery
- Data management
- Program definition
- Program execution
- Summary

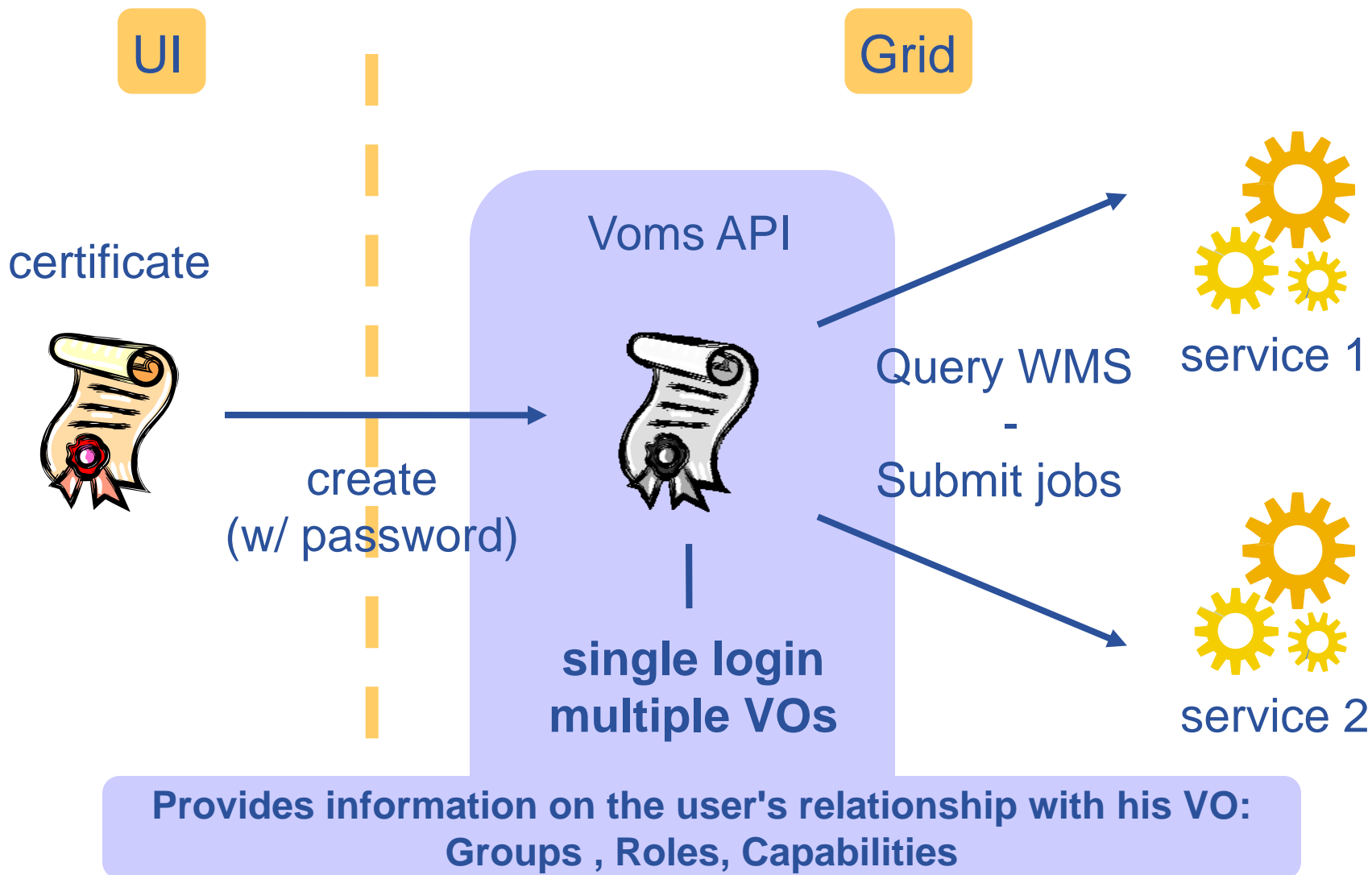

- Application definition
- Environment configuration
- Information discovery
- Data management
- Program definition
- Program execution
- Summary

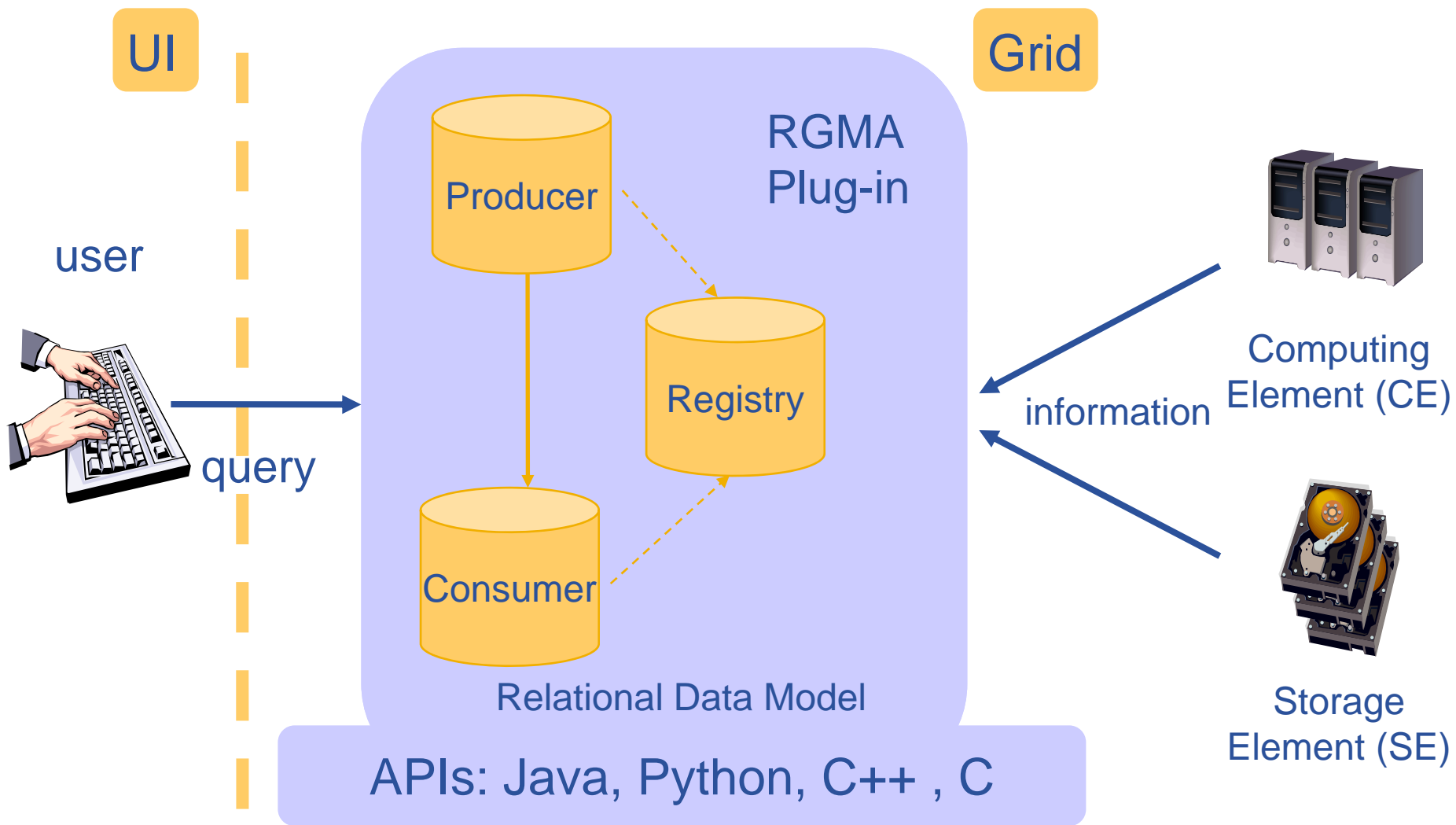

- Application definition
- Environment configuration
- Information discovery
- Data management
- Program definition
- Program execution
- Summary

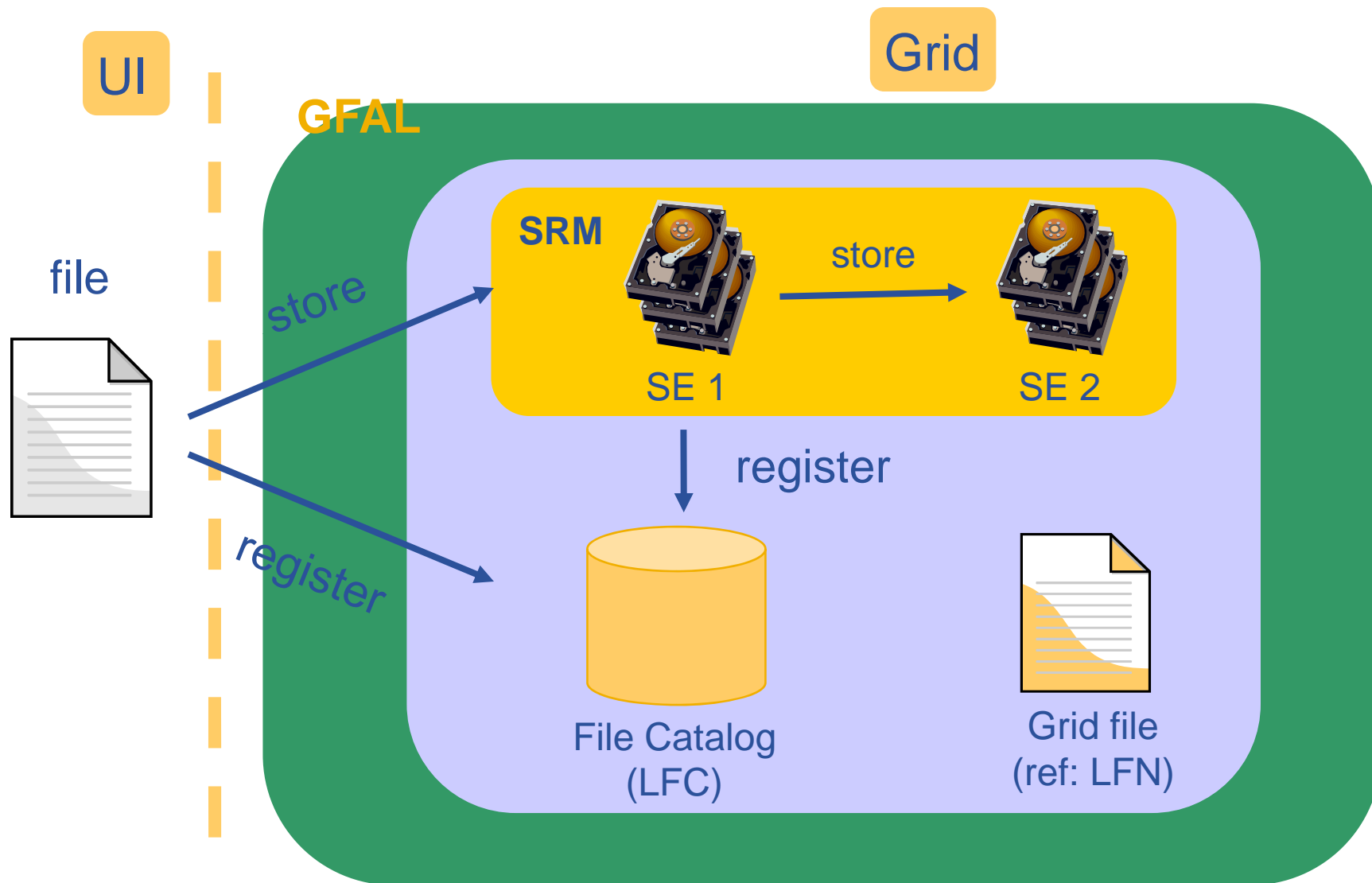

- Application definition
- Environment configuration
- Information discovery
- Data management
- Program definition
- Program execution
- Summary

Job Description Language (JDL)

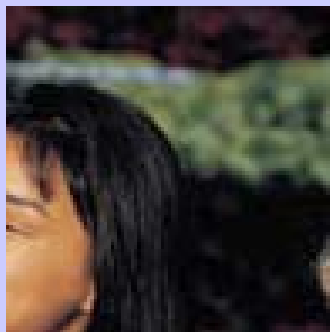

original
input data
sub-image

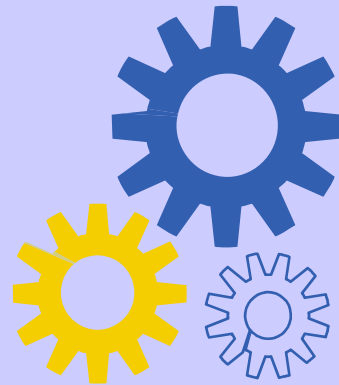

compression
program
algorithm



compressed
output data
sub-image

- Application definition
- Environment configuration
- Information discovery
- Data management
- Program definition
- Program execution
- Summary

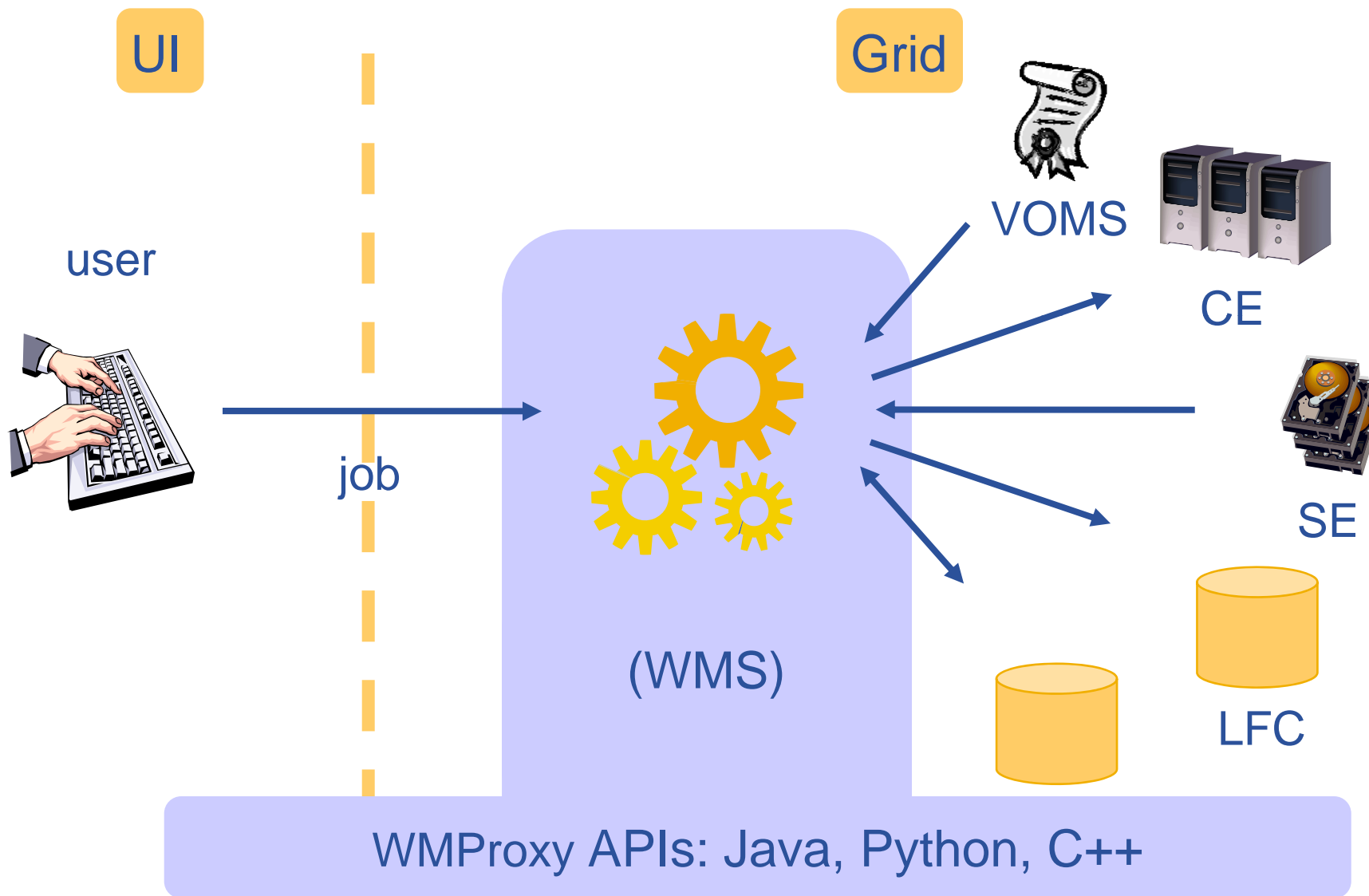

- Application definition
- Environment configuration
- Information discovery
- Data management
- Program definition
- Program execution
- Summary

- Parallelize application
- Authenticate with VOMS API
- Get information with Service Discovery
- Data management with GFAL
- Execute application with WMS & WMSProxy API

- gLite Documentation
- <http://glite.web.cern.ch/glite/documentation/>



Enabling Grids for E-science

Questions?

Christos Filippidis
(filippidis@inp.demokritos.gr)
Application Support Team
NCSR "Demokritos", Institute of Nuclear Physics

www.eu-egee.org

