

---

# Medical Applications of Modern Physics

Marco Silari  
CERN, Geneva, Switzerland  
marco.silari@cern.ch

---

# Medical Physics

=

A branch of applied physics concerning  
the application of physics to medicine

or, in other words

The application of physics techniques to the  
human health

# Introduction to Medical Physics

- Physics discoveries
- Tools for physics applied to medicine
- Medical imaging
- X-ray CT
- PET and PET/CT
- Photon/electron radiation therapy
- Hadron therapy

# The beginnings of modern physics and of medical physics

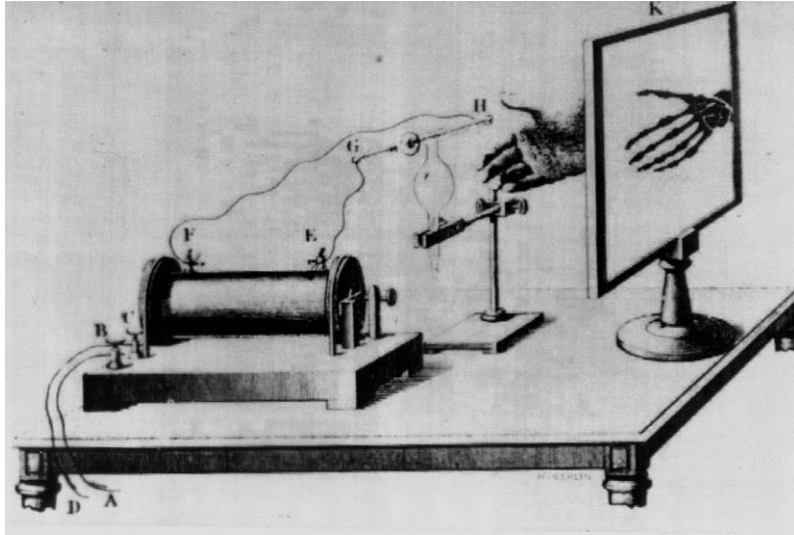

1895  
Discovery of X rays  
**Wilhelm C. Röntgen**



1897  
First treatment of  
tissue with X rays  
**Leopold Freund**

**J.J. Thompson**

1897  
"Discovery" of the  
electron

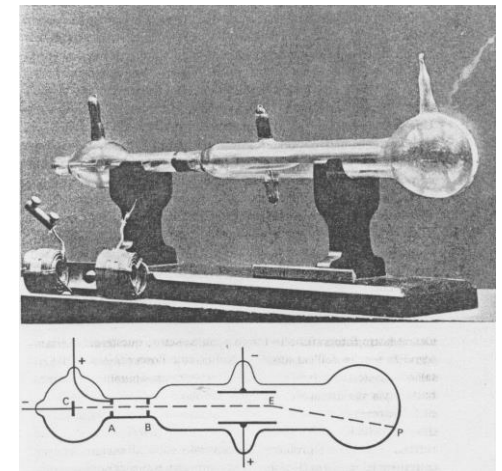

# The beginnings of modern physics and of medical physics



**Henri Becquerel  
(1852-1908)**

1896

Discovery of natural  
radioactivity

Thesis of Mme. Curie – 1904

$\alpha$ ,  $\beta$ ,  $\gamma$  in magnetic field

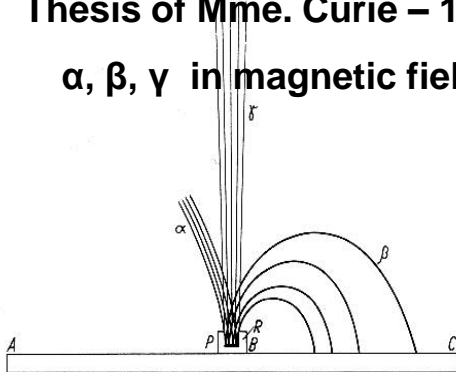

Hundred years ago

1898

Discovery of polonium  
and radium

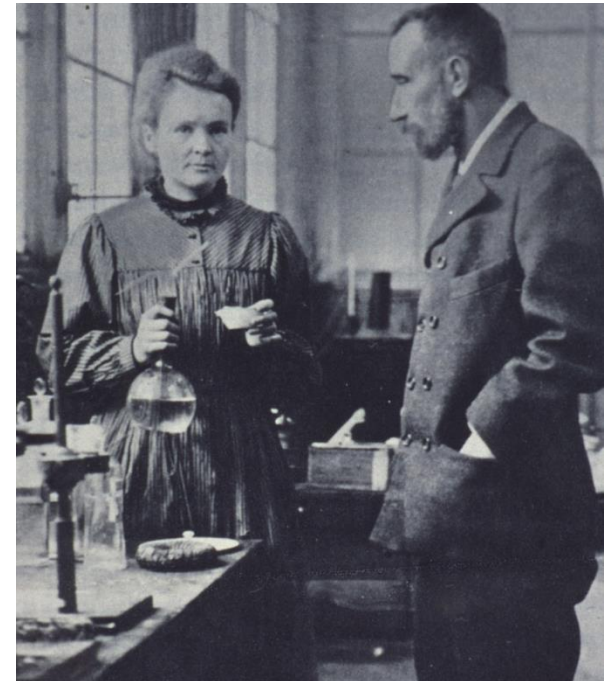

**Marie Curie    Pierre Curie  
(1867 – 1934) (1859 – 1906)**

# First practical application of a radioisotope

---

- **1911: first practical application of a radioisotope** (as *radiotracer*) by G. de Hevesy (a young Hungarian student working with naturally radioactive materials) in Manchester
- **1924:** de Hevesy, who had become a physician, used radioactive isotopes of lead as tracers in bone studies

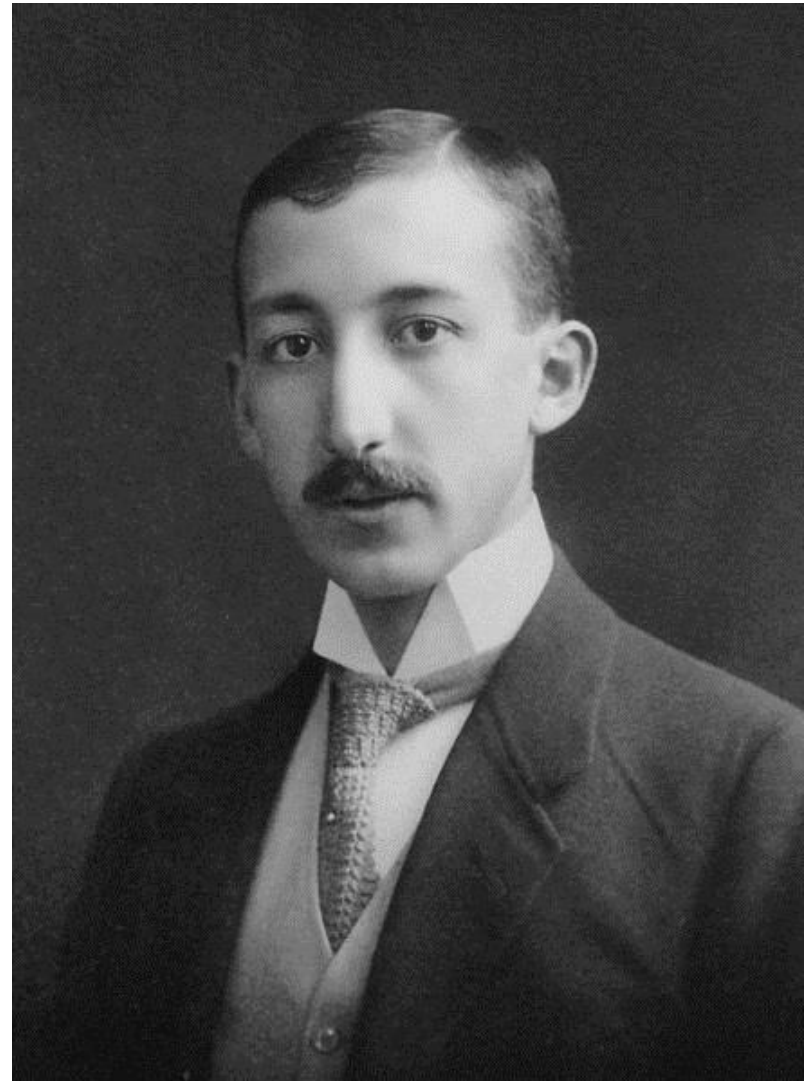

# 1920's – Industrially manufactured x-ray apparatus

## Röhren fremden Fabrikates.

„Monopol“-Oberflächen-Therapie-Röntgenröhre mit Vorrichtung zur therapeutischen Dosierung der Röntgenstrahlen nach Prof. Dr. A. Köhler, Wiesbaden.

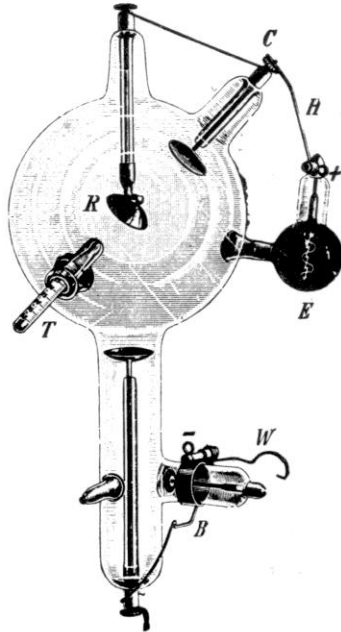

Schutzmarke.

Diese Röhre ist besonders für die Röntgen-Oberflächen-therapie bestimmt. Sie gestattet eine praktisch genügend genaue Verabreichung der für eine Sitzung erforderlichen Strahlenmenge durch bequeme direkte Ablesung an einer Thermometerskala.

[22.5] Monopol X-ray tubes were available in 1907 and some were modified to Köhler's specification by 1914. (Courtesy: Siemens AG, Erlangen.)

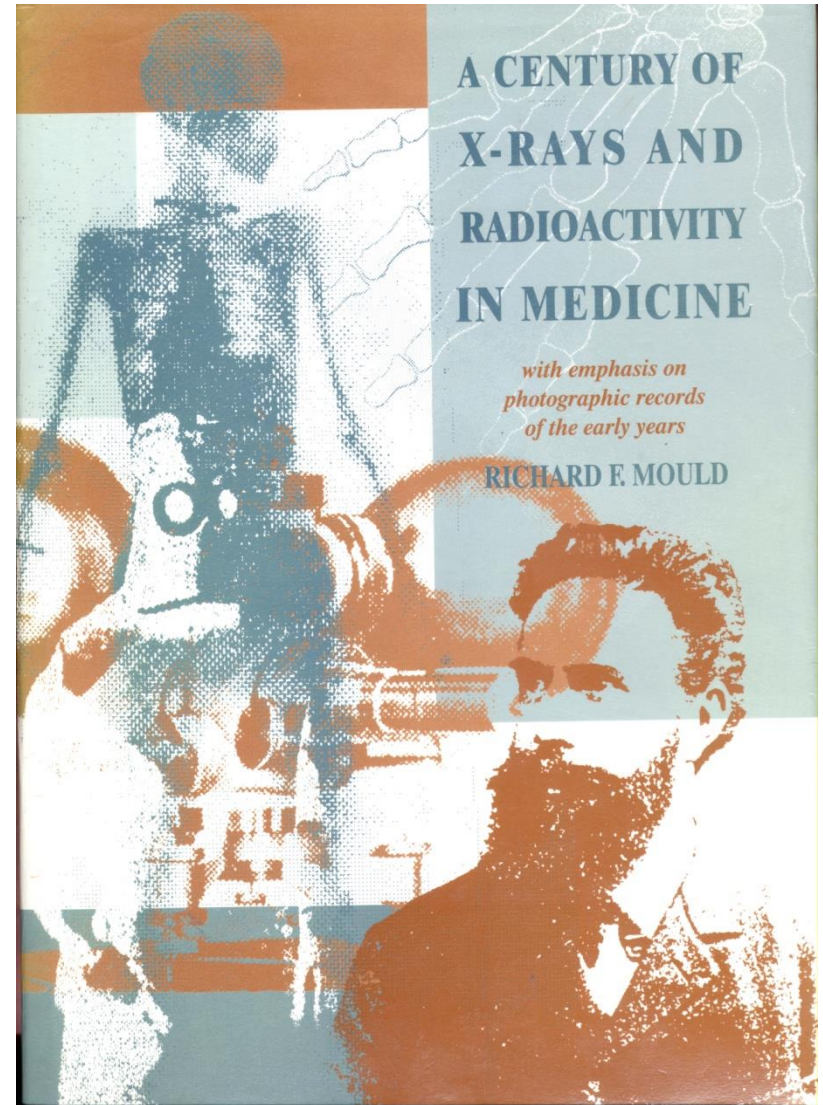

# Tools for (medical) physics: the cyclotron



1930

Invention of the cyclotron

**Ernest Lawrence**

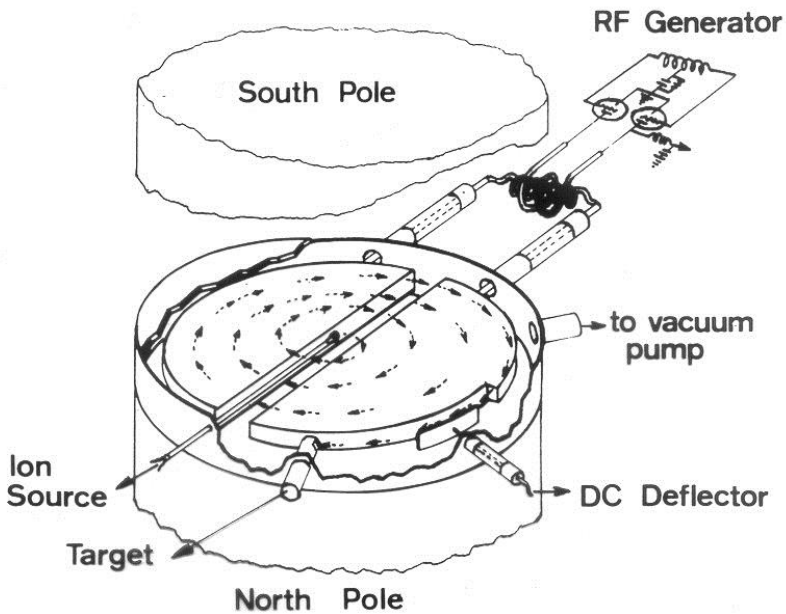



# The beginnings of modern physics and of medical physics



**James Chadwick**  
**(1891 – 1974)**

1932

## Discovery of the neutron

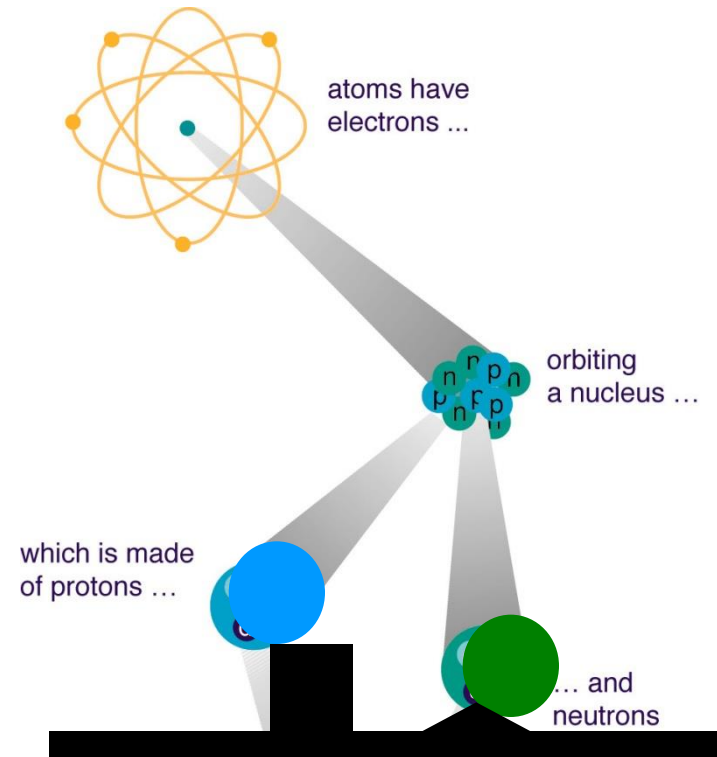

**Cyclotron + neutrons = first attempt of radiation therapy with fast neutrons at LBL (R. Stone and J. Lawrence, 1938)**

# The beginnings of modern physics and of medical physics

1932

Discovery of the positron

**C. D. Anderson**

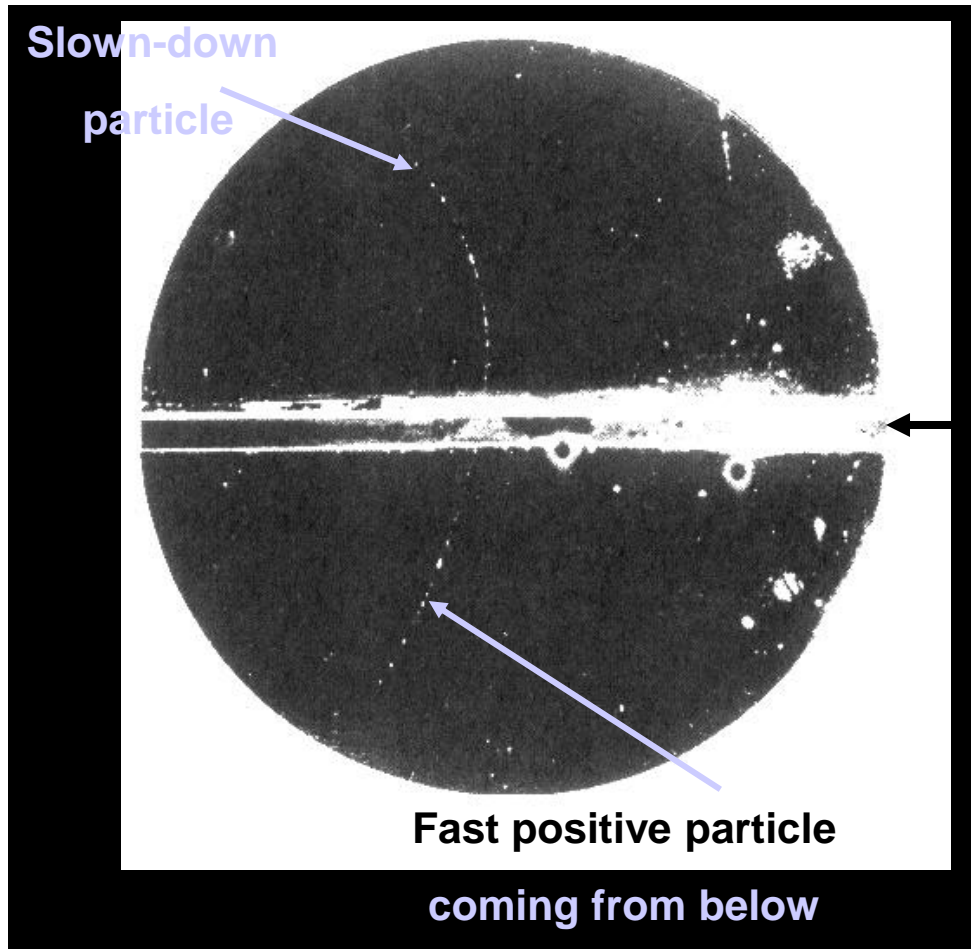

Layer of lead

Inserted in a cloud chamber

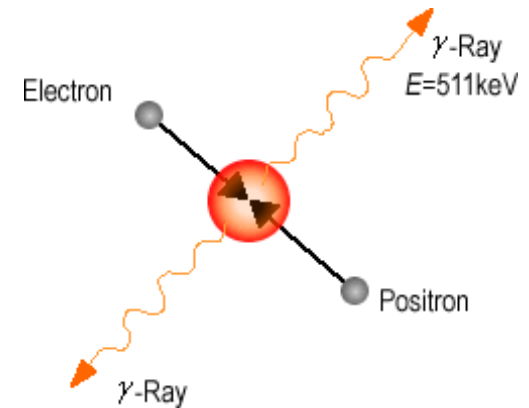

## Historical development of radioisotopes for medicine

---

- **1932:** the invention of the cyclotron by E. Lawrence makes it possible to produce radioactive isotopes of a number of biologically important elements
- **1941:** first medical cyclotron installed at Washington University, St Louis, for the production of radioactive isotopes of phosphorus, iron, arsenic and sulphur
- **After WWII:** following the development of the fission process, most radioisotopes of medical interest begin to be produced in nuclear reactors
- **1951:** Cassen et al. develop the concept of the rectilinear scanner
- **1957:** the  $^{99}\text{Mo}/^{99\text{m}}\text{Tc}$  generator system is developed by the Brookhaven National Laboratory
- **1958:** production of the first gamma camera by Anger, later modified to what is now known as the Anger scintillation camera, still in use today

# Tools for (medical) physics: the electron linac

Sigmur Varian

William W. Hansen

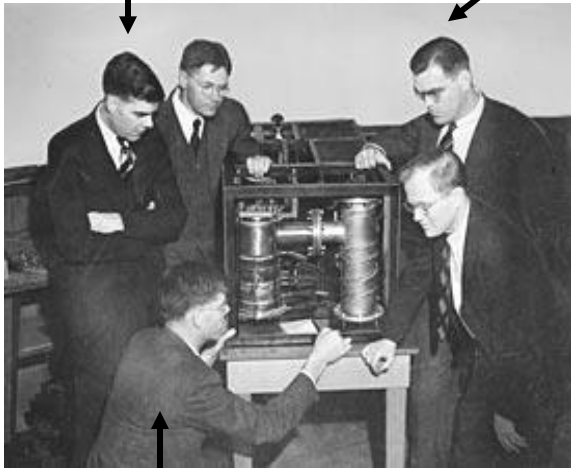

Russell Varian

1939

Invention of the klystron

**1950's: development of compact linear electron accelerators by various companies**

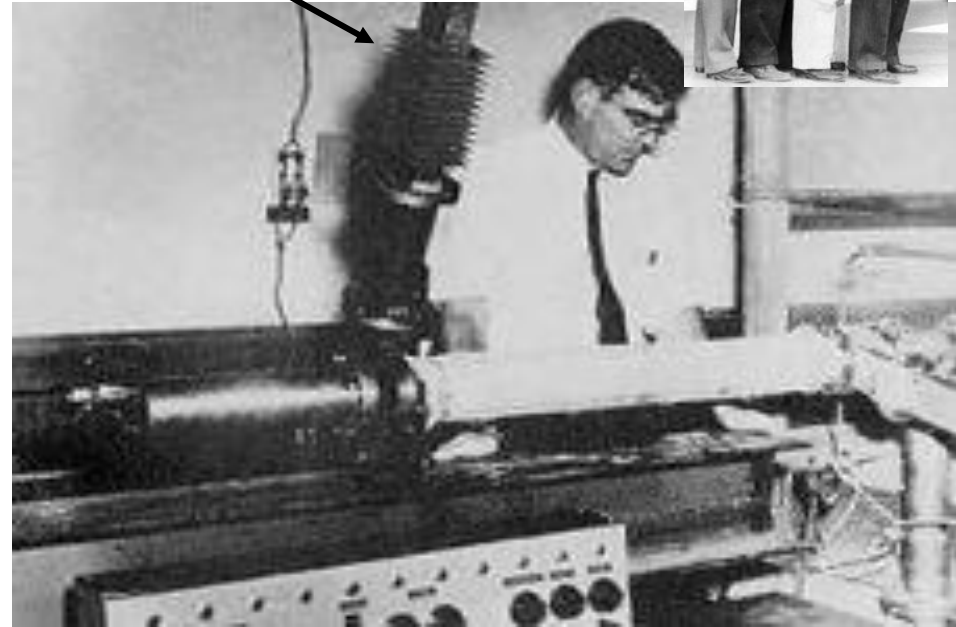

1947  
first linac for electrons  
4.5 MeV and 3 GHz

# Tools for (medical) physics: the synchrotron

**1945: E. McMillan and V.J.Veksler**

discover the  
principle of phase stability

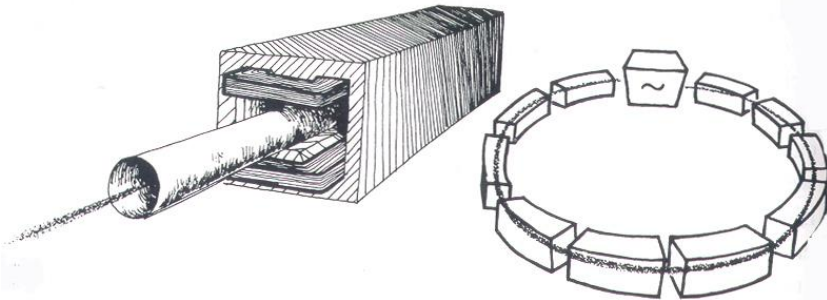

1 GeV electron synchrotron

Frascati - INFN - 1959

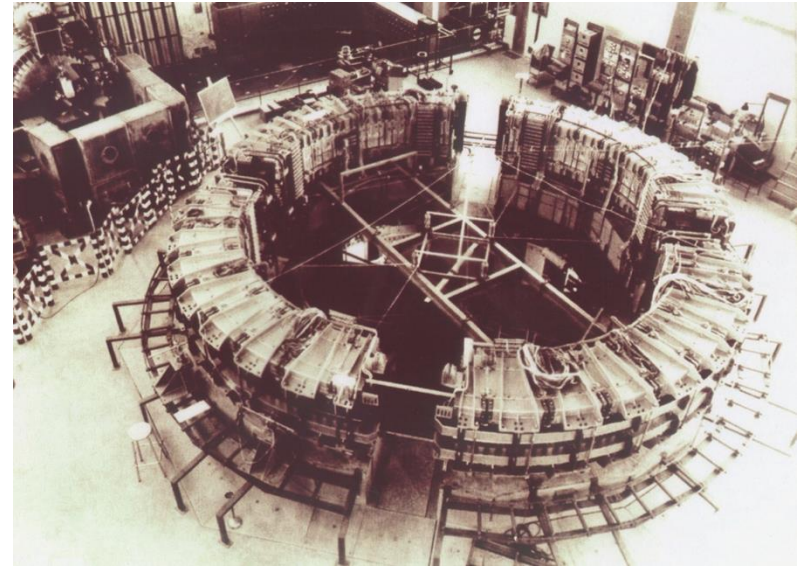

6 GeV proton synchrotron

Bevatron - Berkeley - 1954

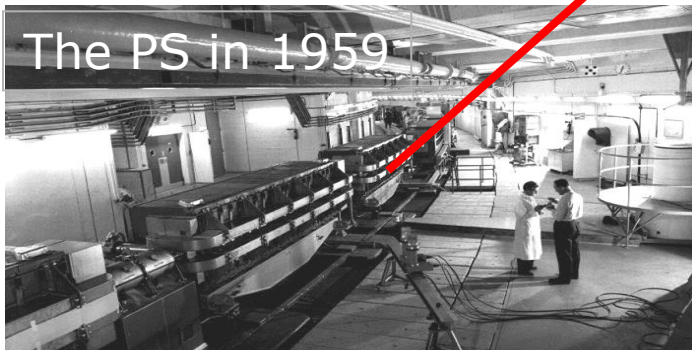
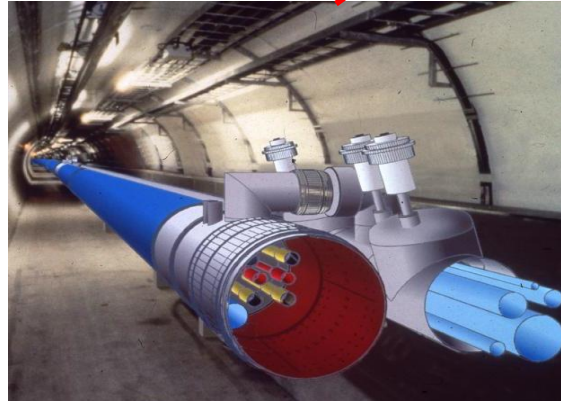
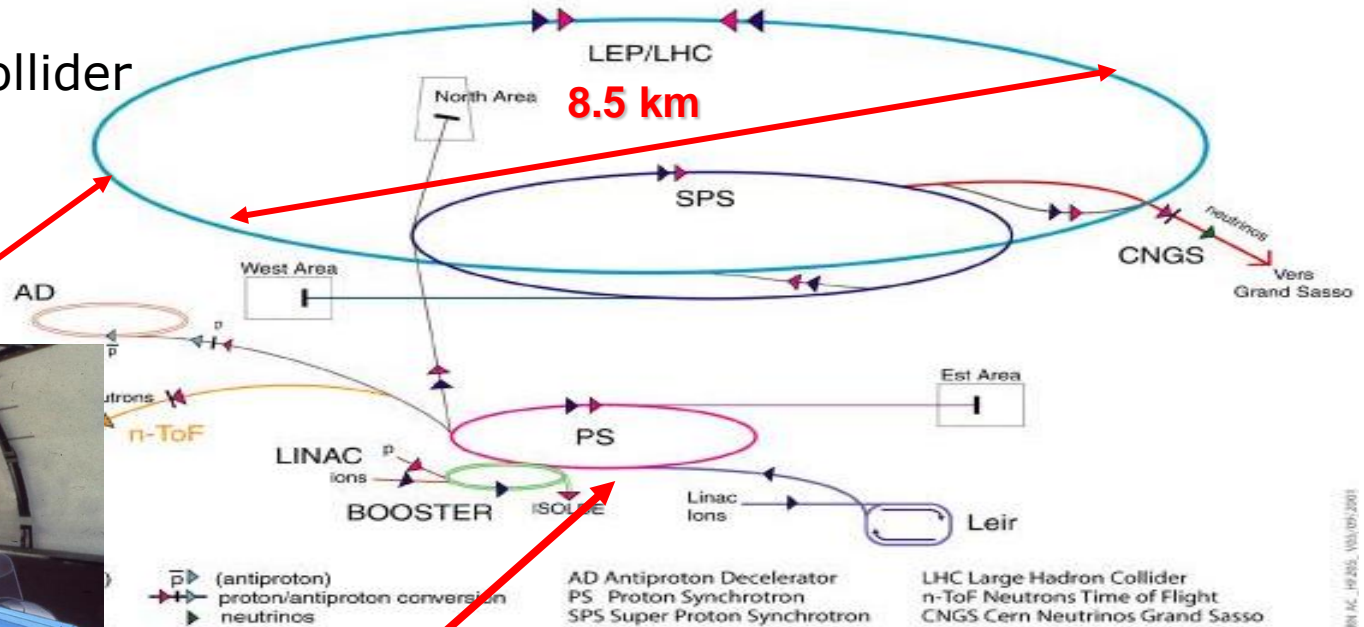

# CERN accelerators

Large Hadron Collider  
7 TeV + 7 TeV  
Start in 2008



In 1952 the "strong-focusing" method  
invented at BNL (USA)  
was chosen for the CERN PS

# Medical imaging

TECHNIQUE		YEAR	ENERGY	PHYSICAL PROPERTY	IMAGING
RADIOLOGY	X RAYS IMAGING	<b>1895</b>	X RAYS	ABSORPTION	
ECHOGRAPHY	ULTRASOUND IMAGING	1950	US	REFLECTION TRANSMISSION	
NUCLEAR MEDICINE	RADIOISOTOPE IMAGING	1950	$\gamma$ RAYS	RADIATION EMISSION	

# Medical imaging

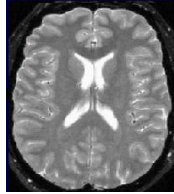
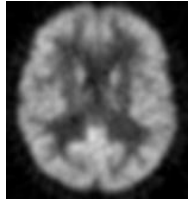
TECHNIQUE		YEAR	ENERGY	PHYSICAL PROPERTY	IMAGING	
X RAYS COMPUTERIZED TOMOGRAPHY	<b>CT</b>	<b>1971</b>	X RAYS	ABSORPTION		MORPHOLOGY
MAGNETIC RESONANCE IMAGING	MRI	1980	RADIO WAVES	MAGNETIC RESONANCE		MORPHOLOGY /FUNCTION
POSITRON EMISSION TOMOGRAPHY	PET	1973	$\gamma$ RAYS	RADIATION EMISSION		FUNCTION



# Medical imaging: x-ray generator and image intensifier

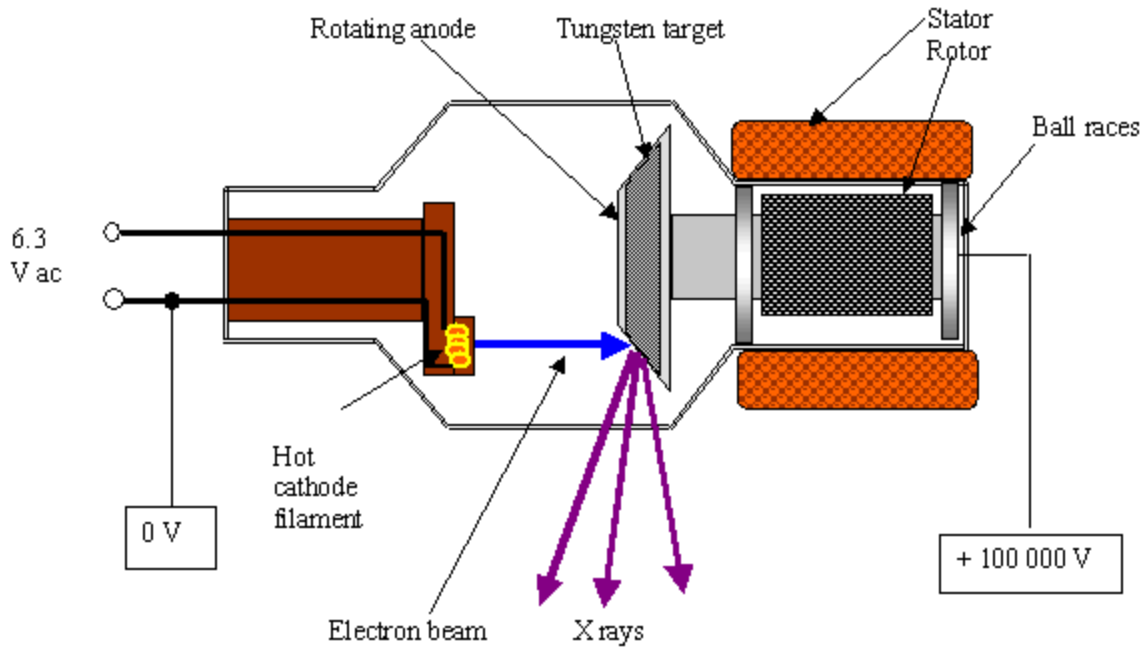

X-ray tube

Image intensifier

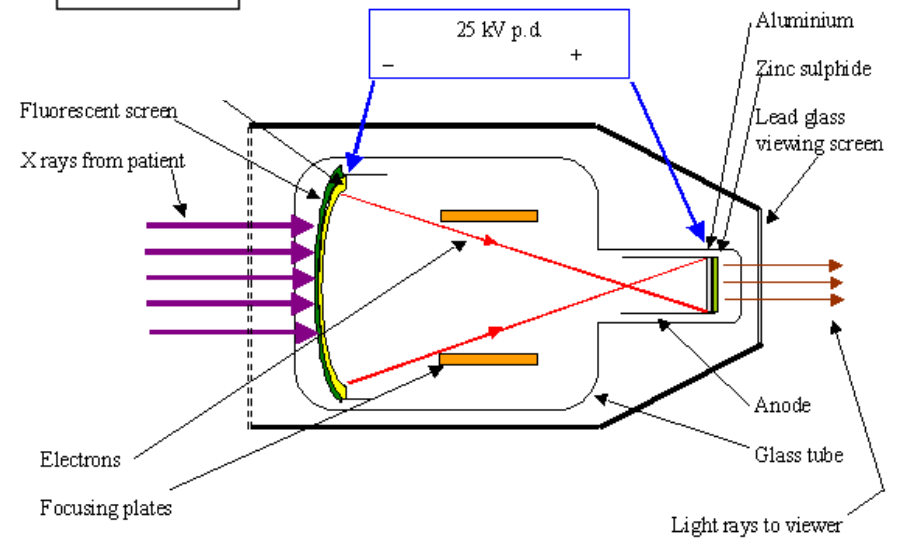

# Emission versus transmission imaging

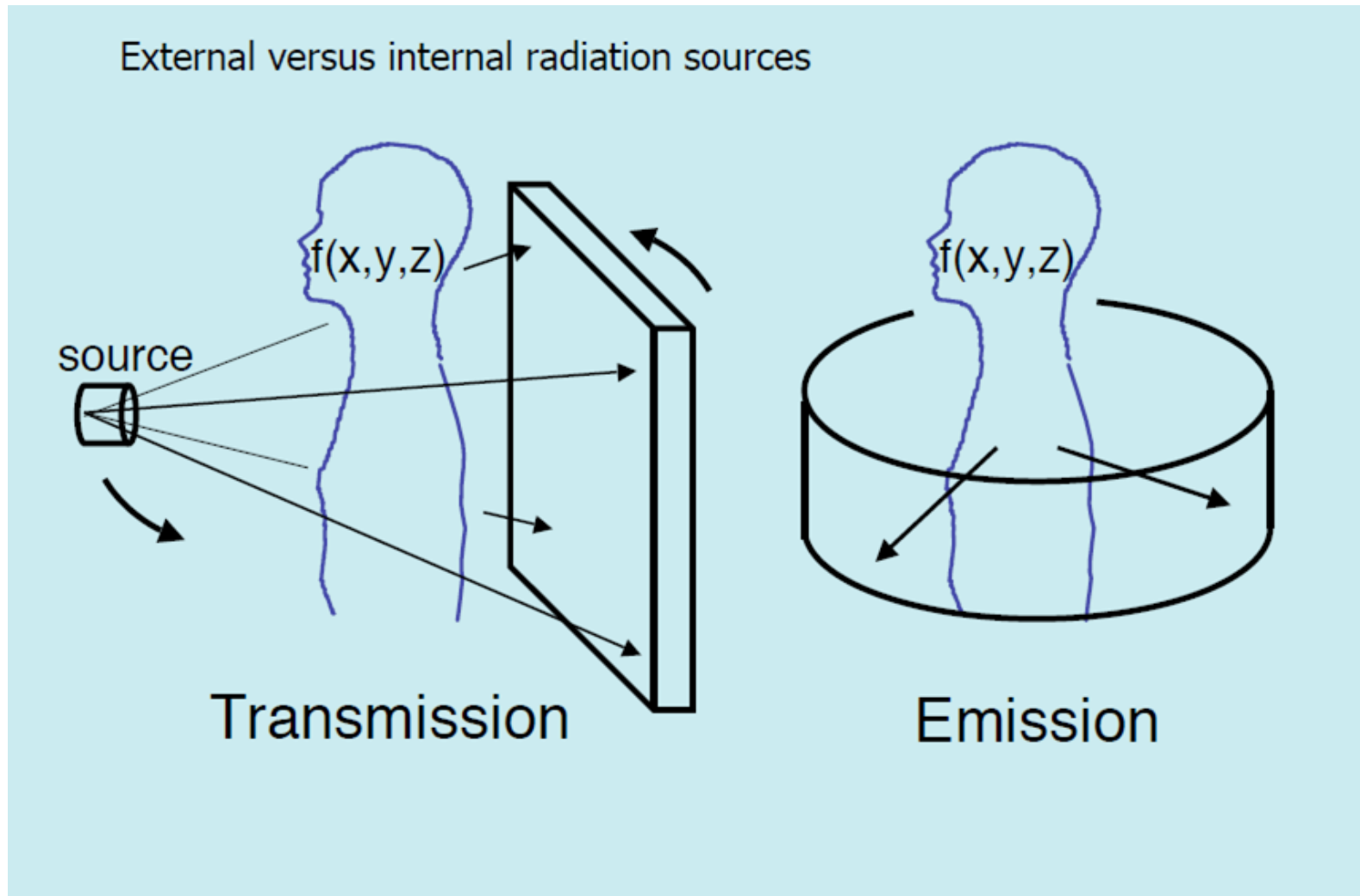

## X-ray image versus CT scan

A conventional X-ray image is basically a **shadow**: you shine a “light” on one side of the body, and a piece of film on the other side registers the silhouette of the bones (to be more precise, **organs and tissues of different densities show up differently on the radiographic film**).

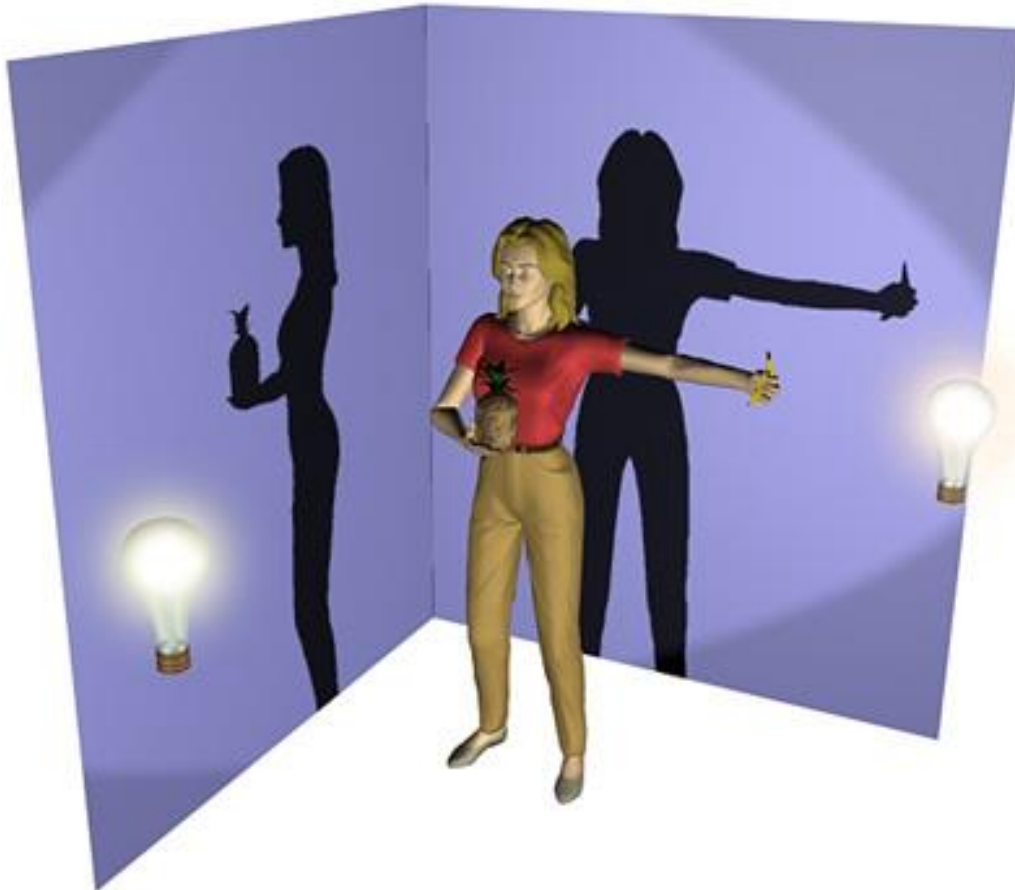

**Shadows give an incomplete picture of an object's shape.**

Look at the wall, not at the person. If there's a lamp in front of the person, you see the silhouette holding the banana, but not the pineapple as the shadow of the torso blocks the pineapple. If the lamp is to the left, you see the outline of the pineapple, but not the banana.

© 2002 HowStuffWorks

# Computed tomography

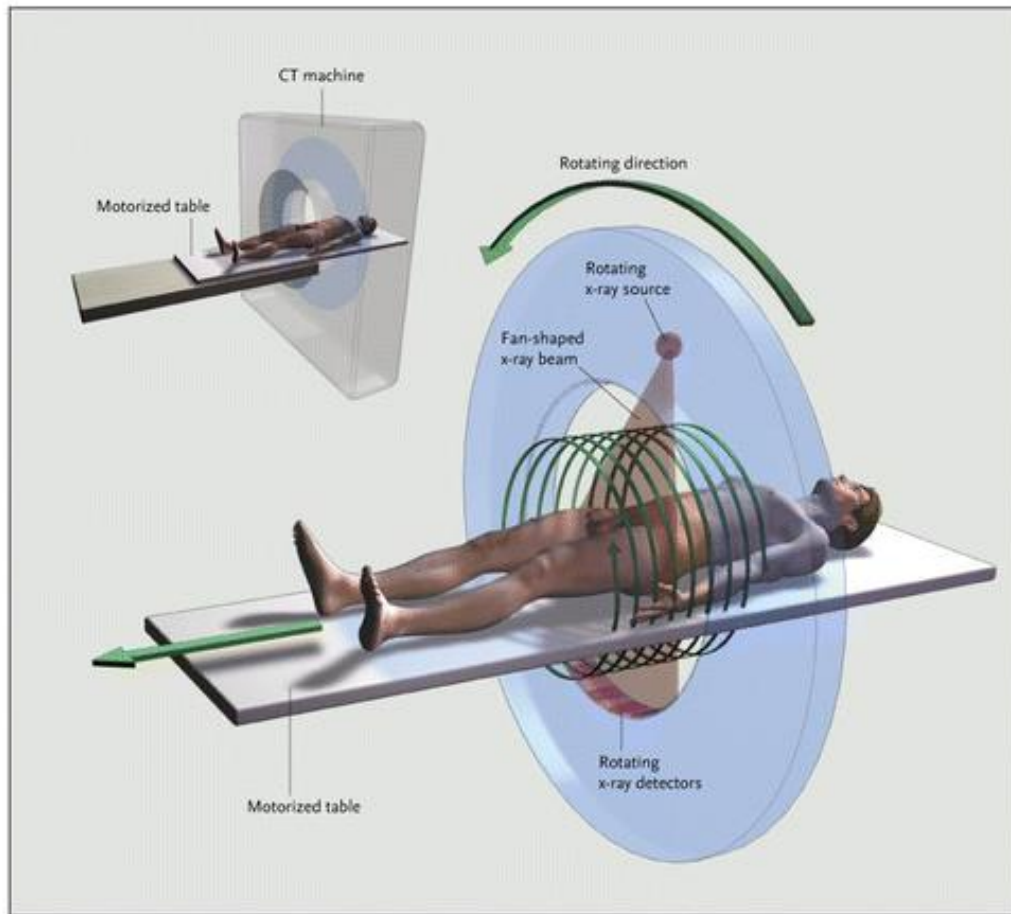

- The X-rays source rotates around the longitudinal axis of the body: it moves  $360^\circ$  around the patient, scanning from hundreds of different angles
- Opposite to the x-ray source, a series of detectors measure the radiation emerging from the body
- Each rotation scans a different body slice
- The couch moves to scan the next slice
- A computer analyses the data and reconstructs the **3D image** through mathematical algorithms.

# X-ray computerized tomography (CT)

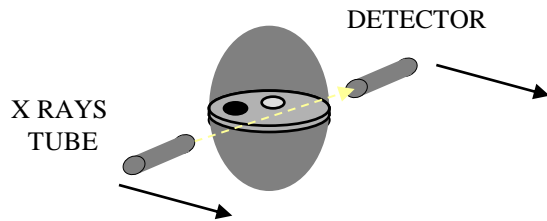

**A – LINEAR SAMPLING**

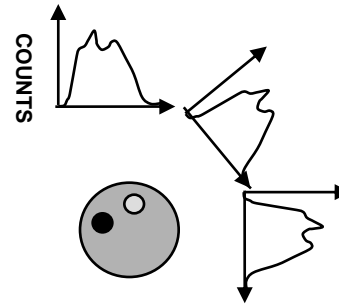

**B – ANGULAR SAMPLING**

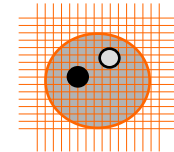

**C - RECONSTRUCTION**

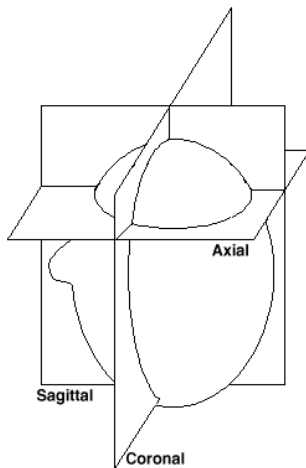

**X RAYS  
COMPUTERIZED TOMOGRAPHY**

# Volumetric CT

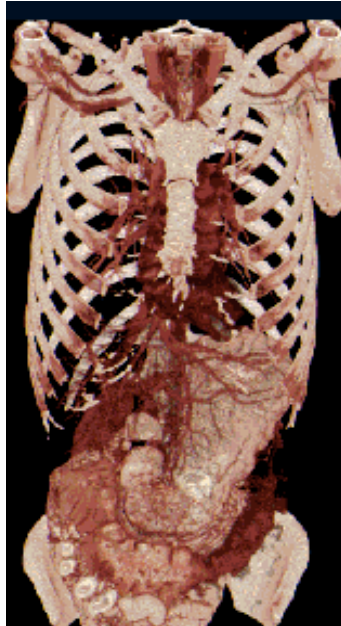
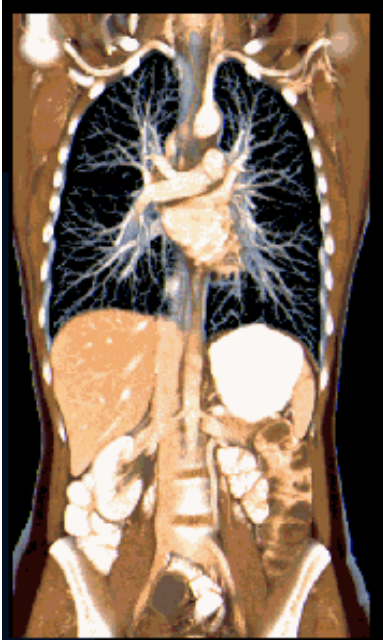

< 0.4 sec/rotation  
Organ in a sec (17 cm/sec)  
Whole body < 10 sec

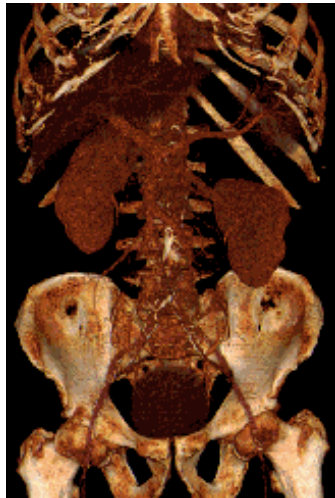
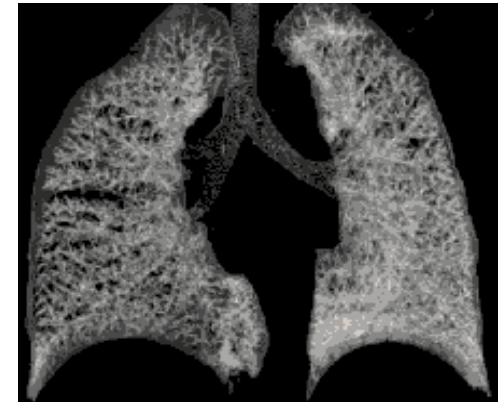
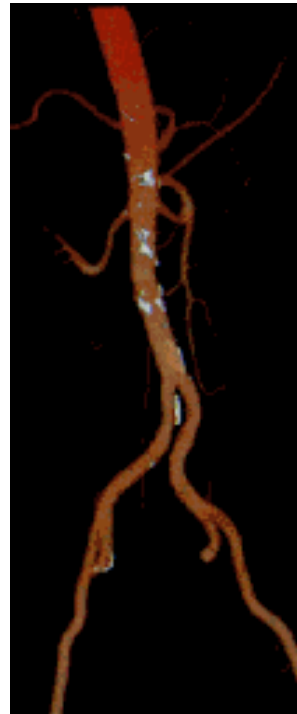

# Cardiac CT

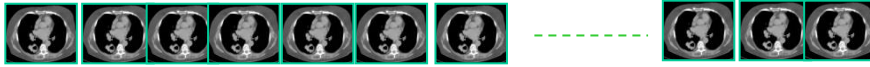

DYNAMIC CT ACQUISITION



ECG

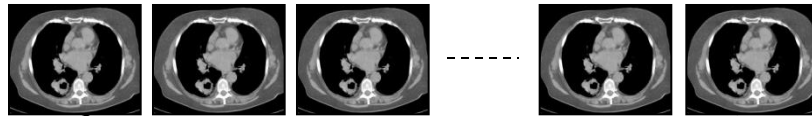

PHASES OF A CARDIAC CYCLE

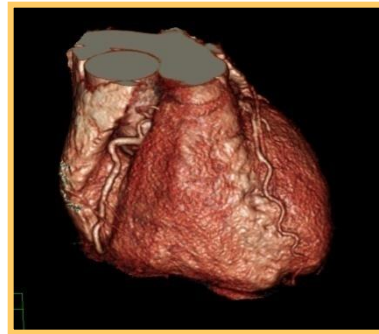
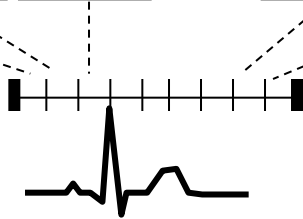

- EJECTION FRACTION
- CARDIAC OUTPUT
- REGIONAL WALL MOTION
- ..

FUNCTIONAL PARAMETERS

VOLUME RENDERED IMAGE OF HEART AND VESSELS

All **radionuclides** commonly administered to patients in nuclear medicine are *artificially* produced

Three production routes:

- **(n,  $\gamma$ ) reactions (nuclear reactor)**: the resulting nuclide has the same chemical properties as those of the target nuclide
- **Fission (nuclear reactor)** followed by separation
- **Charged particle induced reaction (cyclotron)**: the resulting nucleus is usually that of a different element



# Positron Emission Tomography (PET)

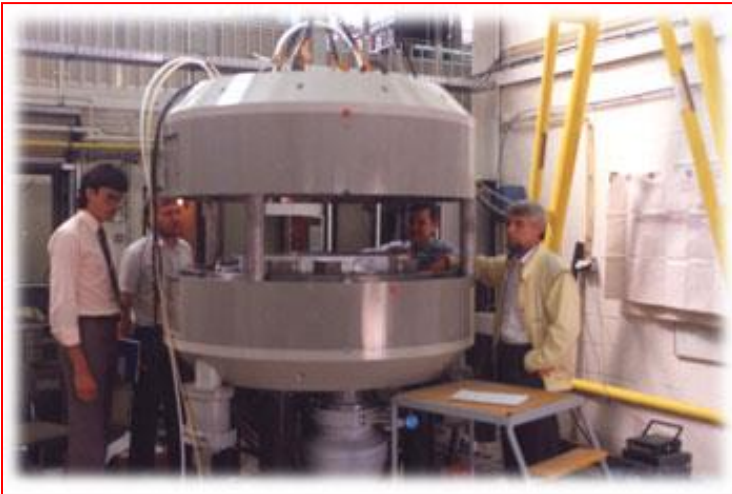

Cyclotron

Radiochemistry



ISOTOPES	Half-Life	
11-C	20.4 min,	"natural"
13-N	10.0 min	"natural"
15-O	2.0 min	"natural"
18-F	109.8 min	"pseudo-natural"

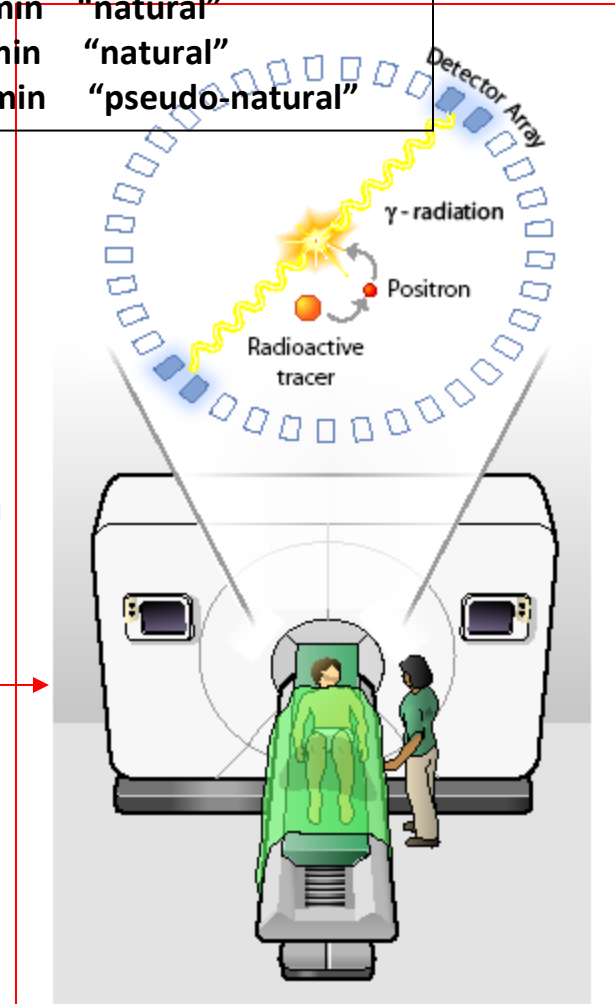

# Positron Emission Tomography (PET)

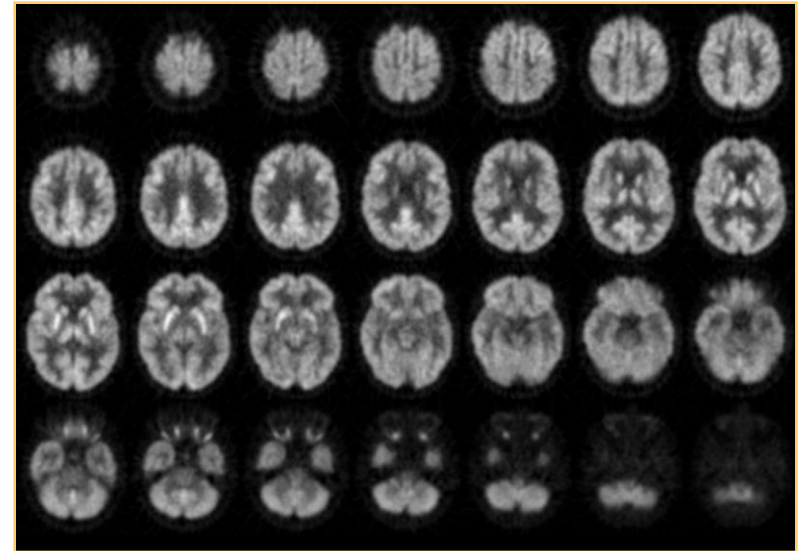
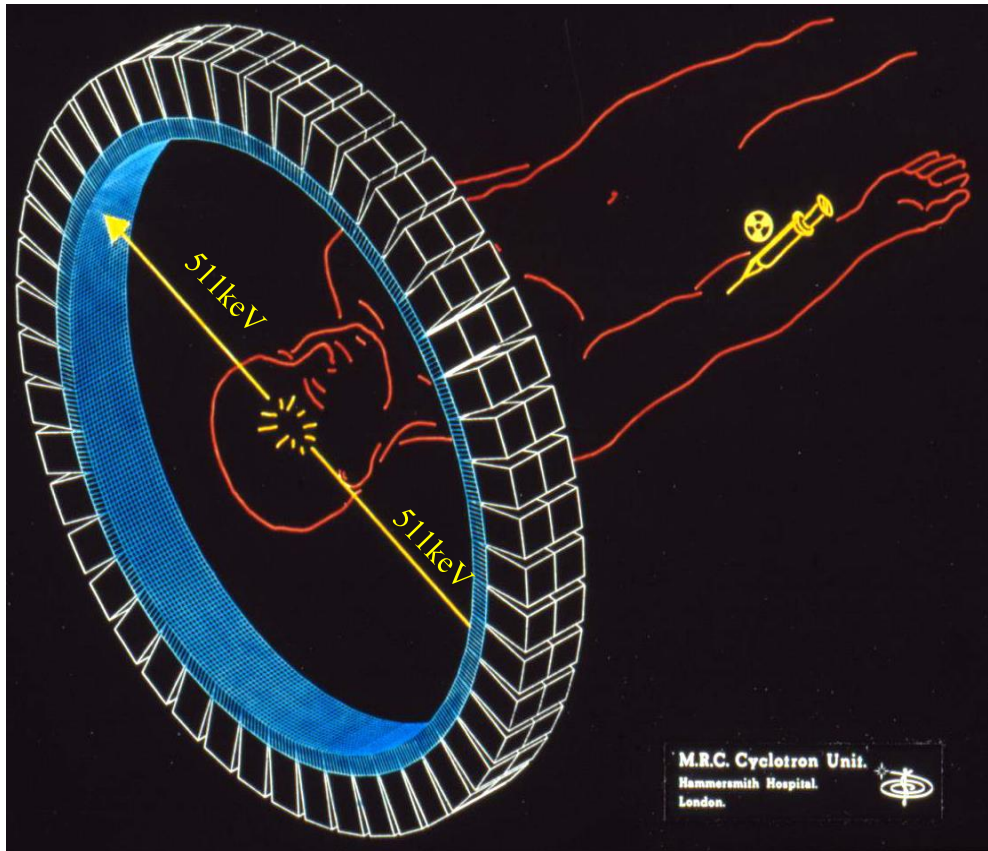

COVERAGE:

~ 15-20 cm

SPATIAL RESOLUTION:

~ 5 mm

SCAN TIME to cover an entire organ:

~ 5 min

CONTRAST RESOLUTION:

depends on the radiotracer

# PET functional receptor imaging

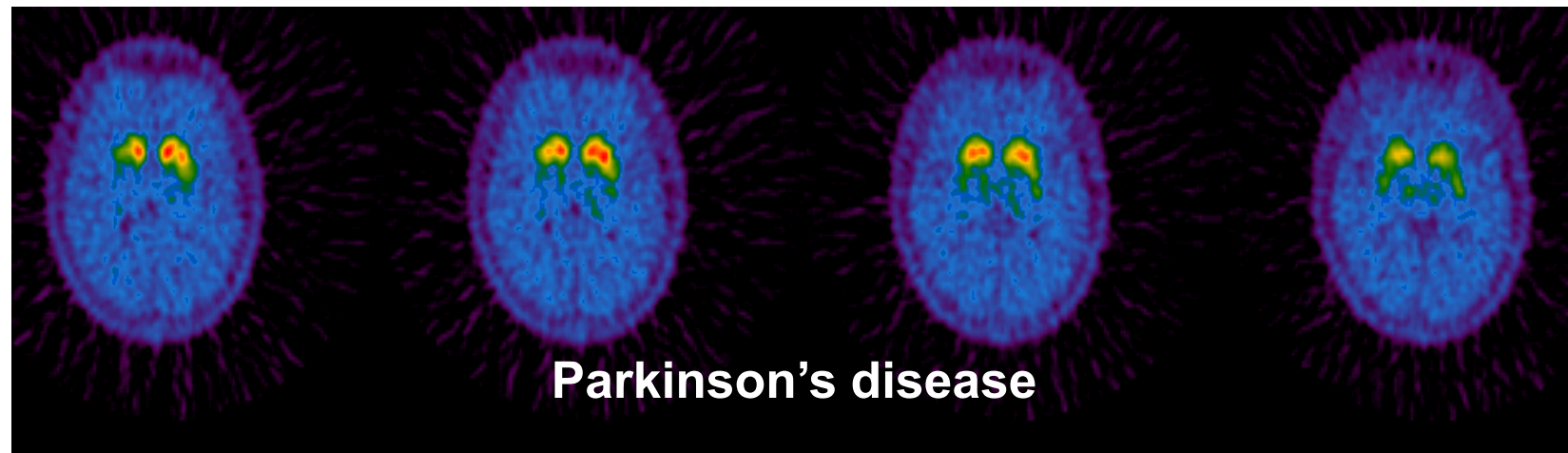
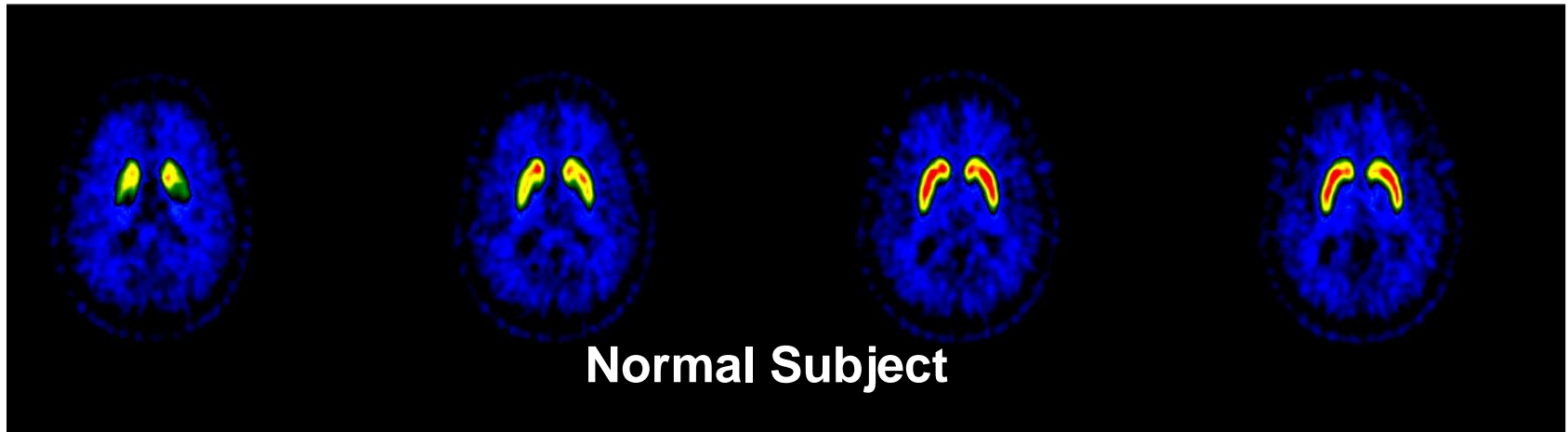

**[<sup>11</sup>C] FE-CIT**

Courtesy HSR MILANO

# PET coverage and axial sampling

---

## FIRST GENERATION PET

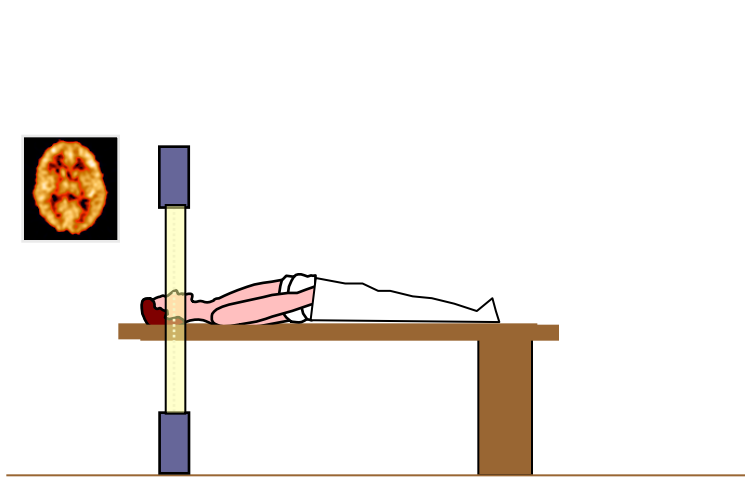

1 SLICE – 2 cm

## CURRENT GENERATION PET

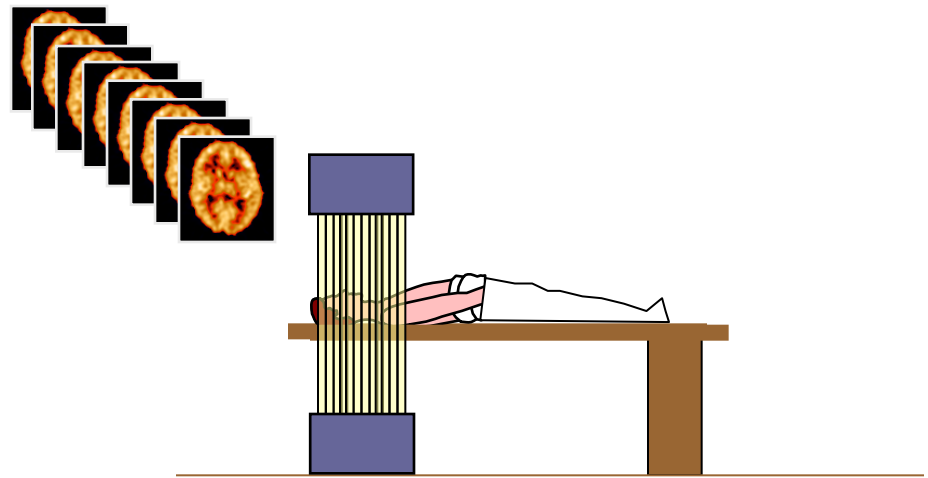

> 40 SLICES – 6 mm  
Axial FOV: 15 – 20 cm

# PET: total body studies

TRANSAXIAL  
IMAGES

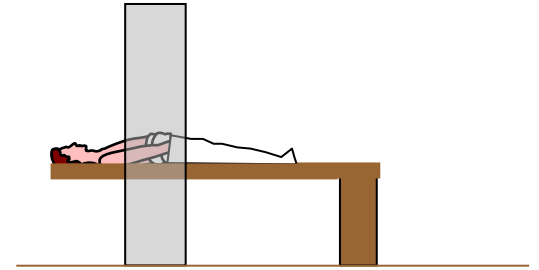
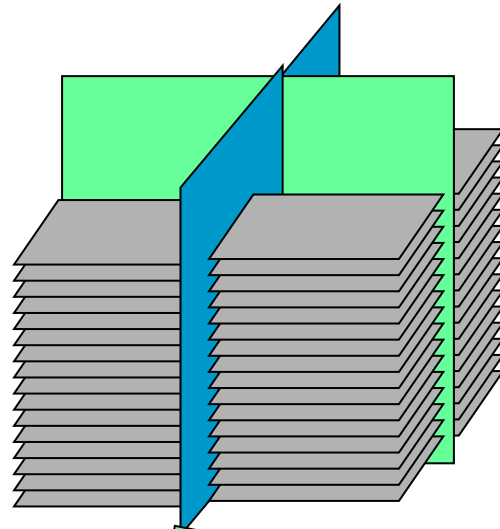

CORONAL

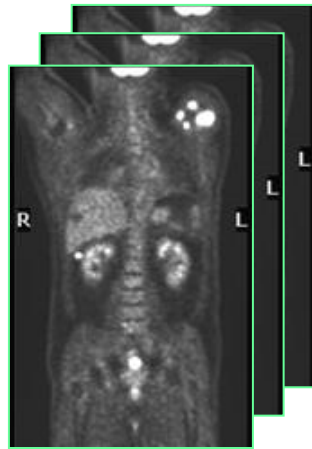

SAGITTAL

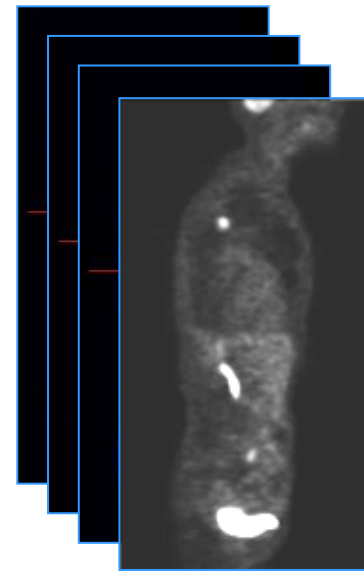

# PET/CT scanner

---

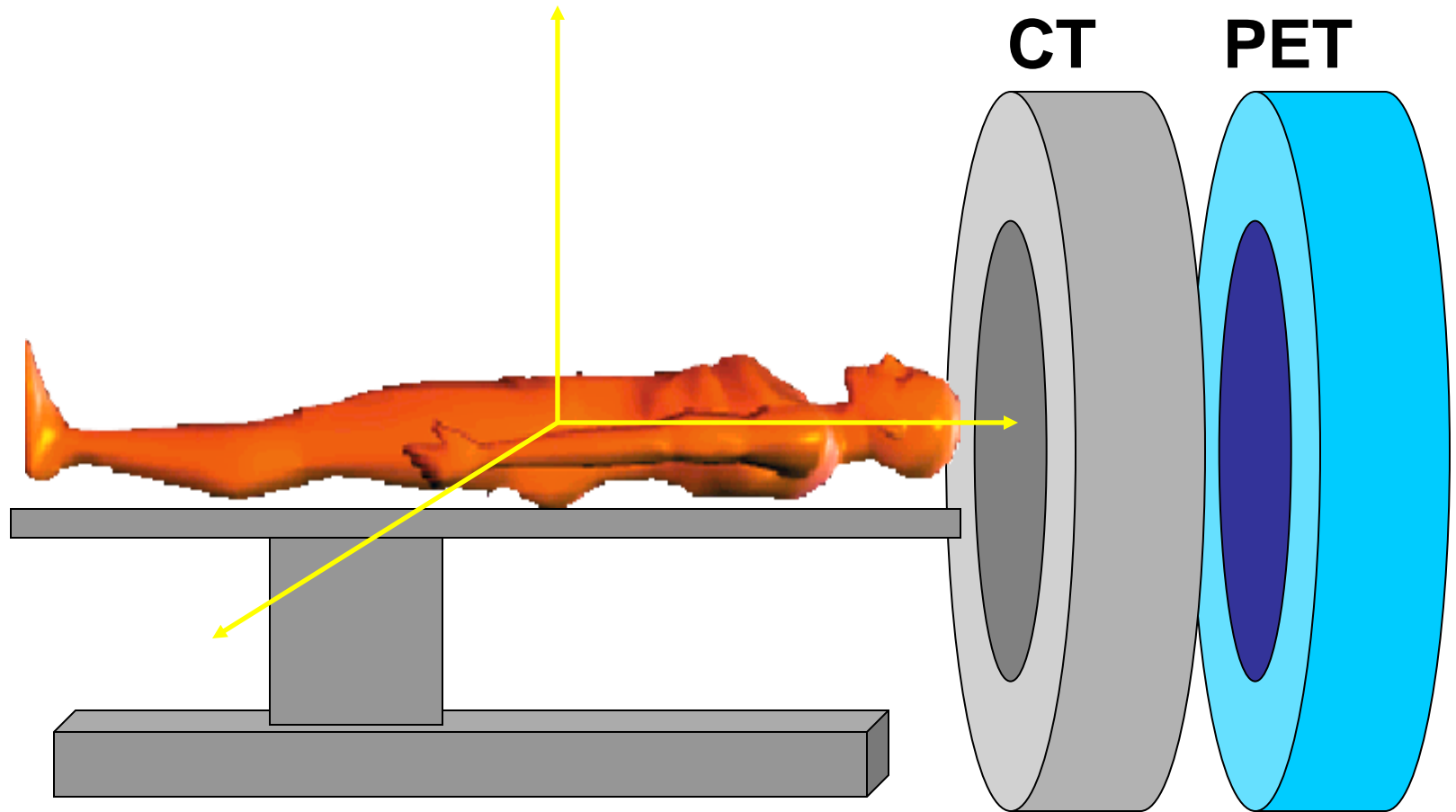

# PET/CT scanner

---

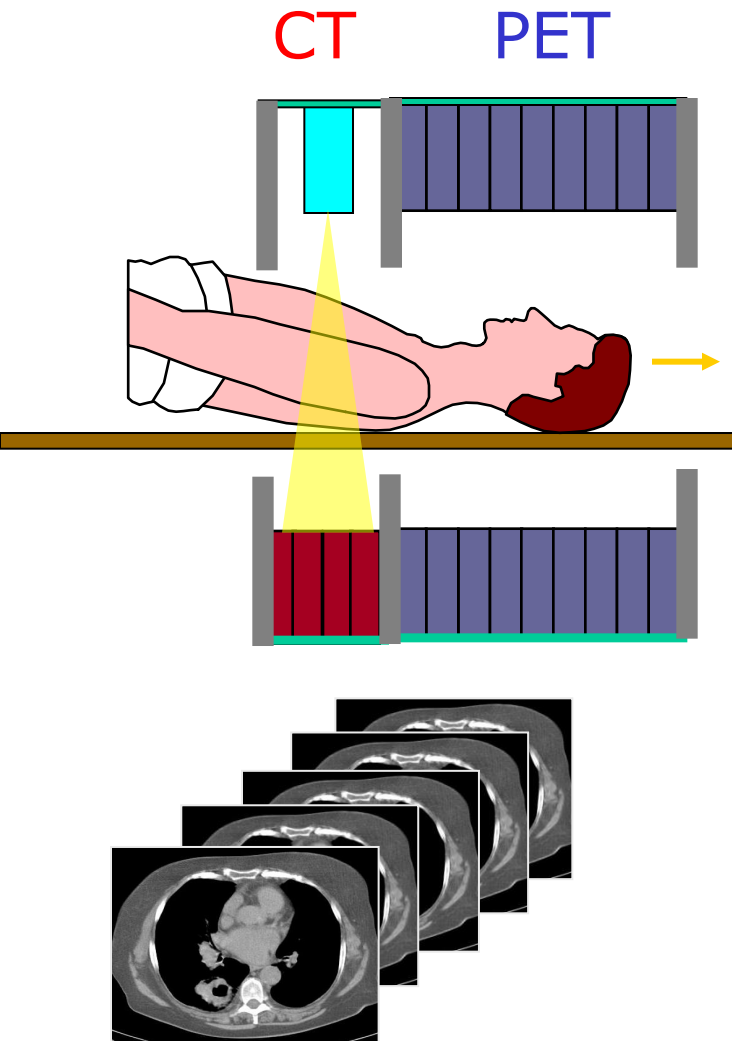

Courtesy HSR MILANO

# PET/CT scanner

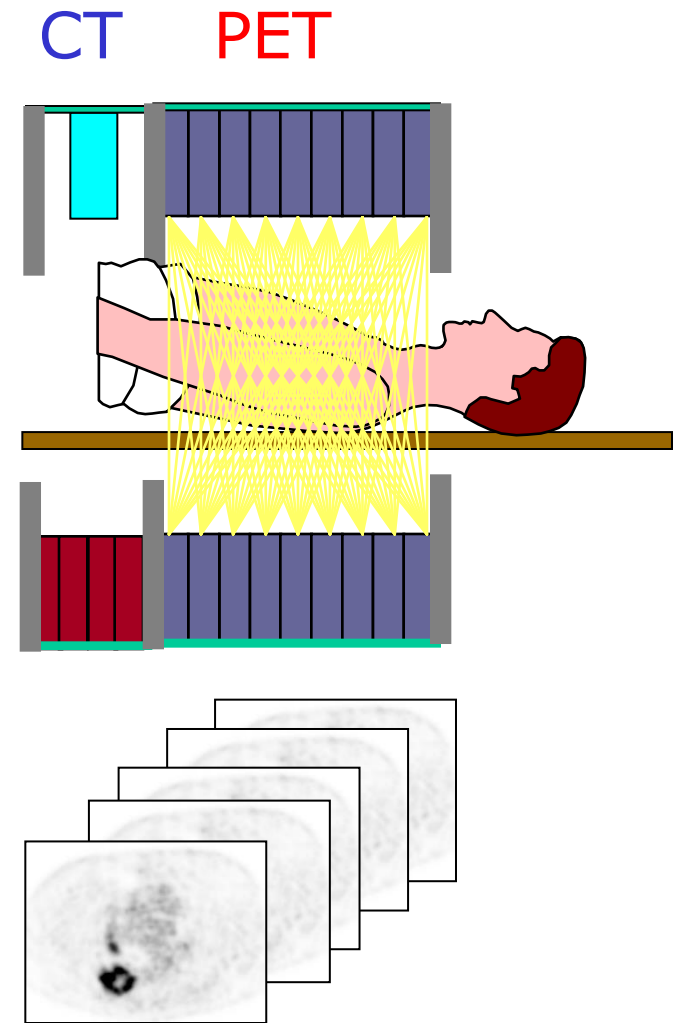
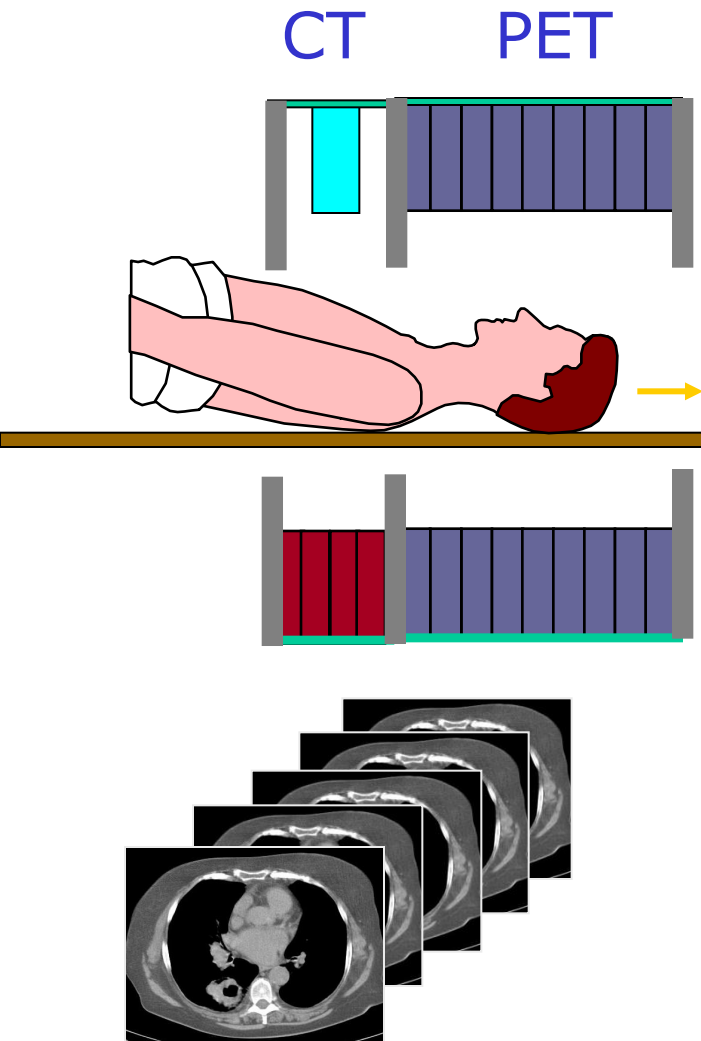

Courtesy HSR MILANO



# $^{18}\text{F}$ -FDG PET/CT

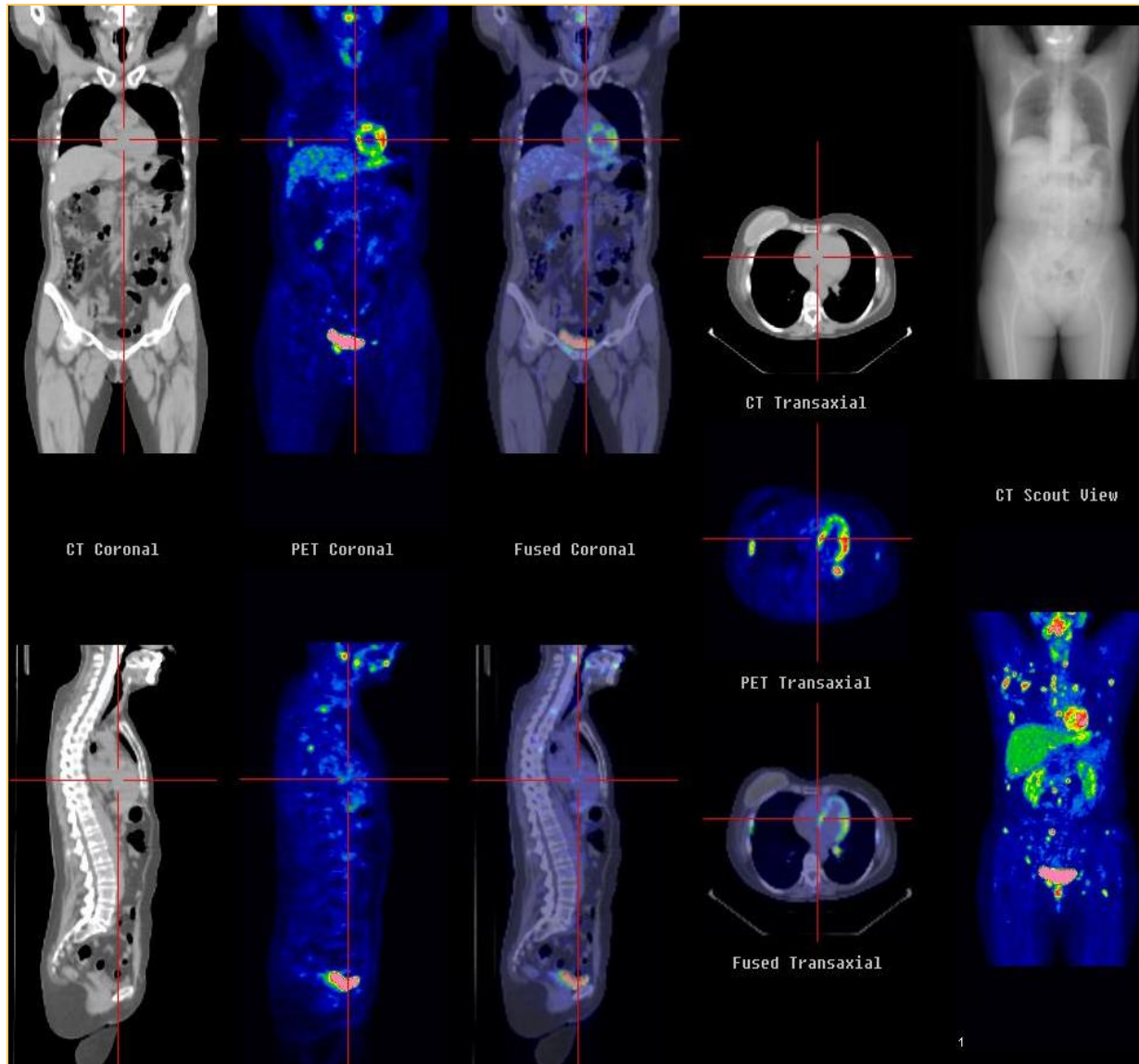

Courtesy HSR MILANO

# Summary of accelerators running in the world

## Three main applications

- 1) Scientific research
- 2) **Medical applications**
- 3) Industrial uses

CATEGORY OF ACCELERATORS	NUMBER IN USE (*)
High-energy accelerators ( $E > 1$ GeV)	~ 120
Synchrotron radiation sources	> 100
<b>Medical radioisotope production</b>	~ 1,000
<b>Accelerators for radiation therapy</b>	> 7,500
Research accelerators including biomedical research	~ 1,000
Industrial processing and research	~ 1,500
Ion implanters, surface modification	> 7,000
<b>TOTAL</b>	<b>&gt; 18,000</b>

Adapted from “Maciszewski, W. and Scharf, W., *Particle accelerators for radiotherapy, Present status and future*, Physica Medica XX, 137-145 (2004)”

# Three classes of medical accelerators

Electron linacs for conventional radiation therapy, including advanced modalities:

- Cyberknife
- IntraOperative RT (IORT)
- Intensity Modulated RT



Low-energy cyclotrons for production of radionuclides for medical diagnostics

Medium-energy cyclotrons and synchrotrons for hadron therapy with protons (250 MeV) or light ion beams (400 MeV/u  $^{12}\text{C}$ -ions)

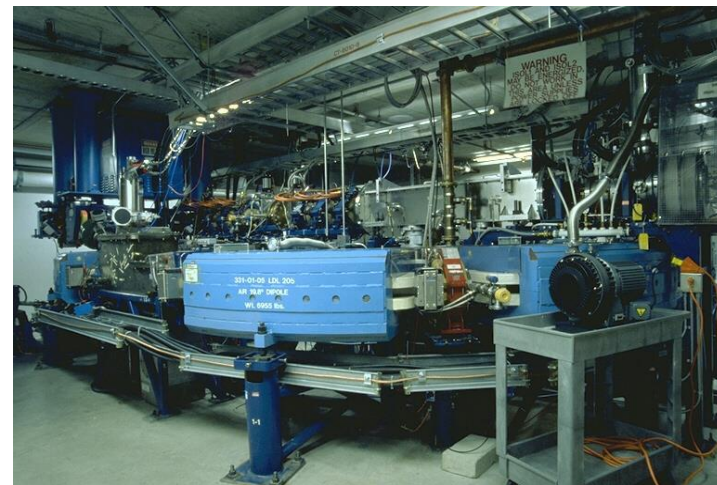

# Availability of radiation therapy worldwide

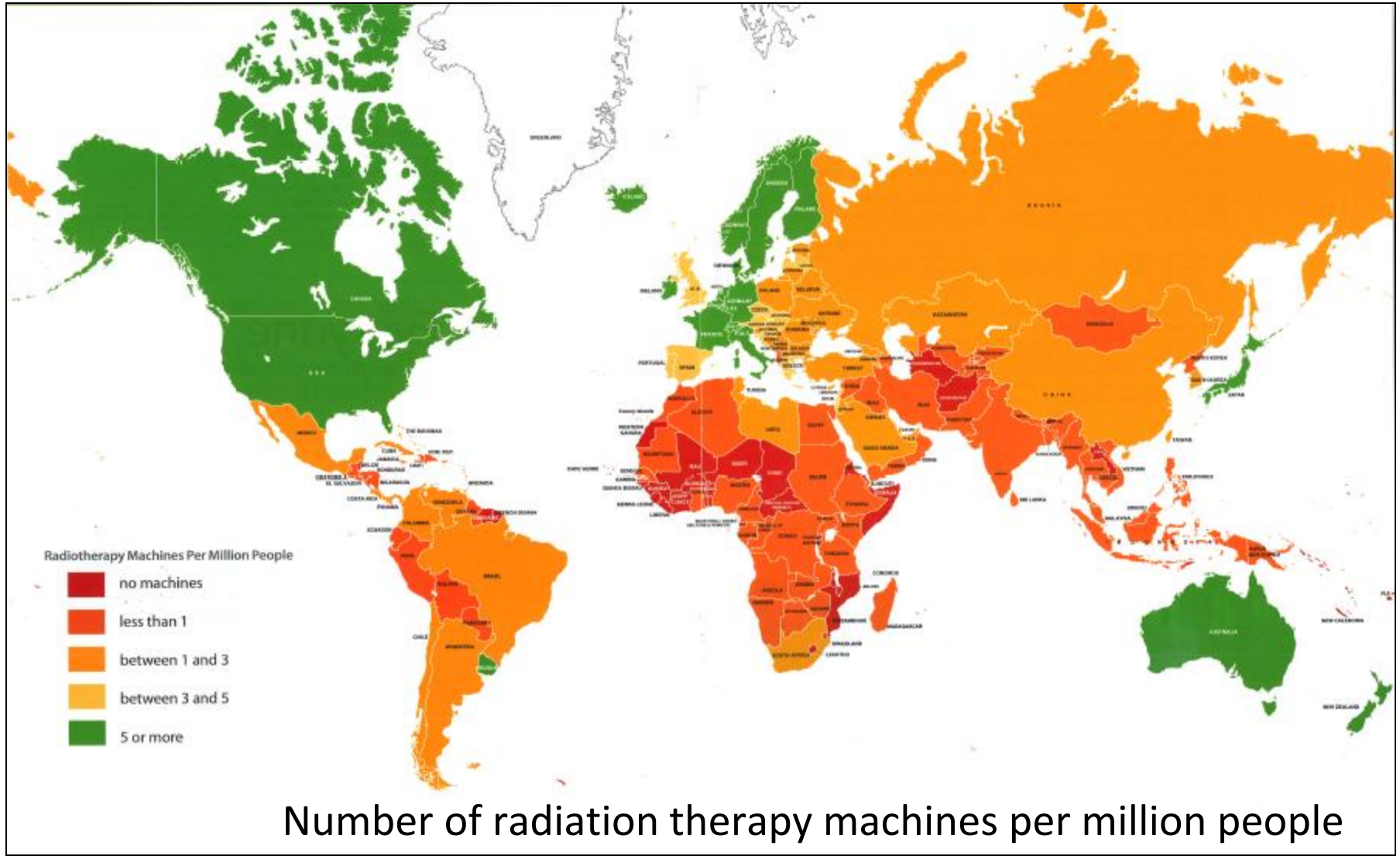

# Treatment planning and dose delivery to tumour volume

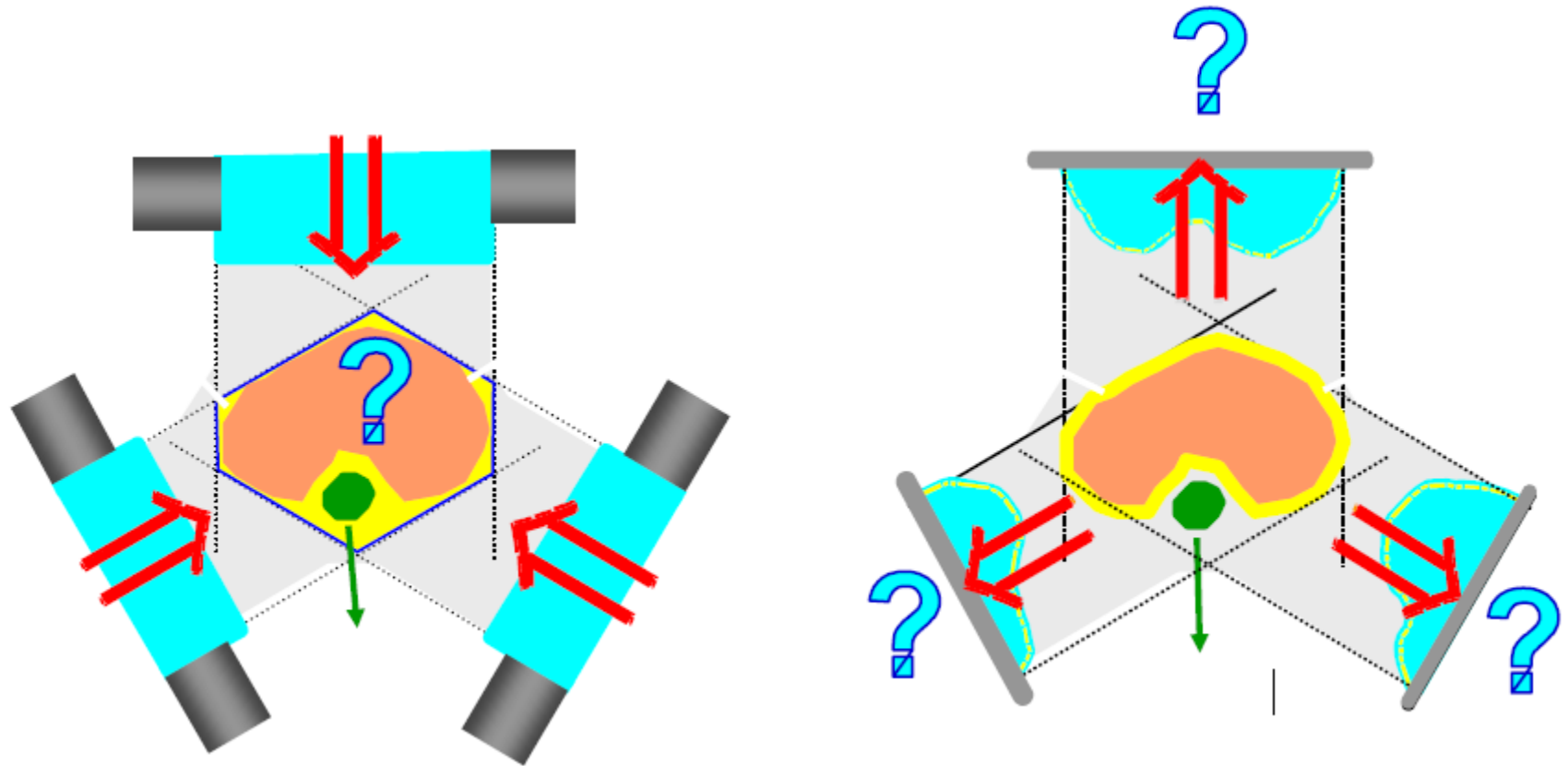

# Tumour control and therapeutic window

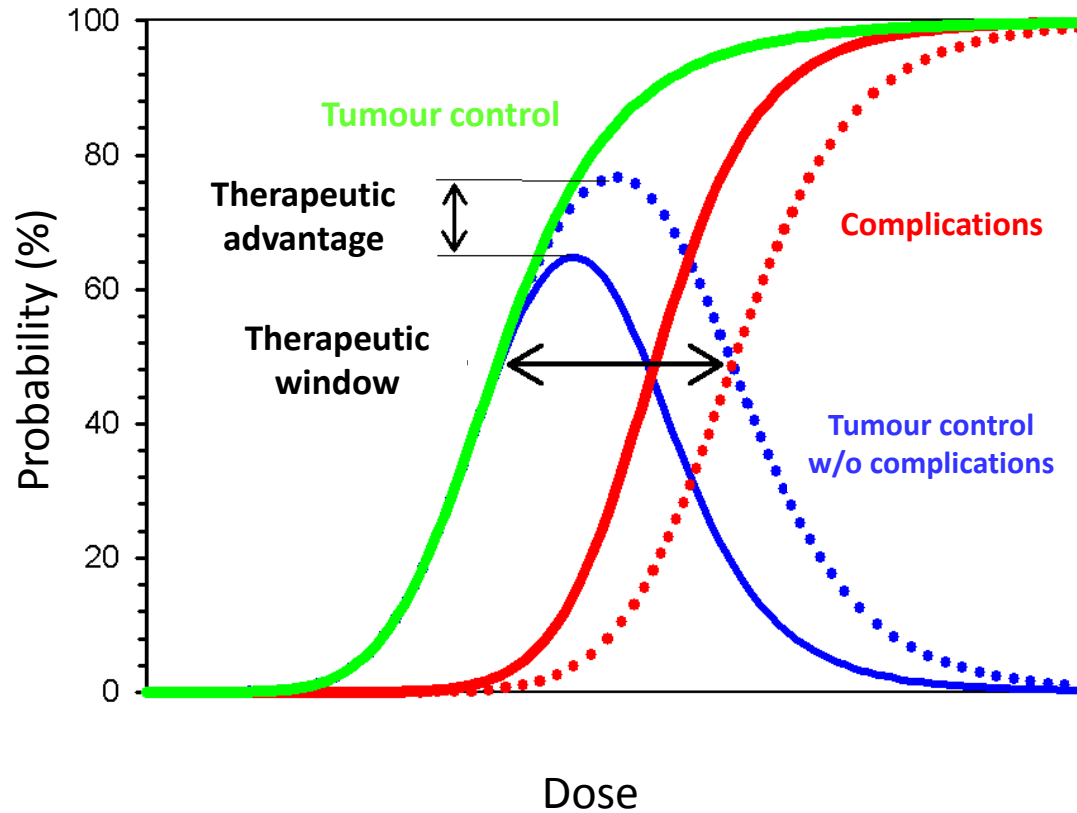

# X-rays in radiation therapy: medical electron linacs

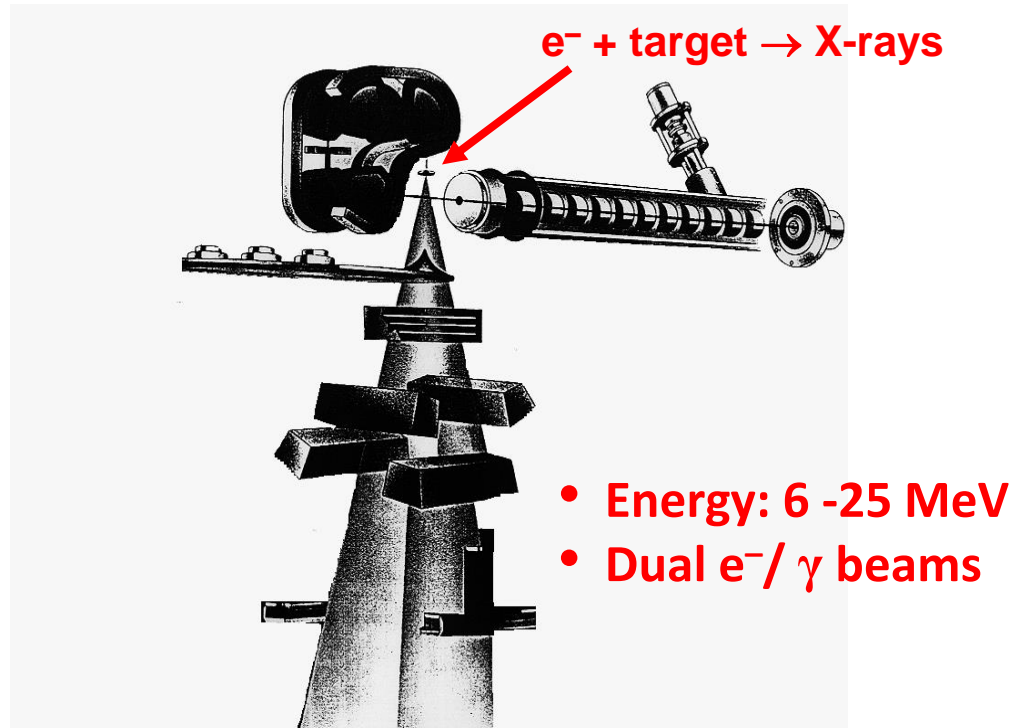
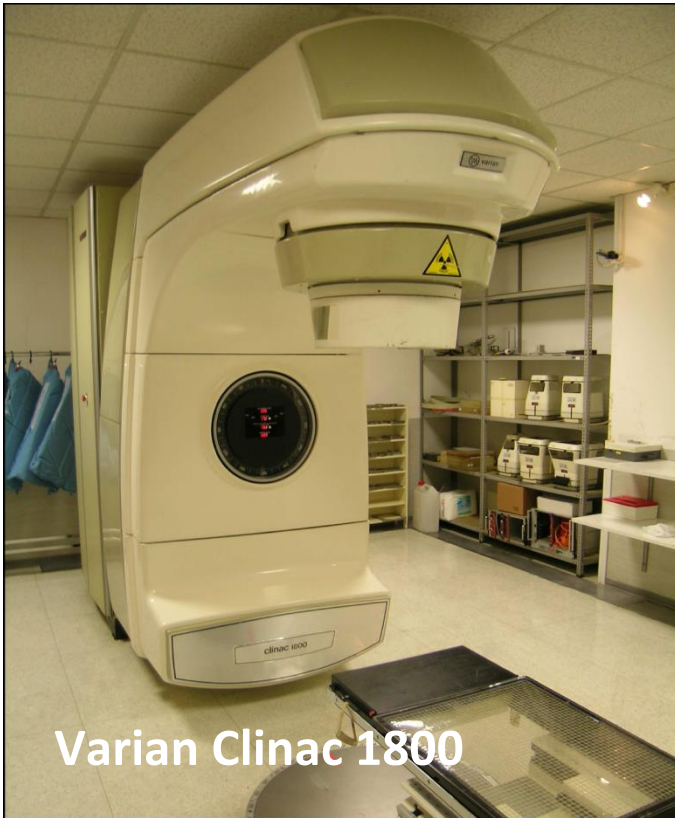

Multi-leaf collimator

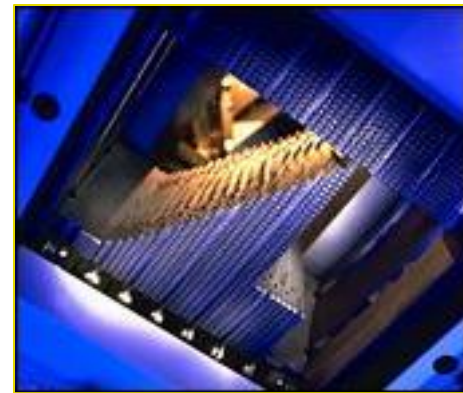

# Intra-Operative Radiation Therapy (IORT)

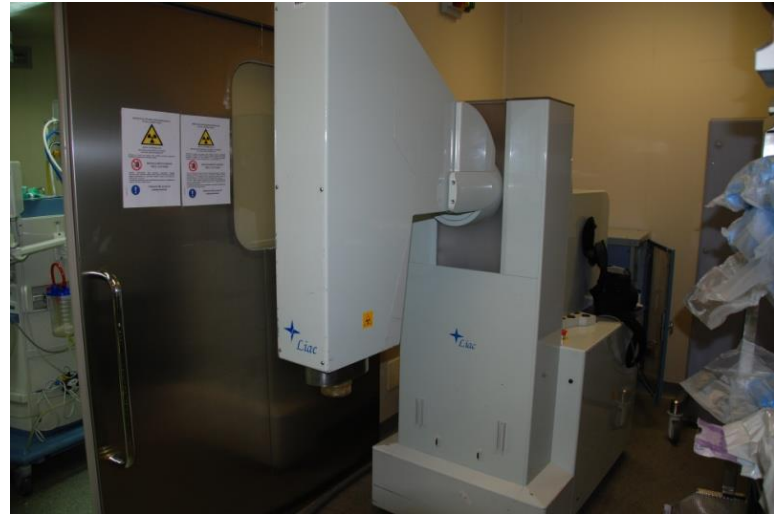

- Small electron linac
- Energy 6 – 12 MeV
- Treatment with electrons only
- Single irradiation
- Three models of linac produced by three manufacturers (two in Italy)





# CyberKnife (CK) Robotic Surgery System

6 MV Linac mounted on a robotic arm

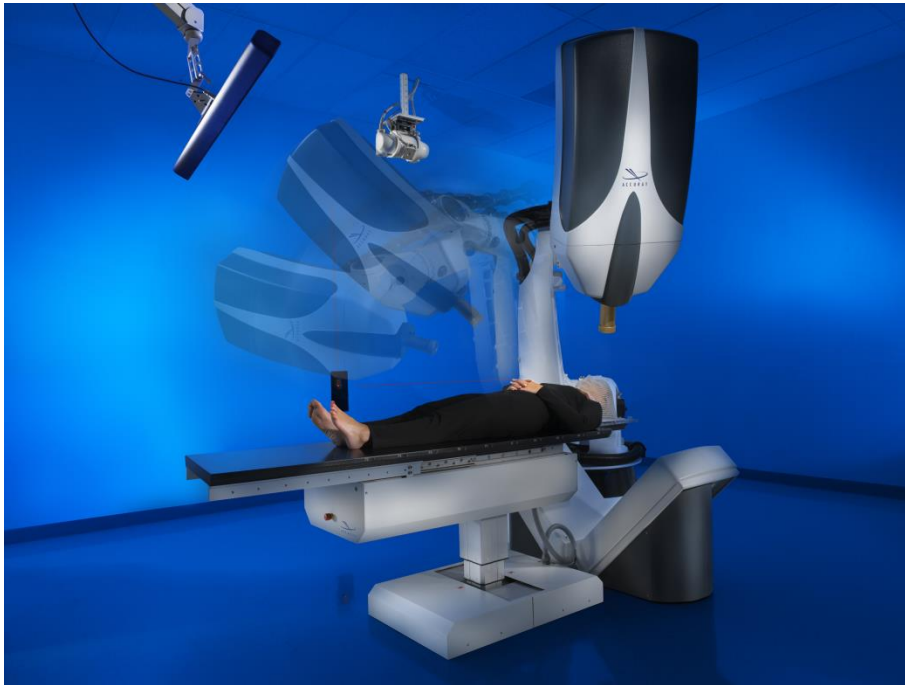

- No flattening filter
- Uses circular cones of diameter 0.5 to 6 cm
- Non-Isocentric
- Average dose delivered per session is 12.5 Gy
- 6 sessions/day
- Dose rate @ 80 cm = 400 cGy/min

<http://www.accuray.com/Products/Cyberknife/index.aspx>

# Intensity Modulated Radiation Therapy

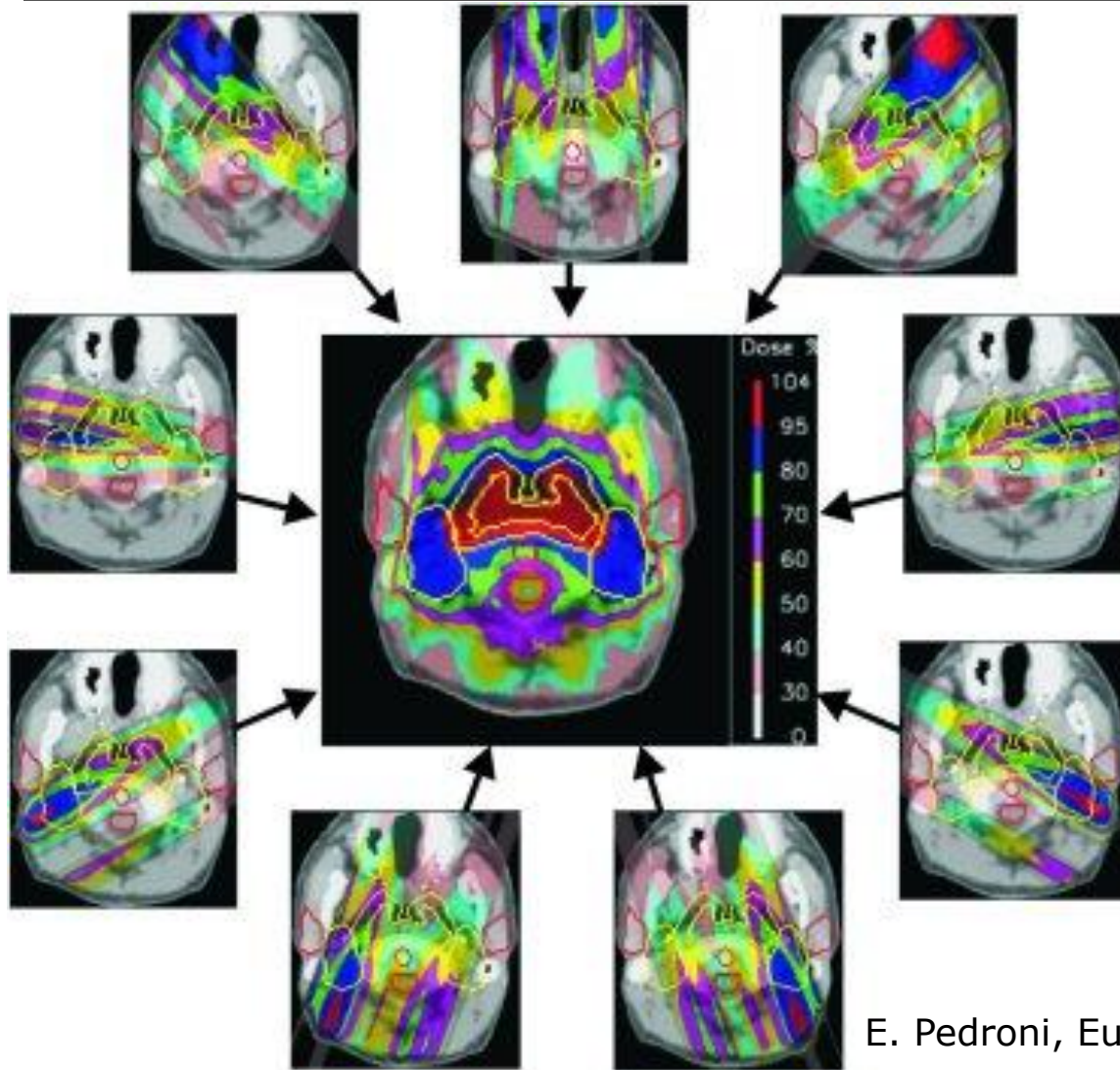

An example of intensity modulated treatment planning with photons. Through the addition of 9 fields it is possible to construct a highly conformal dose distribution with good dose sparing in the region of the brain stem (courtesy of T. Lomax, PSI).

E. Pedroni, Europhysics News (2000) Vol. 31 No. 6

Yet X-rays have a comparatively poor energy deposition as compared to protons and carbon ions

# Helical tomotherapy

---

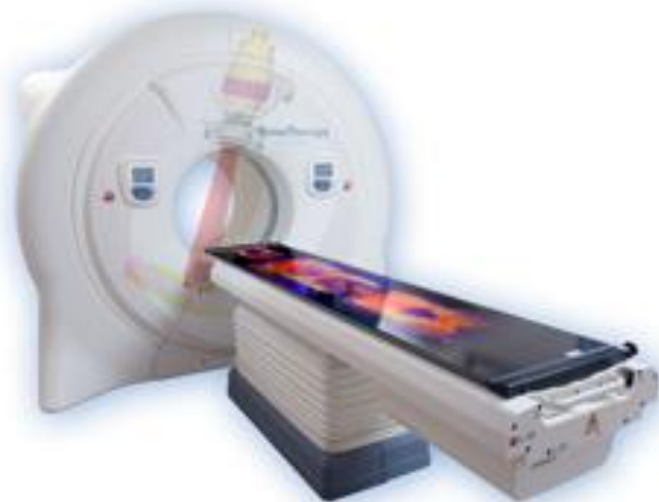

[www.tomotherapy.com](http://www.tomotherapy.com)

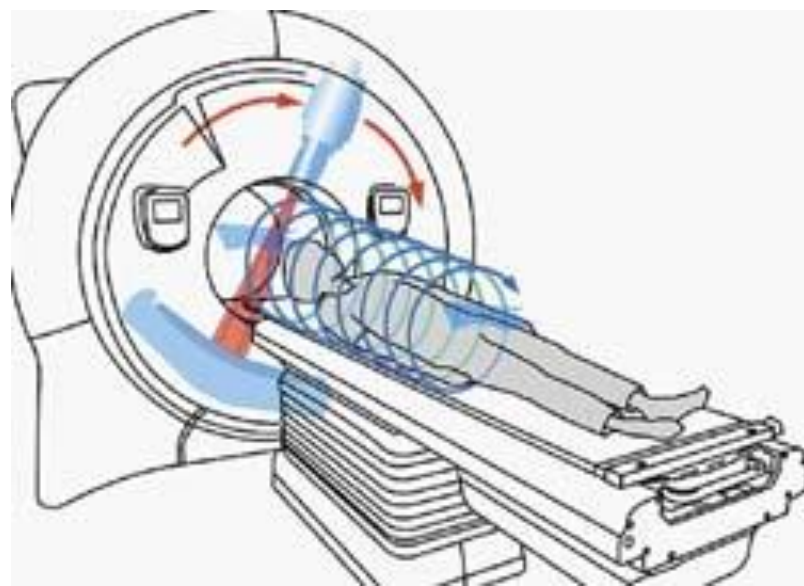

- **Integrated CT guidance**

- Integrated CT scanner allowing efficient 3D CT imaging for ensuring the accuracy of treatment

- **A binary multi-leaf collimator (MLC)** for beam shaping and modulation

- **A ring gantry design** enabling TomoHelical delivery

- As the ring gantry rotates in simultaneous motion to the couch, **helical fan-beam IMRT** is continuously delivered from all angles around the patient

- Very large volumes can be treated in a single set-up

# Hybrid MRI linac

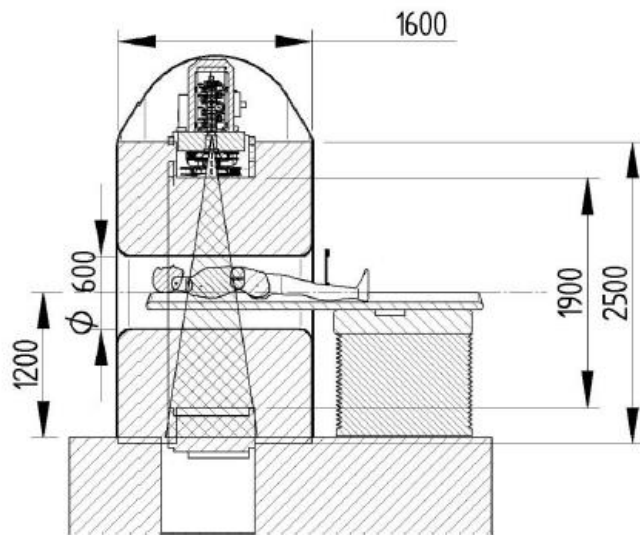
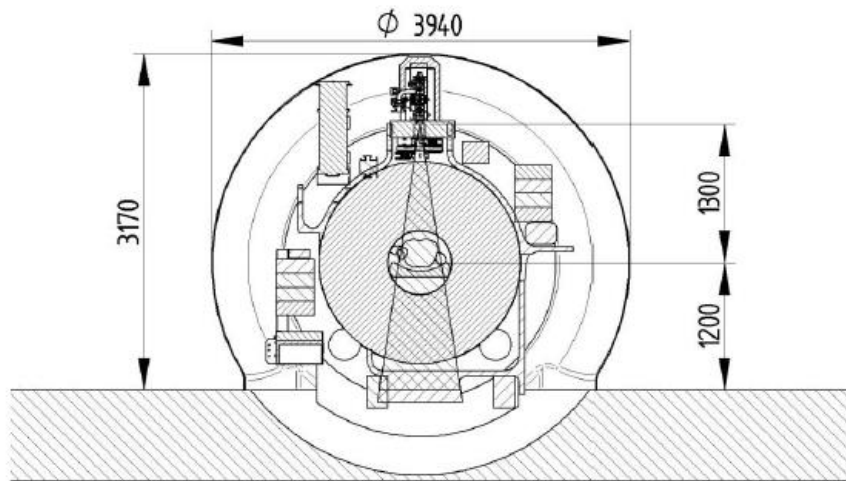

- Closed bore high field MRI
  - Gantry ring based 6 MV accelerator with MLC
- accelerator and MRI system have to operate simultaneously and independently

Courtesy J. Legendijk

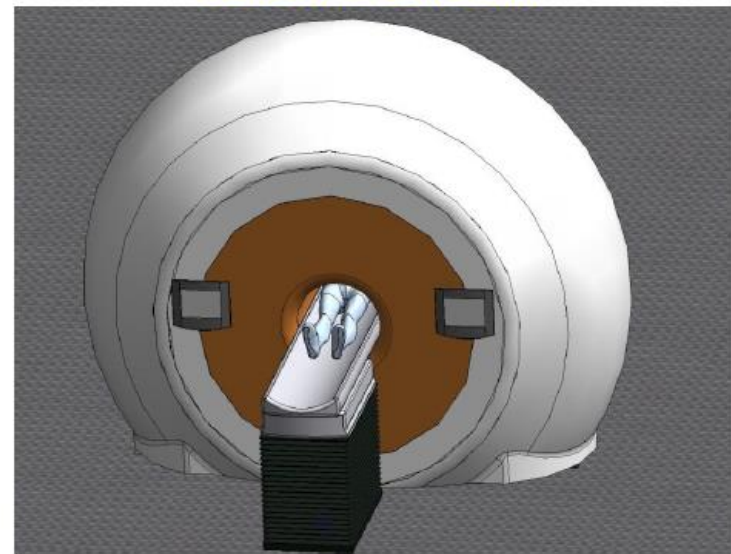

# Hadrontherapy: n, p and C-ion beams

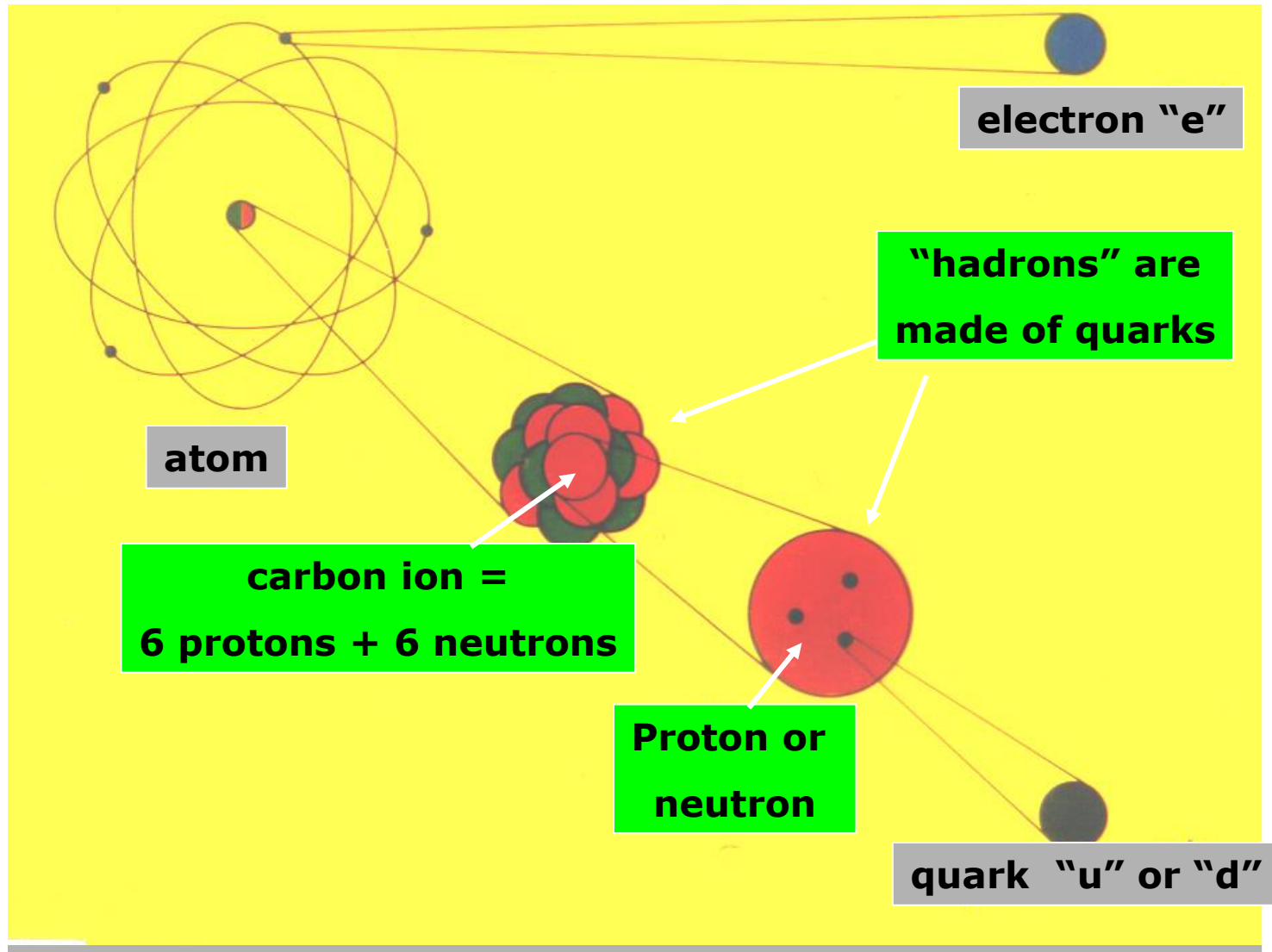

# Proton radiation therapy

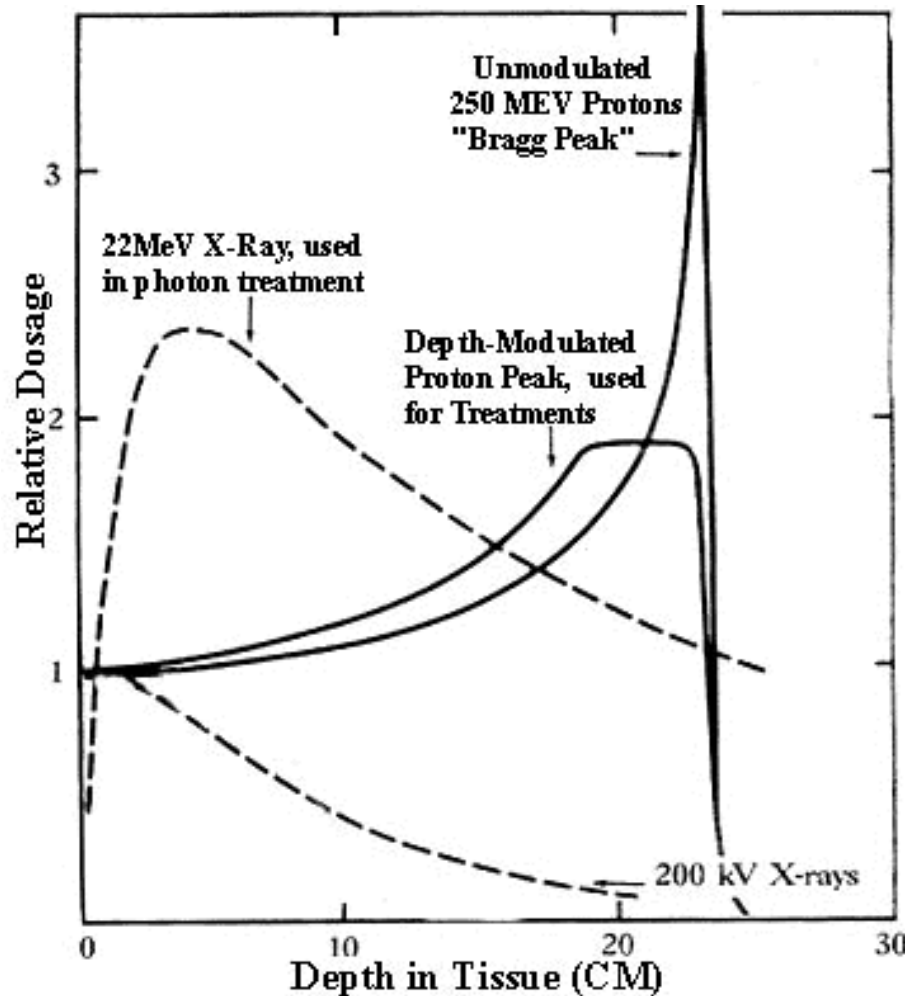

Prostate Cancer Treatment from the front.

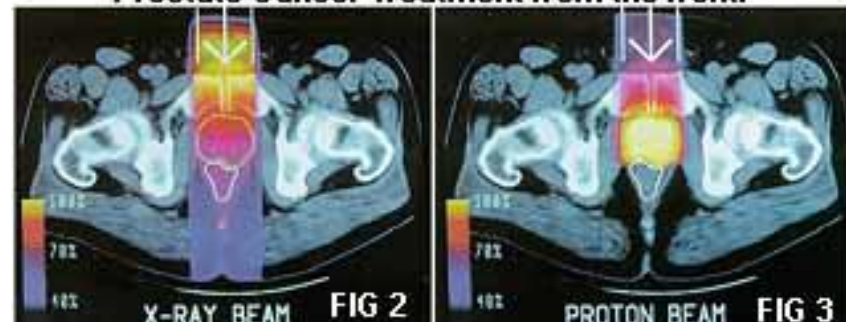

Prostate cancer treatment from the sides

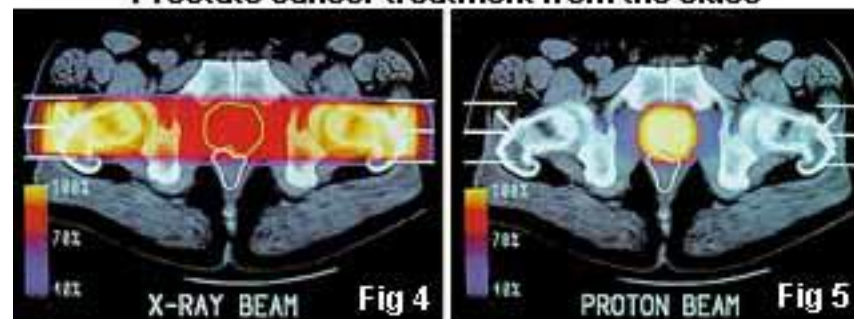

X-Ray vs Proton Side effects Treating Prostate cancer

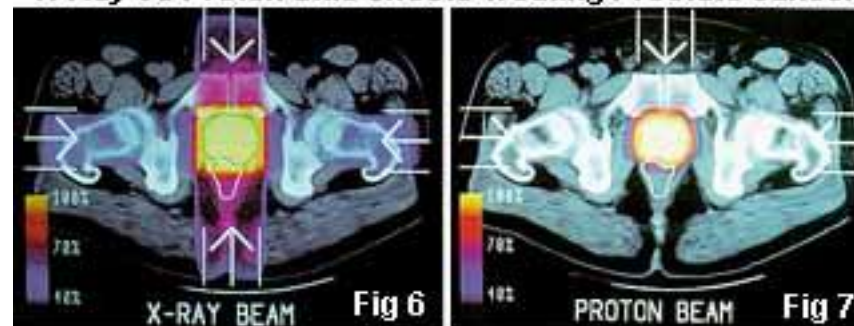

## Treatment planning

- *Ion beam therapy is more conformal than photon beam RT*
- *Sharper dose fall off*
- *Range of ions much more influenced by tissue heterogeneities than photon beams with direct impact on TCP and NTCP*
- *Image guidance is necessary for ion beam therapy*

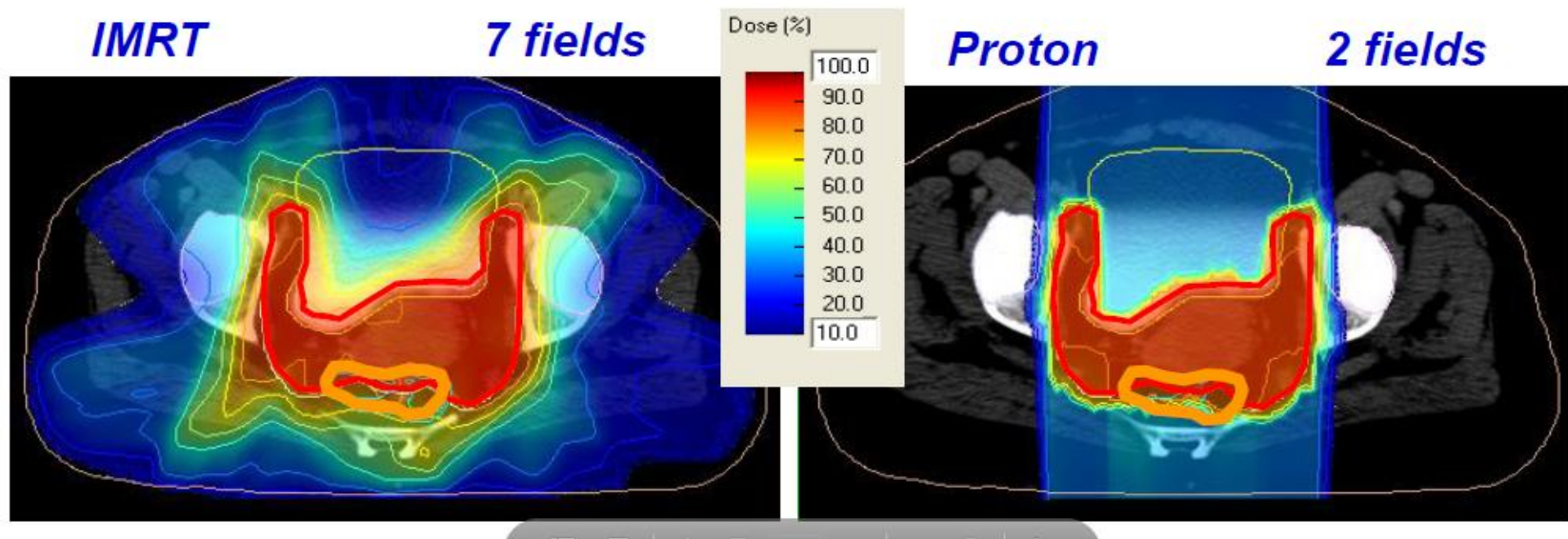

# Radiobiological effectiveness (RBE)

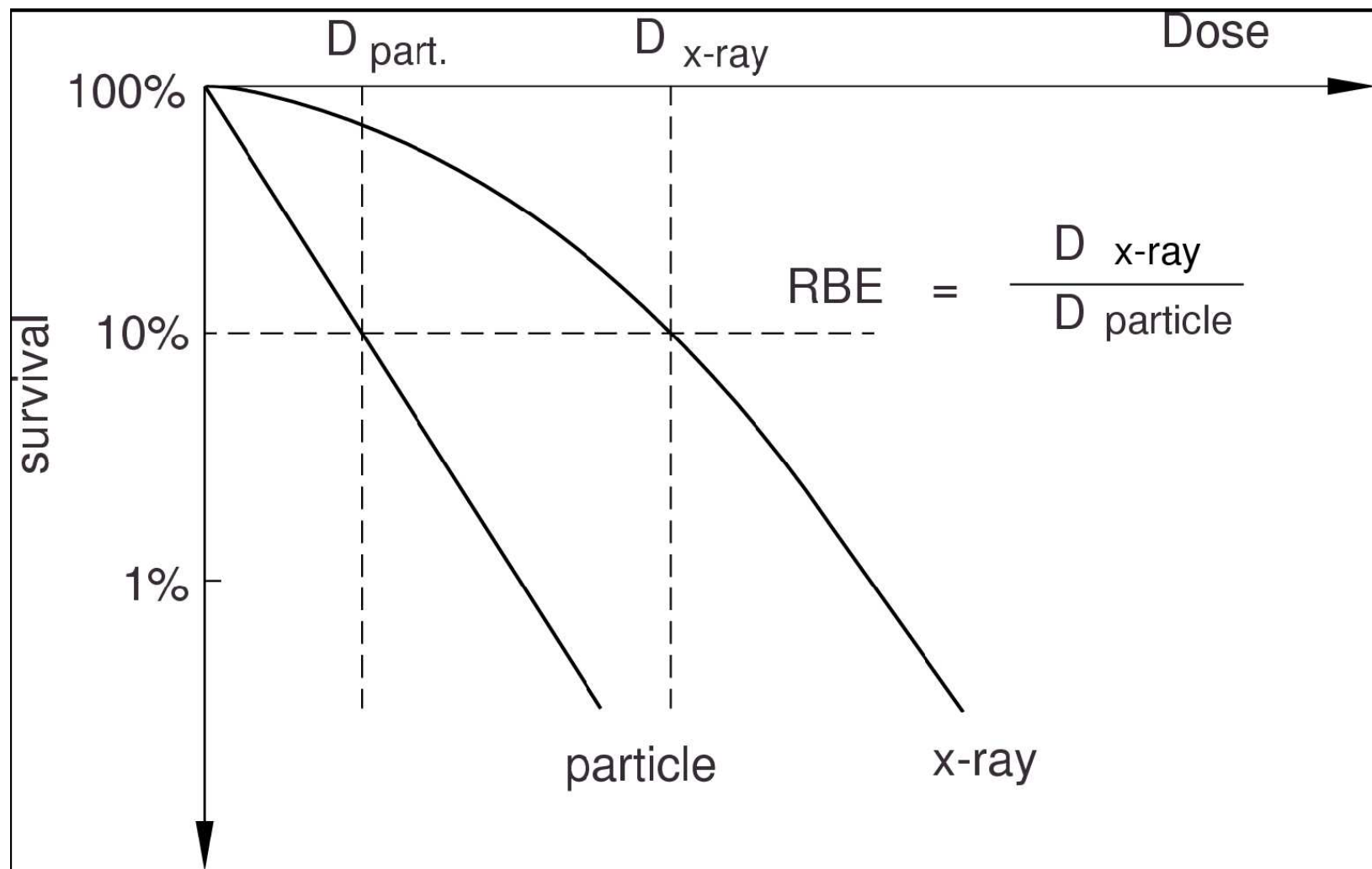



## G. Kraft, 2007 - Results for C ions

Indication	End point	Results photons	Results carbon HIMAC-NIRS	Results carbon GSI
Chordoma	local control rate	30 – 50 %	65 %	70 %
Chondrosarcoma	local control rate	33 %	88 %	89 %
Nasopharynx carcinoma	5 year survival	40 -50 %	63 %	
Glioblastoma	av. survival time	12 months	16 months	
Choroid melanoma	local control rate	95 %	96 % (*)	
Paranasal sinuses tumours	local control rate	21 %	63 %	
Pancreatic carcinoma	av. survival time	6.5 months	7.8 months	
Liver tumours	5 year survival	23 %	100 %	
Salivary gland tumours	local control rate	24-28 %	61 %	77 %
Soft-tissue carcinoma	5 year survival	31 – 75 %	52 -83 %	

# Hadrontherapy

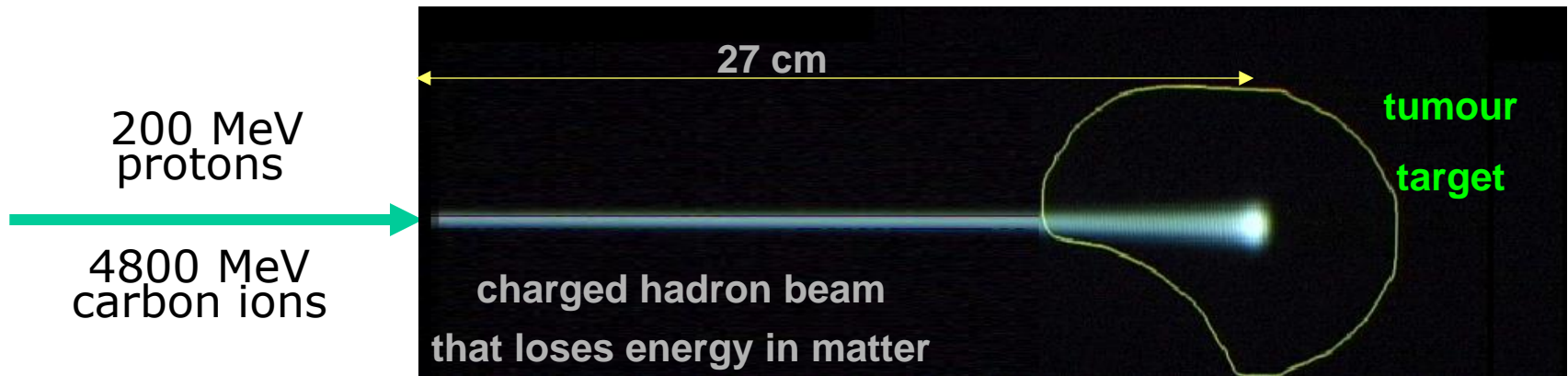

47 particle therapy facilities operation worldwide (mostly protons)

Number of patient treated until end of 2013

2054	He ions
1100	pions
13119	Carbon ions
433	other ions
105743	protons
<b>122449</b>	<b>Grand Total</b>

# Proton radiation therapy

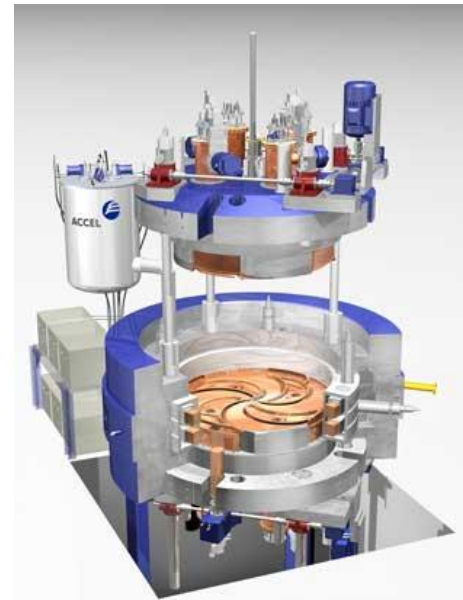

Loma Linda  
(built by FNAL)

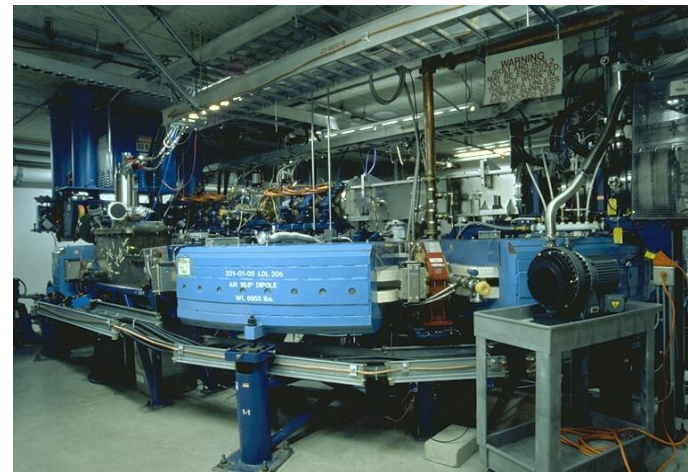

# Loma Linda University Medical Center (LLUMC)

## A NEW TOOL FOR CONTROLLING CANCER

The Loma Linda University Medical Center Proton Treatment Center is the first in the world to offer proton therapy, designed to treat cancerous tumors without harming surrounding healthy tissue. The center cost \$10 million, took four years to

design and build, and contains the world's smallest synchrotron built by Fermi National Accelerator Laboratory. It is as large as some hospitals, can serve up to 100 patients in a 10-hour day, and is a model for worldwide training and research.

### HOW A PROTON BEAM WORKS

The beam enters the body at a low absorption rate and increases in intensity at a specific point, called the Bragg peak. A series of protons are focused on the tumor, giving it the highest concentration of radiation, killing the cells of the tumor. Not only is the dose of radiation in normal tissue sharply reduced, compared to conventional radiation therapy, but the energy of the proton beam completely dissipates within the tumor, causing no damage to normal tissues beyond the tumor.

### THE GANTRY

These gantries resembling giant ferris wheels can rotate around the patient and direct the proton beam to a precise point. Each gantry weighs about 90 tons and stands three stories tall. The 15-foot-diameter gantries support the bending and focusing magnets to direct the beam, and have counterweights for extra radiation shielding.

### STATIONARY BEAM

The stationary beam has two branches, one for irradiating eye tumors and the other for central nervous system tumors.

### THE INJECTOR

Protons are stripped out of the nucleus of hydrogen atoms and sent to the accelerators.

### SYNCHROTRON (ACCELERATOR)

The synchrotron is a ring of magnets, about 20 feet in diameter, through which protons circulate in a vacuum tube. As the magnetic field in the ring is increased, the energy of the protons is also increased. When the magnetic field reaches the value corresponding to a prescribed beam energy, the field is held constant while protons are slowly extracted from the ring. The system accelerates protons to a minimum energy (20 million electron volts) in one-quarter second and to maximum energy (250 million electron volts) in one-half second.

Steel-reinforced concrete walls are up to 15 feet thick.

### BEAM TRANSPORT SYSTEM

The Beam Transport System carries the beam from the accelerator to one of four treatment rooms. This system consists of several bending and focusing magnets which guide the beam around corners and focus it to the desired spot size and location within the vacuum tube. The system revisitors the size, position, and intensity of the beam at many points. Variations from the prescribed parameters send messages through the computer network to adjust the beam or to trip interlocks which automatically shut it off.

### WHAT THE PATIENT SEES

The patient rests on a couch or sits in a chair, as appropriate for treatment. Alignment and verification of the patient to the beam, controlled from a room just outside the treatment room, will take most of the time; actual beam time takes less than a minute. Most patients will be able to return to work or other activities immediately after the procedure.

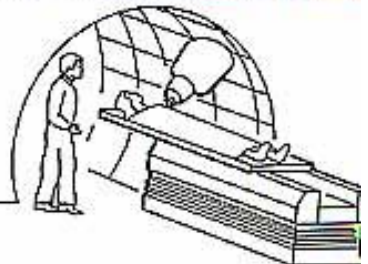

# Loma Linda University Medical Center (LLUMC)

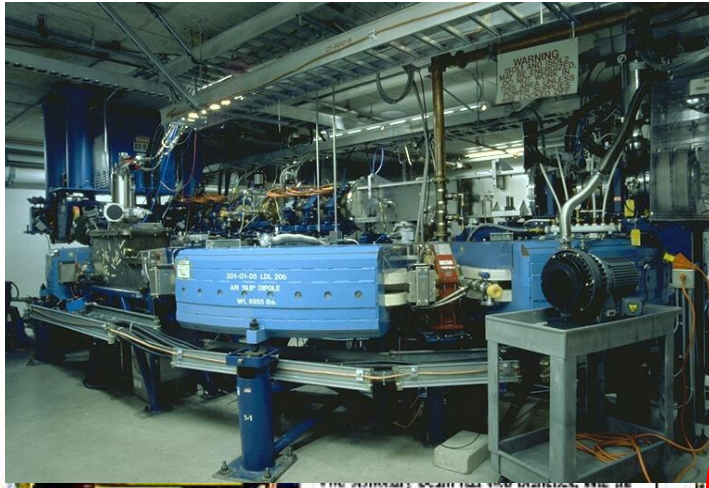

## CANCER

...the world's smallest synchrotron...  
...radiation Laboratory. It is as large as...  
...up to 100 patients in a 10-hour day...  
...the training and research.

## HOW A PROTON BEAM

The beam enters the body at a...  
...specific point, called the Bragg...  
...giving it the highest concentration...  
...only is the dose of radiation in...  
...tional radiation therapy, but the...  
...within the tumor, causing no dan...

## THE GANTRY

These garties resembling giant ferris wheels can rotate around...  
...the proton beam to a precise point. Each gantry weighs about...  
...three stories tall. The 15-foot-diameter garties support the b...  
...magnets to direct the beam, and have counterweights for extra...

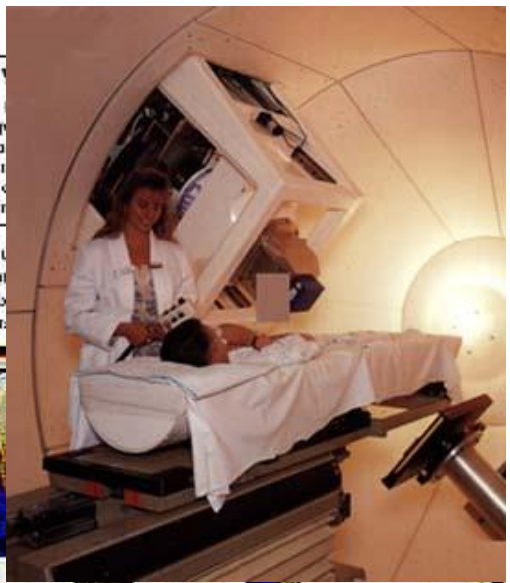

## THE INJECTOR

Protons are stripped out of the...  
...nucleus of hydrogen atoms and sent...  
...to the accelerator.

The secondary beam has...  
...irradiating eye tumors and the...  
...target for central...  
...nervous system tumors.



## SYNCHROTRON

The synchrotron...  
...30 feet in diam...  
...outside in a vacu...  
...in the ring is in...  
...toes is also...  
...field reaches the...  
...scribed beam a...  
...while protons a...  
...ring. The syste...  
...mean energy (2...  
...quarter second...  
...million electron

Steel-reinforced...  
...concrete walls...  
...are up to 15...  
...feet thick.

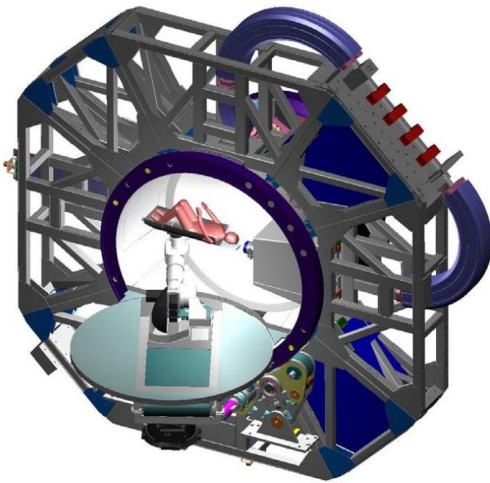

## PORT SYSTEM

Port System carries the beam...  
...to one of four treatment...  
...n consists of several bending...  
...elements which guide the beam...  
...I focus it to the desired spot...  
...within the vacuum tube. The...  
...size, position, and intensi...  
...tary points. Variations from...  
...instruments send messages...  
...ner network to adjust the...  
...relocks which automatically

## WELAR

The pati...  
...a chair...  
...Adjuster...  
...patient to...  
...turns just...  
...will take...  
...these table...  
...patients...  
...or other...  
...procedur...

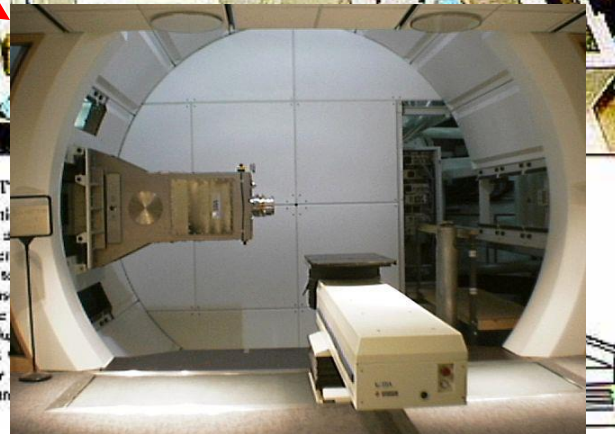

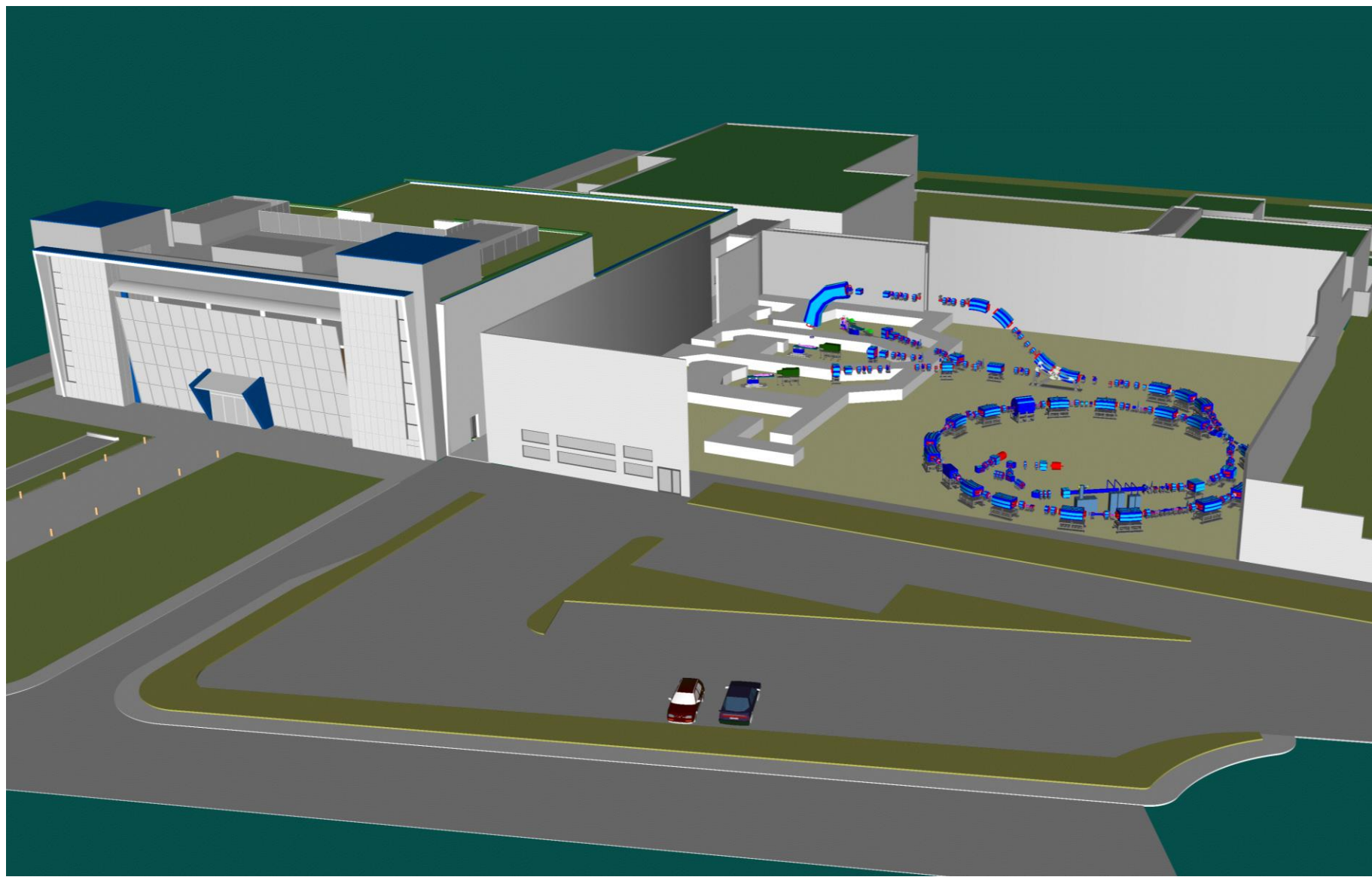

# National Centre for Oncological Hadrontherapy, CNAO, Pavia, Italy

---



# National Centre for Oncological Hadrontherapy, CNAO, Pavia, Italy

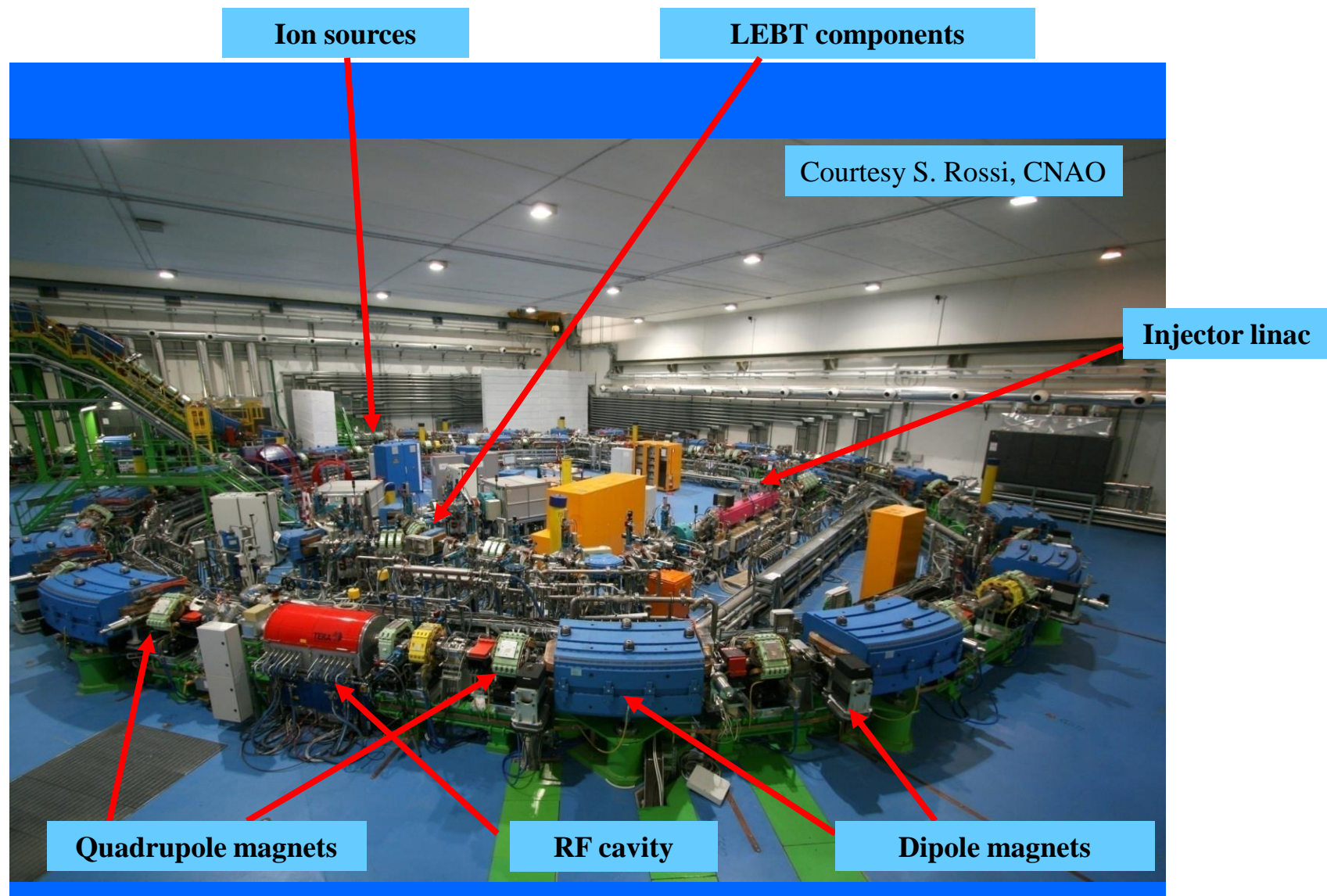





# The future of hadrontherapy: single room facilities ?

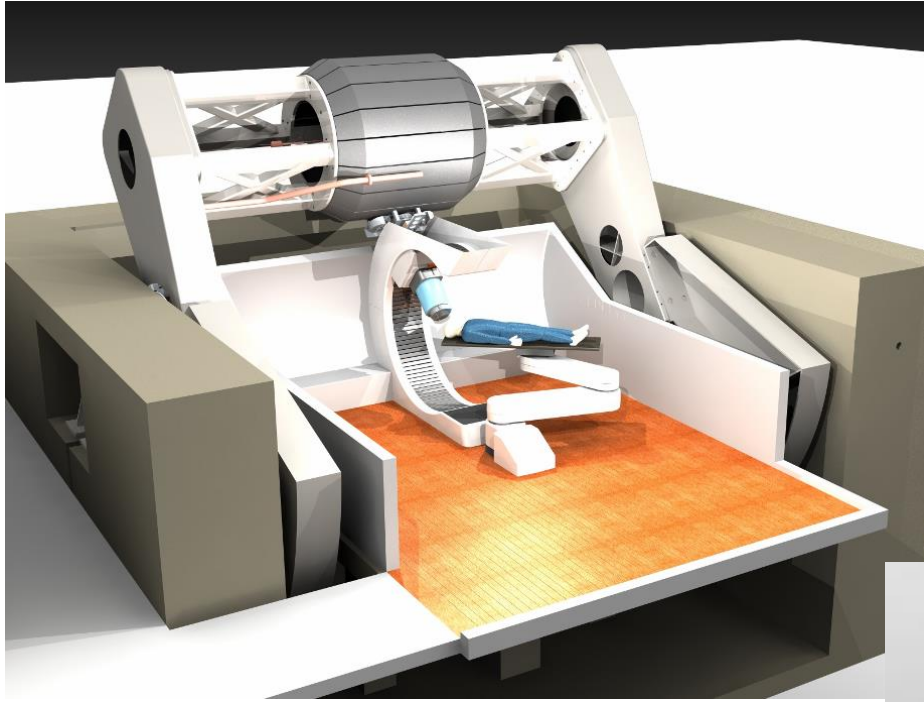

IBA Proteus Nano

Mevion Medical Systems

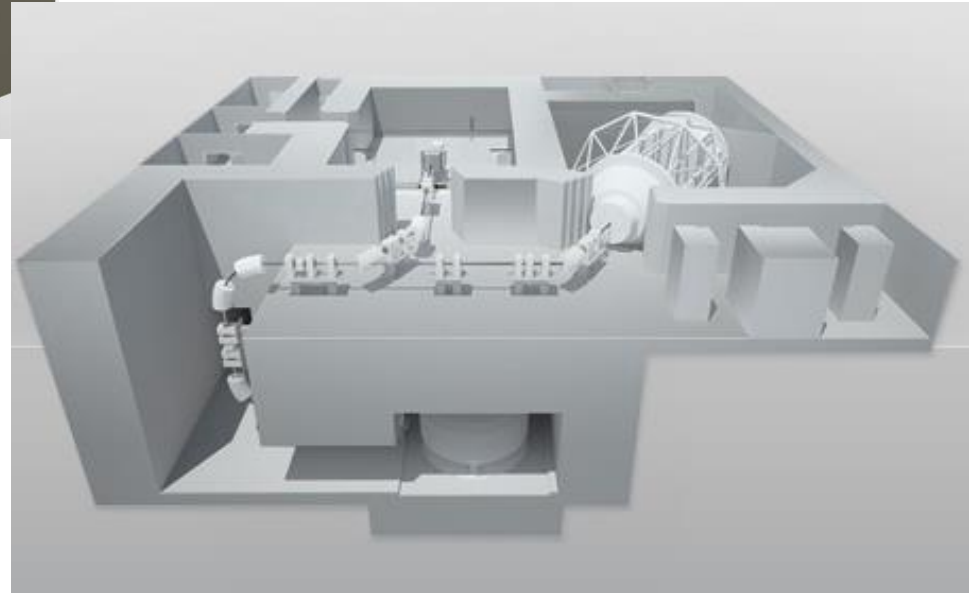

# Acknowledgements

---

I am indebted to Prof. Ugo Amaldi (TERA Foundation and University of Milano Bicocca, Italy) and Prof. Maria Carla Gilardi (University of Milano Bicocca, Italy) for providing me with some of the slides that I have shown you today.

I also wish to thank Dr. David Bartlett (formerly Health Protection Agency, UK) for pointing me to the very interesting book shown on slide 7.