

CLIC

(The Compact Linear Collider)

By Kyle Spindelman

The Accelerator

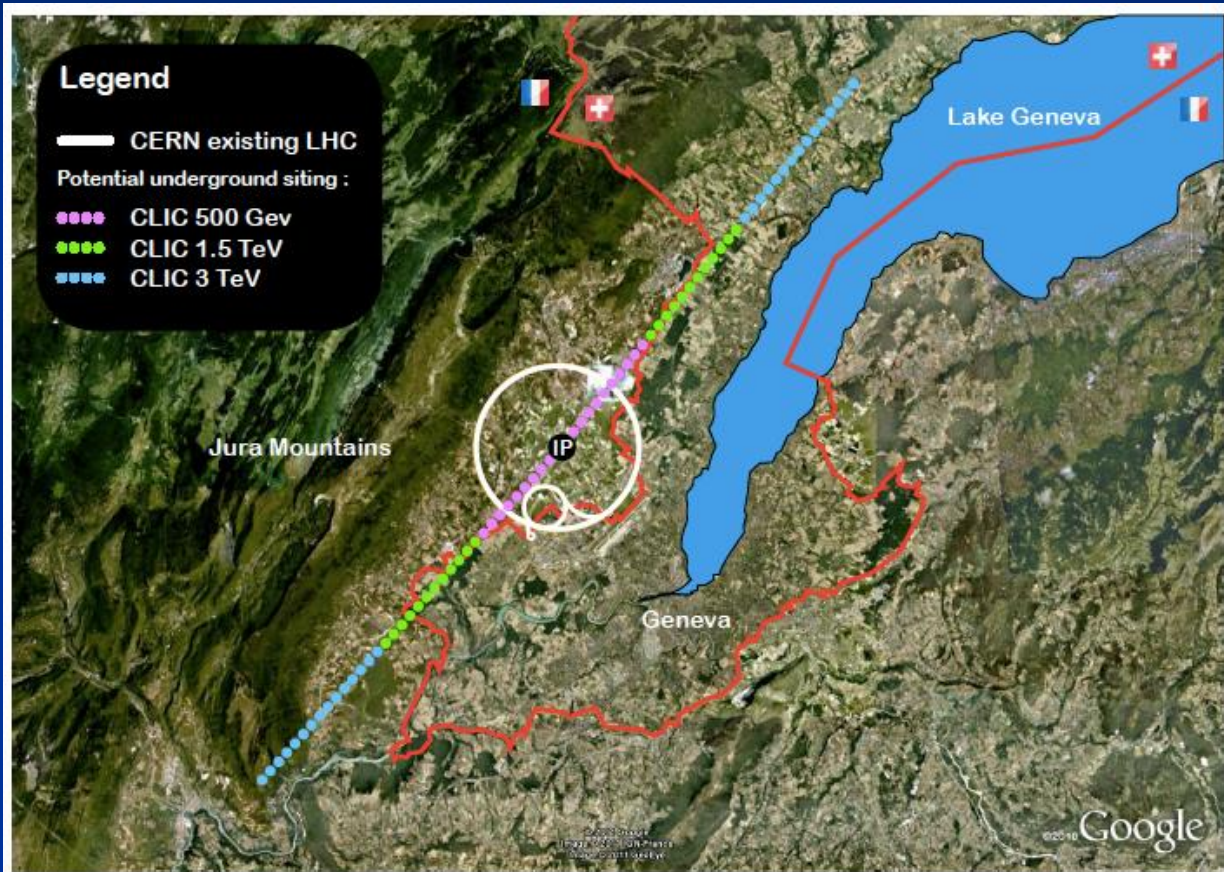

Fig. 7.2: CLIC footprints near CERN, showing various implementation stages [5].

The Accelerator

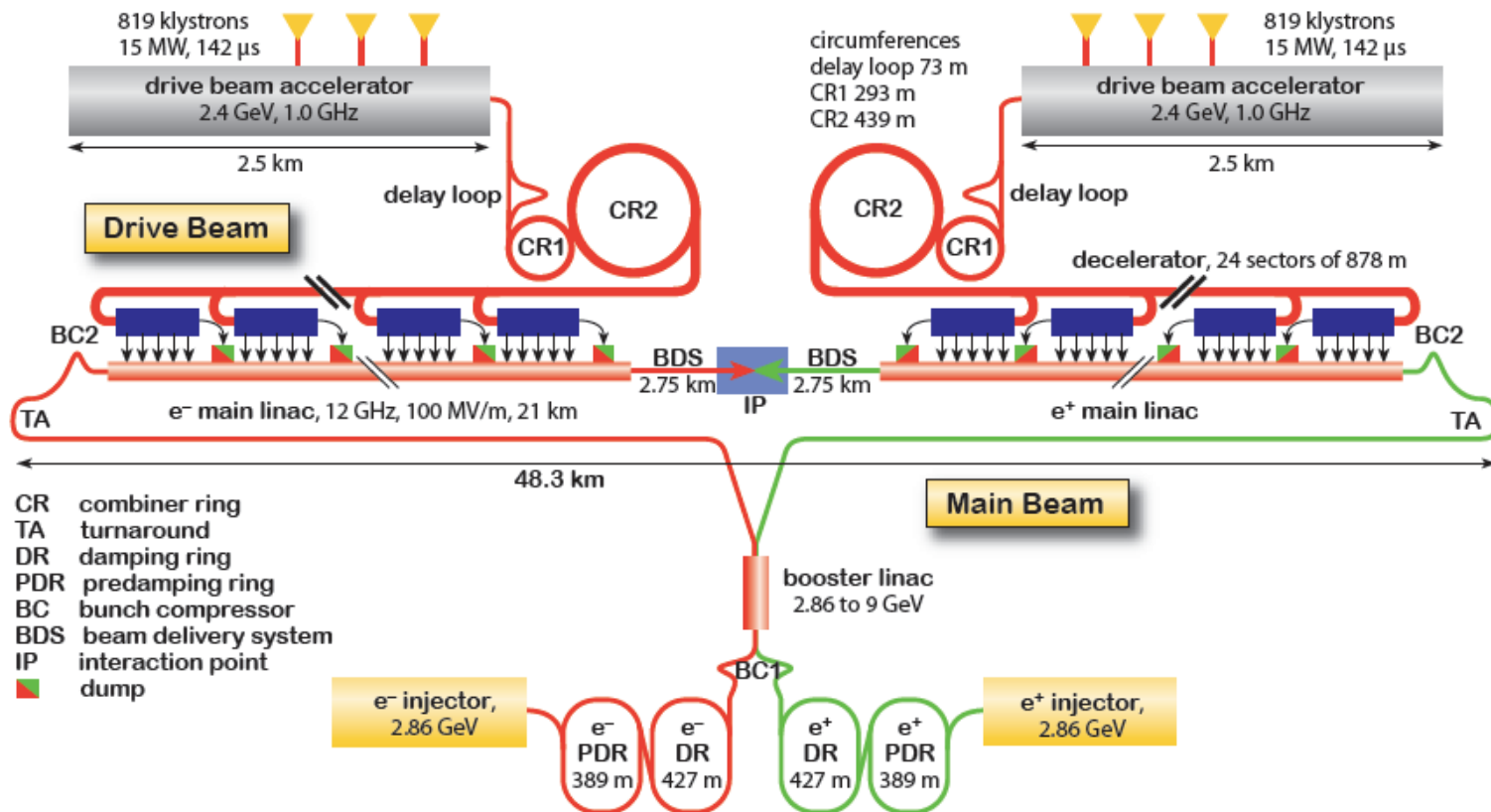
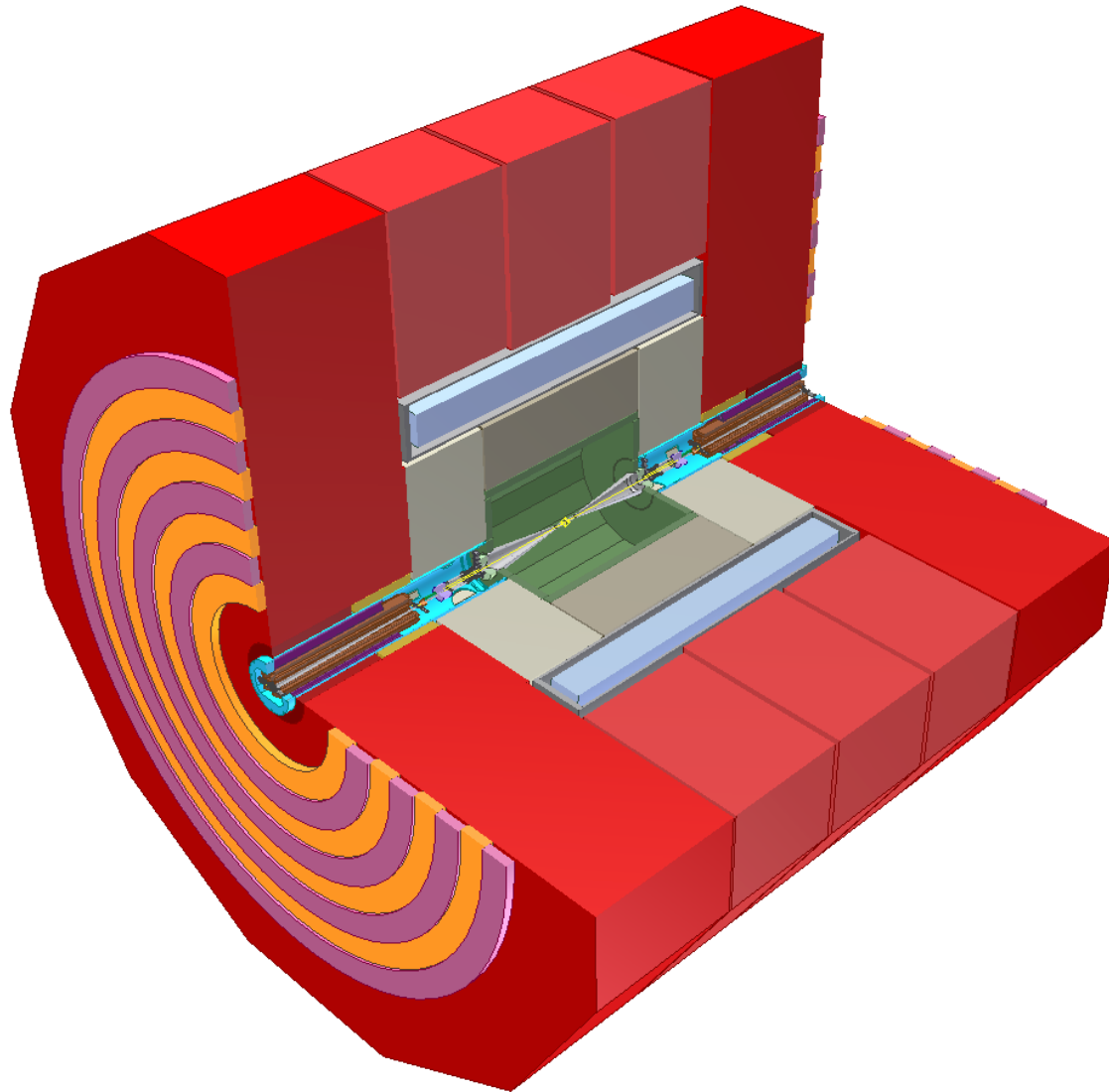
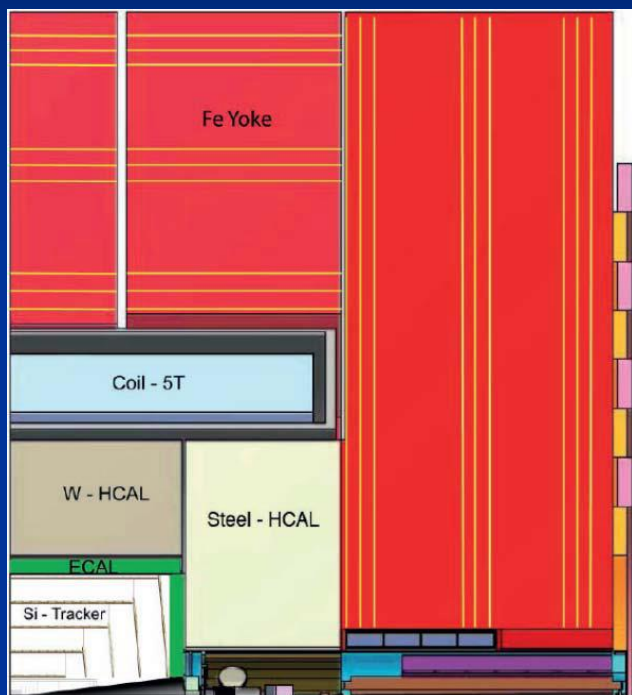

Fig. 3.1: Overview of the CLIC layout at $\sqrt{s} = 3$ TeV.

The Detectors



The Detectors



CLIC_SiD



CLIC_ILD

The Vertex Detector

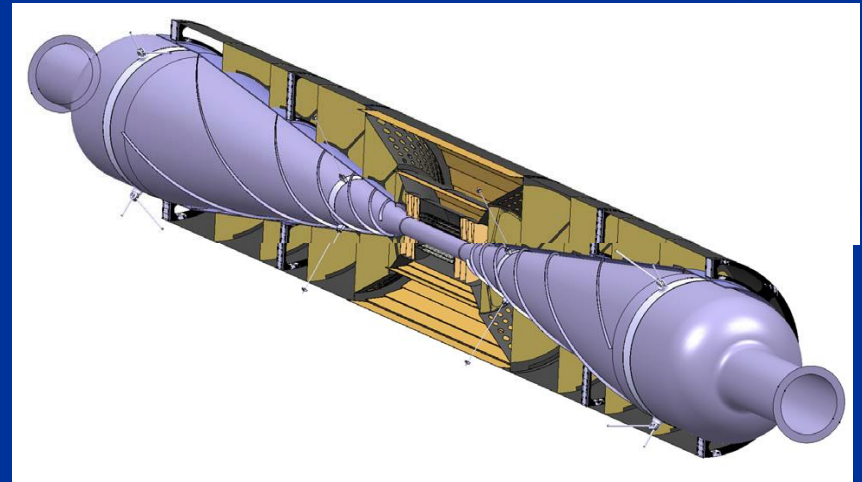
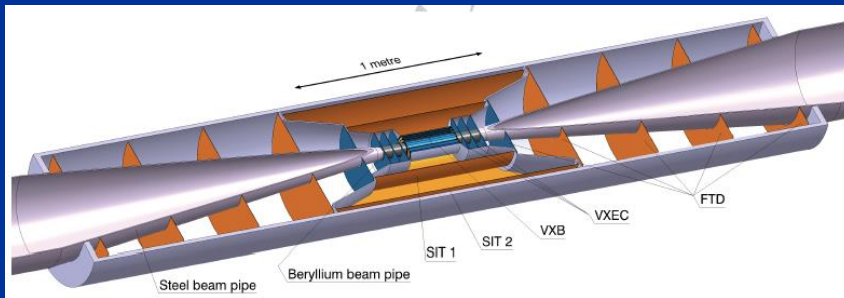

Air Cooling

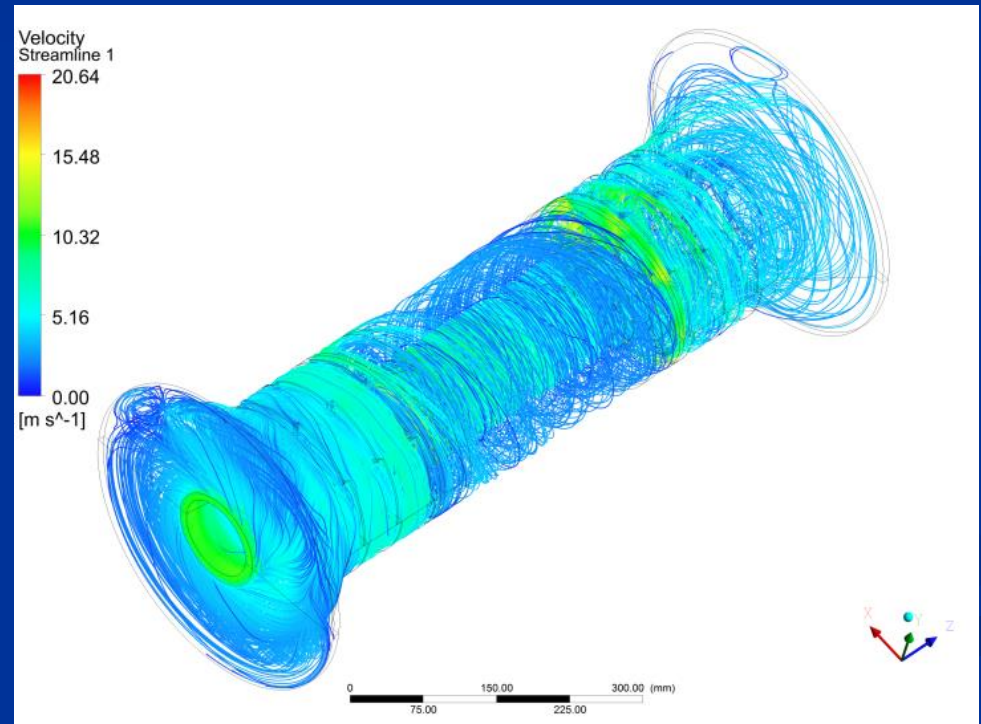
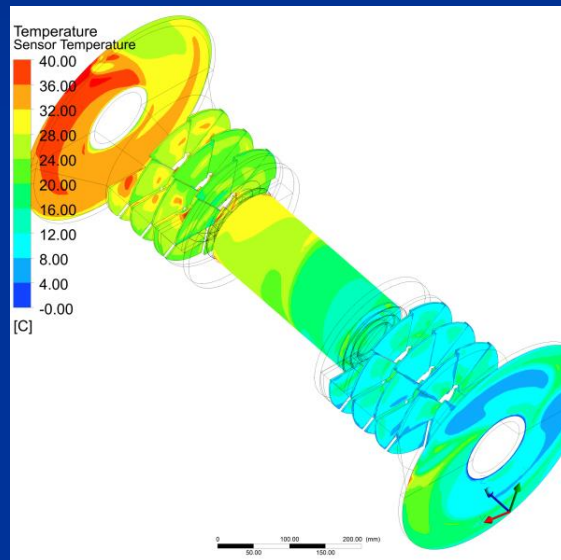
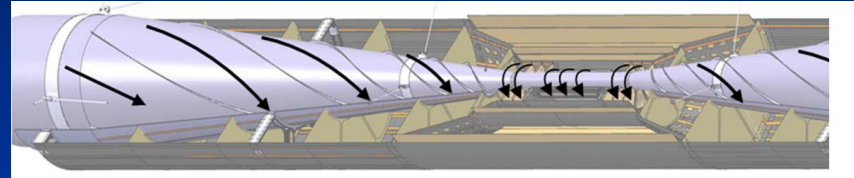

Staves

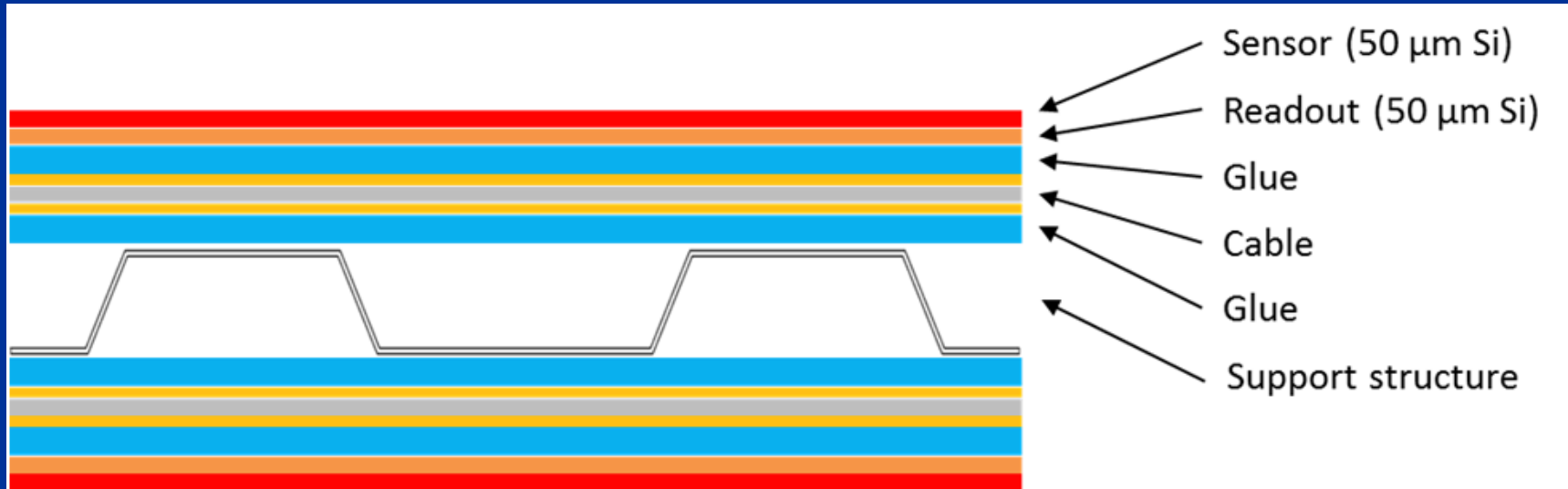

Stave Research

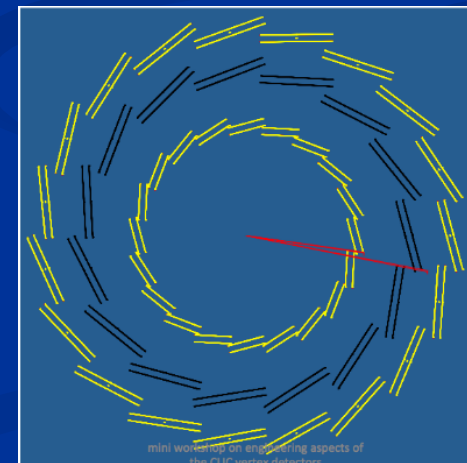
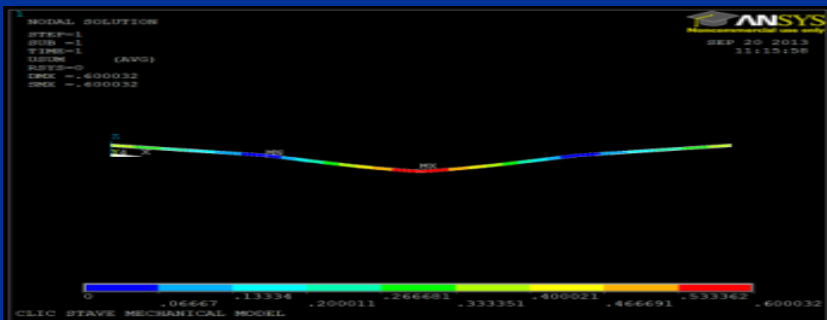

END

Questions?