

---

# Heater delays: Simulations and experimental data

T. Salmi (TUT),  
and the magnet test teams at LBNL, FNAL and CERN

Quench protection topical meeting, Apr 29 2014



# Outline

---

- Delays in HQ
- Delays in LQ
- Delays in 11 T
- Delays in QXF
- Summary of delays and modeling uncertainties at 80% and 50%
- References
- Additional material: Delays in HD3, Simulation uncertainty analysis, simulation parameters

# HQ01 and HQ02 – Outer layer

PH peak power = 50-55 W/cm<sup>2</sup>,  
 $\tau = 40-45$  ms

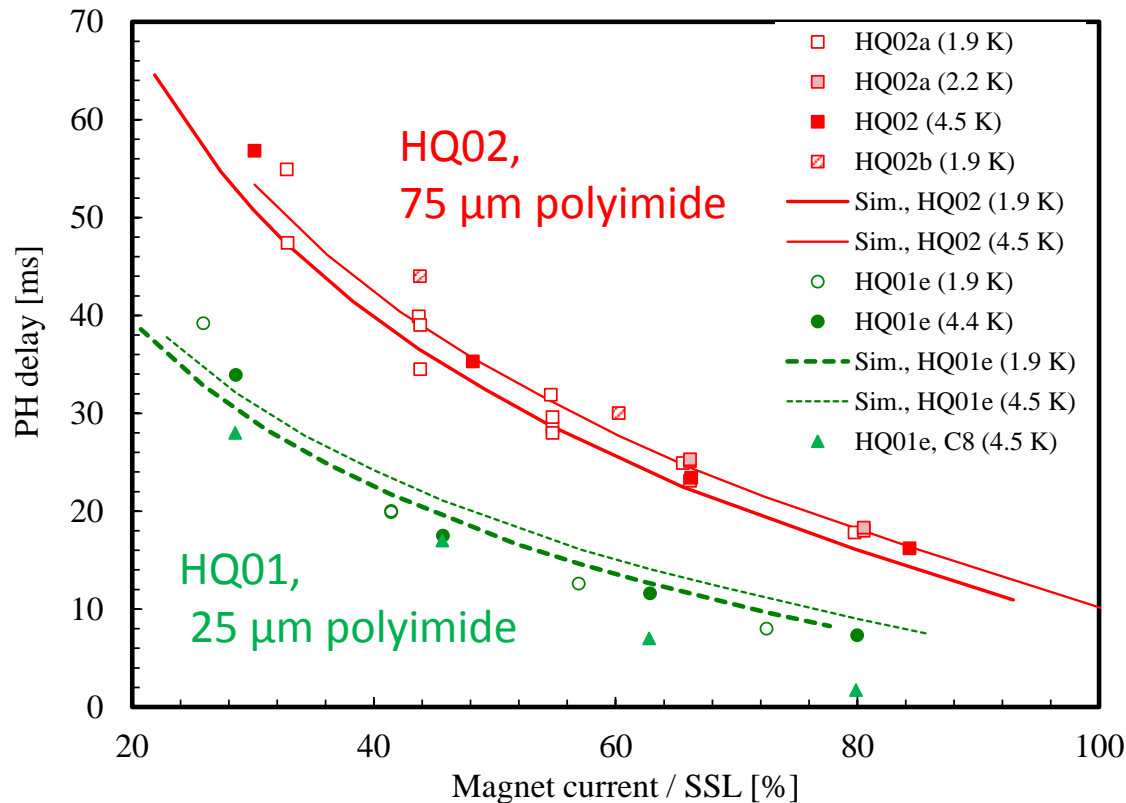
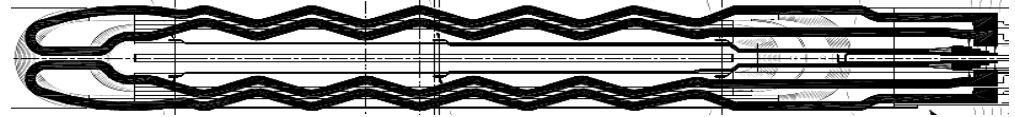

- Thicker insulation:  
10 – 30 ms longer delay
- Impact of  $T_{op}$  negligible
- Different coils and test stations: Exp. variation up to 10 ms
  - Same, well controlled test specification
- Very good modeling agreement

# HQ01 and HQ02 – Inner layer

PH peak power = 50-55 W/cm<sup>2</sup>,  
 $\tau = 40-45$  ms  
 $T_{\text{op}} = 1.9$  K

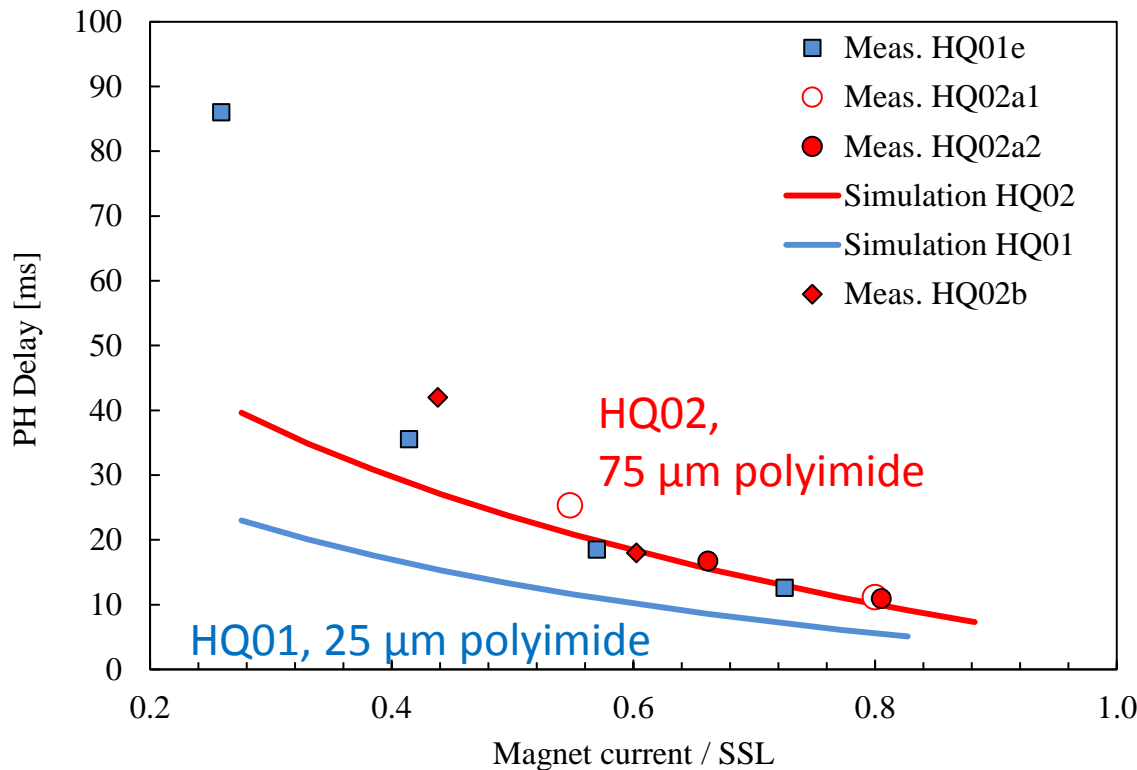
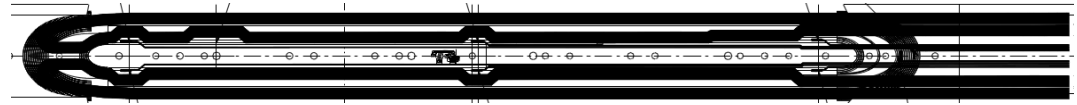

- No difference in exp. btw HQ01 and HQ02
  - Not clear why
- Stronger increase of delay at lower current than in OL
- Model match well HQ02 at high current, but does not catch the low current behaviour
- HQ01 delays longer than predicted by model

# HQ02 – Delay vs. power

$T = 1.9 \text{ K}$ ,  $\tau = 40\text{-}45 \text{ ms}$   
Kapton thickness =  $75 \mu\text{m}$

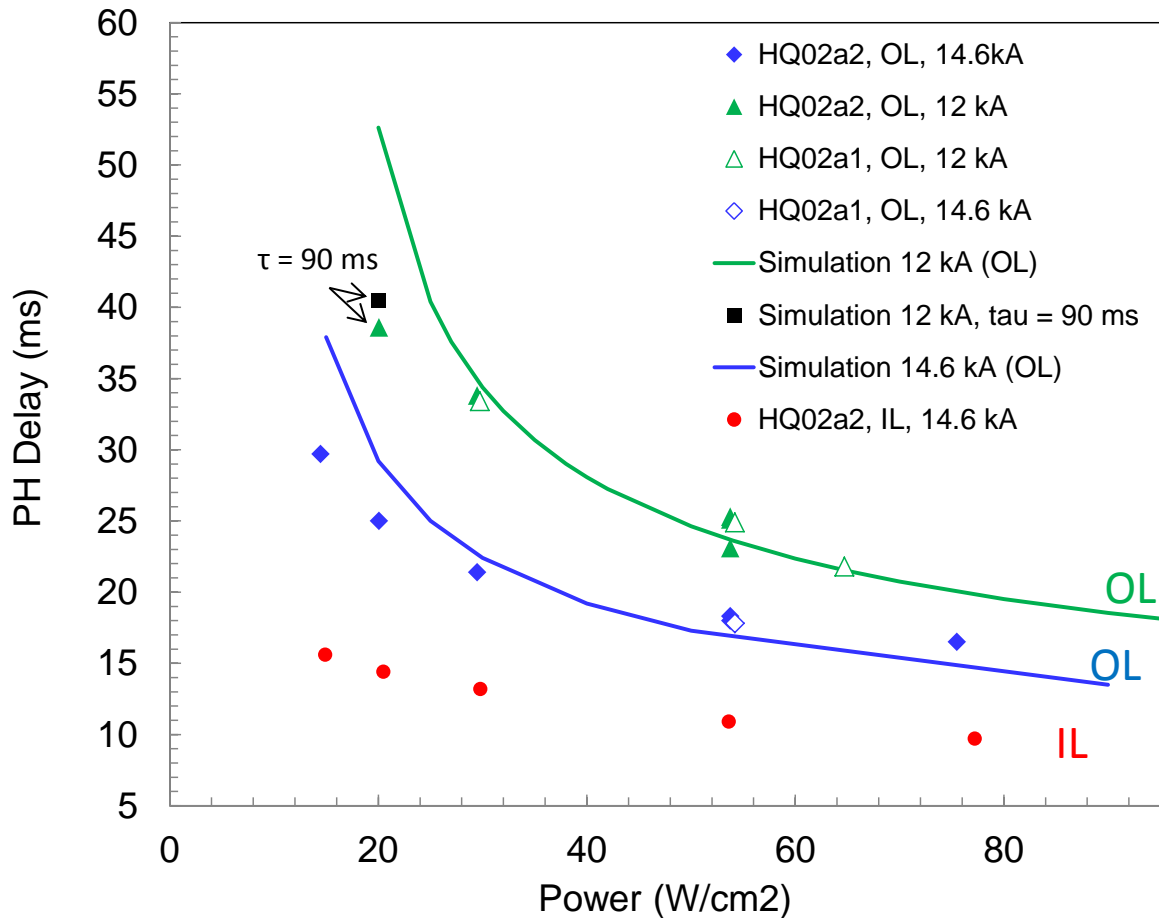

- Saturation around  $50 \text{ W/cm}^2$ 
  - A few ms gain possible above that
- Good modeling agreement for OL
  - (IL not yet done)

# LQ

PH peak power = 40 W/cm<sup>2</sup>,  
 $\tau = 35$  ms  
 Kapton thickness = 25  $\mu$ m

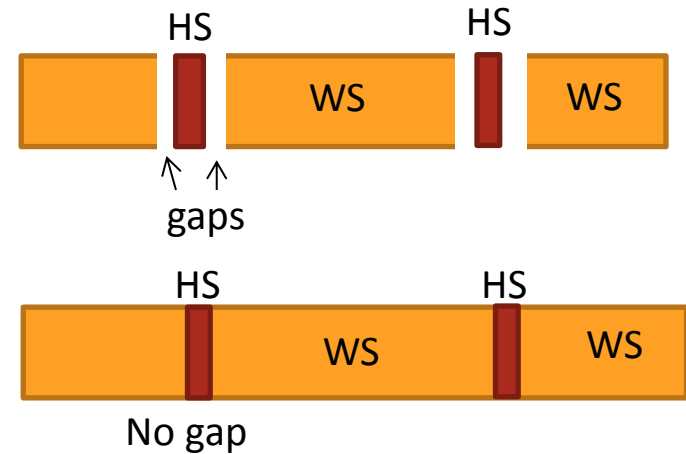
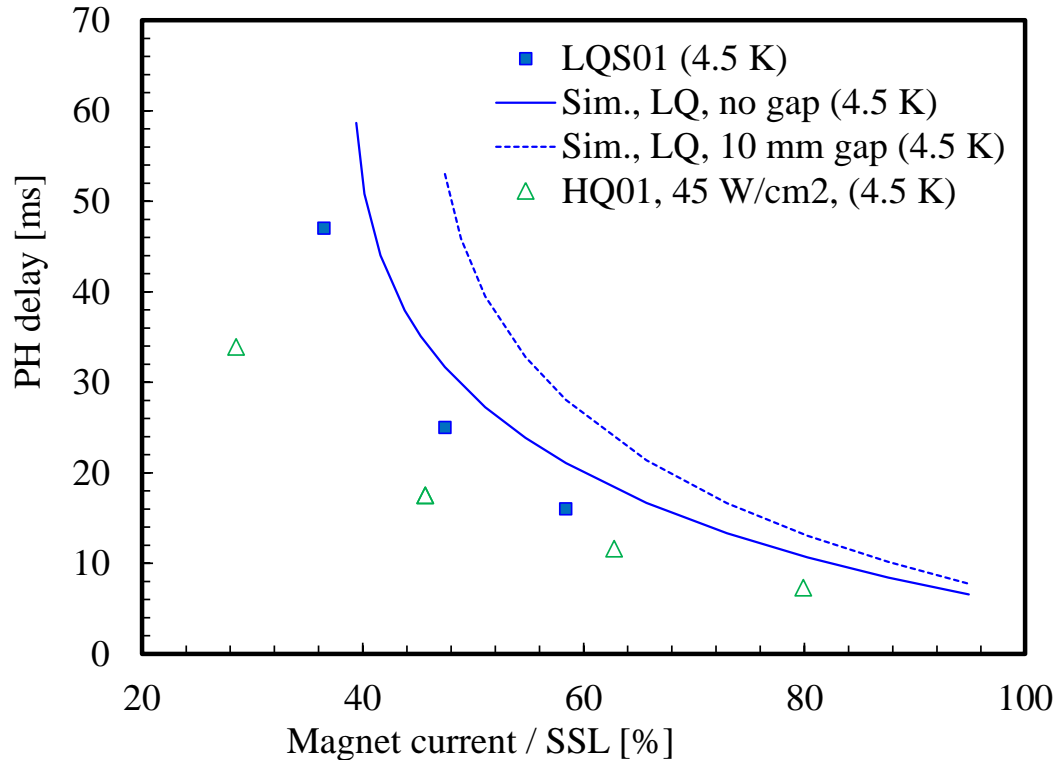
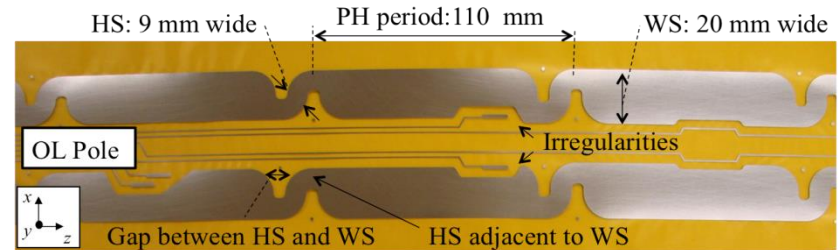

- Longer delay than in HQ01
- Wide segment (WS) has 5 times less heating power but is still important

# 11 T (MBHSP01) - Delays

PH peak power = 18.5 W/cm<sup>2</sup>,  
 $\tau = 25$  ms  
Kapton 76 or 203  $\mu$ m  
- Simulation for cable B<sub>max</sub>

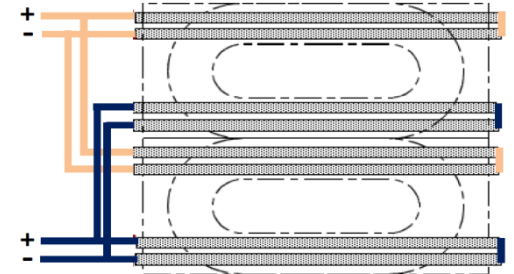

## Kapton 76 $\mu$ m

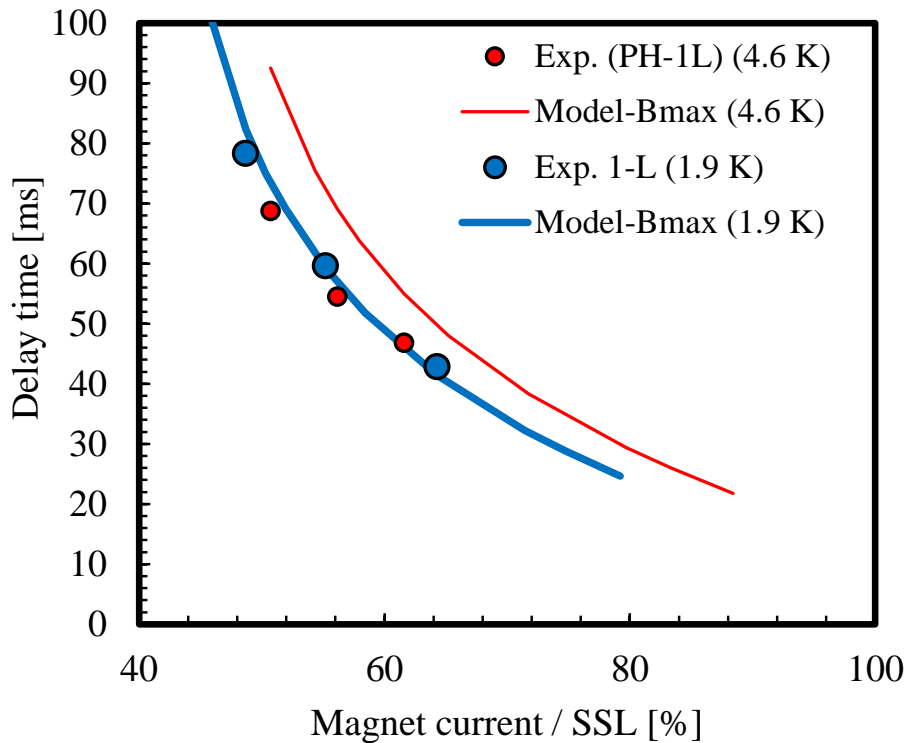

## Kapton 203 $\mu$ m

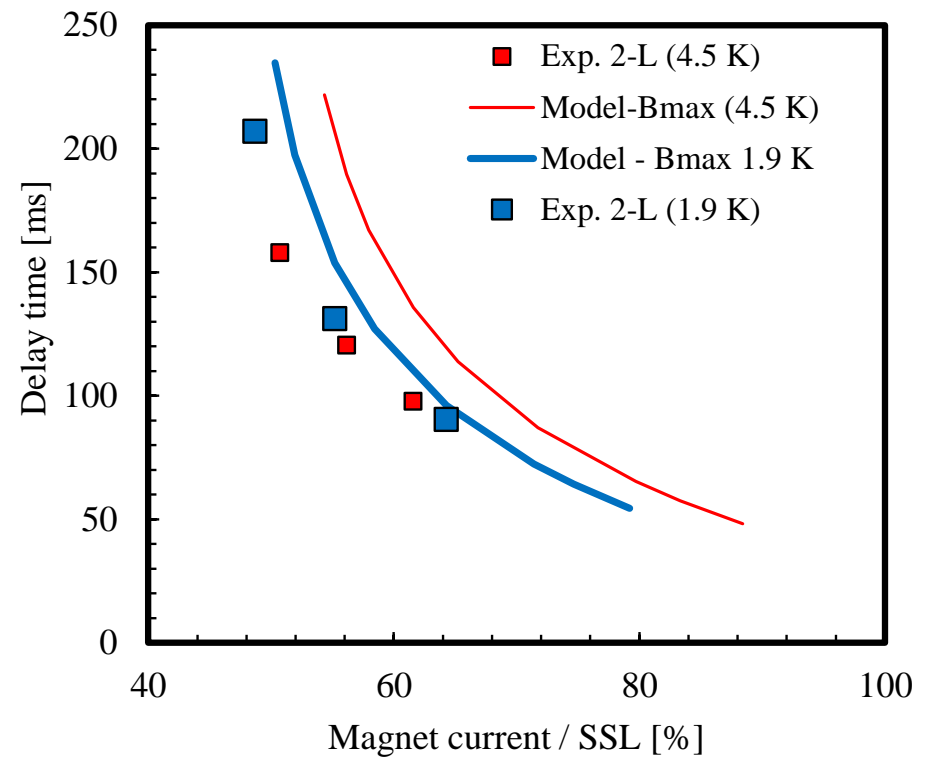

# 11 T (MBHSP02) - Delays

PH peak power = 40 W/cm<sup>2</sup>,  
 $\tau = 16$  or 31 ms  
 Kapton 114  $\mu\text{m}$  (incl. adhesive)  
 - Simulation For Bmax

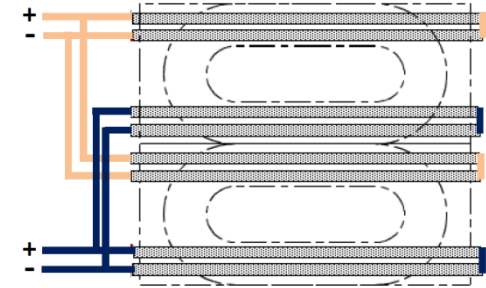

## Kapton 114 $\mu\text{m}$ Delays vs. $I_{\text{mag}}$ and $T_{\text{op}}$

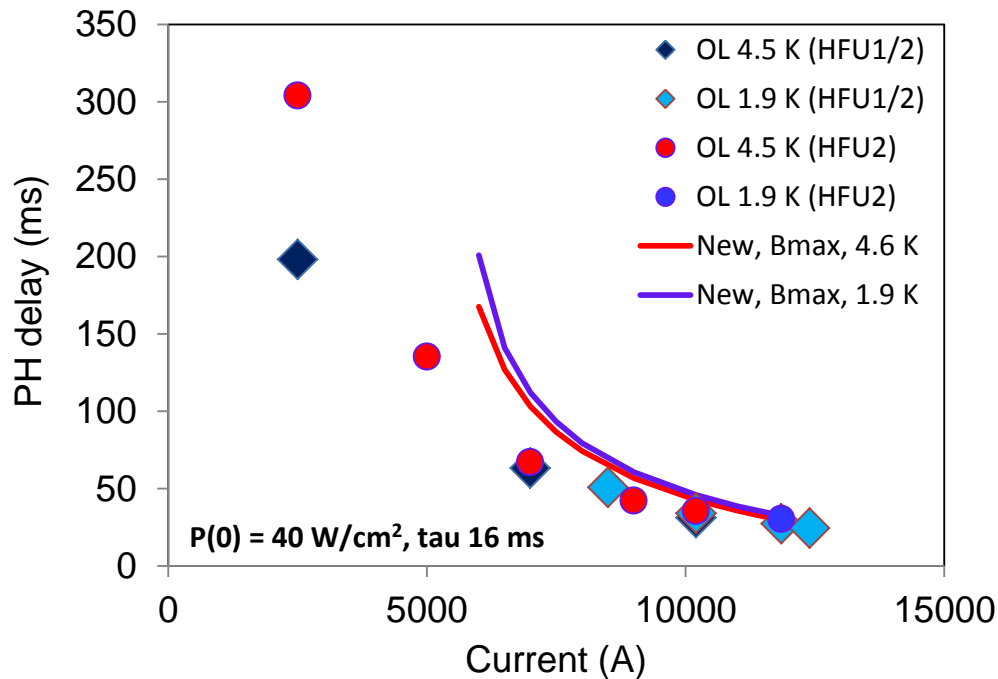

## Impact of tau (RC)

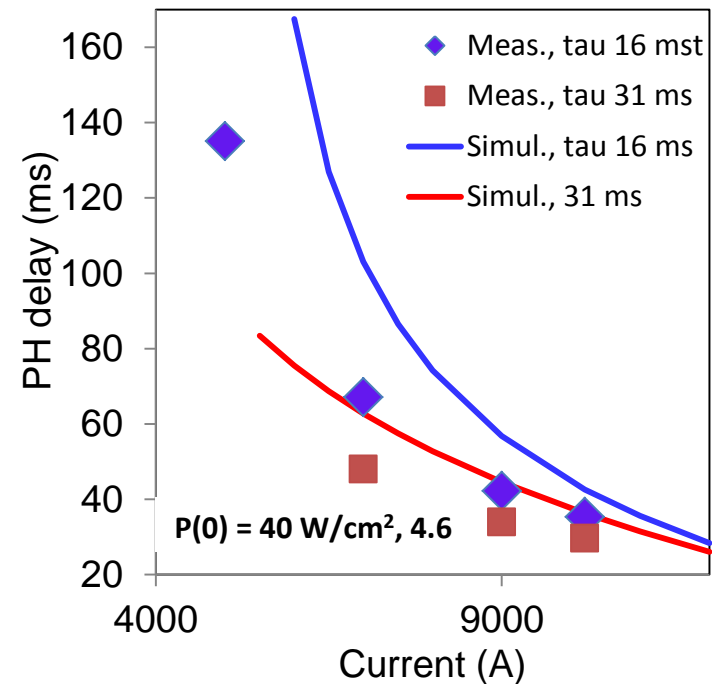



# QXF

## IL – Option 1

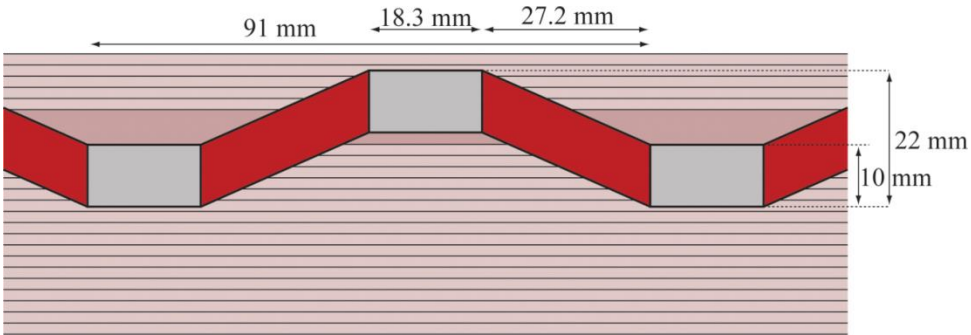

## IL – Option 2

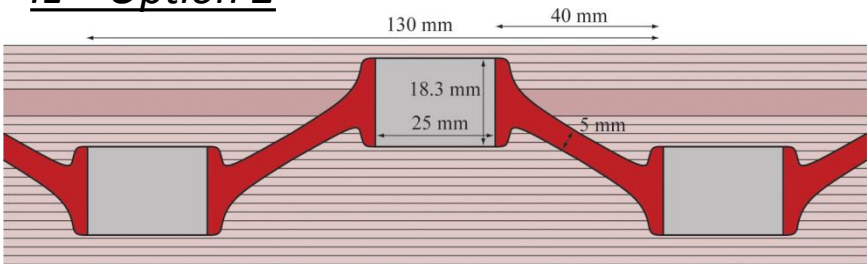

## OL

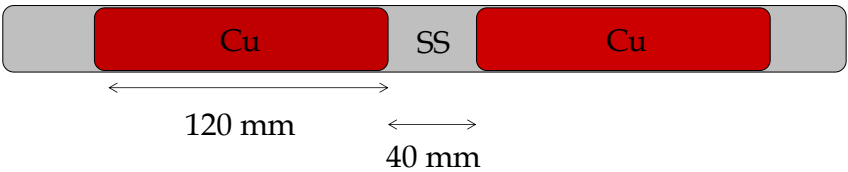

## Simulation for 100 W/cm<sup>2</sup>, $\tau = 47$ ms

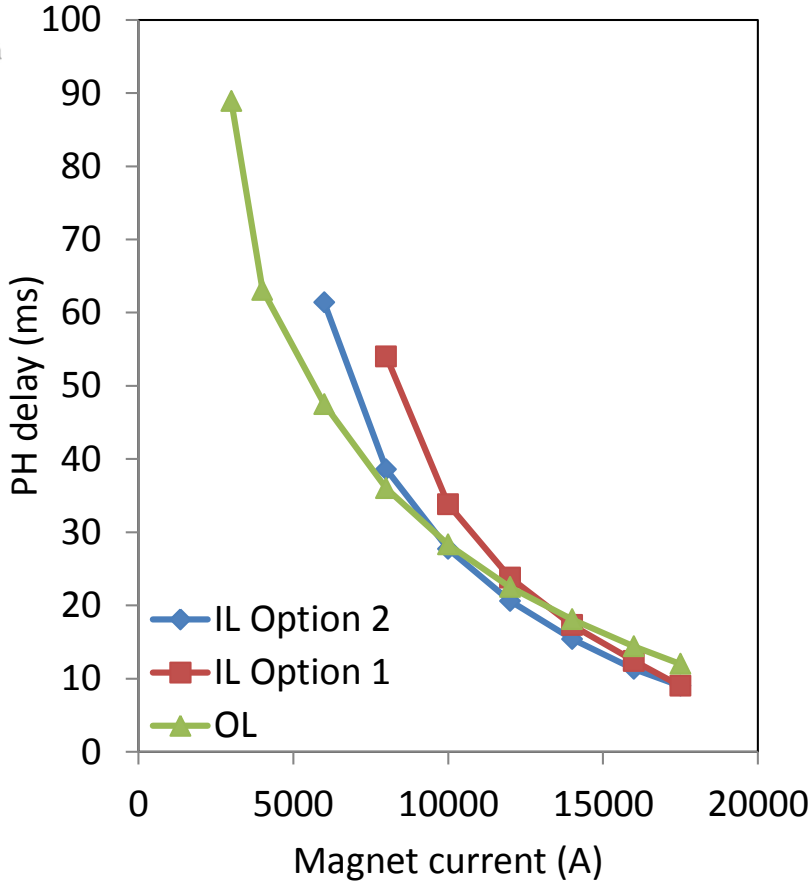

All with polyimide 50  $\mu$ m

# Summary – Delays at ~80% SSL

Magnet	Ins. Btw. PH and bare cable	PH power and $\tau$ (RC)	Measur.	Simulat.	Delta (ms)	Delta  (%)
HQ01e (C9) – OL	25 $\mu\text{m}$ Kapt + 90 $\mu\text{m}$ G10	45 W/cm <sup>2</sup> 40-45 ms	8	10	2	25
HQ01e (C9) – IL	25 $\mu\text{m}$ Kapt + 90 $\mu\text{m}$ G10	50 W/cm <sup>2</sup> 40-45 ms	13	7	-5	46
HQ02a1 (C20) – OL	75 $\mu\text{m}$ Kapt + 90 $\mu\text{m}$ G10	55 W/cm <sup>2</sup> 45 ms	18	16	-2	11
HQ02a1 (C20) – IL	75 $\mu\text{m}$ Kapt + 90 $\mu\text{m}$ G10	55 W/cm <sup>2</sup> 50 ms	11	10	-1	9
LQ (OL)	25 $\mu\text{m}$ Kapt + 90 $\mu\text{m}$ G10	40 W/cm <sup>2</sup> 35 ms	-	11	-	-
11 T* (MBHSP01) (Thinner ins.)	76 $\mu\text{m}$ Kapt + 200 $\mu\text{m}$ G10	~19 W/cm <sup>2</sup> 25 ms	-	25	-	-
11 T* (MBHSP01) (Thicker ins.)	203 $\mu\text{m}$ Kapt + 200 $\mu\text{m}$ G10	~19 W/cm <sup>2</sup> 25 ms	-	55	-	-
11 T* (MBHSP02)	114 $\mu\text{m}$ Kapt + 200 $\mu\text{m}$ G10	~40 W/cm <sup>2</sup> 16 ms	24	29	5	19
QXF (OL)	50 $\mu\text{m}$ Kapt + 150 $\mu\text{m}$ G10	100 W/cm <sup>2</sup> 47 ms	-	12	-	-
QXF (IL)	50 $\mu\text{m}$ Kapt + 150 $\mu\text{m}$ G10	100 W/cm <sup>2</sup> 47 ms	-	9	-	-

# Summary – Delays at ~50% SSL

Magnet	Ins. Btw. PH and bare cable	PH power and $\tau$ (RC)	Measur.	Simulat.	Delta (ms)	Delta  (%)
HQ01e (C9) – OL	25 $\mu\text{m}$ Kapt + 90 $\mu\text{m}$ G10	45 W/cm <sup>2</sup> 40-45 ms	20	22	2	10
HQ01e (C9) – IL	25 $\mu\text{m}$ Kapt + 90 $\mu\text{m}$ G10	50 W/cm <sup>2</sup> 40-45 ms	19	12	-7	37
HQ02a1 (C20) – OL	75 $\mu\text{m}$ Kapt + 90 $\mu\text{m}$ G10	55 W/cm <sup>2</sup> 45 ms	40	37	-3	8
HQ02a1 (C20) – IL	75 $\mu\text{m}$ Kapt + 90 $\mu\text{m}$ G10	55 W/cm <sup>2</sup> 50 ms	25	21	-4	16
LQ (OL)	25 $\mu\text{m}$ Kapt + 90 $\mu\text{m}$ G10	40 W/cm <sup>2</sup> 35 ms	16	21	5	24
11 T* (MBHSP01) (Thinner ins.)	76 $\mu\text{m}$ Kapt + 200 $\mu\text{m}$ G10	~19 W/cm <sup>2</sup> 25 ms	82	78	-4	5
11 T* (MBHSP01) (Thicker ins.)	203 $\mu\text{m}$ Kapt + 200 $\mu\text{m}$ G10	~19 W/cm <sup>2</sup> 25 ms	207	235	28	13
11 T* (MBHSP02)	114 $\mu\text{m}$ Kapt + 200 $\mu\text{m}$ G10	~40 W/cm <sup>2</sup> 16 ms	69	51	-18	36
QXF (OL)	50 $\mu\text{m}$ Kapt + 150 $\mu\text{m}$ G10	100 W/cm <sup>2</sup> 47 ms	-	28	-	-
QXF (IL)	50 $\mu\text{m}$ Kapt + 150 $\mu\text{m}$ G10	100 W/cm <sup>2</sup> 47 ms	-	34 (opt. 1) 28 (opt. 2)	-	-

# Some references

---

## **Model and simulations:**

- T. Salmi, et al., IEEE, trans. on appl. supercond., 24 (3), 2014
- T. Salmi, et al., IEEE, trans. on appl. supercond., 24 (4), 2014
- T. Salmi, et al., Proc. WAMSDO, 2013

## **HQ delay measurements and parameters:**

- H. Bajas, et al., IEEE, trans. on appl. supercond., 23 (3), 2014
- G. Chlachidze, et al., IEEE, trans. on appl. supercond., 24 (3), 2014
- F. Borgnolutti, et al., IEEE, trans. on appl. supercond., 24 (3), 2014

## **LQ delay measurements and parameters:**

- G. Ambrosio, et al., IEEE, trans. on appl. supercond., 21 (3), 2014
- G. Chlachidze, et al., TD-10-001, 2001
- T. Salmi, et al, Proc. CEC, vol. 57, 2012

## **11 T delay measurements and parameters:**

- A. V. Zlobin, et al., IEEE, trans. on appl. supercond., 24 (3), 2014
- G. Chlachidze, Proc. WAMSDO, 2013
- E. Barzi, et al., FERMILAB-TM-2552-TD

## **QXF parameters:**

- SQXF1 design report v2b, downloaded from the US LARP plone site, March 14, 2014

Also information, data, and input from Guram C., Fred N., Helene F., Bernhard A, Maxim M., .....

# Additional material

---

# HD3

PH peak power =  
 42 W/cm<sup>2</sup> (V = 225 V),  
 55 W/cm<sup>2</sup> (V = 260 V),  
 $\tau = 48$  (L1), 42 (L2) ms  
 Kapton thickness = 25  $\mu$ m

HD3 Layer 1



HD3 Layer 2

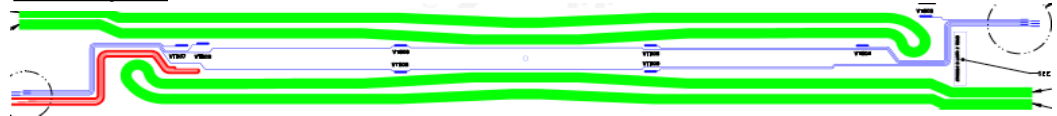

Layer 2 (outer)

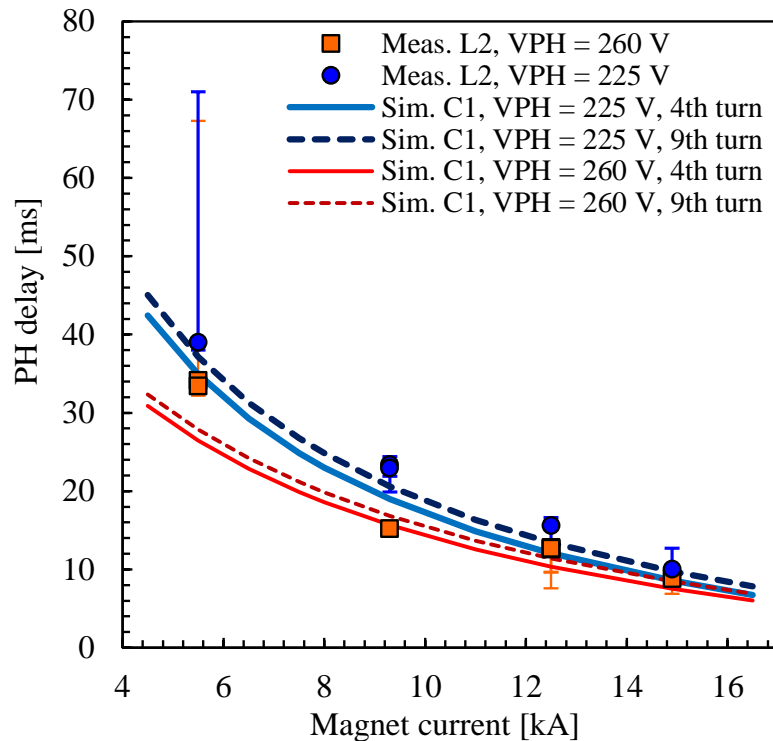

Layer 1 (inner)

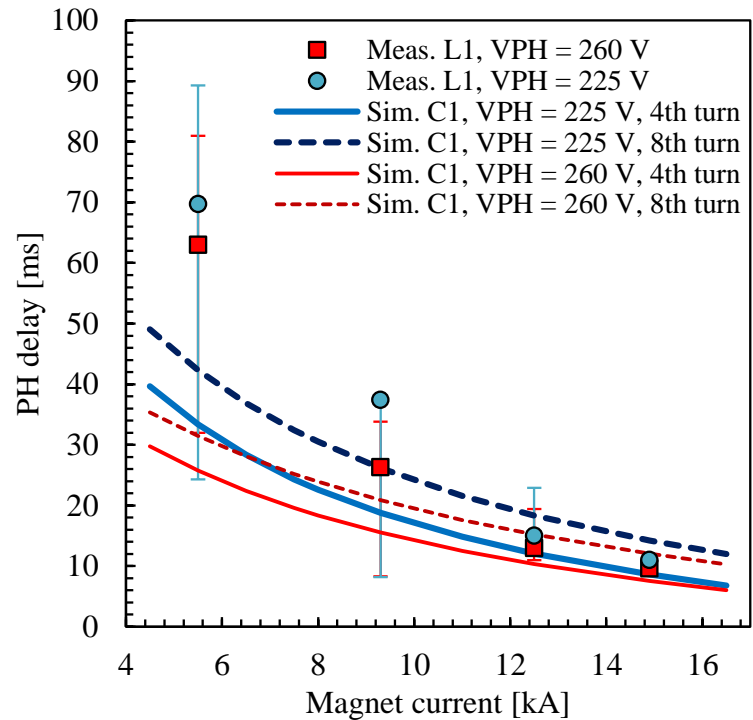

# Simulation sensitivity analysis

- An individual input parameter, or material property, is varied by +/- 10%
- The relative delay response is studied
- A delay at 80% of SSL

**Biggest impact: Field, PH power and cable insulation thickness**

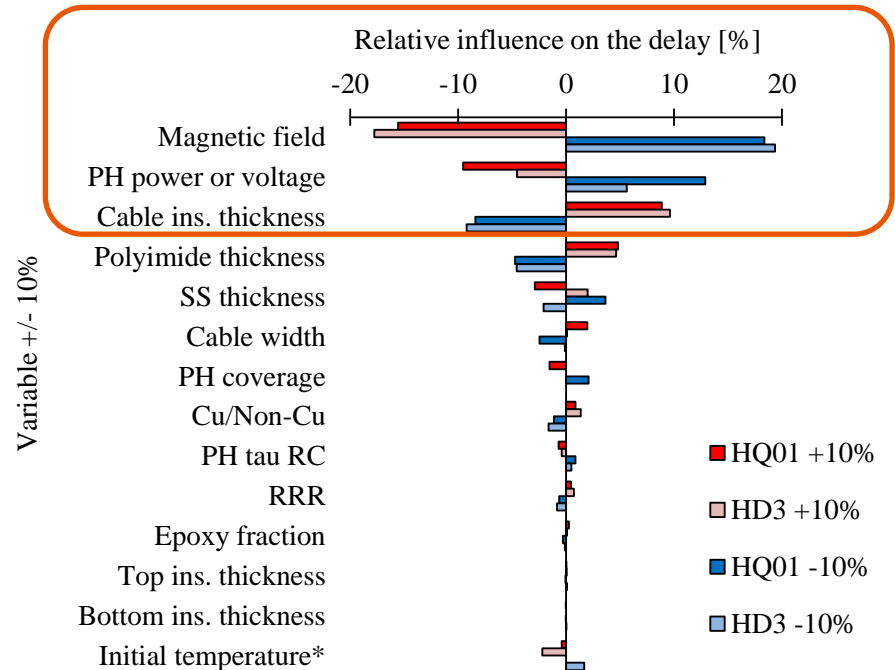
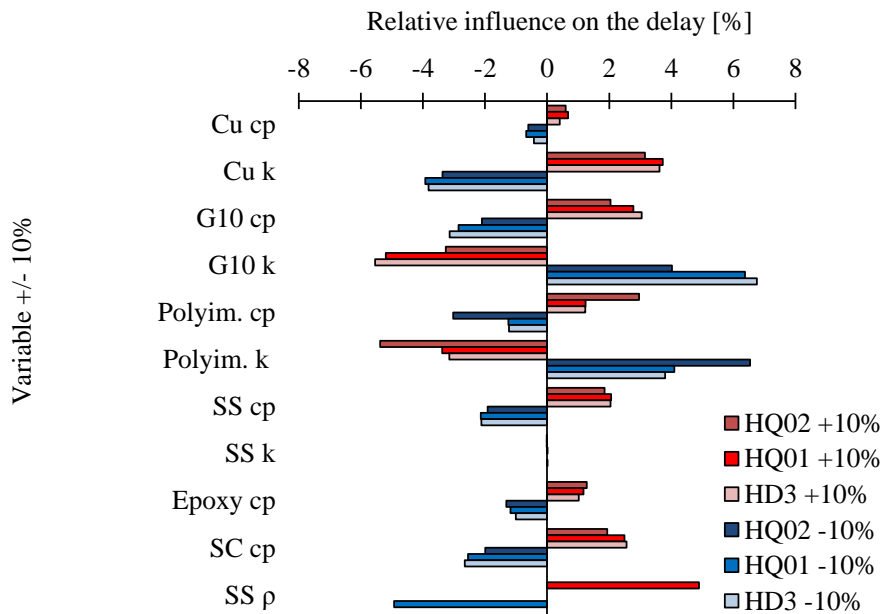

# Simulation parameters (to be completed)

	QXF	HQ01/HQ02	11 T (MBHSP01 / MBHSP02)	HD3 (C3, C1)
SSL @ 1.9 K (kA9)		19.3 / 18.3	15.4 / 16.0	20.7 (C3)
SSL @ 4.4 K (kA)		17.5 / 16.6	13.8 / 14.3	18.7, 18.9
Operation current	17500 A			
Bpeak field at lop	12.1 T			
Transposition pitch (mm)	109			
# of strands	40	35	40	51
Strand diam. (mm)	0.85	0.8 / 0.778	0.7	
Cu fraction	0.55	1.05 / 1.20	1.02	0.83, 0.65
RRR	150	190 / 155	100	150, 100
Reacted cable width (mm)	18.5	15.0	14.9	22.0
Insulation (mm)	0.15	0.09 / 0.1	0.1 + 0.1	0.1
Voids fraction (epoxy)	0.15	0.12 / 0.15	0.12	0.12
Bc20m and C for Jc fit	30.88 T and 1519 TA			
Midplane thicken. (per coil) (mm)	0.250	0.35	0.35	0.55
Insulation btw IL ss heater and the bore (mm)	0.150	0.25	-	0.635 (to L1)