

IMPEDANCE ISSUES FOR FCC-hh

Elias Métral

- ◆ **Main goal of this talk:** review the LHC experience during Run 1 and the upgrade studies to see what needs to be done to study the collective effects (and in particular the ones related to impedances) for FCC-hh
- ◆ **Introduction**
- ◆ **LHC and HL-LHC impedance models**
- ◆ **LHC experience during Run 1 (2010-2012)**
 - Coherent instabilities
 - Beam-induced RF heating
- ◆ **CERN RF fingers task force in 2012**
- ◆ **Conclusion**

INTRODUCTION (1/8)

- ◆ Large values of the accelerator impedance influence the motion of trailing particles, in the longitudinal and transverse directions, leading to energy loss, beam instabilities, or secondary effects such as excessive heating of sensitive components at or near the chamber wall (the so-called beam-induced RF heating). **Beam-induced RF heating has been observed in many places, for instance in several CERN LHC components during the 2011 and 2012 runs when the bunch/beam intensity was increased and/or the bunch length reduced. This caused beam dumps and delays in operation (reducing integrated luminosity) as well as considerable damage to some equipment. Furthermore, despite the excellent performance of the LHC in 2012, with a record peak luminosity at 4 TeV corresponding to 77 % of the 7 TeV design luminosity of $10^{34} \text{ cm}^{-2}\text{s}^{-1}$, the intensity ramp-up was perturbed by several types of instabilities, one of which could not be damped at the end of the run.** These limitations could be more severe in the future and therefore impedances should be treated with great care

INTRODUCTION (2/8)

LHC parameters

Beam energy	E	7 TeV (4 in 2012)
Number of particles per bunch	N_b	1.15 10^{11} (~ 1.6 in 2012)
Number of bunches per beam	M	2808 (1380 in 2012)
Bunch spacing	Δt	25 ns (50 in 2012)
Norm. rms. trans. emittance	ε	3.75 μm (~ 2.2 in 2012)
Revolution frequency	f_0	11245 Hz
Rms bunch length	σ_z	7.5 cm (~ 10 in 2012)
Bunch charge	Q	18.4 nC (25.6 in 2012)
Total beam current	I_b	0.58 A (~ 0.4 in 2012)

=> **Bunch brightness reached: ~ (1.6 / 1.15) × (3.75 / 2.2) ~ 2.4 times larger than nominal (at 4 TeV)!**

INTRODUCTION (3/8)

Parameter	nominal	25ns	50ns
N_b	1.15E+11	2.2E+11	3.5E+11
n_b	2808	2808	1404
N_{tot}	3.2E+14	6.2E+14	4.9E+14
beam current [A]	0.58	1.11	0.89
x-ing angle [μ rad]	300	590	590
beam separation [σ]	9.9	12.5	11.4
β^* [m]	0.55	0.15	0.15
ϵ_n [μ m]	3.75	2.50	3
ϵ_L [eVs]	2.51	2.51	2.51
energy spread	1.20E-04	1.20E-04	1.20E-04
bunch length [m]	7.50E-02	7.50E-02	7.50E-02
IBS horizontal [h]	80 -> 106	18.5	17.2
IBS longitudinal [h]	61 -> 60	20.4	16.1
Piwinski parameter	0.68	3.12	2.85
Reduction factor 'R1*H1' at full crossing angle (no crabbing)	0.828	0.306	0.333
Reduction factor 'H0' at zero crossing angle (full crabbing)	0.991	0.905	0.905
beam-beam / IP without Crab Cavity	3.1E-03	3.3E-03	4.7E-03
beam-beam / IP with Crab cavity	3.8E-03	1.1E-02	1.4E-02
Peak Luminosity without levelling [$\text{cm}^{-2} \text{s}^{-1}$]	1.0E+34	7.4E+34	8.5E+34
Virtual Luminosity: $L_{peak} \cdot H_0 / R_1 / H_1$ [$\text{cm}^{-2} \text{s}^{-1}$]	1.2E+34	21.9E+34	23.1E+34
Events / crossing without levelling	19 -> 28	210	475
Levelled Luminosity [$\text{cm}^{-2} \text{s}^{-1}$]	-	5E+34	2.50E+34
Events / crossing (with leveling for HL-LHC)	*19 -> 28	140	140
Leveling time [h] (assuming no emittance growth)	-	9.0	18.3

HL-LHC parameters

INTRODUCTION (4/8)

Physics Parameters

	LHC	HL-LHC	HE-LHC	FCC-hh
Cms energy [TeV]	14		33	100
Luminosity [$10^{34}\text{cm}^{-2}\text{s}^{-1}$]	1	5	5	5
Bunch distance [ns]		25		25 (5)
Background events/bx	27	135	147	170 (34)
Bunch length [cm]	7.5	7.5	7.5	8

- Two main experiments sharing the beam-beam tunes shift
 - Two reserve experimental areas not contributing to tunes shift

Operation

	FCC-hh
Luminosity lifetime [h]	19.1 (15.9)
Turn-around time [h]	5
Optimum run time [h]	12.1 (10.7)
Int. lumi / day [fb^{-1}]	2.2 (2.1)

Basic Machine Parameters

	LHC	HL-LHC	HE-LHC	FCC-hh
Dipole field [T]	8.33		20	16 (20)
Magn. Aperture [mm]	56		40	40
Arc fill factor [%]	79		79	79
Straight section		8x0.5km		16.8km
Total length		26.7km		100(83)km

Beam Parameters

	LHC	HL-LHC	HE-LHC	FCC-hh
Bunch charge [10^{11}]	1.15	2.2	1	1 (0.2)
Norm. emitt. [μm]	3.75	2.5	1.38	2.2(0.44)
IP beta-function [m]	0.55	0.15	0.35	1.1
IP beam size [μm]	16.7	7.1	5.2	6.8 (3)
RMS bunch length [cm]	7.55	7.55	7.55	8

*D. Schulte, FCC-hh
kick-off meeting –
March 2014 :
[https://indico.cern.ch/
event/308561/
contribution/0/
material/slides/1.pdf](https://indico.cern.ch/event/308561/contribution/0/material/slides/1.pdf)*

**For 5 ns
spacing**

INTRODUCTION (5/8)

- ◆ **Wake field** = Electromagnetic field generated by the beam interacting with its surroundings (vacuum pipe, etc.)
 - Energy loss
 - Beam instabilities
 - Excessive heating => “Beam-induced RF heating”
- ◆ **Impedance** = Fourier transform of the wake field (wake function)

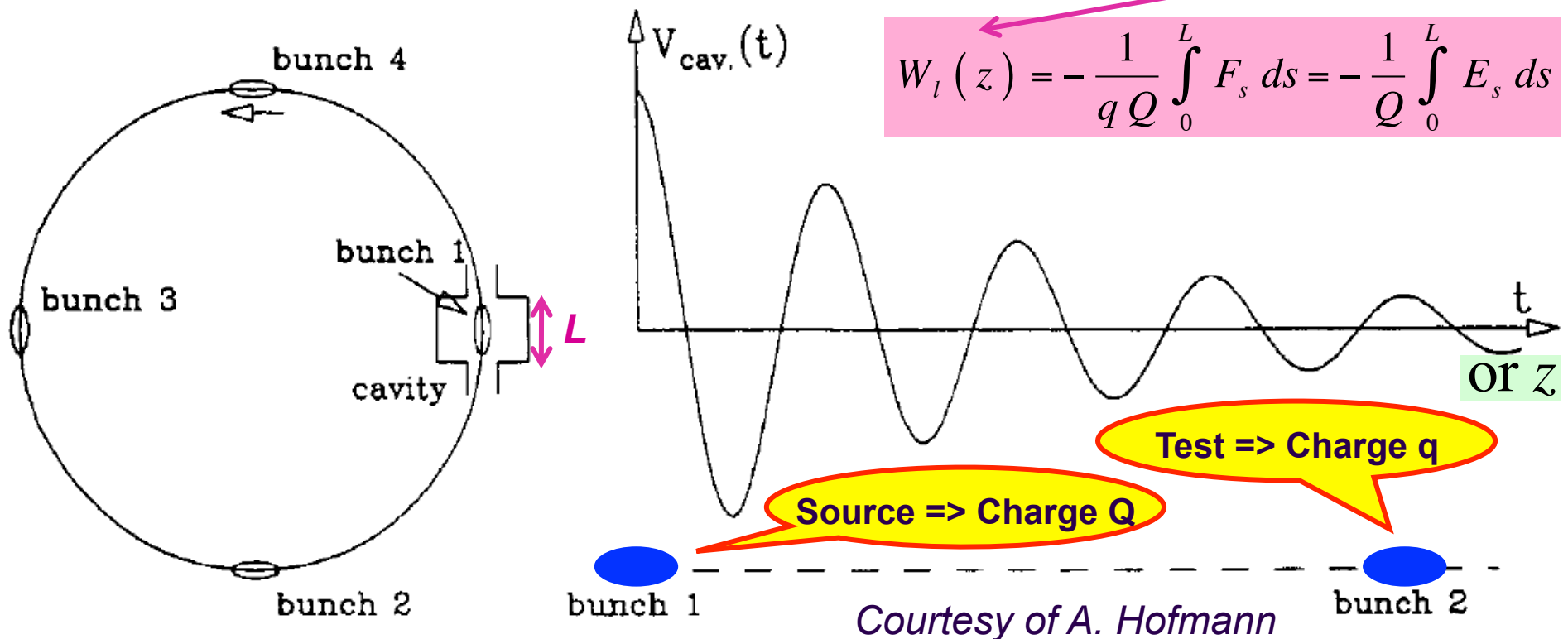

INTRODUCTION (6/8)

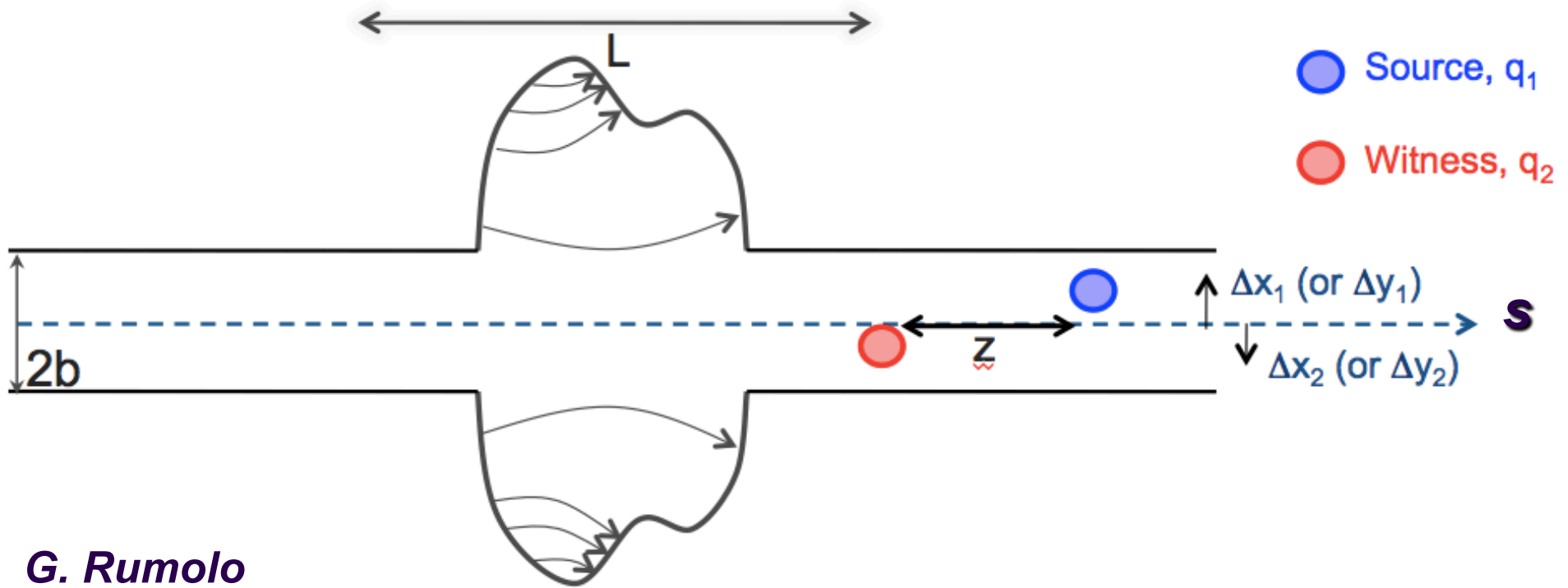

◆ 2 fundamental approximations behind the “conventional impedances / wakes”

■ Rigid-beam approximation $\Rightarrow z = s_{witness} - s_{source} = \text{Constant}$

■ Impulse approximation $\Rightarrow v \Delta p = \int_0^L F ds$

Wake potential

INTRODUCTION (7/8)

- ◆ Sessler-Vaccaro formalism (1967) works very well for longitudinal impedance

$$\int_0^L F_l ds = -e^2 W_l(z)$$

- ◆ Transverse case is more complicated

- Conventional definition

$$\int_0^L F_r ds = -e^2 r_{source} W_r(z)$$

- ... but several terms need to be added to correctly describe the beam dynamics

$$\int_0^L F_r ds = -e^2 r_{source} W_r(z) - e^2 r'_{source} A_r(z) - e^2 r_{witness} D_r(z) + \dots$$

Driving (or dipolar) wake

Angular wake =>
Fast damping in
VEPP-2 and BEP

Detuning (or quadrupolar) wake =>
Effect on tune shift,
TMCI, etc.

INTRODUCTION (8/8)

◆ Example of the importance of the detuning (quadrupolar) impedance

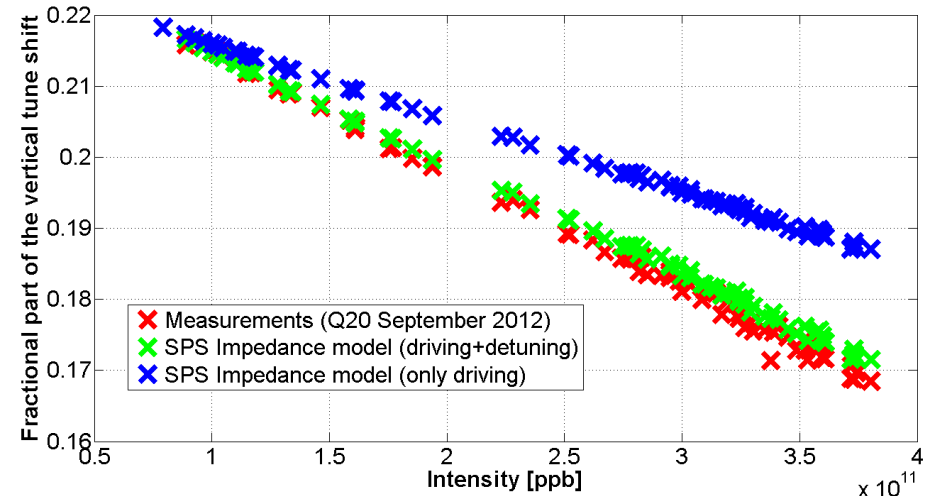
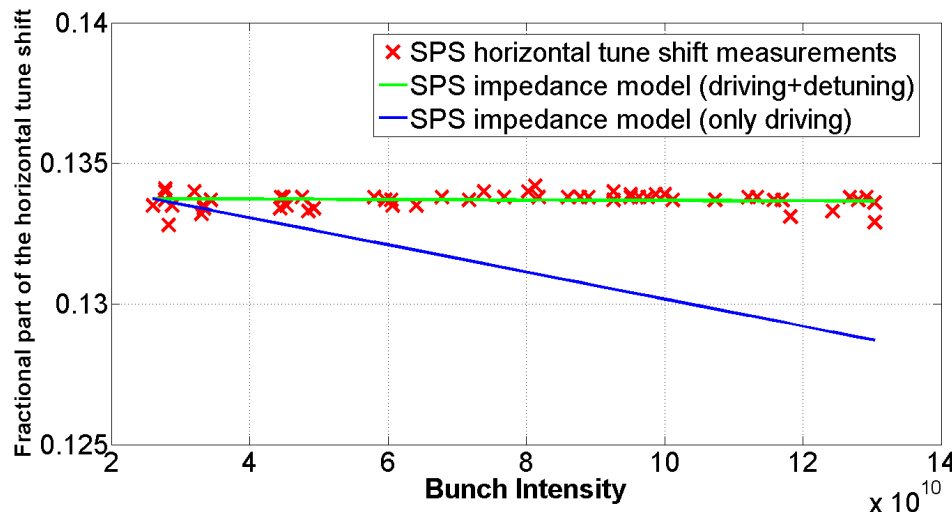

G. Rumolo et al.

- ◆ \Rightarrow Many impedances (which are complex functions of frequency) are needed for each equipment to build the impedance model!
- ◆ Furthermore, the transverse impedance needs to be weighted by the local beta functions (small impedances at large betas are important...)

LHC AND HL-LHC IMPEDANCE MODELS (1/13)

- ◆ **New studies / theories were needed for the LHC graphite collimators (see last talk from Stefano Redaelli about collimation)**

B. Zotter => Fully developed by N. Mounet

- First unstable betatron line $f_{\beta}^1 \approx 8 \text{ kHz}$

- Skin depth for graphite ($\rho = 10 \mu\Omega\text{m}$) $\delta(8 \text{ kHz}) = 1.8 \text{ cm}$

- Collimator thickness $d_{th} = 2.5 \text{ cm}$

$$\Rightarrow \delta(f_{\beta}) = \sqrt{\frac{\rho}{\pi \mu f_{\beta}}} < d_{th}$$

\Rightarrow One could think that the classical “thick-wall” formula would be about right

$$Z_{\perp}^{\text{thick-wall}}(f) \propto \frac{1}{b^3 \sqrt{f}}$$

LHC AND HL-LHC IMPEDANCE MODELS (2/13)

- ◆ **In fact it is not** \Rightarrow The resistive impedance is ~ 2 orders of magnitude lower at ~ 8 kHz !

\Rightarrow A new physical regime was revealed by the LHC collimators

Usual regime : $d_{th}, \delta < b$

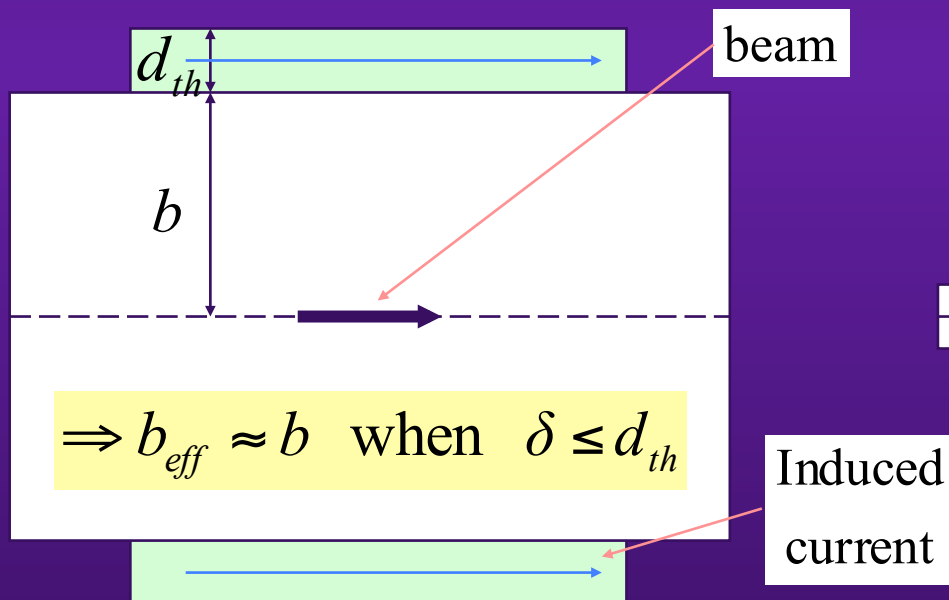

New regime : $d_{th} \gg b, \delta \leq d_{th}$

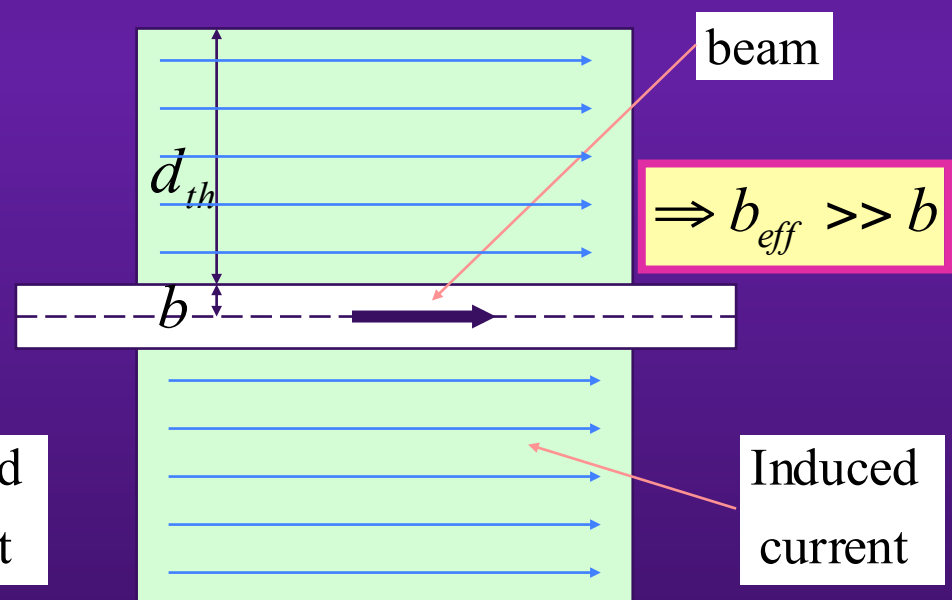

LHC AND HL-LHC IMPEDANCE MODELS (3/13)

- ◆ The interesting frequency range in the LHC lies between few kHz and few GHz. In this case a simple formula can be derived for a cylindrical geometry (in case of the real flat geometry => Yokoya factors), which should be valid for any “relatively” good conductor with real permeability and the permittivity of vacuum. It can be written as (up to a certain frequency which depends on β)

$$Z_x^{\text{Wall}}(f) = \frac{j L Z_0}{2 \pi b^2 \beta \gamma^2} + \beta \frac{j L Z_0}{\pi b^2} \times \frac{1}{1 - \frac{x_2}{\mu_r} \times \frac{K'_1(x_2)}{K_1(x_2)}}$$

with

$$x_2 = (1 + j) \frac{b}{\delta}$$

$$\delta = \sqrt{\frac{2}{\mu_0 \mu_r \sigma \omega}}$$

LHC AND HL-LHC IMPEDANCE MODELS (4/13)

- ◆ Furthermore, this equation can be simplified even further in the two limiting cases using the following equations

$$\frac{K'_1(x_2)}{K_1(x_2)} = \begin{cases} -\frac{1}{x_2} & \text{if } |x_2| \ll 1 \\ -1 & \text{if } |x_2| \gg 1 \end{cases}$$

- ◆ When $|x_2| \ll 1$, i.e. at very low frequency, the transverse “wall impedance” approaches a constant inductive value

$$Z_x^{\text{Wall}}(f \rightarrow 0) = j \frac{L Z_0}{2\pi \beta b^2} \quad \text{for } \mu_r = 1$$

Only electric images contribute
as there are no ac magnetic images
when $f \rightarrow 0$

LHC AND HL-LHC IMPEDANCE MODELS (5/13)

- ◆ When $|x_2| \gg 1$, the “classical thick-wall formula” is recovered (up to a certain frequency which depends on β)

$$Z_x^{\text{Wall}}(f) = \frac{j L Z_0}{2 \pi b^2 \beta \gamma^2} + (1 + j) \beta \frac{L Z_0 \mu_r \delta}{2 \pi b^3}$$

Coherent part (from the pipe) of the SC impedance => Electric images + ac magnetic images

Classical thick-wall formula for the “RW” impedance

- ◆ Note that the (broad) maximum of the real part of the transverse impedance is reached when $\text{Re}[x_2] \approx 1$, i.e. $\delta \approx b$, which means

$$f_{\text{max,Re}} \approx \frac{\rho}{b^2} \times \frac{1}{\pi \mu_0}$$

LHC AND HL-LHC IMPEDANCE MODELS (6/13)

ZOTTER2005'S THEORY FOR 1 GRAPHITE COLLIMATOR

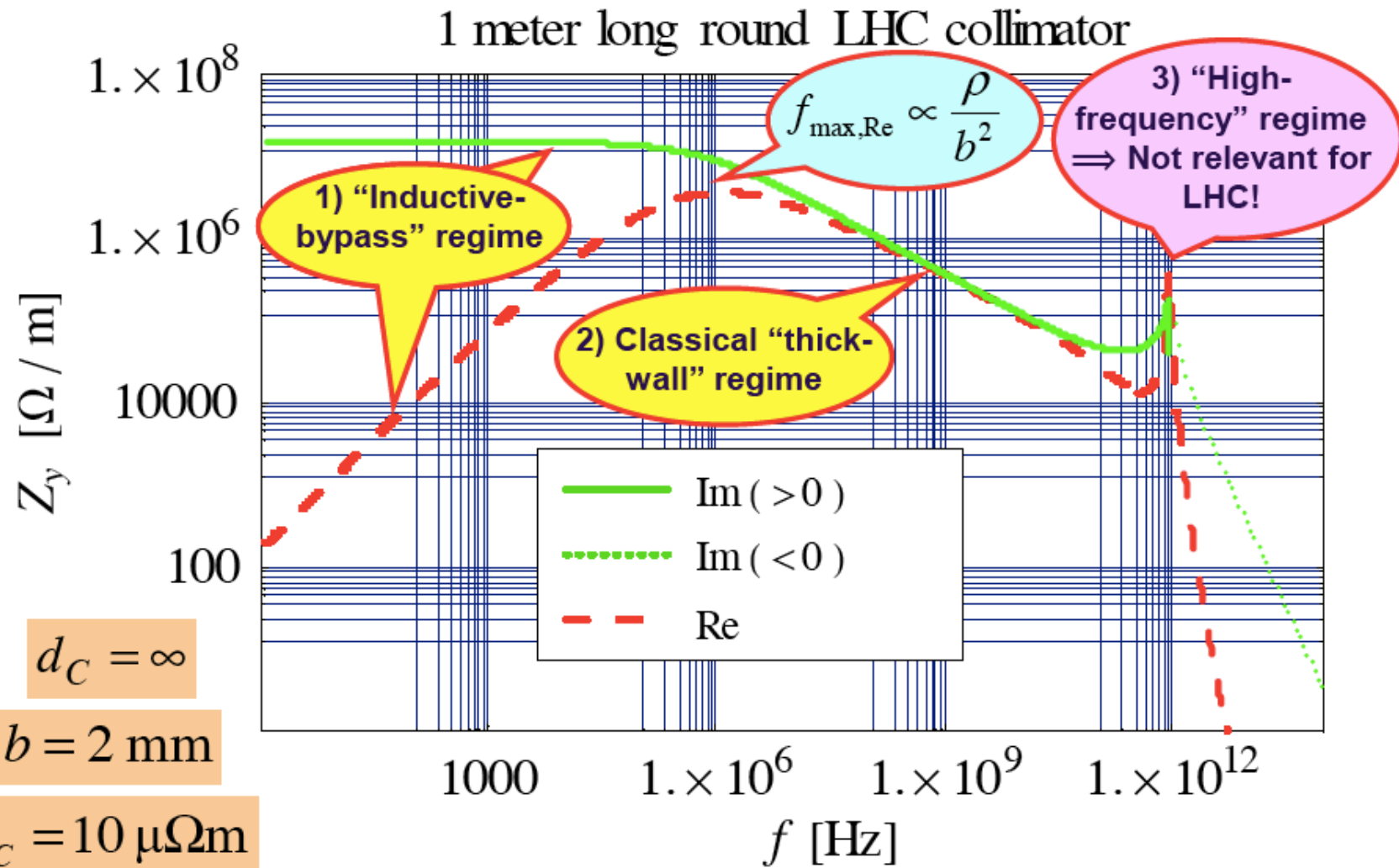

Interesting frequency range for LHC
 \Rightarrow From few kHz to few GHz

LHC AND HL-LHC IMPEDANCE MODELS (7/13)

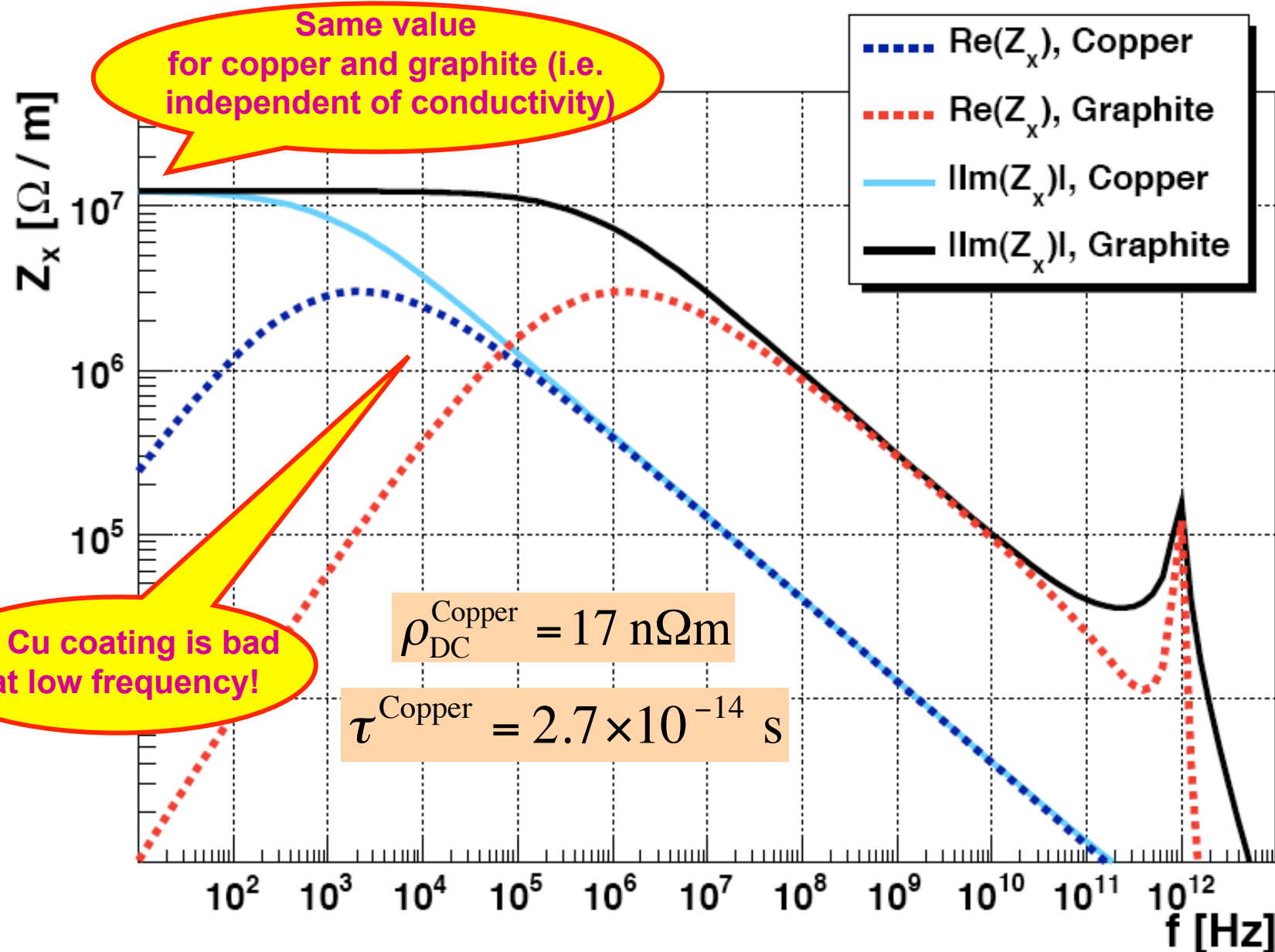

LHC AND HL-LHC IMPEDANCE MODELS (8/13)

- ◆ **A** general code from Nicolas Mounet is available to compute all the “wall impedances” **for cylindrical and flat 2D structures (i.e. neglecting the finite length of the impedance) for any number of layers, any beam velocity, any frequency, any resistivity / permittivity and permeability**
- ◆ **The** effect of the finite length has been studied by Nicolo Biancacci (see in particular his PHD thesis => **The same result was obtained (for our particular case of “long collimators”)**)

LHC AND HL-LHC IMPEDANCE MODELS (9/13)

- ◆ **Beam screen in the LHC:**
 - ~ 90% (beam screen) between 5 and 20K
 - ~ 10% at room temperature (2 mm thick copper beam pipe)
- ◆ **Main purpose of the beam screen: Shield the cold bore from SyncRad => Made of SS to resist to mechanical stresses**
- ◆ **Cu coating to keep the resistance as low as possible**
 - Transverse resistive-wall instability (low-frequency phenomenon, from a few kHz to a few MHz) => Magneto-Resistance important
 - Power loss is a different issue due to the short bunch length + Anomalous Skin Effect + surface roughness (both important at high frequencies)
- ◆ **Drawback from Cu coating: Eddy currents mainly in the Cu layer when quenches => The smaller the copper coating thickness the better for the quench force (which deforms the beam screen horizontally)**
- ◆ **Other impedance issues: pumping slots (for the vacuum) + weld**

LHC AND HL-LHC IMPEDANCE MODELS (10/13)

Courtesy of N. Kos

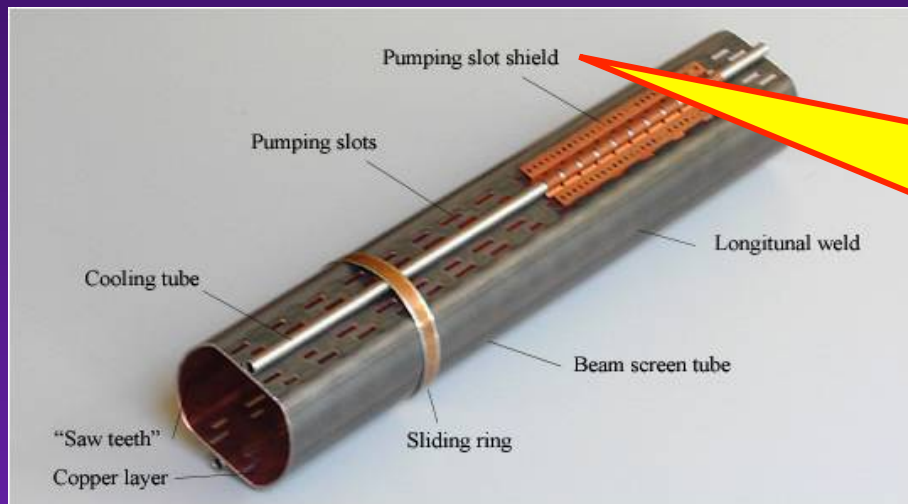

In dipoles, also called baffles, to avoid direct e⁻ path along magnetic field lines to the cold bore (which would then add to the heat load)

Saw teeth in the arcs on Cu

(a series of $\sim 30\text{-}40\ \mu\text{m}$ high steps spaced by $\sim 500\ \mu\text{m}$ in the long. direction, to reduce the forward reflectivity)

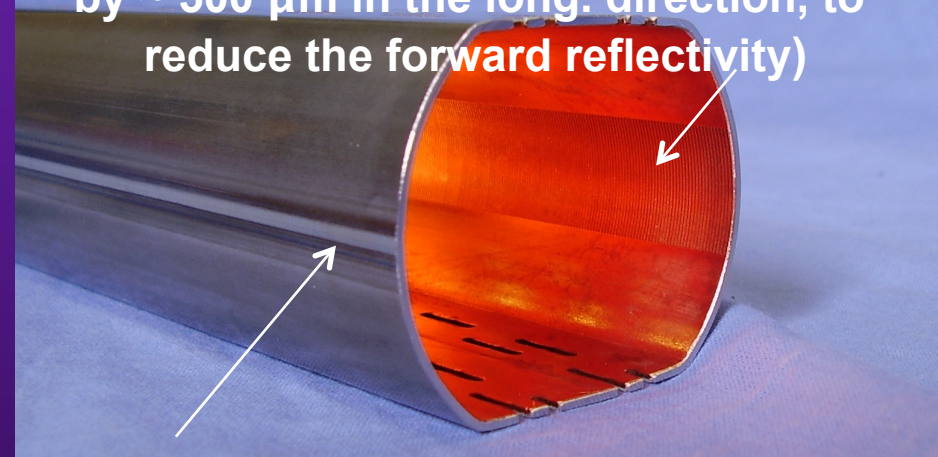

Weld

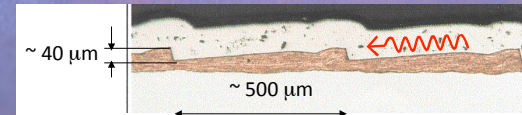

LHC AND HL-LHC IMPEDANCE MODELS (11/13)

- ◆ **Effect of temperature, magnetic field and anomalous skin effect on resistivity to be taken into account**
- ◆ **General remark for “exotic” material**
⇒ **Material characterization needed!**
- ◆ **The impedance of the FCC-hh beam screen has been already discussed by N. Mounet and G. Rumolo at <https://indico.cern.ch/event/289331/contribution/2/material/slides/0.pdf>**
⇒ **Sets a lower limit for the beam pipe aperture**

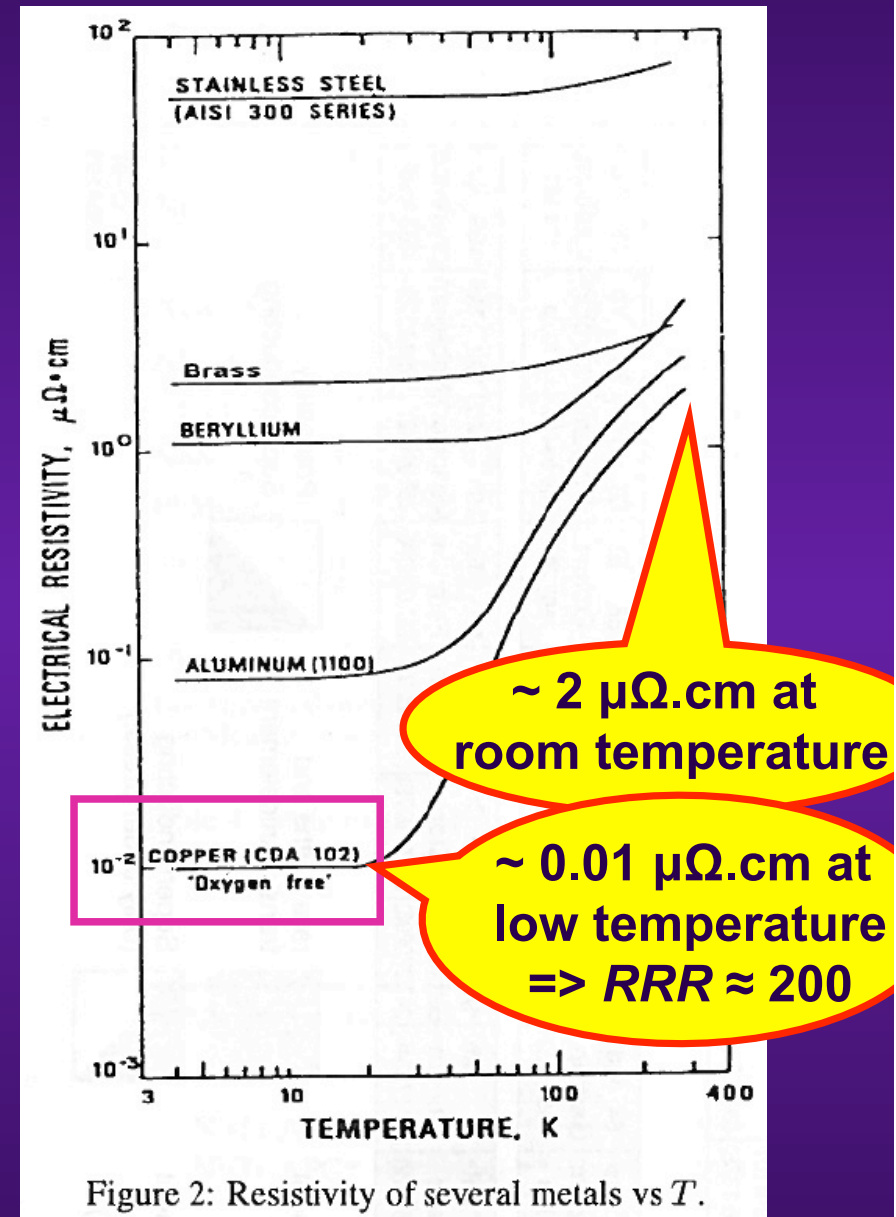

LHC AND HL-LHC IMPEDANCE MODELS (12/13)

- ◆ Lot of effort to refine the LHC impedance model
=> Vertical dipolar impedance only here

Nicolas Mounet

Real part

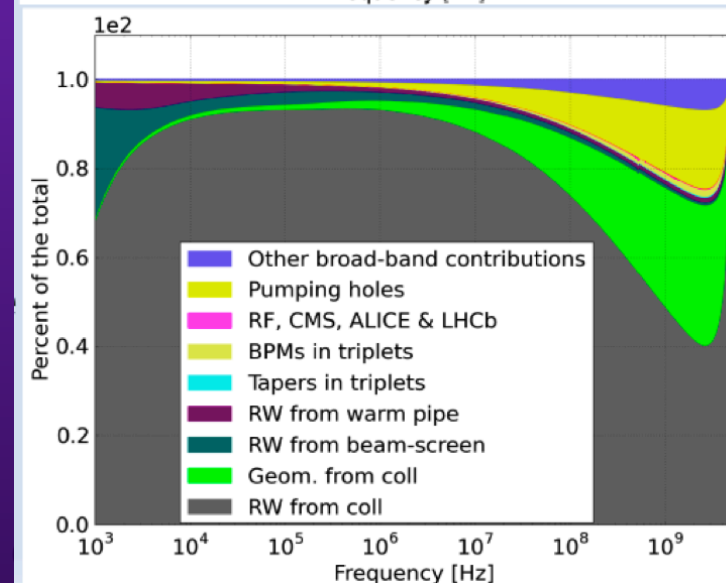
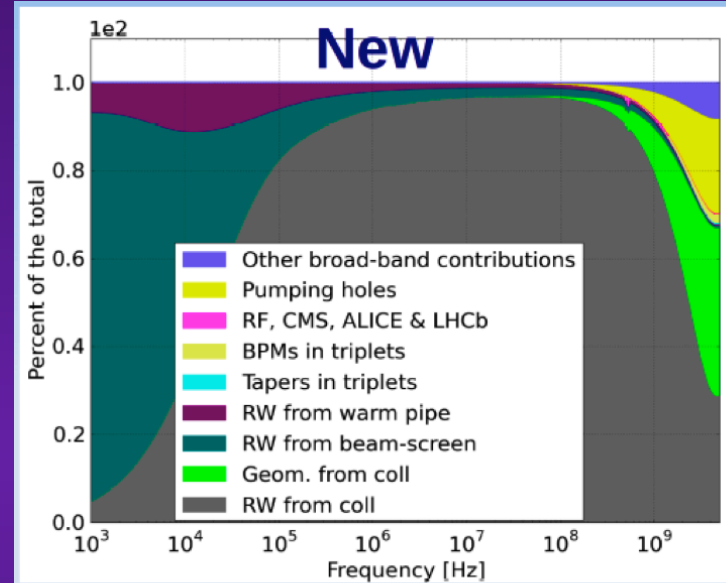
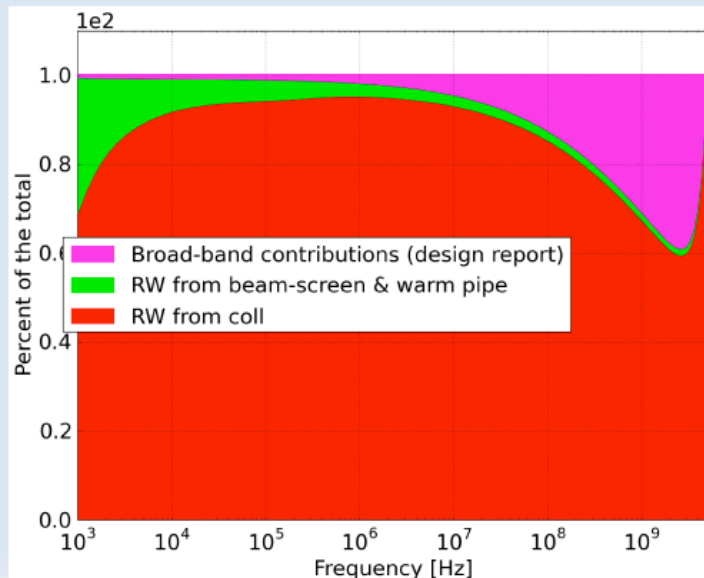
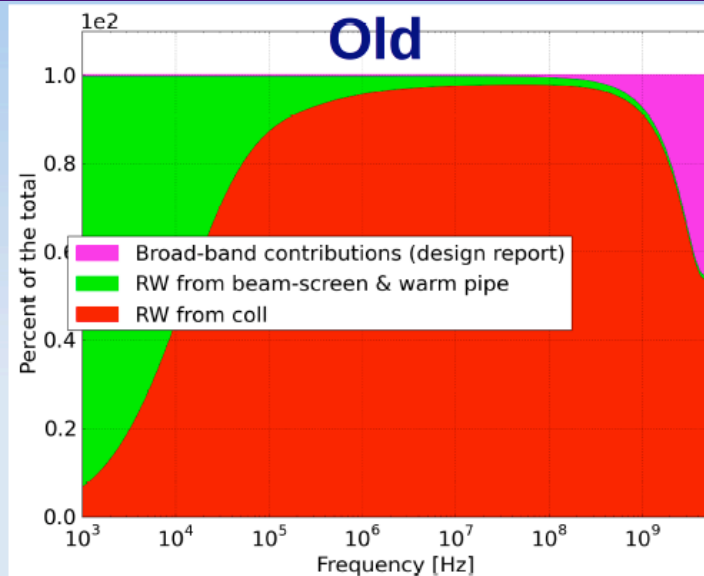

LHC AND HL-LHC IMPEDANCE MODELS (13/13)

◆ First estimate of the HL-LHC impedance model

⇒ Vertical dipolar impedance only here (Re left and Im right)

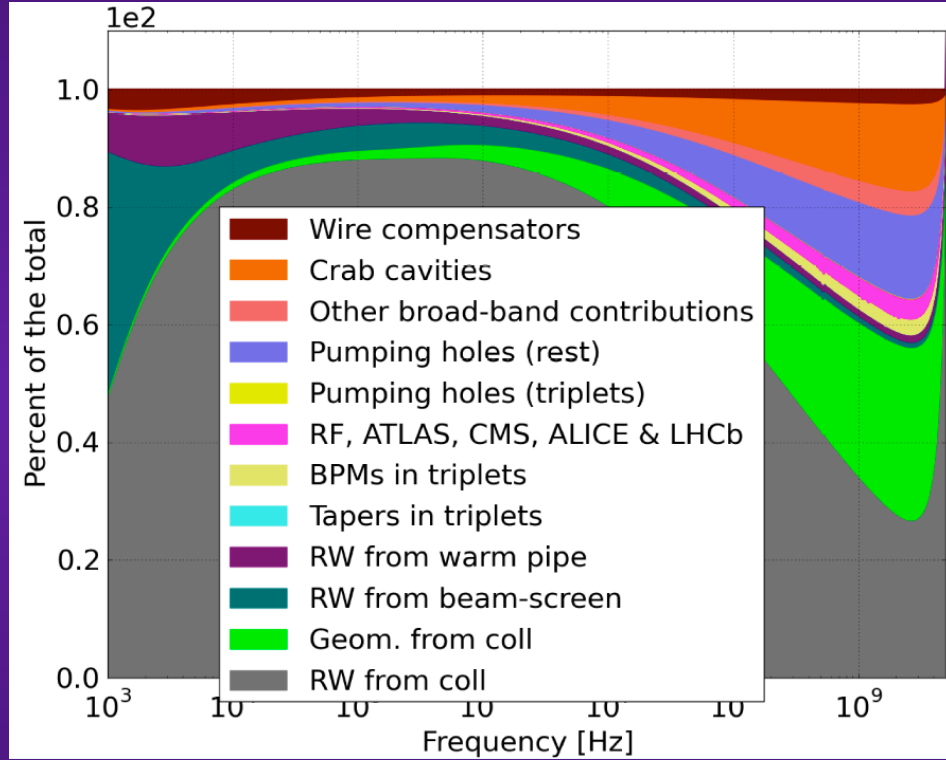
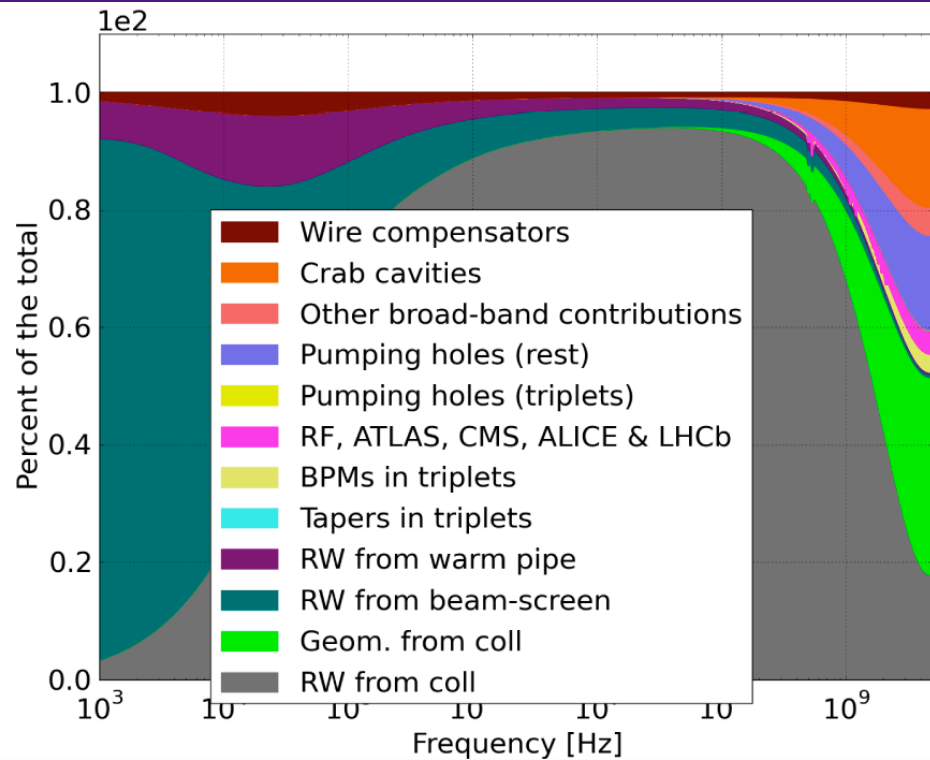

Nicolas Mounet

LHC EXPERIENCE DURING RUN 1: INSTABILITIES (1/13)

- ◆ Several types of instabilities perturbed the intensity ramp-up and 1 instability remained at the end of the Run 1 => Worry for the future...

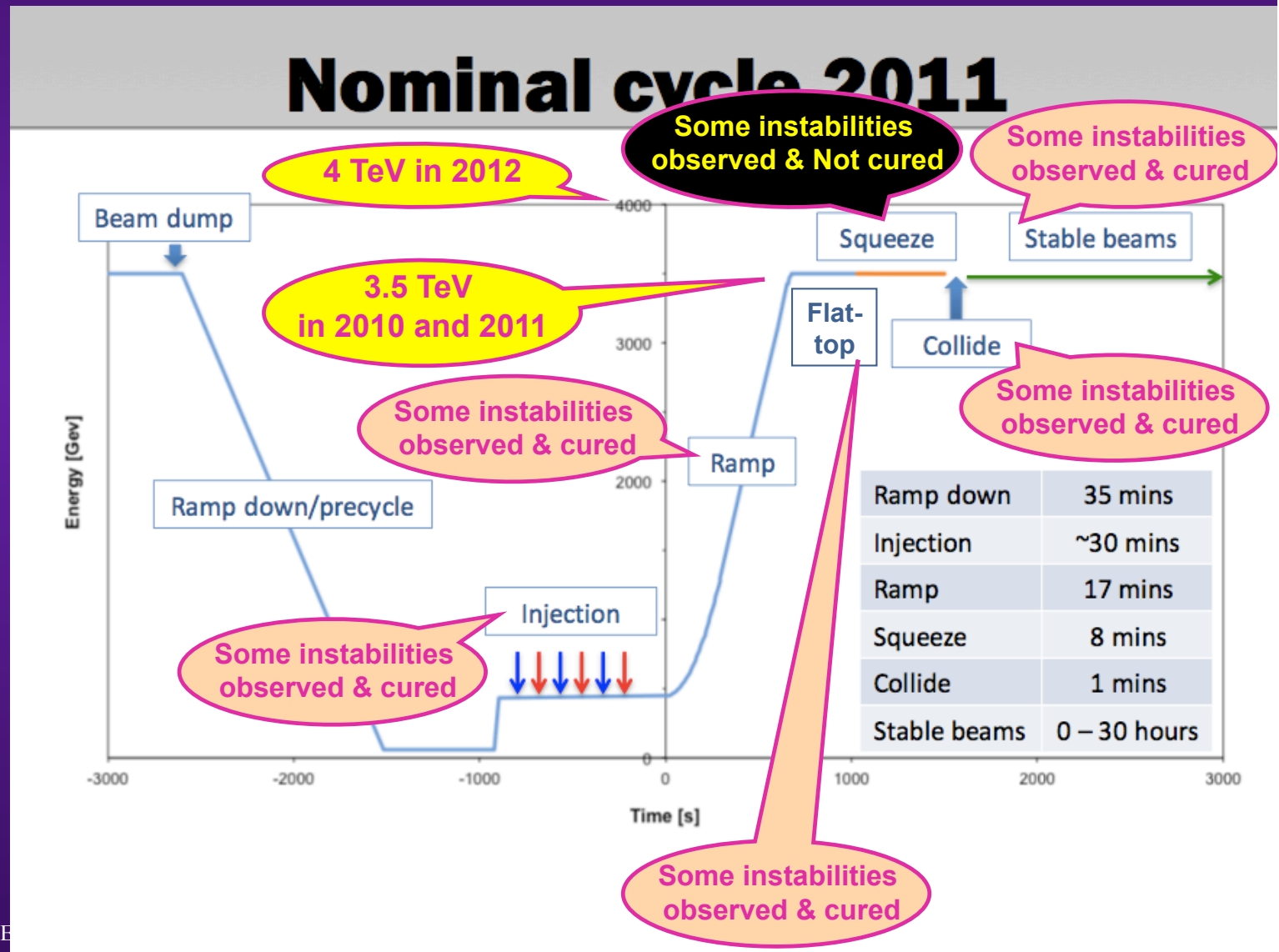

LHC EXPERIENCE DURING RUN 1: INSTABILITIES (2/13)

- ◆ **Reminder: Knobs available to damp transverse coherent instabilities**
 - Transverse tunes and tune split between the 2 beams
 - Coupling between the transverse planes
 - Chromaticities (value and sign)
 - (Landau) octupoles (value and sign) to increase Landau damping
 - Transverse damper (gain and bandwidth: not fully flat / bunch-by-bunch or flat / bunch-by-bunch)
 - Bunch length and / or longitudinal profile

LHC EXPERIENCE DURING RUN 1: INSTABILITIES (3/13)

- ◆ 1) Loss of longitudinal Landau damping during LHC acceleration when longitudinal emittance too small (~ as predicted...)

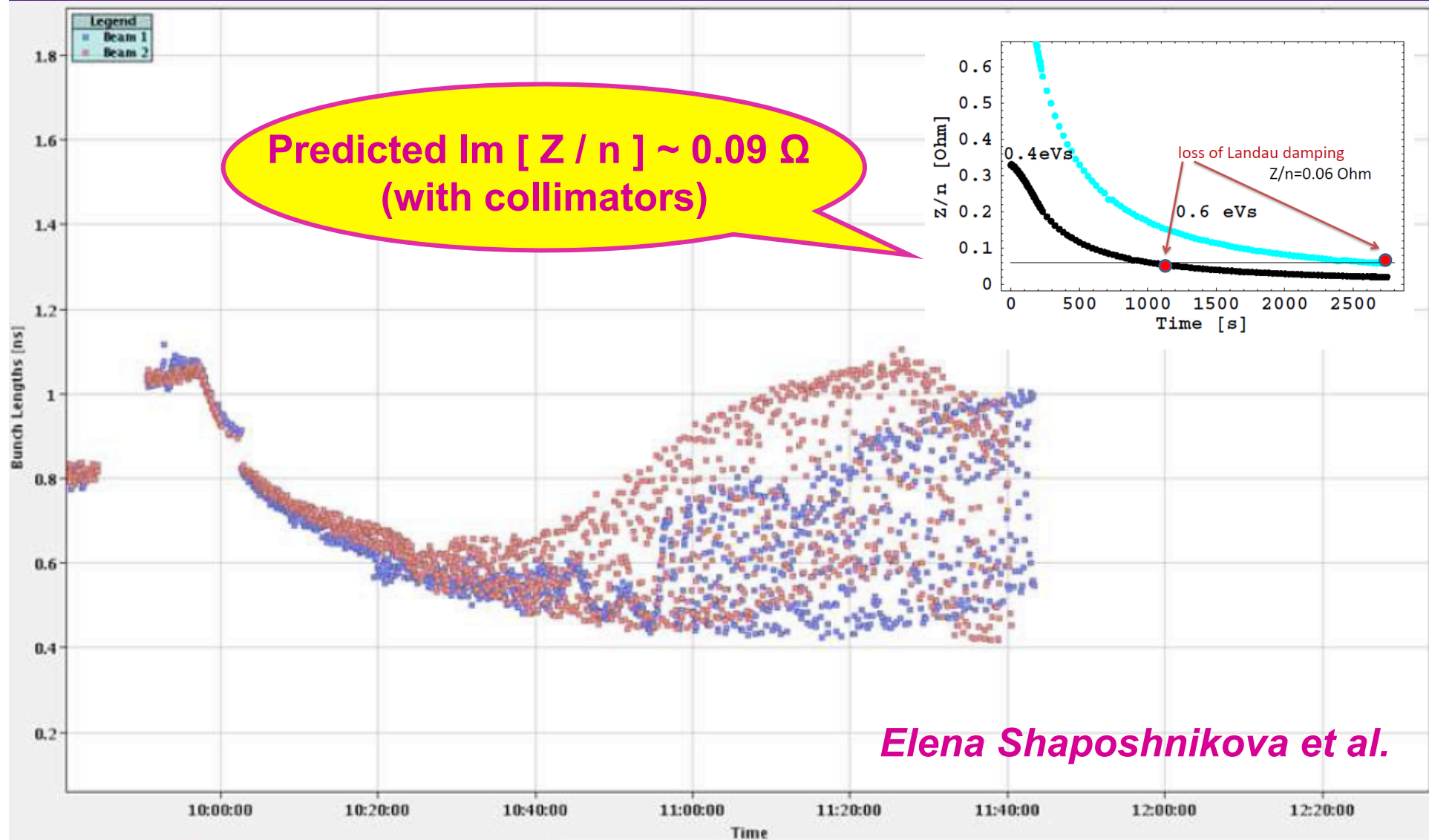

LHC EXPERIENCE DURING RUN 1: INSTABILITIES (4/13)

- ◆ 2) 1st ramp tried with single-bunch of $\sim 1E11$ p/b (both B1 and B2) on SA 15/05/2010 without Landau octupoles

=> Bunch unstable at ~ 1.8 TeV for B1 and ~ 2.1 TeV for B2

=> Famous “Christmas tree”

Dedicated study
on MO 17/05/2010
at 3.5 TeV

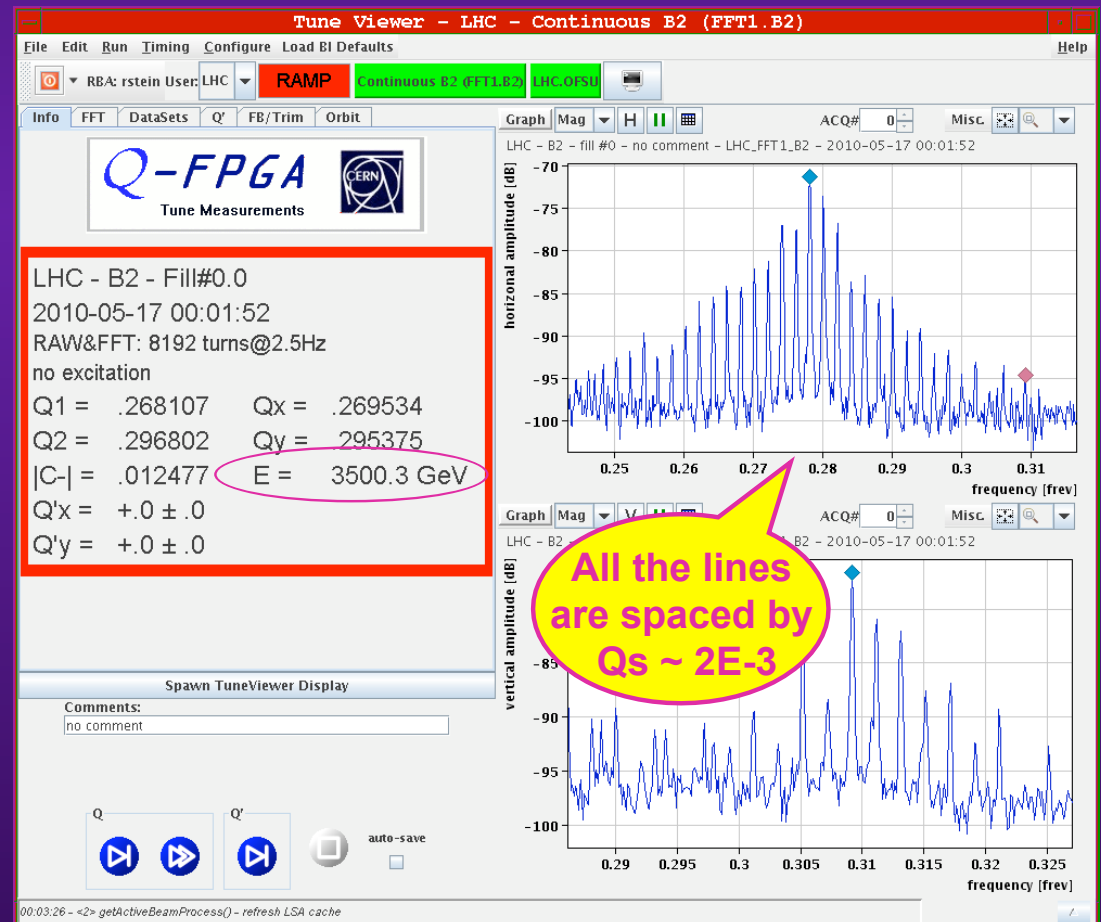

LHC EXPERIENCE DURING RUN 1: INSTABILITIES (5/13)

MEASUREMENTS

(17/05/2010 at 3.5 TeV)

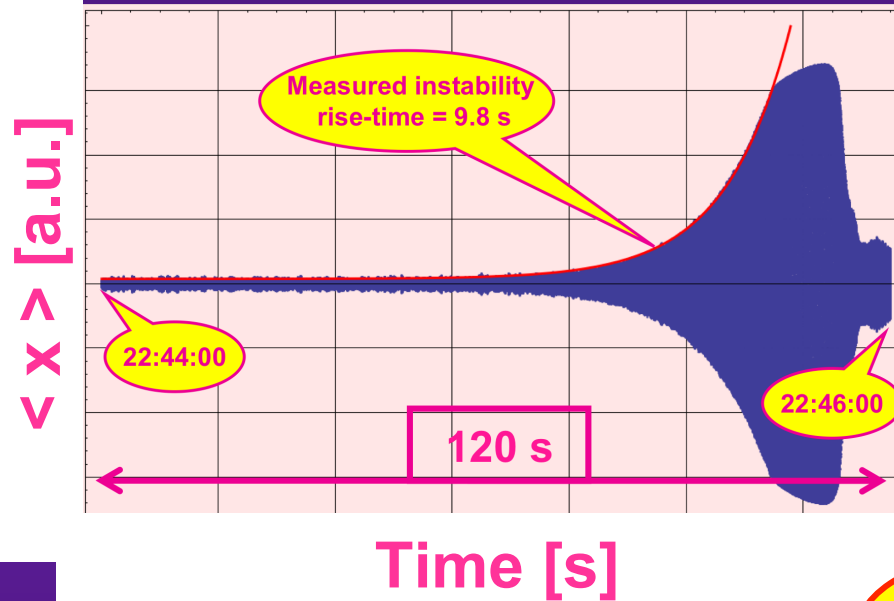

SIMULATIONS

Scan in octupole current

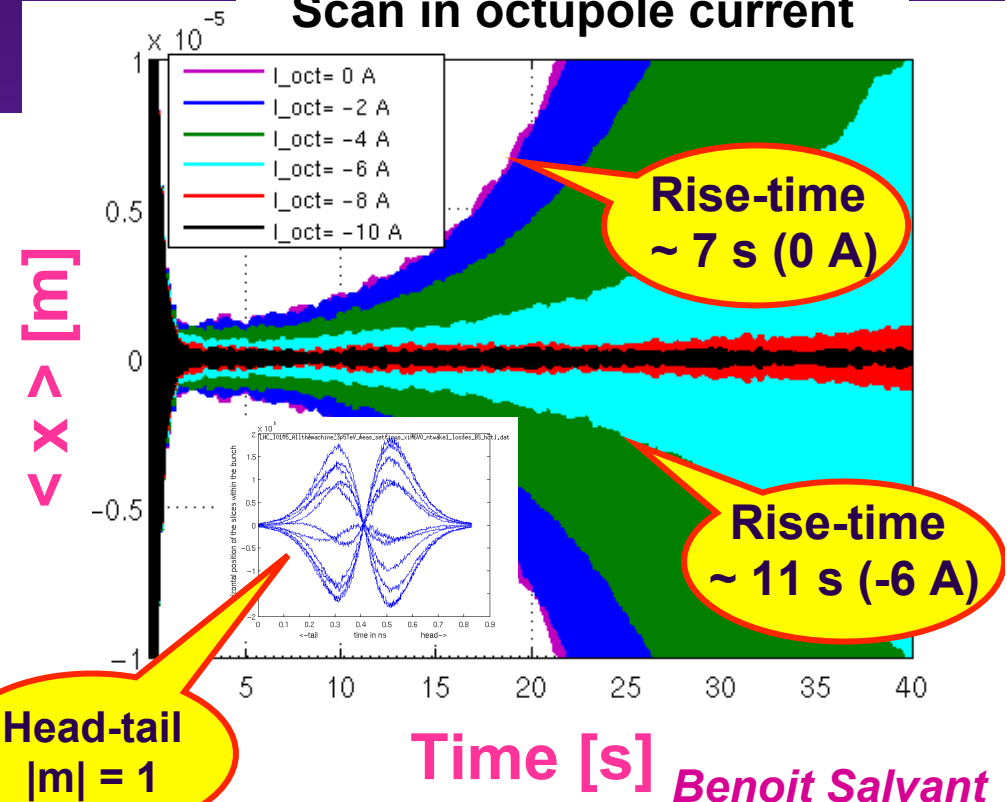

- Rise-time ~ 10 s
- $-20 A < I_{oct}$ for stability $< -10 A$

- Rise-time ~ 10 s
- Stability for $I_{oct} \sim -10 A$

LHC EXPERIENCE DURING RUN 1: INSTABILITIES (6/13)

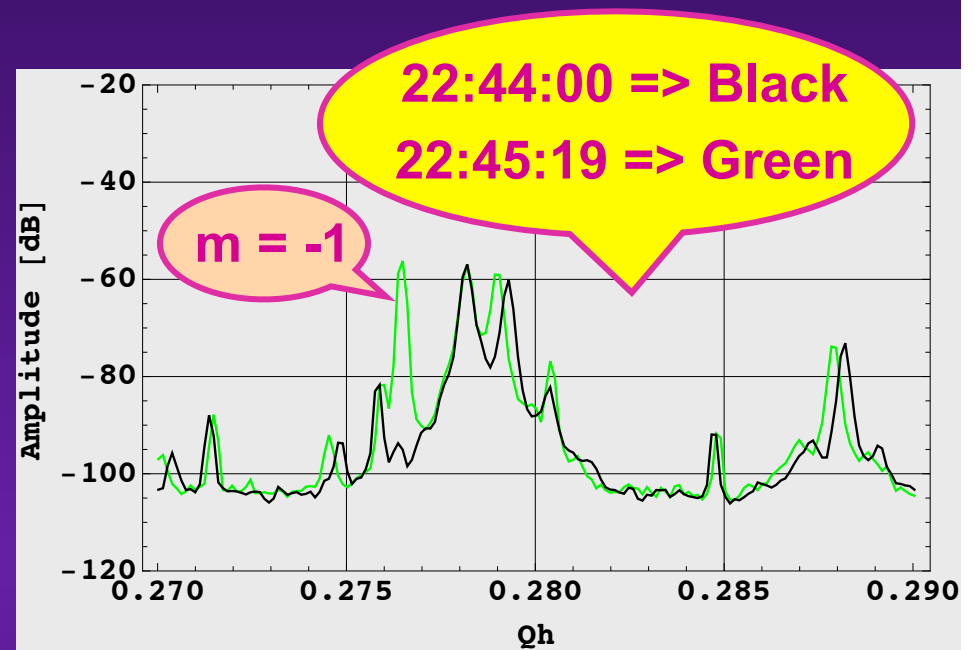
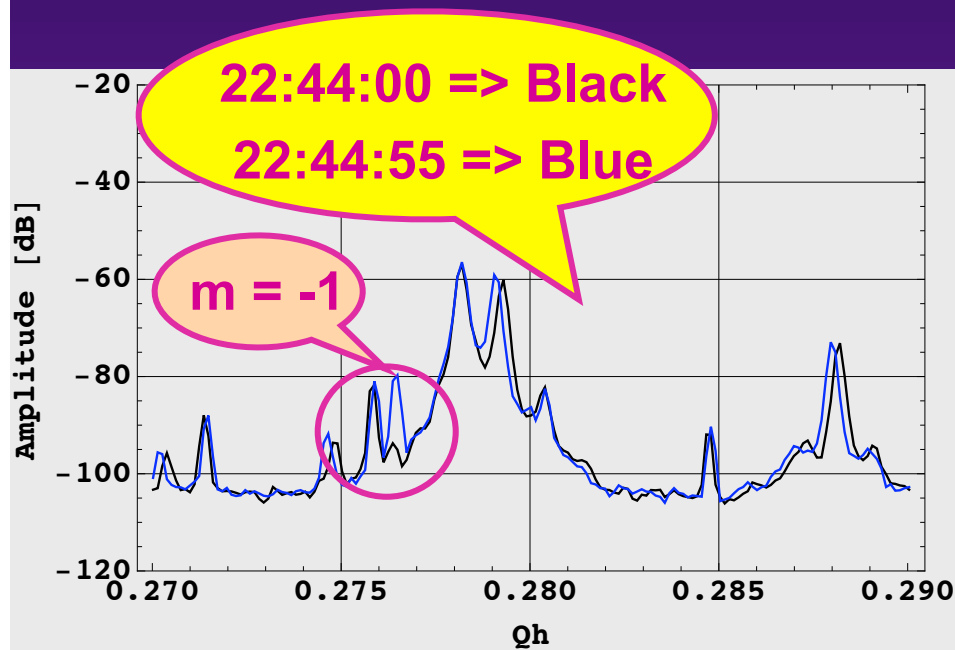

Estimation of the rise-time in frequency domain

~ 24 dB in 24 s => ~ 9 dB in ~ 9 s

=> Instability rise time ~ 9 s (consistent with time domain)

LHC EXPERIENCE DURING RUN 1: INSTABILITIES (7/13)

- ◆ 3) TCBI rise-time studies (for mode 0) with 48 bunches (12 + 36)
 - Good agreement at 450 GeV

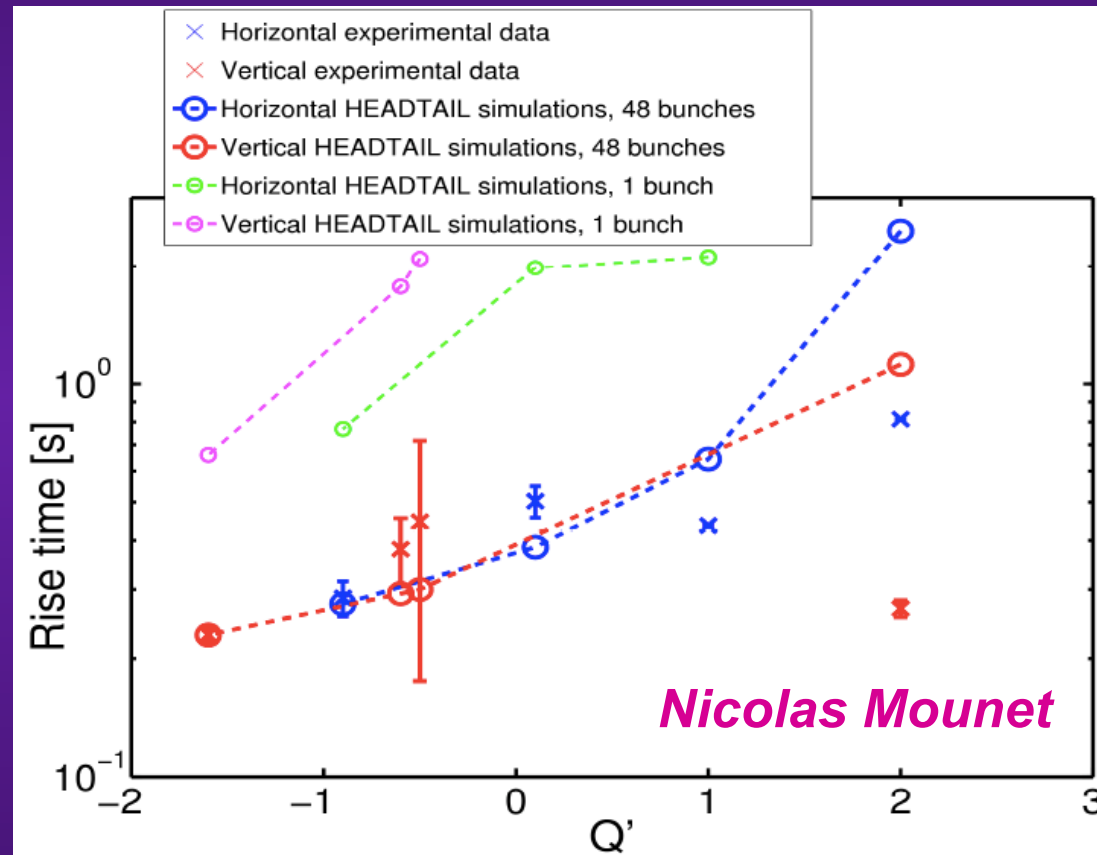

- ~ 2-3 faster rise-times observed at 3.5 TeV (but uncertainty on chromaticities...)

LHC EXPERIENCE DURING RUN 1: INSTABILITIES (8/13)

- Landau octupoles used at 3.5 TeV to stabilize the beam

LOD = - LOF

Landau octupole current [A]	Beam 1	Beam 2
HEADTAIL predictions (Gaussian bunch)	120	100
Measurements	60	70

Nicolas Mounet

- Simulations more critical (but uncertainty on chromaticities, transverse profile - measured by collimation team - different from Gaussian, etc.) => Reasons exist for that and some explanation can be found!

LHC EXPERIENCE DURING RUN 1: INSTABILITIES (9/13)

◆ Transverse coherent tune shifts: simulations vs. measurements

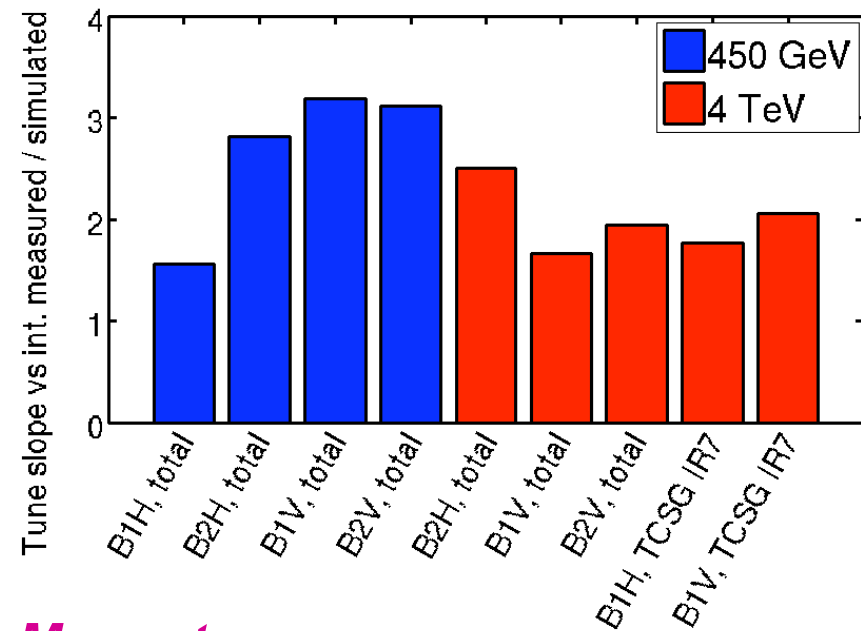
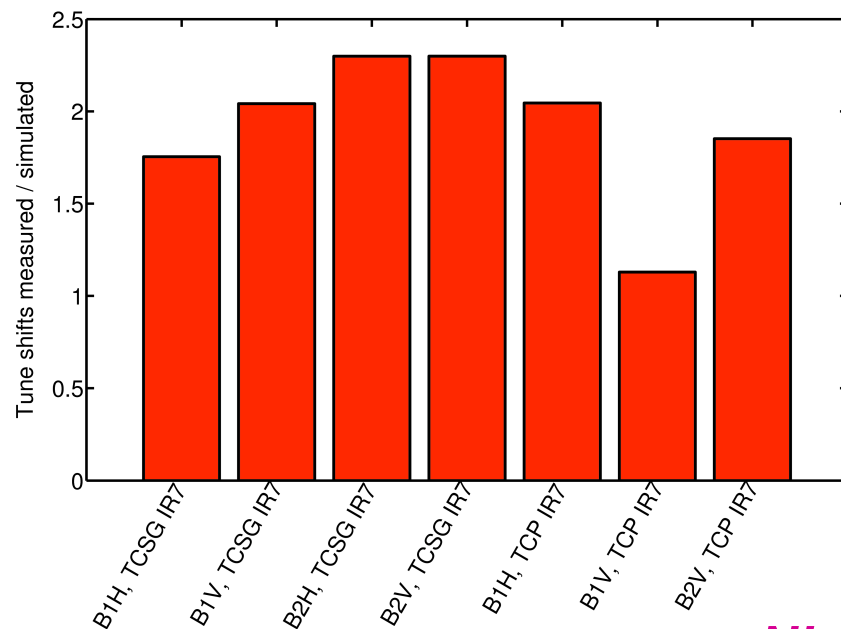

Nicolas Mounet

⇒ Everything was for the best in the best of all possible worlds...

LHC EXPERIENCE DURING RUN 1: INSTABILITIES (10/13)

◆ Everything continued ~ well with nice measurements on impedance, beam-beam and e-cloud

- Impedance *N. Mounet et al.*
 - Always within factor ~ 2-3 (tune shifts, rise-times) and sometimes even better than predicted (instability thresholds)
- Beam-Beam *W. Herr, T. Pieloni et al.*
 - PACMAN effects (loss pattern, orbits) clearly visible and ~ as expected; coherent beam-beam modes as expected
 - BBHO tune spread \gg nominal can be achieved
- E-cloud *G. Rumolo, G. Iadarola et al.*
 - Fast instability damped by large chroma (~ as expected)
 - Nice decreases of SEYs (scrubbing history); nice meas. & sim. of energy loss / bunch (stable phase shift)

LHC EXPERIENCE DURING RUN 1: INSTABILITIES (11/13)

- ◆ 09/06/2011 => Some octupoles added also at injection due to BBQ activity and emittance BU on some batches (LOF = - 6.5 A > fill 1865) => OK afterwards (2011 and 2012) but never optimized
 - Changing the sign of LOF (in 2012, see later) and going from - 6.5 A to + 6.5 A also worked

Hints towards e-cloud

Kevin Li

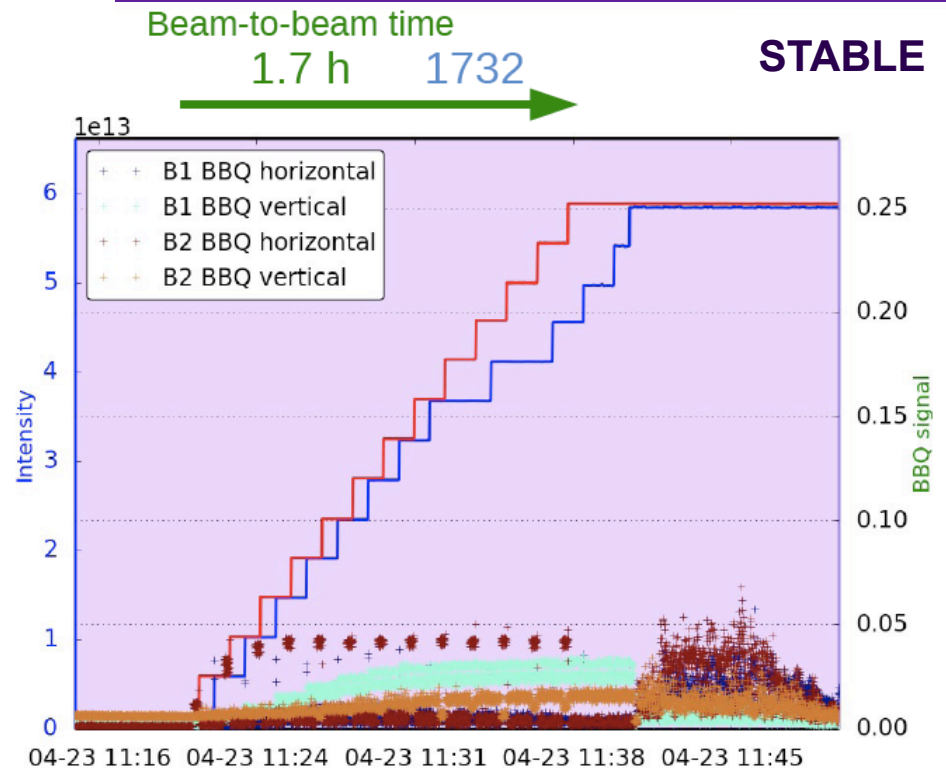
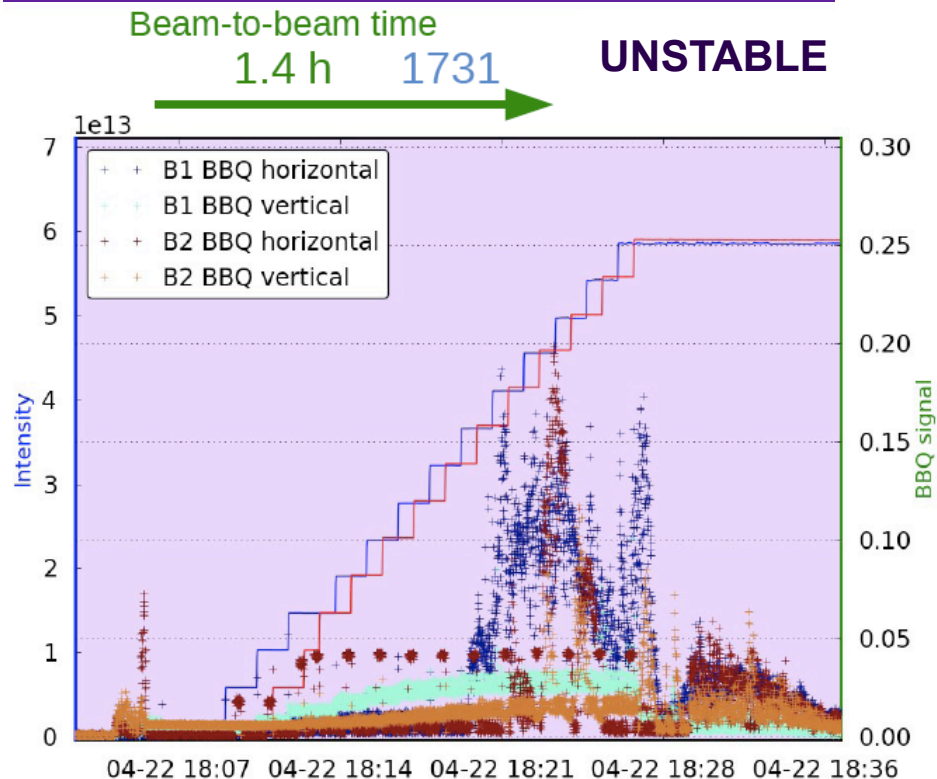

LHC EXPERIENCE DURING RUN 1: INSTABILITIES (12/13)

- ◆ At the end of the 2011 run, a Landau octupoles current of ~ -200 A (~ 600 A is the maximum value) during the betatron squeeze was needed for beam stability, which was much bigger than predicted... assuming known beam parameters such as chromaticities, etc. Why? => Not understood yet...
- ◆ Things started to get even worse during the 2012 run, which was devoted to LHC exploitation but also to explore the LHC performance limits => Busy period for us!
- ◆ Lot of effort devoted to study the interplays between the different mechanisms

A. Burov

- Impedance, octupoles and transverse damper (and BBLR)
- Octupoles and BB

S. Fartoukh

X. Buffat et al.

Led to the change of the sign of the Landau octupoles

LHC EXPERIENCE DURING RUN 1: INSTABILITIES (13/13)

- Impedance and transverse damper
- Impedance and beam-beam (and etc.)
- 3-beam instability with e-cloud
- Effect of octupoles (and sign) on chromaticities
- Effect of BB on chromaticities
- Etc.

N. Mounet

S. White et al.

A. Burov

W. Herr et al.

T. Pieloni et al.

=> A lot of progress made but the EOSI is not understood yet (several studies ongoing: effect of a non perfect transverse damper; holes in the stability diagram; etc.)!

X. Buffat et al.

LHC EXPERIENCE DURING RUN 1: RF HEATING (1/10)

- Observed in several equipment during the 2011-2012 runs when bunch/beam intensity increased and/or bunch length reduced

equipment	Problem	2011	2012	Hopes after LS1	OK for HL-LHC?
VMTSA	Damage	Damage	Should be fine	removed	removed
TDI	Damage	Damage	Damage	Beam screen reinforced, copper coating on the jaw	New design underway
MKI	Delay	Limits operation	Limits operation	Beam screen and tank emissivity upgrade	Current upgrade may not be enough
TCP_B6L7_B1	Few dumps	Limits operation	Limits operation	Cooling system checked	400 W expected for 7 kW cooling
TCTVB	Few dumps	Limits operation	Worry that can limit operation	removed	removed
Beam screen Q6R5	Regulation at the limit	Worry that can limit operation	Should be fine	Upgrade of the valves + TOTEM check	Upgrade should be sufficient
ALFA	Risk of damage	Worry that can limit operation	Limits operation	New design + cooling	No forward physics after LS3?
BSRT	Deformation suspected	Worry that can limit operation	Damage	New design + cooling	New design underway

Temp. estimate:
~ 800-1000 °C

■	Damage
■	Limits operation
■	Worry that can limit operation
■	Should be fine

LHC EXPERIENCE DURING RUN 1: RF HEATING (2/10)

VMTSA = Double-bellow module



TDI = Injection Beam Stopper

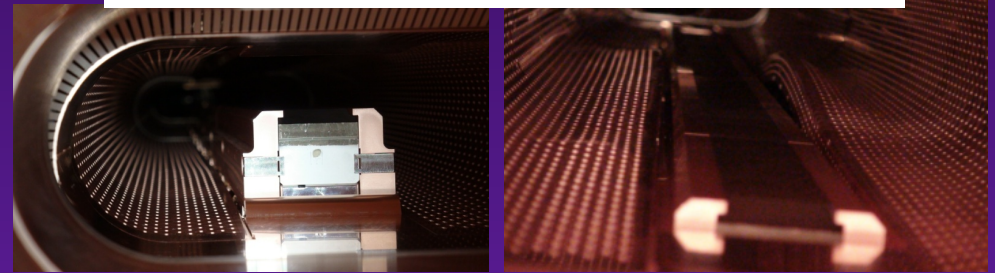

MKI = Injection kickers

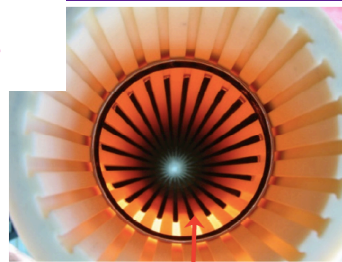
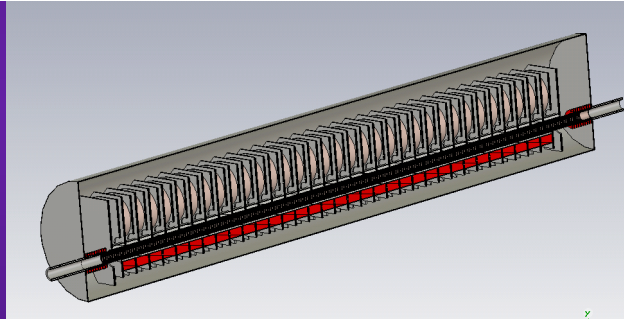

"beam-screen"
of LHC Injection Kicker:
ceramic tube with
conductors in slots

ALFA detector

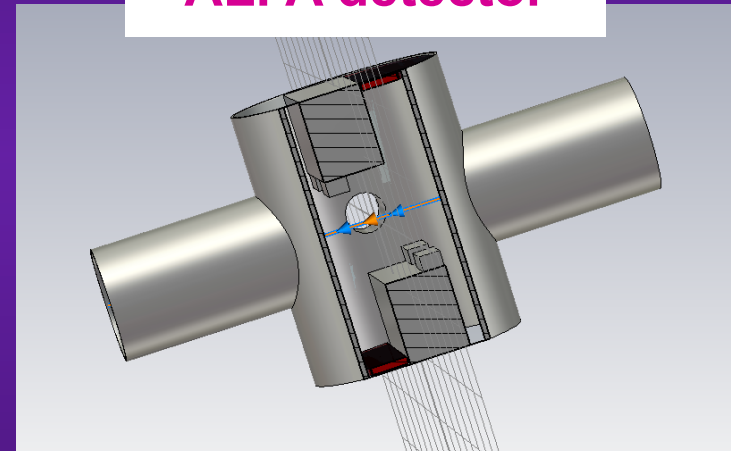

BSRT = Meas. of
transv. emittance

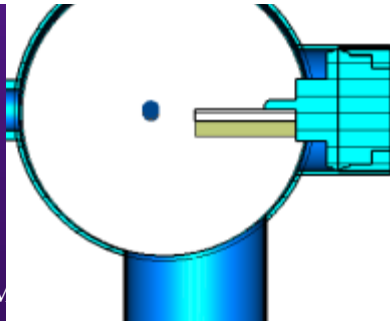

TCP collimator

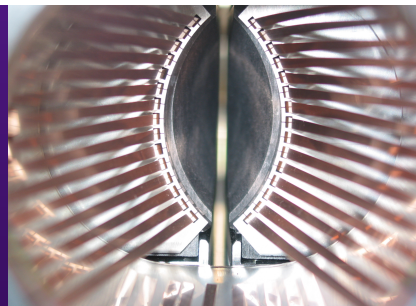

Beam screen



LHC EXPERIENCE DURING RUN 1: RF HEATING (3/10)

- ◆ General formula in the case of M equi-spaced equi-populated bunches (Furman-Lee-Zotter1986)

$$P_{loss} = M I_b^2 Z_{loss}$$

$$Z_{loss} = 2 M \sum_{p=0}^{\infty} \text{Re} [Z_l (p M \omega_0)] \times \text{PowerSpectrum} [p M \omega_0]$$

$$I_b = N_b e f_0$$
$$\omega_0 = 2 \pi f_0$$

- Broad-band impedance (i.e. short-range wake field) => Sum can be replaced by an integral (M in front disappears) => $P_{loss} \propto M$

- Narrow-band impedance (i.e. long-range wake field) => Only 1 term in the sum => $P_{loss} \propto M^2$

LHC EXPERIENCE DURING RUN 1: RF HEATING (4/10)

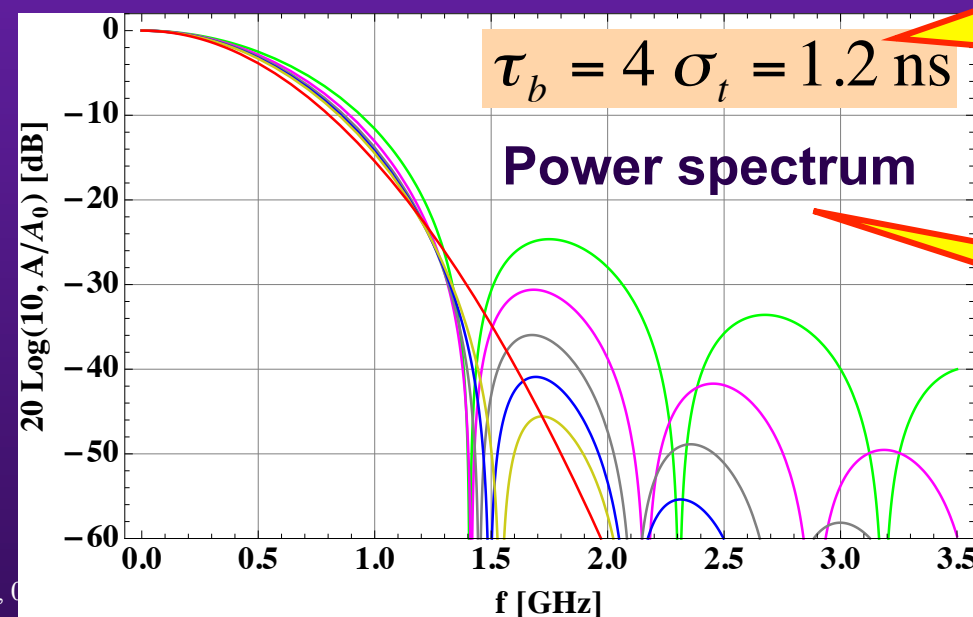
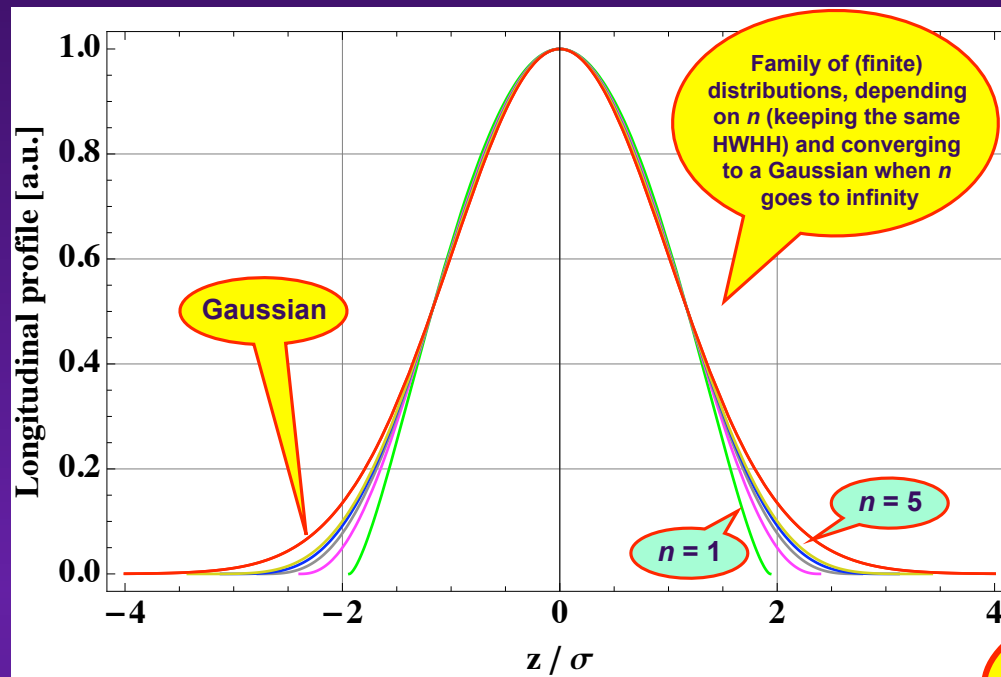

For LHC in 2011
($\Rightarrow 9 \text{ cm rms}$)

Envelopes
shown

LHC EXPERIENCE DURING RUN 1: RF HEATING (5/10)

- ◆ Power loss formula for the case of a (sharp) resonance (i.e. with only 1 line)

=> Valid when

$$Q \gg \frac{f_r}{2 f_b}$$

Bunch frequency

$$P_{loss}^{On-resonance} = 2 R I^2 \times F$$

$$F = 10^{\frac{P_{dB}(f_r)}{10}}$$

Shunt impedance [Ω]

I = Total beam current [in A] =
 $M \times I_b$

$P_{dB}(f_r)$ is the power in dB read from a power spectrum (computed or measured) at the frequency f_r

- In the case of a Gaussian bunch

$$F = e^{-(2\pi f_r \sigma_t)^2}$$

LHC EXPERIENCE DURING RUN 1: RF HEATING (6/10)

- **Huge effect of the bunch length and / or longitudinal profile**
 => Ex. with a 1 A beam and a shunt impedance $R = 5 \text{ k}\Omega$ at 1.4 GHz

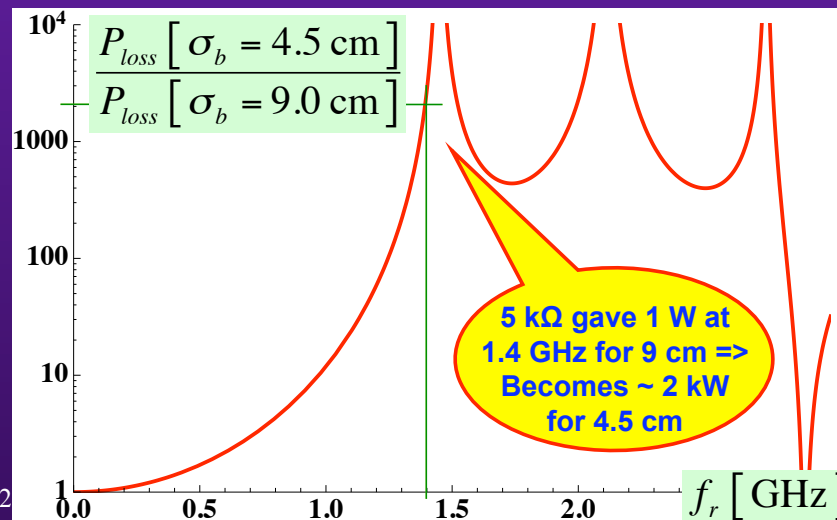
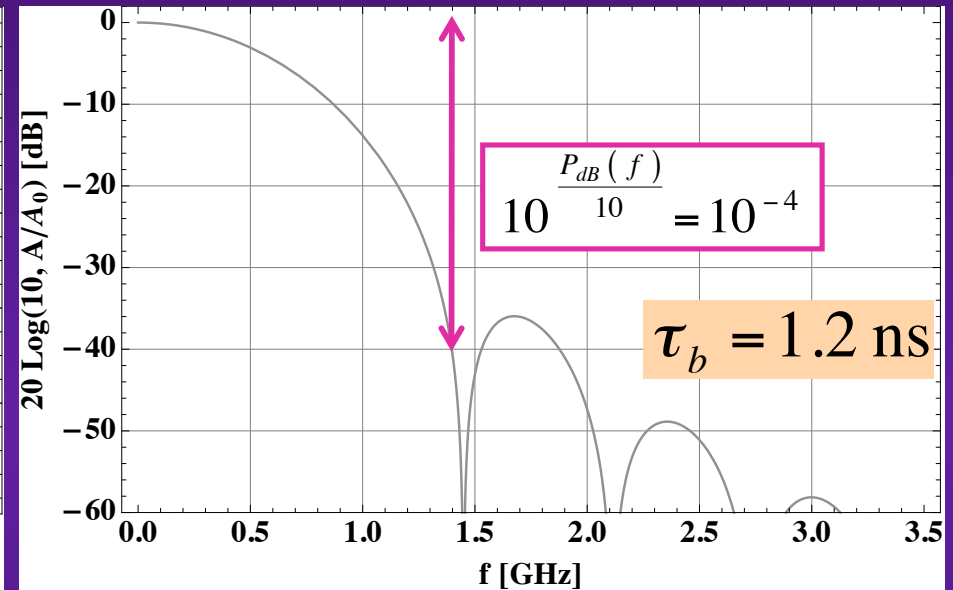
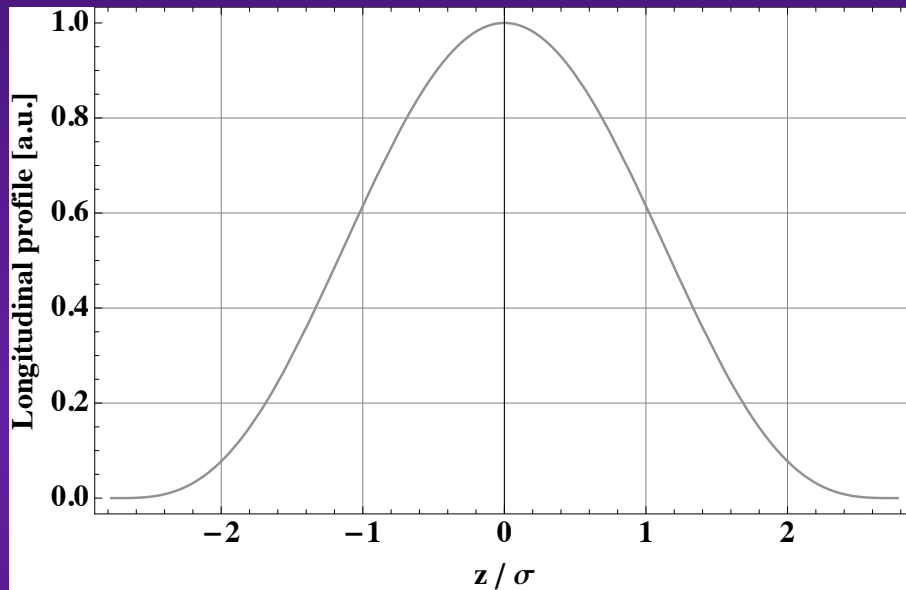

LHC EXPERIENCE DURING RUN 1: RF HEATING (7/10)

- Off-resonance effect

=> Valid when $Q \gg 1$ and $\Delta \ll 1$

$$P_{loss}^{Off-resonance} = P_{loss}^{On-resonance} G$$

$$G = \frac{\Delta^2}{\Delta^2 + \sin^2\left(\frac{\pi f_r}{f_b}\right)}$$

$$\Delta = \frac{\pi f_r}{2 Q f_b}$$

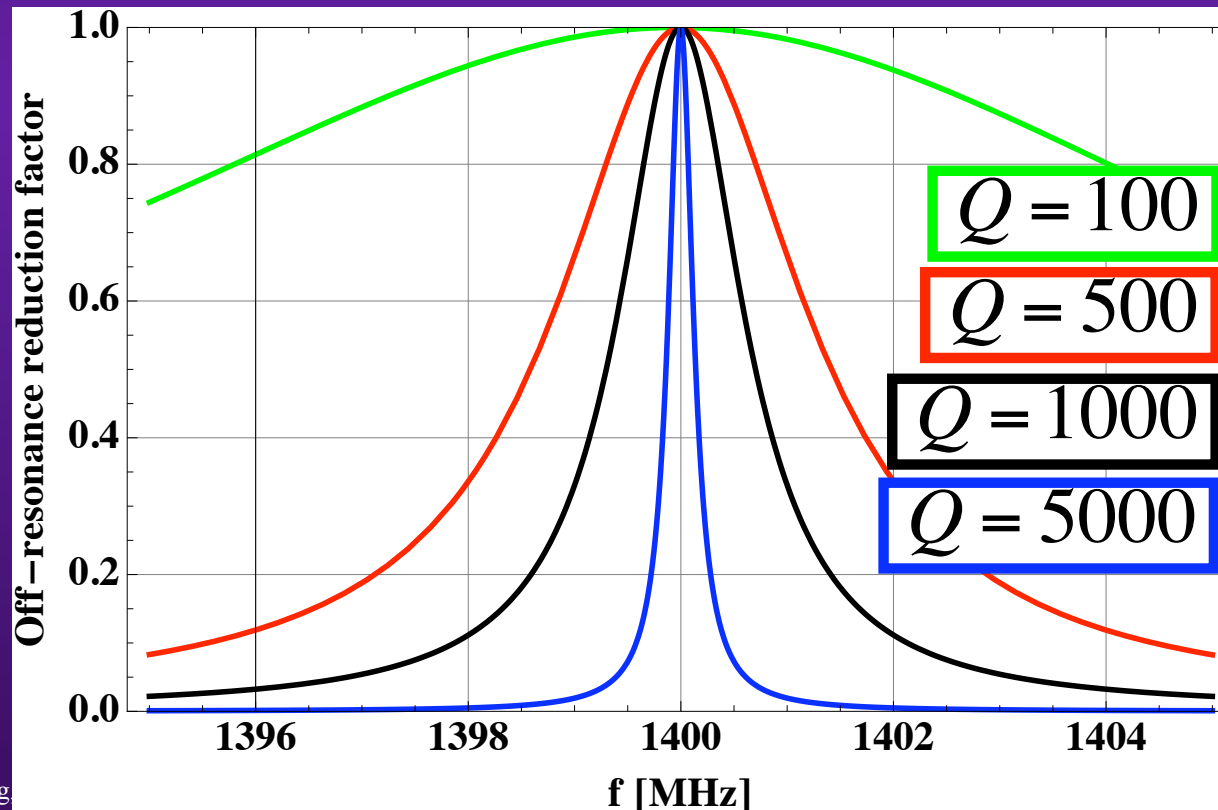

LHC EXPERIENCE DURING RUN 1: RF HEATING (8/10)

- ◆ In the opposite situation of a broad-band impedance, consider for instance the case of the resistive-wall impedance, and, as an example, the particular case of the beam screen (neglecting the holes, whose contribution has been estimated to be small in the past, and the longitudinal weld). Assuming a Gaussian longitudinal profile (other similar distributions would give more or less the same result), the power loss (per unit of length) is given by

$$P_{loss/m}^{G,RW,1layer} = \frac{1}{2\pi R} \Gamma\left(\frac{3}{4}\right) \frac{M}{b} \left(\frac{N_b e}{2\pi}\right)^2 \sqrt{\frac{c \rho Z_0}{2}} \sigma_t^{-3/2} \approx 101 \text{ mW/m}$$

$$\Gamma\left(\frac{3}{4}\right) = 1.23$$

Euler gamma function

$$\begin{aligned} \text{LHC circumference} &= L \\ &= 2\pi R = 26658.883 \text{ m} \end{aligned}$$

$$\begin{aligned} \rho_{Cu}^{20K,7TeV} \\ &= 7.7 \times 10^{-10} \text{ } \Omega\text{m} \end{aligned}$$

$$b = \text{beam screen half height} = 36.8 / 2 = 18.4 \text{ mm}$$

$$M = 2808$$

$$N_b = 1.15 \times 10^{11} \text{ p/b}$$

$$\sigma_t = 0.25 \text{ ns}$$

LHC EXPERIENCE DURING RUN 1: RF HEATING (9/10)

- ◆ **Usual solutions to avoid RF heating => Depending on the situation**
 - Increase the distance between the beam and the equipment
 - Coat with a good conductor (if resistive losses and not geom.)
 - Close large volumes (could lead to resonances at low frequency) and add a smooth transition => Beam screens, RF fingers etc.
 - Put some ferrite with high Curie temperature and good vacuum properties (close to maximum of magnetic field of the mode and not seen directly by the beam) or other damping materials (AlN-SiC Ceralloy 13740Y as in PEP II => S. Novokhatski):
 - Power loss can be significantly decreased
 - The ferrite should absorb the remaining (much smaller) power => Still potential issue of heating due to bad contact / conduction
 - Increase the bunch length (if possible). The longitudinal distribution can also play a very important role for some devices, and it should be kept under tight control

LHC EXPERIENCE DURING RUN 1: RF HEATING (10/10)

- **Improve the subsequent heat transfer:**
 - **Convection: none in vacuum**
 - **Radiation: usually, temperature already quite high for radiation to be efficient. One should therefore try and improve the emissivities of surrounding materials**
 - **Conduction: good contact and thermal conductivity needed**
 - **Active cooling: LHC strategy was to water cool all the near beam equipment**
- **Try and design an All Modes Damper (AMD) if possible, to remove the heat as much as possible to an external load outside vacuum, where it can be more easily cooled away. This can also work together with a damping ferrite**
- **Install temperature monitoring on critical devices to avoid possible damages**

CERN RF FINGERS TASK FORCE IN 2012 (1/9)

- ◆ Why do we need RF fingers (and or ferrite)? => To avoid having too large impedances (longitudinal or transverse) due to (big) changes of geometry for moving equipments, which can lead to
 - Beam-induced RF heating (if real part of longitudinal impedance)
 - Longitudinal or transverse beam instabilities (if real and/or imaginary parts of longitudinal or transverse impedances)

- ◆ Example of RF fingers:
PIMs = Plug-In Modules

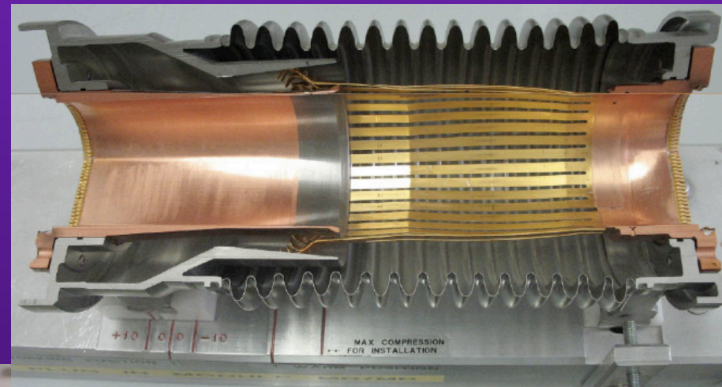

- ◆ Example of ferrite tiles:
Installed in the new VMTSA
in 2012



Initial dimensions
(quickly available!):
~ 12 cm × 3 cm × 1 cm

CERN RF FINGERS TASK FORCE IN 2012 (2/9)

◆ 1) Funnel for the PIMs

- For case of longitudinal movement (only)
- Good for contact / gap
- Possible issue with buckling and aperture restriction

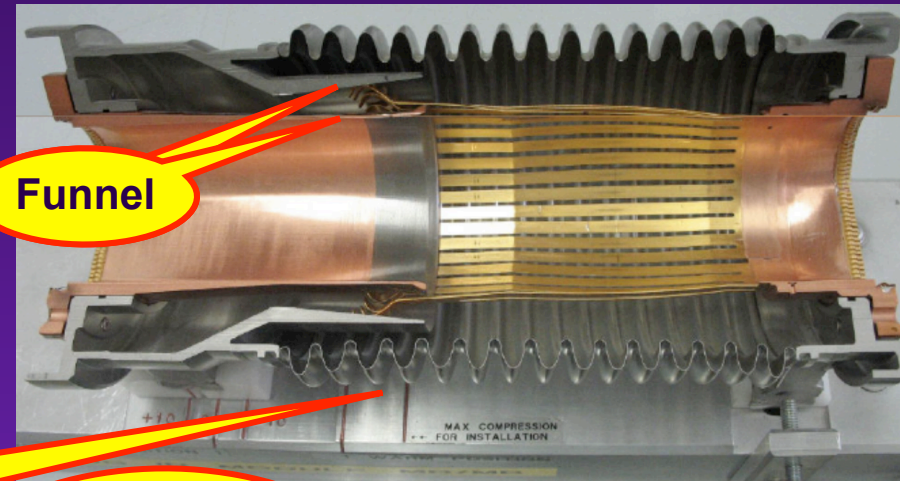

RF contact fingers to shield the distorted geometry of the bellows from the beam

Spring (to be put at the extremity of the RF fingers where there is a groove)

Conforming RF fingers

◆ 2) Spring for the VMTSA

- For case of transversal movement
- Possible issue with contact / gap (due to elliptical shape) => RF heating
- Possible issue with aperture restriction

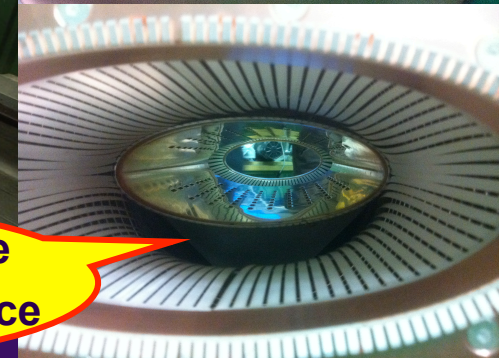
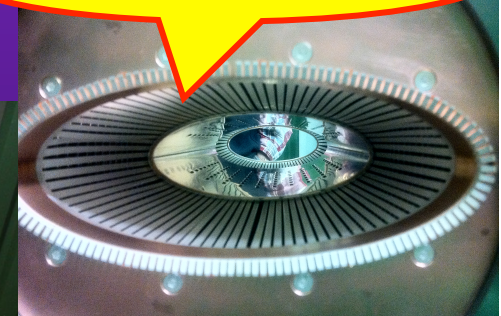

Big gap created in case the spring is NOT in place

CERN RF FINGERS TASK FORCE IN 2012 (3/9)

◆ 3) Fixed extremities for the LHCb VELO (VERtEX LOcator)

- Seems to work very well!
- Well-studied VELO design in terms of impedance effects paid off => No issue observed

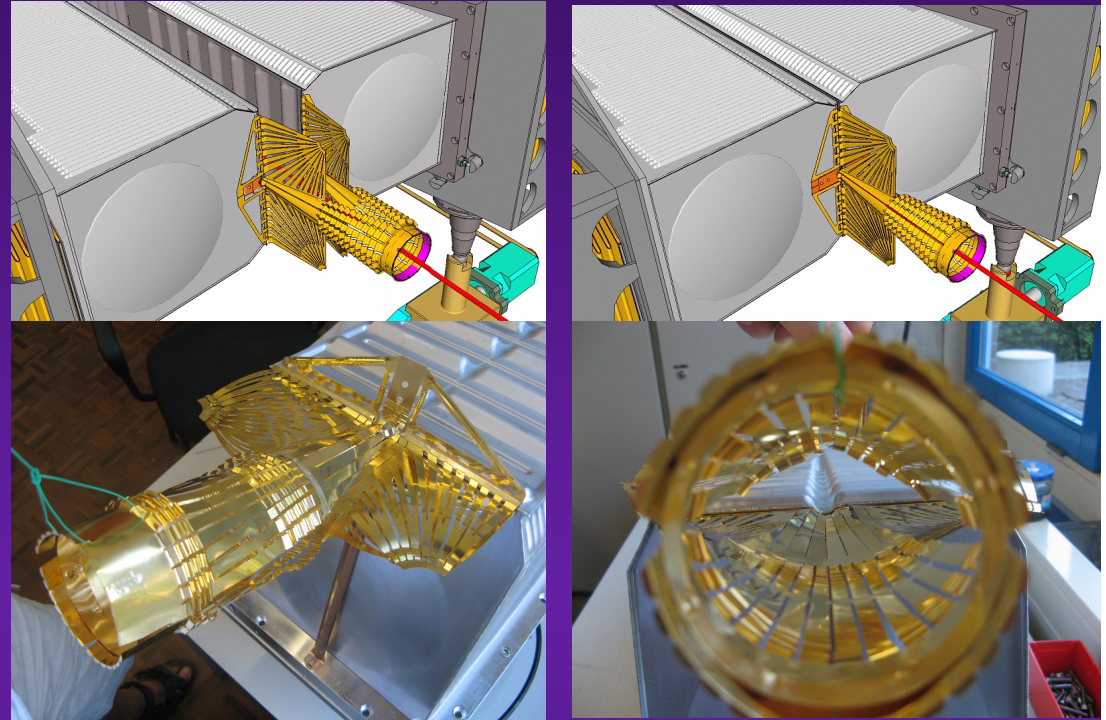

◆ 4) New RF design from TE/VSC

- 1st prototype based on 2 convolutions manufactured in 2012
- Issue: Imaginary part of the longitudinal impedance (if many and if not elongated)



CERN RF FINGERS TASK FORCE IN 2012 (4/9)

◆ 5) Longitudinal sliding contacts for collimators

- Initial proposal for 1st (SPS) prototype (2003)
- Uncoated CuBe fingers sliding on C/C
- Electrical contact resistance $\sim 30 \text{ m}\Omega$ (specification: $1 \text{ m}\Omega$)
=> Redesign necessary

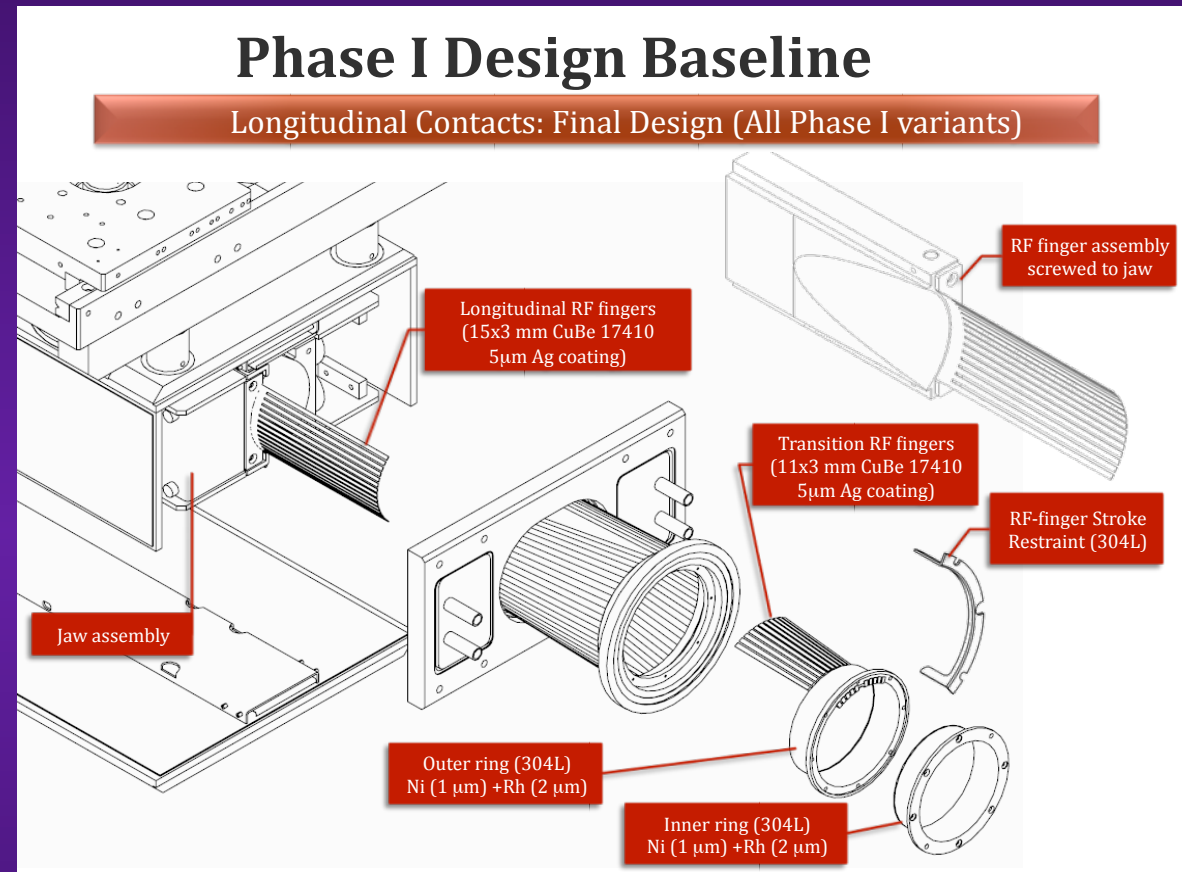

CERN RF FINGERS TASK FORCE IN 2012 (5/9)

◆ RF fingers for PIMs

- Low contact resistance $< 0.1 \text{ m}\Omega$ (i.e. $3 \text{ m}\Omega$ / RF finger as there are 30 RF fingers in //)
- No cold welding
- Low friction
- Good formability properties

◆ RF fingers for collimators

- Same as above with contact resistance $< 1 \text{ m}\Omega$
- Resistance to bake out: $250^\circ\text{C} / 1000 \text{ h}$
- Resistance to heating \Rightarrow Good thermal conductivity
- Wear after many cycles “open-close of the jaws” (1500 cycles \sim 4 years)

◆ Good electric contacts requires

- Low surface roughness
- Soft metals (at least one)
- No oxide layer at the surface

CERN RF FINGERS TASK FORCE IN 2012 (6/9)

- ◆ **1800 X-rays taken in 2012**
- ◆ **92 Nonconformities (~ 5 %) => 2 types of design: circular and elliptical (VMTSA)**

CONFORMITY

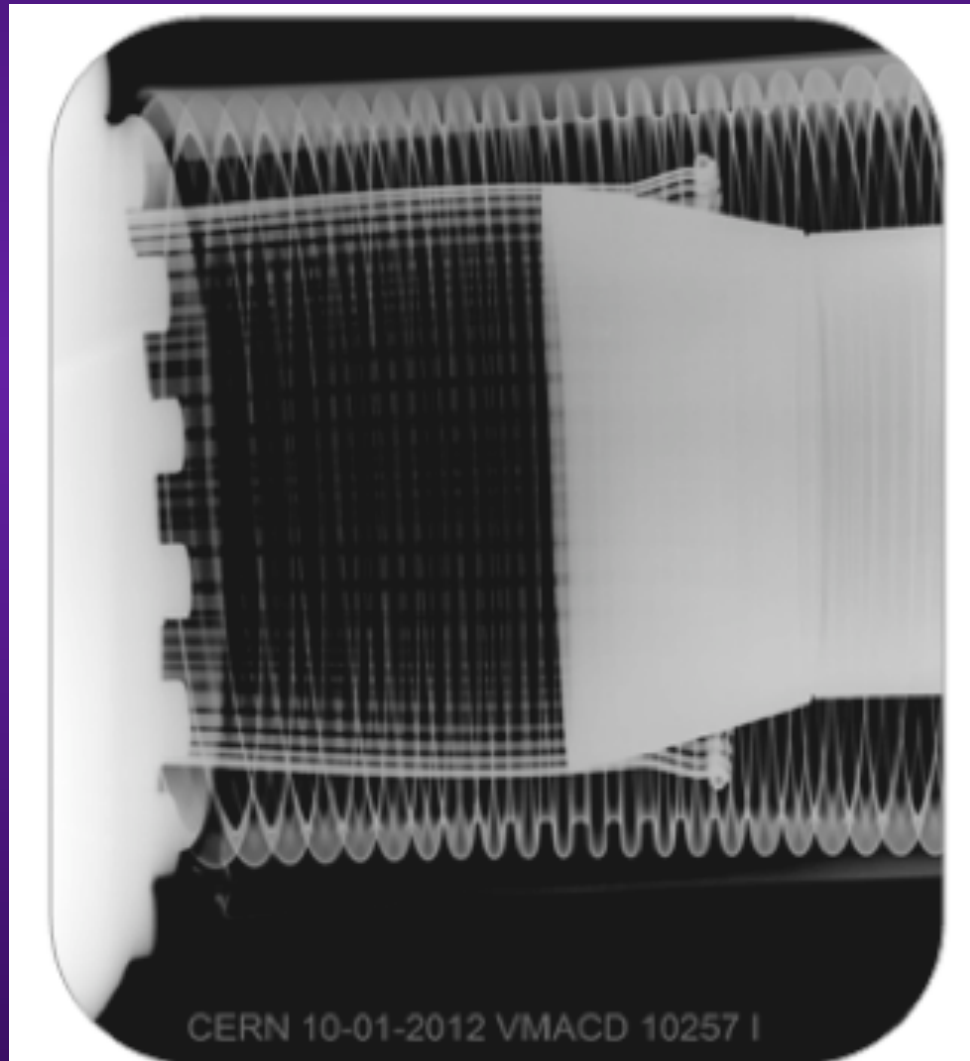

CERN RF FINGERS TASK FORCE IN 2012 (7/9)

NONCONFORMITIES

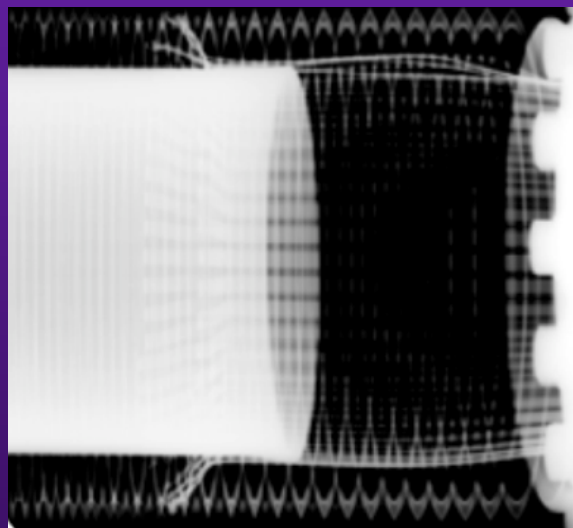
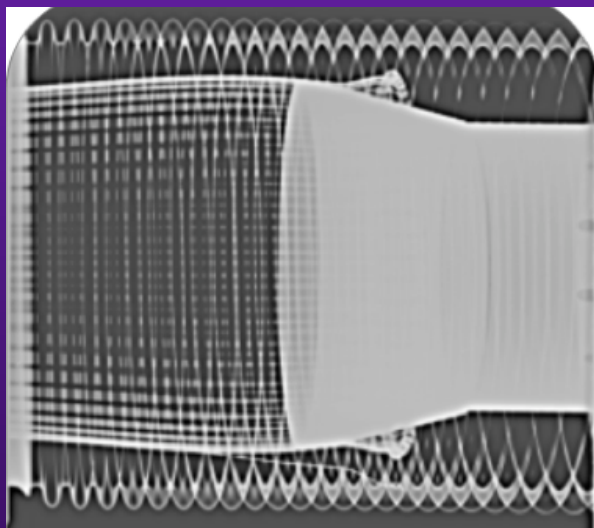
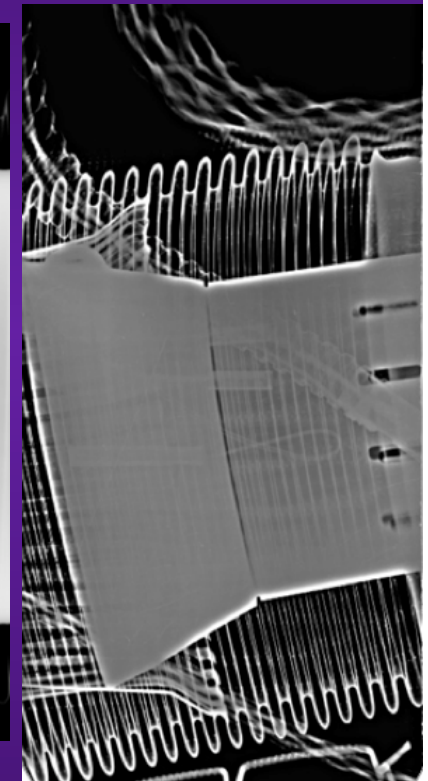
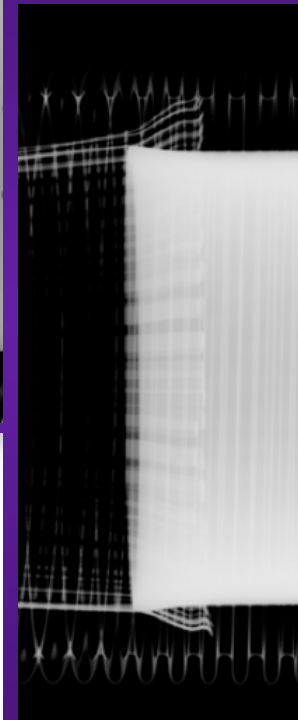
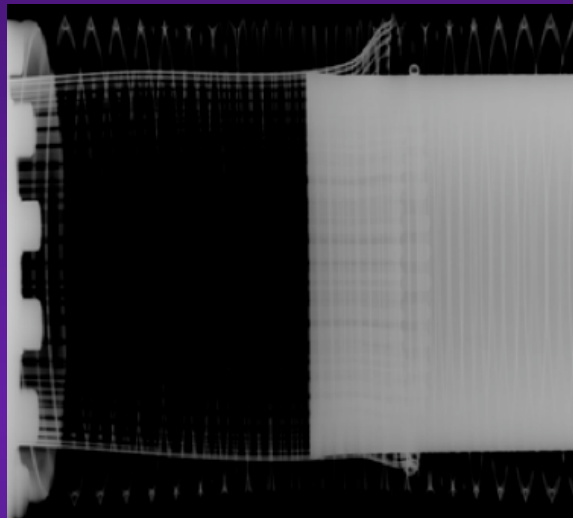
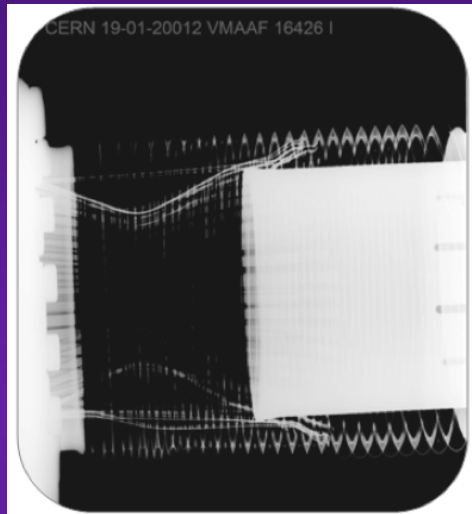

CERN RF FINGERS TASK FORCE IN 2012 (8/9)

◆ Guidelines for RF fingers

- CuBe => Grade important in case of bake-out as for collimators (=> C17410)
- CuBe is a good conductor but still has too an high surface impedance => Coating needed to increase surface conductivity, reduce contact resistance and avoid cold welding => 2 possible solutions to avoid cold welding
 - Putting a diffusion barrier between the 2 metals (i.e. an oxide layer) => Bad for electrical contact
 - Choosing metals with low solubility => Adopted solution: Au-Rh for the PIMs (Ag-Rh is quite similar). The contact surface on the insert should be electro-polished before putting the Rh coating
- Collimators needs a bake-out at 250°C => Au cannot be used at this temperature because of the diffusion of Cu into Au => Ag used
- For the MKI injection kickers, SS (instead of CuBe), but still Au plated, is used for the RF fingers because of the bake-out at ~ 300°C (CuBe would lead to a very small residual elasticity of ~ 20% only)
- Top priority: Try and achieve robust mechanical designs to keep the contacts of all the RF fingers and do a very careful installation

CERN RF FINGERS TASK FORCE IN 2012 (9/9)

◆ Guidelines for ferrite

- If RF fingers cannot be used or in case of nonconformities, some trapped modes might be created and ferrite tiles can be used to damp these modes
- The ferrite should be put at (or close to) the maximum of the magnetic field of the mode to be damped (at the metallic wall), which is deduced after detailed electro-magnetic simulations, assuming known electro-magnetic properties of the ferrite. The ferrite should not be seen directly by the beam (if possible) and depending on the frequency of the mode to be damped, the ferrite type and thickness need to be optimized
- Furthermore, the ferrite should be compatible with UHV (Ultra High Vacuum) and even if the ferrite will considerably reduce the power loss (by lowering the quality factor Q of the resonance, while keeping $R / Q \sim$ constant), the remaining power loss will be absorbed by the ferrite which will heat and might reach its Curie temperature (and therefore lose its damping properties) if the heat transfer is not optimized

CONCLUSION (1/4)

◆ Great success for the LHC performance during Run 1

- ~ 1.6E11 p/b instead of nominal 1.15E11 p/b => + ~ 40%
- ~ 2.2 μm instead of nominal 3.75 μm => - ~ 40%

=> Bunch brightness: $\sim (1.6 / 1.15) \times (3.75 / 2.2) \sim 2.4$ times larger than nominal (at 4 TeV)!

- Both transverse damper and Landau octupoles are needed (during the full cycle) and work well! High chromaticity used at high energy

◆ However,

- The End-Of-The-Squeeze Instability could not be cured (not understood yet!) => Potential worry for future operation at higher energy, higher beam intensity and higher beam brightness

- Many beam-induced RF heating issues

CONCLUSION (2/4)

- ◆ **Lessons learnt for the future projects** => Better impedance model needed and better study of the interplays between the different mechanisms: Impedance, octupoles, transverse feedback, BBLR, BBHO, space charge, e-cloud, etc.
- ◆ **Main (expected) transverse impedance contributors for LHC & HL-LHC**
 - Beam screen at low frequencies (Real part)
 - Collimators at intermediate frequencies => change of material for HL-LHC
 - Broad-band geometric contributions at high frequencies + possible trapped modes at any frequencies => (many) careful simulations needed
- ◆ **What next for LHC (in 2015)** => Remains to be seen what will happen at ~ 7 TeV (instead of 4) and with 25 ns (instead of 50 ns)...
=> e-cloud + 2 times more BBLR...

CONCLUSION (3/4)

- ◆ **Might not have enough transverse Landau damping in the future**
 - More octupoles needed (and $\text{LOF} < 0$ better for 1-beam). ATS optics (from StephaneF) will help
 - Use BBHO tune spread as soon as possible (but we need to reach this point...) => Collide and squeeze
 - Decrease the impedance
 - Recent idea / proposition from Alexej Grudiev to help us having more transverse Landau damping => **RF quadrupole (to provide longitudinal spread of betatron tune)**
 - A ~ 1 m long cryomodule with three 800 MHz SC pillbox cavities in IR4 could provide enough tune spread for Landau damping of a mode with $\Delta Q_{\text{coh}} \sim 2\text{E-}4$ at 7 TeV
 - Under study if this can really help us (beam dynamics)
 - Then, possible design, prototype, etc.

CONCLUSION (4/4)

- ◆ **Lot of work at CERN on impedances over the last few years (theory, simulations through CST in particular => Many benchmarks made, bench measurements and beam-based measurements)**
 - **LHC and HL-LHC**
 - **Impedance and related (transverse) instabilities**
 - **Beam-induced RF heating**
 - **LHC injectors within the LIU (LHC Injectors Upgrade) project**
 - **SPS, PS and PSB => Reliable impedance models under development**
- => CERN impedance working group led by B. Salvant (<https://impedance.web.cern.ch/impedance/>)**



ETTORE MAJORANA FOUNDATION AND CENTRE FOR SCIENTIFIC CULTURE
30.0117 - 2. PARADISE STREET - 91012 ERICE (AG) - ITALY
 AND 30.0117 - 2. PARADISE STREET - 91012 ERICE (AG) - ITALY



ICFA mini-Workshop on "Electromagnetic wake fields and impedances in particle accelerators"

- Chairmen: V. Vaccaro (Naples) and E. Métral
- 52 participants

23-28 April 2014
 Europe/Zurich timezone

<https://indico.cern.ch/event/287930/>



Wednesday 23/04/2014: Arrival

21:00 - 23:00: Get-Together-Party

Thursday 24/04/2014:

- Session 1: Impedance theory and related effects
- Session 2: Impedance numerical simulations
- Session 3: Impedance bench and beam-based measurements

Friday 25/04/2014:

- Session 4: Extensions of the impedance concept
- Session 5: Impedance challenges for new projects
- Session 6: Building the impedance model of a machine
- Banquet in the evening

Saturday 26/04/2014:

- Session 7: Space charge and resistive-wall impedances
- Session 8: Geometrical impedance
- Session 9: Impedance of diagnostics structures
- Poster session at the end of the afternoon

Sunday 27/04/2014: Full-day excursion

Monday 28/04/2014:

- Session 10: Impedance of collimators and kickers
- Session 11: Summaries

Tuesday 29/04/2014: Departure

- Overview
- Motivation
- Scientific programme and timeline
- International Advisory Committee (IAC)
- List of items to be discussed
- Contacts
- List of participants
- Timetable
- Erice - Get there
- Excursions
- Application form
 - Application Form
- Flyer
- Picture of the workshop

ICFA mini-Workshop on "Electromagnetic wake fields and impedances in particle accelerators" to be held in Erice, Sicily, in 2014 from April 24th to April 28th. The Workshop will be hosted by "ETTORE MAJORANA FOUNDATION AND CENTRE FOR SCIENTIFIC CULTURE".



THE ROOTS OF WESTERN CIVILIZATION

The quadrilingual gravestone in Ziza Museum in Palermo, Sicily. The languages are Latin, Greek, Arabic and Hebrew. The dates appearing in the four languages, each computed in its own calendar, correspond to 1148 a.d. .

Support
 ✉ Delphine.rivoiron@cer...
 ☎ 004122 767 25 23



SOME REFERENCES (1/2)

- ◆ **LHC design report:** <http://ab-div.web.cern.ch/ab-div/Publications/LHC-DesignReport.html> and in particular chapter 5 on collective effects
- ◆ **HL-LHC WP2 Task 2.4 (collective effects)**
 - **Web site:** <https://espace.cern.ch/HiLumi/WP2/task4/SitePages/Home.aspx>
 - **Milestone report 1 on “Initial estimate of machine impedance”:** <https://cds.cern.ch/record/1644770/files/CERN-ACC-2014-0005.pdf>
 - **Milestone report 2 on “Initial estimates of intensity limitations”:** <http://cds.cern.ch/record/1712646/files/CERN-ACC-2014-0074.pdf>
 - **Final report to be released in November 2014**
- ◆ **Future HiLumi book and chapter 4 from Stephane Fartoukh and Frank Zimmaermann on “The Accelerator Physics Challenge”**
- ◆ **PHD thesis of Nicolas Mounet on “The LHC transverse coupled-bunch instability”:** http://wiki.epfl.ch/nmounet/documents/phd_thesis_nmounet.pdf
- ◆ **Coming PHD thesis of Xavier Buffat on interplay between beam-beam, octupoles and impedances**

SOME REFERENCES (2/2)

- ◆ **Beam screen issues (with 20 T dipole magnets instead of 8.3 T):**
http://emetral.web.cern.ch/emetral/BeamScreenIssues_HE-LHC10_EM.pdf
- ◆ **Web site of the Task Force on LHC RF fingers:**
<http://emetral.web.cern.ch/emetral/LRFF/LRFF.htm>
- ◆ **Etc.**