



# MC TOOLS FOR THE LHC

**FABIO MALTONI**

CENTRE FOR COSMOLOGY, PARTICLE PHYSICS AND PHENOMENOLOGY (CP3), BELGIUM

LECTURE I

# TEST: HOW MUCH DO I KNOW ABOUT MC'S?

	Statements	TRUE	FALSE	IT DEPENDS	I have no clue
0	MC's are black boxes, I don't need to know the details as long as there are no bugs.				
1	A MC generator produces "unweighted" events, i.e., events distributed as in Nature.				
2	MC's are based on a classical approximation (Markov Chain), QM effects are not included.				
3	The "Sudakov form factor" directly quantifies how likely it is for a parton to undergo branching.				
4	A calculation/code at NLO for a process provides NLO predictions for any IR safe observable.				
5	Tree-level based MC's are less accurate than those at NLO.				

# TEST: HOW MUCH DO I KNOW ABOUT MC'S?

	Statements	TRUE	FALSE	IT DEPENDS	I have no clue
0	MC's are black boxes, I don't need to know the details as long as there are no bugs.		✓		
1	A MC generator produces "unweighted" events, i.e., events distributed as in Nature.	✓			
2	MC's are based on a classical approximation (Markov Chain), QM effects are not included.		✓		
3	The "Sudakov form factor" directly quantifies how likely it is for a parton to undergo branching.		✓		
4	A calculation/code at NLO for a process provides NLO predictions for any IR safe observable.		✓		
5	Tree-level based MC's are less accurate than those at NLO.			✓	

# TEST: HOW MUCH DO I KNOW ABOUT MC'S?

Score	Result	Comment
$\geq 5$	Addict	Always keep in mind that there are also other interesting activities in the field.
4	Excellent	No problem in following these lectures.
3	Fair	Check out carefully the missed topics.
$\leq 2$	Room for improvement	Enroll in a MC crash course at your home institution.
6 x no clue	No clue	



# DISCOVERIES AT HADRON COLLIDERS

# DISCOVERIES AT HADRON COLLIDERS

peak

$$pp \rightarrow H \rightarrow 4l$$

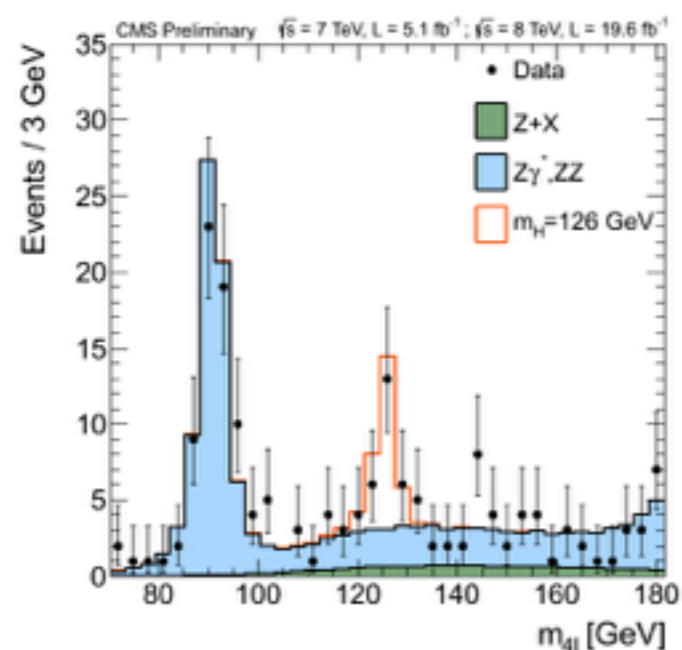

“easy”

Background directly measured from data. TH needed only for parameter extraction (Normalization, acceptance,...)

# DISCOVERIES AT HADRON COLLIDERS

peak

$$pp \rightarrow H \rightarrow 4l$$

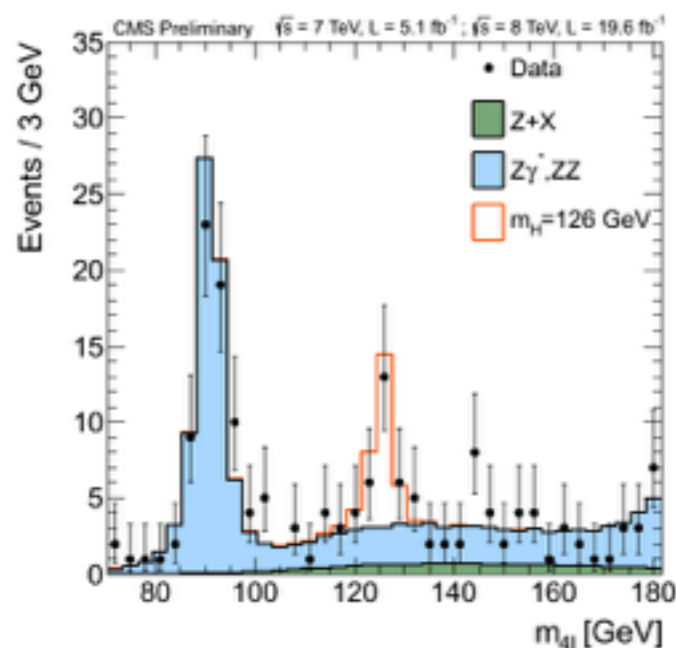

“easy”

Background directly measured from data. TH needed only for parameter extraction (Normalization, acceptance,...)

shape

$$pp \rightarrow \tilde{g}\tilde{g}, \tilde{g}\tilde{q}, \tilde{q}\tilde{q} \rightarrow \text{jets} + \cancel{E}_T$$

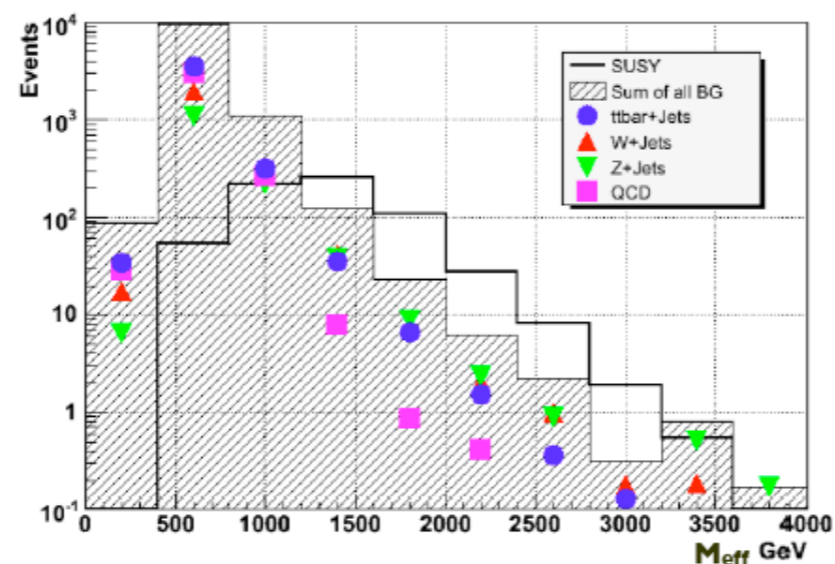

hard

Background shapes needed. Flexible MC for both signal and background tuned and validated with data.

# DISCOVERIES AT HADRON COLLIDERS

peak

$$pp \rightarrow H \rightarrow 4l$$

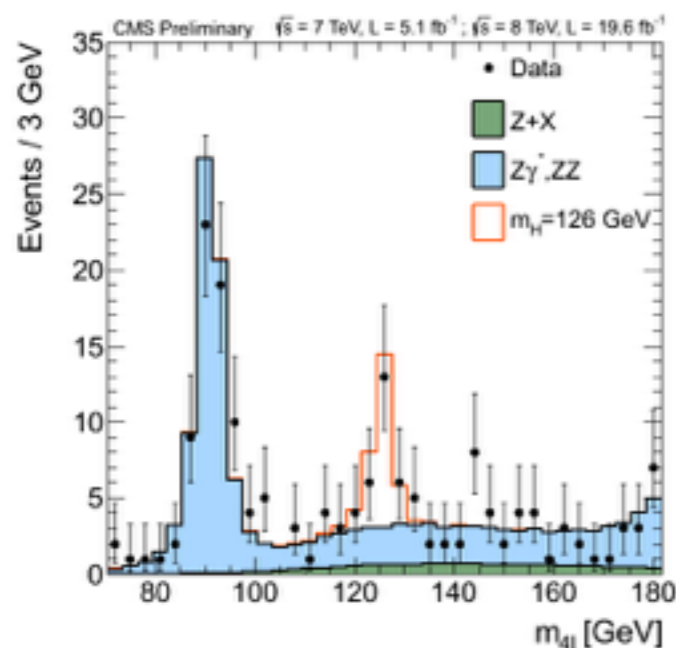

“easy”

Background directly measured from data. TH needed only for parameter extraction (Normalization, acceptance,...)

shape

$$pp \rightarrow \tilde{g}\tilde{g}, \tilde{g}\tilde{q}, \tilde{q}\tilde{q} \rightarrow \text{jets} + \cancel{E}_T$$

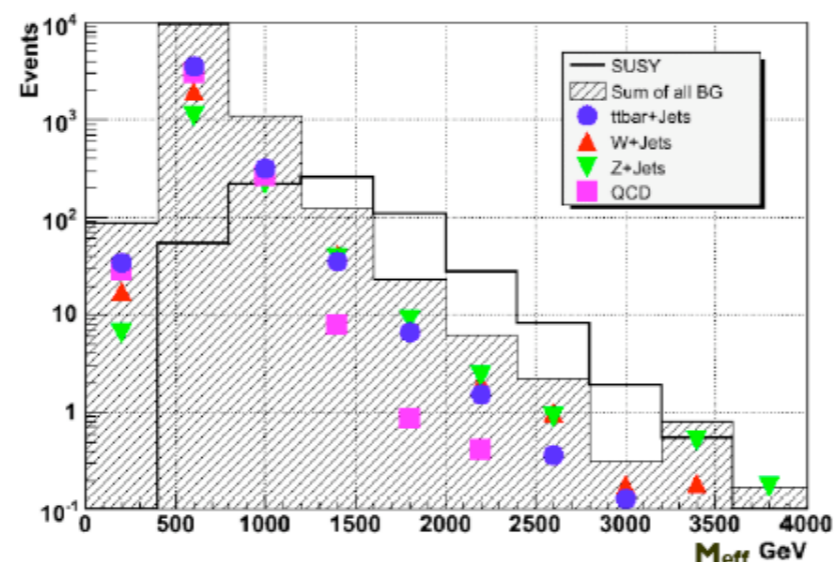

hard

Background shapes needed. Flexible MC for both signal and background tuned and validated with data.

discriminant

$$pp \rightarrow H \rightarrow W^+W^-$$

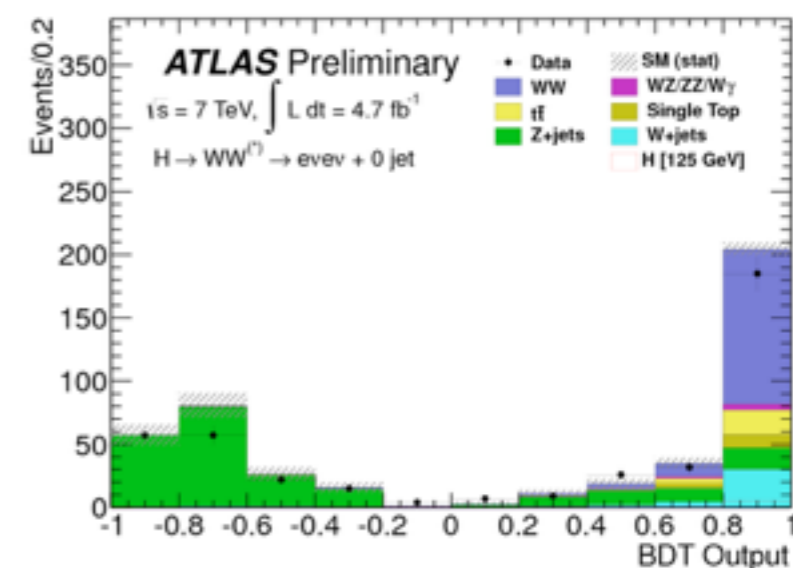

very hard

Background normalization and shapes known very well. Interplay with the best theoretical predictions (via MC) and data.

NO SIGN OF NEW PHYSICS (SO FAR)!







PhD student

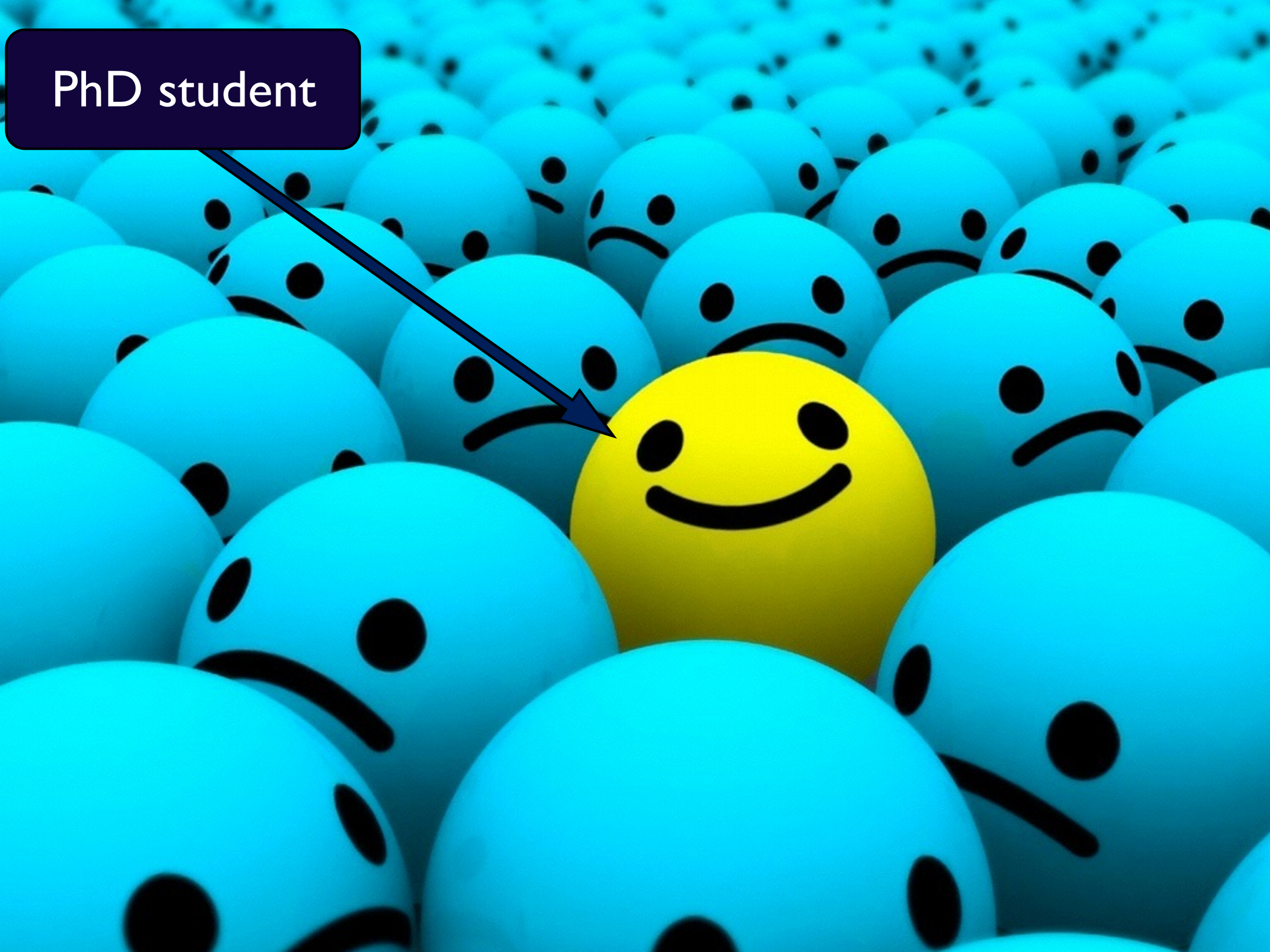

# WHY HAPPY?



## WHY HAPPY?

- Optimism: New Physics could be hiding there already, just need to dig it out.

## WHY HAPPY?

- Optimism: New Physics could be hiding there already, just need to dig it out.
- Democratization: No evidence of most beaten BSM proposals, means more and more room for diversification. Possibility for small teams to make a big discovery.

## WHY HAPPY?

- Optimism: New Physics could be hiding there already, just need to dig it out.
- Democratization: No evidence of most beaten BSM proposals, means more and more room for diversification. Possibility for small teams to make a big discovery.
- Ingenuity/Creativity: From new signatures to smart and new analysis techniques (MVA), and combination with non-collider searches (DM, Flavor...).

## WHY HAPPY?

- Optimism: New Physics could be hiding there already, just need to dig it out.
- Democratization: No evidence of most beaten BSM proposals, means more and more room for diversification. Possibility for small teams to make a big discovery.
- Ingenuity/Creativity: From new signatures to smart and new analysis techniques (MVA), and combination with non-collider searches (DM, Flavor...).
- Massification (the practice of making luxury products available to the mass market) : MC's in the hands of every th/exp might turn out to be the best overall strategy for discovering the Unexpected.

## WHY HAPPY?

- Optimism: New Physics could be hiding there already, just need to dig it out.
- Democratization: No evidence of most beaten BSM proposals, means more and more room for diversification. Possibility for small teams to make a big discovery.
- Ingenuity/Creativity: From new signatures to smart and new analysis techniques (MVA), and combination with non-collider searches (DM, Flavor...).
- Massification (the practice of making luxury products available to the mass market) : MC's in the hands of every th/exp might turn out to be the best overall strategy for discovering the Unexpected.
- Flexibility: We need MC that are able to predict the pheno of the Unexpected.

## WHY HAPPY?

- Optimism: New Physics could be hiding there already, just need to dig it out.
- Democratization: No evidence of most beaten BSM proposals, means more and more room for diversification. Possibility for small teams to make a big discovery.
- Ingenuity/Creativity: From new signatures to smart and new analysis techniques (MVA), and combination with non-collider searches (DM, Flavor...).
- Massification (the practice of making luxury products available to the mass market) : MC's in the hands of every th/exp might turn out to be the best overall strategy for discovering the Unexpected.
- Flexibility: We need MC that are able to predict the pheno of the Unexpected.
- Accuracy: accurate simulations for both SM and BSM are a must.

# CHALLENGES FOR LHC PHYSICISTS

# CHALLENGES FOR LHC PHYSICISTS

- Accurate and experimental friendly predictions for collider physics range from being *very useful* to *strictly necessary*.



# CHALLENGES FOR LHC PHYSICISTS

- Accurate and experimental friendly predictions for collider physics range from being *very useful* to *strictly necessary*.
- *Confidence* on possible excesses, evidences and eventually discoveries builds upon an intense (and often non-linear) process of description/prediction of data via MC's.

# CHALLENGES FOR LHC PHYSICISTS

- Accurate and experimental friendly predictions for collider physics range from being *very useful* to *strictly necessary*.
- *Confidence* on possible excesses, evidences and eventually discoveries builds upon an intense (and often non-linear) process of description/prediction of data via MC's.
- Both **measurements** and **exclusions** *rely* on accurate predictions.

# CHALLENGES FOR LHC PHYSICISTS

Even this plot actually needs theory input (and the total quoted uncertainty in the measurements does have a contribution from theory)!!!

# CHALLENGES FOR LHC PHYSICISTS

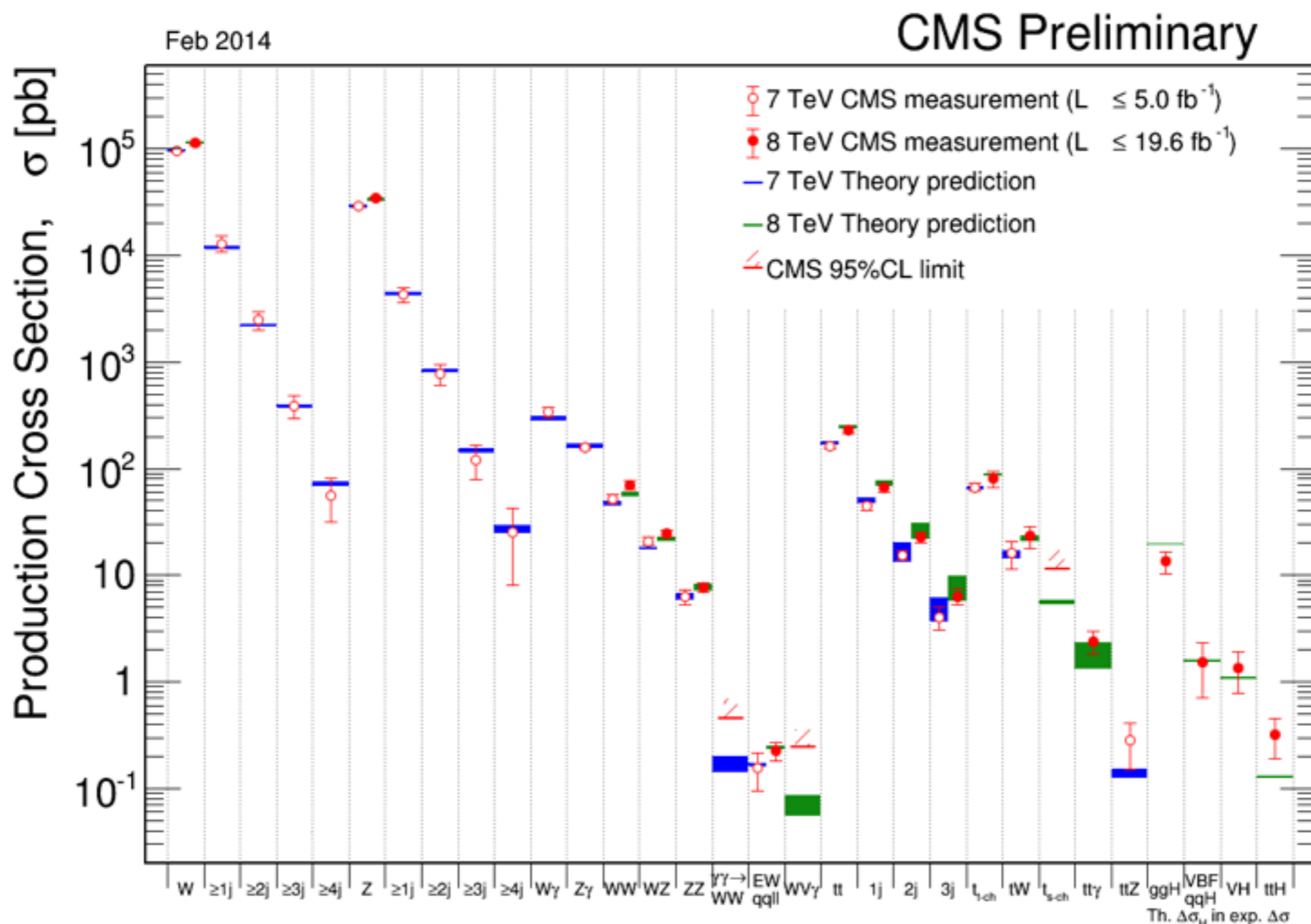

Even this plot actually needs theory input (and the total quoted uncertainty in the measurements does have a contribution from theory)!!!

# NEW GENERATION (LHC) OF MC TOOLS

## Theory

Lagrangian  
Gauge invariance  
QCD  
Partons  
NLO  
Resummation  
...

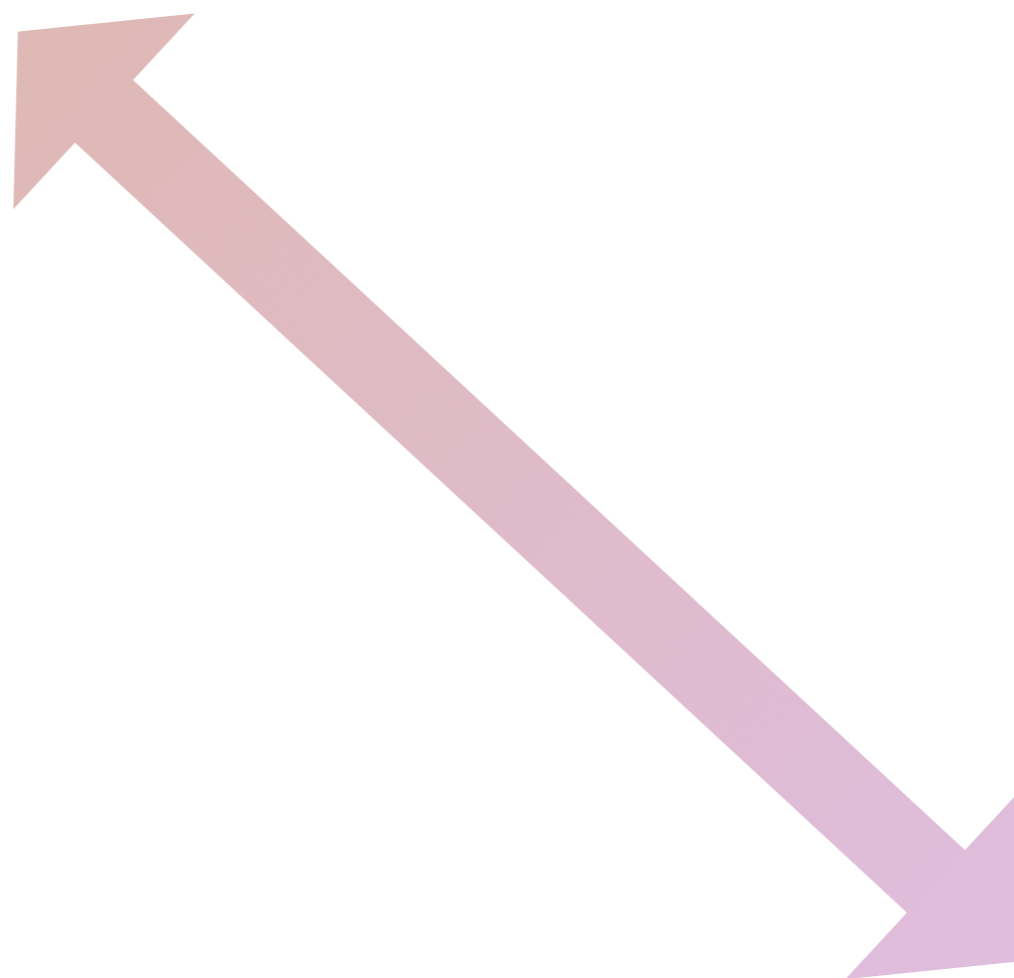

Detector simulation  
Pions, Kaons, ...  
Reconstruction  
B-tagging efficiency  
Boosted decision tree  
Neural network  
...

## Experiment

# NEW GENERATION (LHC) OF MC TOOLS

## Theory

- Lagrangian
- Gauge invariance
- QCD
- Partons
- NLO
- Resummation

...

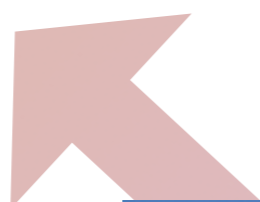

- Detector simulation
- Pions, Kaons, ...
- Reconstruction
- B-tagging efficiency
- Boosted decision tree
- Neural network

...

## Experiment

# AIMS FOR THESE LECTURES

- Recall the basics of the necessary QCD concepts to understand what is going on in a pp event at the TeV scale.
- Critically revisit the “old” ways of making predictions for hadron colliders: either via fixed-order predictions or parton showers.
- Present the new *predictive* techniques which allow to:
  - Merge tree-level calculations with parton showers (CKKW/MLM).
  - Match NLO calculations with parton showers (MC@NLO and POWHEG) automatically.

# PLAN

- Basics : LO predictions and event generation
- Fixed-order calculations : from NLO to NNLO
- Exclusive predictions : Parton Shower
- Merging ME+PS
- Matching NLO with PS



# MASTER FORMULA FOR THE LHC

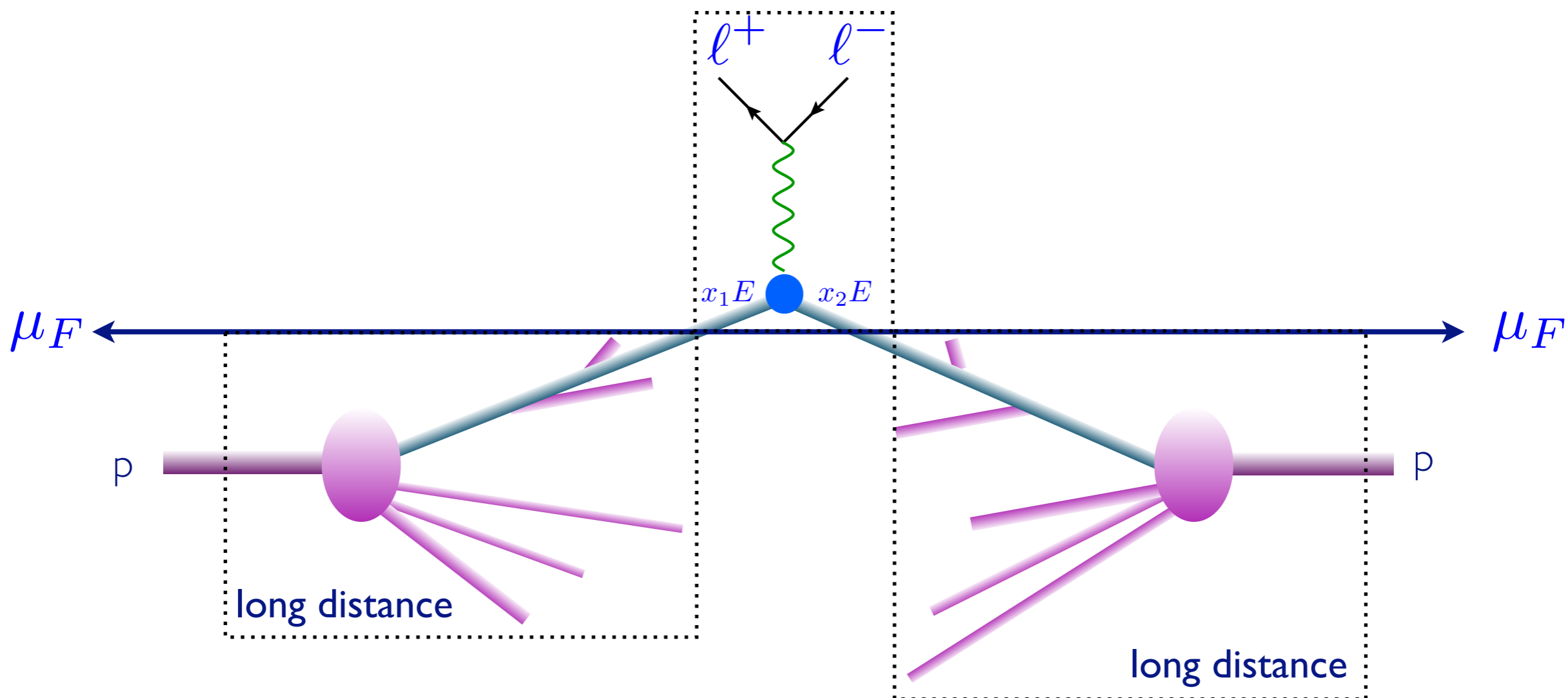

$$\sum_{a,b} \int dx_1 dx_2 d\Phi_{\text{FS}} f_a(x_1, \mu_F) f_b(x_2, \mu_F) \hat{\sigma}_{ab \rightarrow X}(\hat{S}, \mu_F, \mu_R)$$

Phase-space integral
Parton density functions
Parton-level cross section

# MASTER FORMULA FOR THE LHC

$$\sum_{a,b} \int dx_1 dx_2 d\Phi_{\text{FS}} f_a(x_1, \mu_F) f_b(x_2, \mu_F) \hat{\sigma}_{ab \rightarrow X}(\hat{S}, \mu_F, \mu_R)$$

Phase-space integral
Parton density functions
Parton-level cross section

Two ingredients necessary:

1. Parton distribution functions : non perturbative  
(fit from experiments, but evolution from theory)

2. Parton-level cross section: short distance coefficients as  
an expansion in  $\alpha_s$  (from theory)

# PERTURBATIVE EXPANSION

$\hat{\sigma}_{ab \rightarrow X}(\hat{S}, \mu_F, \mu_R)$  Parton-level cross section

# PERTURBATIVE EXPANSION

$\hat{\sigma}_{ab \rightarrow X}(\hat{S}, \mu_F, \mu_R)$  Parton-level cross section

- The parton-level cross section can be computed as a series in perturbation theory, using the coupling constant as an expansion parameter

# PERTURBATIVE EXPANSION

$\hat{\sigma}_{ab \rightarrow X}(\hat{S}, \mu_F, \mu_R)$  Parton-level cross section

- The parton-level cross section can be computed as a series in perturbation theory, using the coupling constant as an expansion parameter

$$\hat{\sigma} = \sigma^{\text{Born}} \left( 1 + \frac{\alpha_s}{2\pi} \sigma^{(1)} + \left( \frac{\alpha_s}{2\pi} \right)^2 \sigma^{(2)} + \left( \frac{\alpha_s}{2\pi} \right)^3 \sigma^{(3)} + \dots \right)$$

# PERTURBATIVE EXPANSION

$\hat{\sigma}_{ab \rightarrow X}(\hat{S}, \mu_F, \mu_R)$  Parton-level cross section

- The parton-level cross section can be computed as a series in perturbation theory, using the coupling constant as an expansion parameter

$$\hat{\sigma} = \sigma^{\text{Born}} \left( 1 + \frac{\alpha_s}{2\pi} \sigma^{(1)} + \left( \frac{\alpha_s}{2\pi} \right)^2 \sigma^{(2)} + \left( \frac{\alpha_s}{2\pi} \right)^3 \sigma^{(3)} + \dots \right)$$

LO  
predictions

# PERTURBATIVE EXPANSION

$\hat{\sigma}_{ab \rightarrow X}(\hat{S}, \mu_F, \mu_R)$  Parton-level cross section

- The parton-level cross section can be computed as a series in perturbation theory, using the coupling constant as an expansion parameter

$$\hat{\sigma} = \sigma^{\text{Born}} \left( 1 + \frac{\alpha_s}{2\pi} \sigma^{(1)} + \left( \frac{\alpha_s}{2\pi} \right)^2 \sigma^{(2)} + \left( \frac{\alpha_s}{2\pi} \right)^3 \sigma^{(3)} + \dots \right)$$

LO  
predictions

NLO  
corrections

# PERTURBATIVE EXPANSION

$\hat{\sigma}_{ab \rightarrow X}(\hat{S}, \mu_F, \mu_R)$  Parton-level cross section

- The parton-level cross section can be computed as a series in perturbation theory, using the coupling constant as an expansion parameter

$$\hat{\sigma} = \sigma^{\text{Born}} \left( 1 + \frac{\alpha_s}{2\pi} \sigma^{(1)} + \left( \frac{\alpha_s}{2\pi} \right)^2 \sigma^{(2)} + \left( \frac{\alpha_s}{2\pi} \right)^3 \sigma^{(3)} + \dots \right)$$

**LO**  
predictions

**NLO**  
corrections

**NNLO**  
corrections



# PERTURBATIVE EXPANSION

$\hat{\sigma}_{ab \rightarrow X}(\hat{S}, \mu_F, \mu_R)$  Parton-level cross section

- The parton-level cross section can be computed as a series in perturbation theory, using the coupling constant as an expansion parameter

$$\hat{\sigma} = \sigma^{\text{Born}} \left( 1 + \frac{\alpha_s}{2\pi} \sigma^{(1)} + \left( \frac{\alpha_s}{2\pi} \right)^2 \sigma^{(2)} + \left( \frac{\alpha_s}{2\pi} \right)^3 \sigma^{(3)} + \dots \right)$$

**LO**  
predictions

**NLO**  
corrections

**NNLO**  
corrections

**NNNLO**  
corrections

# PERTURBATIVE EXPANSION

$\hat{\sigma}_{ab \rightarrow X}(\hat{S}, \mu_F, \mu_R)$  Parton-level cross section

- The parton-level cross section can be computed as a series in perturbation theory, using the coupling constant as an expansion parameter

$$\hat{\sigma} = \sigma^{\text{Born}} \left( 1 + \frac{\alpha_s}{2\pi} \sigma^{(1)} + \left( \frac{\alpha_s}{2\pi} \right)^2 \sigma^{(2)} + \left( \frac{\alpha_s}{2\pi} \right)^3 \sigma^{(3)} + \dots \right)$$

**LO**  
predictions

**NLO**  
corrections

**NNLO**  
corrections

**NNNLO**  
corrections

- Including higher corrections improves predictions and reduces theoretical uncertainties

# PREDICTIONS AT LO

How do we calculate a LO cross section for 3 jets at the LHC?

# PREDICTIONS AT LO

How do we calculate a LO cross section for 3 jets at the LHC?

I. Identify all subprocesses ( $gg \rightarrow ggg$ ,  $qg \rightarrow qgg$ ....) in:

$$\sigma(pp \rightarrow 3j) = \sum_{ijk} \int f_i(x_1) f_j(x_2) \hat{\sigma}(ij \rightarrow k_1 k_2 k_3)$$

# PREDICTIONS AT LO

How do we calculate a LO cross section for 3 jets at the LHC?

I. Identify all subprocesses ( $gg \rightarrow ggg$ ,  $qg \rightarrow qgg$ ....) in:

$$\sigma(pp \rightarrow 3j) = \sum_{ijk} \int f_i(x_1) f_j(x_2) \hat{\sigma}(ij \rightarrow k_1 k_2 k_3)$$

II. For each one, calculate the amplitude:

$$\mathcal{A}(\{p\}, \{h\}, \{c\}) = \sum_i D_i$$

# PREDICTIONS AT LO

How do we calculate a LO cross section for 3 jets at the LHC?

I. Identify all subprocesses ( $gg \rightarrow ggg$ ,  $qg \rightarrow qgg$ ....) in:

$$\sigma(pp \rightarrow 3j) = \sum_{ijk} \int f_i(x_1) f_j(x_2) \hat{\sigma}(ij \rightarrow k_1 k_2 k_3)$$

II. For each one, calculate the amplitude:

$$\mathcal{A}(\{p\}, \{h\}, \{c\}) = \sum_i D_i$$

III. Square the amplitude, sum over spins & color, integrate over the phase space ( $D \sim 3n$ )

$$\hat{\sigma} = \frac{1}{2\hat{s}} \int d\Phi_p \sum_{h,c} |\mathcal{A}|^2$$

# PREDICTIONS AT LO

How do we calculate a LO cross section for 3 jets at the LHC?

I. Identify all subprocesses ( $gg \rightarrow ggg$ ,  $qg \rightarrow qgg$ ....) in:

$$\sigma(pp \rightarrow 3j) = \sum_{ijk} \int f_i(x_1) f_j(x_2) \hat{\sigma}(ij \rightarrow k_1 k_2 k_3)$$

easy

II. For each one, calculate the amplitude:

$$\mathcal{A}(\{p\}, \{h\}, \{c\}) = \sum_i D_i$$

III. Square the amplitude, sum over spins & color, integrate over the phase space ( $D \sim 3n$ )

$$\hat{\sigma} = \frac{1}{2\hat{s}} \int d\Phi_p \sum_{h,c} |\mathcal{A}|^2$$



# PREDICTIONS AT LO

How do we calculate a LO cross section for 3 jets at the LHC?

I. Identify all subprocesses ( $gg \rightarrow ggg$ ,  $qg \rightarrow qgg$ ....) in:

$$\sigma(pp \rightarrow 3j) = \sum_{ijk} \int f_i(x_1) f_j(x_2) \hat{\sigma}(ij \rightarrow k_1 k_2 k_3)$$

easy

II. For each one, calculate the amplitude:

$$\mathcal{A}(\{p\}, \{h\}, \{c\}) = \sum_i D_i$$

difficult

III. Square the amplitude, sum over spins & color, integrate over the phase space ( $D \sim 3n$ )

$$\hat{\sigma} = \frac{1}{2\hat{s}} \int d\Phi_p \sum_{h,c} |\mathcal{A}|^2$$

# PREDICTIONS AT LO

How do we calculate a LO cross section for 3 jets at the LHC?

I. Identify all subprocesses ( $gg \rightarrow ggg$ ,  $qg \rightarrow qgg$ ....) in:

$$\sigma(pp \rightarrow 3j) = \sum_{ijk} \int f_i(x_1) f_j(x_2) \hat{\sigma}(ij \rightarrow k_1 k_2 k_3)$$

easy

II. For each one, calculate the amplitude:

$$\mathcal{A}(\{p\}, \{h\}, \{c\}) = \sum_i D_i$$

difficult

III. Square the amplitude, sum over spins & color, integrate over the phase space ( $D \sim 3n$ )

$$\hat{\sigma} = \frac{1}{2\hat{s}} \int d\Phi_p \sum_{h,c} |\mathcal{A}|^2$$

quite hard

# PHASE-SPACE INTEGRAL

- Calculations of cross section or decay widths involve integrations over phase space of very complex functions

# PHASE-SPACE INTEGRAL

- Calculations of cross section or decay widths involve integrations over phase space of very complex functions

$$\sigma = \frac{1}{2s} \int |\mathcal{M}|^2 d\Phi(n)$$

# PHASE-SPACE INTEGRAL

- Calculations of cross section or decay widths involve integrations over phase space of very complex functions

$$\sigma = \frac{1}{2s} \int |\mathcal{M}|^2 d\Phi(n) \quad \swarrow \text{Dim}[\Phi(n)] \sim 3n$$

# PHASE-SPACE INTEGRAL

- Calculations of cross section or decay widths involve integrations over phase space of very complex functions

$$\sigma = \frac{1}{2s} \int |\mathcal{M}|^2 d\Phi(n) \quad \swarrow \text{Dim}[\Phi(n)] \sim 3n$$

General and flexible method is needed:  
Numerical (Monte Carlo) integration

# PHASE-SPACE



# PHASE-SPACE

$$d\Phi_n = \left[ \prod_{i=1}^n \frac{d^3 p_i}{(2\pi)^3 (2E_i)} \right] (2\pi)^4 \delta^{(4)} \left( p_0 - \sum_{i=1}^n p_i \right)$$

# PHASE-SPACE

$$d\Phi_n = \left[ \prod_{i=1}^n \frac{d^3 p_i}{(2\pi)^3 (2E_i)} \right] (2\pi)^4 \delta^{(4)} \left( p_0 - \sum_{i=1}^n p_i \right)$$

$$d\Phi_2(M) = \frac{1}{8\pi} \frac{2p}{M} \frac{d\Omega}{4\pi}$$

# PHASE-SPACE

$$d\Phi_n = \left[ \prod_{i=1}^n \frac{d^3 p_i}{(2\pi)^3 (2E_i)} \right] (2\pi)^4 \delta^{(4)} \left( p_0 - \sum_{i=1}^n p_i \right)$$

$$d\Phi_2(M) = \frac{1}{8\pi} \frac{2p}{M} \frac{d\Omega}{4\pi}$$

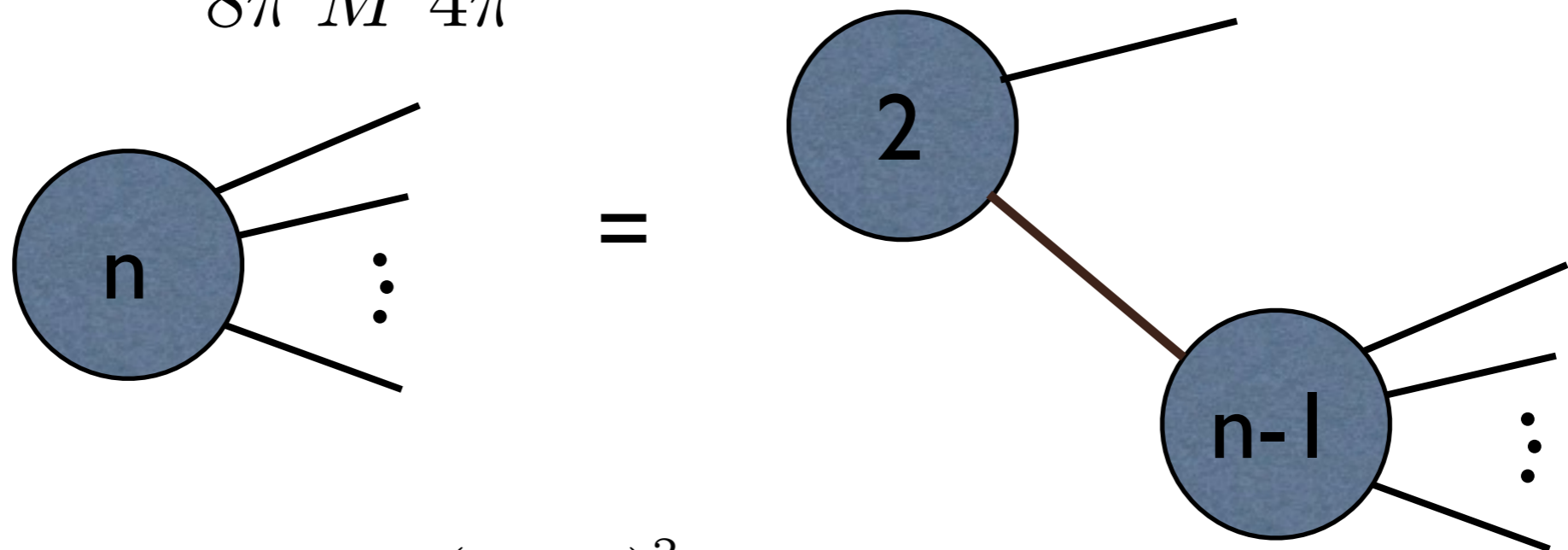

$$d\Phi_n(M) = \frac{1}{2\pi} \int_0^{(M-\mu)^2} d\mu^2 d\Phi_2(M) d\Phi_{n-1}(\mu)$$

# INTEGRALS AS AVERAGES



$$I = \int_{x_1}^{x_2} f(x) dx \quad \longrightarrow \quad I_N = (x_2 - x_1) \frac{1}{N} \sum_{i=1}^N f(x)$$

$$V = (x_2 - x_1) \int_{x_1}^{x_2} [f(x)]^2 dx - I^2 \quad \longrightarrow \quad V_N = (x_2 - x_1)^2 \frac{1}{N} \sum_{i=1}^N [f(x)]^2 - I_N^2$$

# INTEGRALS AS AVERAGES



$$I = \int_{x_1}^{x_2} f(x) dx \quad \longrightarrow \quad I_N = (x_2 - x_1) \frac{1}{N} \sum_{i=1}^N f(x_i)$$

$$V = (x_2 - x_1) \int_{x_1}^{x_2} [f(x)]^2 dx - I^2 \quad \longrightarrow \quad V_N = (x_2 - x_1)^2 \frac{1}{N} \sum_{i=1}^N [f(x_i)]^2 - I_N^2$$

$$I = I_N \pm \sqrt{V_N/N}$$

# INTEGRALS AS AVERAGES



$$I = \int_{x_1}^{x_2} f(x) dx \quad \longrightarrow \quad I_N = (x_2 - x_1) \frac{1}{N} \sum_{i=1}^N f(x_i)$$

$$V = (x_2 - x_1) \int_{x_1}^{x_2} [f(x)]^2 dx - I^2 \quad \longrightarrow \quad V_N = (x_2 - x_1)^2 \frac{1}{N} \sum_{i=1}^N [f(x_i)]^2 - I_N^2$$

$$I = I_N \pm \sqrt{V_N/N}$$

- 👉 Convergence is slow but it can be estimated easily
- 👉 Error does not depend on # of dimensions!
- 👉 Improvement by minimizing  $V_N$
- 👉 Optimal/Ideal case:  $f(x) = \text{Constant} \Rightarrow V_N = 0$

# IMPORTANCE SAMPLING

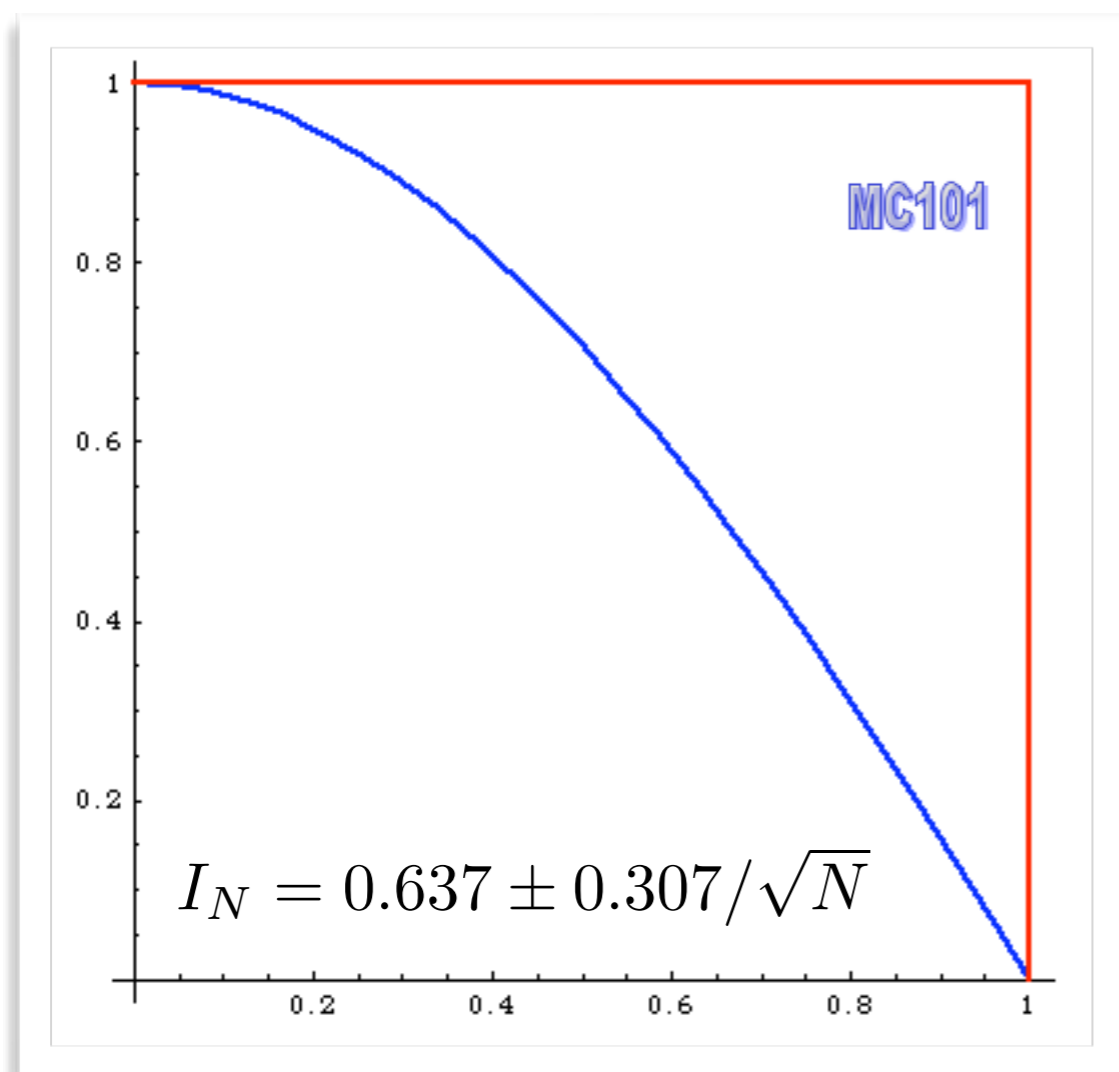

$$I = \int_0^1 dx \cos \frac{\pi}{2} x$$

# IMPORTANCE SAMPLING

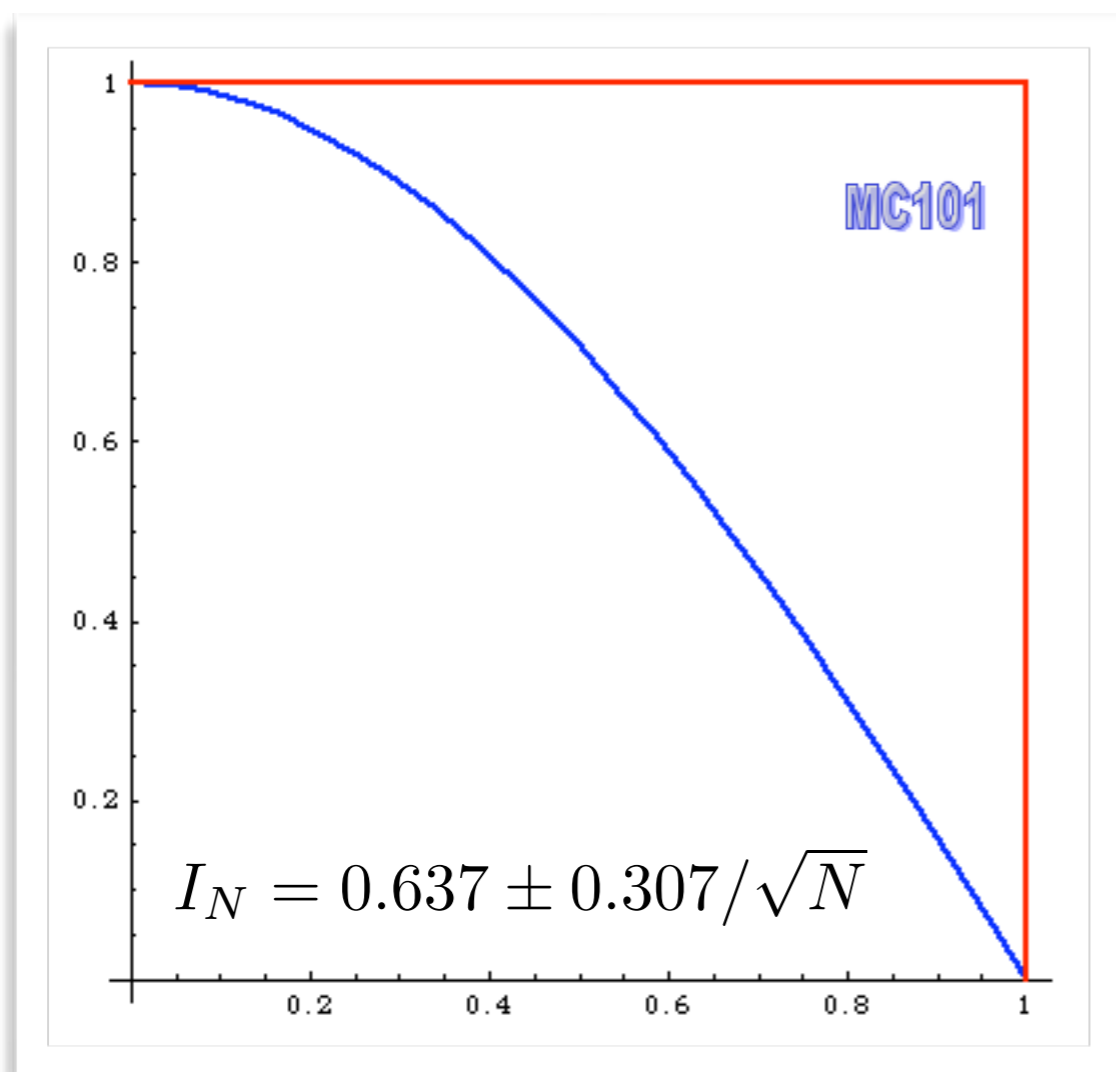

$$I = \int_0^1 dx \cos \frac{\pi}{2} x$$

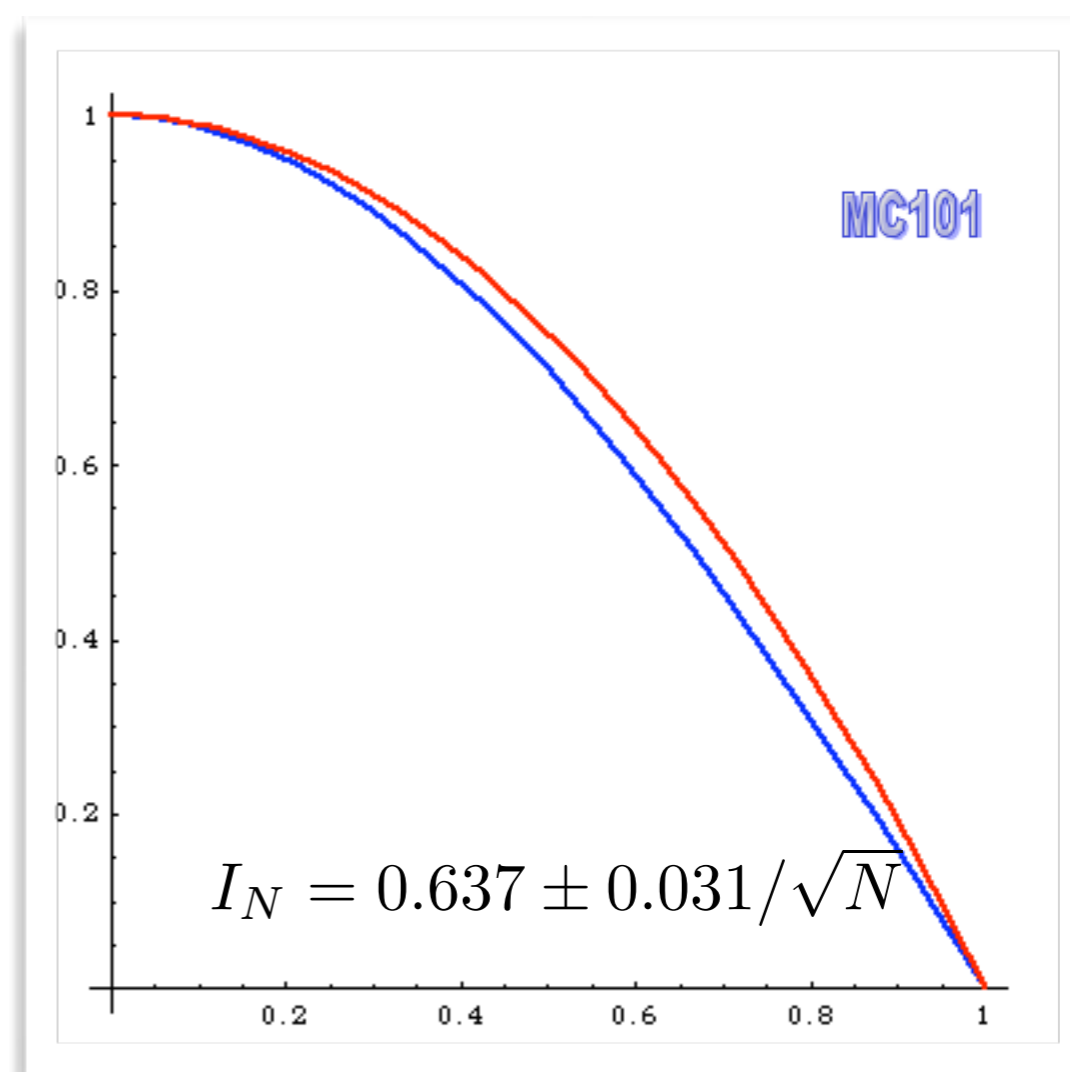

$$I = \int_0^1 dx (1 - x^2) \frac{\cos \frac{\pi}{2} x}{1 - x^2}$$



# IMPORTANCE SAMPLING

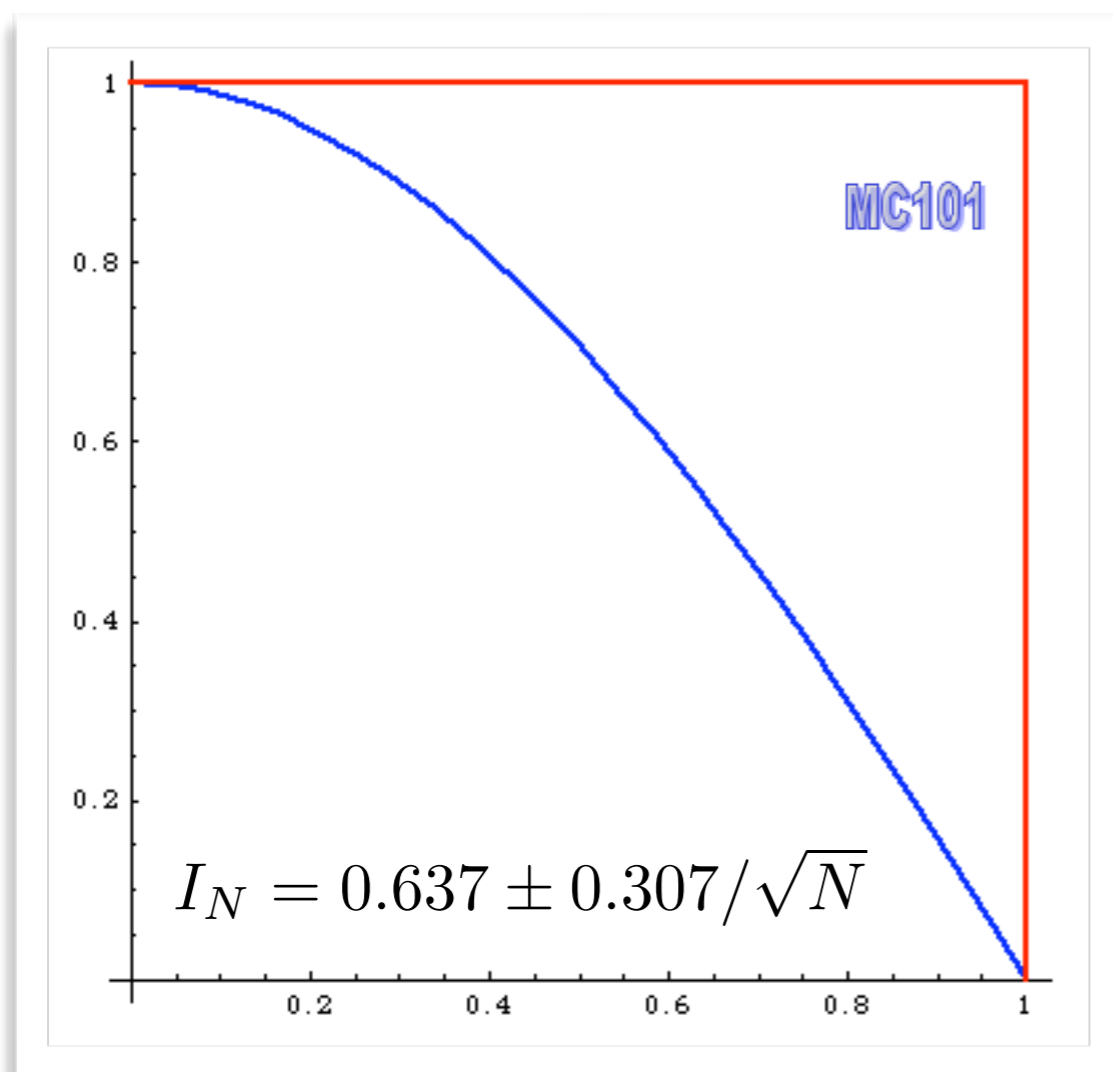

$$I = \int_0^1 dx \cos \frac{\pi}{2} x$$

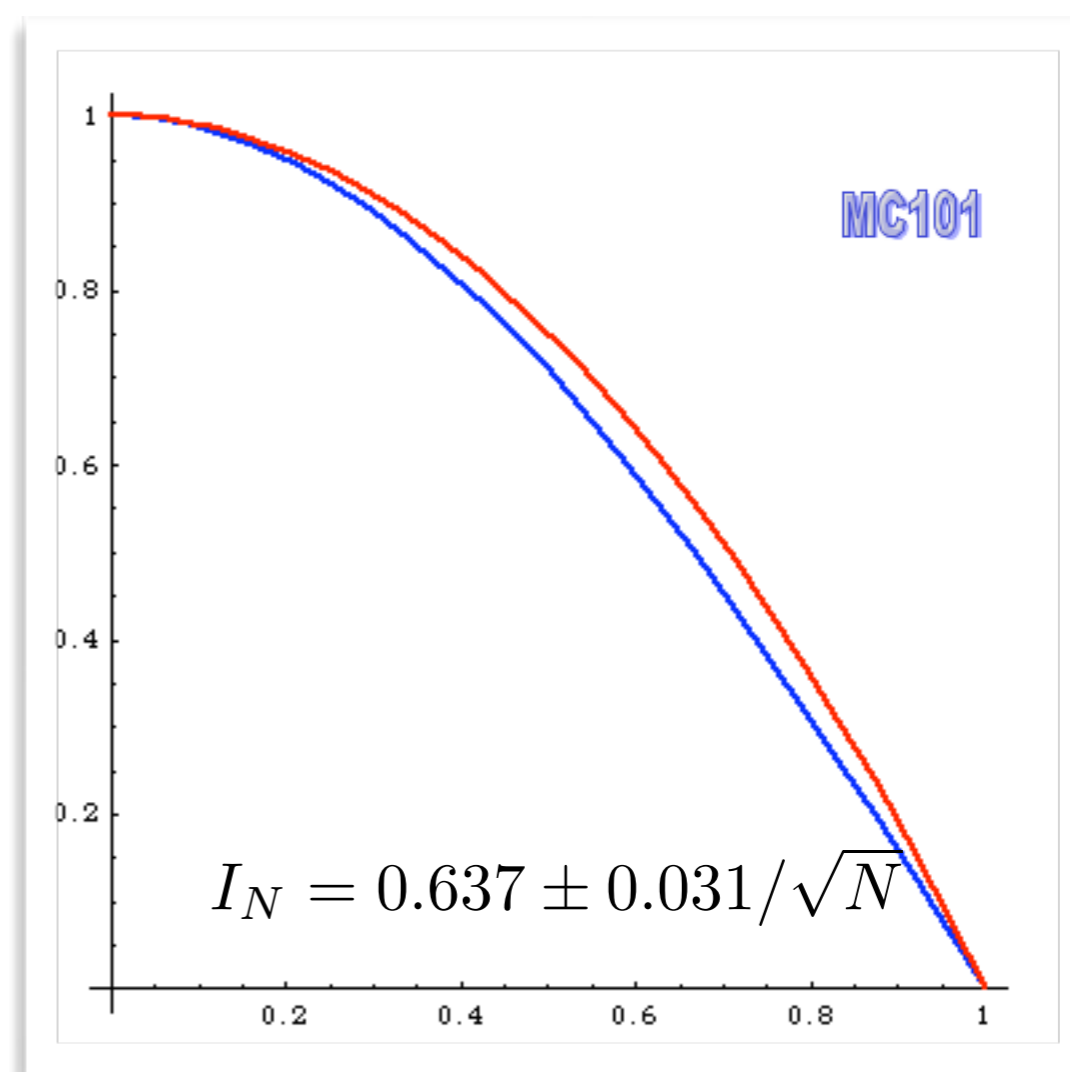

$$I = \int_0^1 dx (1 - x^2) \frac{\cos \frac{\pi}{2} x}{1 - x^2}$$

$$= \int_{\xi_1}^{\xi_2} d\xi \frac{\cos \frac{\pi}{2} x[\xi]}{1 - x[\xi]^2}$$

# IMPORTANCE SAMPLING

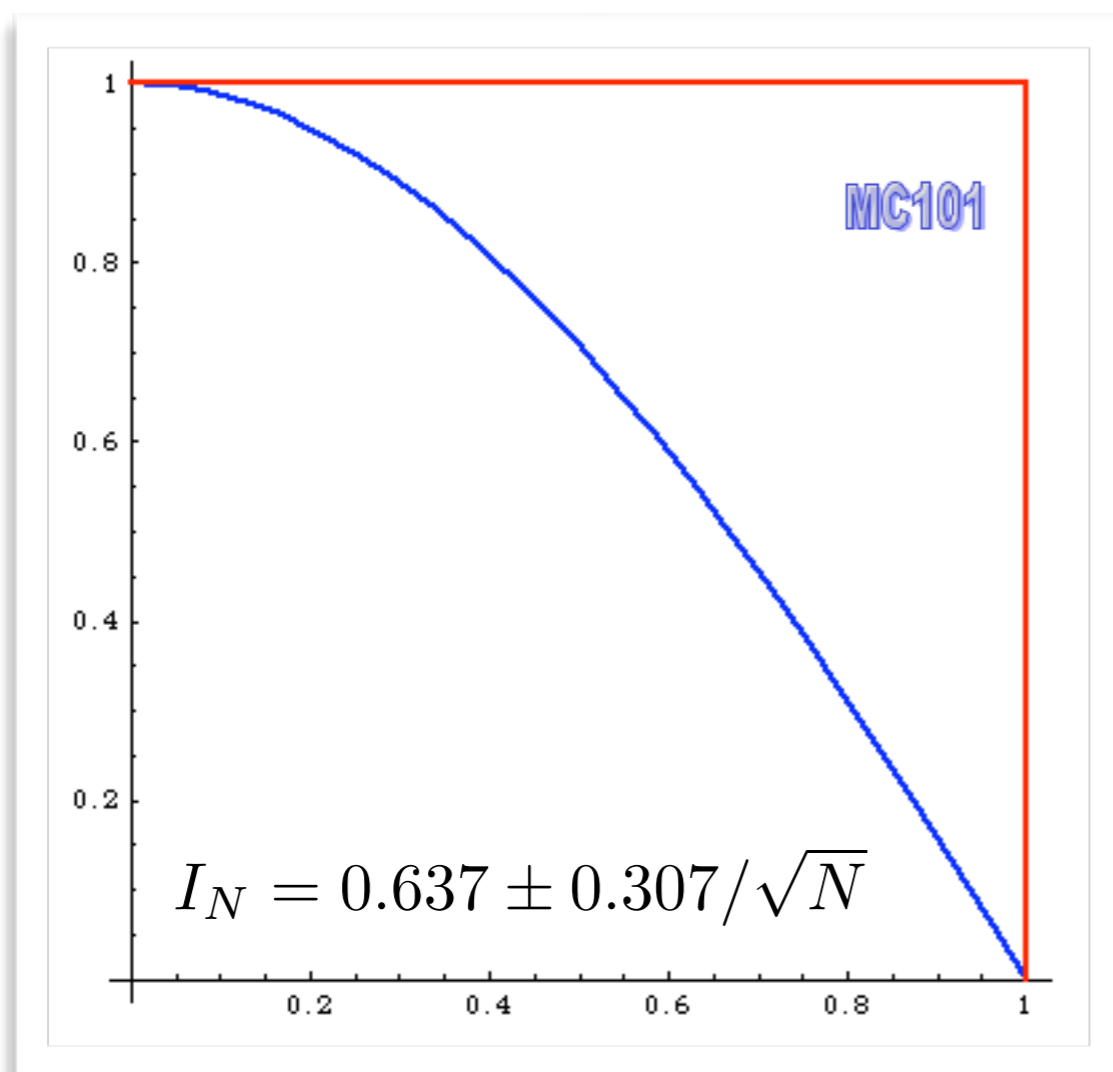

$$I = \int_0^1 dx \cos \frac{\pi}{2} x$$

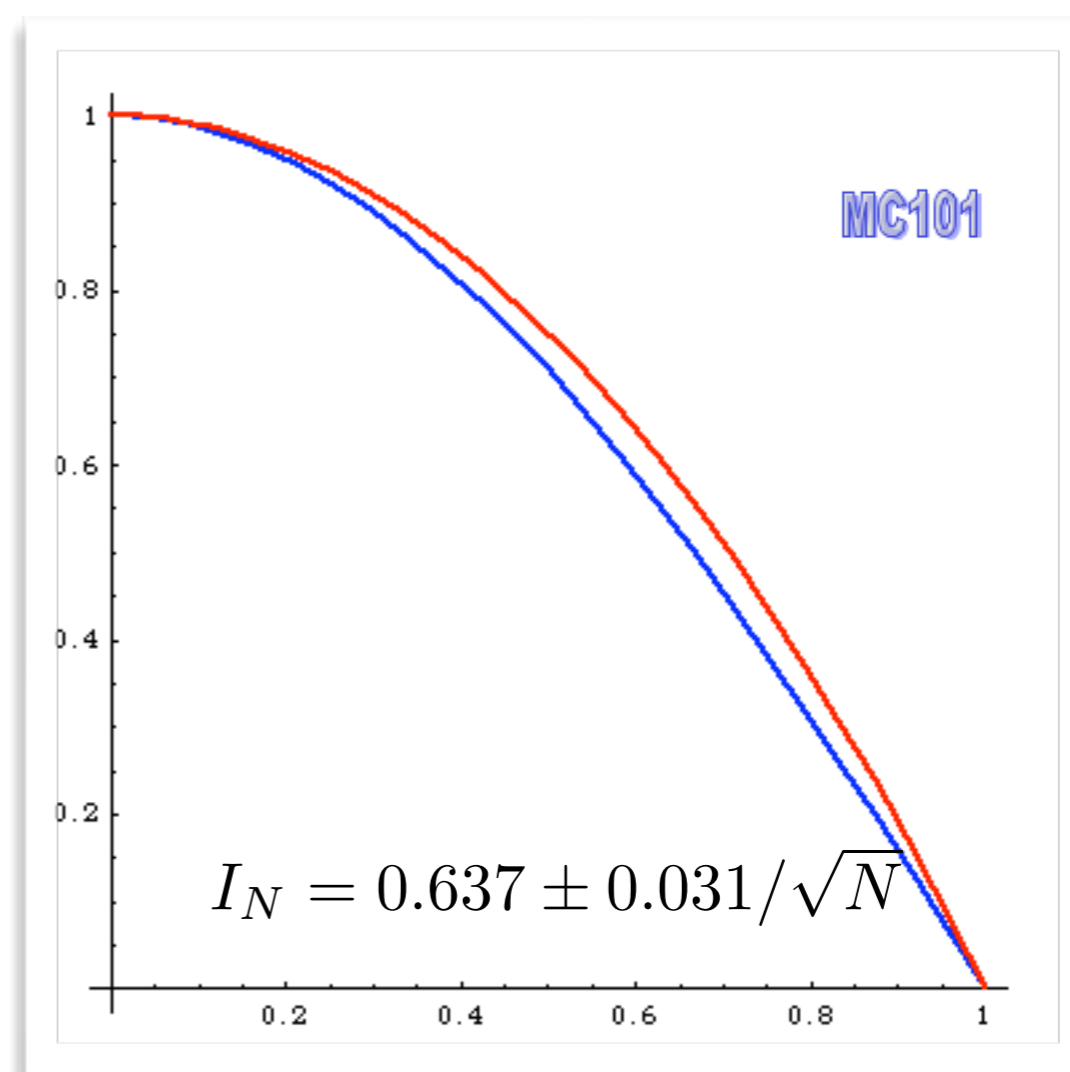

$$I = \int_0^1 dx (1-x^2) \frac{\cos \frac{\pi}{2} x}{1-x^2}$$

$$= \int_{\xi_1}^{\xi_2} d\xi \frac{\cos \frac{\pi}{2} x[\xi]}{1-x[\xi]^2}$$

# IMPORTANCE SAMPLING

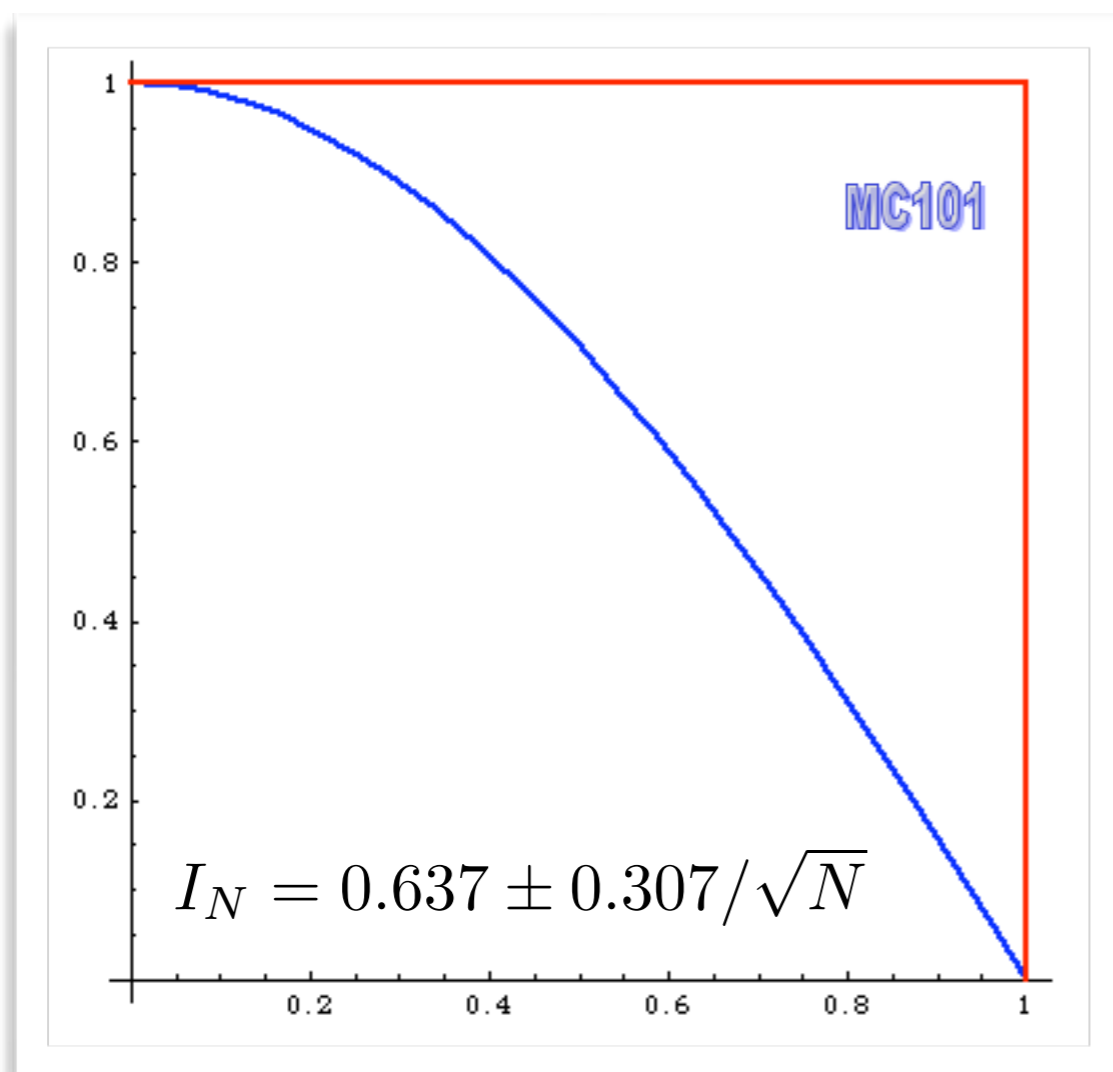

$$I = \int_0^1 dx \cos \frac{\pi}{2} x$$

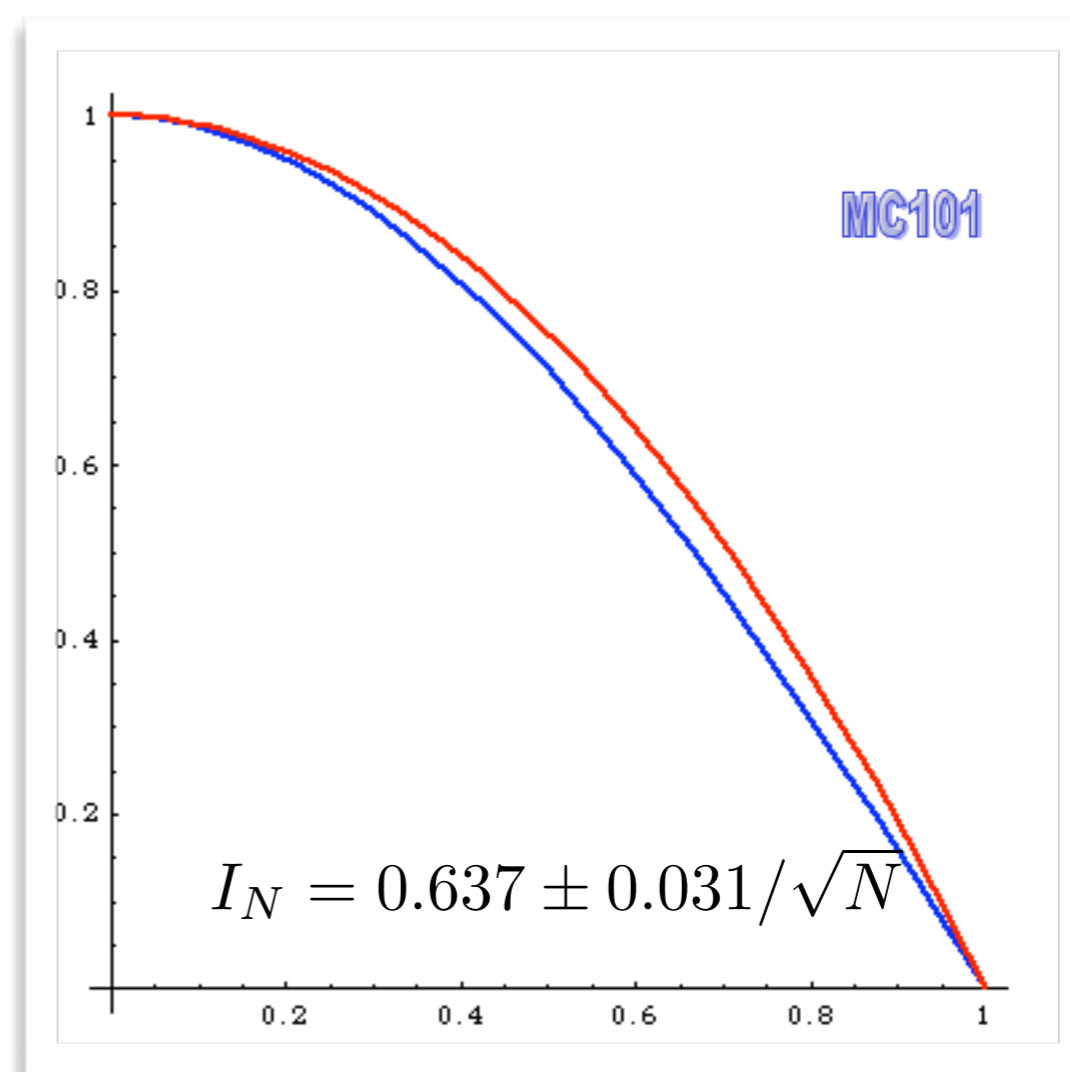

$$I = \int_0^1 dx (1 - x^2) \frac{\cos \frac{\pi}{2} x}{1 - x^2}$$

$$= \int_{\xi_1}^{\xi_2} d\xi \frac{\cos \frac{\pi}{2} x[\xi]}{1 - x[\xi]^2} \rightarrow \simeq 1$$

# EVENT GENERATION

- Every phase-space point computed in this way, can be seen as an event (=collision) in a detector
- However, they still carry the “weight” of the matrix elements:
  - ▷ events with large weights where the cross section is large
  - ▷ events with small weights where the cross section is small
- In nature, the events don't carry a weight:
  - ▷ more events where the cross section is large
  - ▷ less events where the cross section is small
- How to go from weighted events to unweighted events?

# EVENT GENERATION

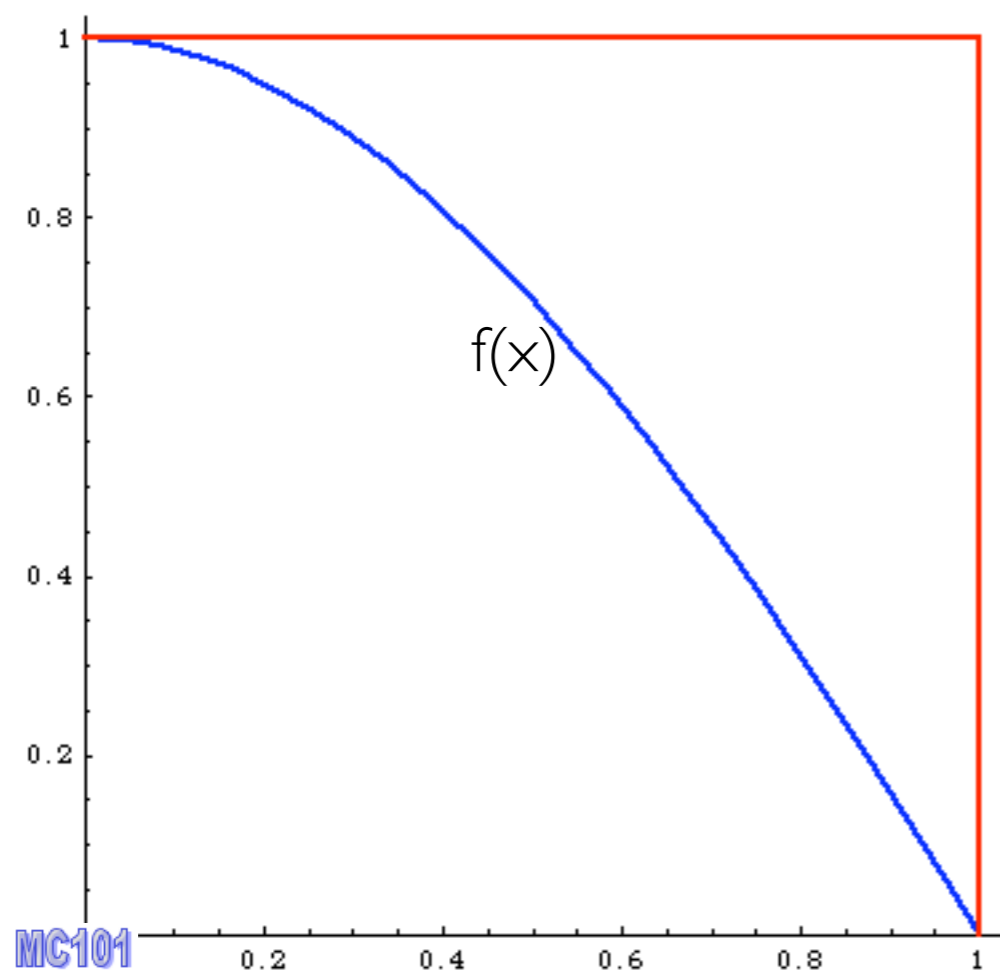

Alternative way

# EVENT GENERATION

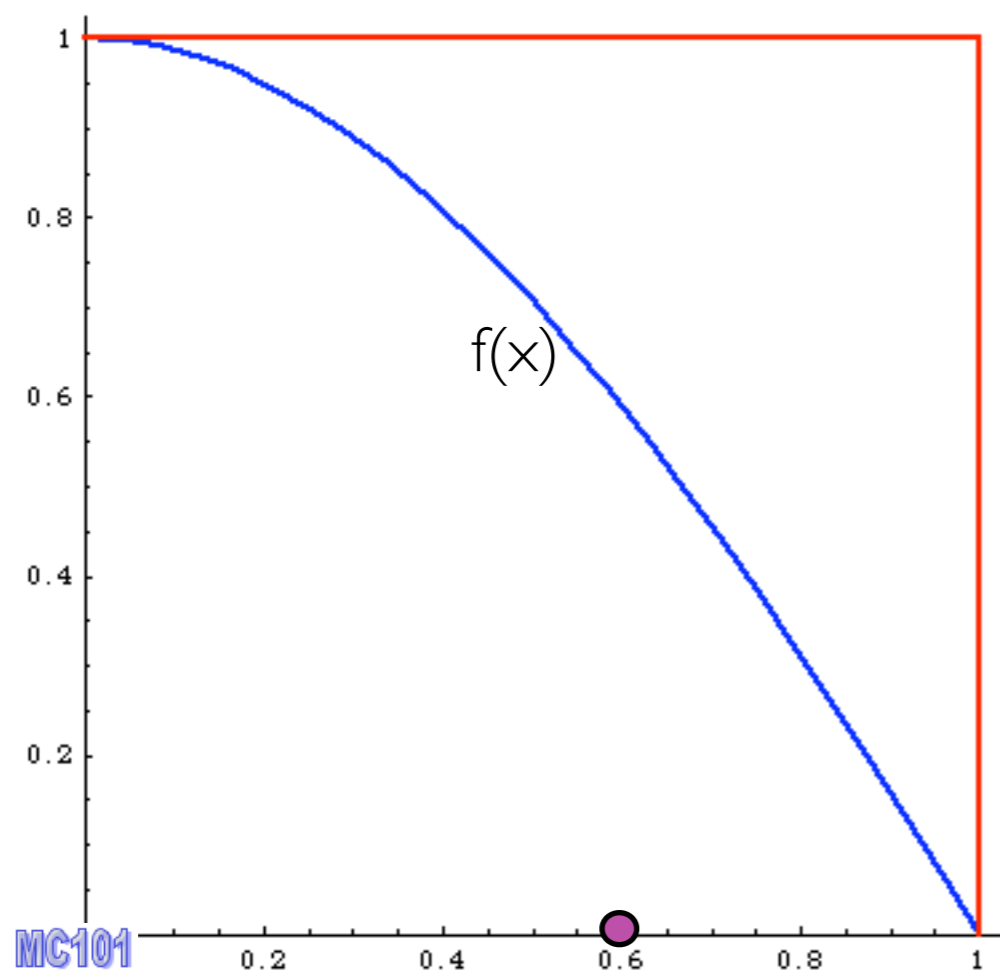

Alternative way

1. (randomly) pick  $x$

# EVENT GENERATION

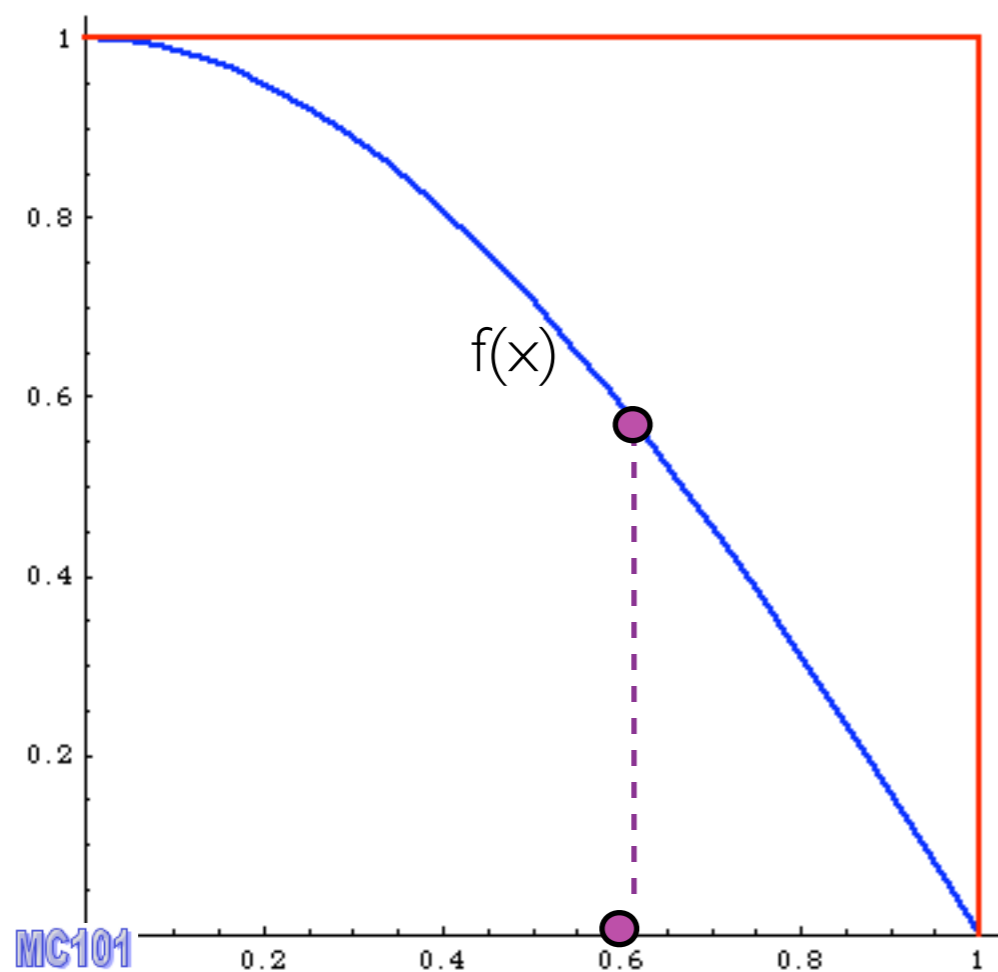

Alternative way

1. (randomly) pick  $x$
2. calculate  $f(x)$

# EVENT GENERATION

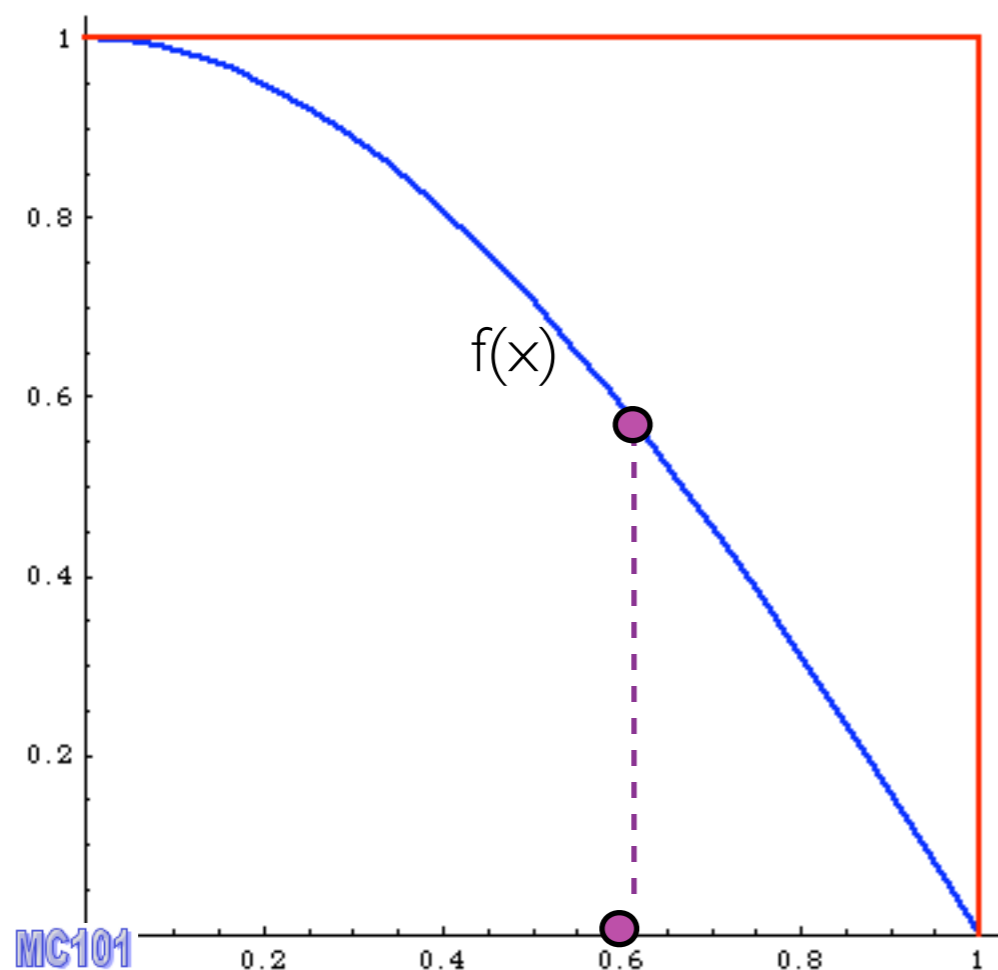

Alternative way

1. (randomly) pick  $x$
2. calculate  $f(x)$
3. (randomly) pick  $0 < y < f_{\max}$



# EVENT GENERATION

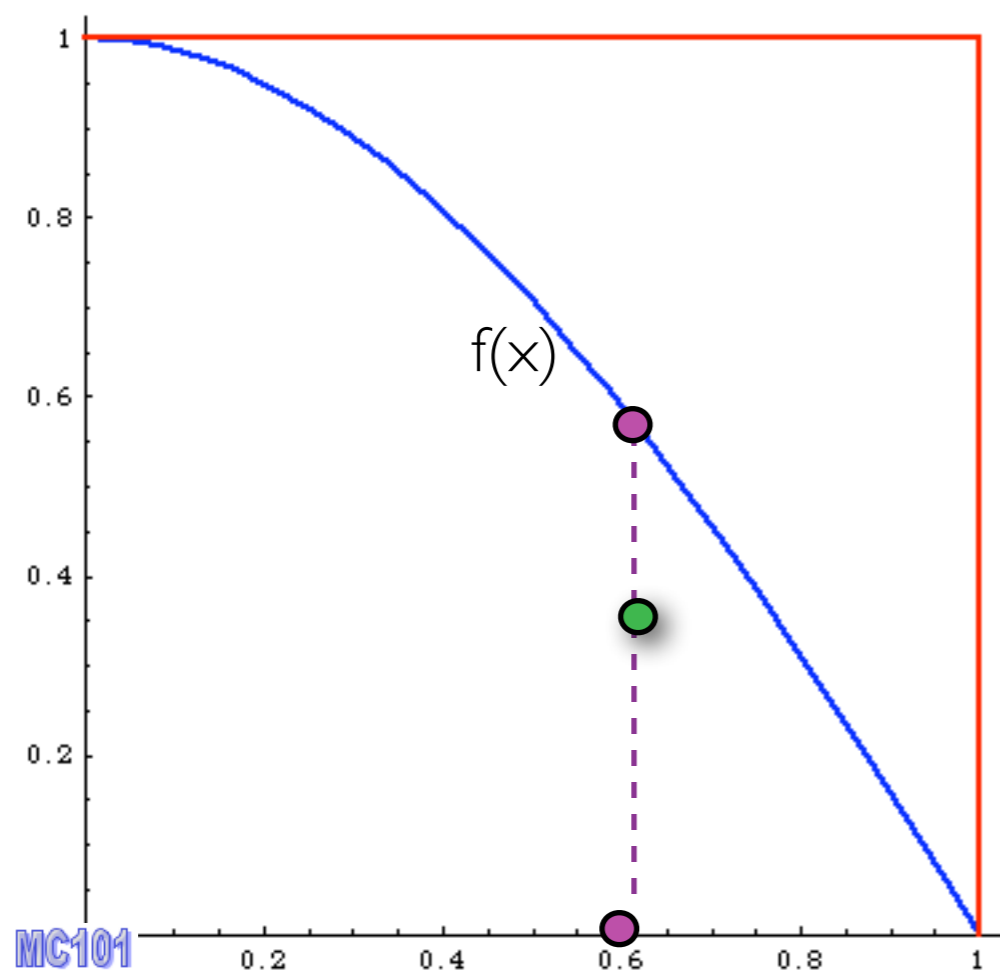

Alternative way

1. (randomly) pick  $x$
2. calculate  $f(x)$
3. (randomly) pick  $0 < y < f_{\max}$
4. Compare:  
if  $f(x) > y$  accept event,

# EVENT GENERATION

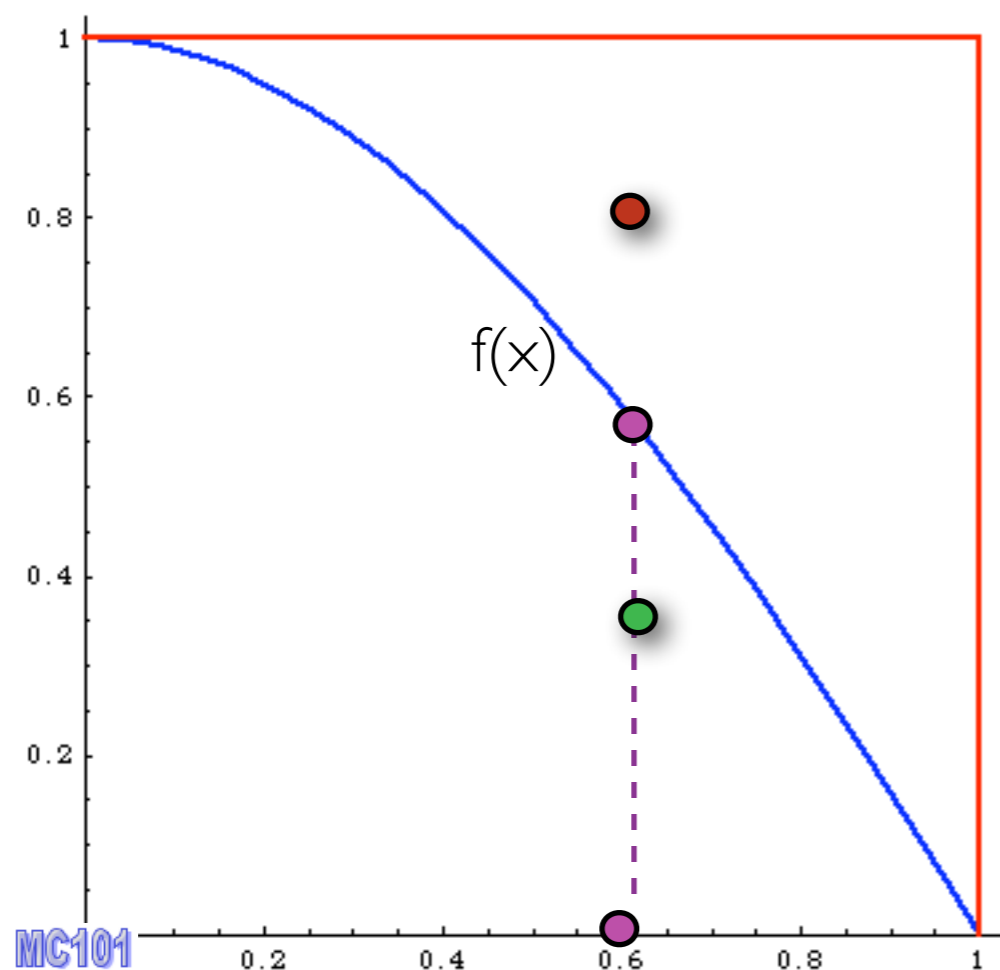

Alternative way

1. (randomly) pick  $x$
2. calculate  $f(x)$
3. (randomly) pick  $0 < y < f_{\max}$
4. Compare:  
if  $f(x) > y$  accept event,  
else reject it.

# EVENT GENERATION

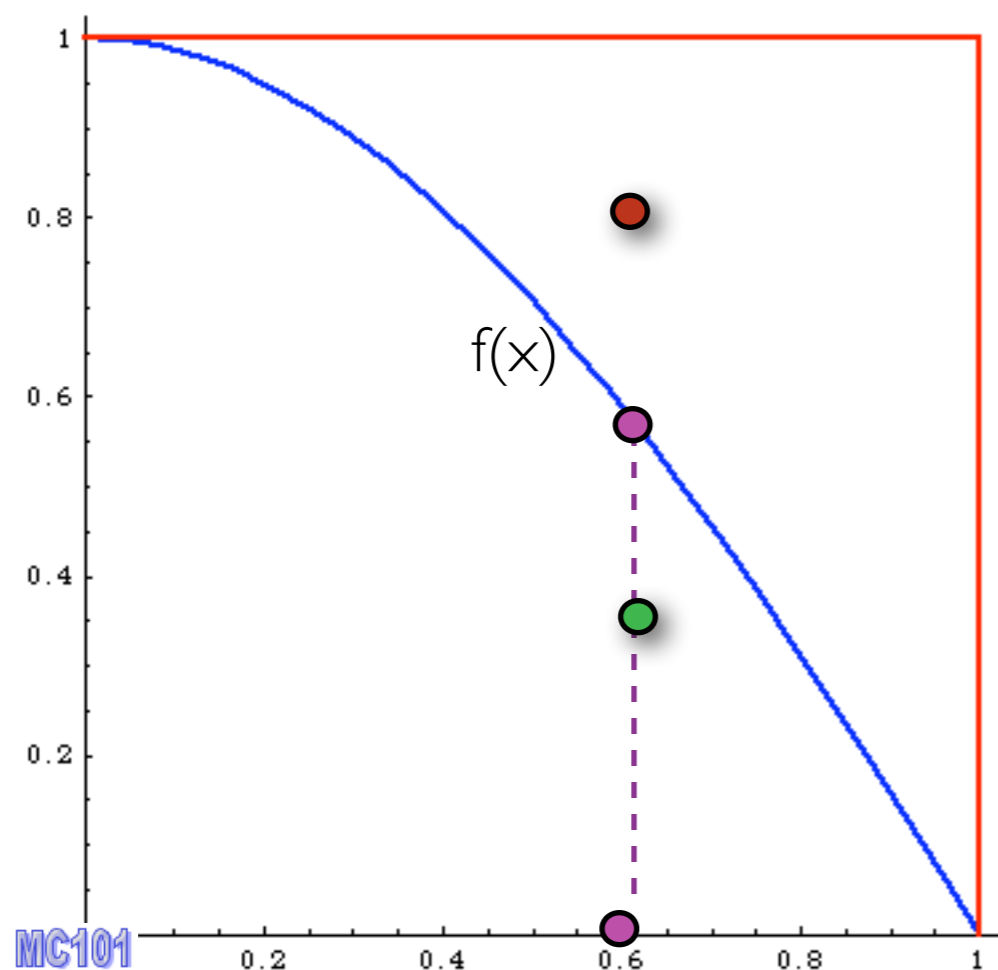

Alternative way

1. (randomly) pick  $x$
2. calculate  $f(x)$
3. (randomly) pick  $0 < y < f_{\max}$
4. Compare:  
if  $f(x) > y$  accept event,  
else reject it.

$$\text{Integral} = \frac{\text{accepted}}{\text{total tries}} = \text{efficiency}$$

# EVENT GENERATION

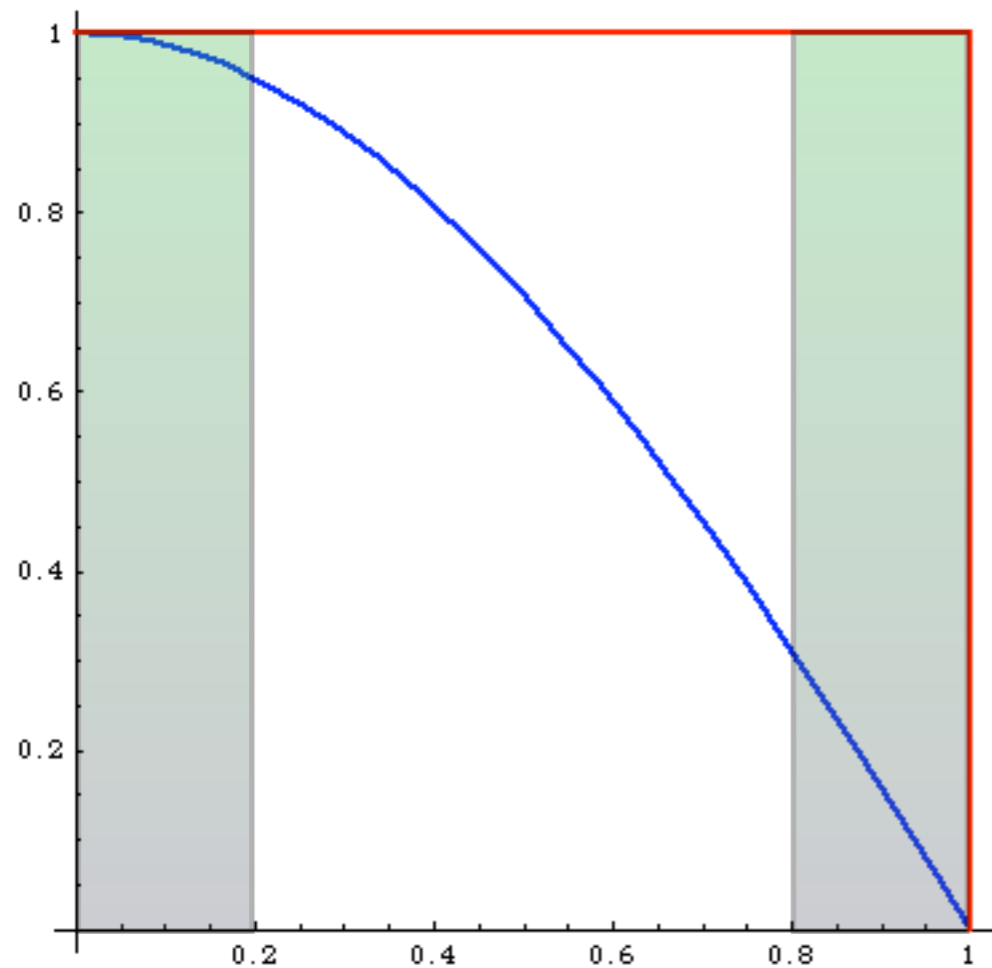

What's the difference?

before:

Same # of events in areas of phase space with very different probabilities:

Events must have different weights:

$$w_i = p(x_i)$$

# EVENT GENERATION

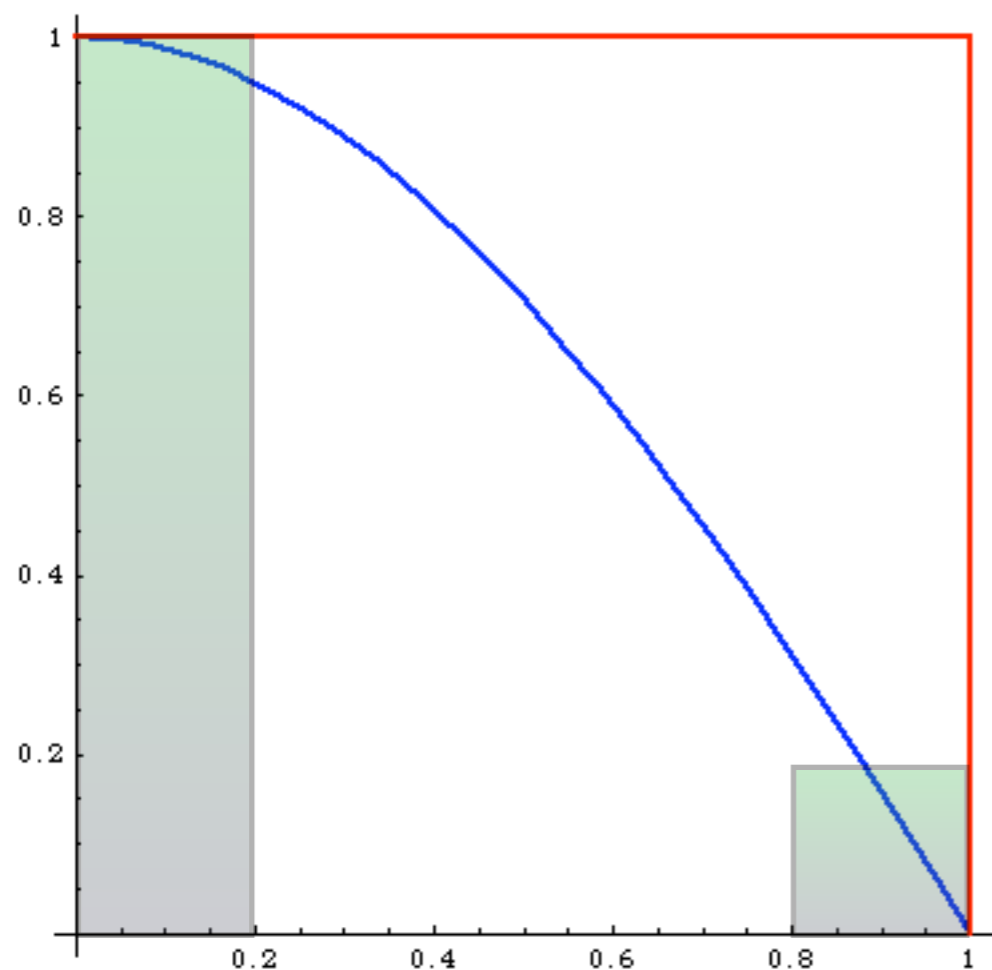

What's the difference?

after:

# events is proportional to the probability of areas of phase space:

Events have all the same weight ("unweighted")

Events distributed as in Nature

# EVENT GENERATION

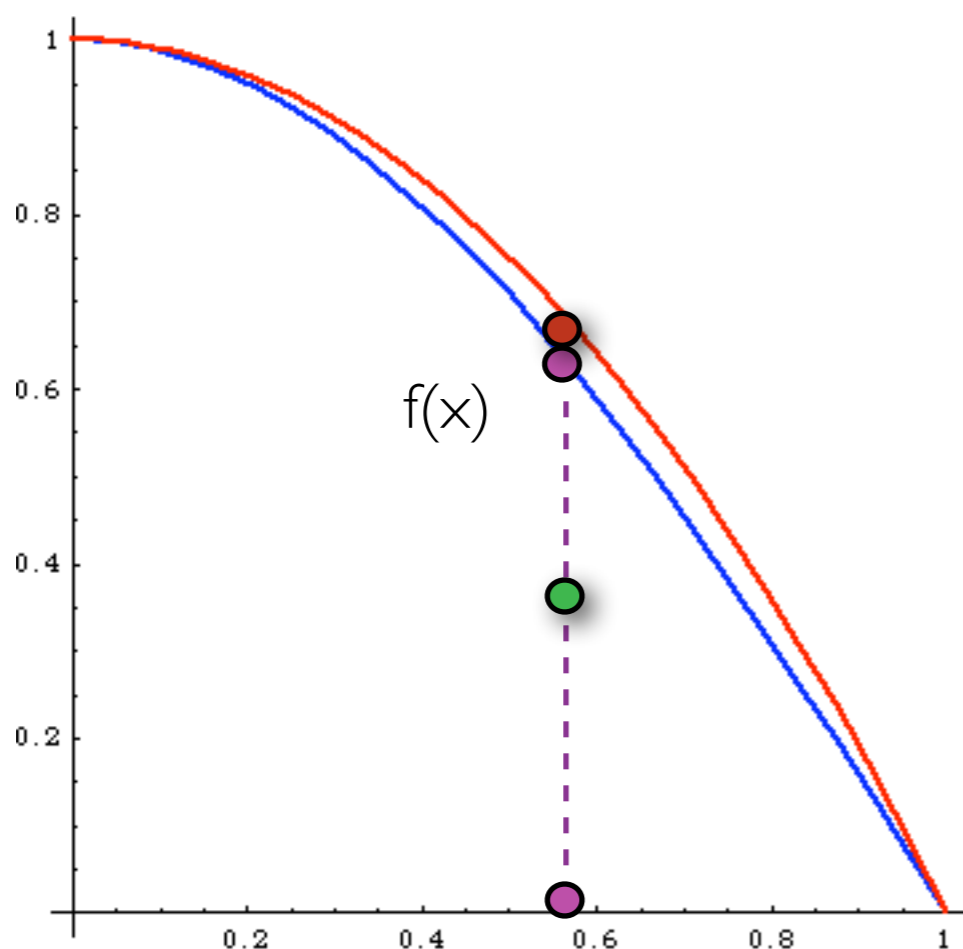

Improved

1. pick  $x$  distributed as  $p(x)$
2. calculate  $f(x)$  and  $p(x)$
3. pick  $0 < y < 1$
4. Compare:  
if  $f(x) > y$   $p(x)$  accept event,  
else reject it.

much better efficiency!!!

# EVENT GENERATION

# EVENT GENERATION

MC integrator



# EVENT GENERATION

MC integrator

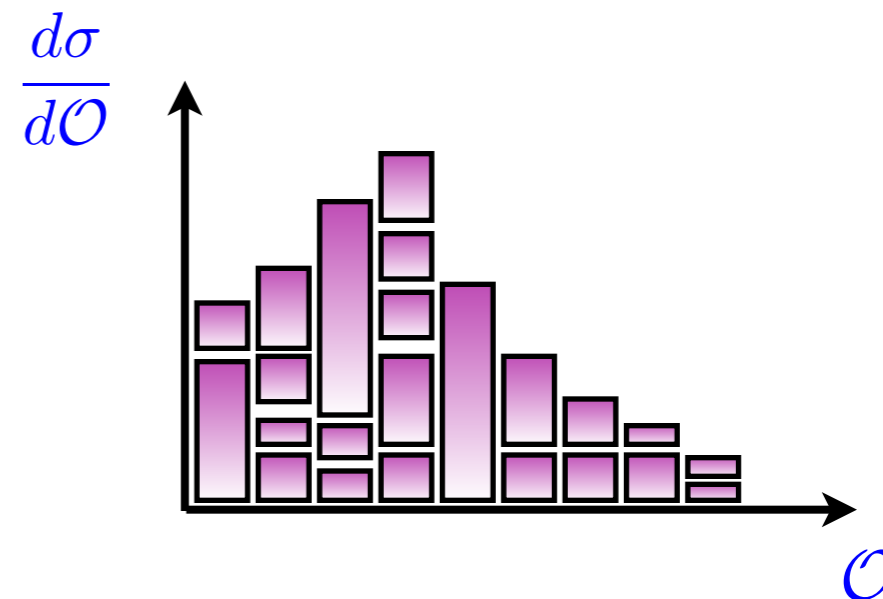

# EVENT GENERATION

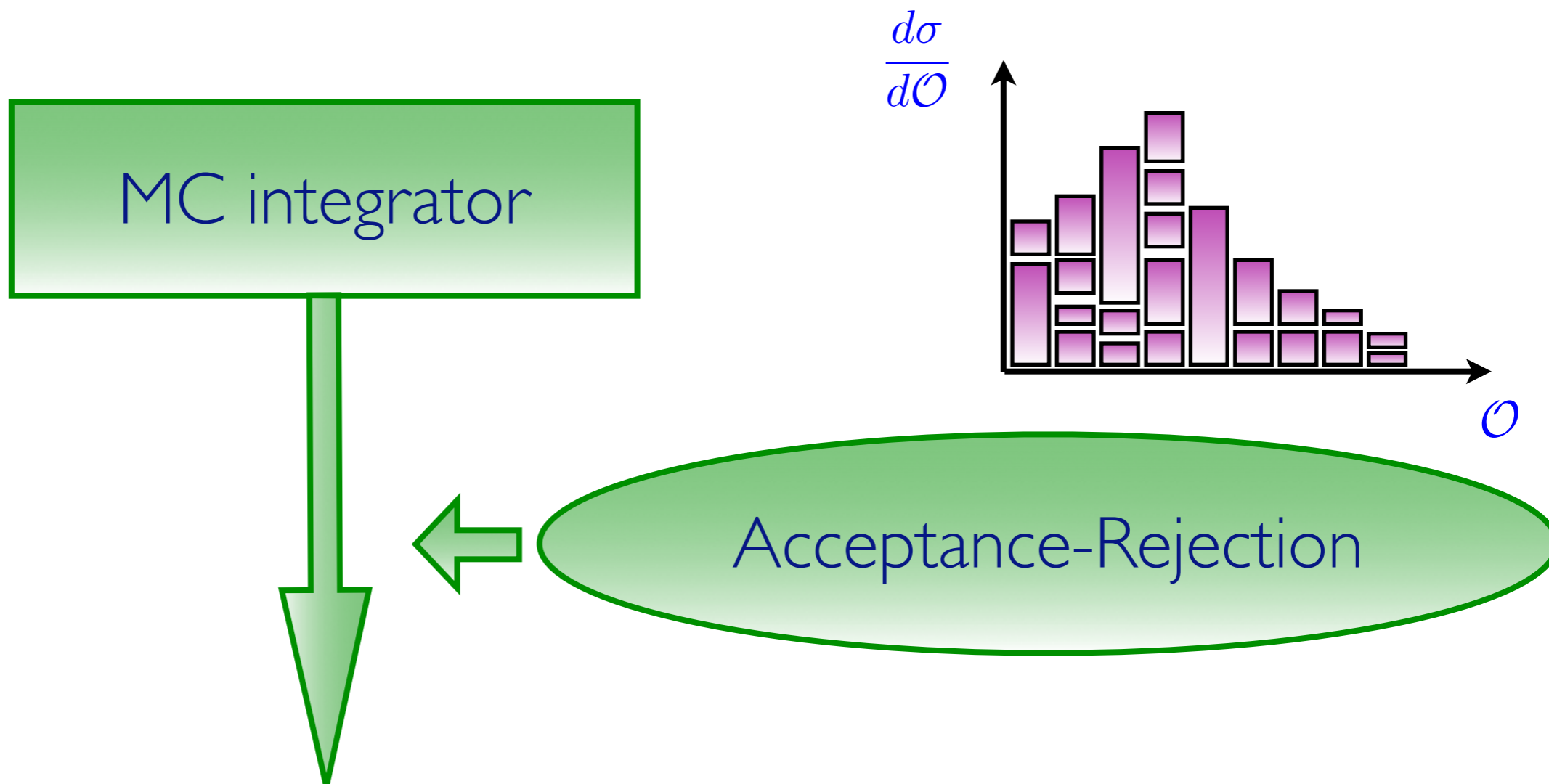

# EVENT GENERATION

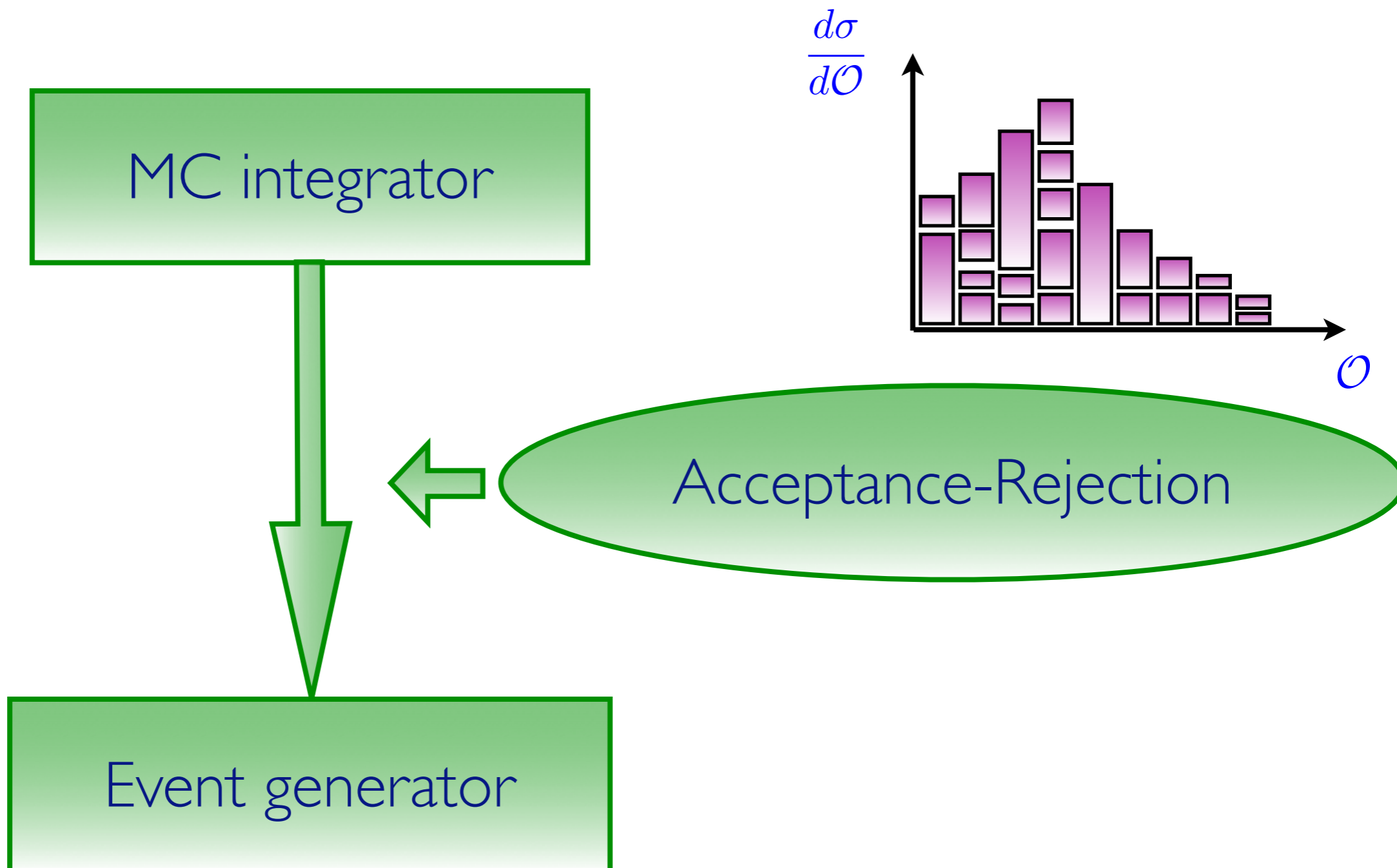

# EVENT GENERATION

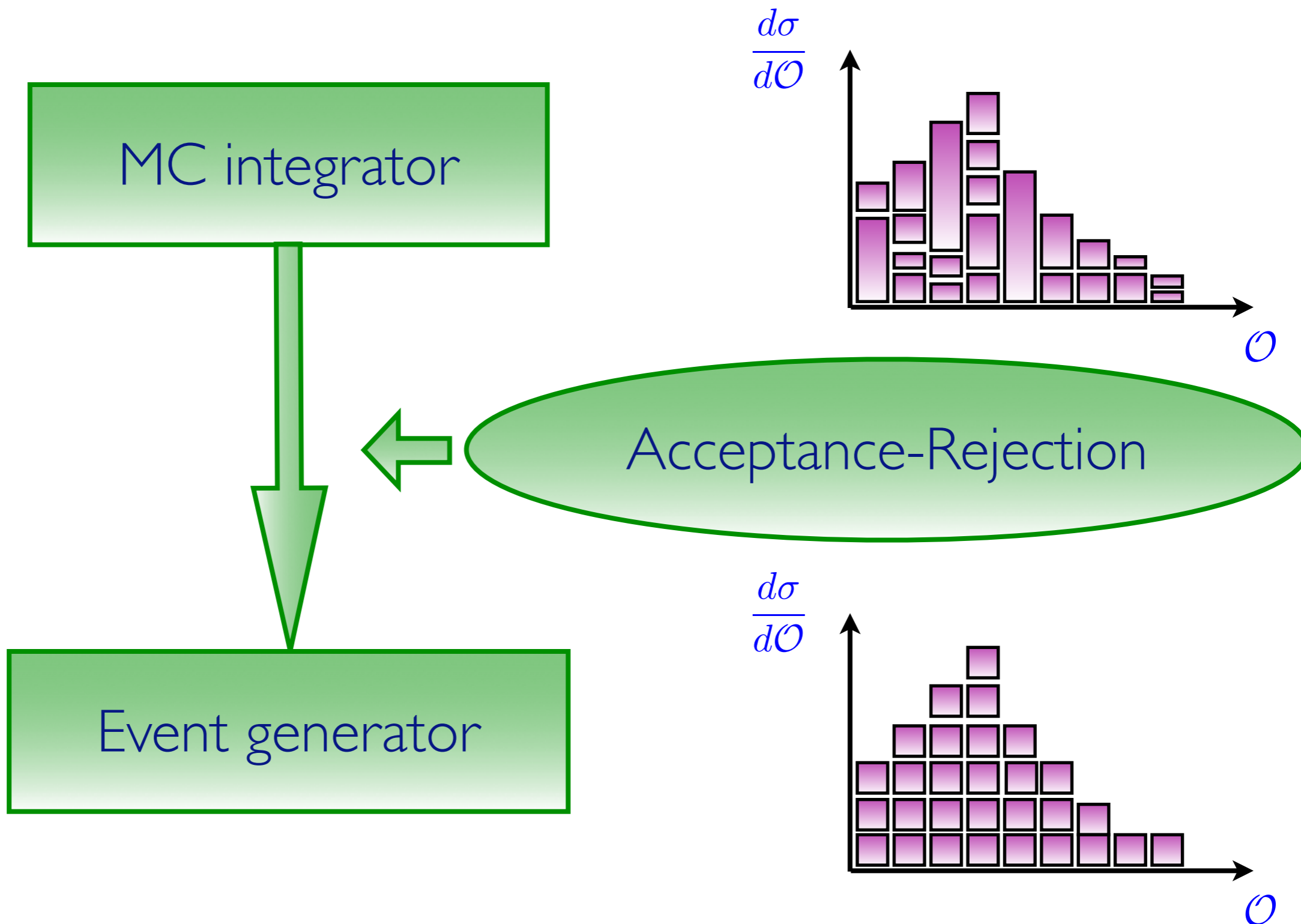

# EVENT GENERATION

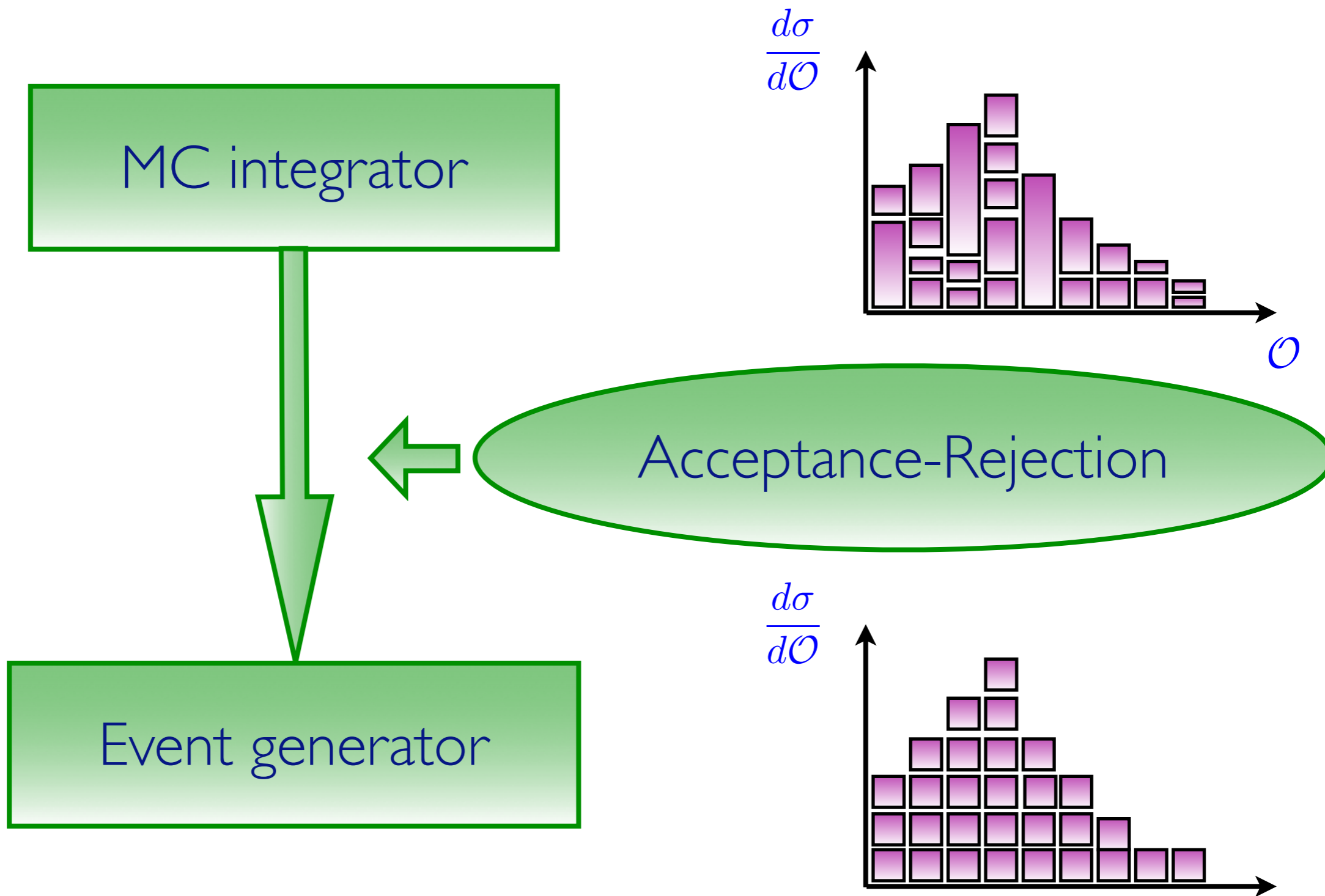

👉 This is possible only if  $f(x)$  is bounded (and has definite sign)!

## MC EVENT GENERATOR: DEFINITION

At the most basic level a Monte Carlo event generator is a program which produces particle physics events with the same probability as they occur in nature (virtual collider).

In practice it performs (a possibly large) number of (sometimes very difficult) integrals and then unweights to give the four momenta of the particles that interact with the detector (simulation).

Note that, at least among theorists, the definition of a “Monte Carlo program” also includes codes which don’t provide a fully exclusive information on the final state but only cross sections or distributions at the parton level, even when no unweighting can be performed (typically at NLO).

I will refer to these kind of codes as “MC integrators”.

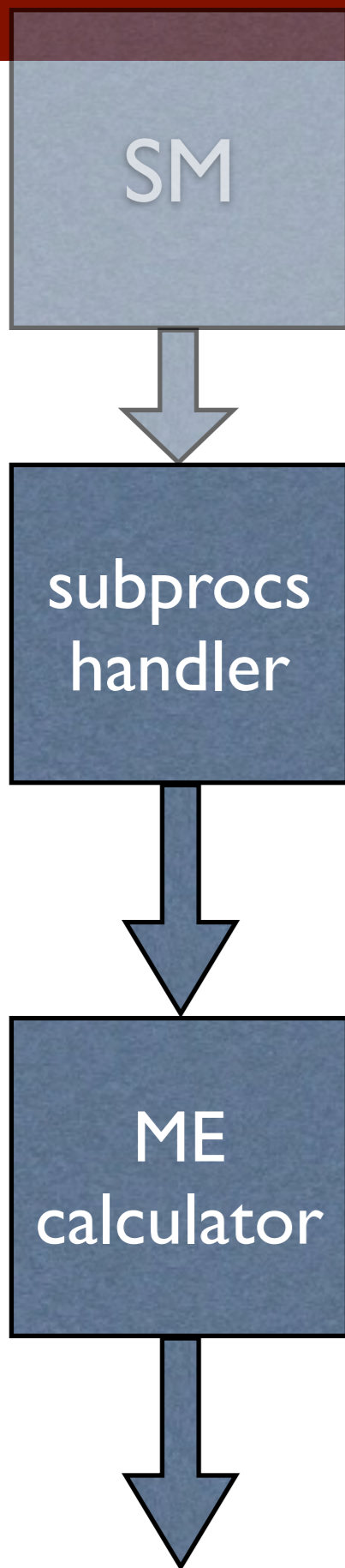

# GENERAL STRUCTURE

Includes all possible subprocess leading to a given multi-jet final state automatically or manually (done once for all)

“Automatically” generates a code to calculate  $|M|^2$  for arbitrary processes with many partons in the final state. Use Feynman diagrams with tricks to reduce the factorial growth, others have recursive relations to reduce the complexity to exponential. 😊

$d \sim d \rightarrow a d d \sim u u \sim g$   
 $d \sim d \rightarrow a d d \sim c c \sim g$   
 $s \sim s \rightarrow a d d \sim u u \sim g$   
 $s \sim s \rightarrow a d d \sim c c \sim g$   
 ...

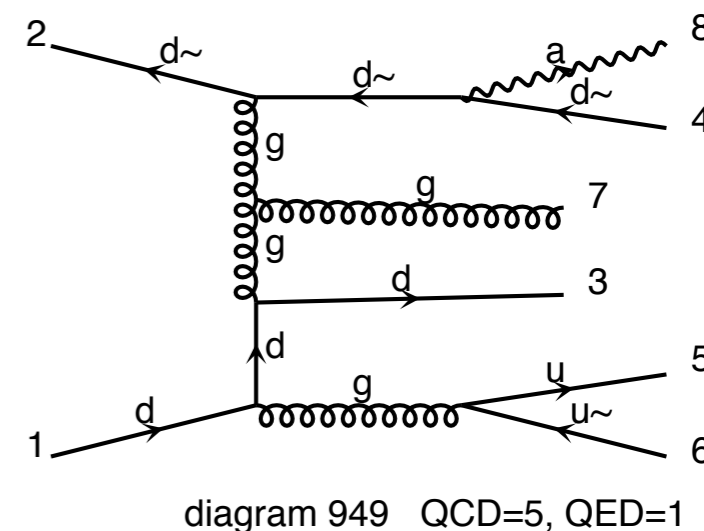

# GENERAL STRUCTURE

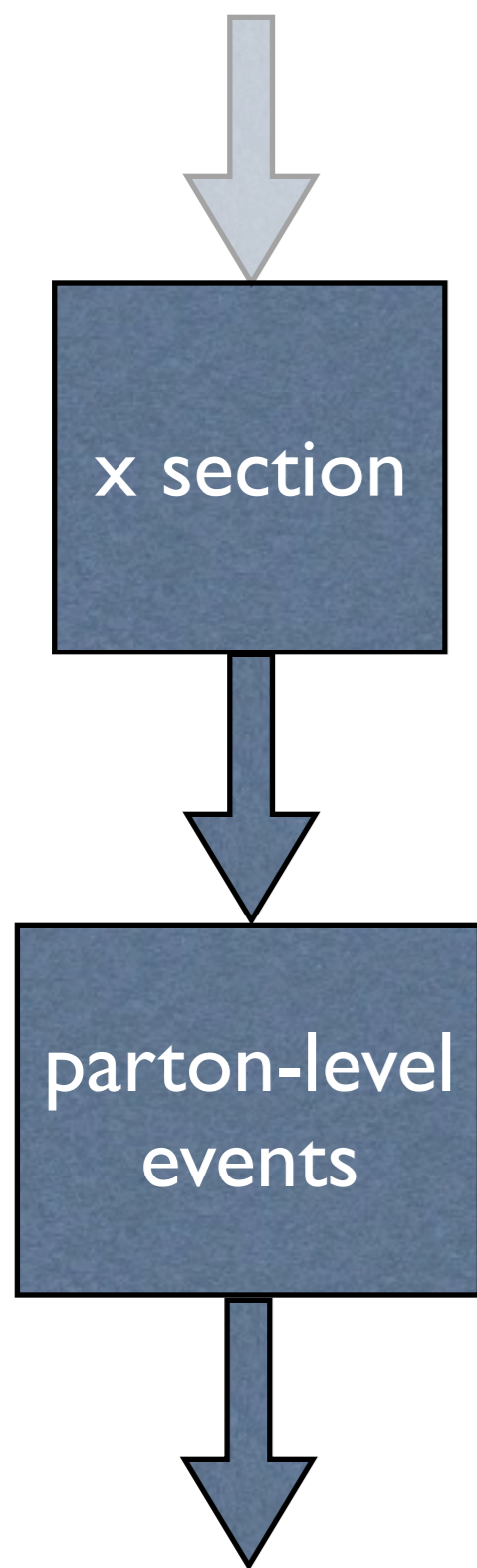

Integrate the matrix element over the phase space using a multi-channel technique and using parton-level cuts.

Events are obtained by unweighting. These are at the parton-level. Information on particle id, momenta, spin, color is given in the Les Houches format.

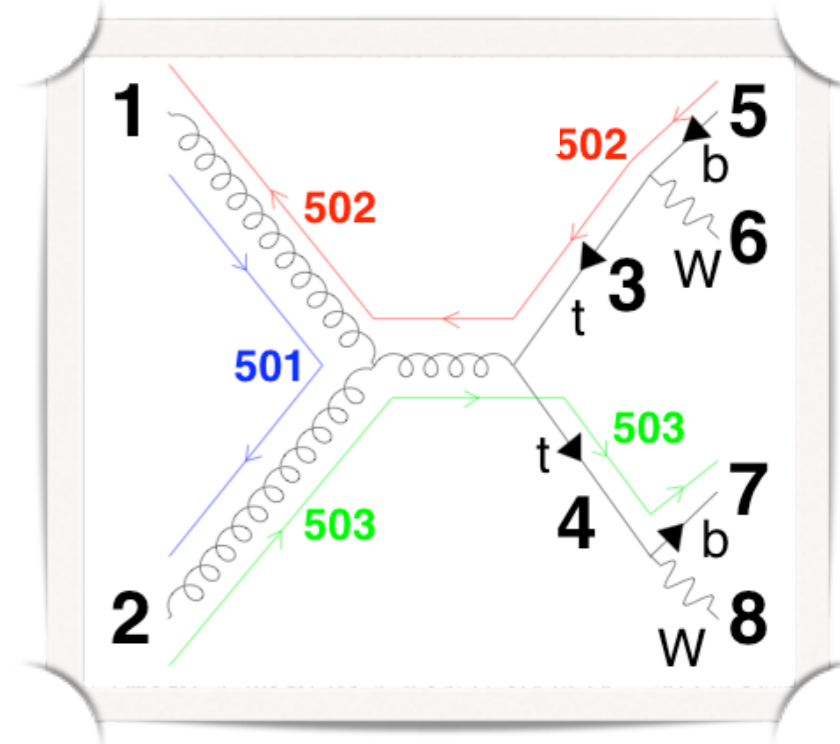
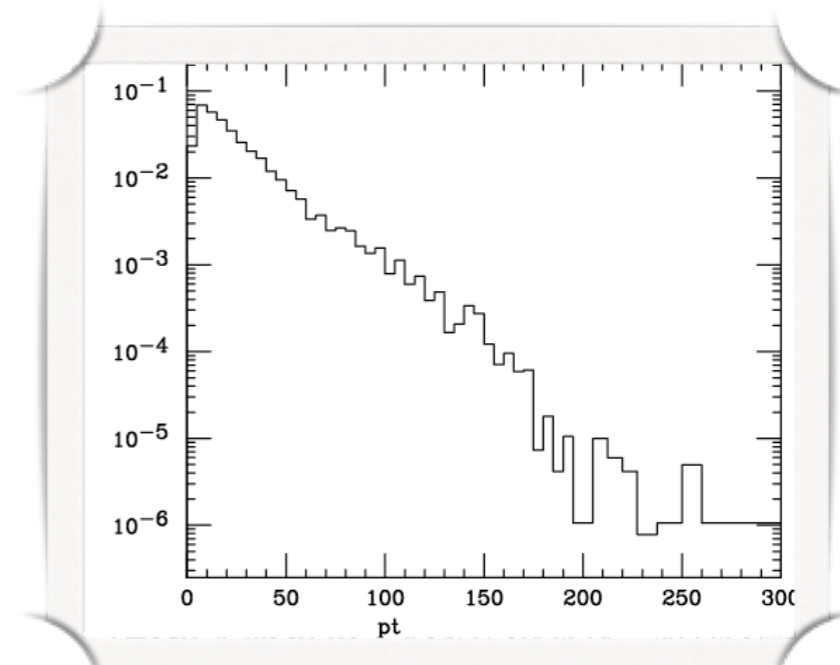



# GENERAL STRUCTURE

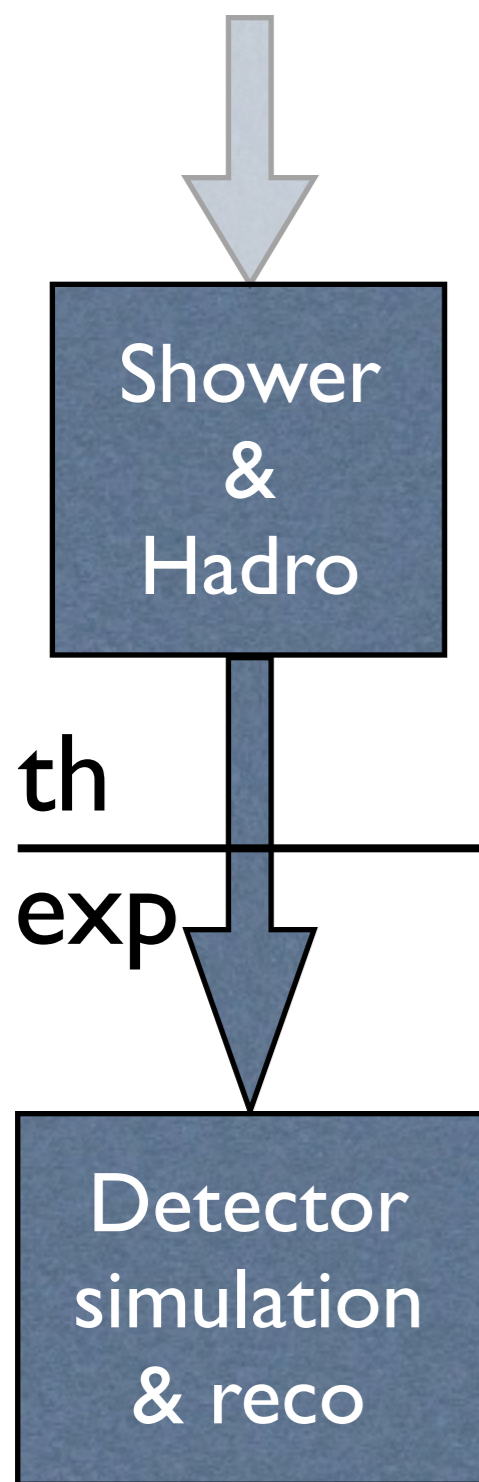

Events in the LH format are passed to the showering and hadronization  $\Rightarrow$  high multiplicity hadron-level events

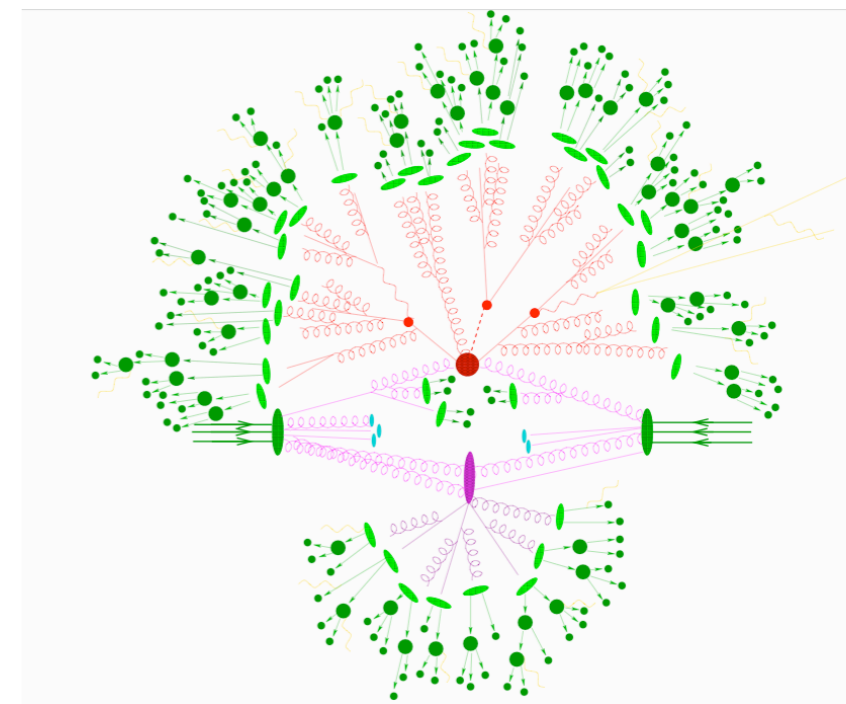

Events in HepMC format are passed through fast or full simulation, and physical objects (leptons, photons, jet, b-jets, taus) are reconstructed.

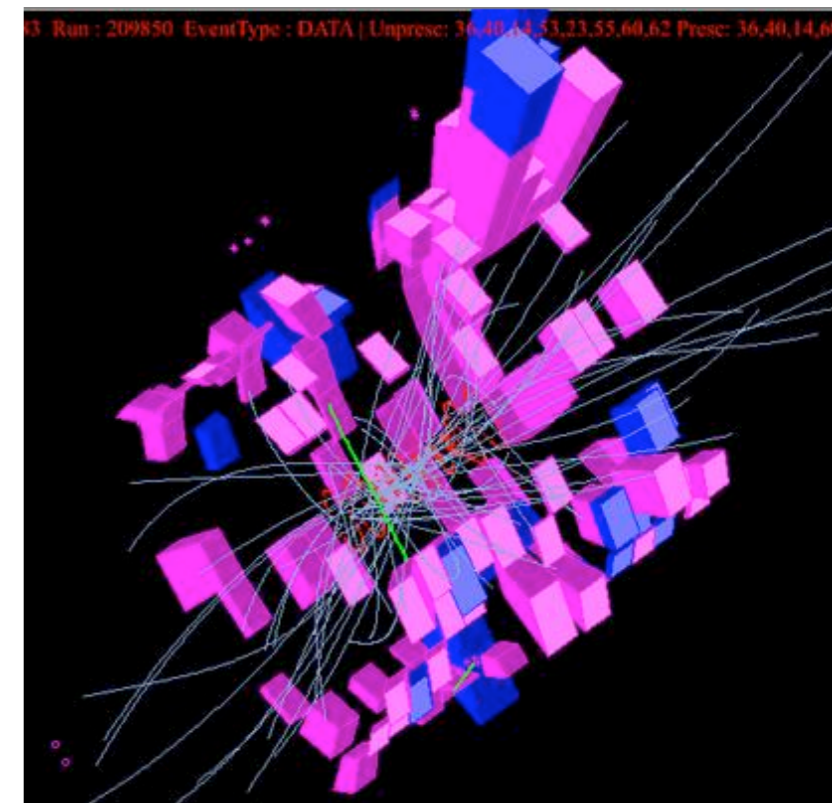

# CODES

- Example of tree-level Monte Carlo codes:
  - **AlpGen**: fast matrix elements due to use of recursion relations. SM only.
  - **Comix** (Sherpa): fast matrix elements due to use of recursion relations. Some BSM models implemented (however, e.g. no Majorana particles).
  - **MadGraph**: Feynman diagrams to generate matrix elements which results in high unweighting efficiency. Virtually all BSM models are (or can be) implemented.
- and more: CalcHEP/CompHEP, Whizard...

Skip FeynRules

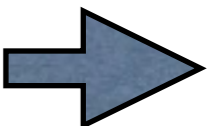

# FEYNRULES

- FeynRules is a Mathematica package that allows to derive Feynman rules from a Lagrangian.
- Current public version: 1.6.x.
- The only requirements on the Lagrangian are:
  - ➔ All indices need to be contracted (i.e. Lorentz and gauge invariance)
  - ➔ Locality
  - ➔ Supported field types:  
spin 0, 1/2, 1, 2 & ghosts (3/2 are coming)

# FEYNRULES

- FeynRules comes with a set of interfaces, that allow to export the Feynman rules to various matrix element generators.
- Interfaces coming with current public version
  - ➔ CalcHep / CompHep
  - ➔ FeynArts / FormCalc
  - ➔ MadGraph
  - ➔ Sherpa
  - ➔ Whizard / Omega
  - ➔ Universal FeynRules Output

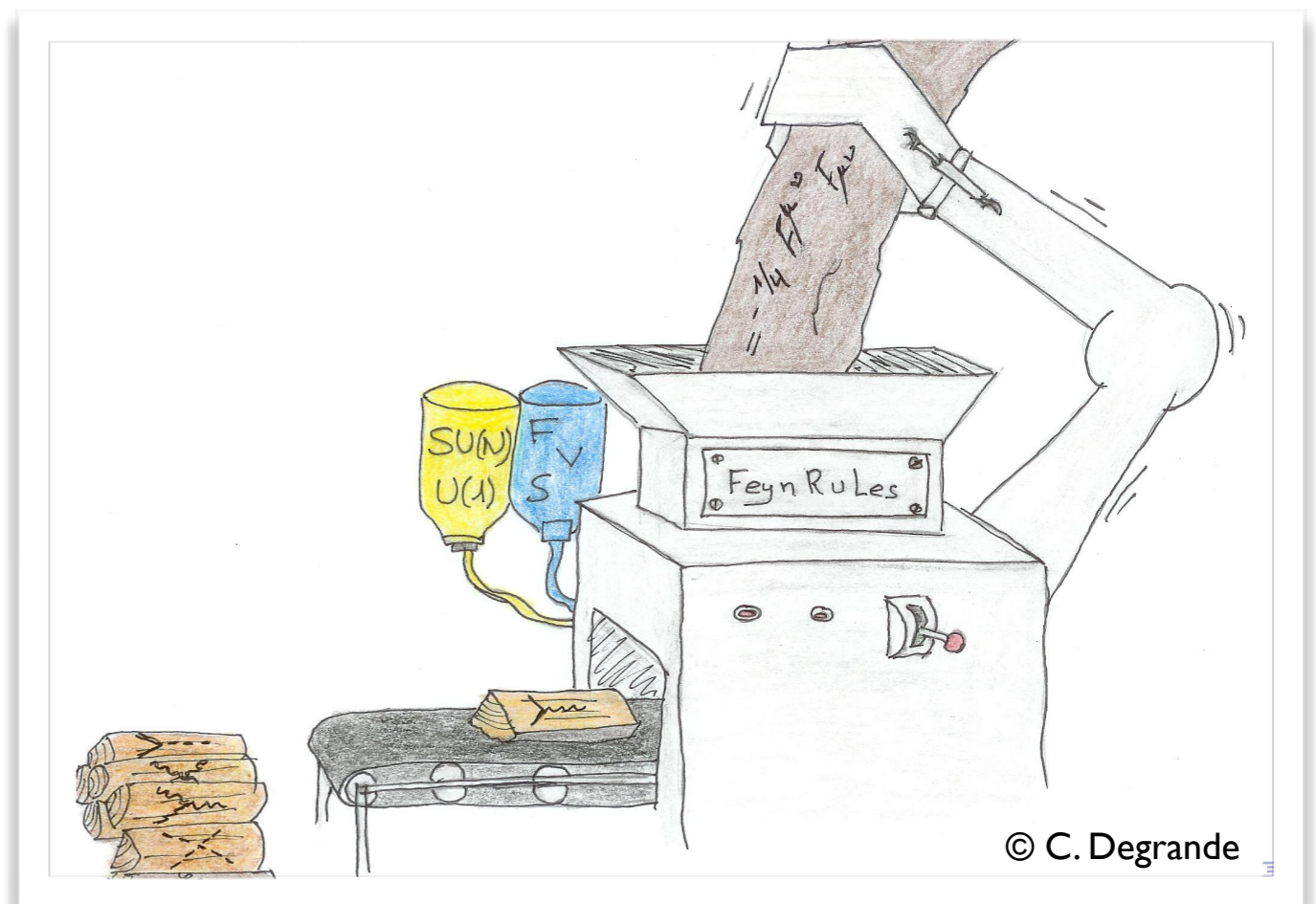

# FEYNRULES

- FeynRules comes with a set of interfaces, that allow to export the Feynman rules to various matrix element generators.
- Interfaces coming with current public version
  - ➔ CalcHep / CompHep
  - ➔ FeynArts / FormCalc
  - ➔ MadGraph
  - ➔ Sherpa
  - ➔ Whizard / Omega
  - ➔ Universal FeynRules Output





# FEYNRULES

- The input requested from the user is twofold.

- The Model File:  
Definitions of particles and parameters (e.g., a quark)

```
F[1] ==
{ClassName      -> q,
 SelfConjugate  -> False,
 Indices        -> {Index[Colour]},
 Mass           -> {MQ, 200},
 Width         -> {WQ, 5} }
```

- The Lagrangian:

$$\mathcal{L} = -\frac{1}{4} G_{\mu\nu}^a G_a^{\mu\nu} + i\bar{q} \gamma^\mu D_\mu q - M_q \bar{q} q$$

```
L =
-1/4 FS[G,mu,nu,a] FS[G,mu,nu,a]
+ I qbar.Ga[mu].del[q,mu]
- MQ qbar.q
```

# FEYNRULES

- Once this information has been provided, FeynRules can be used to compute the Feynman rules for the model:

`FeynmanRules[ L ]`

# FEYNRULES

- Once this information has been provided, FeynRules can be used to compute the Feynman rules for the model:

FeynmanRules[ L ]

Vertex 1

Particle 1 : Vector ,  $G$

Particle 2 : Dirac ,  $q^\dagger$

Particle 3 : Dirac ,  $q$

Vertex:

$$i g_s \gamma^{\mu_1} s_{2,s_3} \delta_{f_2,f_3} T^{a_1}_{i_2,i_3}$$



# FEYNRULES

- Once we have the Feynman rules, we can export them to a MC event generator via the UFO:

WriteUFOOutput[ L ]

- This produces a set of files that can be directly used in the matrix element generator (“plug ‘n’ play”).

interactions.dat

```
q q G   GG   QCD
G G G   MG VX1 QCD
G G G G  MG VX2 QCD QCD
```

particles.dat

```
q  q~  F  S  ZERO  ZERO  T  d  1
G  G   V  C  ZERO  ZERO  0  G  21
```

couplings.dat

```
GG(1) = -G
GG(1) = -G
MG VX1 = G
MG VX2 = G^2
```

# FEYNRULES

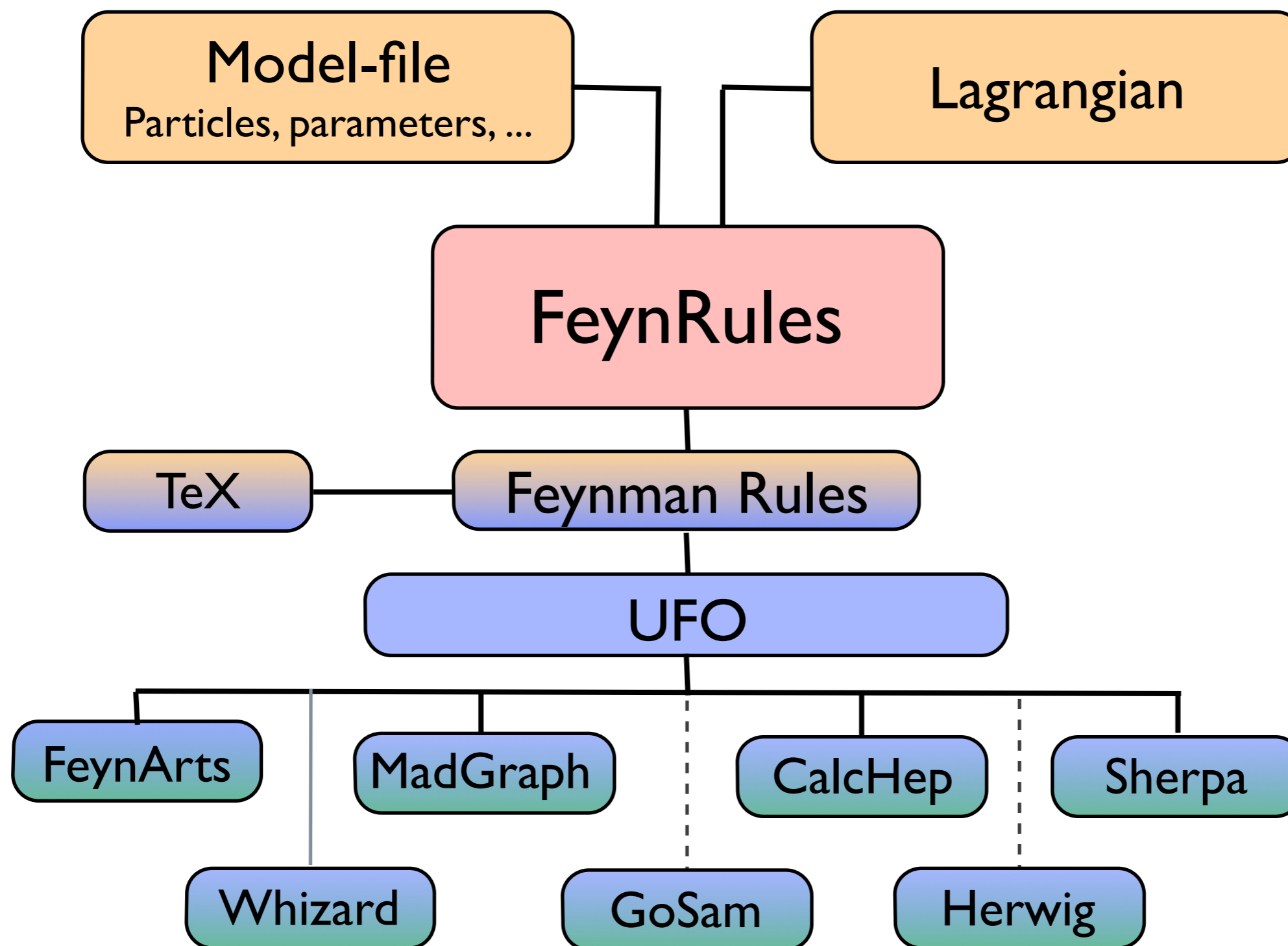

# FEYNRULES

- Already available models:
  - Standard Model
  - Simple extensions of the SM (4th generation, 2HDM, ...)
  - SUSY models ((N)MSSM, RPV-MSSM, ...)
  - Extra-dimensional models (minimal UED, Large Extra Dimensions, ...)
  - Strongly coupled and effective field theories (Minimal Walking Technicolor, Chiral Perturbation theory, ...)
- Straight-forward to start from a given model and to add extra particles/interactions
- All available models, restrictions, syntax and more information can be found on the FeynRules website:

<http://feynrules.phys.ucl.ac.be>

# SUMMARY

- Having accurate and flexible simulations tools available for the LHC is a necessity (even more now!!)
- At LO event generation is technically challenging, yet conceptually straightforward.

# PLAN

- Basics : LO predictions and event generation
- Fixed-order calculations : from NLO to NNLO
- Exclusive predictions : Parton Shower
- Merging ME+PS
- Matching NLO with PS

## LO PREDICTIONS : REMARKS

$$\sigma_X = \sum_{a,b} \int_0^1 dx_1 dx_2 f_a(x_1, \mu_F^2) f_b(x_2, \mu_F^2) \times \hat{\sigma}_{ab \rightarrow X}(x_1, x_2, \alpha_S(\mu_R^2), \frac{Q^2}{\mu_F^2}, \frac{Q^2}{\mu_R^2})$$

- By calculating the short distance coefficient at tree-level we obtain the first estimate of rates for **inclusive** final states.
- **Even at LO extra radiation is included:** it is described by the PDF's in the initial state and by the definition of a final state parton, which at LO represents all possible final state evolutions.
- Due to the above approximations a cross section at LO can strongly depend on the factorization and renormalization scales.
- Predictions can be systematically improved, at NLO and NNLO, by including higher order corrections in the short distance and in the evolution of the PDF's.

# NLO PREDICTIONS

$$\sigma_X = \sum_{a,b} \int_0^1 dx_1 dx_2 f_a(x_1, \mu_F^2) f_b(x_2, \mu_F^2) \times \hat{\sigma}_{ab \rightarrow X}(x_1, x_2, \alpha_S(\mu_R^2), \frac{Q^2}{\mu_F^2}, \frac{Q^2}{\mu_R^2})$$

$$\hat{\sigma}_{ab \rightarrow X} = \sigma_0 + \alpha_S \sigma_1 + \alpha_S^2 \sigma_2 + \dots$$

Why?

1. First order where scale dependences are compensated by the running of  $\alpha_S$  and the evolution of the PDF's: FIRST RELIABLE ESTIMATE OF THE TOTAL CROSS SECTION.

2. The impact of extra radiation is included. For example, jets now have a structure.

3. New effects coming up from higher order terms (e.g., opening up of new production channels or phase space dimensions) can be evaluated.

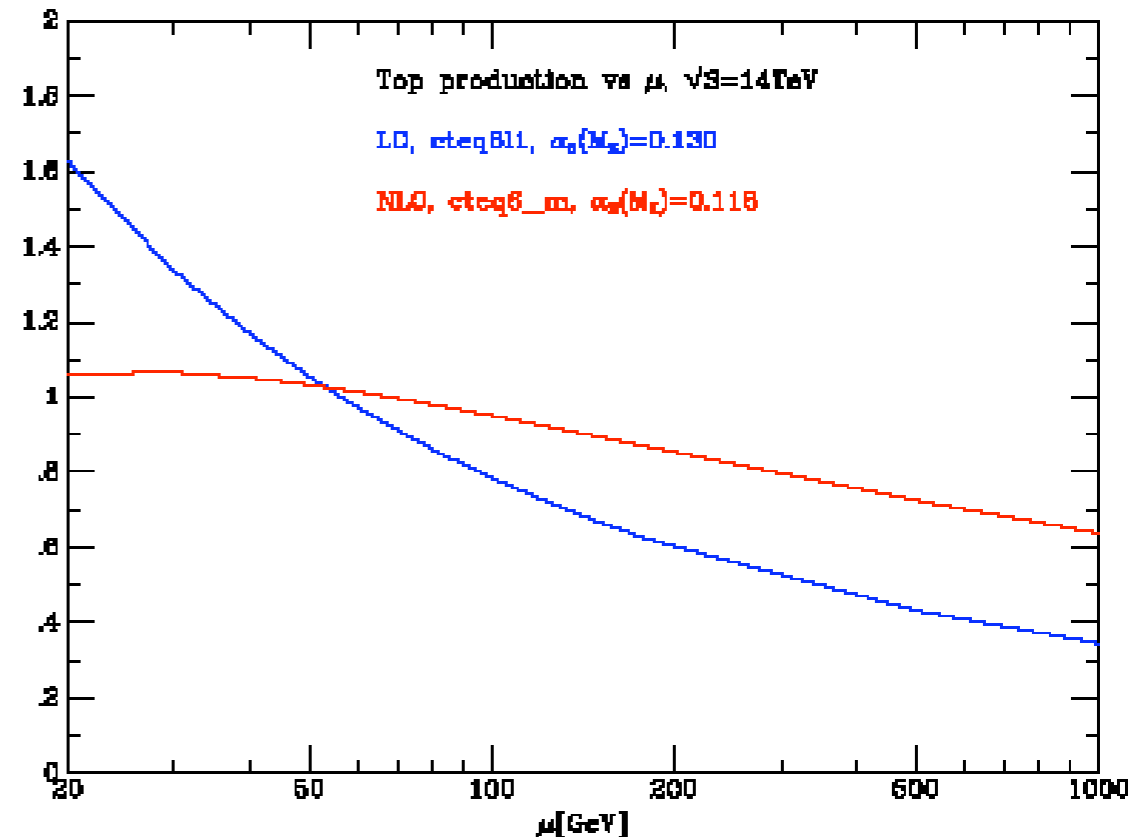

# ELEMENTS OF A NLO COMPUTATION

NLO contributions have three parts



# ELEMENTS OF A NLO COMPUTATION

NLO contributions have three parts

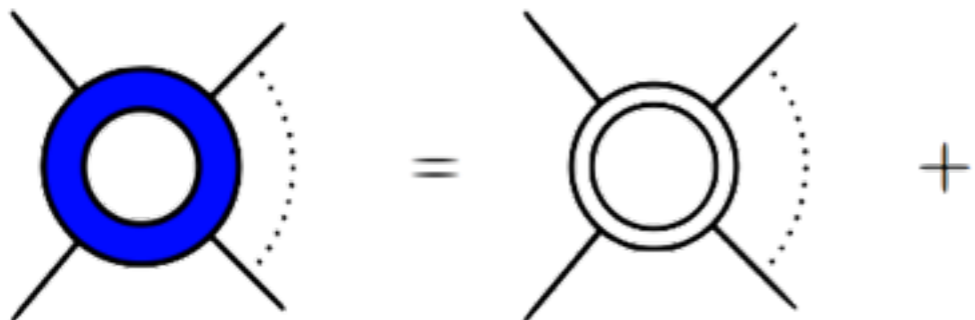

$$\sigma^{\text{NLO}} = \int_m d^{(d)} \sigma^V +$$

Virtual part

# ELEMENTS OF A NLO COMPUTATION

NLO contributions have three parts

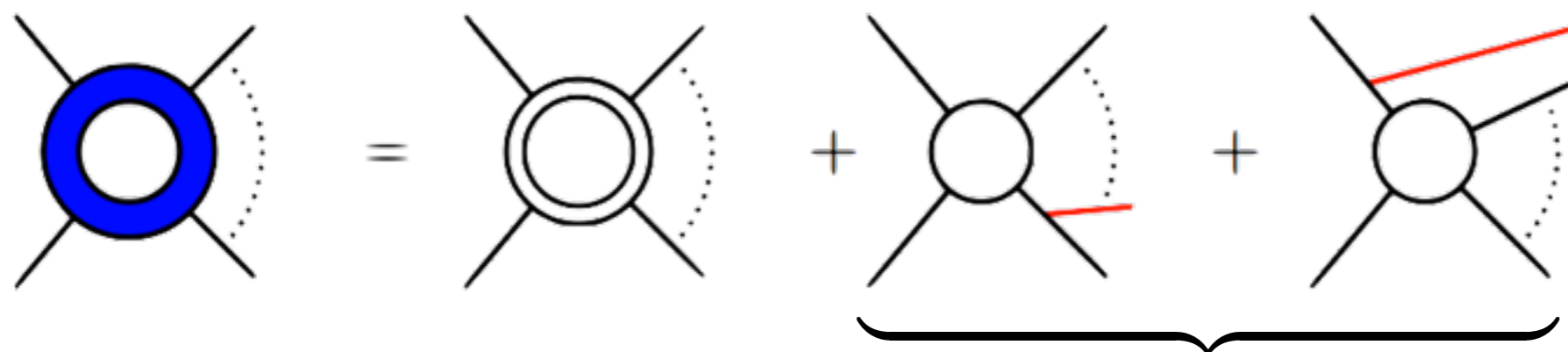

$$\sigma^{\text{NLO}} = \int_m d^{(d)} \sigma^V +$$

**Virtual part**

$$\int_{m+1} d^{(d)} \sigma^R +$$

**Real emission part**

# ELEMENTS OF A NLO COMPUTATION

NLO contributions have three parts

The diagram shows the decomposition of an NLO contribution into three parts. On the left, a thick blue circle with four external lines and a dotted arc represents the total NLO contribution. This is equal to the sum of three terms: a virtual part (a thin black circle with two internal lines), a real emission part (two diagrams with a red line representing an emitted particle), and a Born part (a thin black circle with four external lines and a dotted arc). Below the diagrams, the corresponding mathematical expressions are given.

$$\sigma^{\text{NLO}} = \int_m d^{(d)} \sigma^V + \underbrace{\int_{m+1} d^{(d)} \sigma^R}_{\text{Real emission part}} + \int_m d^{(4)} \sigma^B$$

**Virtual part**
**Real emission part**
**Born**

# ELEMENTS OF A NLO COMPUTATION

NLO contributions have three parts

$$\sigma^{\text{NLO}} = \int_m d^{(d)} \sigma^V + \underbrace{\int_{m+1} d^{(d)} \sigma^R}_{\text{Real emission part}} + \int_m d^{(4)} \sigma^B$$

**Virtual part**
**Real emission part**
**Born**

- ✦ Loops have been for long the bottleneck of NLO computations
- ✦ Virtuals and Reals are each divergent and subtraction scheme need to be used (Dipoles, FKS, Antenna's)
- ✦ A lot of work is necessary for each computation

# ELEMENTS OF A NLO COMPUTATION

NLO contributions have three parts

$$\sigma^{\text{NLO}} = \int_m d^{(d)} \sigma^V + \underbrace{\int_{m+1} d^{(d)} \sigma^R}_{\text{Real emission part}} + \int_m d^{(4)} \sigma^B$$

**Virtual part**
**Real emission part**
**Born**

- ✦ Loops have been for long the bottleneck of NLO computations
- ✦ Virtuals and Reals are each divergent and subtraction scheme need to be used (Dipoles, FKS, Antenna's)
- ✦ A lot of work is necessary for each computation

The cost of a new prediction at NLO could easily exceed 100k euro/dollar.

# PREDICTIONS AT NLO

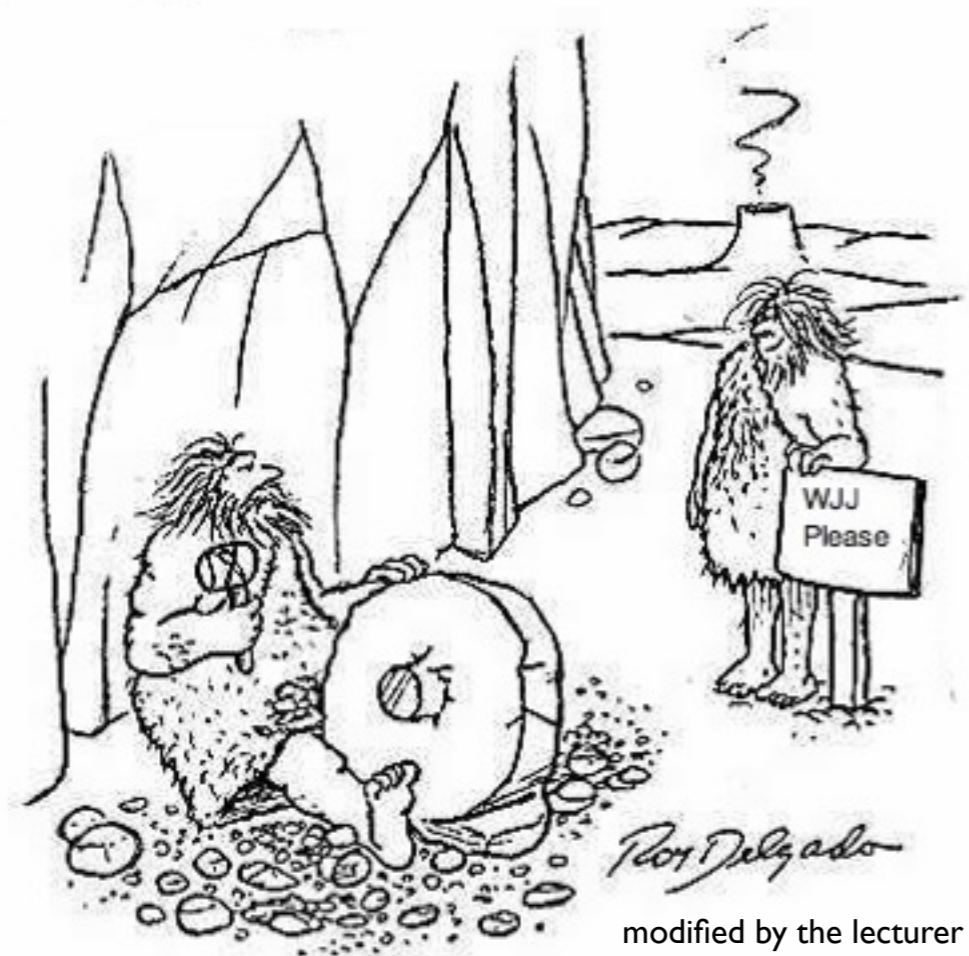



# PREDICTIONS AT NLO

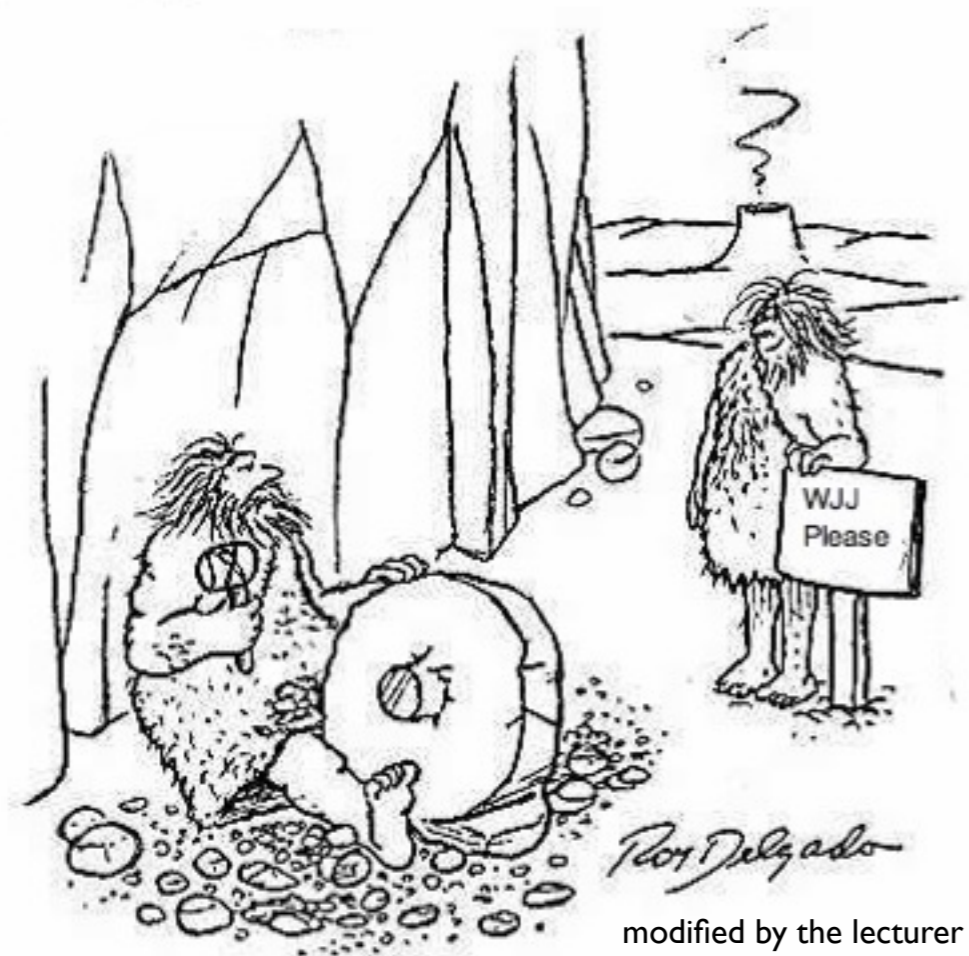

Generalized Unitarity  
(ex. BlackHat, Rocket,...)

Integrand Reduction  
(ex. CutTools, Samurai)

Tensor Reduction  
(ex. Golem)

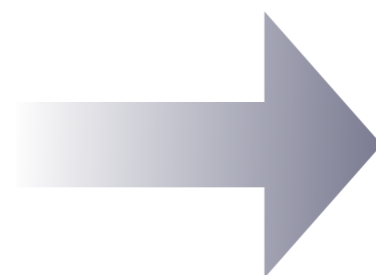

# PREDICTIONS AT NLO

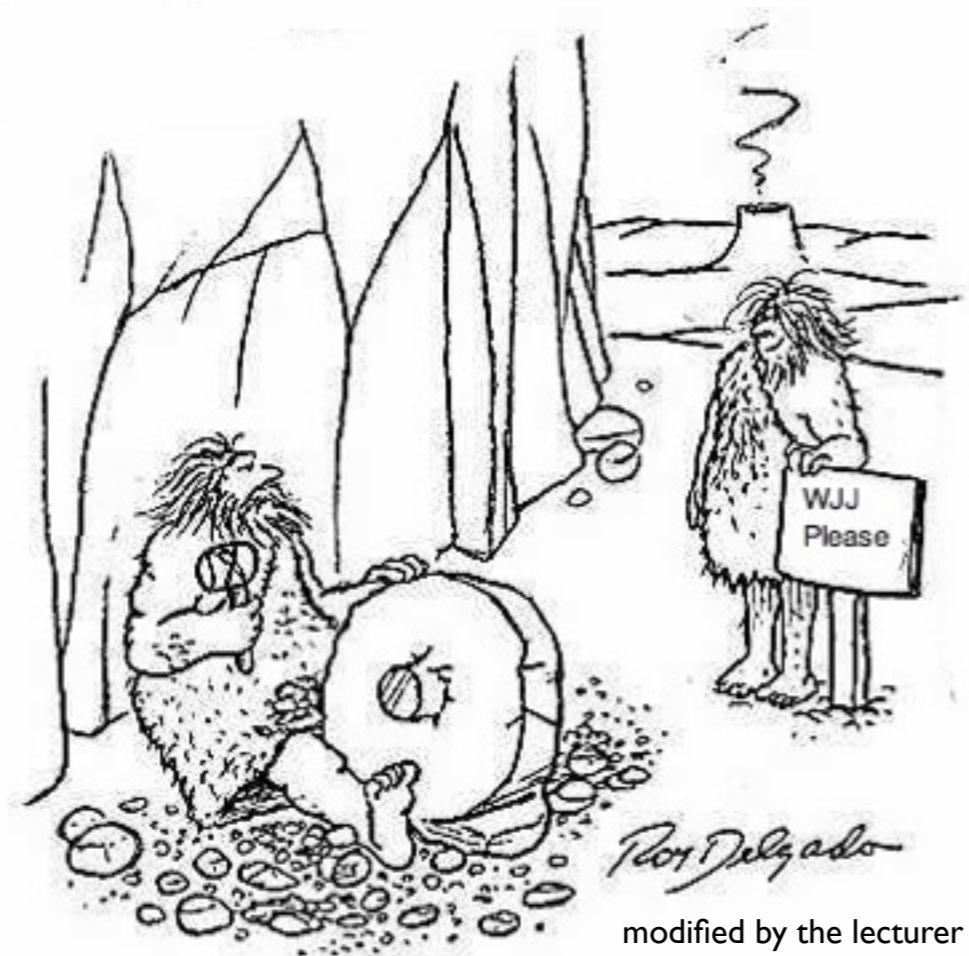

Generalized Unitarity  
(ex. BlackHat, Rocket,...)

Integrand Reduction  
(ex. CutTools, Samurai)

Tensor Reduction  
(ex. Golem)

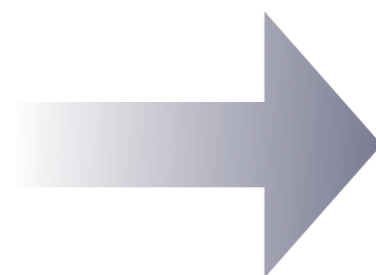

Thanks to new amazing results, some of them inspired by string theory developments, now the computation of loops has been extended to high-multiplicity processes or/and automated.



# PREDICTIONS AT NLO

Warning!

Calling a code “a NLO code” is an abuse of language and can be confusing.

A NLO calculation always refers to an IR-safe observable, when the genuine  $\alpha_s$  corrections to this observable on top of the LO estimate are known.

An NLO code will, in general, be able to produce results for several quantities and distributions, only some of which will be at NLO accuracy.

Example: Suppose we use the NLO code for  $pp \rightarrow t\bar{t}$

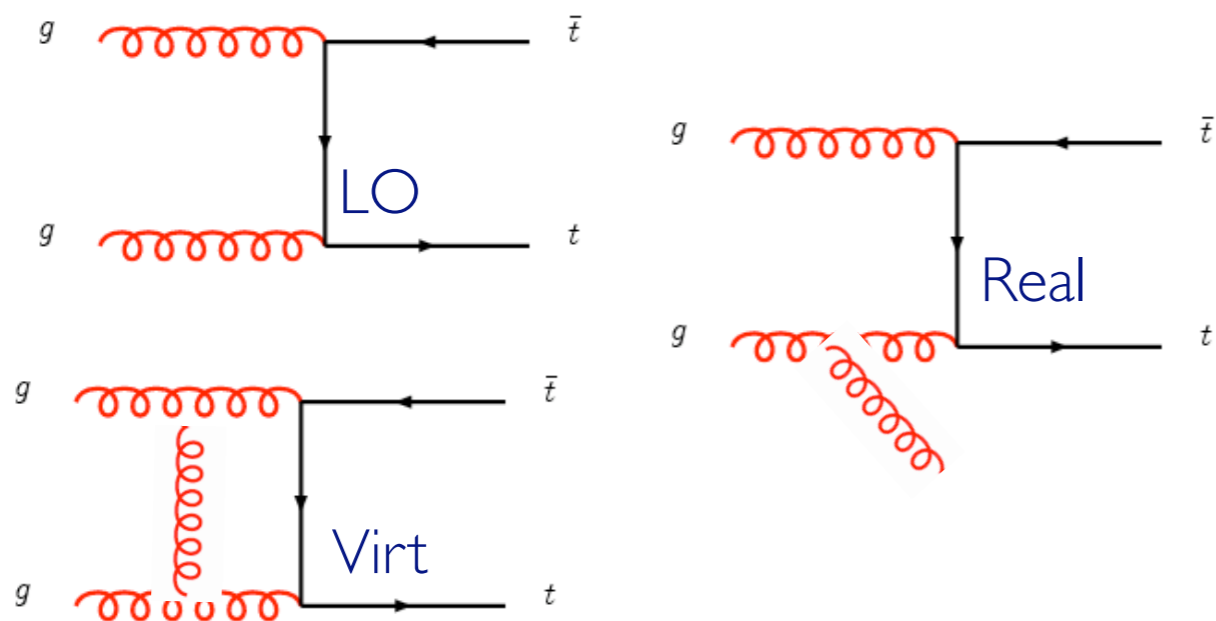

# PREDICTIONS AT NLO

Warning!

Calling a code “a NLO code” is an abuse of language and can be confusing.

A NLO calculation always refers to an IR-safe observable, when the genuine  $\alpha_s$  corrections to this observable on top of the LO estimate are known.

An NLO code will, in general, be able to produce results for several quantities and distributions, only some of which will be at NLO accuracy.

Example: Suppose we use the NLO code for  $pp \rightarrow tt$

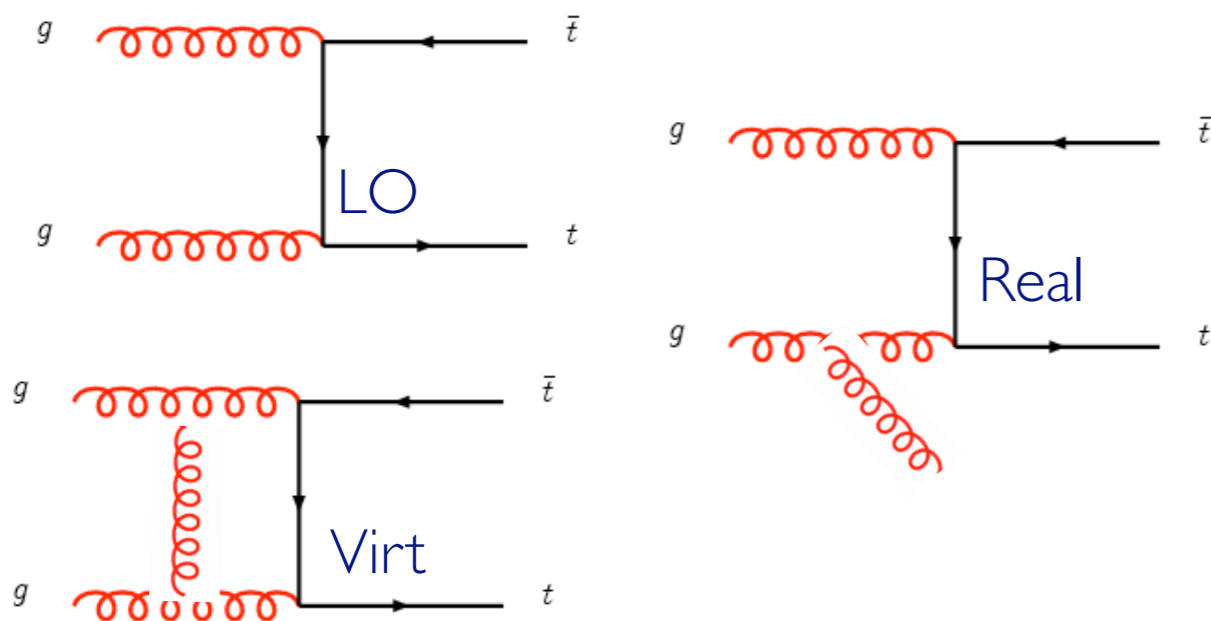

- ☞ Total cross section,  $\sigma(tt)$
- ☞  $P_T > 0$  of one top quark
- ☞  $P_T > 0$  of the  $tt$  pair
- ☞  $P_T > 0$  of the jet
- ☞  $tt$  invariant mass,  $m(tt)$
- ☞  $\Delta\Phi(tt) > 0$

# PREDICTIONS AT NLO

Warning!

Calling a code “a NLO code” is an abuse of language and can be confusing.

A NLO calculation always refers to an IR-safe observable, when the genuine  $\alpha_s$  corrections to this observable on top of the LO estimate are known.

An NLO code will, in general, be able to produce results for several quantities and distributions, only some of which will be at NLO accuracy.

Example: Suppose we use the NLO code for  $pp \rightarrow tt$

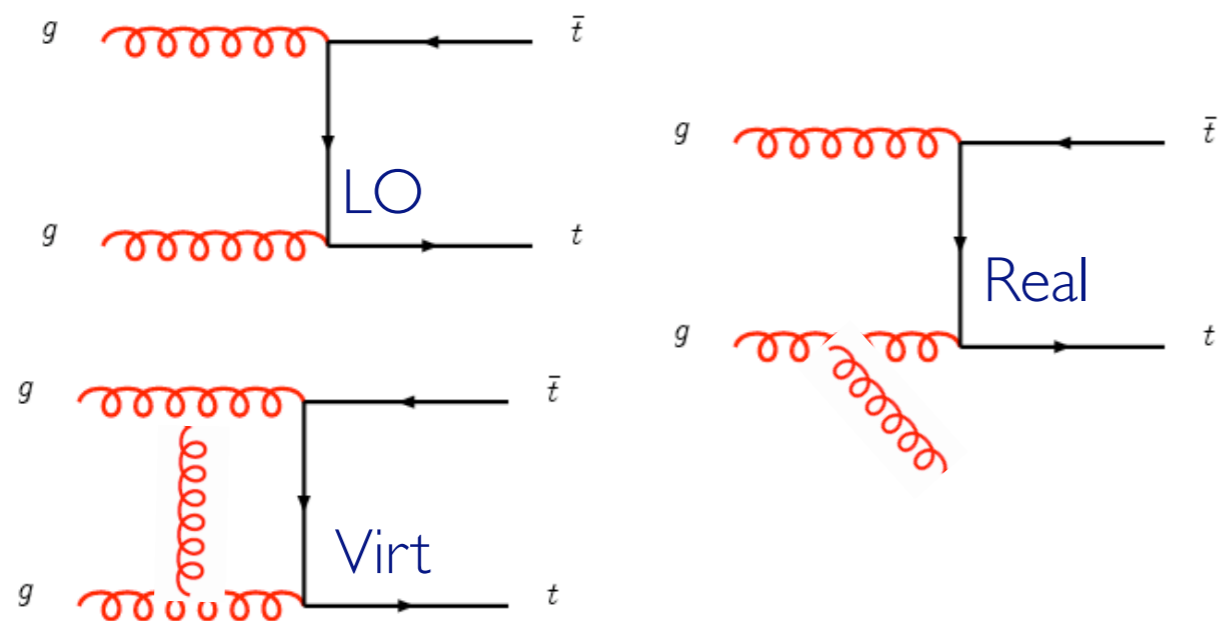

- ☞ Total cross section,  $\sigma(tt)$  ..... ✓
- ☞  $P_T > 0$  of one top quark
- ☞  $P_T > 0$  of the  $tt$  pair
- ☞  $P_T > 0$  of the jet
- ☞  $tt$  invariant mass,  $m(tt)$
- ☞  $\Delta\Phi(tt) > 0$

# PREDICTIONS AT NLO

Warning!

Calling a code “a NLO code” is an abuse of language and can be confusing.

A NLO calculation always refers to an IR-safe observable, when the genuine  $\alpha_s$  corrections to this observable on top of the LO estimate are known.

An NLO code will, in general, be able to produce results for several quantities and distributions, only some of which will be at NLO accuracy.

Example: Suppose we use the NLO code for  $pp \rightarrow tt$

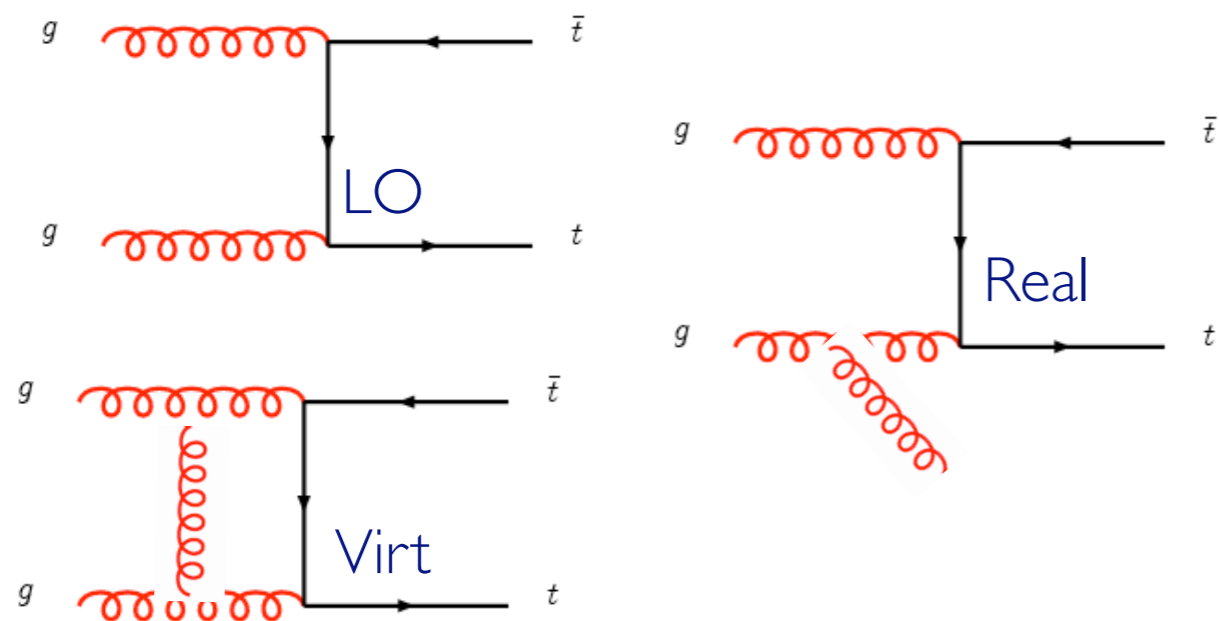

- ☞ Total cross section,  $\sigma(tt)$  ..... ✓
- ☞  $P_T > 0$  of one top quark..... ✓
- ☞  $P_T > 0$  of the  $tt$  pair
- ☞  $P_T > 0$  of the jet
- ☞  $tt$  invariant mass,  $m(tt)$
- ☞  $\Delta\Phi(tt) > 0$

# PREDICTIONS AT NLO

Warning!

Calling a code “a NLO code” is an abuse of language and can be confusing.

A NLO calculation always refers to an IR-safe observable, when the genuine  $\alpha_s$  corrections to this observable on top of the LO estimate are known.

An NLO code will, in general, be able to produce results for several quantities and distributions, only some of which will be at NLO accuracy.

Example: Suppose we use the NLO code for  $pp \rightarrow tt$

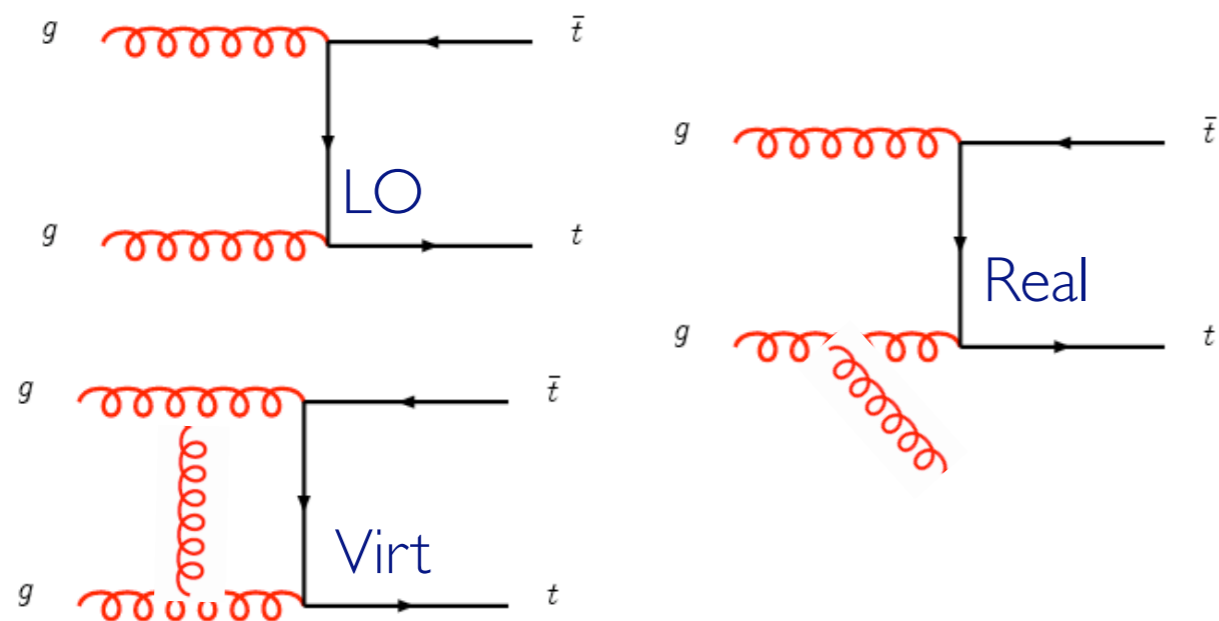

- ☞ Total cross section,  $\sigma(tt)$  ..... ✓
- ☞  $P_T > 0$  of one top quark..... ✓
- ☞  $P_T > 0$  of the  $tt$  pair ..... ✗
- ☞  $P_T > 0$  of the jet
- ☞  $tt$  invariant mass,  $m(tt)$
- ☞  $\Delta\Phi(tt) > 0$

# PREDICTIONS AT NLO

Warning!

Calling a code “a NLO code” is an abuse of language and can be confusing.

A NLO calculation always refers to an IR-safe observable, when the genuine  $\alpha_s$  corrections to this observable on top of the LO estimate are known.

An NLO code will, in general, be able to produce results for several quantities and distributions, only some of which will be at NLO accuracy.

Example: Suppose we use the NLO code for  $pp \rightarrow tt$

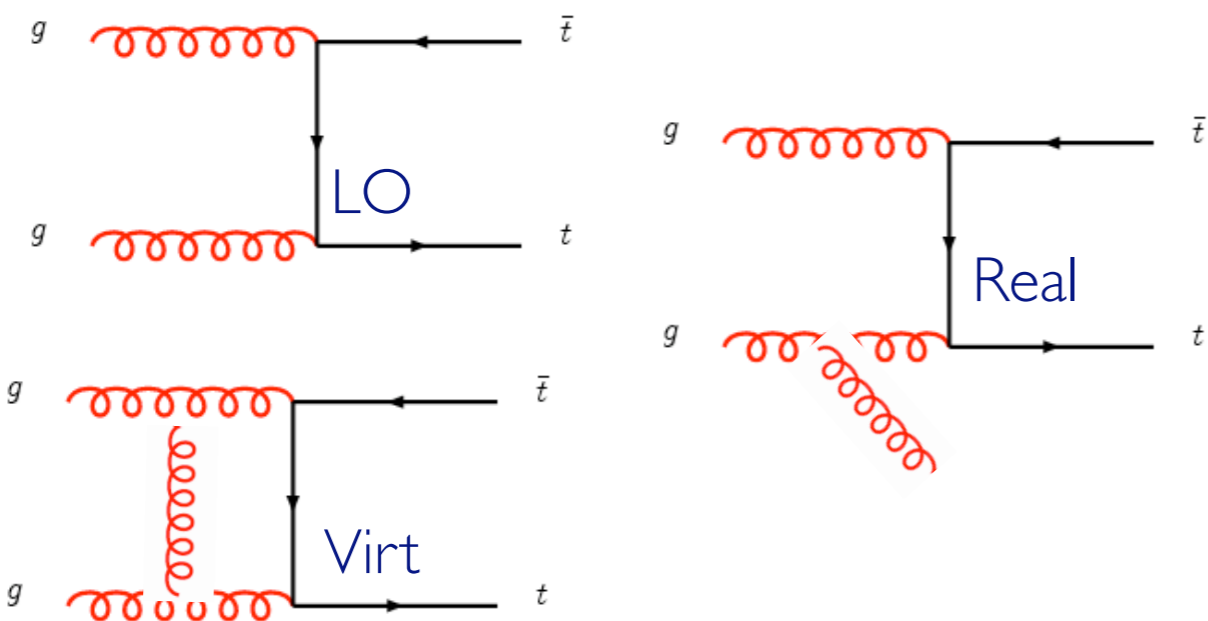

- ☞ Total cross section,  $\sigma(tt)$  ..... ✓
- ☞  $P_T > 0$  of one top quark..... ✓
- ☞  $P_T > 0$  of the  $tt$  pair ..... ✗
- ☞  $P_T > 0$  of the jet..... ✗
- ☞  $tt$  invariant mass,  $m(tt)$
- ☞  $\Delta\Phi(tt) > 0$

# PREDICTIONS AT NLO

Warning!

Calling a code “a NLO code” is an abuse of language and can be confusing.

A NLO calculation always refers to an IR-safe observable, when the genuine  $\alpha_s$  corrections to this observable on top of the LO estimate are known.

An NLO code will, in general, be able to produce results for several quantities and distributions, only some of which will be at NLO accuracy.

Example: Suppose we use the NLO code for  $pp \rightarrow tt$

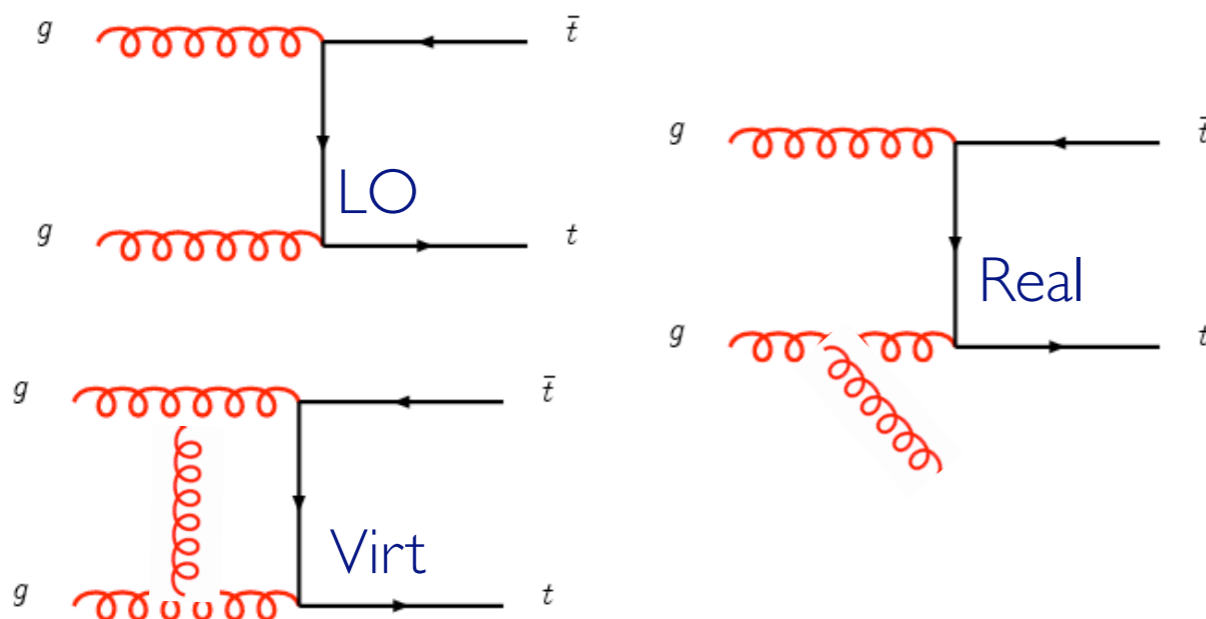

- ☞ Total cross section,  $\sigma(tt)$  ..... ✓
- ☞  $P_T > 0$  of one top quark..... ✓
- ☞  $P_T > 0$  of the  $tt$  pair ..... ✗
- ☞  $P_T > 0$  of the jet..... ✗
- ☞  $tt$  invariant mass,  $m(tt)$  ..... ✓
- ☞  $\Delta\Phi(tt) > 0$

# PREDICTIONS AT NLO

Warning!

Calling a code “a NLO code” is an abuse of language and can be confusing.

A NLO calculation always refers to an IR-safe observable, when the genuine  $\alpha_s$  corrections to this observable on top of the LO estimate are known.

An NLO code will, in general, be able to produce results for several quantities and distributions, only some of which will be at NLO accuracy.

Example: Suppose we use the NLO code for  $pp \rightarrow tt$

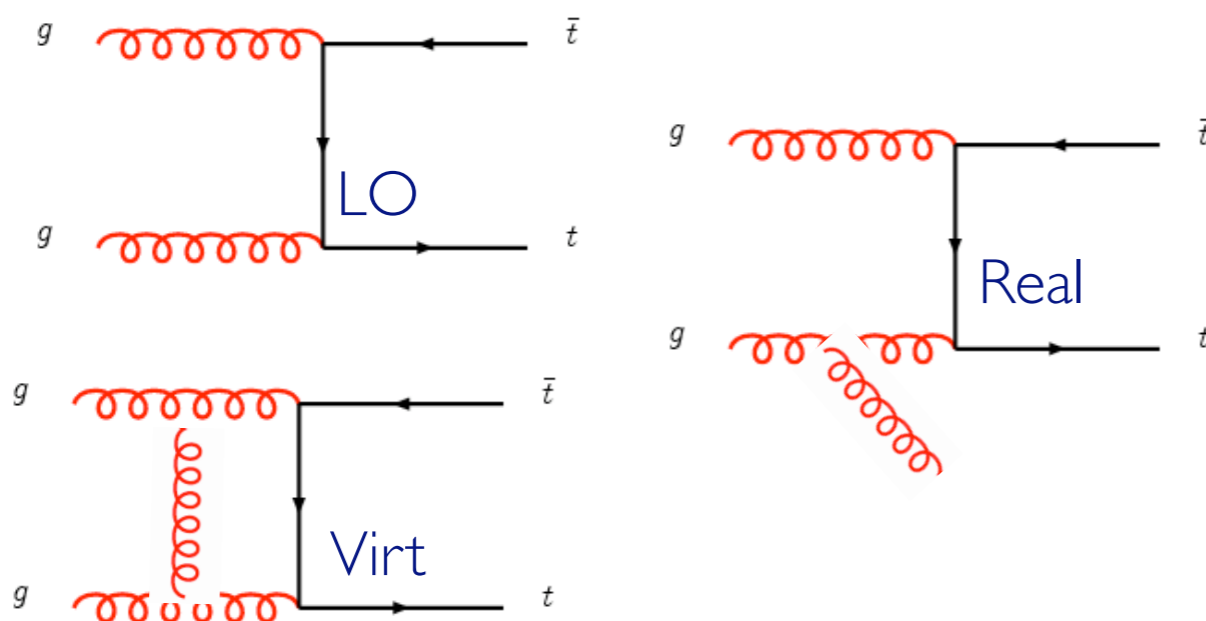

- ☞ Total cross section,  $\sigma(tt)$  ..... ✓
- ☞  $P_T > 0$  of one top quark..... ✓
- ☞  $P_T > 0$  of the  $tt$  pair ..... ✗
- ☞  $P_T > 0$  of the jet..... ✗
- ☞  $tt$  invariant mass,  $m(tt)$  ..... ✓
- ☞  $\Delta\Phi(tt) > 0$  ..... ✗



# LIMITS OF FIXED-ORDER PREDICTIONS

- There are lots of observables that are perfectly well-behaved in this perturbative approach, i.e. that show a good convergence behavior. In particular, sufficiently inclusive observables over well-separated objects are well described.
- But more exclusive observables will, in general, be poorly described in perturbation theory



# MONTE CARLO'S FOR THE LHC

**FABIO MALTONI**

CENTRE FOR COSMOLOGY, PARTICLE PHYSICS AND PHENOMENOLOGY (CP3), BELGIUM

LECTURE II

# LIMITS OF FIXED-ORDER PREDICTIONS

- Consider Drell-Yan production:  
 $pp \rightarrow \gamma^*/Z \rightarrow e^+e^- + X$
- What happens if we plot the transverse momentum of the vector boson?
- Both the LO and the NLO distributions are non-physical
- Low-transverse momentum regions is very sensitive to emissions

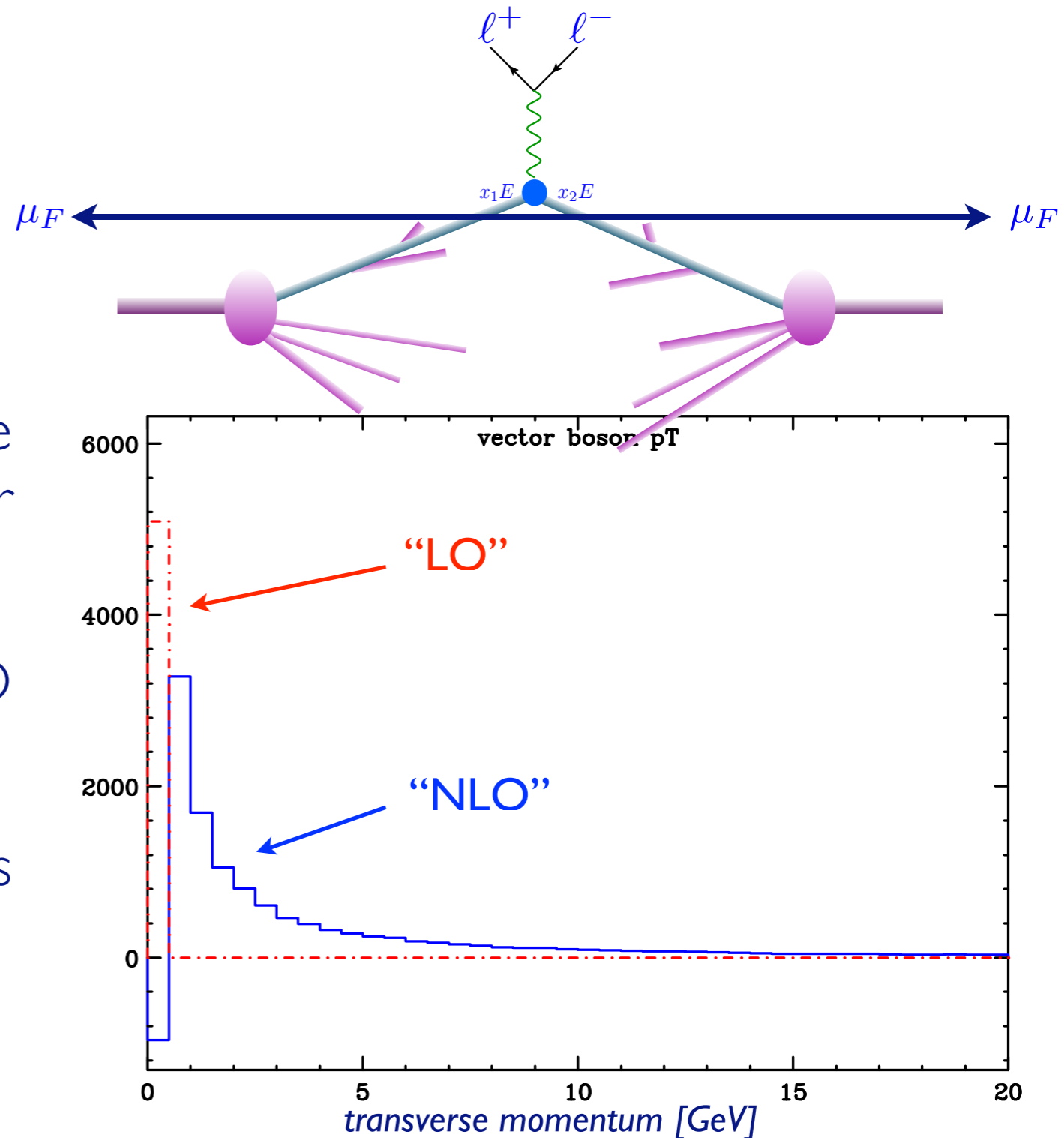

# LIMITS OF FIXED-ORDER PREDICTIONS

# LIMITS OF FIXED-ORDER PREDICTIONS

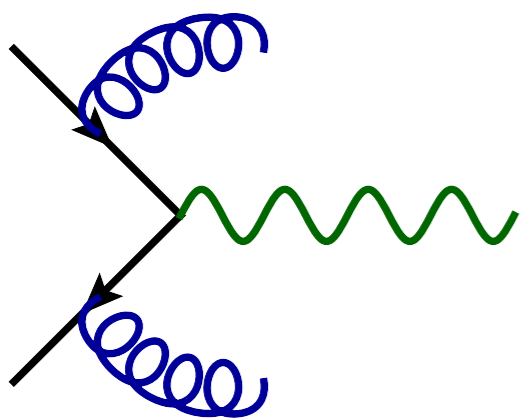

# LIMITS OF FIXED-ORDER PREDICTIONS

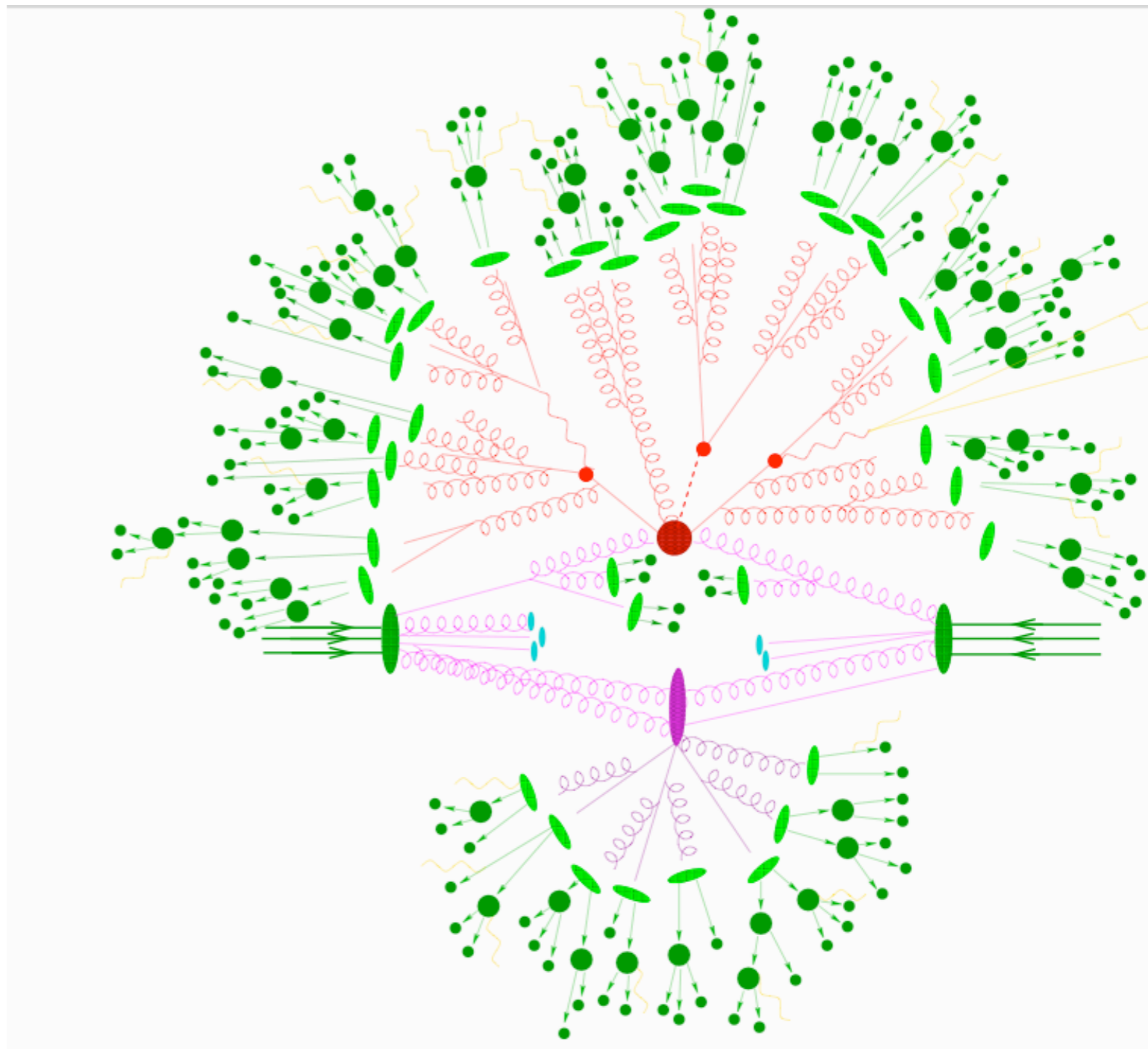
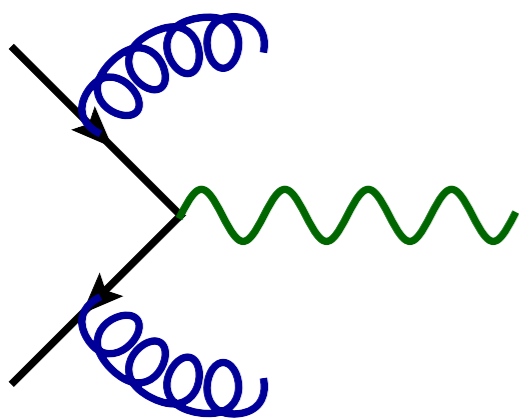

# LIMITS OF FIXED-ORDER PREDICTIONS

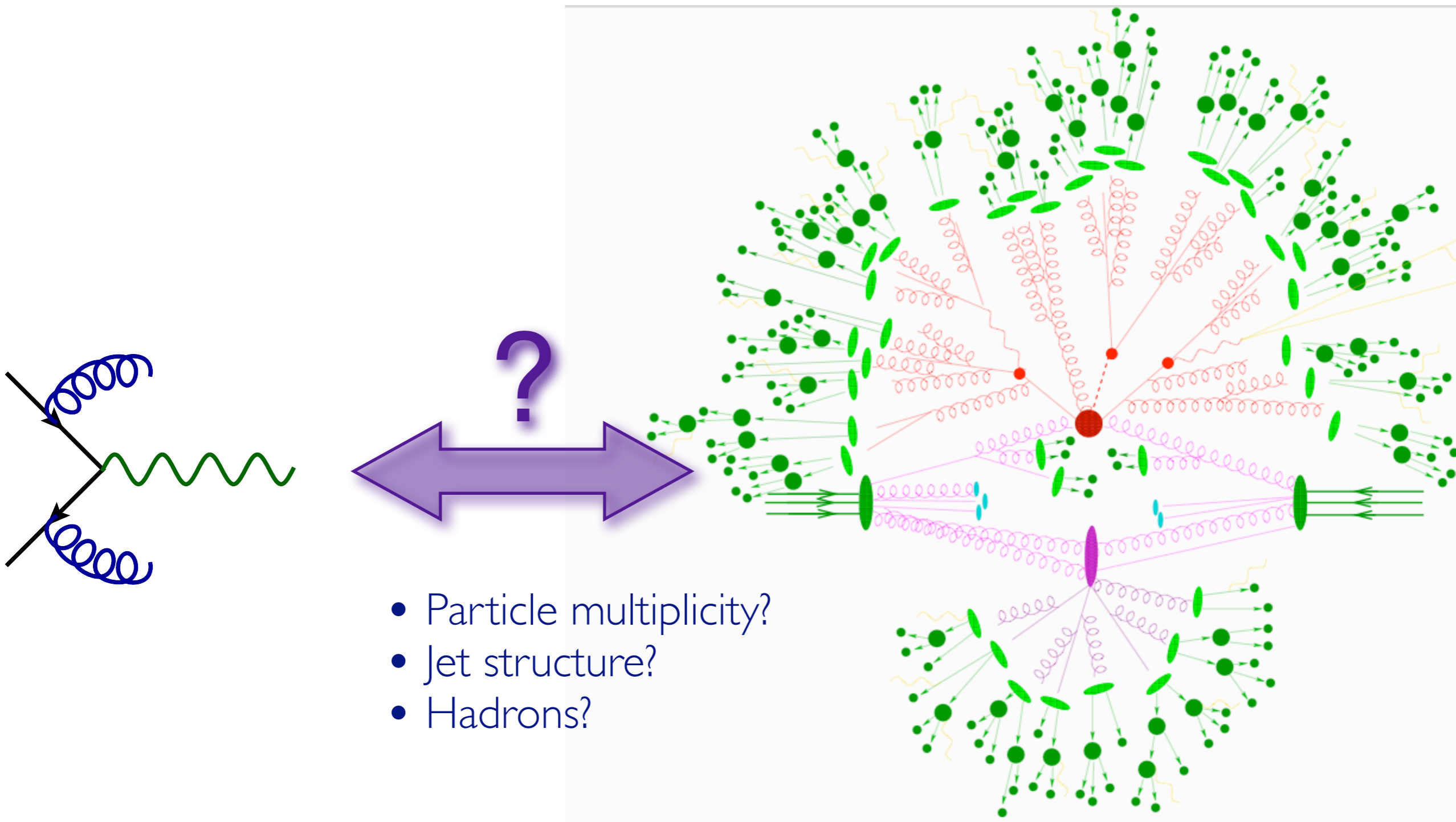

# LIMITS OF FIXED-ORDER PREDICTIONS

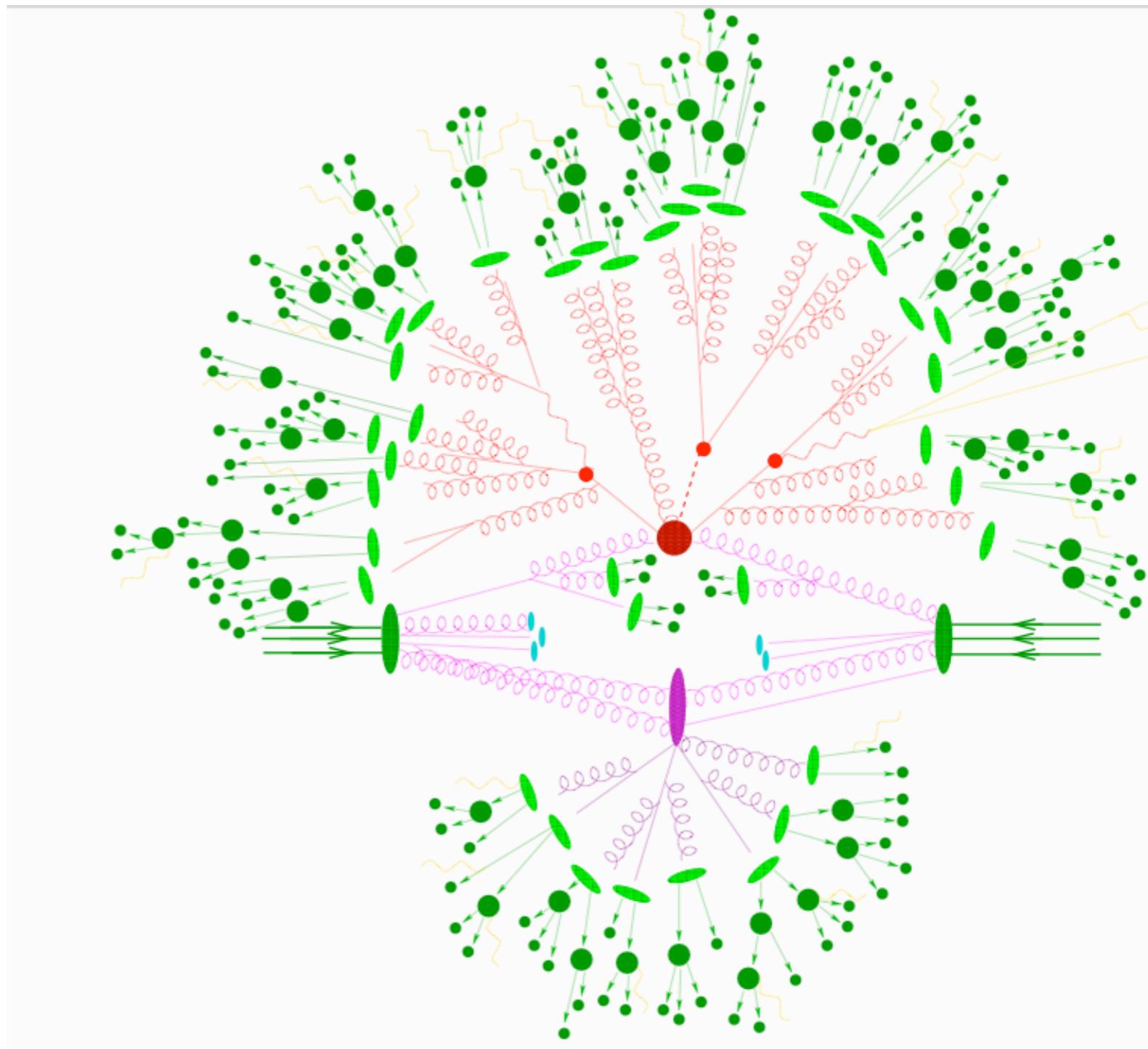
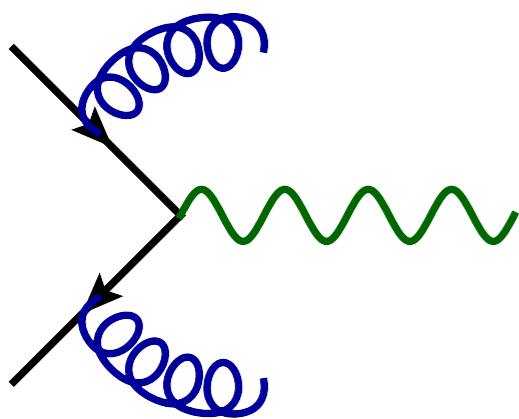



# LIMITS OF FIXED-ORDER PREDICTIONS

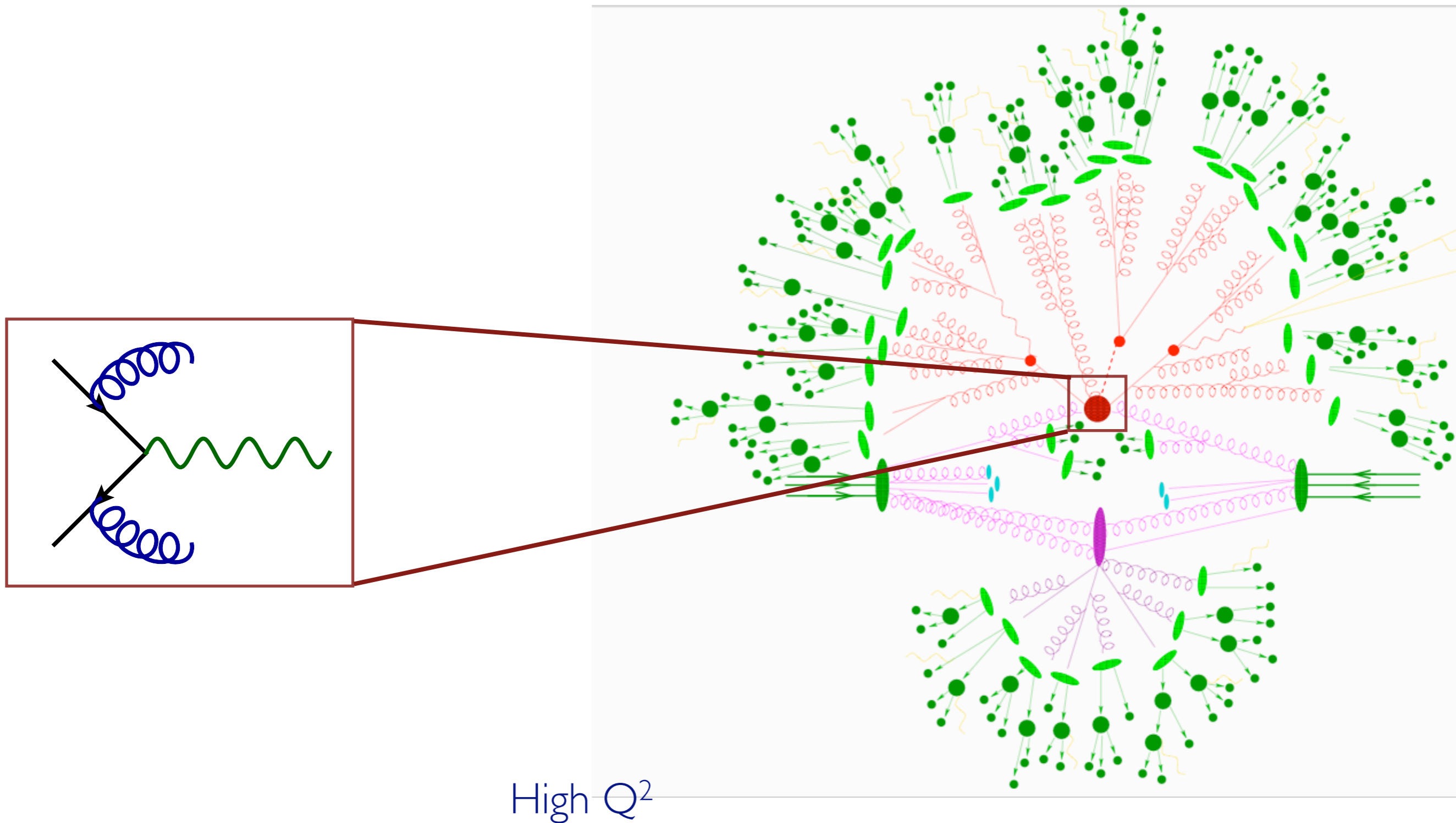

# LIMITS OF FIXED-ORDER PREDICTIONS

- Parton level calculations (NLO and NNLO) can be done only for a handful of partons.
- In an (N)NLO calculation, only a limited set of observables is at (N)NLO accuracy.
- In fixed-order calculations many observables (such as jets) have a hypersimplified structure (certainly not realistic).
- In fixed-order calculations many observables (such as those dominated by soft and collinear effects) are not reliable.
- (N)NLO calculations contain local infinities that cancel in IR-safe observables yet make unweighting impossible  $\Rightarrow$  no event generation!

1. High- $Q^2$  Scattering

2. Parton Shower

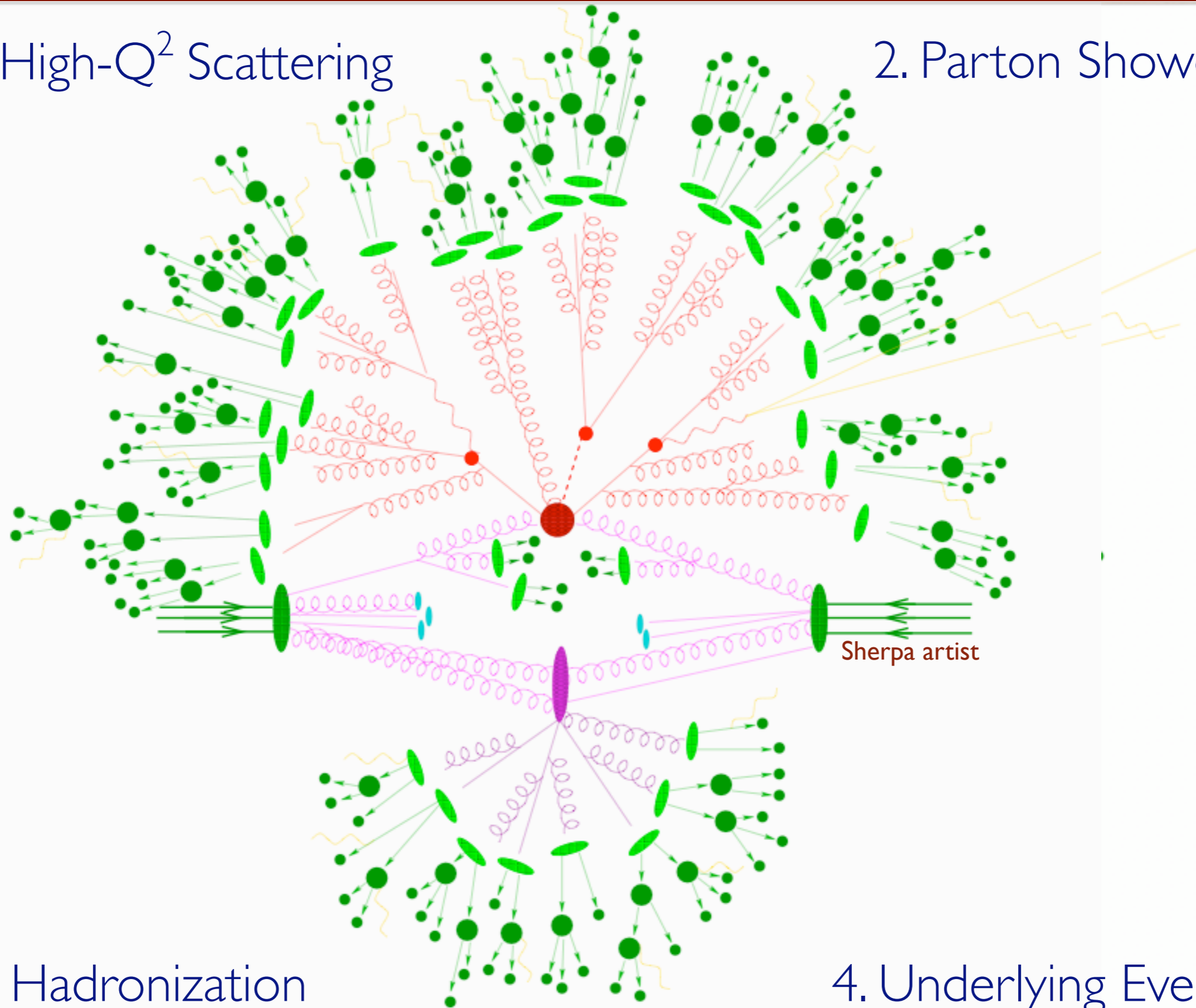

3. Hadronization

4. Underlying Event

# 1. High- $Q^2$ Scattering

# 2. Parton Shower

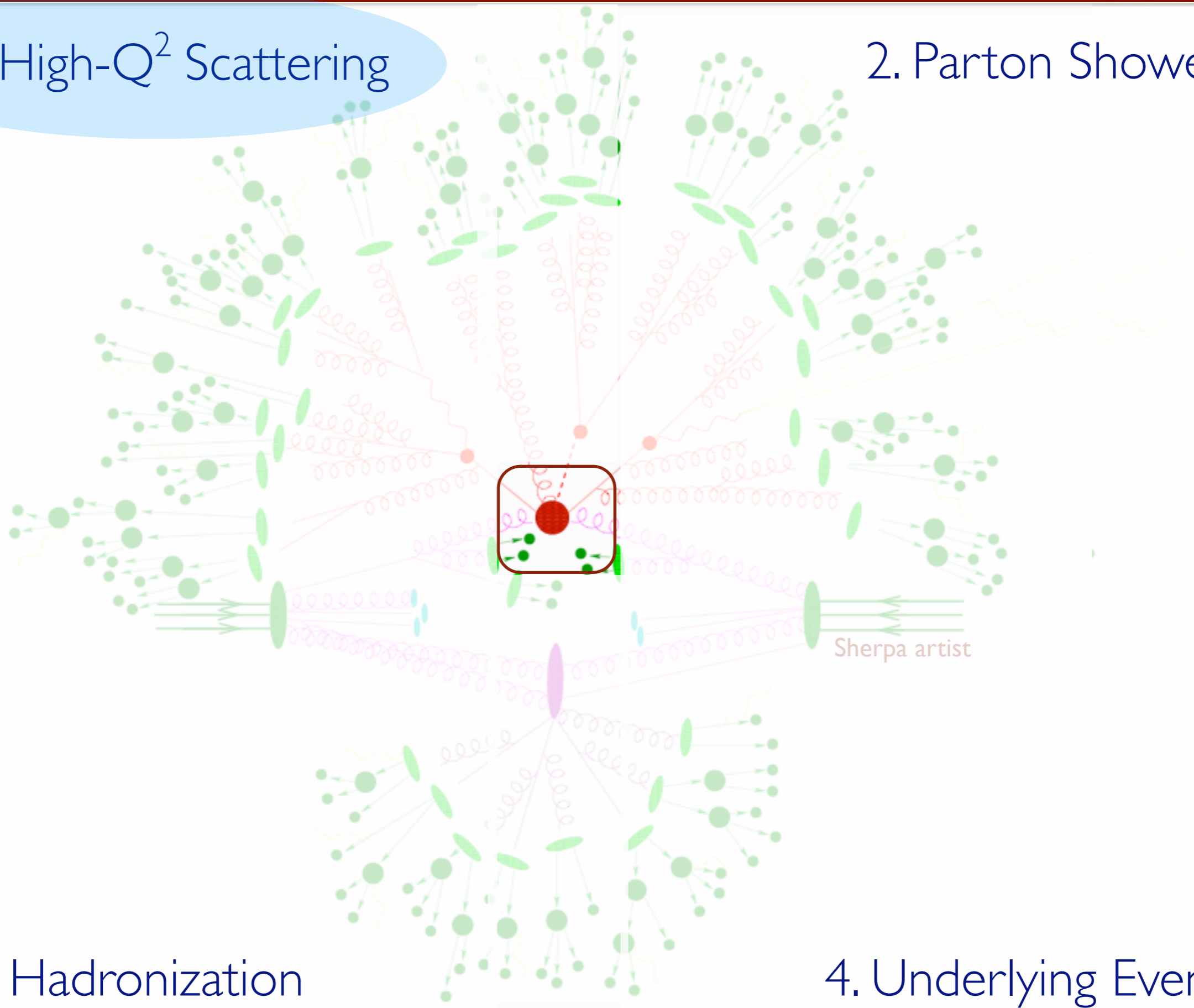

# 3. Hadronization

# 4. Underlying Event

# 1. High- $Q^2$ Scattering

# 2. Parton Shower

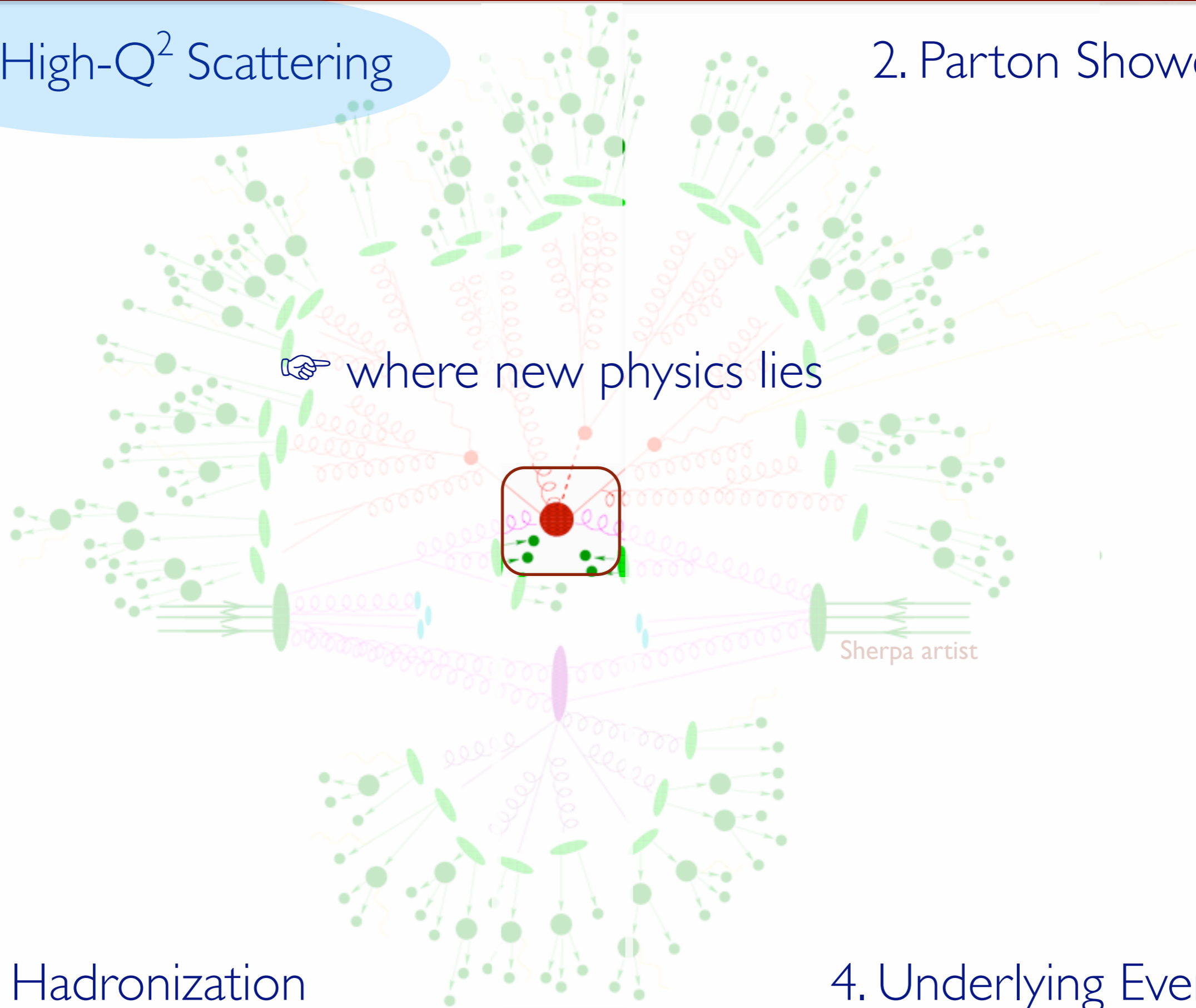

# 3. Hadronization

# 4. Underlying Event



# 1. High- $Q^2$ Scattering

# 2. Parton Shower

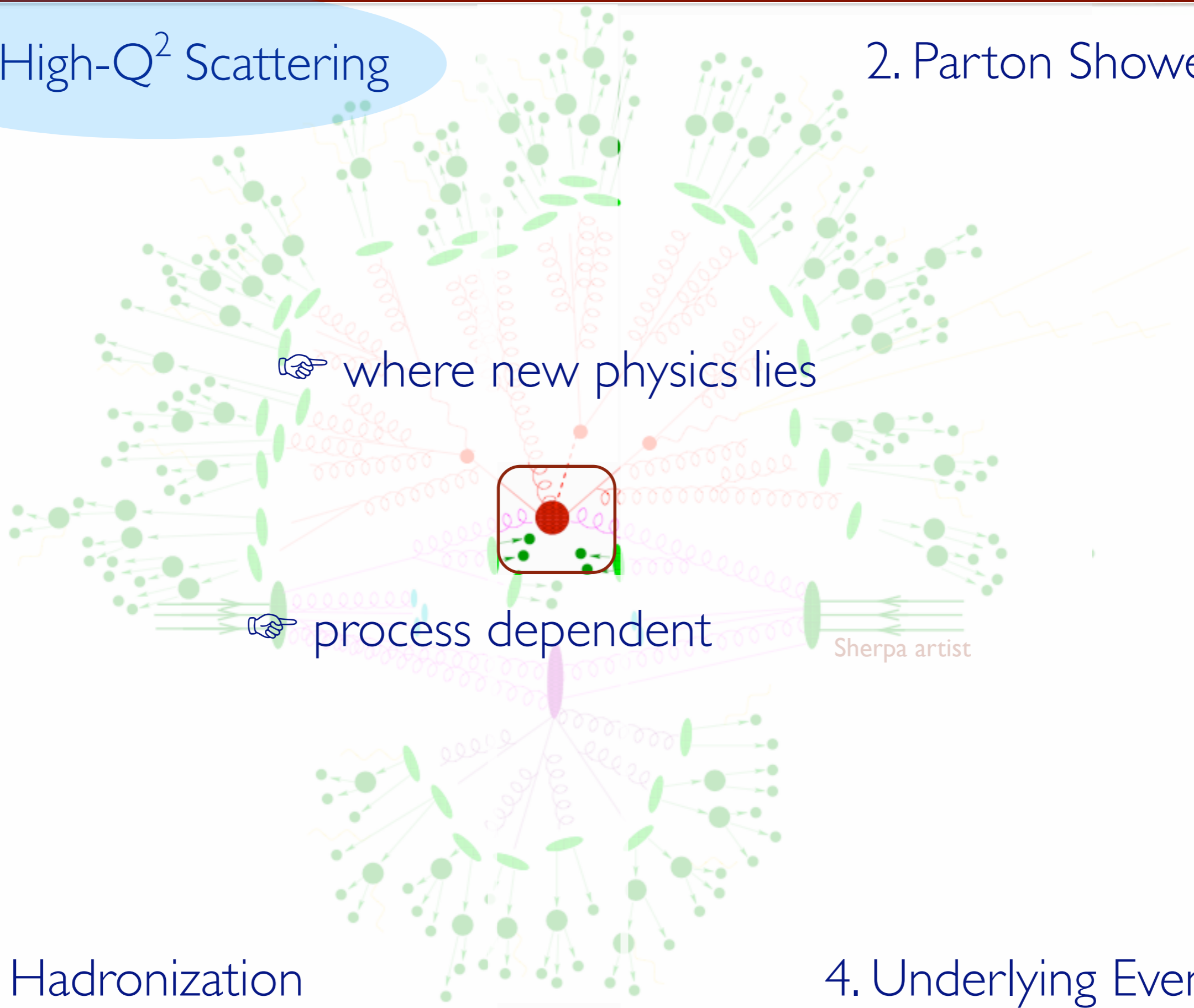

where new physics lies

process dependent

Sherpa artist

# 3. Hadronization

# 4. Underlying Event

# 1. High- $Q^2$ Scattering

# 2. Parton Shower

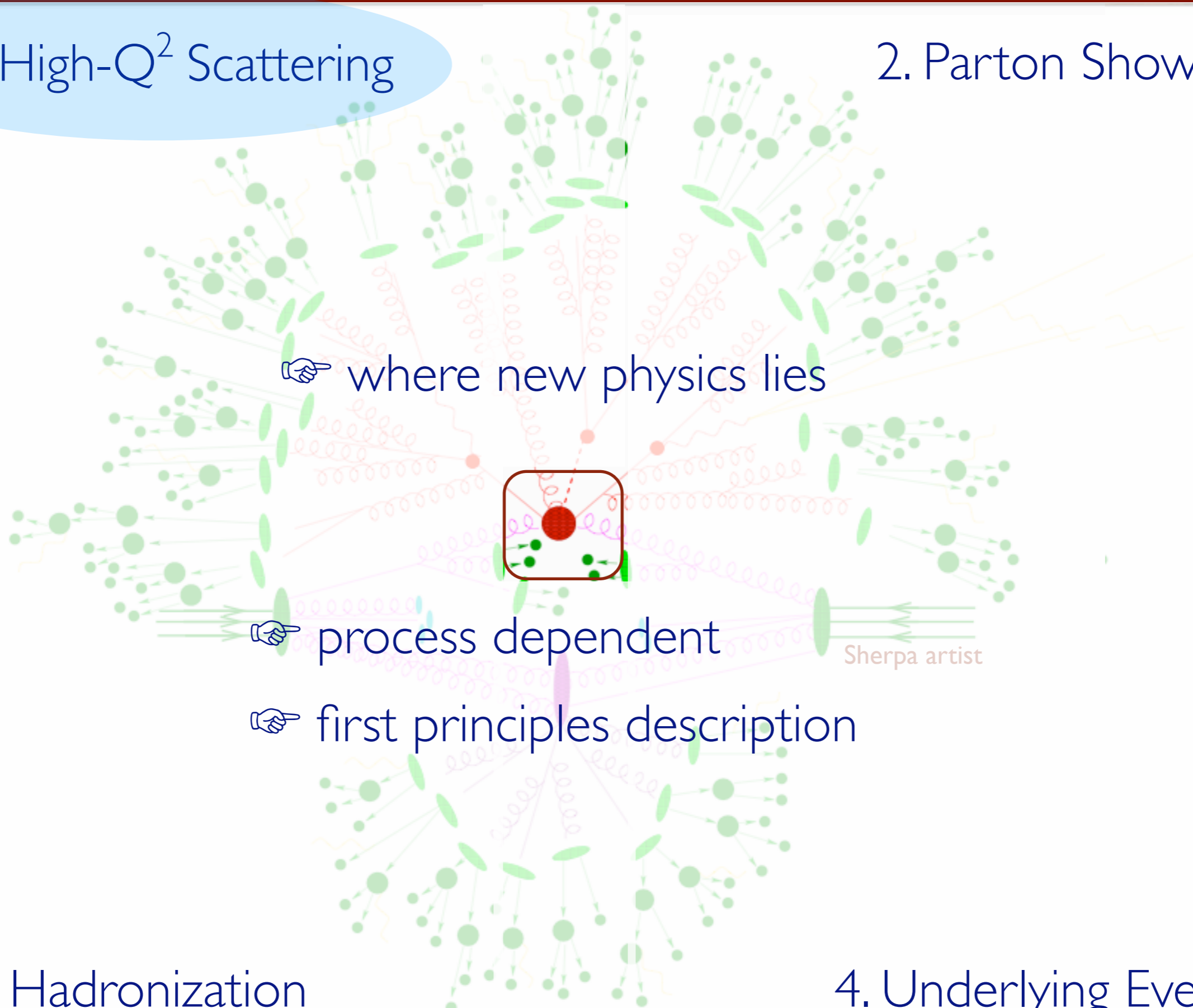

# 3. Hadronization

# 4. Underlying Event

# 1. High- $Q^2$ Scattering

# 2. Parton Shower

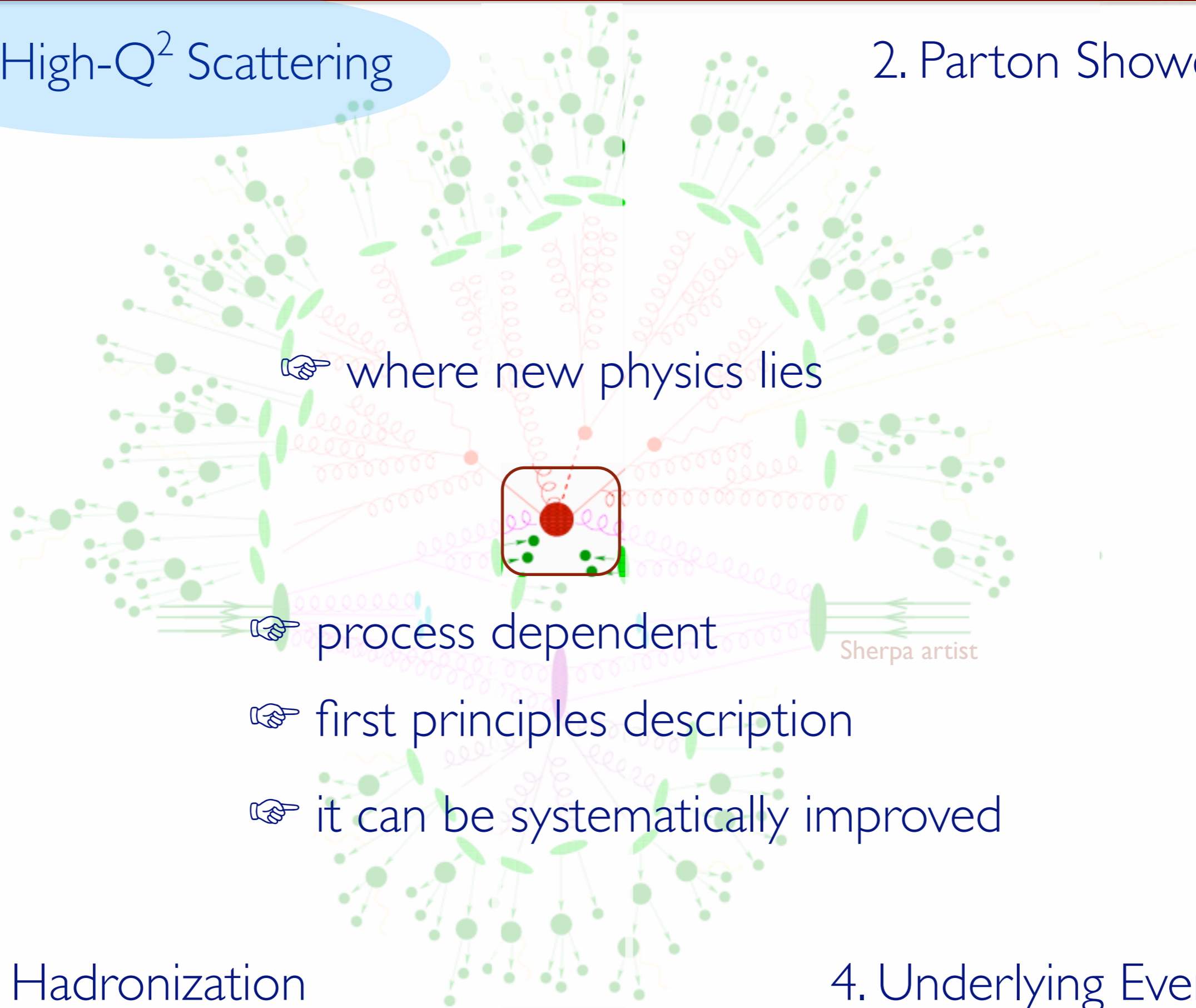

where new physics lies

process dependent

first principles description

it can be systematically improved

Sherpa artist

# 3. Hadronization

# 4. Underlying Event



# 1. High- $Q^2$ Scattering

# 2. Parton Shower

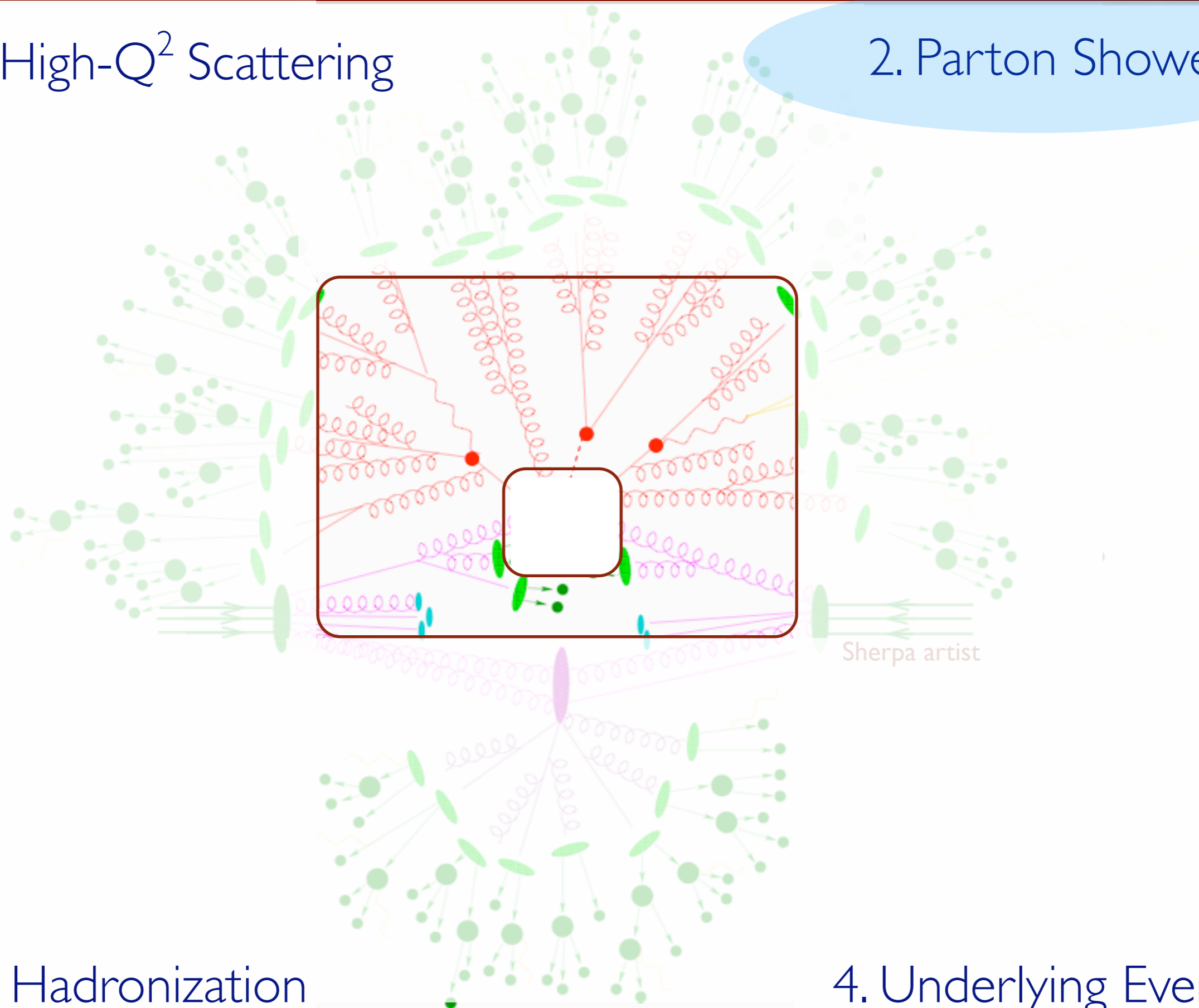

# 3. Hadronization

# 4. Underlying Event

# 1. High- $Q^2$ Scattering

# 2. Parton Shower

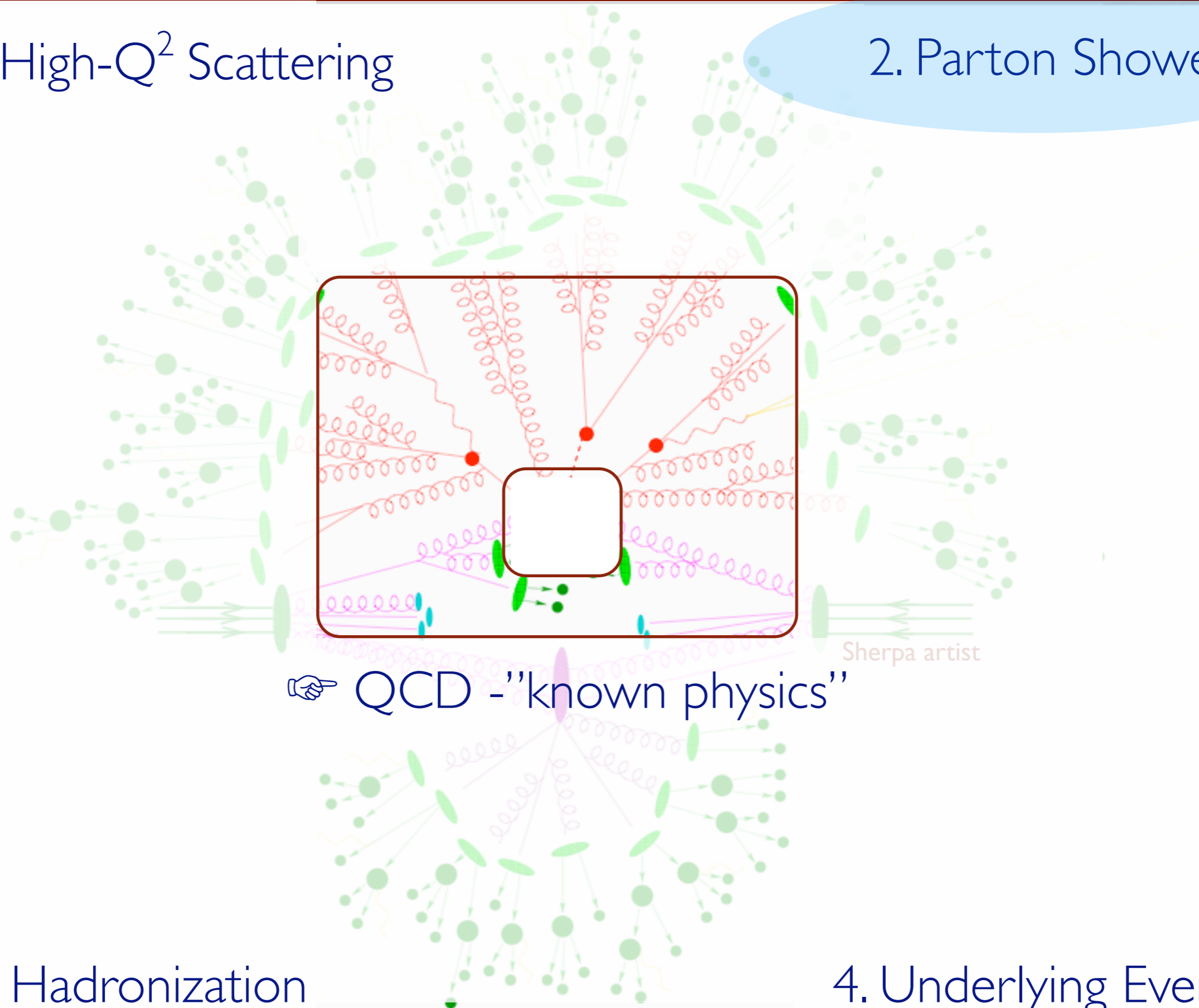

☞ QCD - "known physics"

# 3. Hadronization

# 4. Underlying Event

# 1. High- $Q^2$ Scattering

# 2. Parton Shower

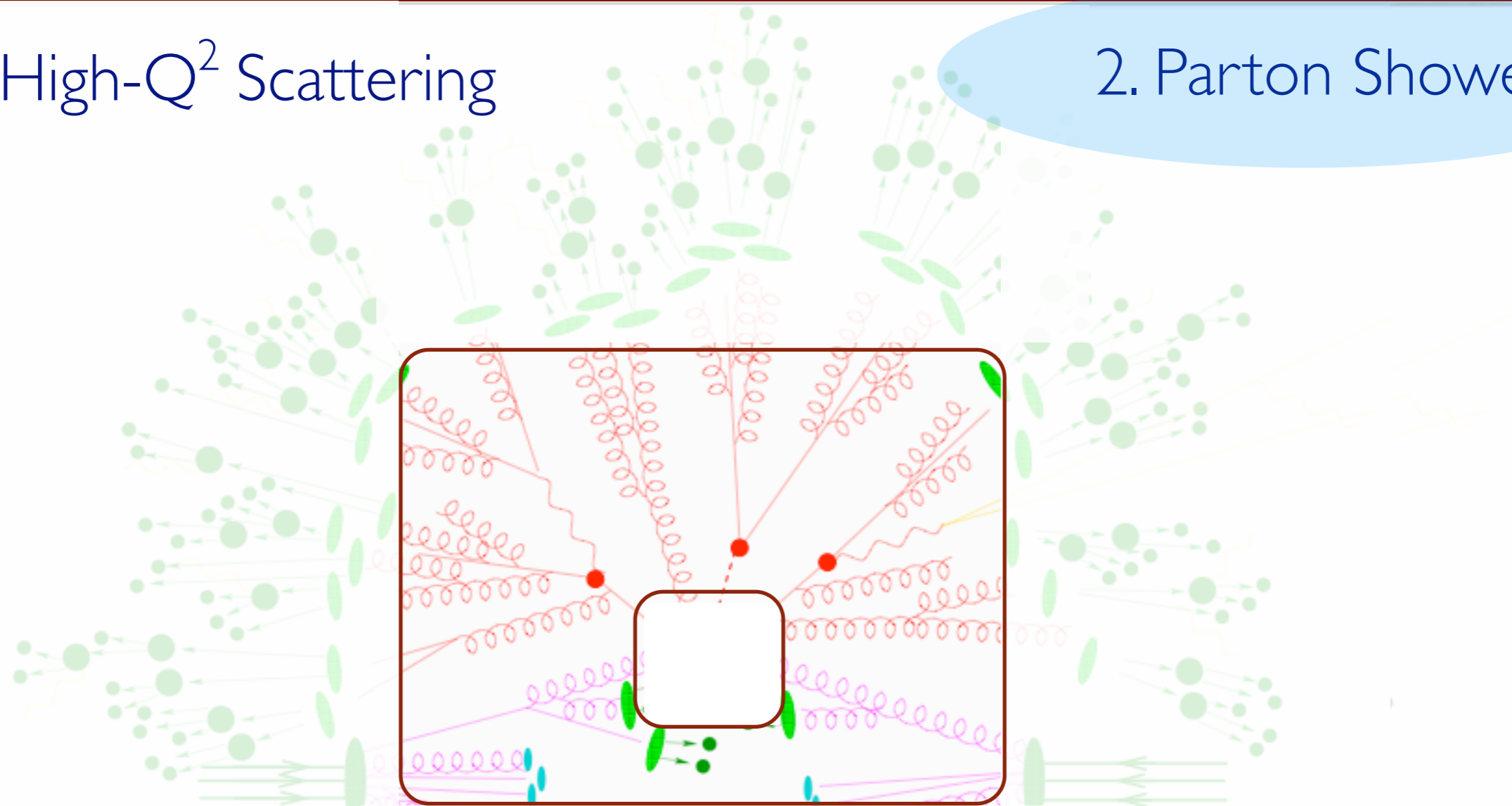

Sherpa artist

- ☞ QCD - "known physics"
- ☞ universal/ process independent

# 3. Hadronization

# 4. Underlying Event

# 1. High- $Q^2$ Scattering

# 2. Parton Shower

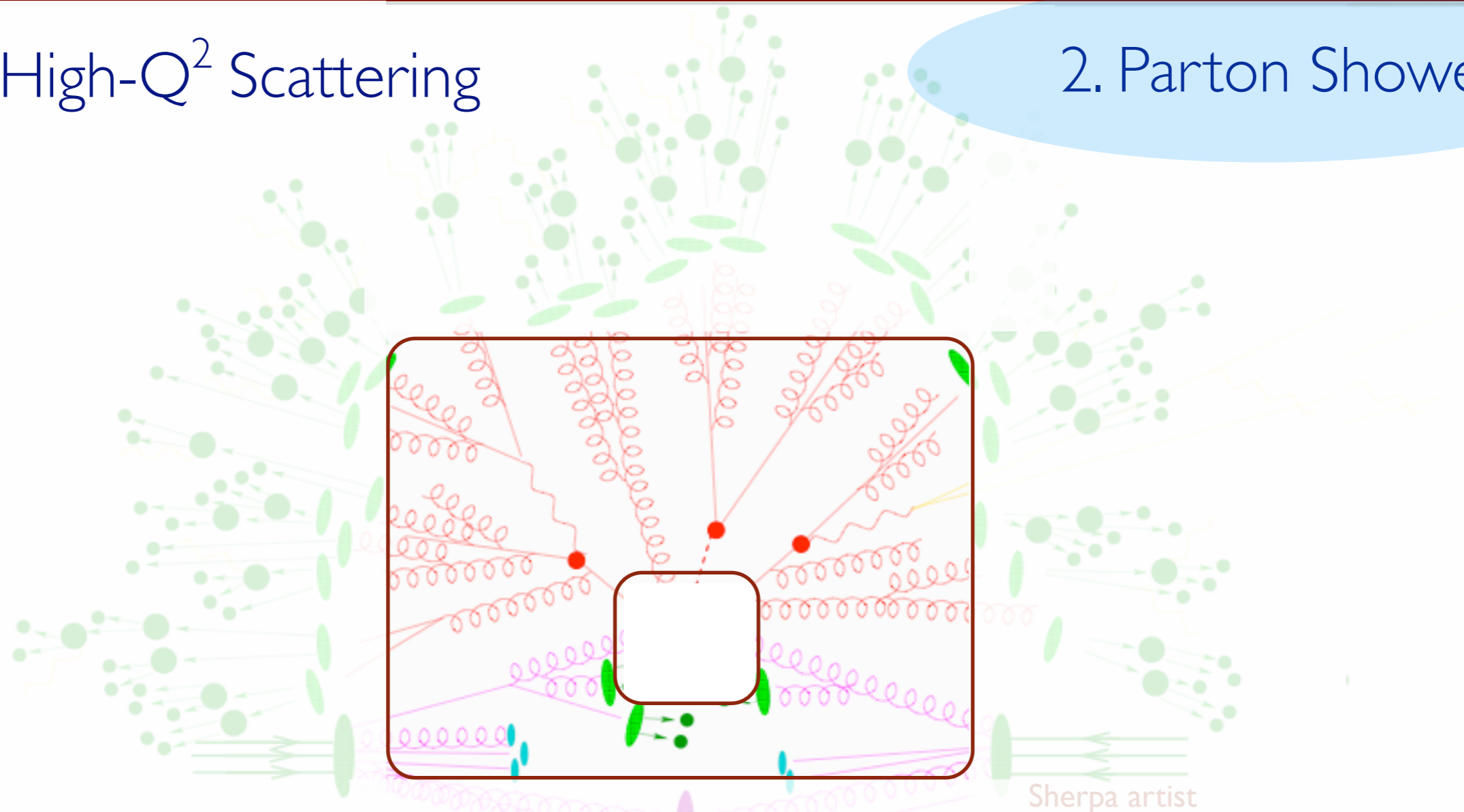

- ☞ QCD - "known physics"
- ☞ universal/ process independent
- ☞ first principles description

# 3. Hadronization

# 4. Underlying Event



# 1. High- $Q^2$ Scattering

# 2. Parton Shower

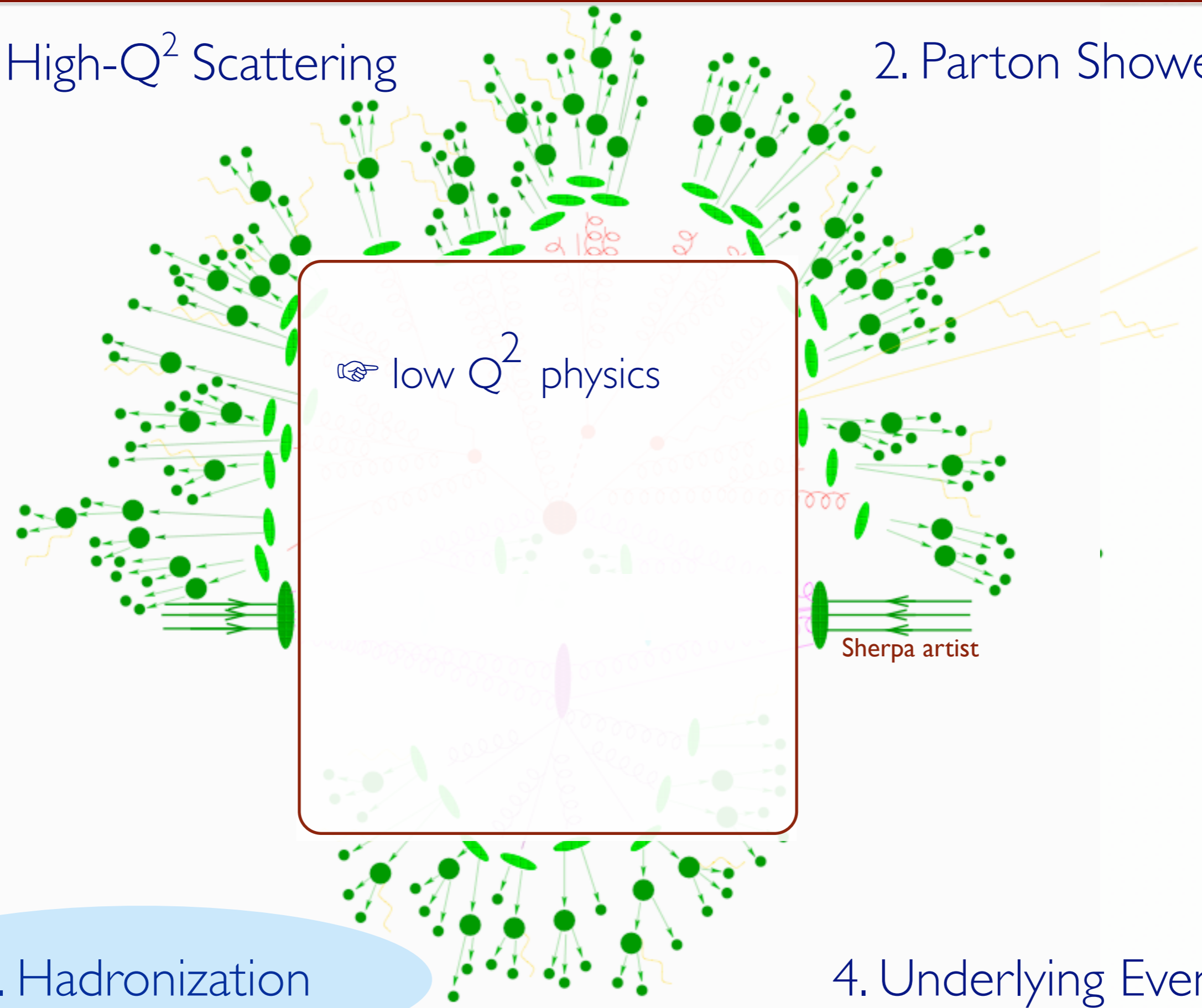

# 3. Hadronization

# 4. Underlying Event

# 1. High- $Q^2$ Scattering

# 2. Parton Shower

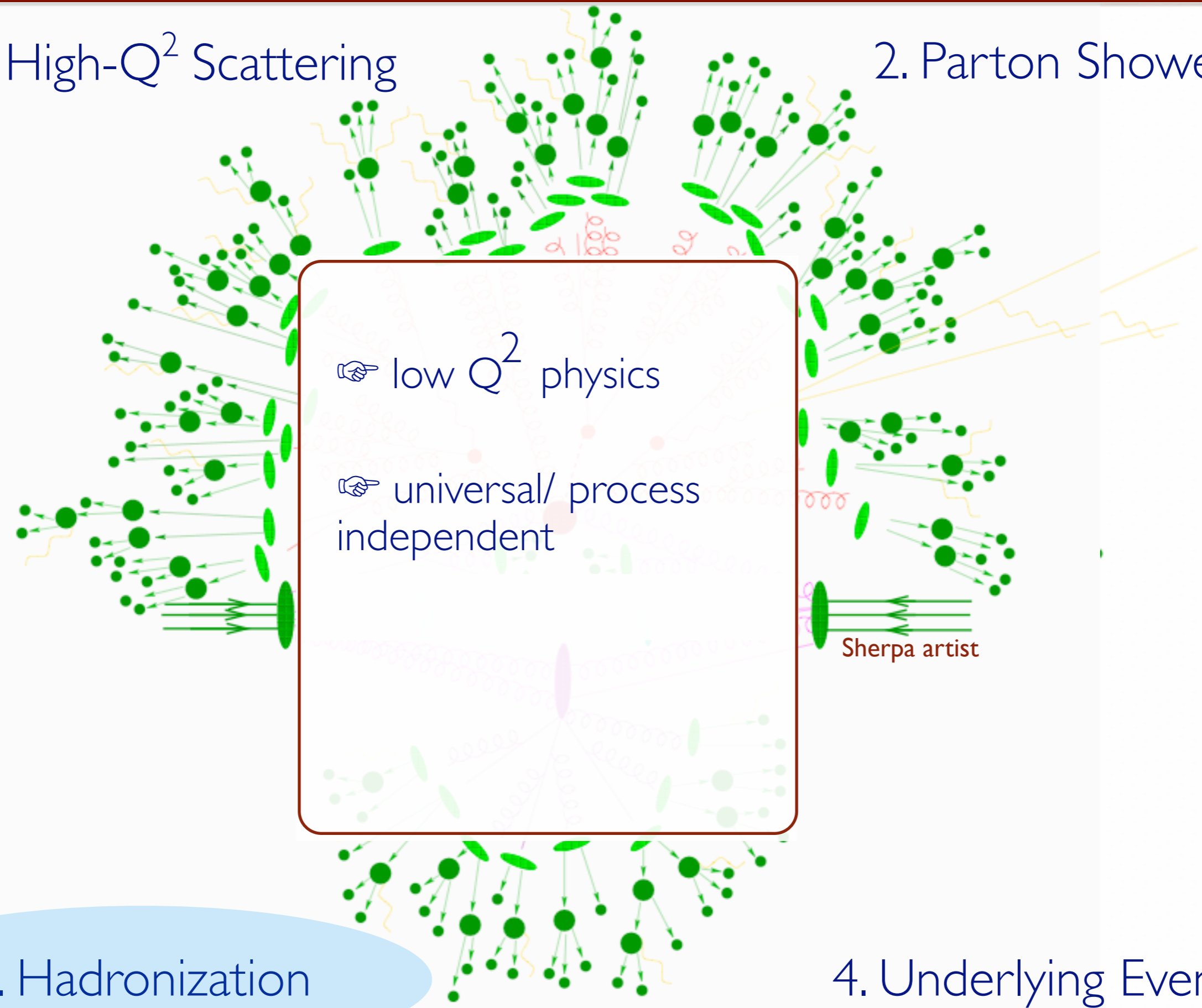

👉 low  $Q^2$  physics

👉 universal/ process independent

Sherpa artist

# 3. Hadronization

# 4. Underlying Event

# 1. High- $Q^2$ Scattering

# 2. Parton Shower

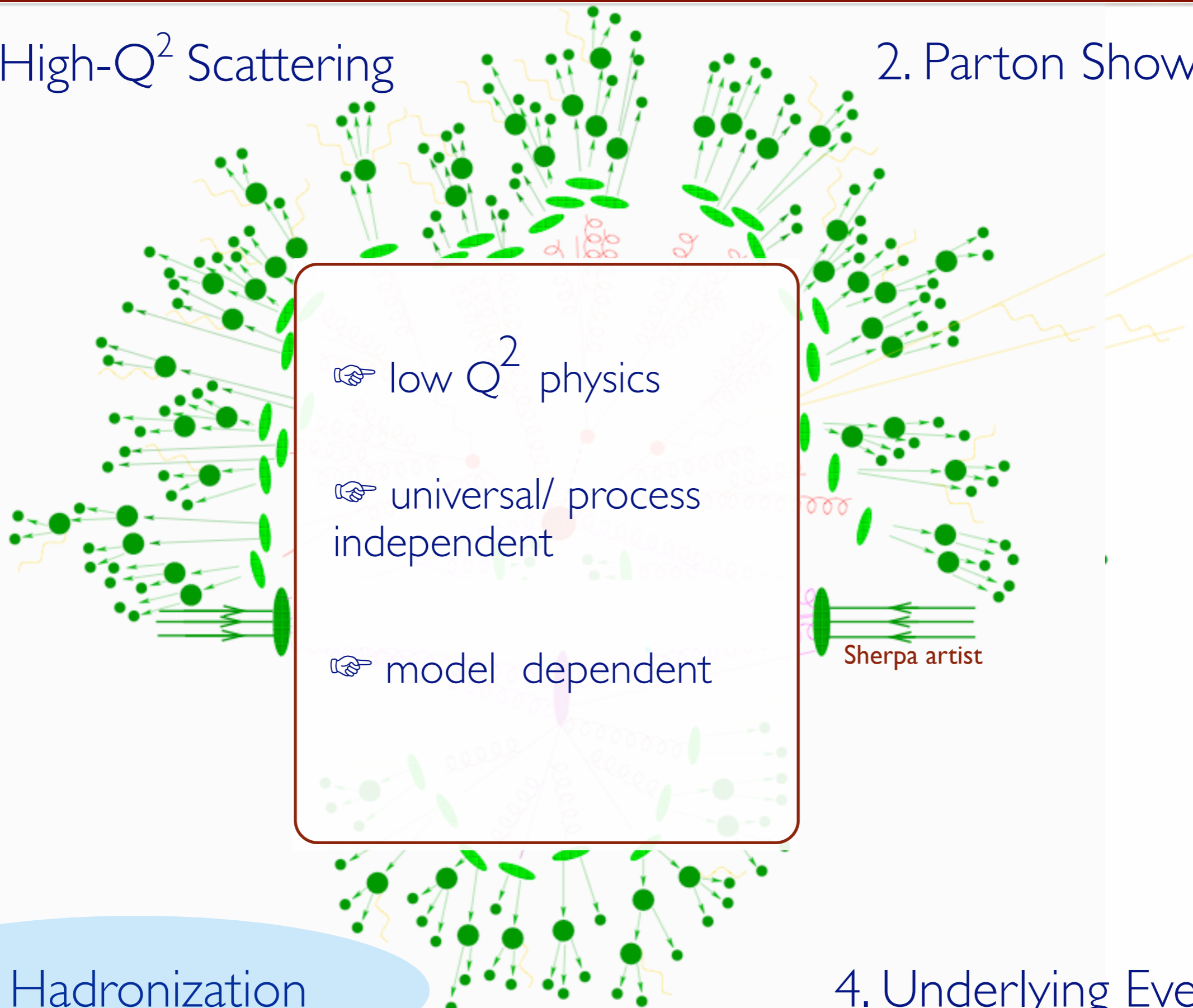

- low  $Q^2$  physics
- universal/ process independent
- model dependent

Sherpa artist

# 3. Hadronization

# 4. Underlying Event

# 1. High- $Q^2$ Scattering

# 2. Parton Shower

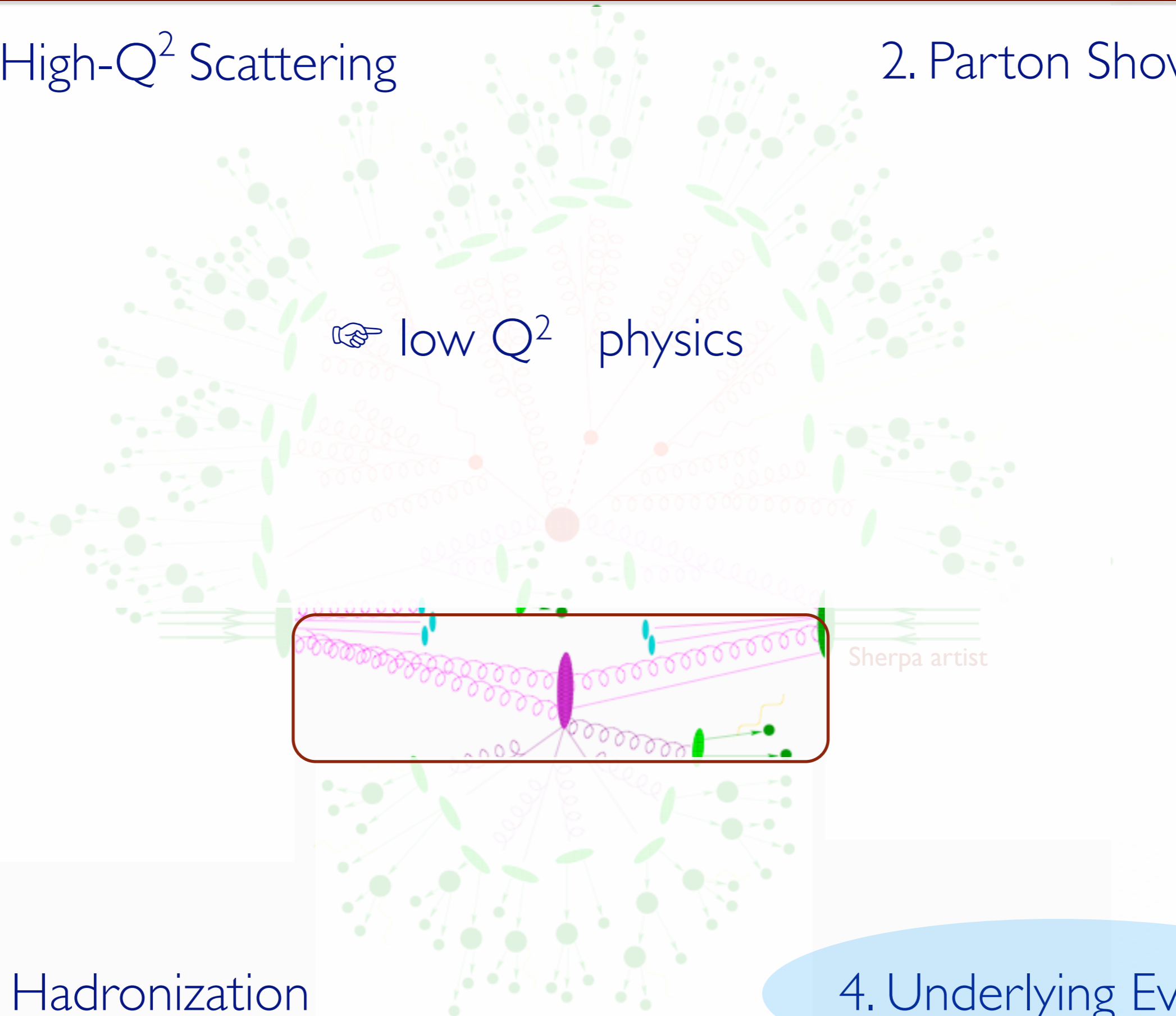

# 3. Hadronization

# 4. Underlying Event



# 1. High- $Q^2$ Scattering

# 2. Parton Shower

👉 low  $Q^2$  physics

👉 energy and process dependent

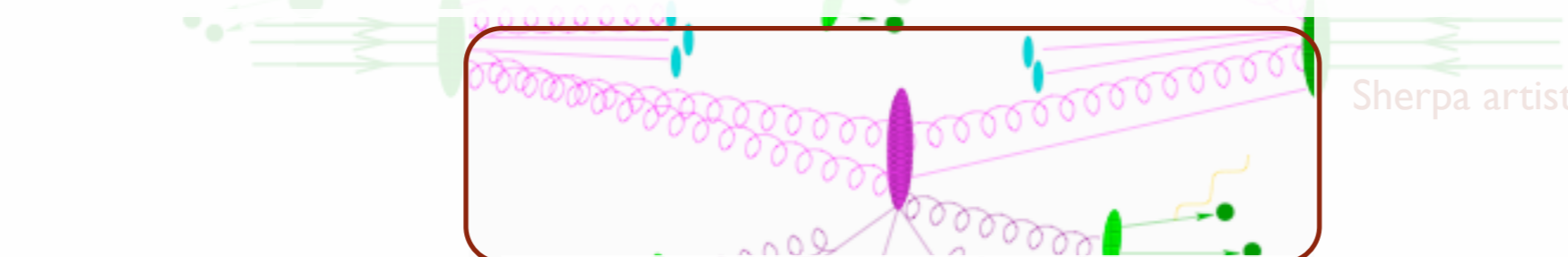

# 3. Hadronization

# 4. Underlying Event

# 1. High- $Q^2$ Scattering

# 2. Parton Shower

- 👉 low  $Q^2$  physics
- 👉 energy and process dependent
- 👉 model dependent

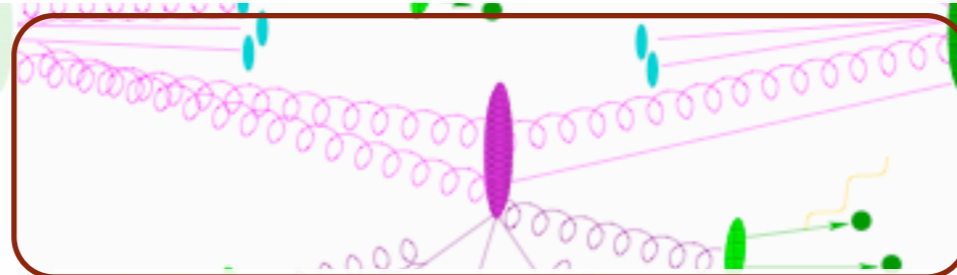

Sherpa artist

# 3. Hadronization

# 4. Underlying Event

1. High- $Q^2$  Scattering

2. Parton Shower

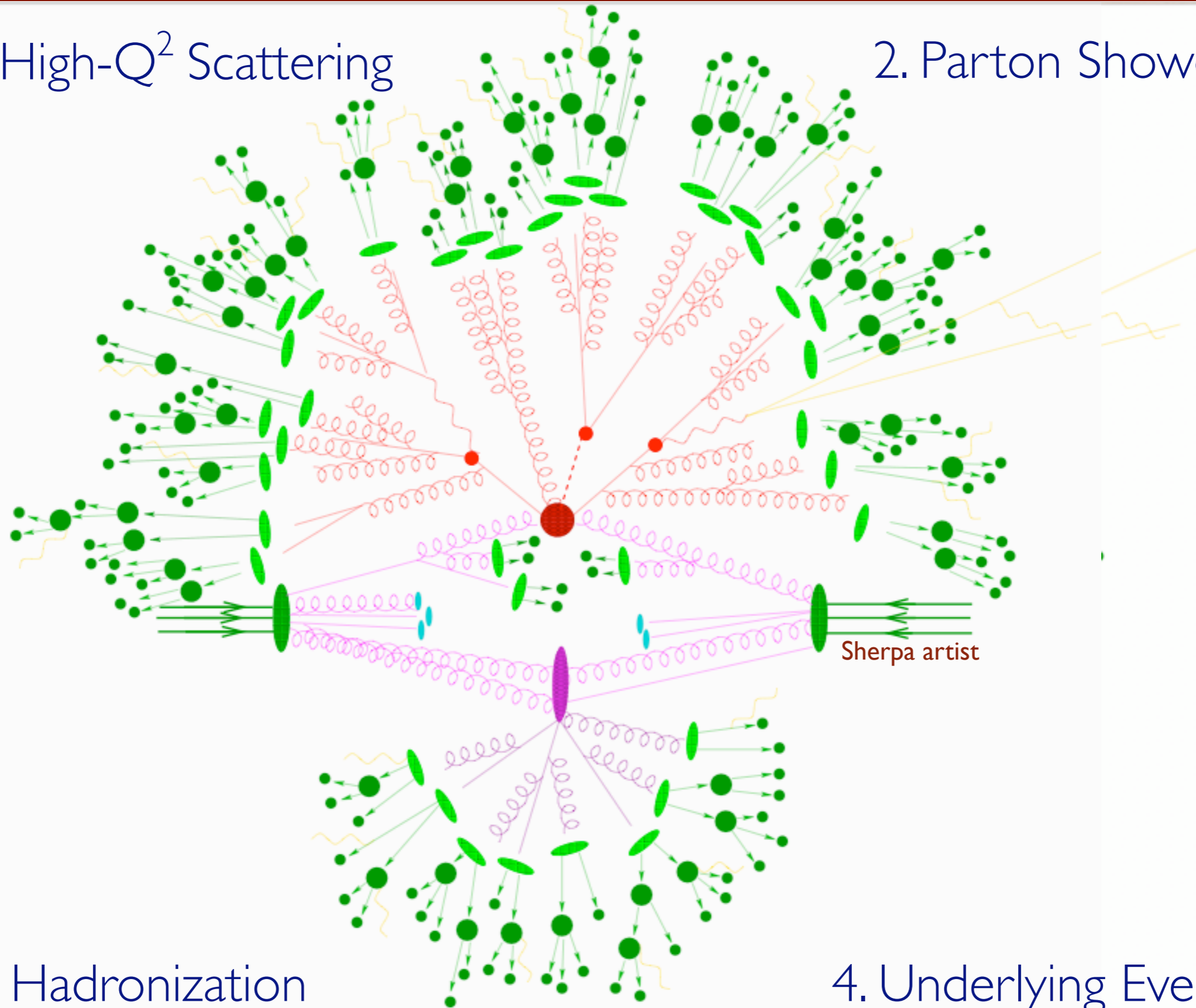

3. Hadronization

4. Underlying Event

# PARTON SHOWER

- We need to be able to describe an arbitrarily number of parton branchings, i.e. we need to 'dress' partons with radiation
- This effect should be unitary: the inclusive cross section shouldn't change when extra radiation is added
- Remember that parton-level cross sections for a hard process are inclusive in anything else.  
E.g. for LO Drell-Yan production **all** radiation is included via PDFs (apart from non-perturbative power corrections)
- And finally we want to turn partons into hadrons (hadronization)....

# COLLINEAR FACTORIZATION

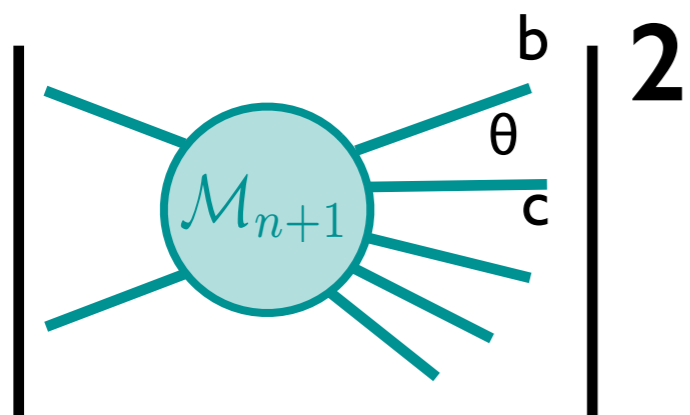

# COLLINEAR FACTORIZATION

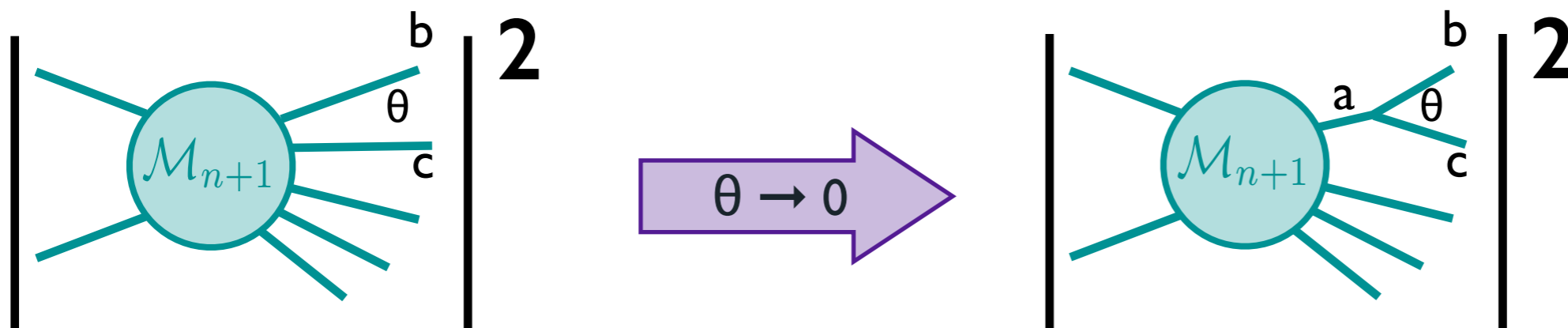

# COLLINEAR FACTORIZATION

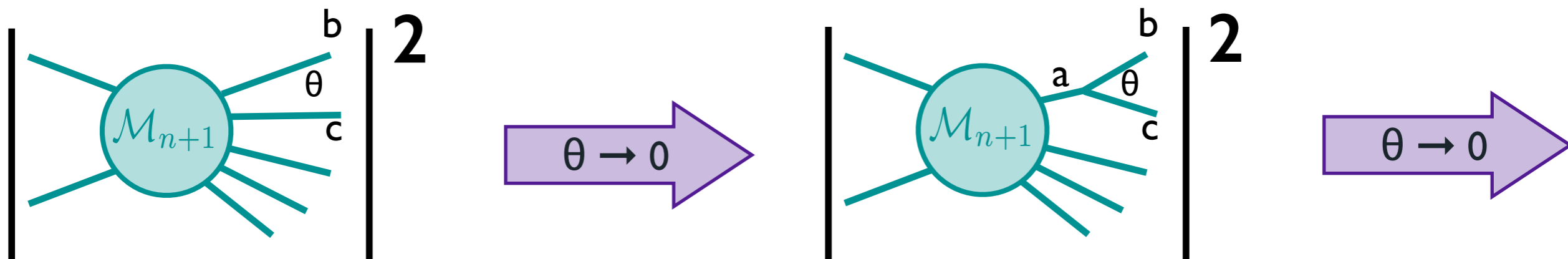

# COLLINEAR FACTORIZATION

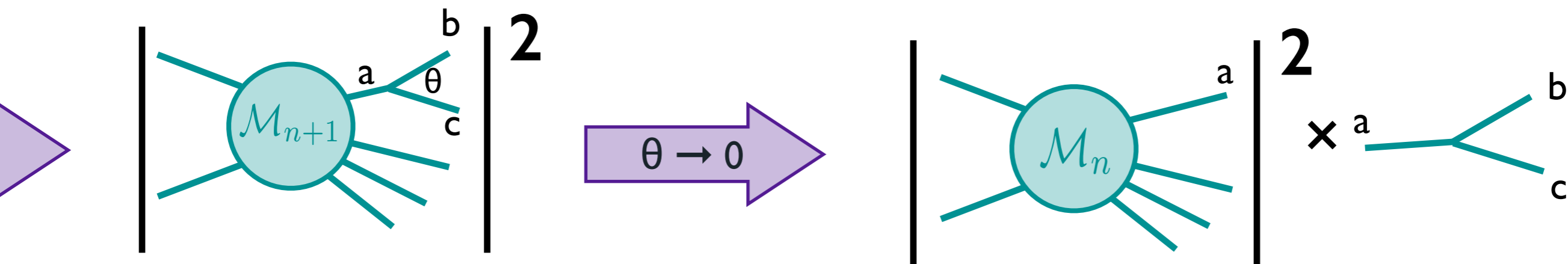



# COLLINEAR FACTORIZATION

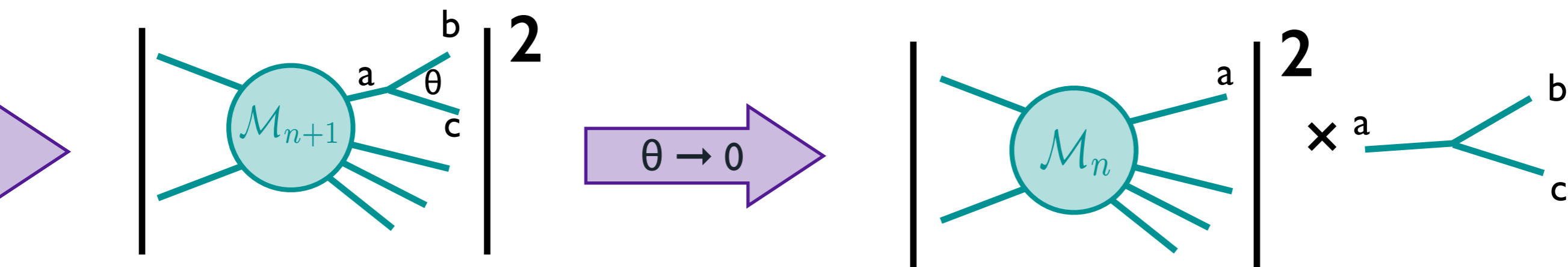

- Consider a process for which two particles are separated by a small angle  $\theta$ .

# COLLINEAR FACTORIZATION

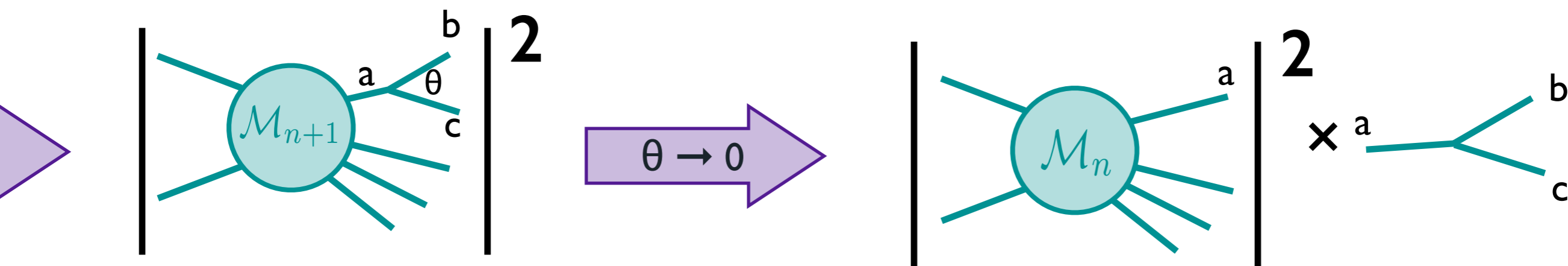

- Consider a process for which two particles are separated by a small angle  $\theta$ .
- In the limit of  $\theta \rightarrow 0$  the contribution is coming from a single parent particle going on shell: therefore its branching is related to time scales which are very long with respect to the hard subprocess.

# COLLINEAR FACTORIZATION

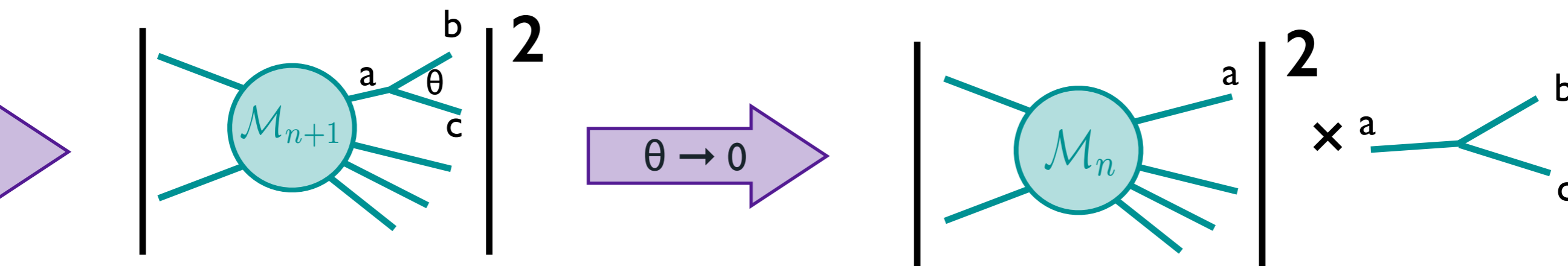

- Consider a process for which two particles are separated by a small angle  $\theta$ .
- In the limit of  $\theta \rightarrow 0$  the contribution is coming from a single parent particle going on shell: therefore its branching is related to time scales which are very long with respect to the hard subprocess.
- The inclusion of such a branching cannot change the picture set up by the hard process: the whole emission process must be writable in this limit as the simpler one times a branching probability.

# COLLINEAR FACTORIZATION

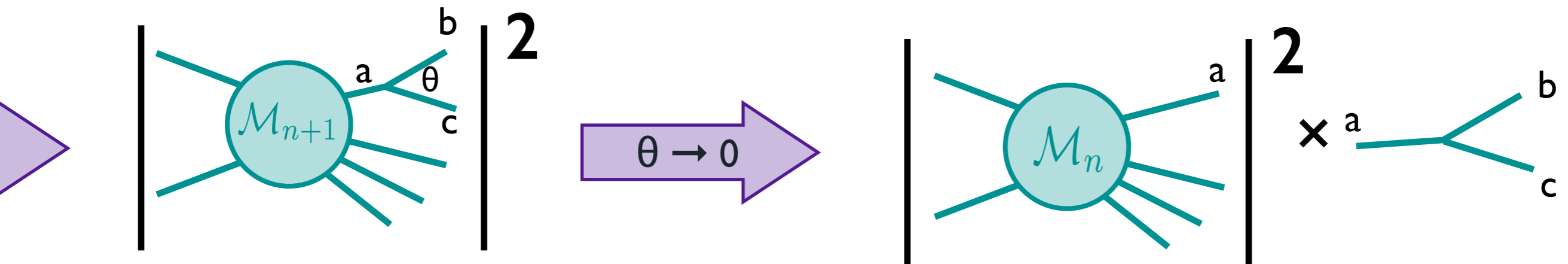

- Consider a process for which two particles are separated by a small angle  $\theta$ .
- In the limit of  $\theta \rightarrow 0$  the contribution is coming from a single parent particle going on shell: therefore its branching is related to time scales which are very long with respect to the hard subprocess.
- The inclusion of such a branching cannot change the picture set up by the hard process: the whole emission process must be writable in this limit as the simpler one times a branching probability.
- The first task of Monte Carlo physics is to make this statement quantitative.

# COLLINEAR FACTORIZATION

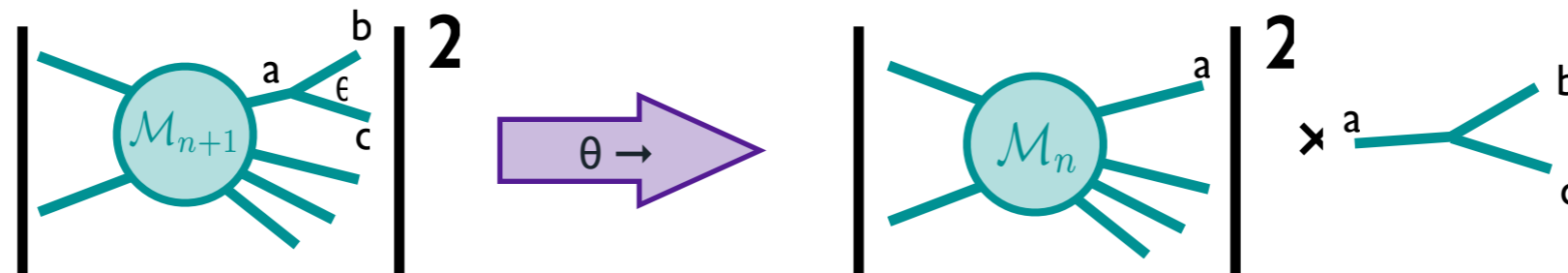

- ✱ The process factorizes in the collinear limit. This procedure is universal!

$$|\mathcal{M}_{n+1}|^2 d\Phi_{n+1} \simeq |\mathcal{M}_n|^2 d\Phi_n \frac{dt}{t} dz \frac{d\phi}{2\pi} \frac{\alpha_s}{2\pi} P_{a \rightarrow bc}(z)$$

- ✱ Notice that what has been roughly called ‘branching probability’ is actually a singular factor, so one will need to make sense precisely of this definition.
- ✱ At the leading contribution to the  $(n+1)$ -body cross section the Altarelli-Parisi splitting kernels are defined as:

$$P_{g \rightarrow qq}(z) = T_R [z^2 + (1-z)^2], \quad P_{g \rightarrow gg}(z) = C_A \left[ z(1-z) + \frac{z}{1-z} + \frac{1-z}{z} \right],$$

$$P_{q \rightarrow qq}(z) = C_F \left[ \frac{1+z^2}{1-z} \right], \quad P_{q \rightarrow gq}(z) = C_F \left[ \frac{1+(1-z)^2}{z} \right].$$

# COLLINEAR FACTORIZATION

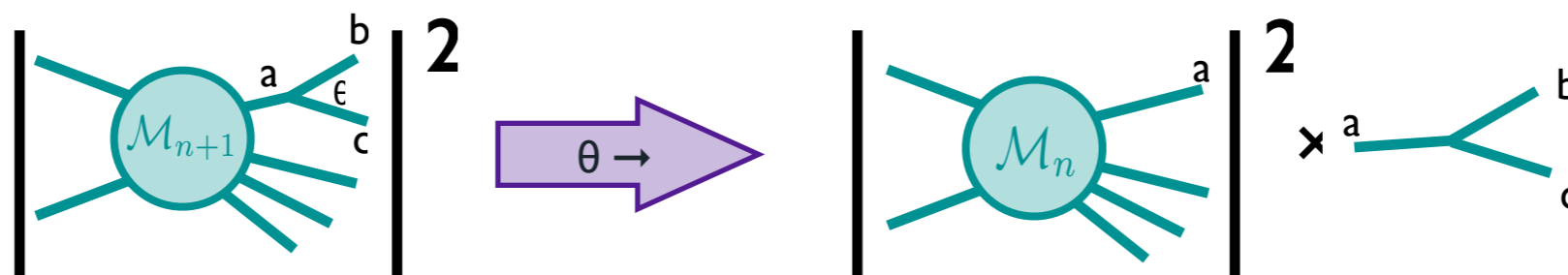

- ✱ The process factorizes in the collinear limit. This procedure is universal!

$$|\mathcal{M}_{n+1}|^2 d\Phi_{n+1} \simeq |\mathcal{M}_n|^2 d\Phi_n \frac{dt}{t} dz \frac{d\phi}{2\pi} \frac{\alpha_s}{2\pi} P_{a \rightarrow bc}(z)$$

- ✱  $t$  can be called the 'evolution variable' (will become clearer later): it can be the virtuality  $m^2$  of particle  $a$  or its  $p_T^2$  or  $E^2\theta^2$  ...

- ✱ It represents the hardness of the branching and tends to 0 in the collinear limit.

- ✱ Indeed in the collinear limit one has: so that the factorization takes place for all these definitions:

$$d\theta^2 / \theta^2 = dm^2 / m^2 = dp_T^2 / p_T^2$$

$$m^2 \simeq z(1-z)\theta^2 E_a^2$$

$$p_T^2 \simeq zm^2$$

# COLLINEAR FACTORIZATION

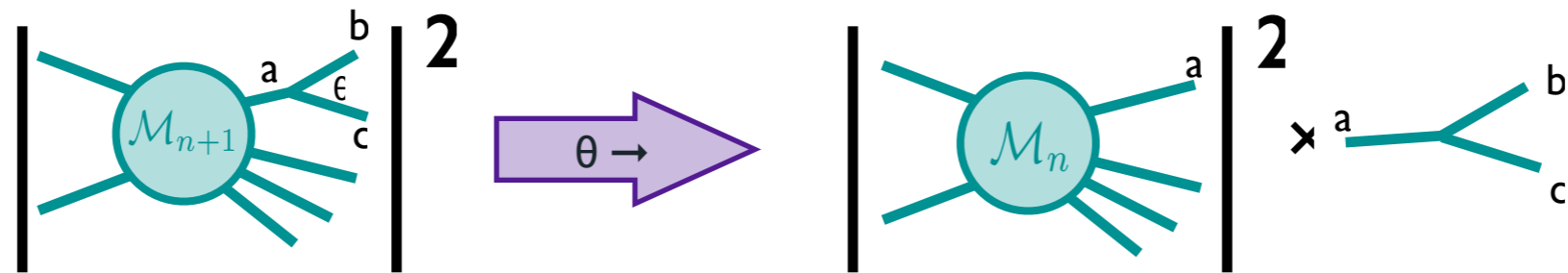

- ✱ The process factorizes in the collinear limit. This procedure is universal!

$$|\mathcal{M}_{n+1}|^2 d\Phi_{n+1} \simeq |\mathcal{M}_n|^2 d\Phi_n \frac{dt}{t} dz \frac{d\phi}{2\pi} \frac{\alpha_s}{2\pi} P_{a \rightarrow bc}(z)$$

- ✱  $\mathbf{z}$  is the “energy variable”: it is defined to be the energy fraction taken by parton  $\mathbf{b}$  from parton  $\mathbf{a}$ . It represents the energy sharing between  $\mathbf{b}$  and  $\mathbf{c}$  and tends to 1 in the soft limit (parton  $\mathbf{c}$  going soft)
- ✱  $\Phi$  is the azimuthal angle. It can be chosen to be the angle between the polarization of  $\mathbf{a}$  and the plane of the branching.

## MULTIPLE EMISSION

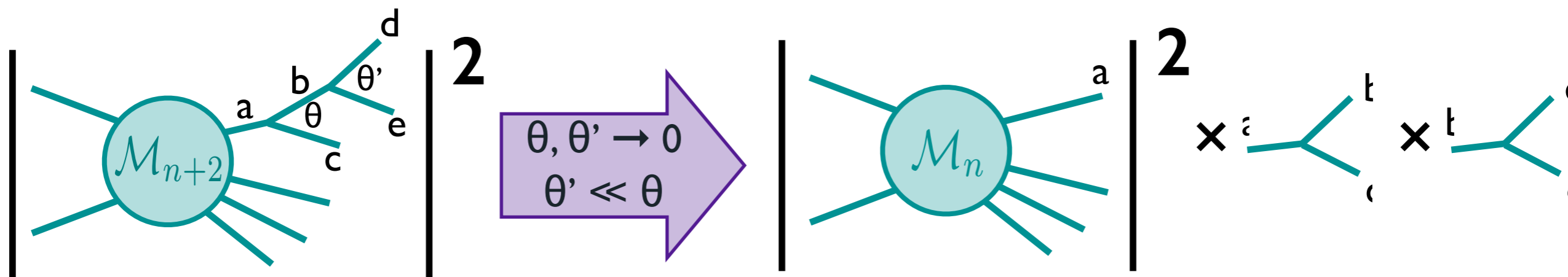

- Now consider  $\mathcal{M}_{n+1}$  as the new core process and use the recipe we used for the first emission in order to get the dominant contribution to the  $(n+2)$ -body cross section: add a new branching at angle much smaller than the previous one:

$$\begin{aligned}
 |\mathcal{M}_{n+2}|^2 d\Phi_{n+2} &\simeq |\mathcal{M}_n|^2 d\Phi_n \frac{dt}{t} dz \frac{d\phi}{2\pi} \frac{\alpha_s}{2\pi} P_{a \rightarrow bc}(z) \\
 &\quad \times \frac{dt'}{t'} dz' \frac{d\phi'}{2\pi} \frac{\alpha_s}{2\pi} P_{b \rightarrow de}(z')
 \end{aligned}$$

- This can be done for an arbitrary number of emissions. The recipe to get the leading collinear singularity is thus cast in the form of an iterative sequence of emissions whose probability does not depend on the past history of the system: a 'Markov chain'. **No interference!!!**



## MULTIPLE EMISSION

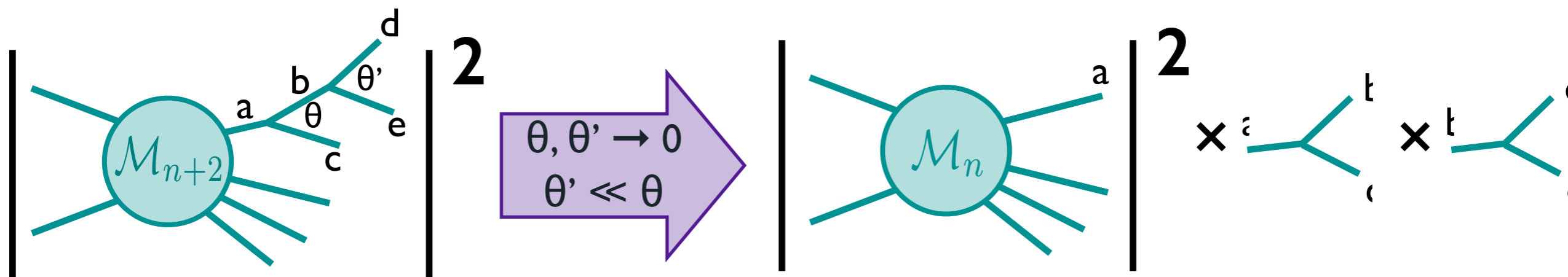

- The dominant contribution comes from the region where the subsequently emitted partons satisfy the strong ordering requirement:  $\theta \gg \theta' \gg \theta'' \dots$

For the rate for multiple emission we get

$$\sigma_{n+k} \propto \alpha_s^k \int_{Q_0^2}^{Q^2} \frac{dt}{t} \int_{Q_0^2}^t \frac{dt'}{t'} \dots \int_{Q_0^2}^{t^{(k-2)}} \frac{dt^{(k-1)}}{t^{(k-1)}} \propto \sigma_n \left( \frac{\alpha_s}{2\pi} \right)^k \log^k(Q^2/Q_0^2)$$

where  $Q$  is a typical hard scale and  $Q_0$  is a small infrared cutoff that separates perturbative from non perturbative regimes.

- Each power of  $\alpha_s$  comes with a logarithm. The logarithm can be easily large, and therefore it can lead to a breakdown of perturbation theory.

## ABSENCE OF INTERFERENCE

- The collinear factorization picture gives a branching sequence for a given leg starting from the hard subprocess all the way down to the non-perturbative region.
- Suppose you want to describe two such histories from two different legs: these two legs are treated in a completely uncorrelated way. And even within the same history, subsequent emissions are uncorrelated.
- The collinear picture completely misses the possible interference effects between the various legs. The extreme simplicity comes at the price of quantum inaccuracy.
- Nevertheless, the collinear picture captures the leading contributions: it gives an excellent description of an arbitrary number of (collinear) emissions:
  - it is a “resummed computation”
  - it bridges the gap between fixed-order perturbation theory and the non-perturbative hadronization.

## SUDAKOV FORM FACTOR

The differential probability for the branching  $a \rightarrow bc$  between scales  $t$  and  $t+dt$  knowing that no emission occurred before:

$$dp(t) = \sum_{bc} \frac{dt}{t} \int dz \frac{d\phi}{2\pi} \frac{\alpha_s}{2\pi} P_{a \rightarrow bc}(z)$$

The probability that a parton does NOT split between the scales  $t$  and  $t+dt$  is given by  $1-dp(t)$ .

Probability that particle  $a$  does not emit between scales  $Q^2$  and  $t$

$$\Delta(Q^2, t) = \prod_k \left[ 1 - \sum_{bc} \frac{dt_k}{t_k} \int dz \frac{d\phi}{2\pi} \frac{\alpha_s}{2\pi} P_{a \rightarrow bc}(z) \right] =$$

$$\exp \left[ - \sum_{bc} \int_t^{Q^2} \frac{dt'}{t'} \int dz \frac{d\phi}{2\pi} \frac{\alpha_s}{2\pi} P_{a \rightarrow bc}(z) \right] = \exp \left[ - \int_t^{Q^2} dp(t') \right]$$

✱  $\Delta(Q^2, t)$  is the Sudakov form factor

✱ Property:  $\Delta(A, B) = \Delta(A, C) \Delta(C, B)$

## PARTON SHOWER

- ✱ The Sudakov form factor is the heart of the parton shower. It gives the probability that a parton does not branch between two scales
- ✱ Using this no-emission probability the **branching tree of a parton** is generated.
- ✱ Define  **$dP_k$**  as the probability for  $k$  ordered splittings from leg  $a$  at given scales

$$\begin{aligned}
 dP_1(t_1) &= \Delta(Q^2, t_1) dp(t_1) \Delta(t_1, Q_0^2), \\
 dP_2(t_1, t_2) &= \Delta(Q^2, t_1) dp(t_1) \Delta(t_1, t_2) dp(t_2) \Delta(t_2, Q_0^2) \Theta(t_1 - t_2), \\
 &\dots = \dots \\
 dP_k(t_1, \dots, t_k) &= \Delta(Q^2, Q_0^2) \prod_{l=1}^k dp(t_l) \Theta(t_{l-1} - t_l)
 \end{aligned}$$

- ✱  $Q_0^2$  is the hadronization scale ( $\sim 1$  GeV). Below this scale we do not trust the perturbative description for parton splitting anymore.
- ✱ This is what is implemented in a parton shower, taking the scales for the splitting  $t_i$  randomly (but weighted according to the no-emission probability).

# UNITARITY

$$dP_k(t_1, \dots, t_k) = \Delta(Q^2, Q_0^2) \prod_{l=1}^k dp(t_l) \Theta(t_{l-1} - t_l)$$

- The parton shower has to be unitary (the sum over all branching trees should be 1). We can explicitly show this by integrating the probability for  $k$  splittings:

$$P_k \equiv \int dP_k(t_1, \dots, t_k) = \Delta(Q^2, Q_0^2) \frac{1}{k!} \left[ \int_{Q_0^2}^{Q^2} dp(t) \right]^k, \quad \forall k = 0, 1, \dots$$

- Summing over all number of emissions

$$\sum_{k=0}^{\infty} P_k = \Delta(Q^2, Q_0^2) \sum_{k=0}^{\infty} \frac{1}{k!} \left[ \int_{Q_0^2}^{Q^2} dp(t) \right]^k = \Delta(Q^2, Q_0^2) \exp \left[ \int_{Q_0^2}^{Q^2} dp(t) \right] = 1$$

- Hence, the total probability is conserved

# CHOICE OF EVOLUTION PARAMETER

$$\Delta(Q^2, t) = \exp \left[ - \sum_{bc} \int_t^{Q^2} \frac{dt'}{t'} dz \frac{d\phi}{2\pi} \frac{\alpha_s}{2\pi} P_{a \rightarrow bc}(z) \right]$$

- There is a lot of freedom in the choice of evolution parameter  $t$ . It can be the virtuality  $m^2$  of particle  $a$  or its  $p_T^2$  or  $E^2\theta^2$  ... For the collinear limit they are all equivalent
- However, in the soft limit ( $z \rightarrow 1$ ) they behave differently
- Can we choose it such that we get the correct soft limit?

# CHOICE OF EVOLUTION PARAMETER

$$\Delta(Q^2, t) = \exp \left[ - \sum_{bc} \int_t^{Q^2} \frac{dt'}{t'} dz \frac{d\phi}{2\pi} \frac{\alpha_s}{2\pi} P_{a \rightarrow bc}(z) \right]$$

- There is a lot of freedom in the choice of evolution parameter  $t$ . It can be the virtuality  $m^2$  of particle  $a$  or its  $p_T^2$  or  $E^2 \theta^2$  ... For the collinear limit they are all equivalent
- However, in the soft limit ( $z \rightarrow 1$ ) they behave differently
- Can we choose it such that we get the correct soft limit?

**YES!** It should be (proportional to) the angle  $\theta$

# ANGULAR ORDERING

$$\left| \begin{array}{c} \text{Vertex} \end{array} \right|^2 = \left| \begin{array}{c} \text{Vertex with } \varphi_1 \text{ and } \varphi \end{array} \right|^2 \Theta(\varphi - \varphi_1) + \left| \begin{array}{c} \text{Vertex with } \varphi_2 \end{array} \right|^2 \Theta(\varphi - \varphi_2)$$

Radiation inside cones around the original partons is allowed (and described by the eikonal approximation), outside the cones it is zero (after averaging over the azimuthal angle)

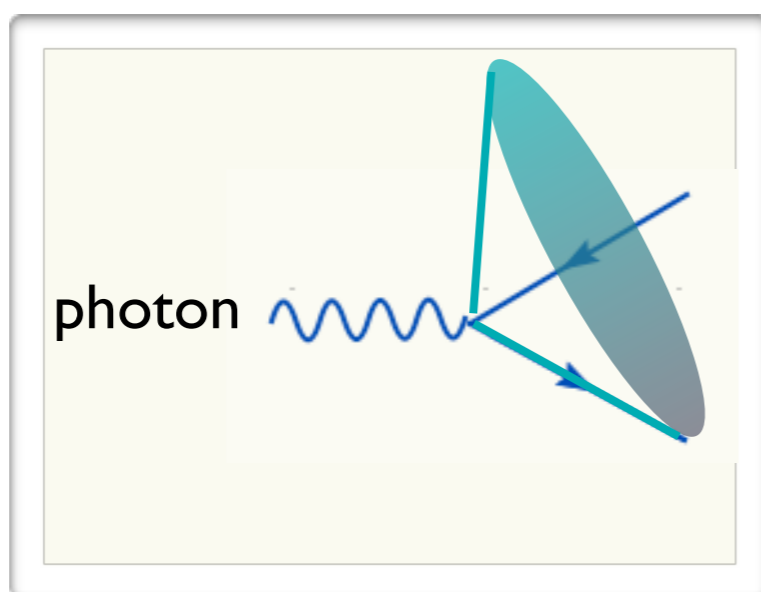

+

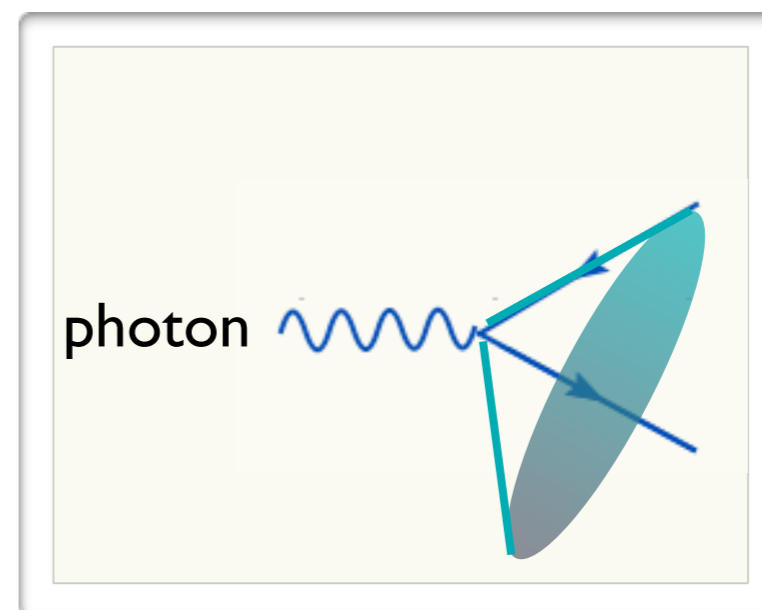



# ANGULAR ORDERING

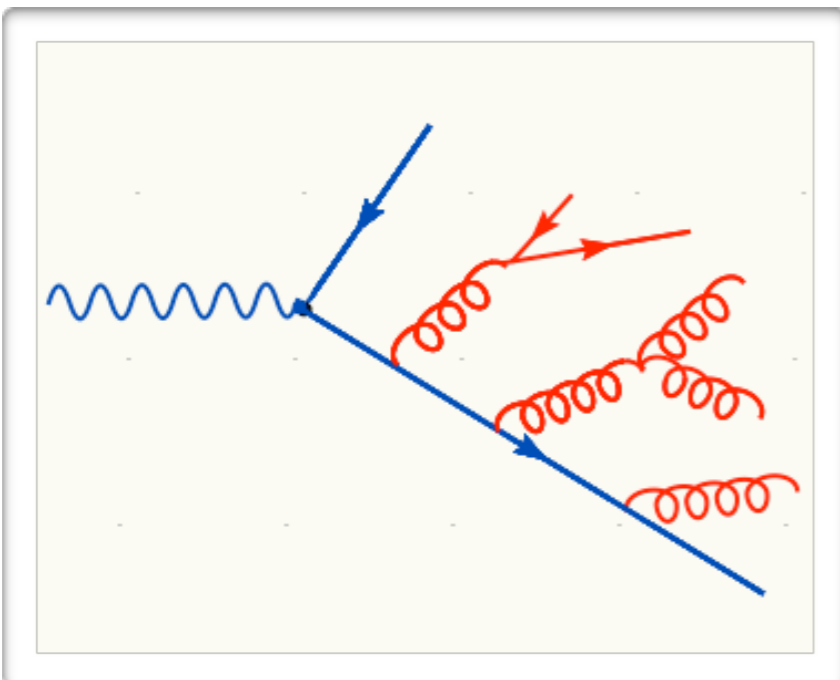
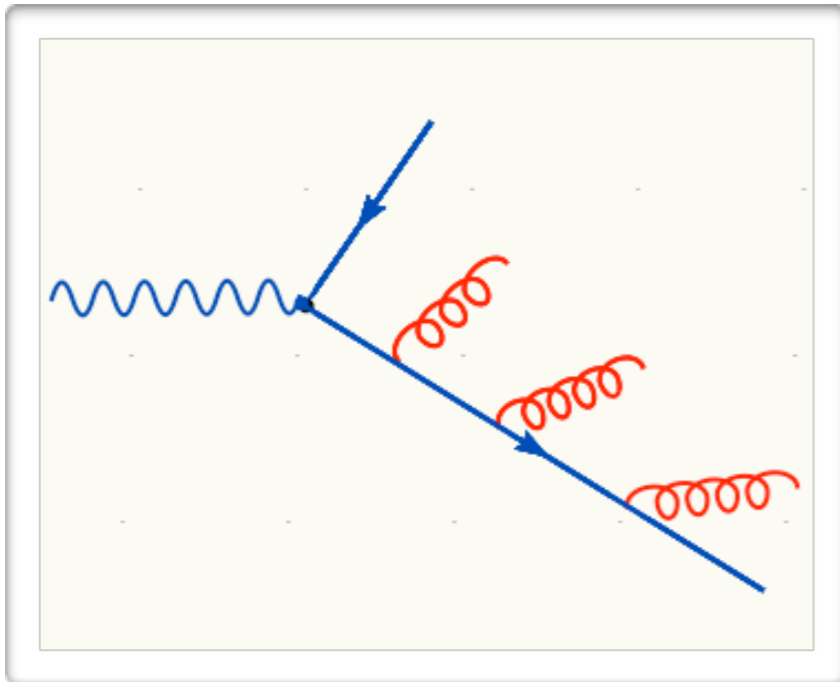

- ✱ The construction can be iterated to the next emission, with the result that the emission angles keep getting smaller and smaller.
- ✱ One can generalize it to a generic parton of color charge  $Q_k$  splitting into two partons  $i$  and  $j$ ,  $Q_k = Q_i + Q_j$ . The result is that inside the cones  $i$  and  $j$  emit as independent charges, and outside their angular-ordered cones the emission is coherent and can be treated as if it was directly from color charge  $Q_k$ .
- ✱ **KEY POINT FOR THE MC!**
- ✱ Angular ordering is automatically satisfied in  $\theta$  ordered showers! (and easy to account for in  $p_T$  ordered showers).

# HADRONIZATION

- The shower stops if all partons are characterized by a scale at the IR cut-off:  $Q_0 \sim 1 \text{ GeV}$ .
- Physically, we observe hadrons, not (colored) partons.
- We need a non-perturbative model in passing from partons to colorless hadrons.
- There are two models (string and cluster), based on physical and phenomenological considerations.

# CLUSTER MODEL

The structure of the perturbative evolution including angular ordering, leads naturally to the clustering in phase-space of color-singlet parton pairs (preconfinement). Long-range correlations are strongly suppressed. Hadronization will only act locally, on low-mass color singlet clusters.

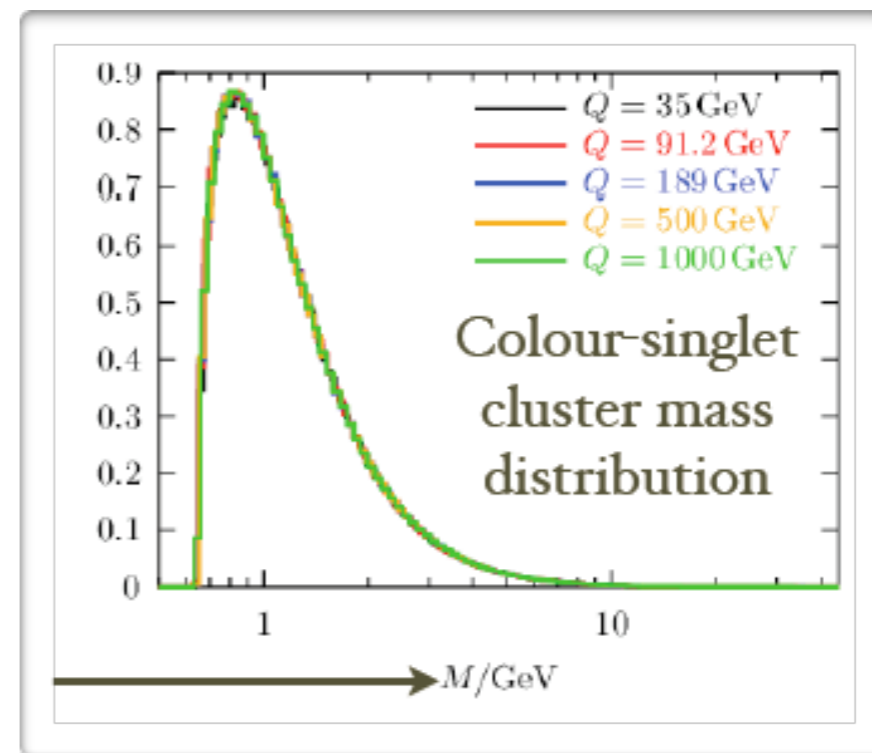
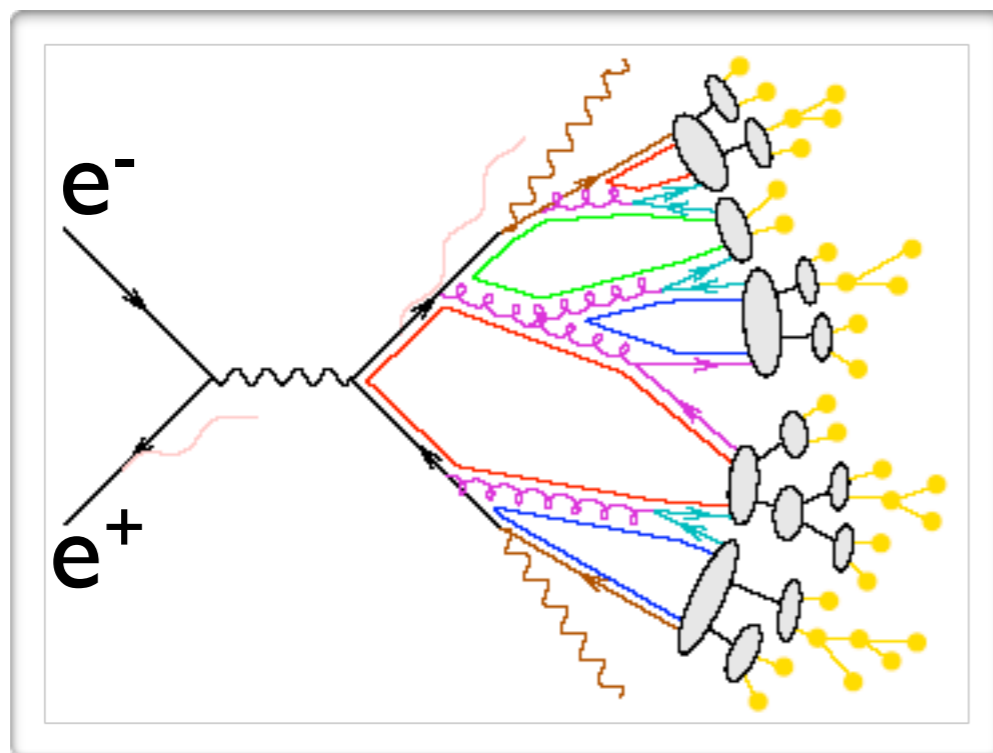

# EXCLUSIVE OBSERVABLE

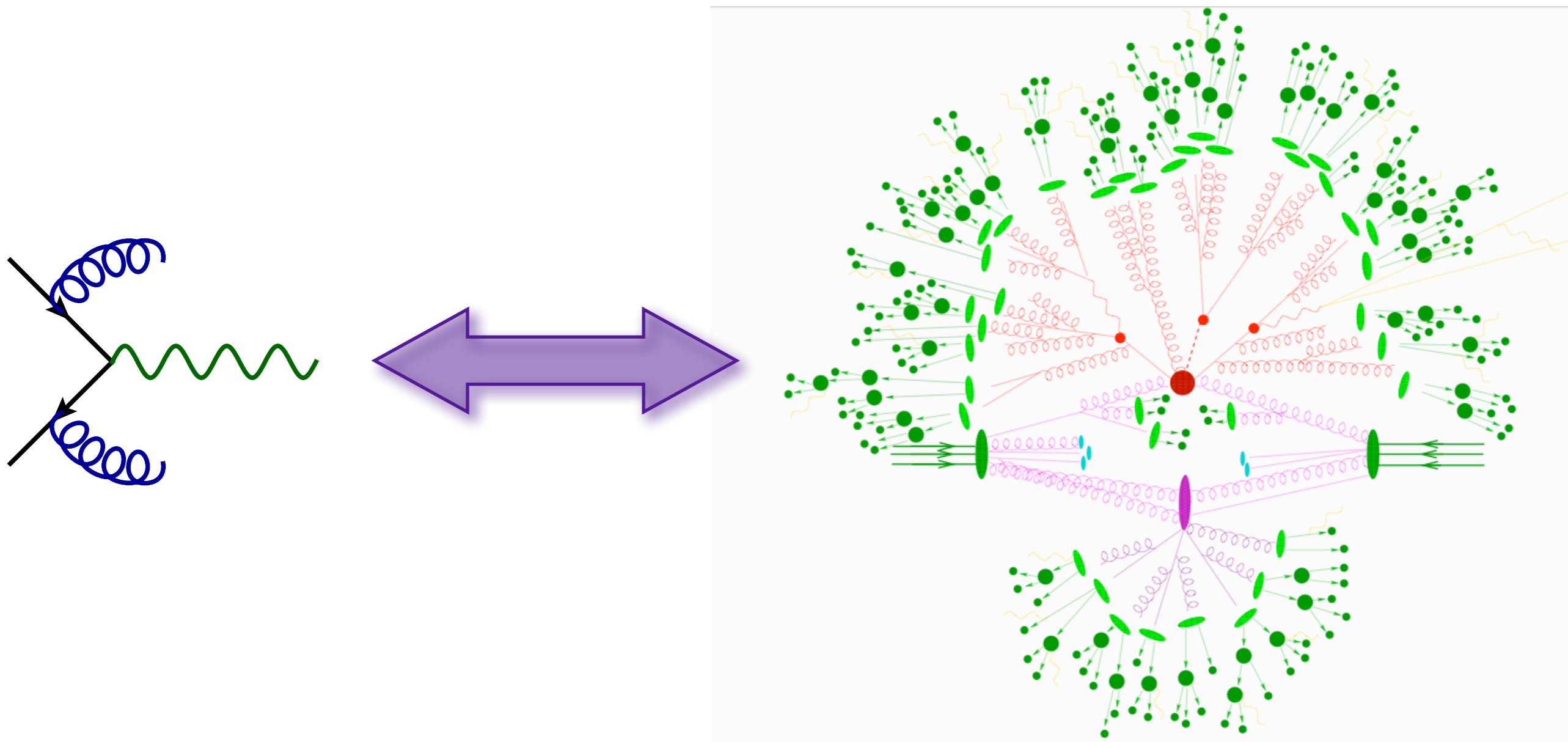

A parton shower program associates one of the possible histories (and pre-histories in case of pp collisions) of an hard event in an explicit and fully detailed way, such that the sum of the probabilities of all possible histories is unity.

# SHOWER STARTING SCALE

Varying the shower starting scale ('wimpy' or 'power') and the evolution parameter (' $Q^2$ ' or ' $p_T^2$ ') a whole range of predictions can be made:

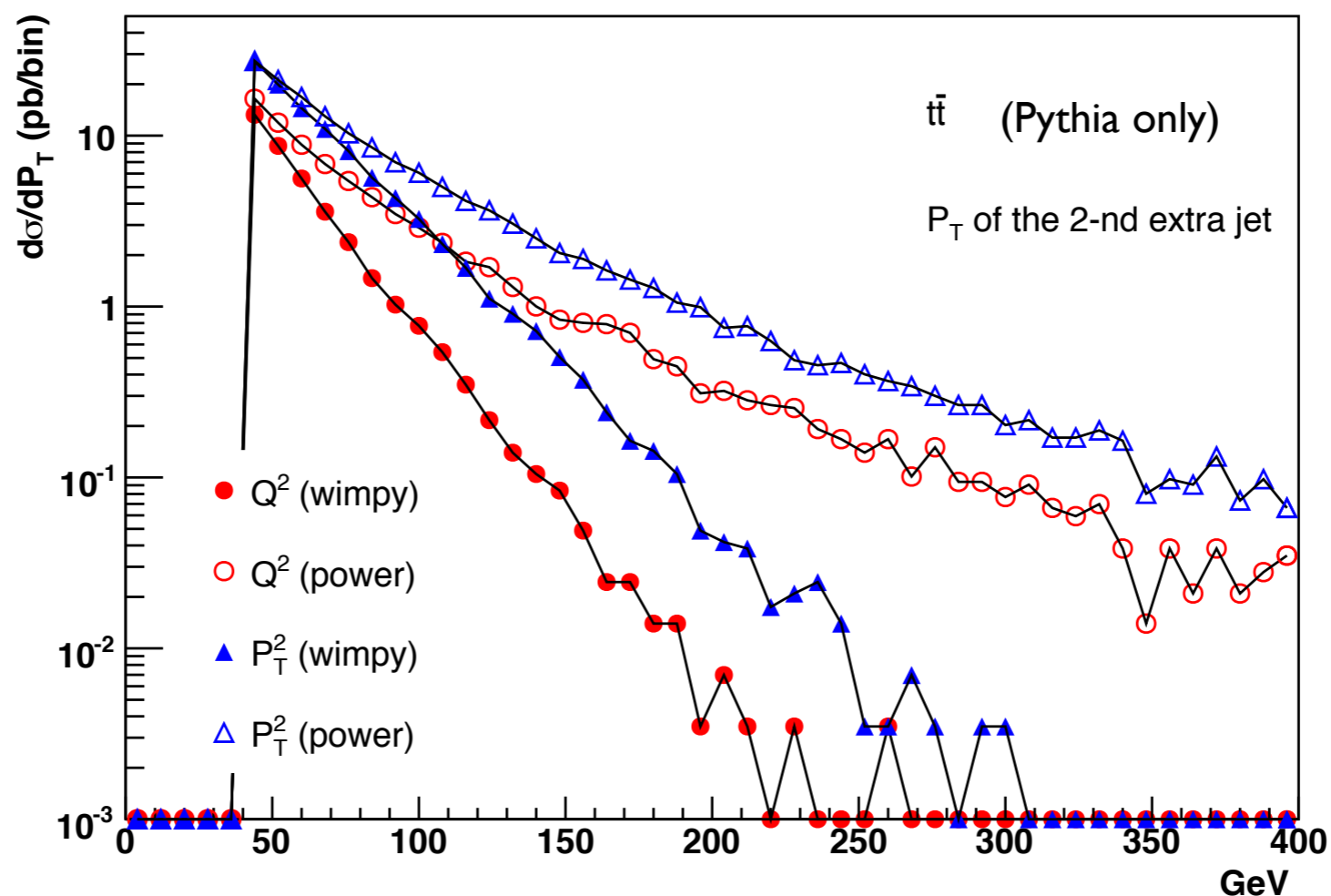

# SHOWER STARTING SCALE

Varying the shower starting scale ('wimpy' or 'power') and the evolution parameter (' $Q^2$ ' or ' $p_{T^2}$ ') a whole range of predictions can be made:

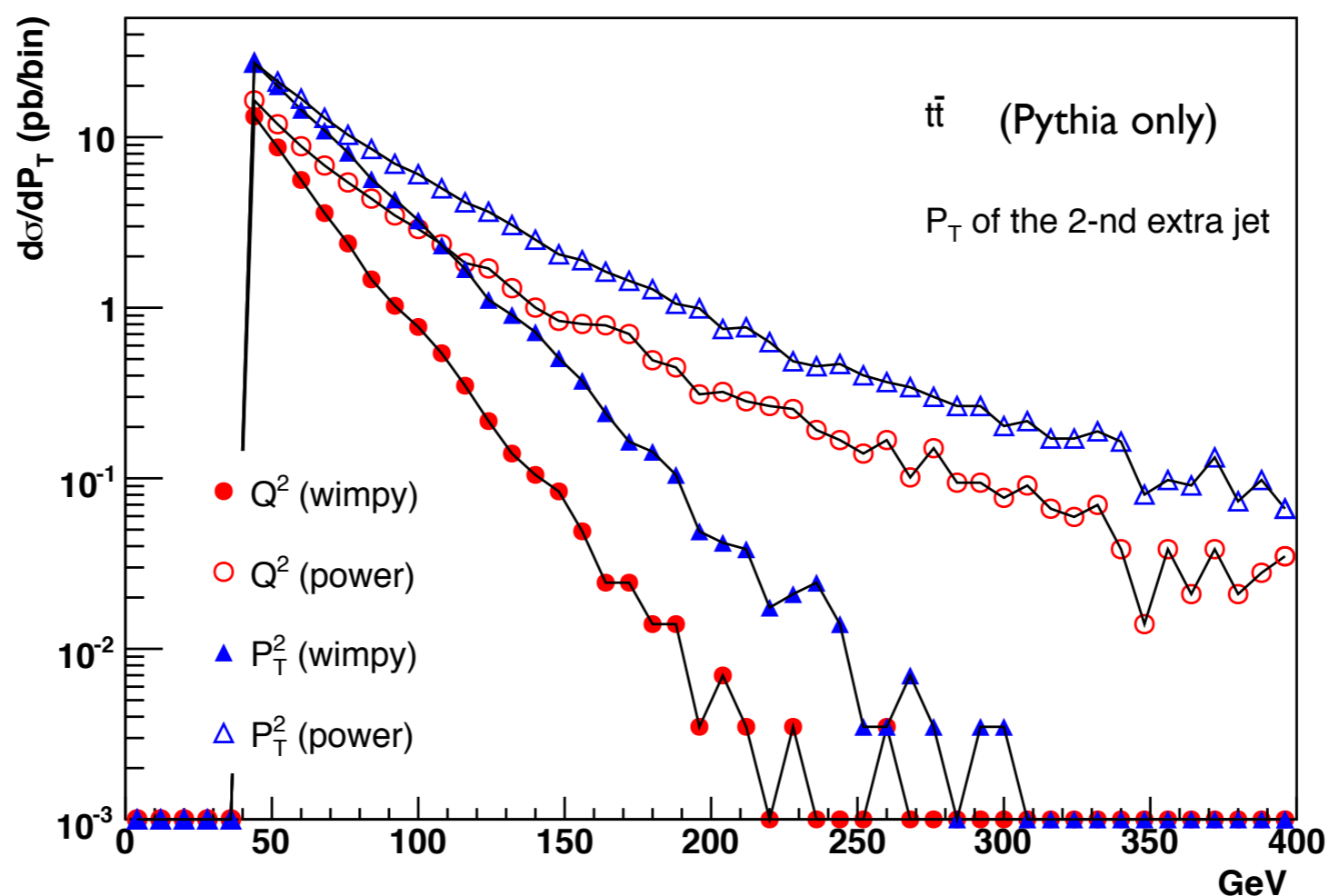

Ideal to describe the data: one can tune the parameters and fit it!  
 But is this really what we want...Does it work for other procs?

# PARTON SHOWER MC EVENT GENERATORS

A parton shower program associates one of the possible histories (and pre-histories in case of pp) of an hard event in an explicit and fully detailed way, such that the sum of the probabilities of all possible histories is unity.

# PARTON SHOWER MC EVENT GENERATORS

A parton shower program associates one of the possible histories (and pre-histories in case of pp) of an hard event in an explicit and fully detailed way, such that the sum of the probabilities of all possible histories is unity.

- General-purpose tools
- Always the first experimental choice
- Complete exclusive description of the events: hard scattering, showering & hadronization (and underlying event)
- Reliable and well-tuned tools
- Significant and intense progress in the development of new showering algorithms with the final aim to go at NLO in QCD



# PARTON SHOWER MC EVENT GENERATORS

A parton shower program associates one of the possible histories (and pre-histories in case of pp) of an hard event in an explicit and fully detailed way, such that the sum of the probabilities of all possible histories is unity.

- General-purpose tools
- Always the first experimental choice
- Complete exclusive description of the events: hard scattering, showering & hadronization (and underlying event)
- Reliable and well-tuned tools
- Significant and intense progress in the development of new showering algorithms with the final aim to go at NLO in QCD

**Shower MC Generators: PYTHIA, HERWIG, SHERPA**

# PARTON SHOWER : SUMMARY

- The parton shower dresses partons with radiation. This makes the inclusive parton-level predictions (i.e. inclusive over extra radiation) completely exclusive
  - In the soft and collinear limits the partons showers are exact, but in practice they are used outside this limit as well.
  - Partons showers are universal (i.e. independent from the process)
- There is a cut-off in the shower (below which we don't trust perturbative QCD) at which a hadronization model takes over
  - Hadronization models are universal and independent from the energy of the collision

# PLAN

- Basics : LO predictions and event generation
- Fixed-order calculations : from NLO to NNLO
- Exclusive predictions : Parton Shower
- Merging ME+PS
- Matching NLO with PS

# PREDICTIVE MC'S

- There are better ways to describe hard radiation: matrix elements!
- There are two ways to improve a Parton Shower Monte Carlo event generator with matrix elements:
  - ME+PS merging: Include matrix elements with more final state partons to describe hard, well-separated radiation better
  - NLO+PS matching: Include full NLO corrections to the matrix elements to reduce theoretical uncertainties in the matrix elements. The real-emission matrix elements will describe the hard radiation

# LIMITS OF THE FO CALCULATION

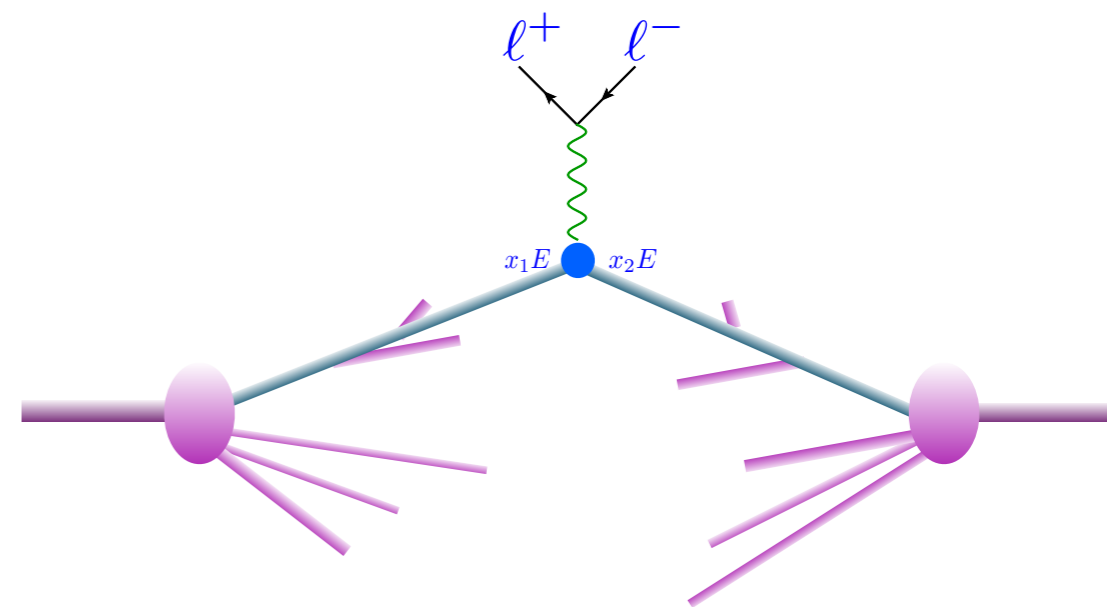
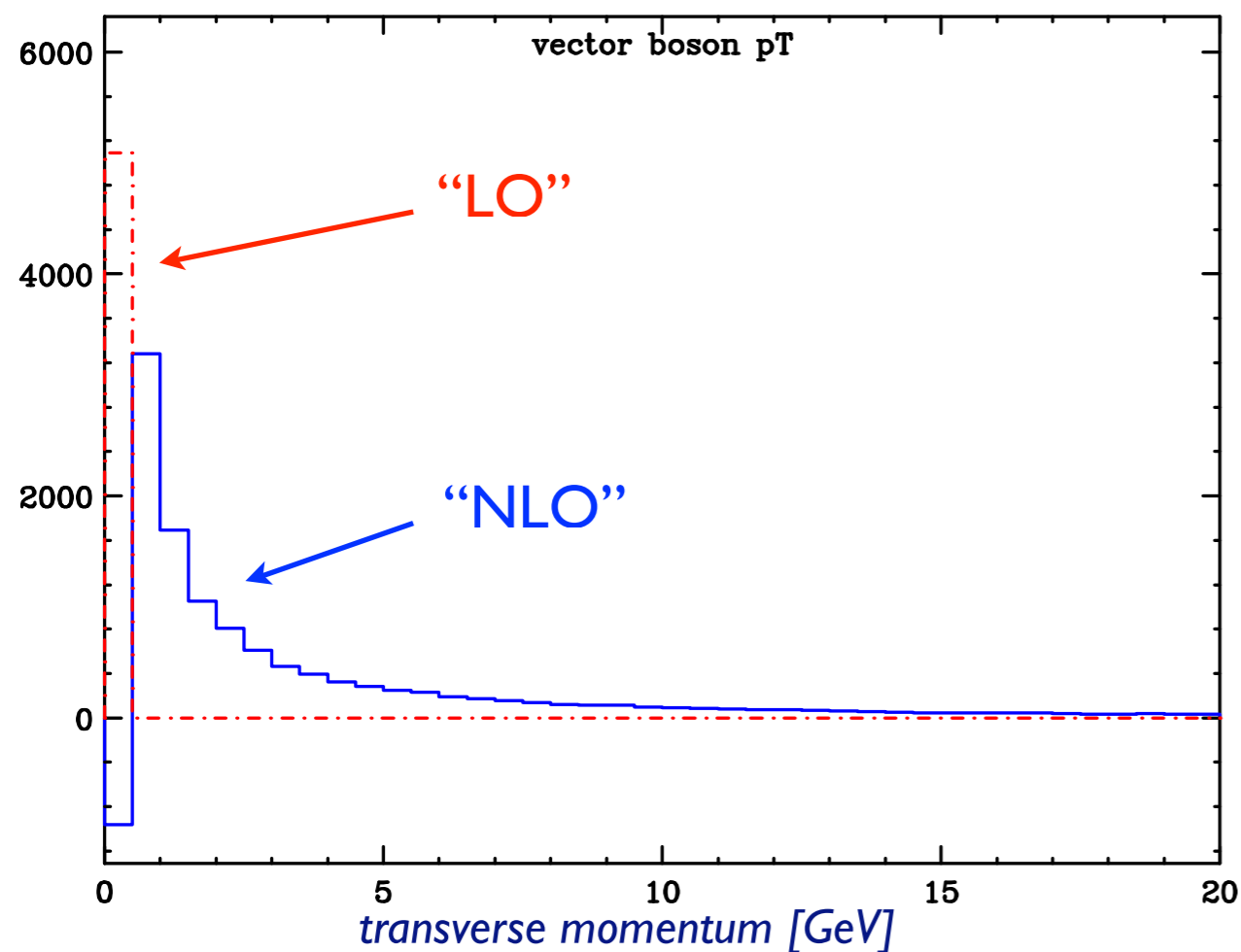

- Both the LO and the NLO distributions are non-physical
- Low-transverse momentum regions is very sensitive to emissions

# LIMITS OF THE PARTON SHOWER

In the soft-collinear approximation of Parton Shower MCs, parameters are used to tune the result  $\Rightarrow$  Large variation in results (small prediction power)

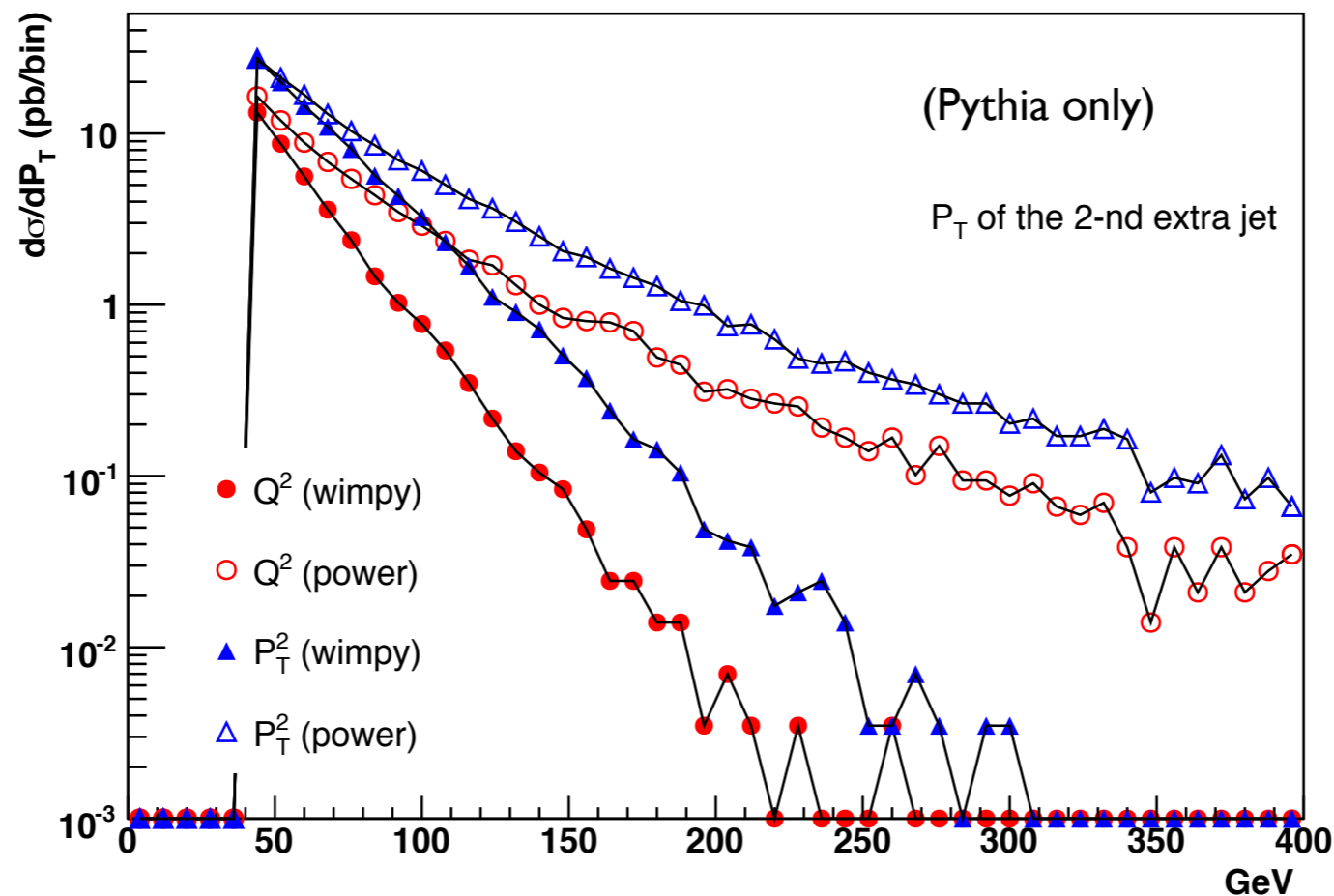

# GOAL FOR ME/PS MERGING

- Regularization of matrix element divergence
- Correction of the parton shower for large momenta
- Smooth jet distributions

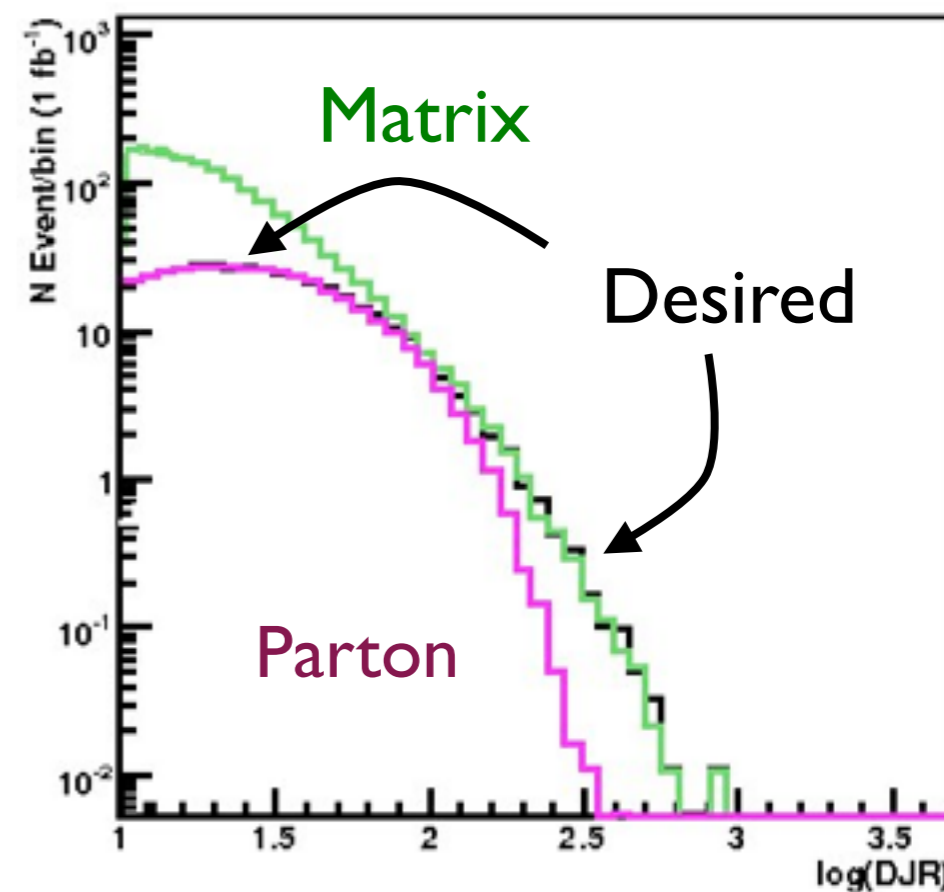
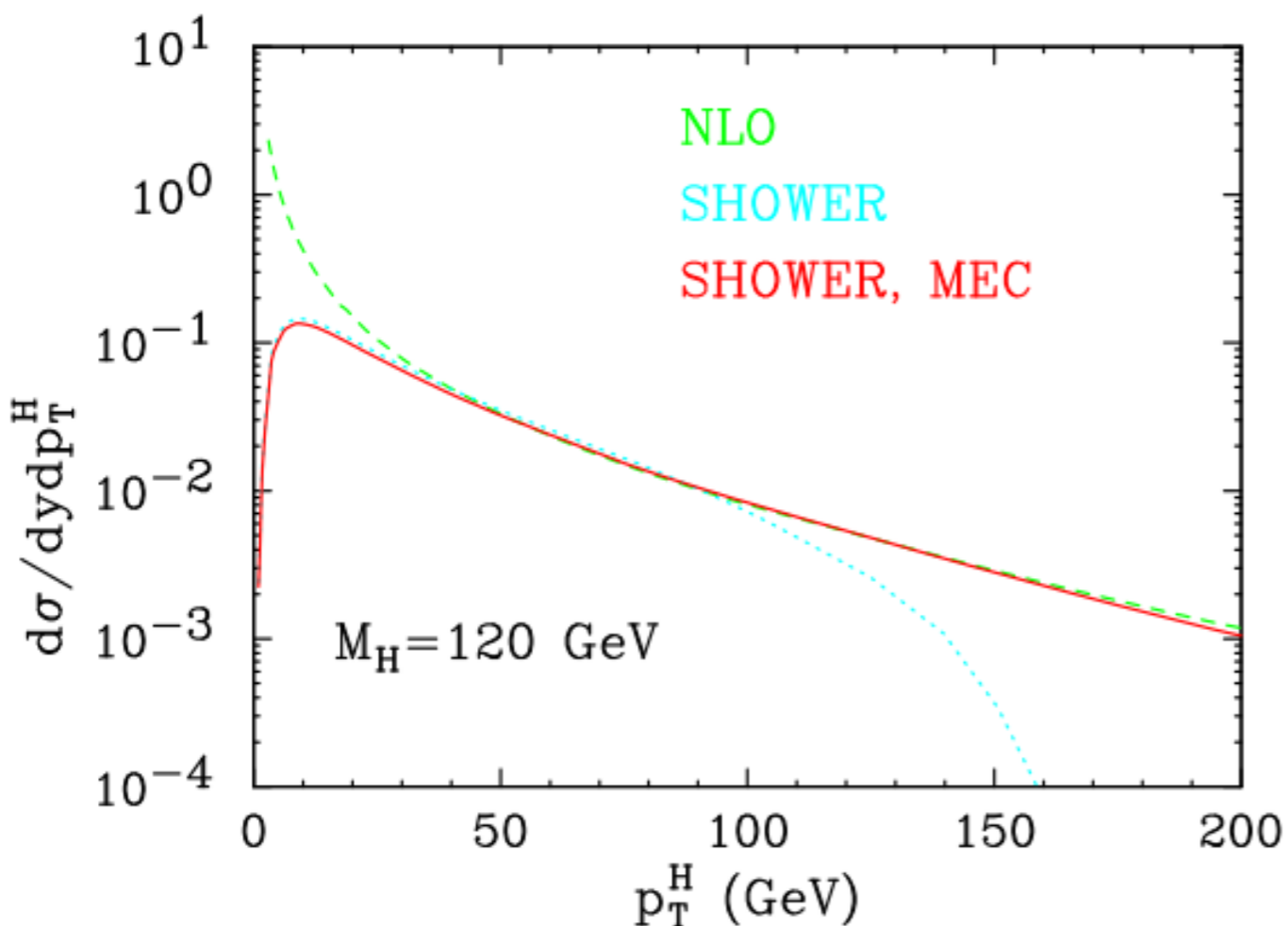

2nd OCD radiation jet in top pair

# MERGING ME+PS



# MATRIX ELEMENTS VS. PARTON SHOWERS

# MATRIX ELEMENTS VS. PARTON SHOWERS

ME

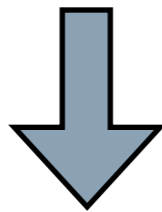

1. Fixed order calculation
2. Computationally expensive
3. Limited number of particles
4. Valid when partons are **hard and well separated**
5. Quantum interference correct
6. Needed for multi-jet description

# MATRIX ELEMENTS VS. PARTON SHOWERS

ME

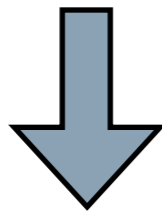

1. Fixed order calculation
2. Computationally expensive
3. Limited number of particles
4. Valid when partons are **hard and well separated**
5. Quantum interference correct
6. Needed for multi-jet description

Shower MC

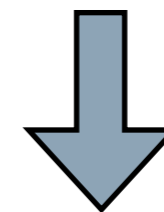

1. Resums logs to all orders
2. Computationally cheap
3. No limit on particle multiplicity
4. Valid when partons are **collinear and/or soft**
5. Partial interference through angular ordering
6. Needed for hadronization

# MATRIX ELEMENTS VS. PARTON SHOWERS

ME

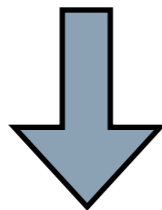

1. Fixed order calculation
2. Computationally expensive
3. Limited number of particles
4. Valid when partons are **hard and well separated**
5. Quantum interference correct
6. Needed for multi-jet description

Shower MC

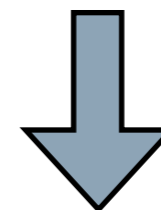

1. Resums logs to all orders
2. Computationally cheap
3. No limit on particle multiplicity
4. Valid when partons are **collinear and/or soft**
5. Partial interference through angular ordering
6. Needed for hadronization

Approaches are complementary: merge them!

# MATRIX ELEMENTS VS. PARTON SHOWERS

ME

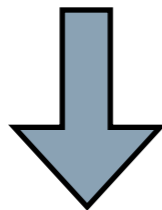

1. Fixed order calculation
2. Computationally expensive
3. Limited number of particles
4. Valid when partons are **hard and well separated**
5. Quantum interference correct
6. Needed for multi-jet description

Shower MC

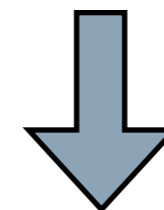

1. Resums logs to all orders
2. Computationally cheap
3. No limit on particle multiplicity
4. Valid when partons are **collinear and/or soft**
5. Partial interference through angular ordering
6. Needed for hadronization

**Approaches are complementary: merge them!**

Difficulty: avoid double counting, ensure smooth distributions

# POSSIBLE DOUBLE COUNTING

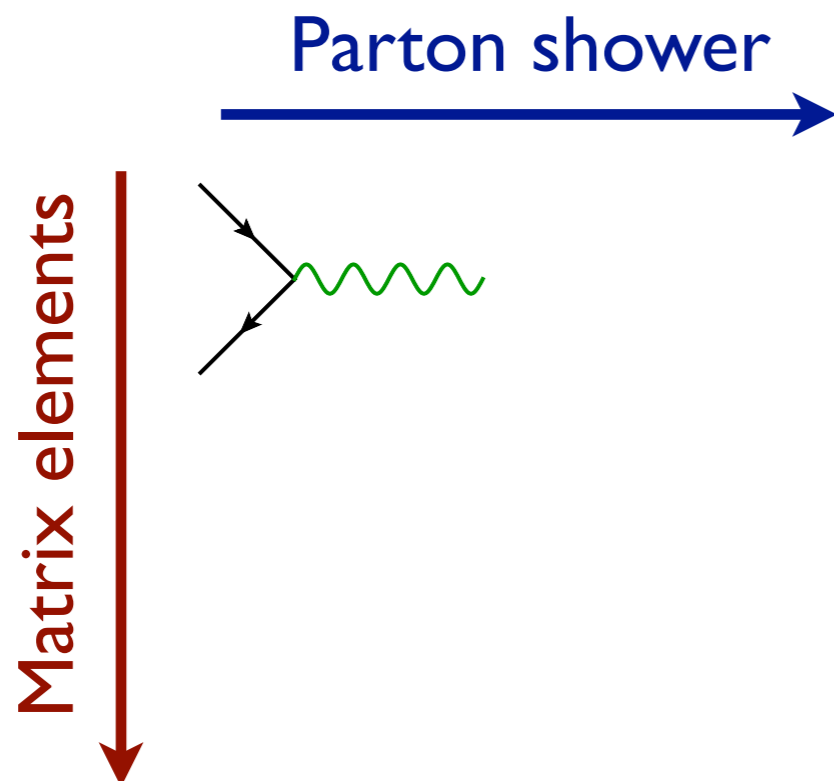

# POSSIBLE DOUBLE COUNTING

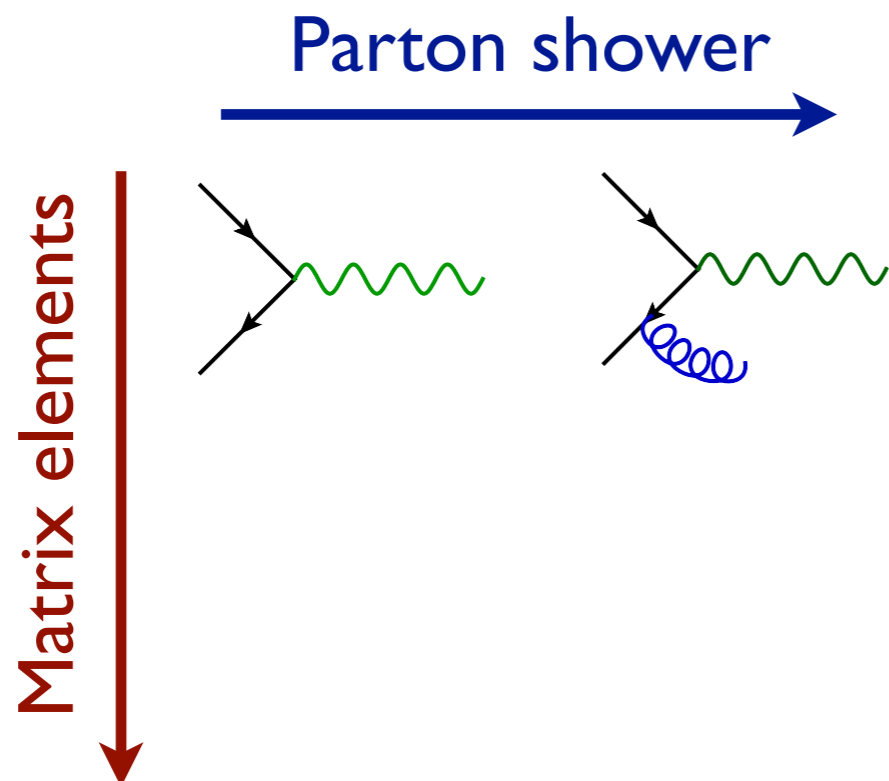

# POSSIBLE DOUBLE COUNTING

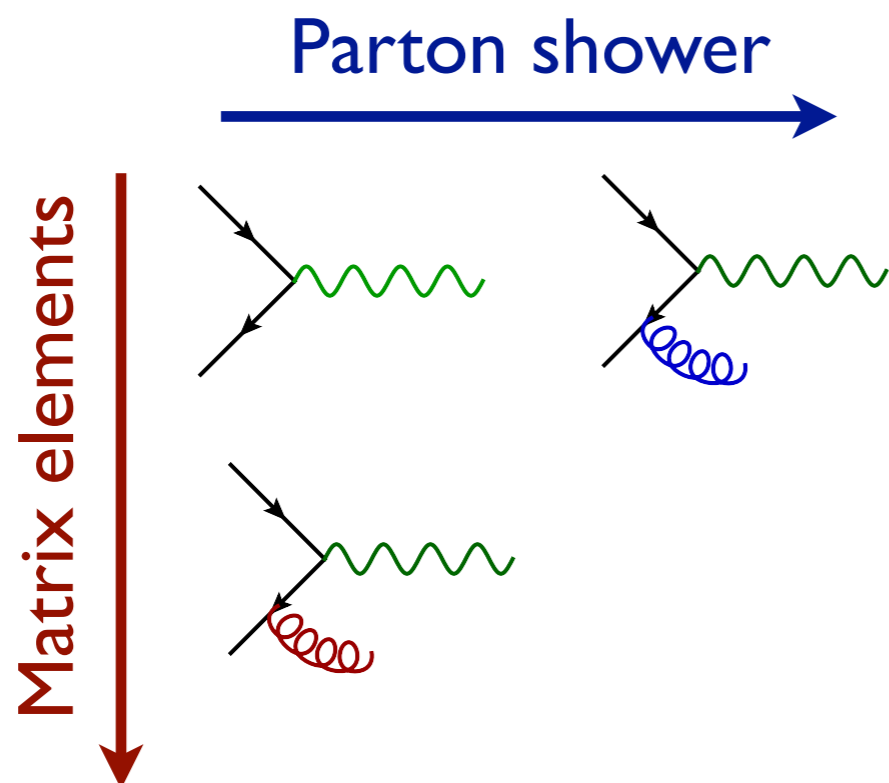



# POSSIBLE DOUBLE COUNTING

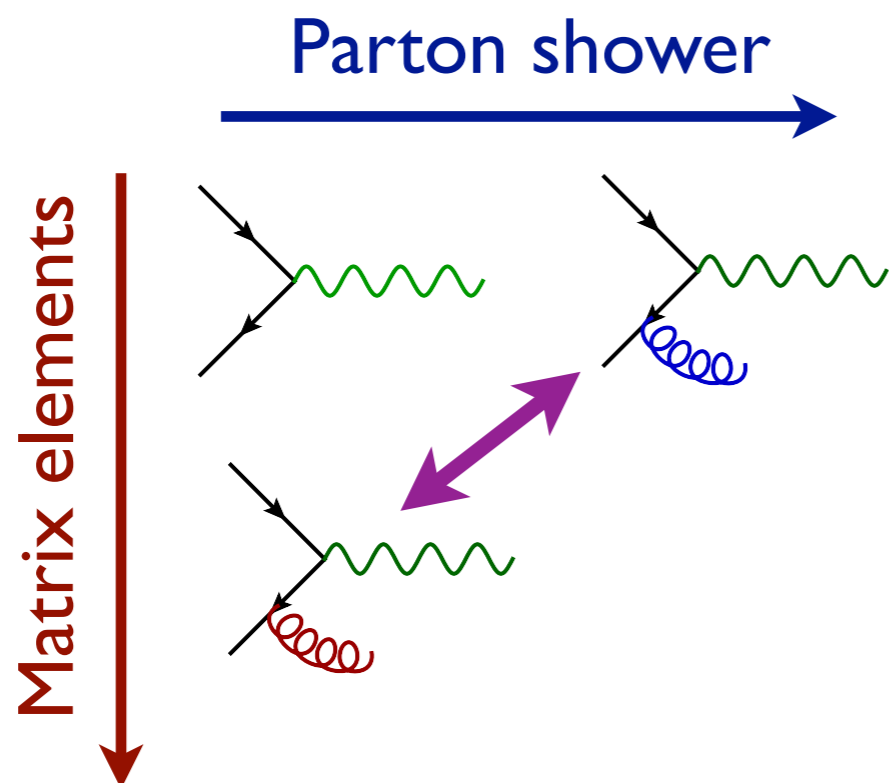

# POSSIBLE DOUBLE COUNTING

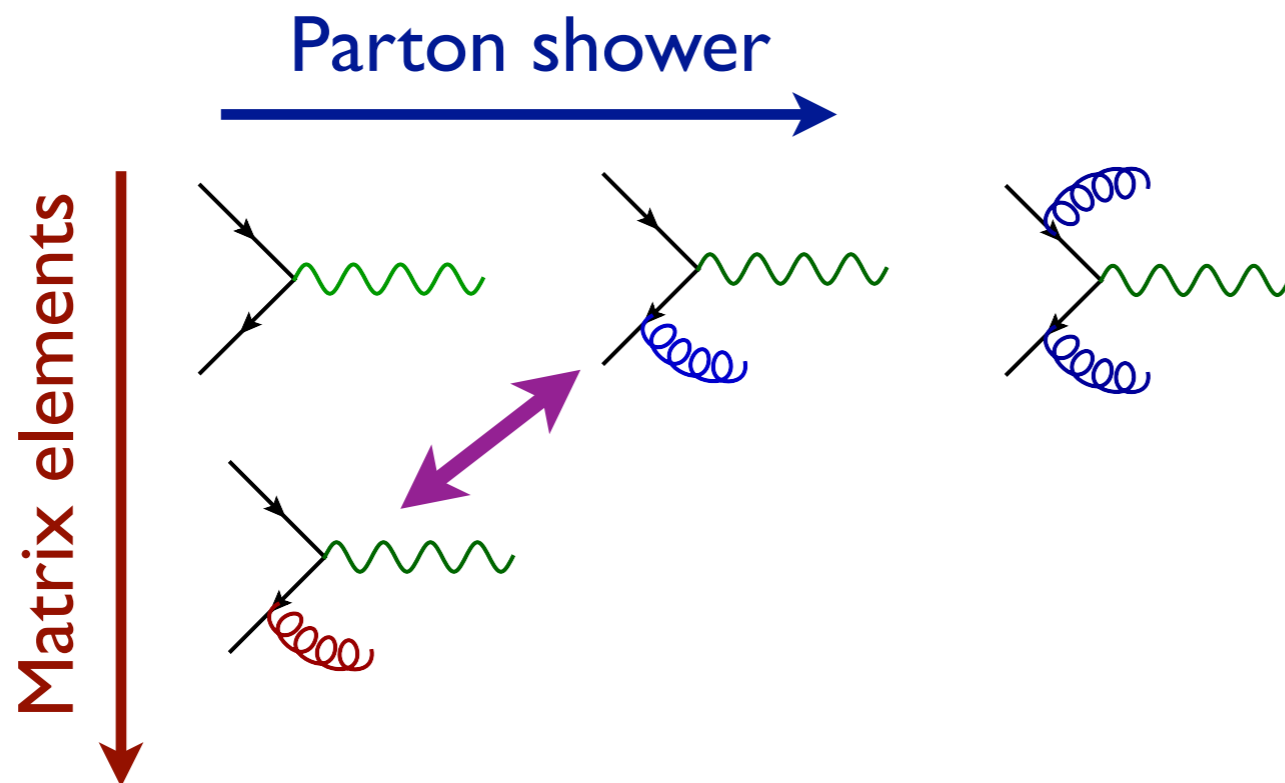

# POSSIBLE DOUBLE COUNTING

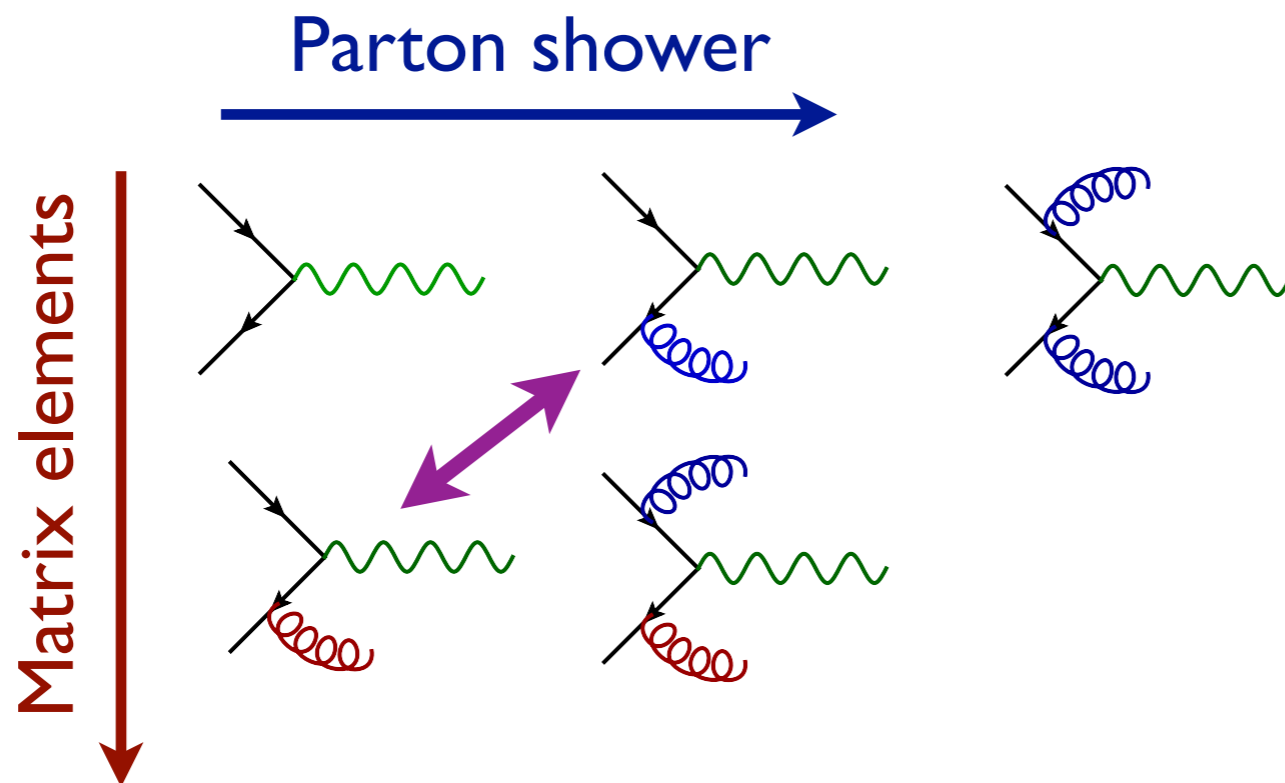

# POSSIBLE DOUBLE COUNTING

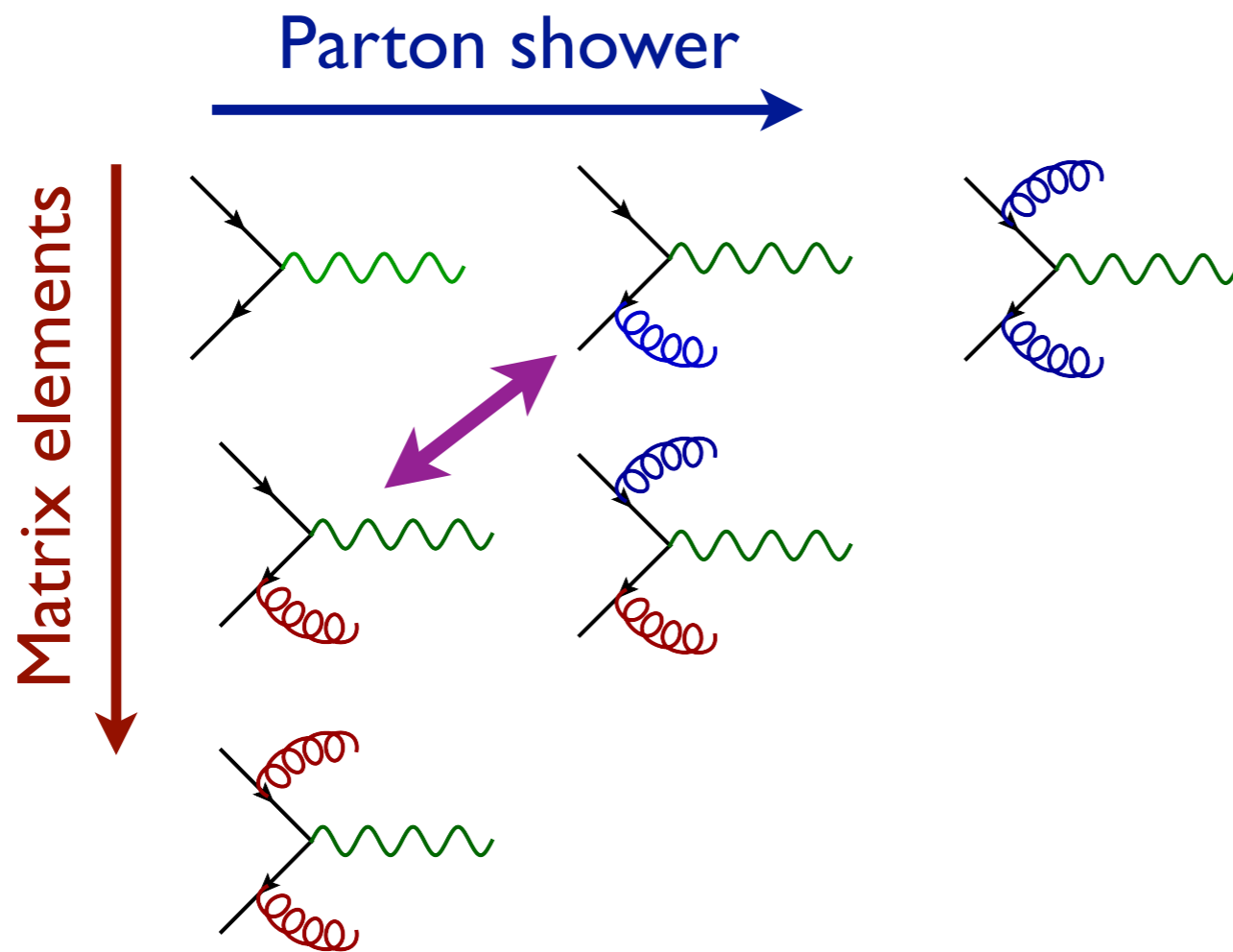

# POSSIBLE DOUBLE COUNTING

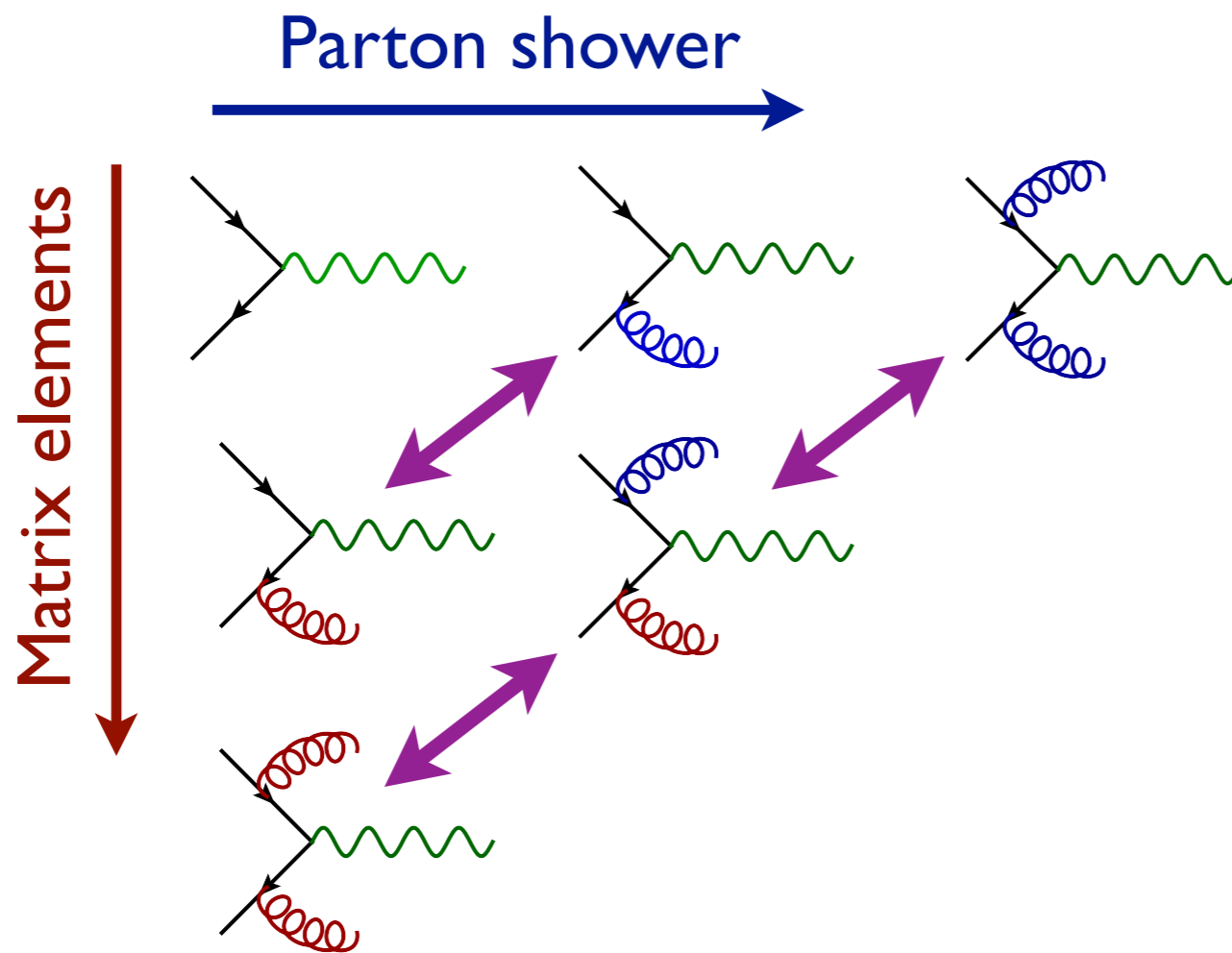

# POSSIBLE DOUBLE COUNTING

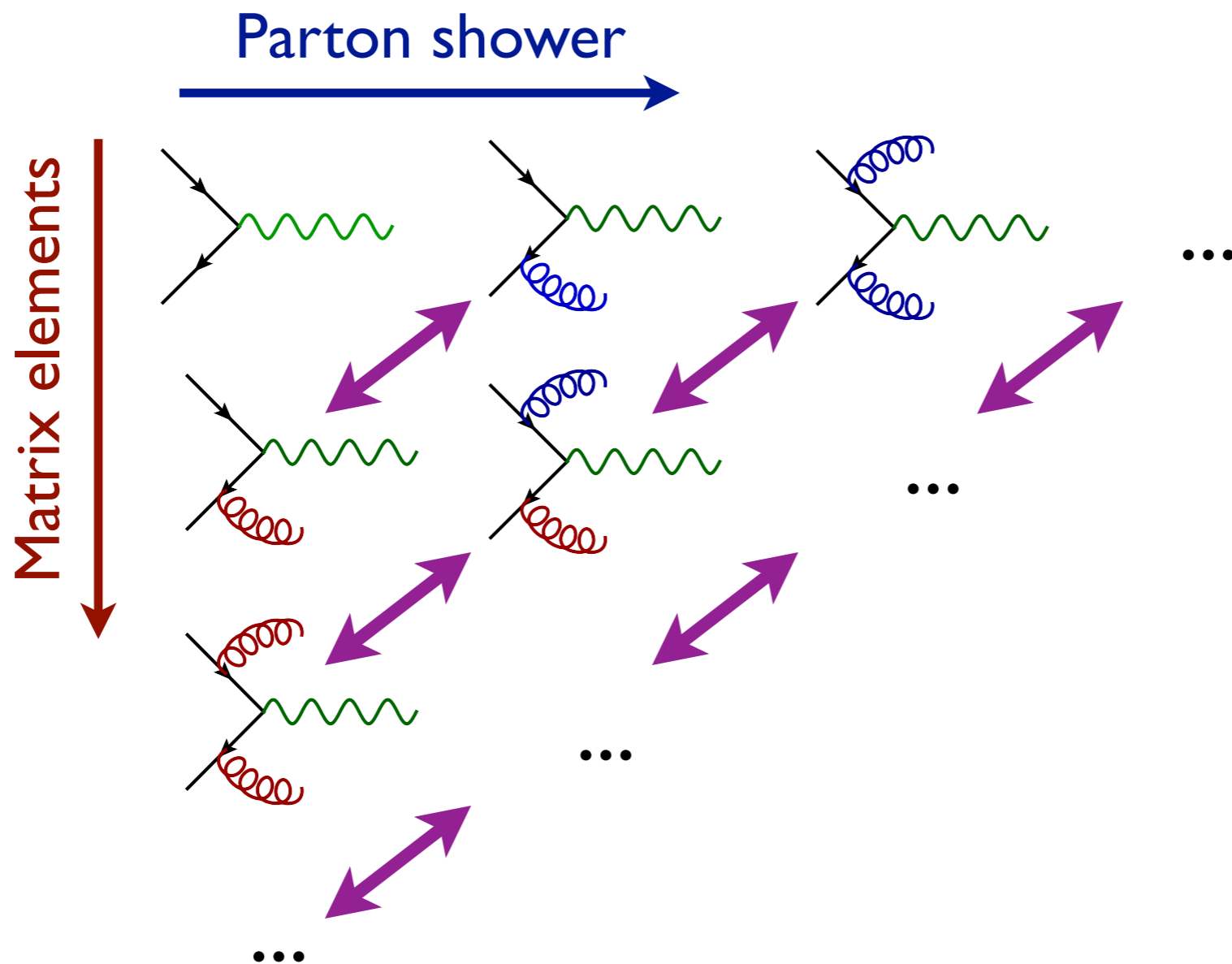

# POSSIBLE DOUBLE COUNTING

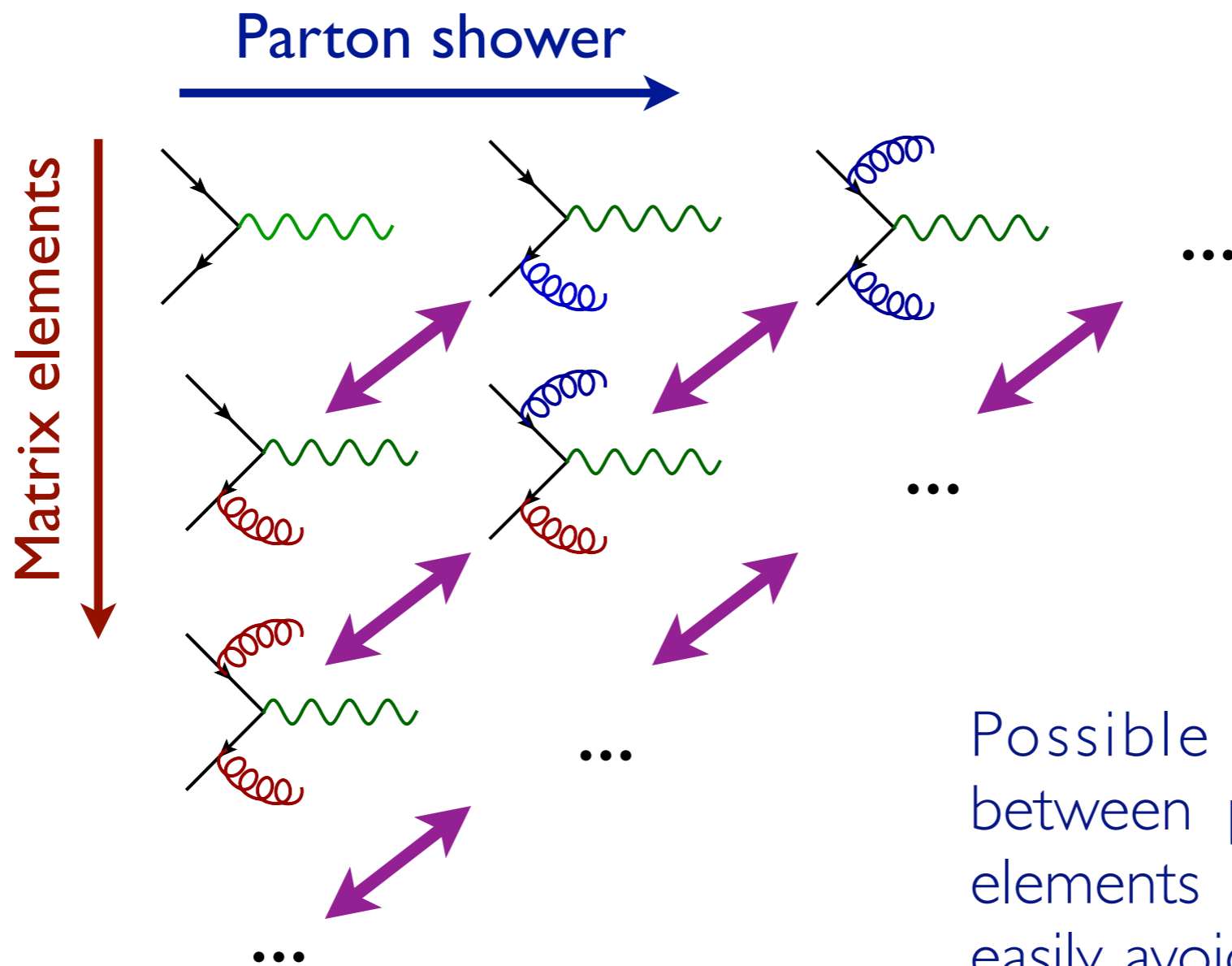

Possible double counting between partons from matrix elements and parton shower easily avoided by applying a cut in phase space





## MERGING ME WITH PS

- So double counting no problem, but what about getting smooth distributions that are independent of the precise value of  $Q^c$ ?
- Below cutoff, distribution is given by PS
  - need to make ME look like PS near cutoff
- Let's take another look at the PS

# MERGING ME WITH PS

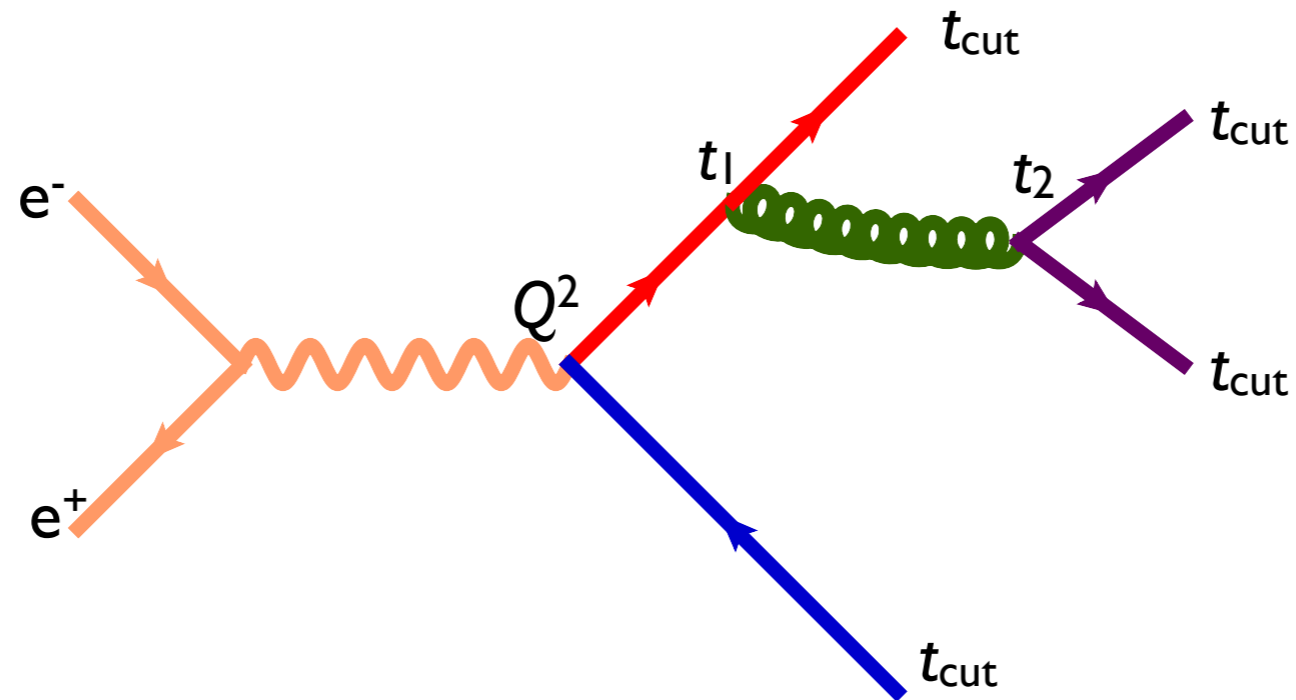

- How does the PS generate the configuration above (i.e. starting from  $e^+e^- \rightarrow qq\bar{q}$  events)?
- Probability for the splitting at  $t_1$  is given by

$$(\Delta_q(Q^2, t_1))^2 \frac{\alpha_s(t_1)}{2\pi} P_{gq}(z)$$

and for the whole tree (remember  $\Delta(A,B) = \Delta(A,C) \Delta(C,B)$ )

$$(\Delta_q(Q^2, t_{\text{cut}}))^2 \Delta_g(t_1, t_2) (\Delta_q(t_2, t_{\text{cut}}))^2 \frac{\alpha_s(t_1)}{2\pi} P_{gq}(z) \frac{\alpha_s(t_2)}{2\pi} P_{qg}(z')$$

# MERGING ME WITH PS

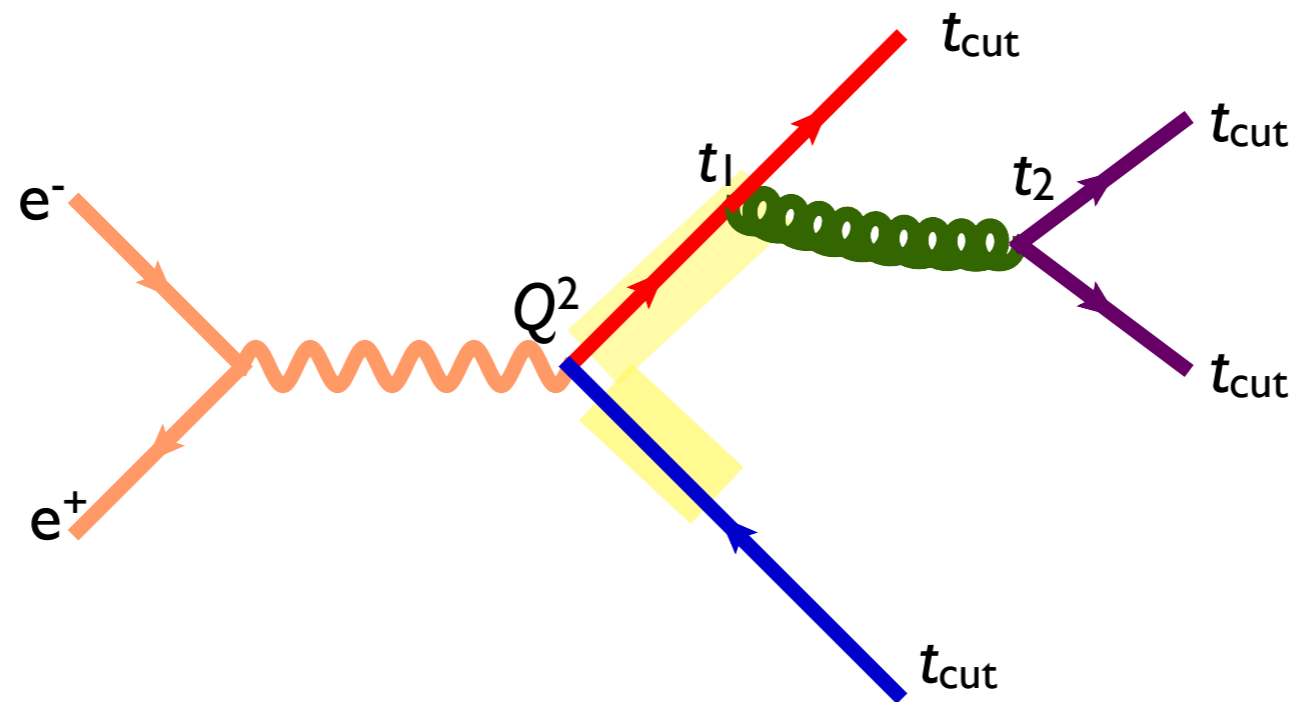

- How does the PS generate the configuration above (i.e. starting from  $e^+e^- \rightarrow qq\bar{q}$  events)?
- Probability for the splitting at  $t_1$  is given by

$$(\Delta_q(Q^2, t_1))^2 \frac{\alpha_s(t_1)}{2\pi} P_{gq}(z)$$

and for the whole tree (remember  $\Delta(A,B) = \Delta(A,C) \Delta(C,B)$ )

$$(\Delta_q(Q^2, t_{\text{cut}}))^2 \Delta_g(t_1, t_2) (\Delta_q(t_2, t_{\text{cut}}))^2 \frac{\alpha_s(t_1)}{2\pi} P_{gq}(z) \frac{\alpha_s(t_2)}{2\pi} P_{qg}(z')$$

# MERGING ME WITH PS

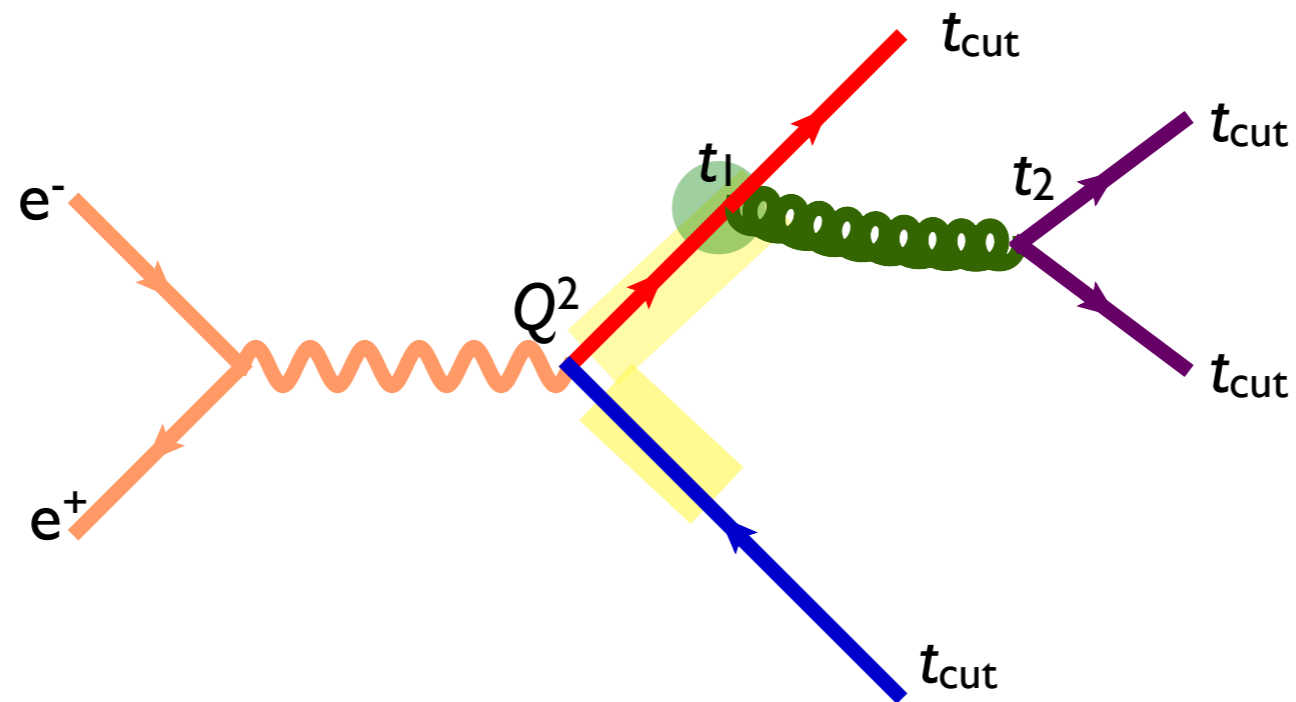

- How does the PS generate the configuration above (i.e. starting from  $e^+e^- \rightarrow qq\bar{q}$  events)?
- Probability for the splitting at  $t_1$  is given by

$$(\Delta_q(Q^2, t_1))^2 \frac{\alpha_s(t_1)}{2\pi} P_{gq}(z)$$

and for the whole tree (remember  $\Delta(A,B) = \Delta(A,C) \Delta(C,B)$  )

$$(\Delta_q(Q^2, t_{\text{cut}}))^2 \Delta_g(t_1, t_2) (\Delta_q(t_2, t_{\text{cut}}))^2 \frac{\alpha_s(t_1)}{2\pi} P_{gq}(z) \frac{\alpha_s(t_2)}{2\pi} P_{qg}(z')$$

# MERGING ME WITH PS

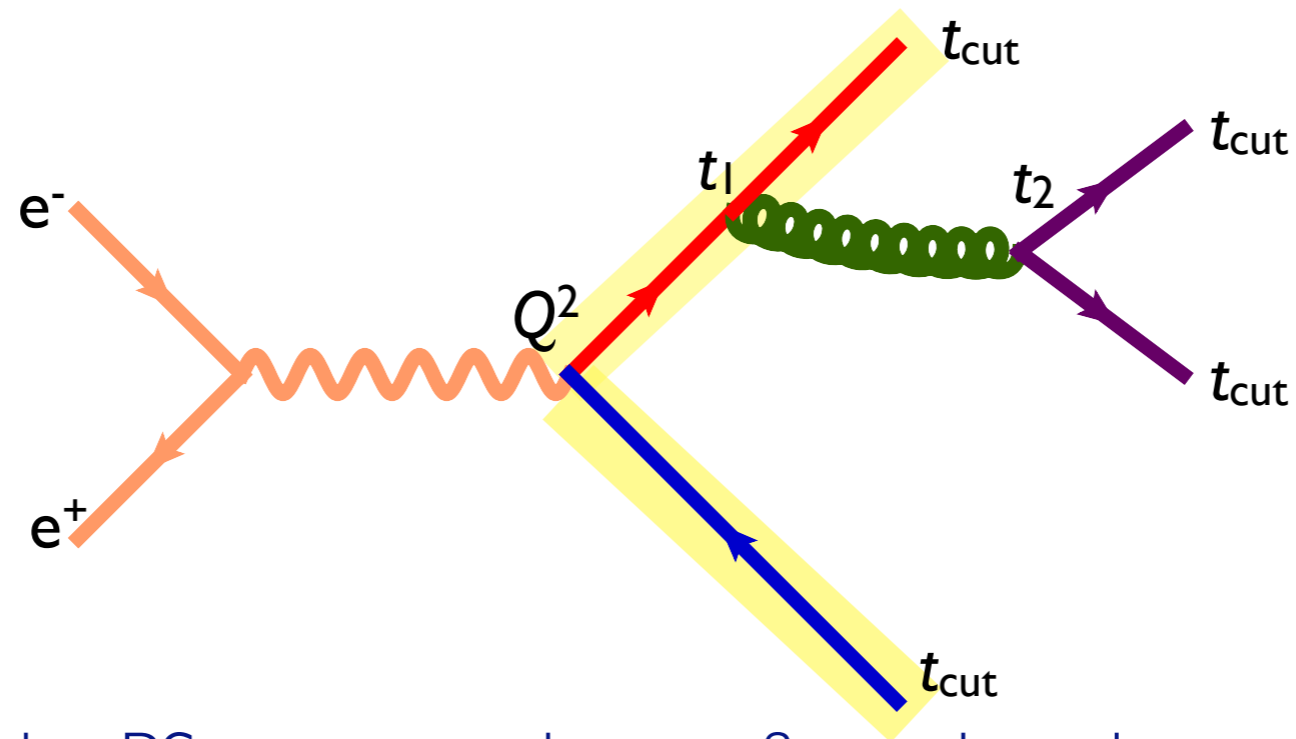

- How does the PS generate the configuration above (i.e. starting from  $e^+e^- \rightarrow qq\bar{q}$  events)?
- Probability for the splitting at  $t_1$  is given by

$$(\Delta_q(Q^2, t_1))^2 \frac{\alpha_s(t_1)}{2\pi} P_{gq}(z)$$

and for the whole tree (remember  $\Delta(A,B) = \Delta(A,C) \Delta(C,B)$  )

$$(\Delta_q(Q^2, t_{\text{cut}}))^2 \Delta_g(t_1, t_2) (\Delta_q(t_2, t_{\text{cut}}))^2 \frac{\alpha_s(t_1)}{2\pi} P_{gq}(z) \frac{\alpha_s(t_2)}{2\pi} P_{qg}(z')$$

# MERGING ME WITH PS

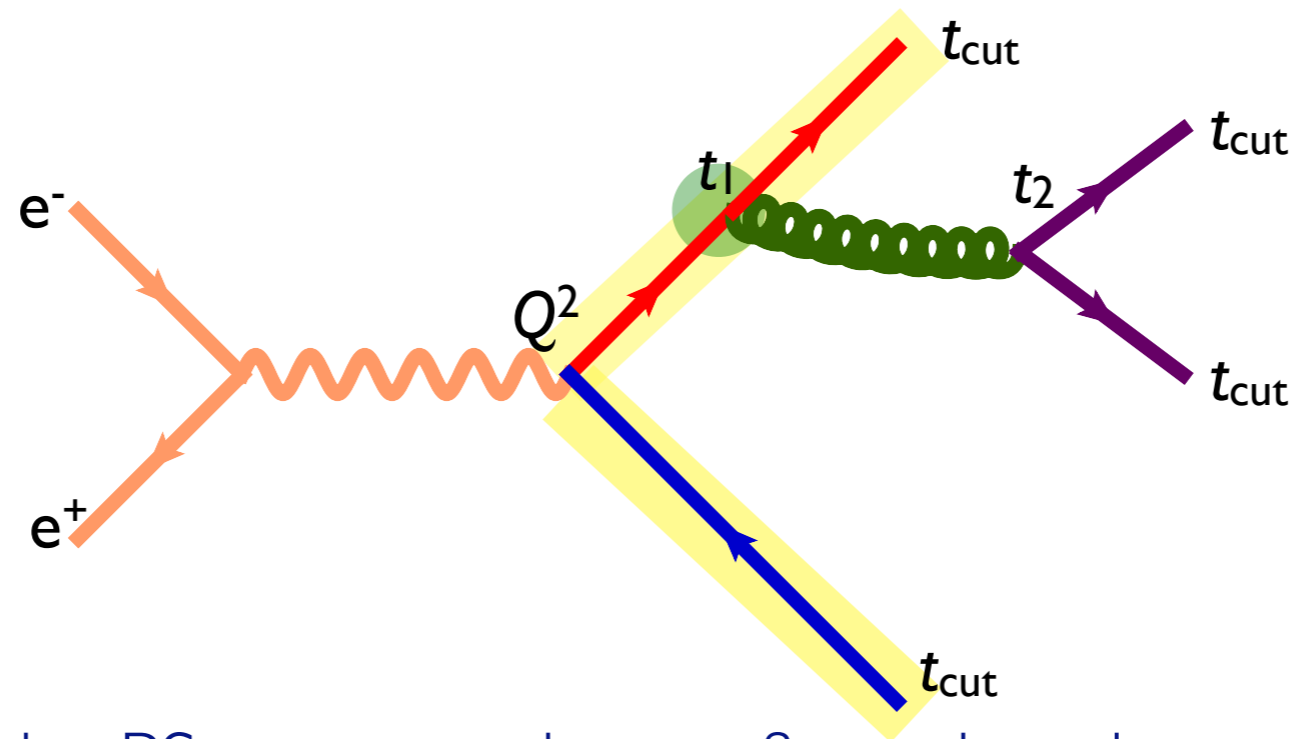

- How does the PS generate the configuration above (i.e. starting from  $e^+e^- \rightarrow qq\bar{q}$  events)?
- Probability for the splitting at  $t_1$  is given by

$$(\Delta_q(Q^2, t_1))^2 \frac{\alpha_s(t_1)}{2\pi} P_{gq}(z)$$

and for the whole tree (remember  $\Delta(A,B) = \Delta(A,C) \Delta(C,B)$ )

$$(\Delta_q(Q^2, t_{\text{cut}}))^2 \Delta_g(t_1, t_2) (\Delta_q(t_2, t_{\text{cut}}))^2 \frac{\alpha_s(t_1)}{2\pi} P_{gq}(z) \frac{\alpha_s(t_2)}{2\pi} P_{qg}(z')$$

# MERGING ME WITH PS

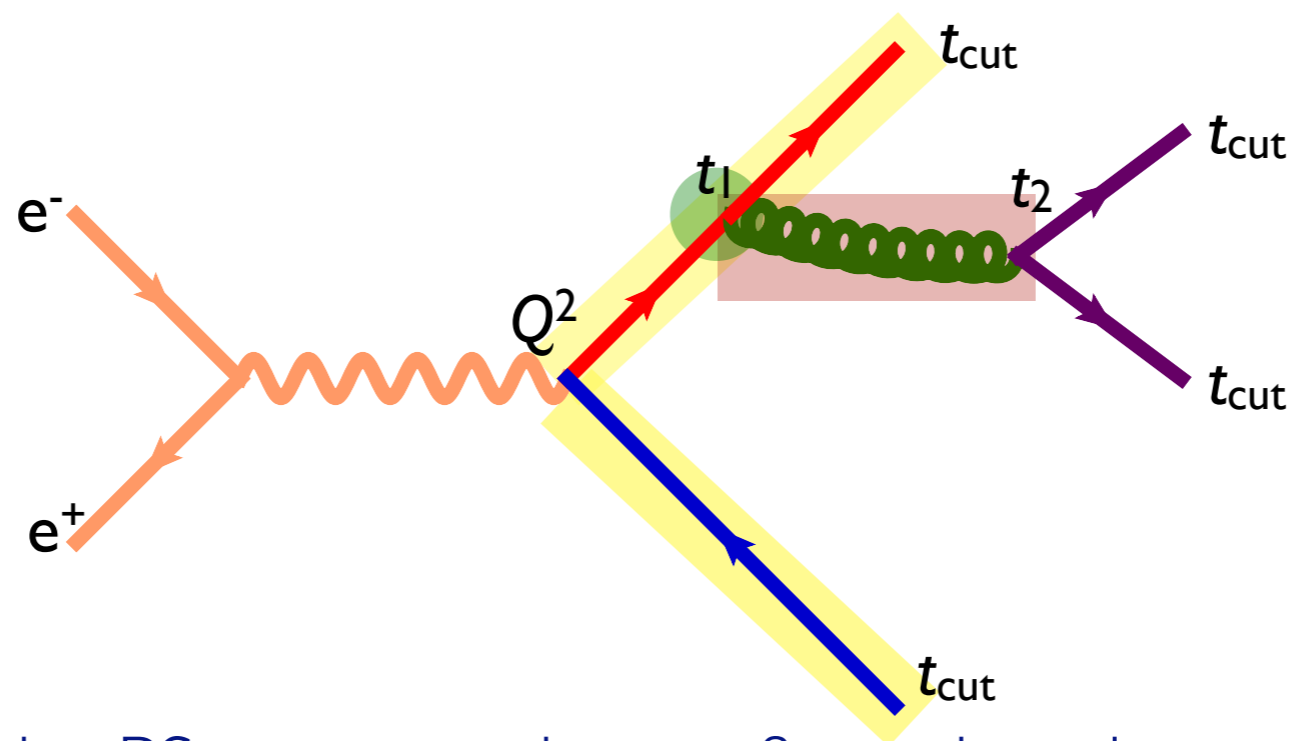

- How does the PS generate the configuration above (i.e. starting from  $e^+e^- \rightarrow qq\bar{q}$  events)?
- Probability for the splitting at  $t_1$  is given by

$$(\Delta_q(Q^2, t_1))^2 \frac{\alpha_s(t_1)}{2\pi} P_{gq}(z)$$

and for the whole tree (remember  $\Delta(A,B) = \Delta(A,C) \Delta(C,B)$ )

$$(\Delta_q(Q^2, t_{\text{cut}}))^2 \Delta_g(t_1, t_2) (\Delta_q(t_2, t_{\text{cut}}))^2 \frac{\alpha_s(t_1)}{2\pi} P_{gq}(z) \frac{\alpha_s(t_2)}{2\pi} P_{qg}(z')$$

# MERGING ME WITH PS

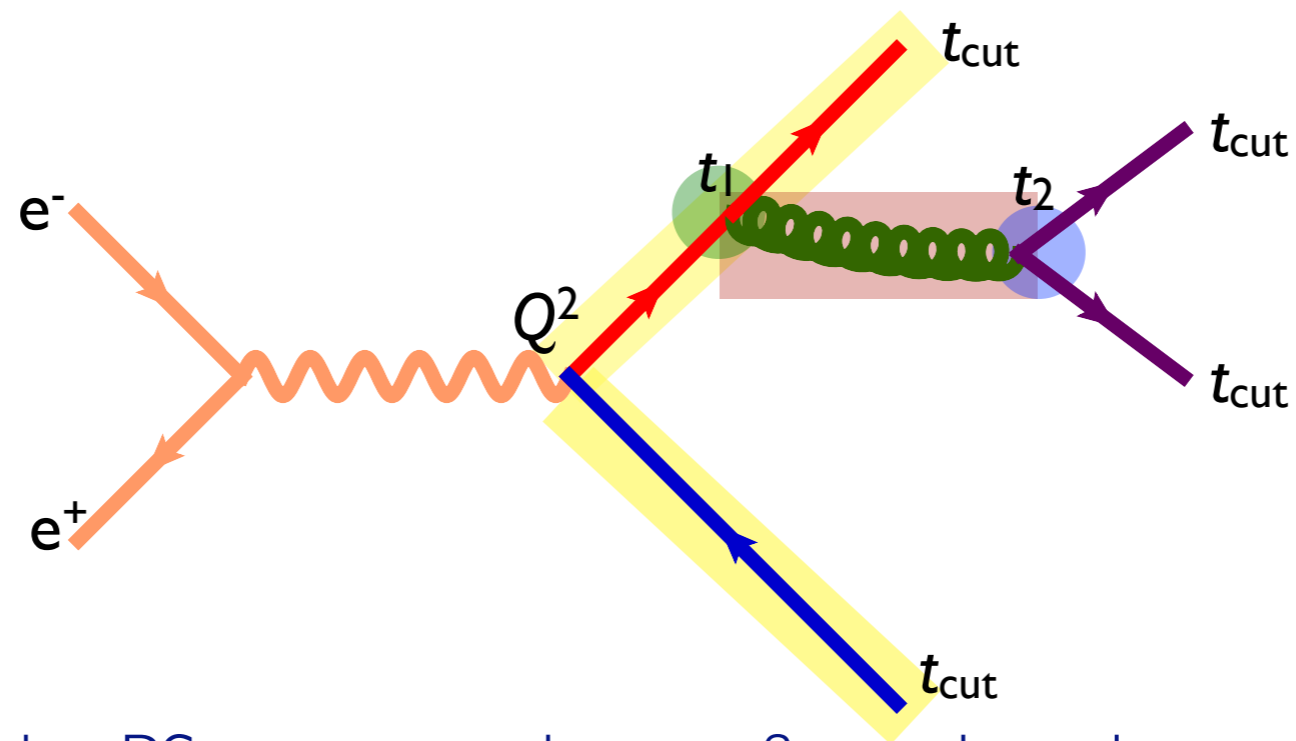

- How does the PS generate the configuration above (i.e. starting from  $e^+e^- \rightarrow qq\bar{q}$  events)?
- Probability for the splitting at  $t_1$  is given by

$$(\Delta_q(Q^2, t_1))^2 \frac{\alpha_s(t_1)}{2\pi} P_{gq}(z)$$

and for the whole tree (remember  $\Delta(A,B) = \Delta(A,C) \Delta(C,B)$ )

$$(\Delta_q(Q^2, t_{\text{cut}}))^2 \Delta_g(t_1, t_2) (\Delta_q(t_2, t_{\text{cut}}))^2 \frac{\alpha_s(t_1)}{2\pi} P_{gq}(z) \frac{\alpha_s(t_2)}{2\pi} P_{qg}(z')$$



# MERGING ME WITH PS

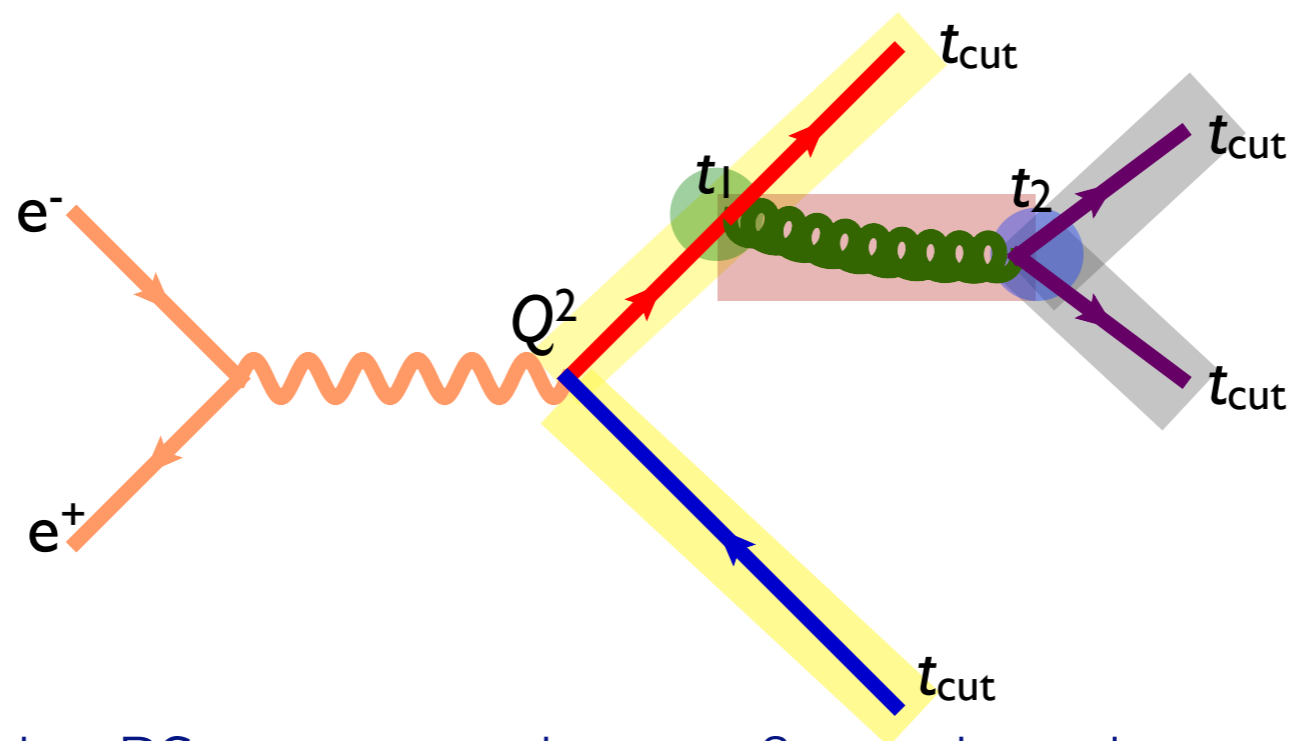

- How does the PS generate the configuration above (i.e. starting from  $e^+e^- \rightarrow qq\bar{q}$  events)?
- Probability for the splitting at  $t_1$  is given by

$$(\Delta_q(Q^2, t_1))^2 \frac{\alpha_s(t_1)}{2\pi} P_{gq}(z)$$

and for the whole tree (remember  $\Delta(A,B) = \Delta(A,C) \Delta(C,B)$  )

$$(\Delta_q(Q^2, t_{\text{cut}}))^2 \Delta_g(t_1, t_2) (\Delta_q(t_2, t_{\text{cut}}))^2 \frac{\alpha_s(t_1)}{2\pi} P_{gq}(z) \frac{\alpha_s(t_2)}{2\pi} P_{qg}(z')$$

# MERGING ME WITH PS

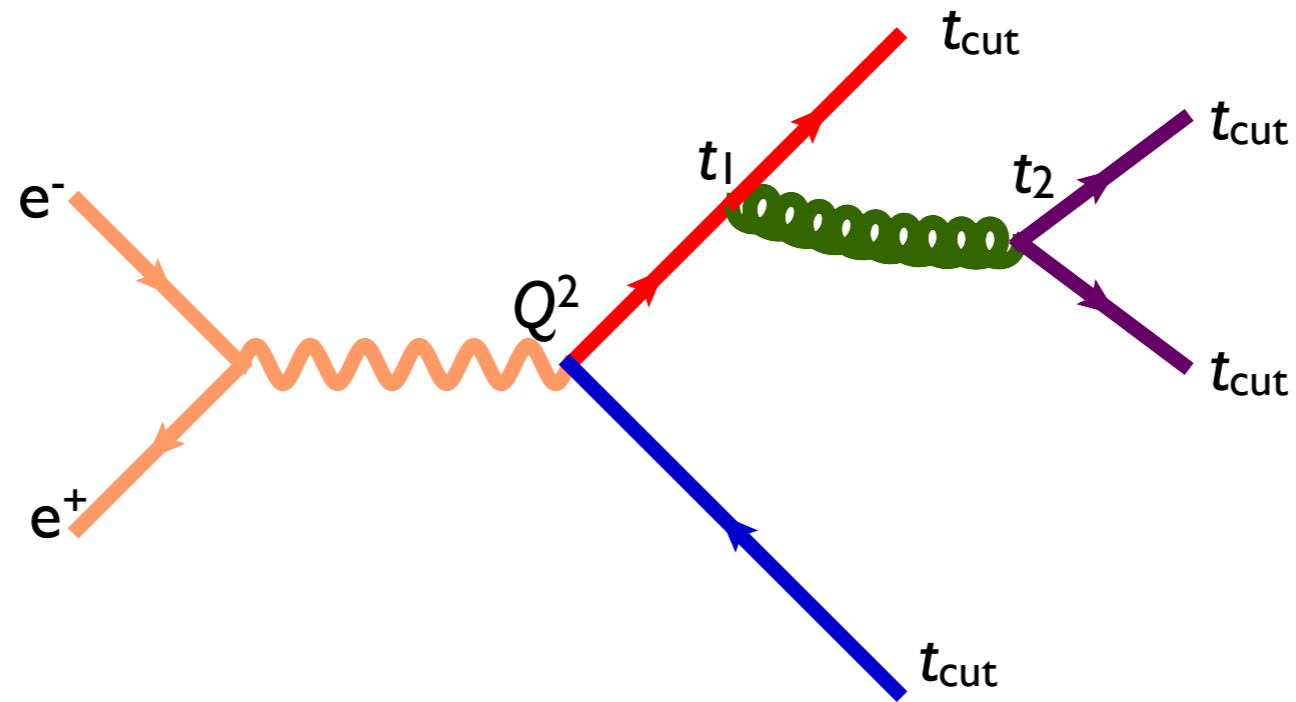

$$(\Delta_q(Q^2, t_{\text{cut}}))^2 \Delta_g(t_1, t_2) (\Delta_q(t_2, t_{\text{cut}}))^2 \frac{\alpha_s(t_1)}{2\pi} P_{gq}(z) \frac{\alpha_s(t_2)}{2\pi} P_{qg}(z')$$

# MERGING ME WITH PS

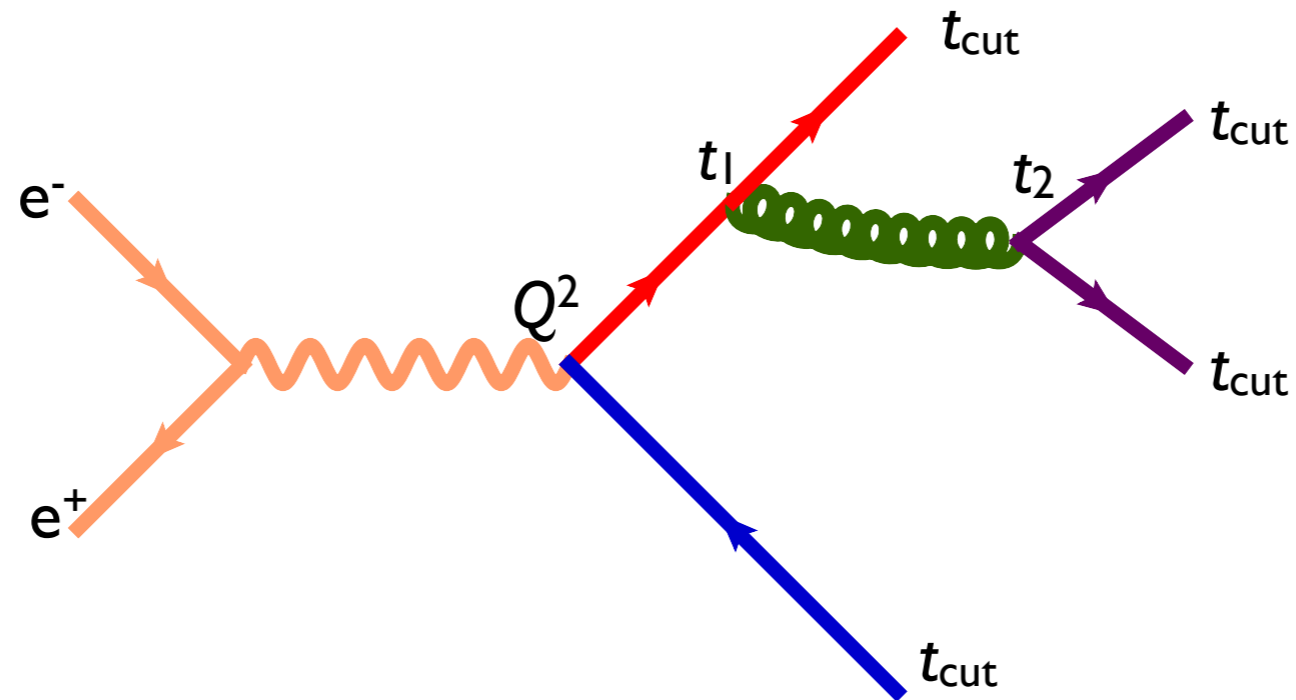

$$(\Delta_q(Q^2, t_{\text{cut}}))^2 \Delta_g(t_1, t_2) (\Delta_q(t_2, t_{\text{cut}}))^2 \frac{\alpha_s(t_1)}{2\pi} P_{gq}(z) \frac{\alpha_s(t_2)}{2\pi} P_{qg}(z')$$

Corresponds to the matrix element  
 BUT with  $\alpha_s$  evaluated at the scale of each splitting

# MERGING ME WITH PS

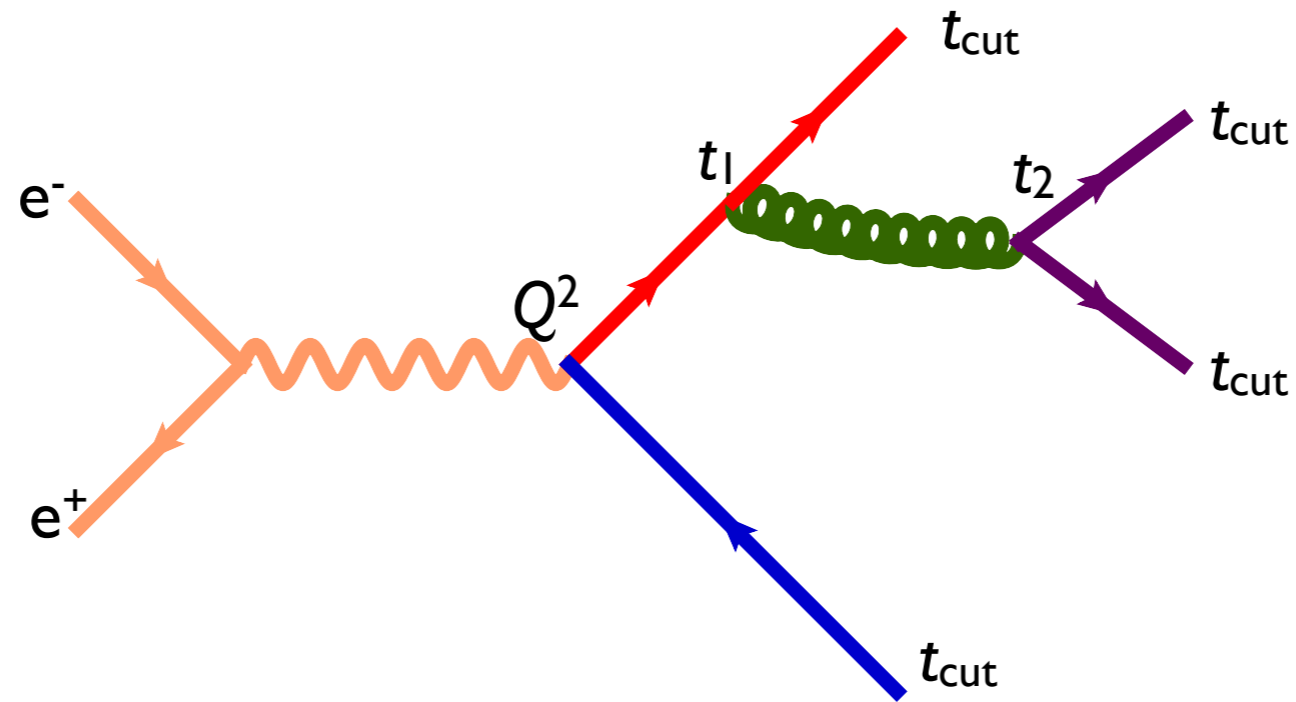

$$(\Delta_q(Q^2, t_{\text{cut}}))^2 \Delta_g(t_1, t_2) (\Delta_q(t_2, t_{\text{cut}}))^2 \frac{\alpha_s(t_1)}{2\pi} P_{gq}(z) \frac{\alpha_s(t_2)}{2\pi} P_{qg}(z')$$

Corresponds to the matrix element  
 BUT with  $\alpha_s$  evaluated at the scale of each splitting

Sudakov suppression due to disallowing additional radiation  
 above the scale  $t_{\text{cut}}$

## MERGING ME WITH PS

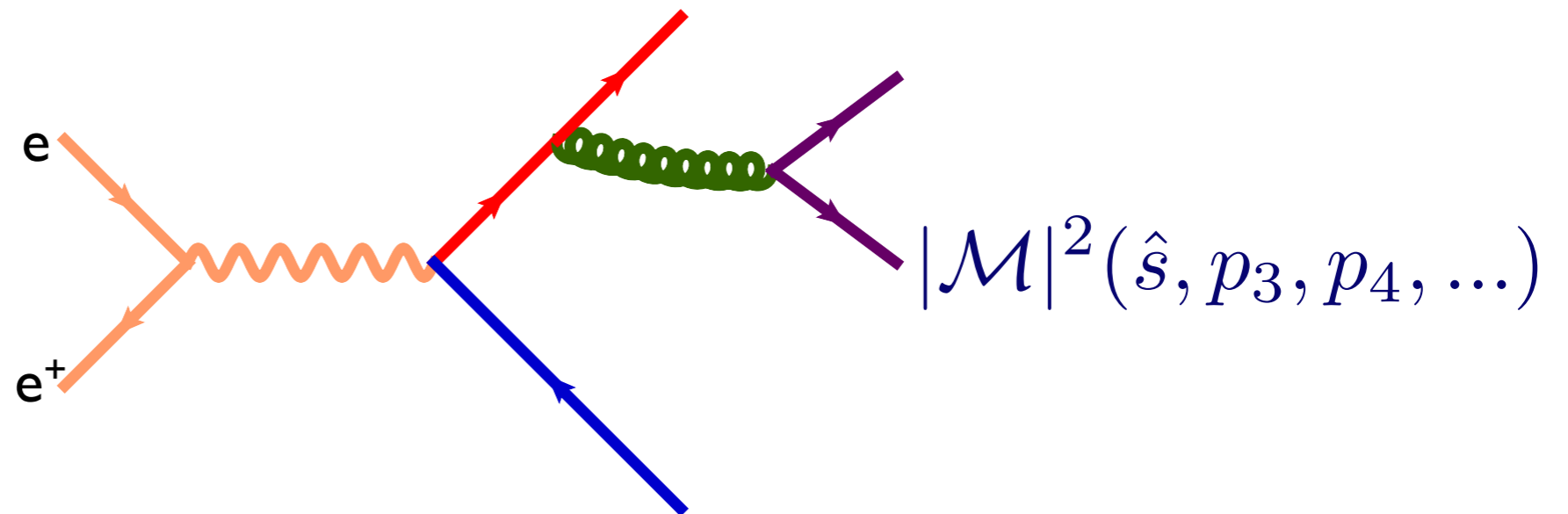

To get an equivalent treatment of the corresponding matrix element, do as follows:

1. Cluster the event using some clustering algorithm  
- this gives us a corresponding “parton shower history”
2. Reweight  $\alpha_s$  in each clustering vertex with the clustering scale

$$|\mathcal{M}|^2 \rightarrow |\mathcal{M}|^2 \frac{\alpha_s(t_1)}{\alpha_s(Q^2)} \frac{\alpha_s(t_2)}{\alpha_s(Q^2)}$$

5. Use some algorithm to apply the equivalent Sudakov suppression  
 $(\Delta_q(Q^2, t_{\text{cut}}))^2 \Delta_g(t_1, t_2) (\Delta_q(t_2, t_{\text{cut}}))^2$

# MERGING ME WITH PS

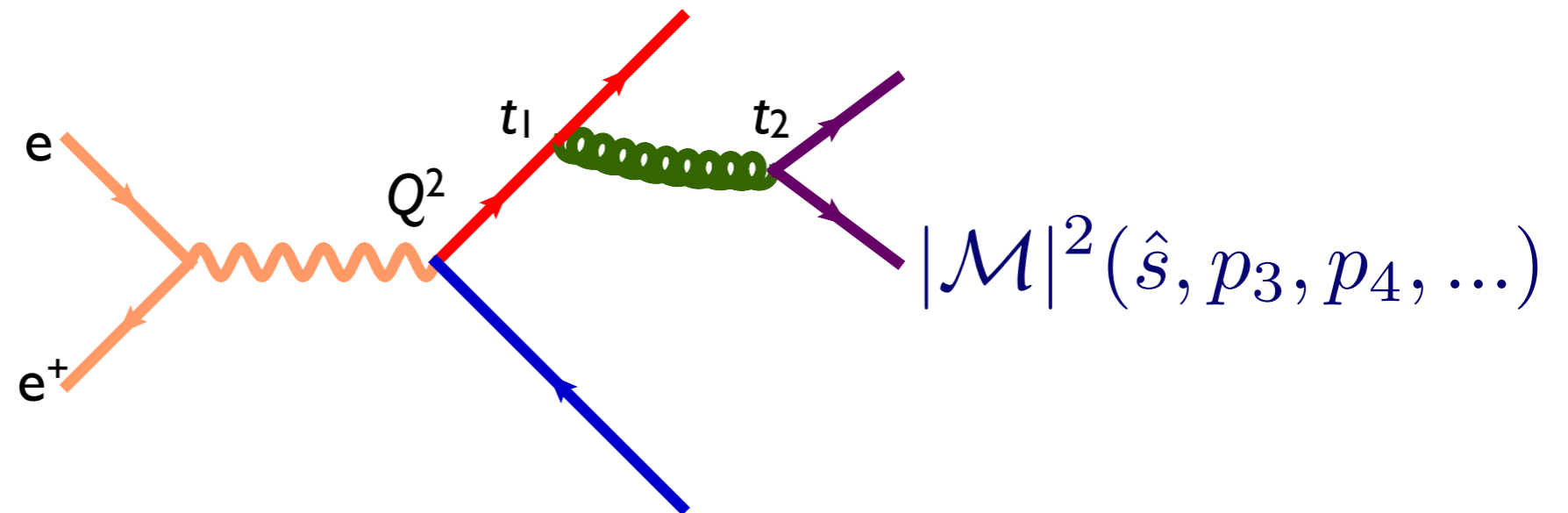

To get an equivalent treatment of the corresponding matrix element, do as follows:

1. Cluster the event using some clustering algorithm  
- this gives us a corresponding “parton shower history”
2. Reweight  $\alpha_s$  in each clustering vertex with the clustering scale

$$|\mathcal{M}|^2 \rightarrow |\mathcal{M}|^2 \frac{\alpha_s(t_1)}{\alpha_s(Q^2)} \frac{\alpha_s(t_2)}{\alpha_s(Q^2)}$$

5. Use some algorithm to apply the equivalent Sudakov suppression  
 $(\Delta_q(Q^2, t_{\text{cut}}))^2 \Delta_g(t_1, t_2) (\Delta_q(t_2, t_{\text{cut}}))^2$

# MLM MATCHING

[M.L. Mangano, 2002, 2006]  
[J. Alwall et al 2007, 2008]

- The simplest way to do the Sudakov suppression is to run the shower on the event, starting from  $t_0$ !

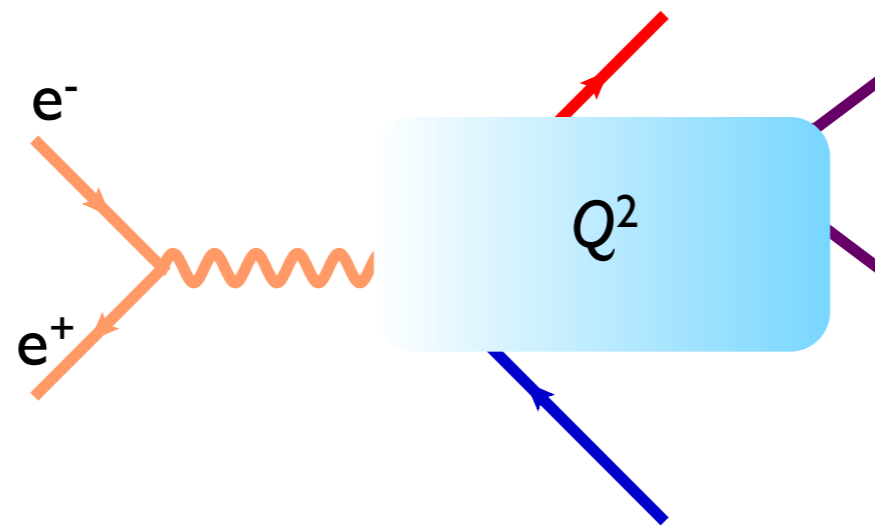

- If hardest shower emission scale  $k_{T1} > t_{cut}$ , throw the event away, if all  $k_{T1,2,3} < t_{cut}$ , keep the event
- The suppression for this is  $(\Delta_q(Q^2, t_{cut}))^4$  so the internal structure of the shower history is ignored. In practice, this approximation is still pretty good
- Allows matching with any shower, without modifications!

# MLM MATCHING

[M.L. Mangano, 2002, 2006]  
[J. Alwall et al 2007, 2008]

- The simplest way to do the Sudakov suppression is to run the shower on the event, starting from  $t_0$ !

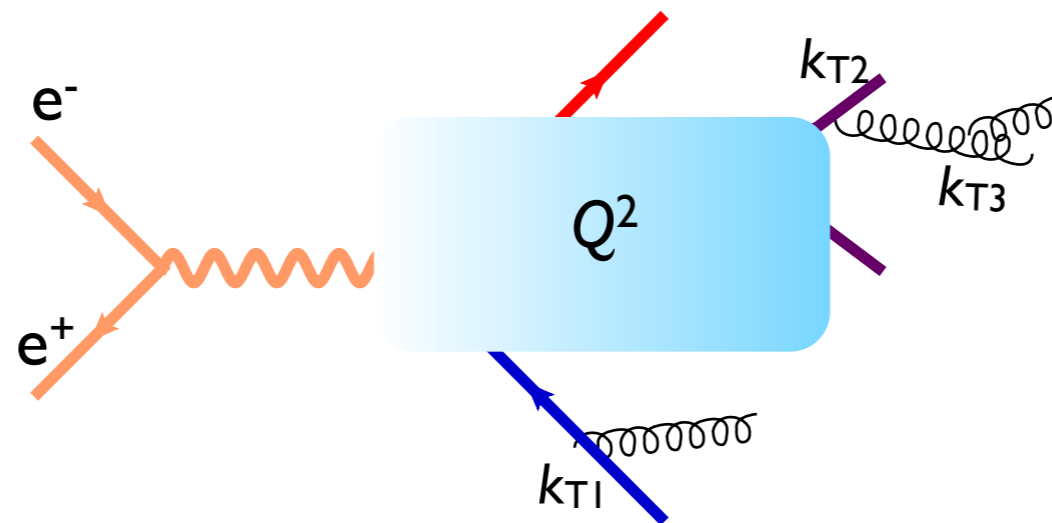

- If hardest shower emission scale  $k_{T1} > t_{cut}$ , throw the event away, if all  $k_{T1,2,3} < t_{cut}$ , keep the event
- The suppression for this is  $(\Delta_q(Q^2, t_{cut}))^4$  so the internal structure of the shower history is ignored. In practice, this approximation is still pretty good
- Allows matching with any shower, without modifications!



# CKKW MATCHING

[Catani, Krauss, Kuhn, Webber, 2001]

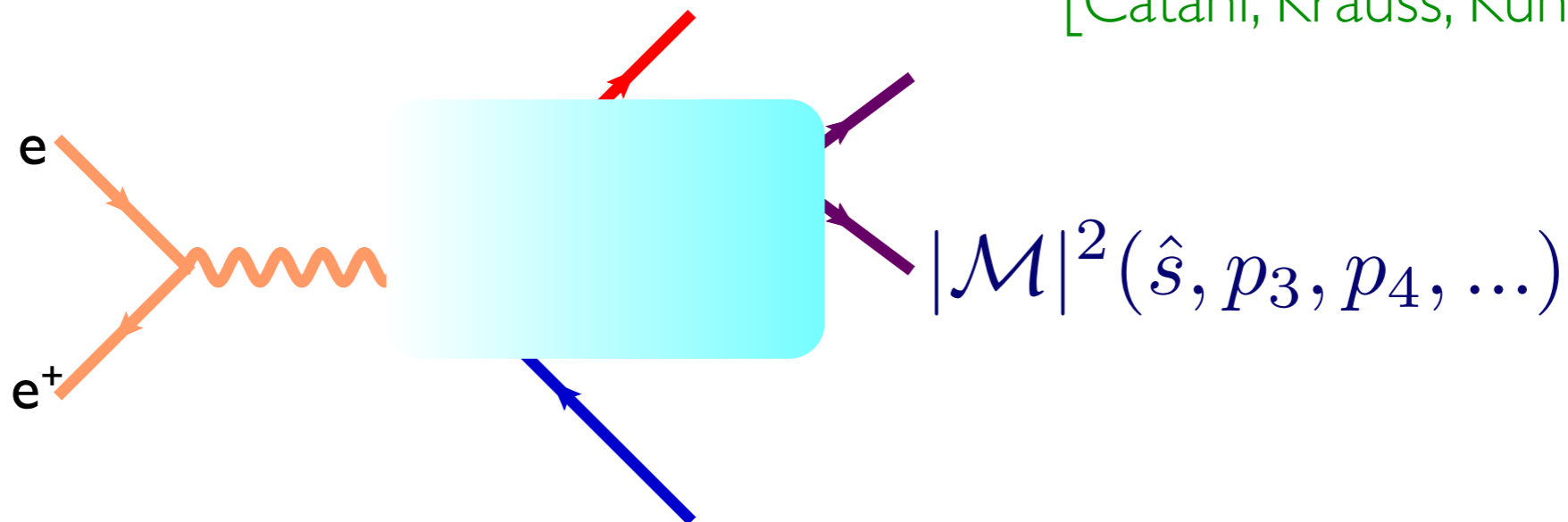

- Once the ‘most-likely parton shower history’ has been found, one can also reweight the matrix element with the Sudakov factors that give that history

$$(\Delta_q(Q^2, t_{\text{cut}}))^2 \Delta_g(t_1, t_2) (\Delta_q(t_2, t_{\text{cut}}))^2$$

- To do this correctly, must use same variable to cluster and define this Sudakov as the one used as evolution parameter in the parton shower. Parton shower can start at  $t_{\text{cut}}$ .

# CKKW MATCHING

[Catani, Krauss, Kuhn, Webber, 2001]

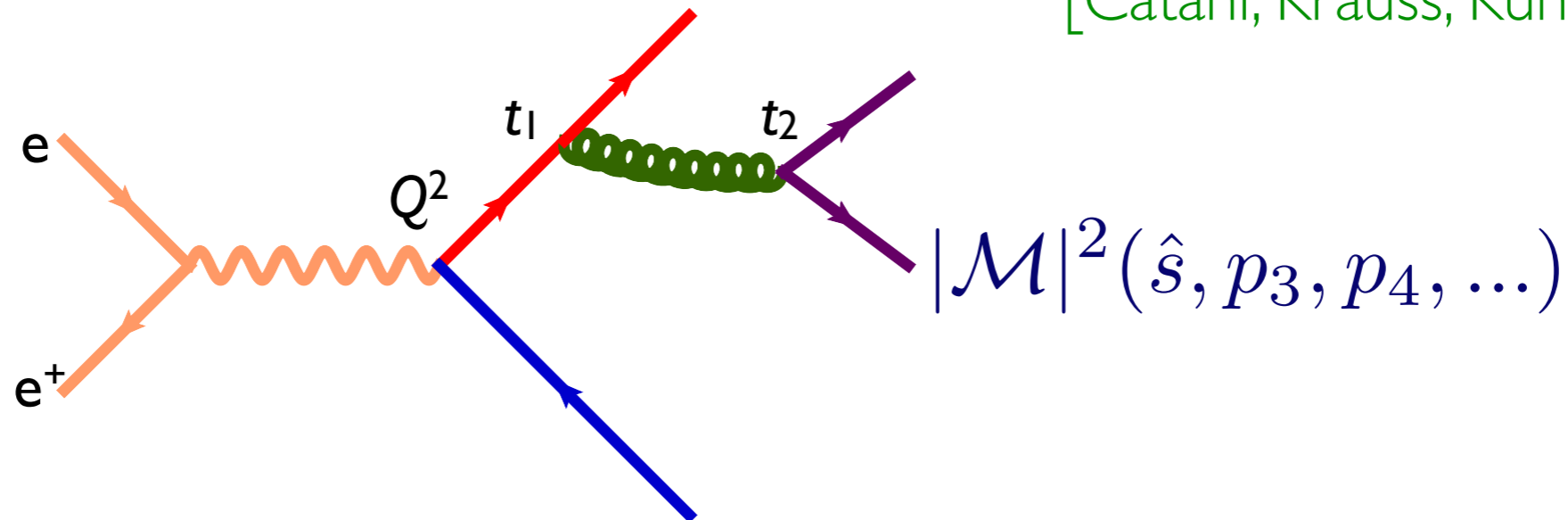

- Once the ‘most-likely parton shower history’ has been found, one can also reweight the matrix element with the Sudakov factors that give that history

$$(\Delta_q(Q^2, t_{\text{cut}}))^2 \Delta_g(t_1, t_2) (\Delta_q(t_2, t_{\text{cut}}))^2$$

- To do this correctly, must use same variable to cluster and define this Sudakov as the one used as evolution parameter in the parton shower. Parton shower can start at  $t_{\text{cut}}$ .

# CKKW MATCHING

[Catani, Krauss, Kuhn, Webber, 2001]

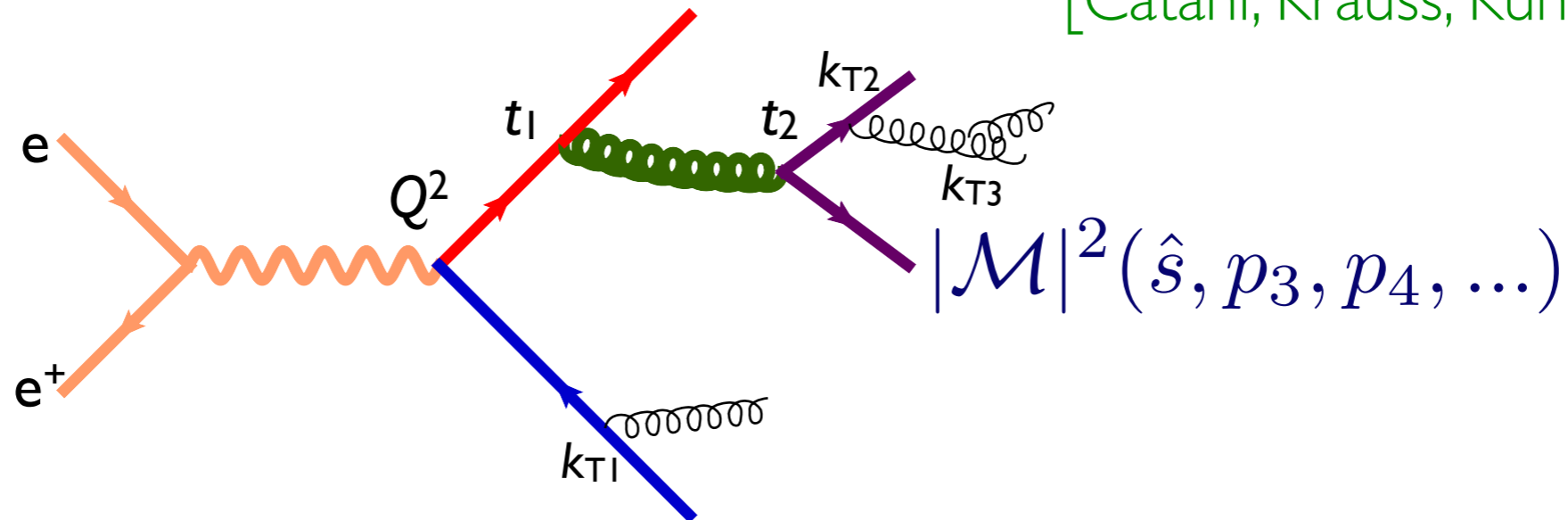

- Once the ‘most-likely parton shower history’ has been found, one can also reweight the matrix element with the Sudakov factors that give that history

$$(\Delta_q(Q^2, t_{\text{cut}}))^2 \Delta_g(t_1, t_2) (\Delta_q(t_2, t_{\text{cut}}))^2$$

- To do this correctly, must use same variable to cluster and define this Sudakov as the one used as evolution parameter in the parton shower. Parton shower can start at  $t_{\text{cut}}$ .

# SANITY CHECKS: DIFFERENTIAL JET RATES

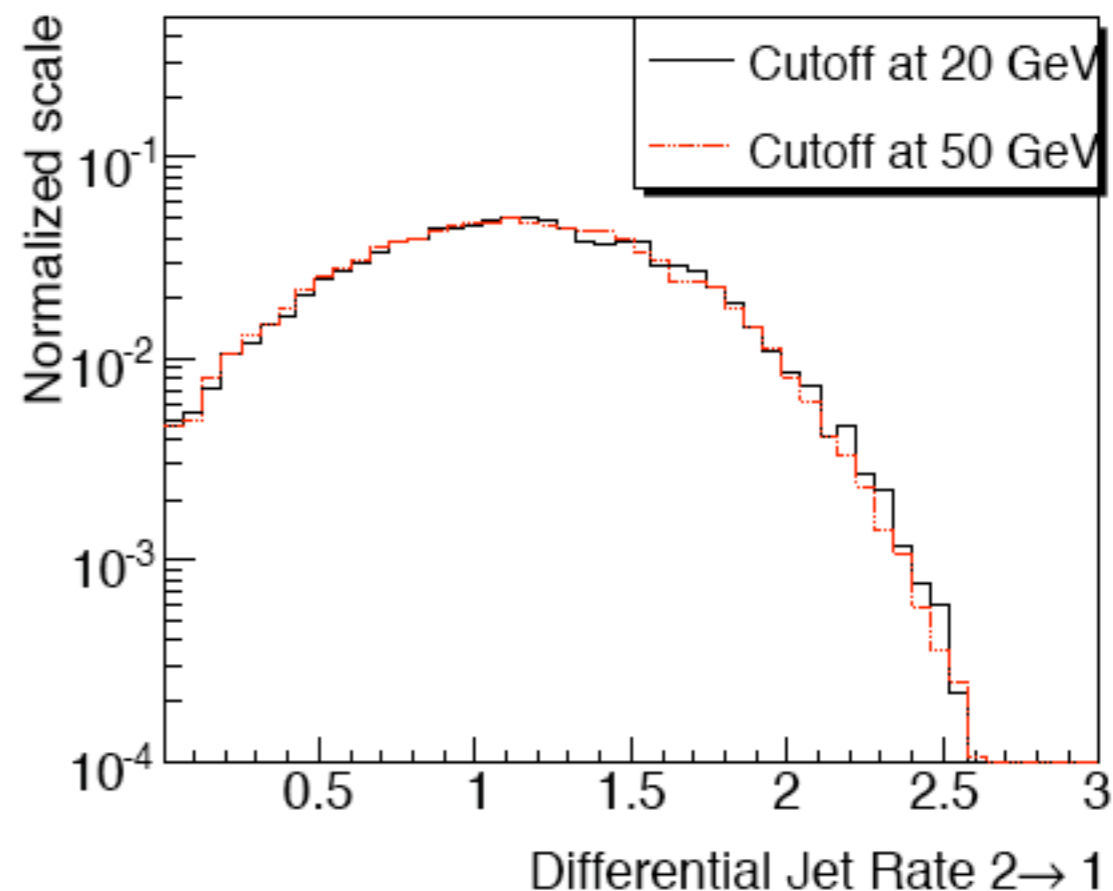
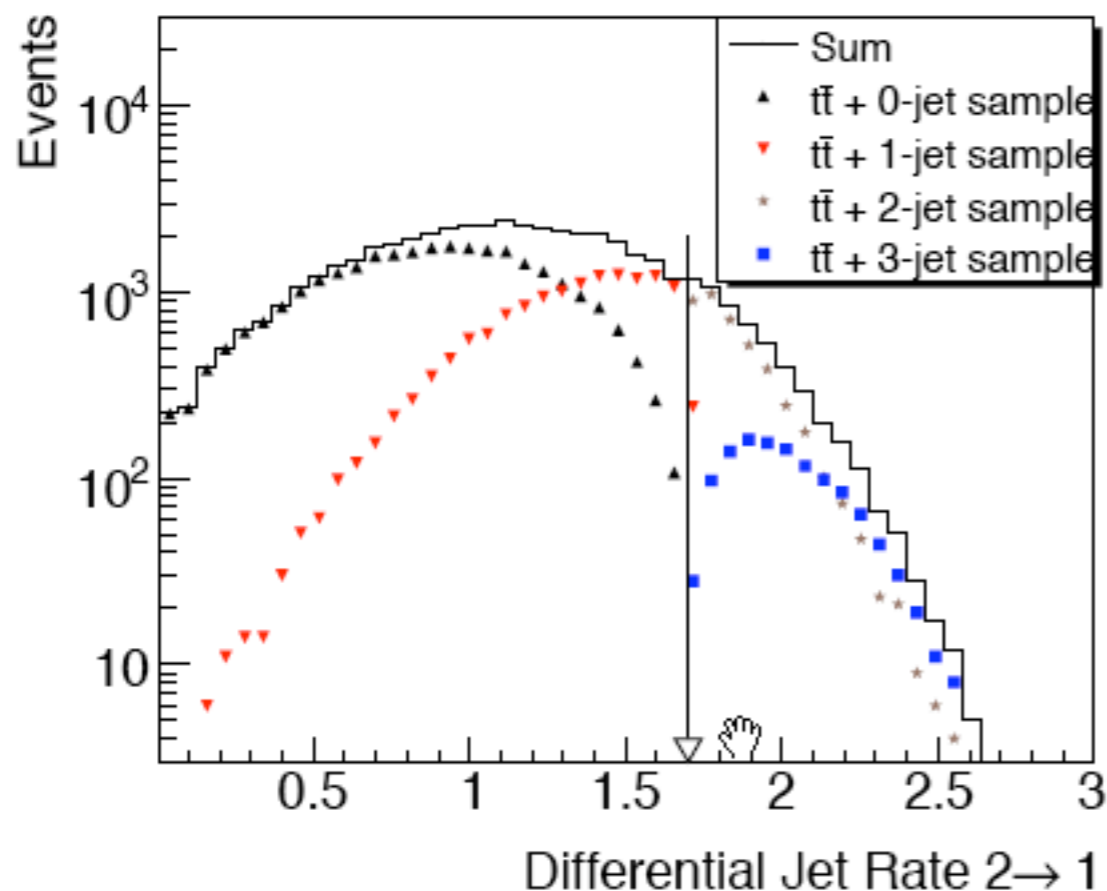

Jet rates are independent of and smooth at the cutoff scale

# PS ALONE VS. MATCHED SAMPLE

In the soft-collinear approximation of Parton Shower MCs, parameters are used to tune the result  $\Rightarrow$  Large variation in results (small prediction power)

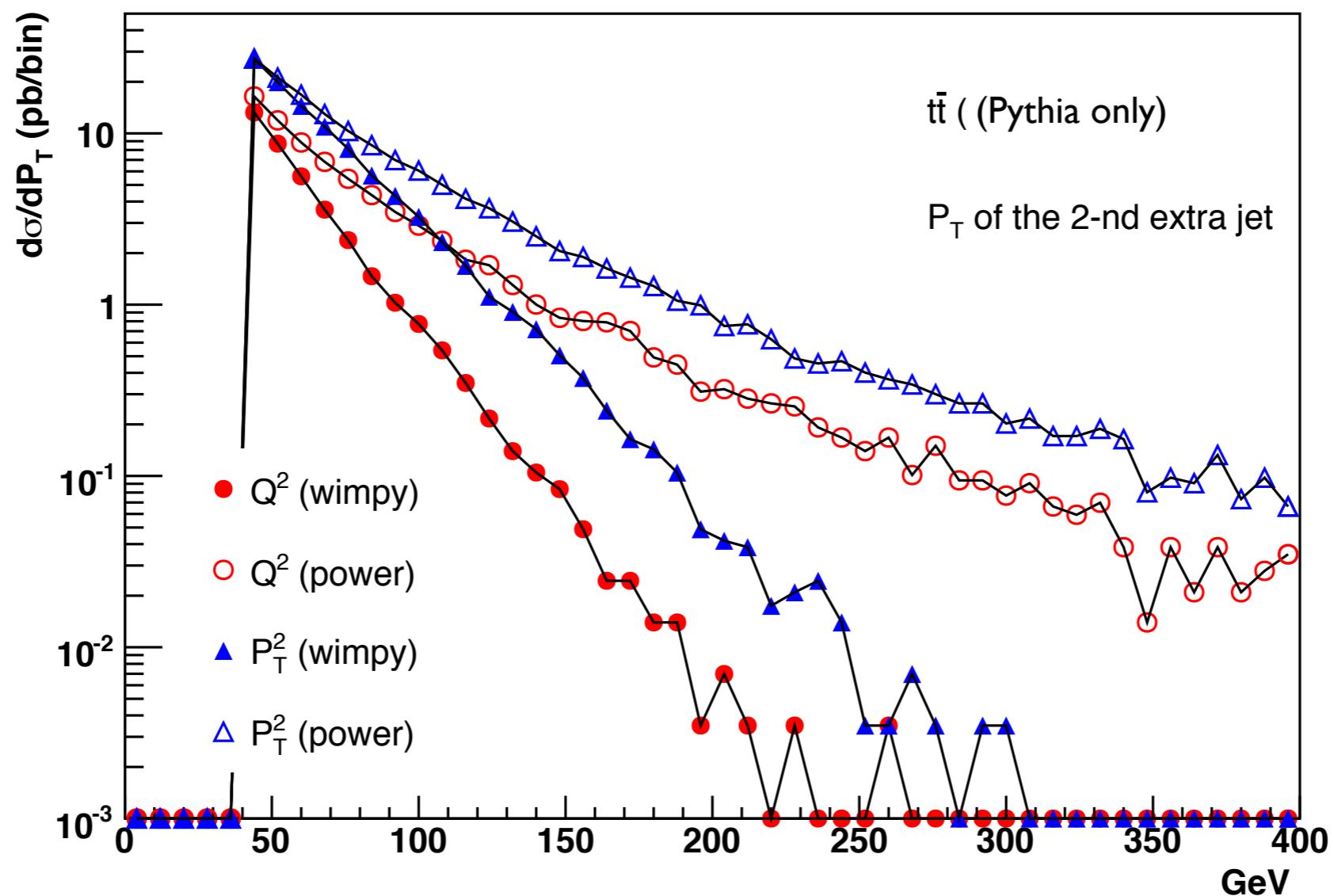

# PS ALONE VS. MERGED SAMPLE

In a matched sample these differences are irrelevant since the behavior at high pt is dominated by the matrix element.

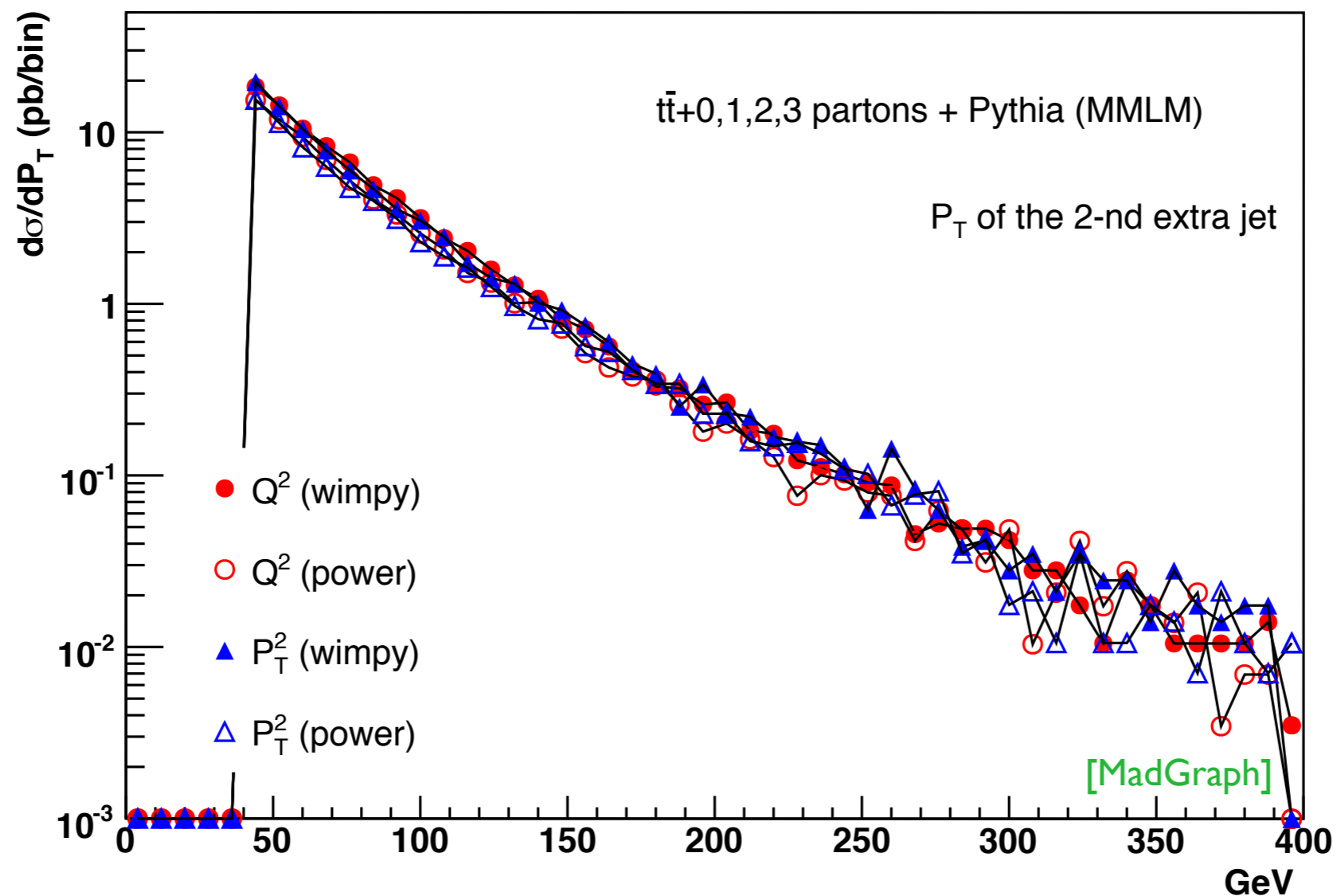

# TH/EXP COMPARISON AT THE LHC

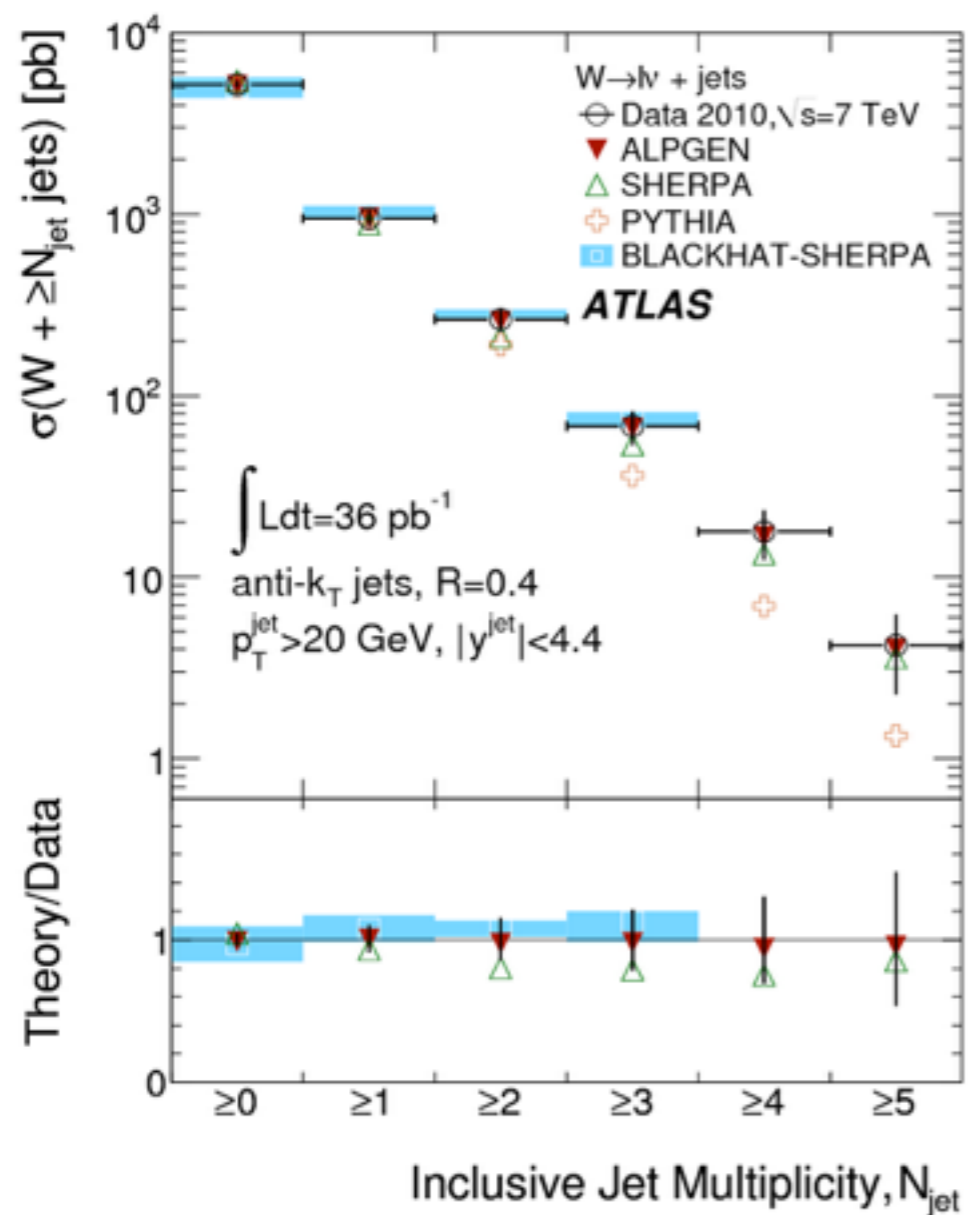

Bonus: Even rates in outstanding agreement with data and NLO

# TH/EXP COMPARISON AT THE LHC

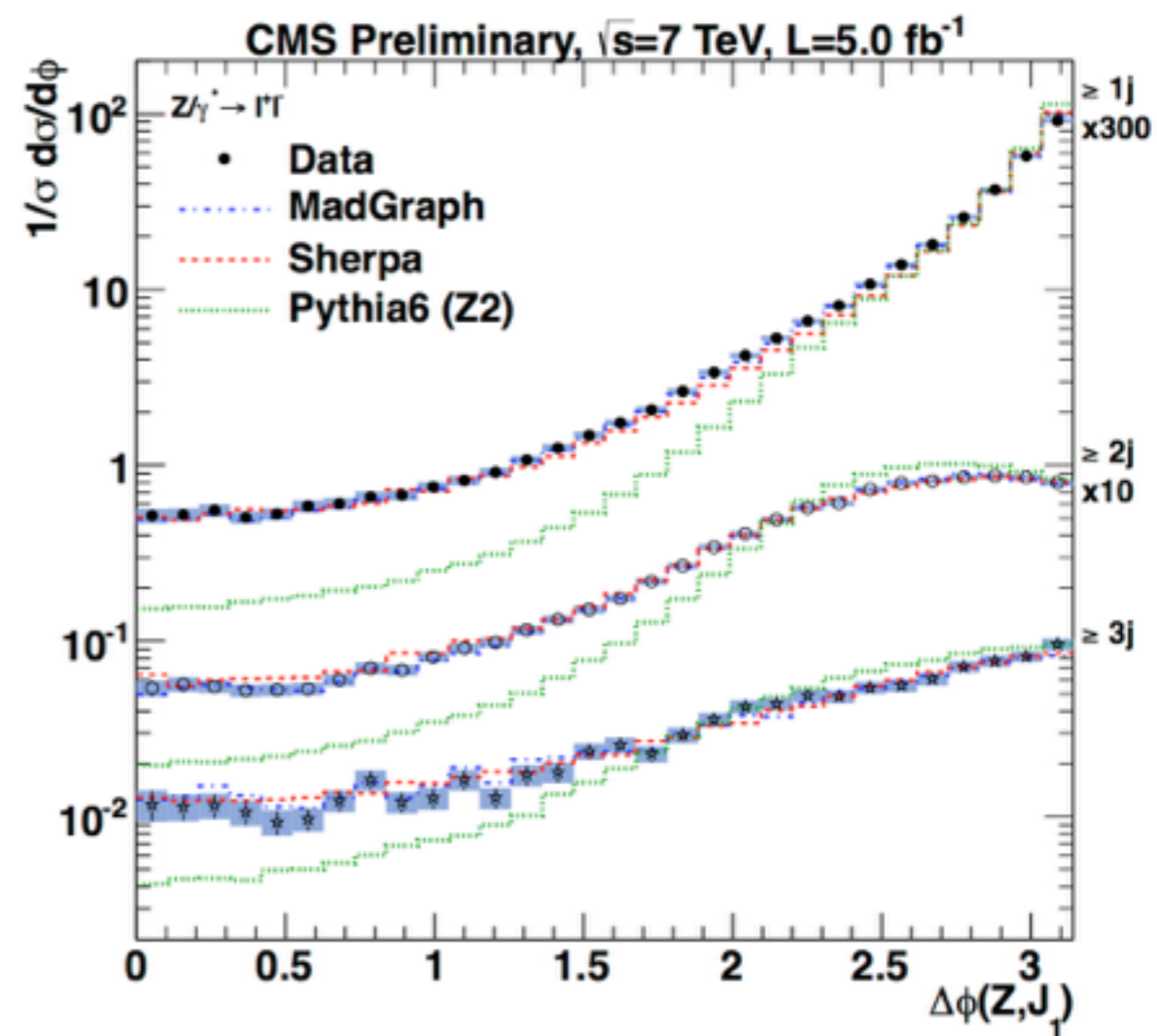
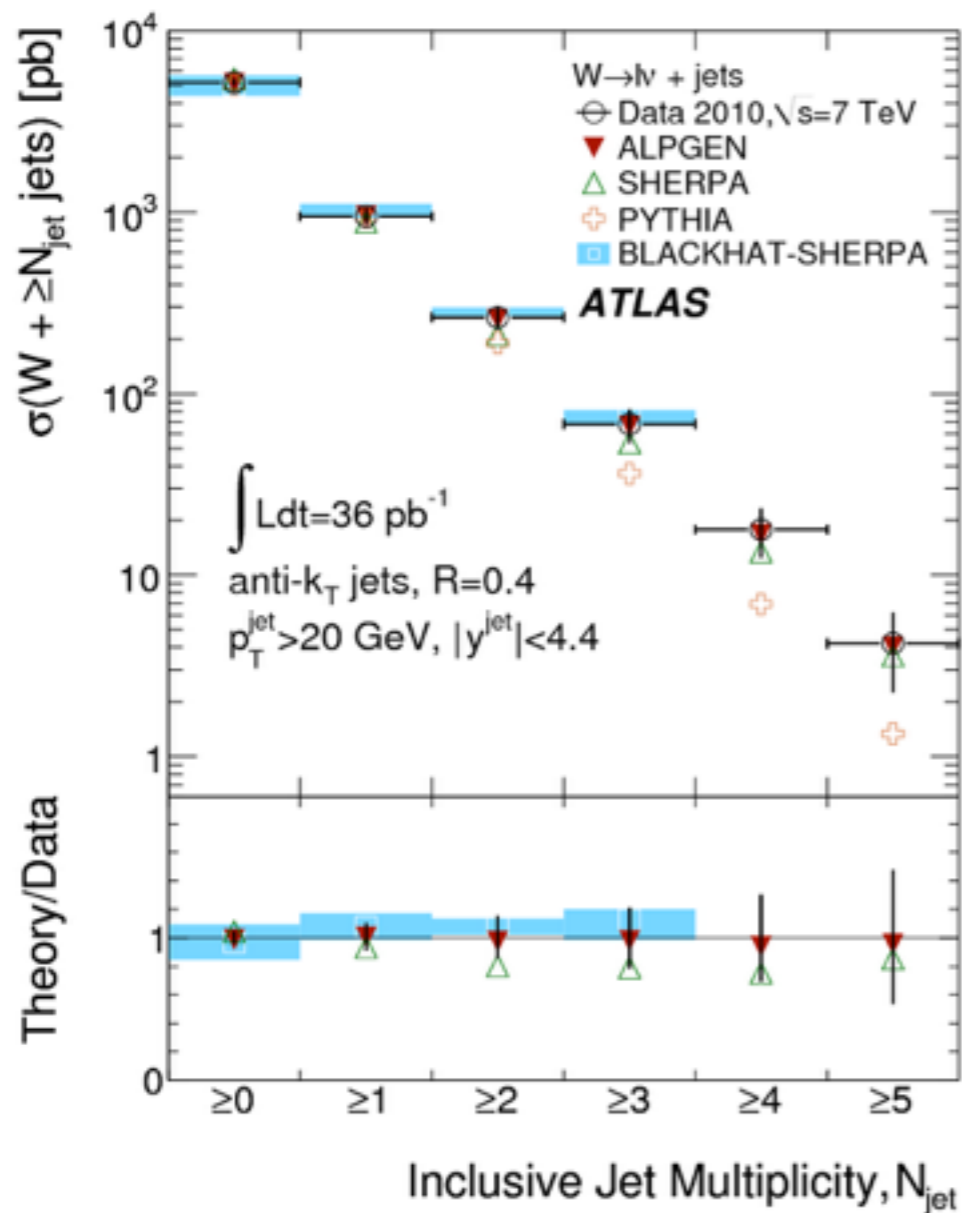

Bonus: Even rates in outstanding agreement with data and NLO



# SUSY MATCHED SAMPLES

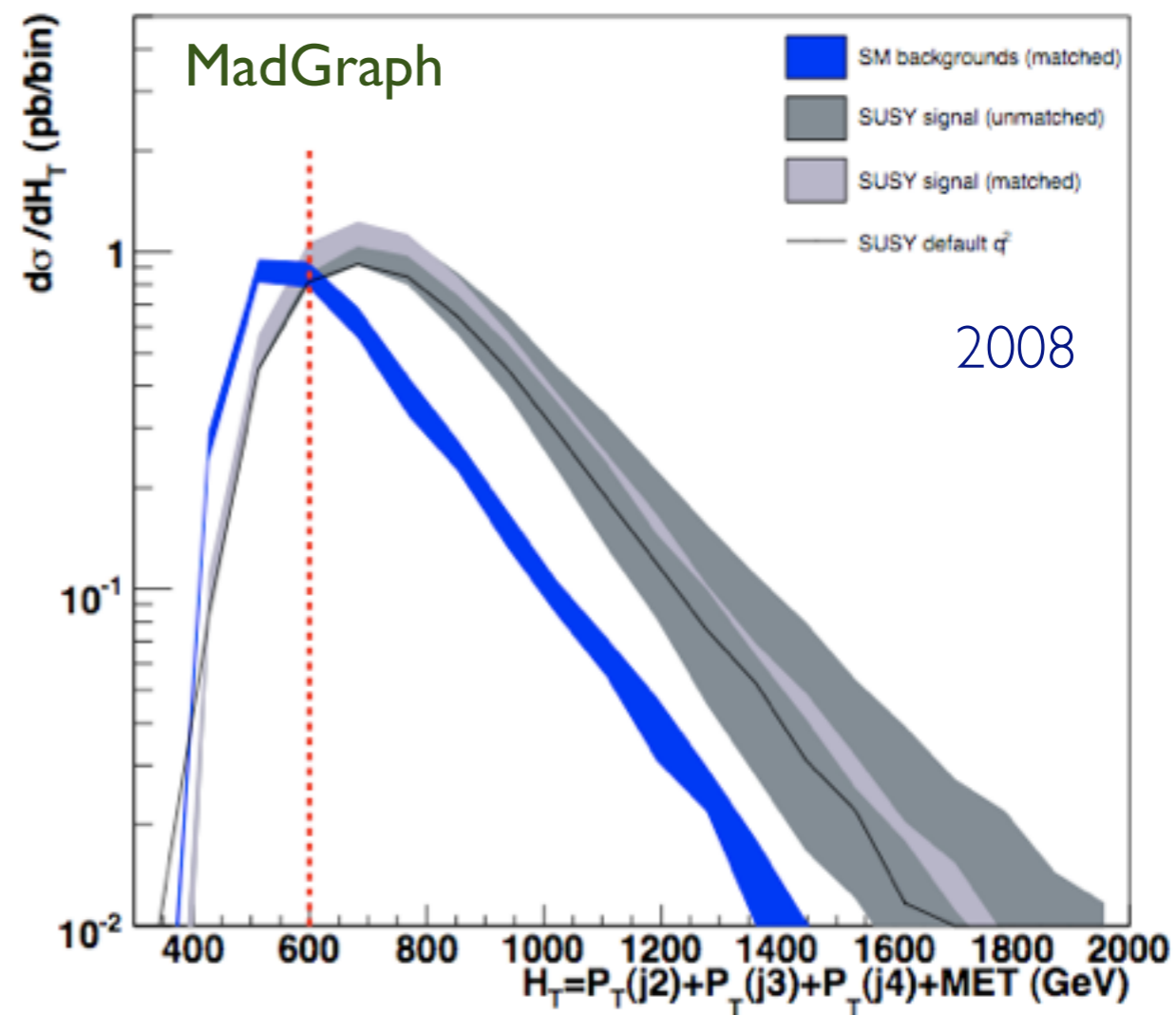
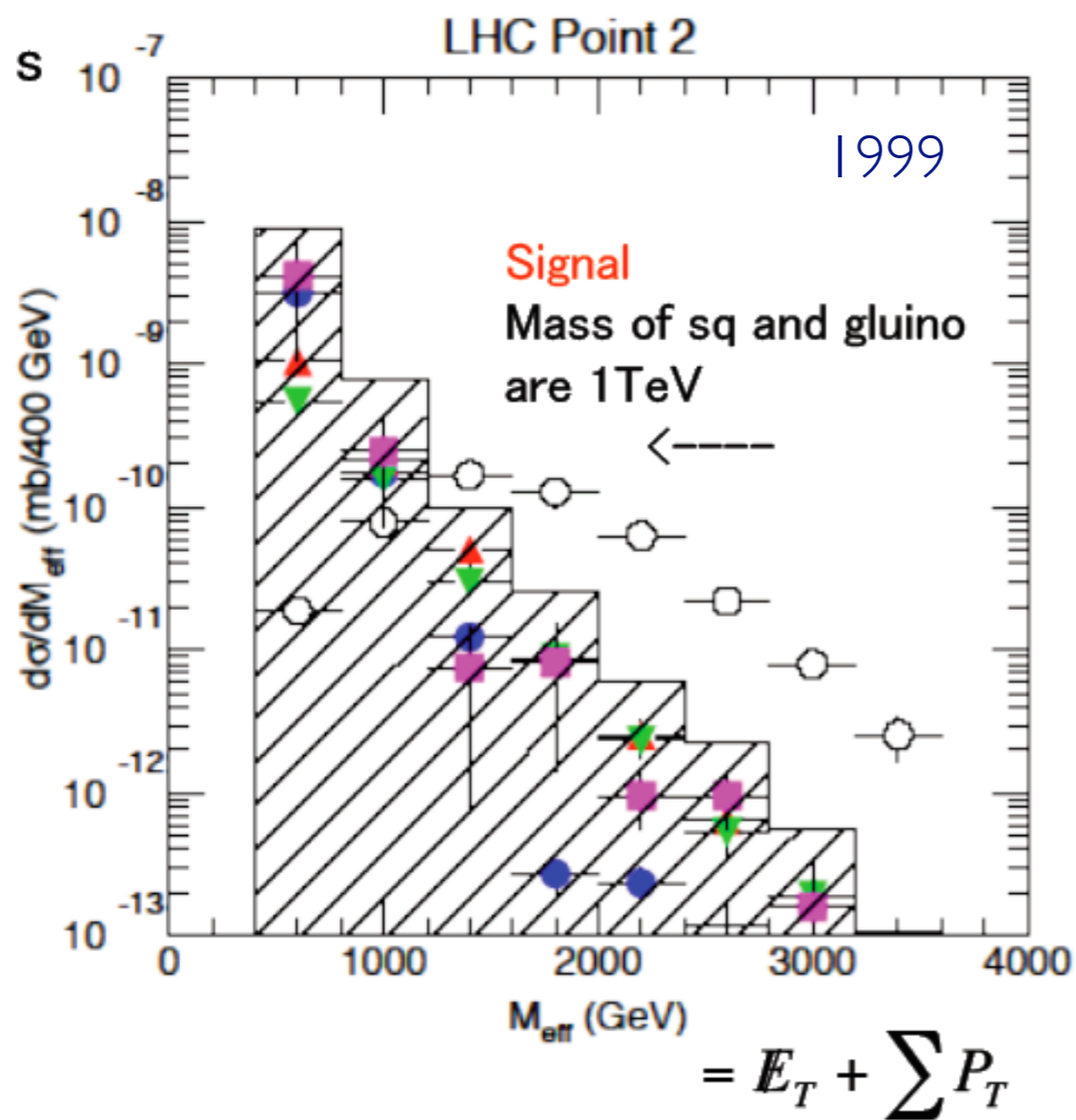

Both signal and background matched!

Sizable reduction of the uncertainties and simulation consistency .

## SUMMARY OF ME/PS MERGING

- Merging matrix elements of various multiplicities with parton showers improves the predictive power of the parton shower outside the collinear/soft regions.
  - These matched samples give excellent prescription of the data (except for the total normalization).
- There is a dependence on the parameters responsible for the cut in phase-space (i.e. the matching scale).
- By letting the matrix elements mimic what the parton shower does in the collinear/soft regions (PDF/ $\alpha_s$  reweighting and including the Sudakov suppression) the dependence is greatly reduced.
- In practice, one should check explicitly that this is the case by plotting differential jet-rate plots for a couple of values for the matching scale.

# NLO+PS MATCHING

ME

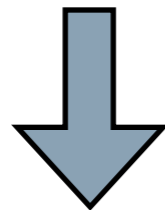

1. Fixed order calculation
2. Computationally expensive
3. Limited number of particles
4. Valid when partons are **hard and well separated**
5. Quantum interference correct
6. Needed for multi-jet description

Shower MC

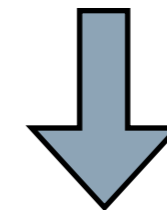

1. Resums logs to all orders
2. Computationally cheap
3. No limit on particle multiplicity
4. Valid when partons are **collinear and/or soft**
5. Partial interference through angular ordering
6. Needed for hadronization

**Approaches are complementary: merge them!**

**Difficulty: avoid double counting, ensure smooth distributions**

# NLO+PS MATCHING

ME

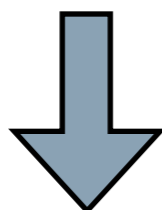

- 1. Fixed order calculation
- 2. Computationally expensive
- 3. Limited number of final state particles
- 4. Valid when partons are **hard and well separated**
- 5. Quantum interference correct
- 6. Needed for multi-jet description

Shower MC

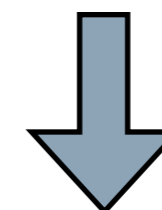

- 1. Resums logs to all orders
- 2. Computationally cheap
- 3. No limit on particle multiplicity
- 4. Valid when partons are **collinear and/or soft**
- 5. Partial interference through angular ordering
- 6. No quantum interference

**No longer true at NLO!**

**Approaches are complementary. Merge them!**

**Difficulty: avoid double counting, ensure smooth distributions**

## AT NLO

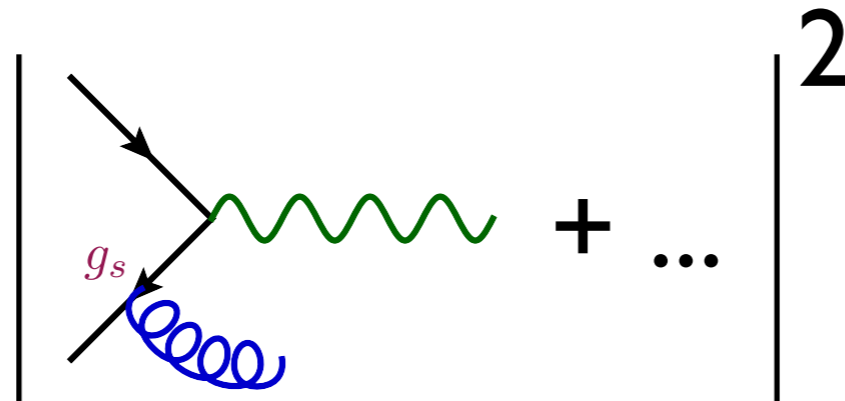

- We have to integrate the real emission over the **complete** phase-space of the one particle that can go soft or collinear to obtain the infra-red poles that will cancel against the virtual corrections
- We cannot use the same matching procedure: requiring that all partons should produce separate jets is not infrared safe
- We have to invent a new procedure to match NLO matrix elements with parton showers

## NAIVE (WRONG) APPROACH

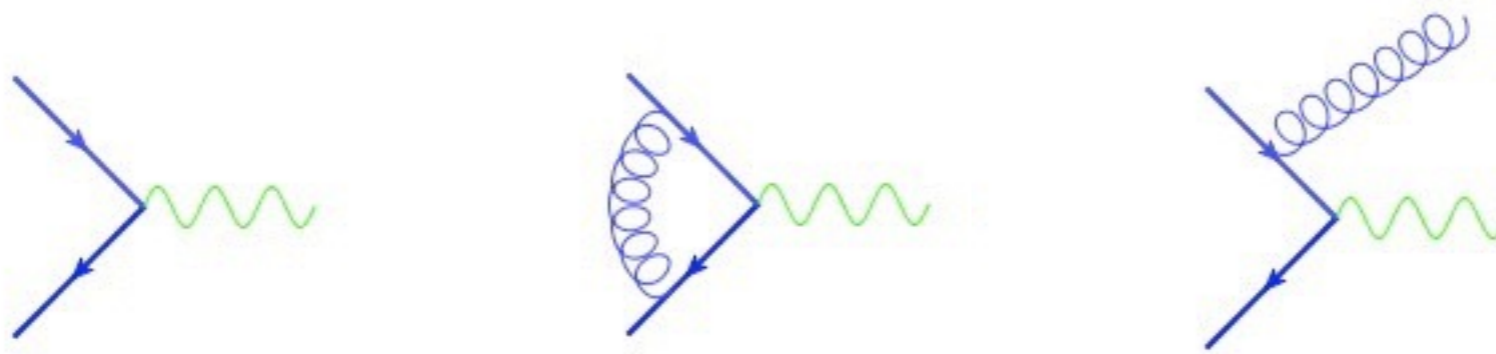

- In a fixed order calculation we have contributions with  $m$  final state particles and with  $m+1$  final state particles

$$\sigma^{\text{NLO}} \sim \int d^4\Phi_m B(\Phi_m) + \int d^4\Phi_m \int_{\text{loop}} d^d l V(\Phi_m) + \int d^d\Phi_{m+1} R(\Phi_{m+1})$$

- We could try to shower them independently
- Let  $I_{\text{MC}}^{(k)}(O)$  be the parton shower spectrum for an observable  $O$ , showering from a  $k$ -body initial condition
- We can then try to shower the  $m$  and  $m+1$  final states independently

$$\frac{d\sigma_{\text{NLOwPS}}}{dO} = \left[ d\Phi_m (B + \int_{\text{loop}} V) \right] I_{\text{MC}}^{(m)}(O) + \left[ d\Phi_{m+1} R \right] I_{\text{MC}}^{(m+1)}(O)$$



## NAIVE (WRONG) APPROACH

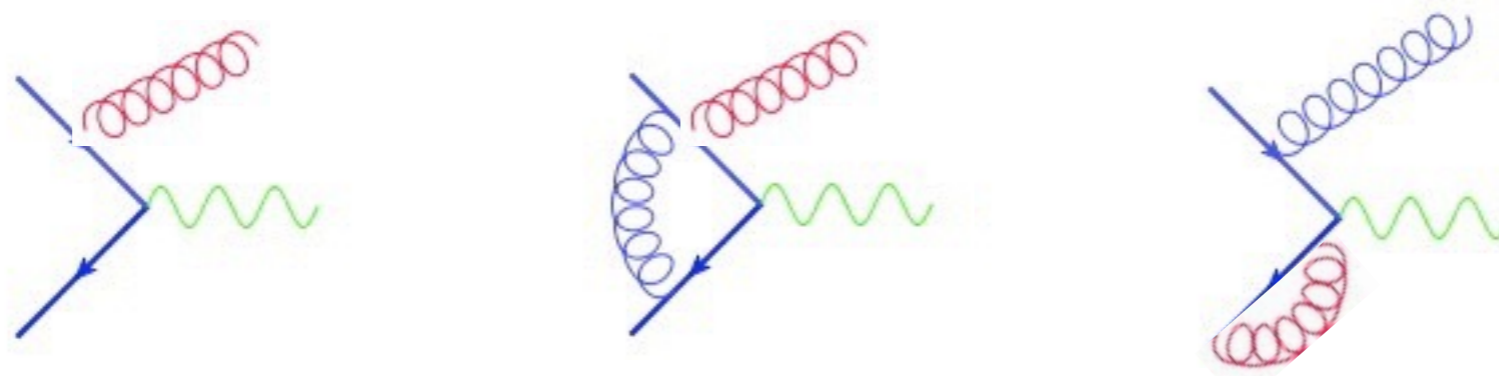

- In a fixed order calculation we have contributions with  $m$  final state particles and with  $m+1$  final state particles

$$\sigma^{\text{NLO}} \sim \int d^4\Phi_m B(\Phi_m) + \int d^4\Phi_m \int_{\text{loop}} d^d l V(\Phi_m) + \int d^d\Phi_{m+1} R(\Phi_{m+1})$$

- We could try to shower them independently
- Let  $I_{\text{MC}}^{(k)}(O)$  be the parton shower spectrum for an observable  $O$ , showering from a  $k$ -body initial condition
- We can then try to shower the  $m$  and  $m+1$  final states independently

$$\frac{d\sigma_{\text{NLOwPS}}}{dO} = \left[ d\Phi_m (B + \int_{\text{loop}} V) \right] I_{\text{MC}}^{(m)}(O) + \left[ d\Phi_{m+1} R \right] I_{\text{MC}}^{(m+1)}(O)$$

## DOUBLE COUNTING

$$\frac{d\sigma_{\text{NLOwPS}}}{dO} = \left[ d\Phi_m (B + \int_{\text{loop}} V) \right] I_{\text{MC}}^{(m)}(O) + \left[ d\Phi_{m+1} R \right] I_{\text{MC}}^{(m+1)}(O)$$

- But this is wrong!
- If you expand this equation out up to NLO, there are more terms than there should be and the total rate does not come out correctly
- Schematically  $I_{\text{MC}}^{(k)}(O)$  for 0 and 1 emission is given by

$$I_{\text{MC}}^{(k)}(O) \sim \Delta_a(Q^2, Q_0^2) + \Delta_a(Q^2, t) \sum_{bc} dz \frac{dt}{t} \frac{d\phi}{2\pi} \frac{\alpha_s(t)}{2\pi} P_{a \rightarrow bc}(z)$$

- And  $\Delta$  is the Sudakov factor

$$\Delta_a(Q^2, t) = \exp \left[ - \sum_{bc} \int_t^{Q^2} \frac{dt'}{t'} dz \frac{d\phi}{2\pi} \frac{\alpha_s(t')}{2\pi} P_{a \rightarrow bc} \right]$$



# SOURCES OF DOUBLE COUNTING

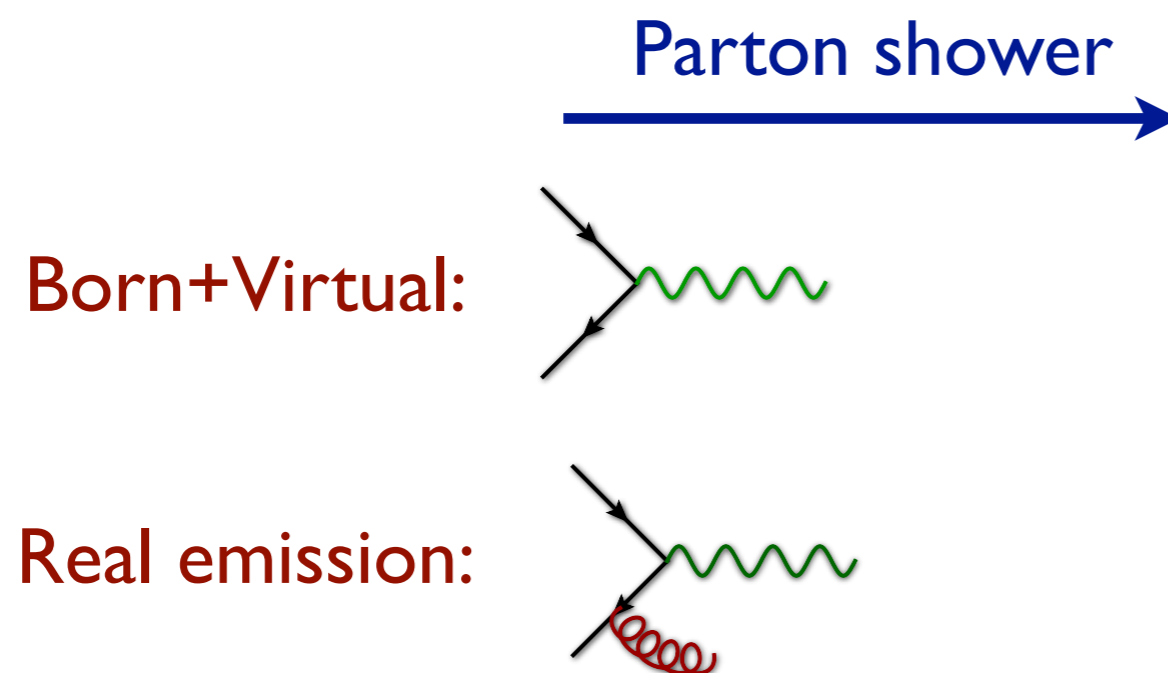

# SOURCES OF DOUBLE COUNTING

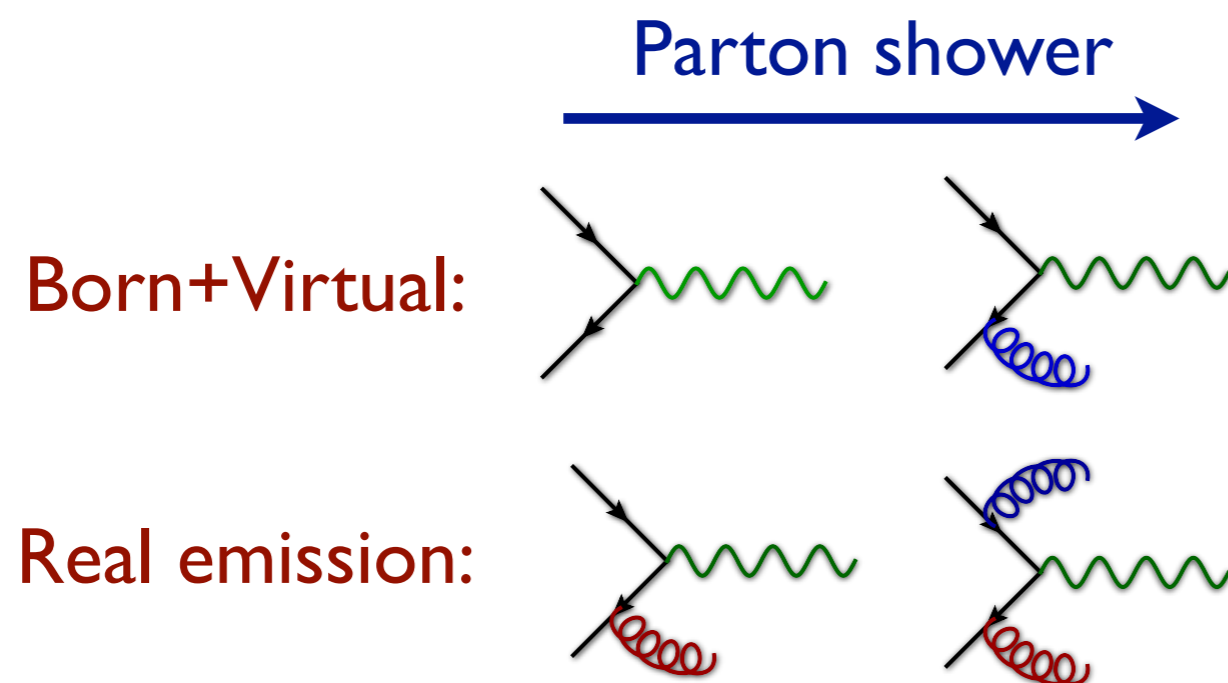

# SOURCES OF DOUBLE COUNTING

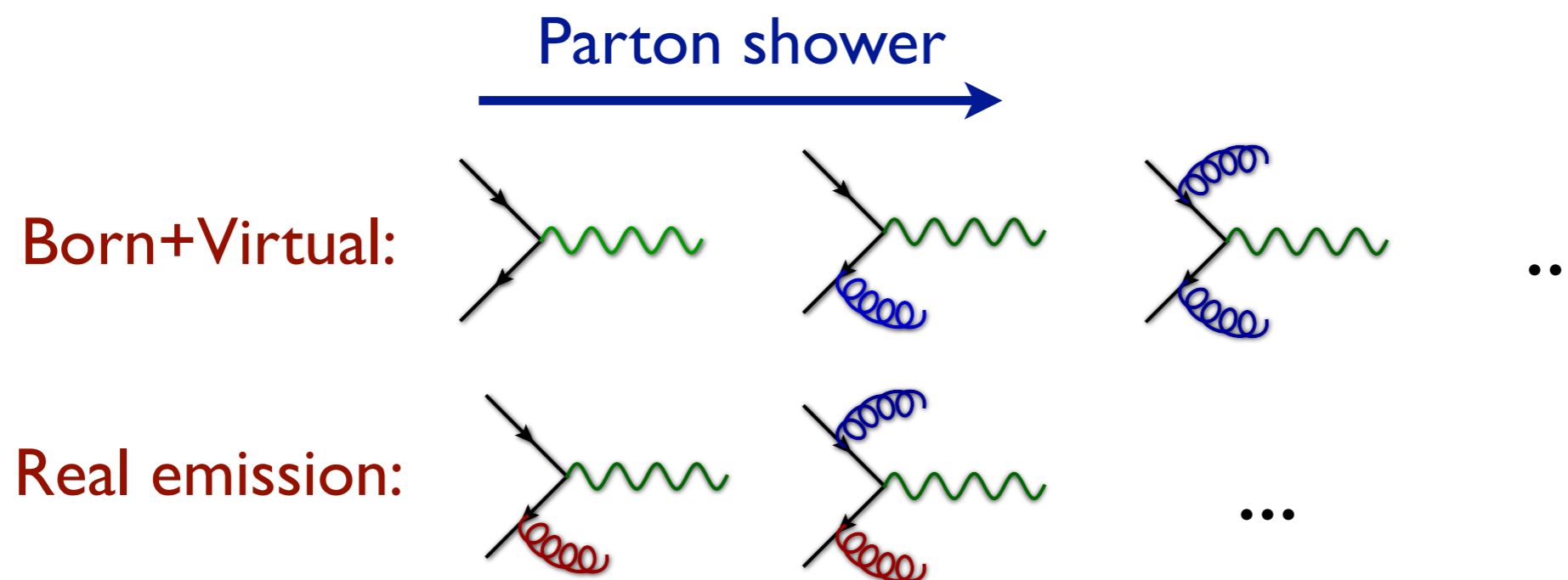

# SOURCES OF DOUBLE COUNTING

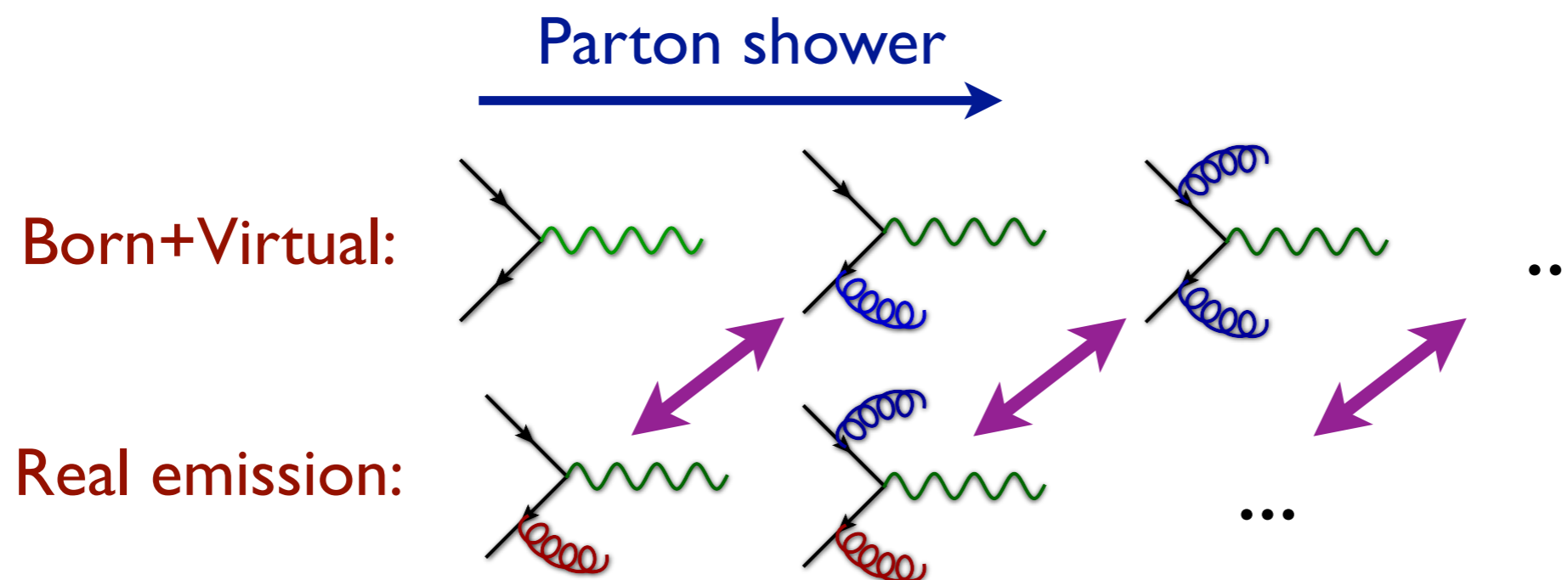

# SOURCES OF DOUBLE COUNTING

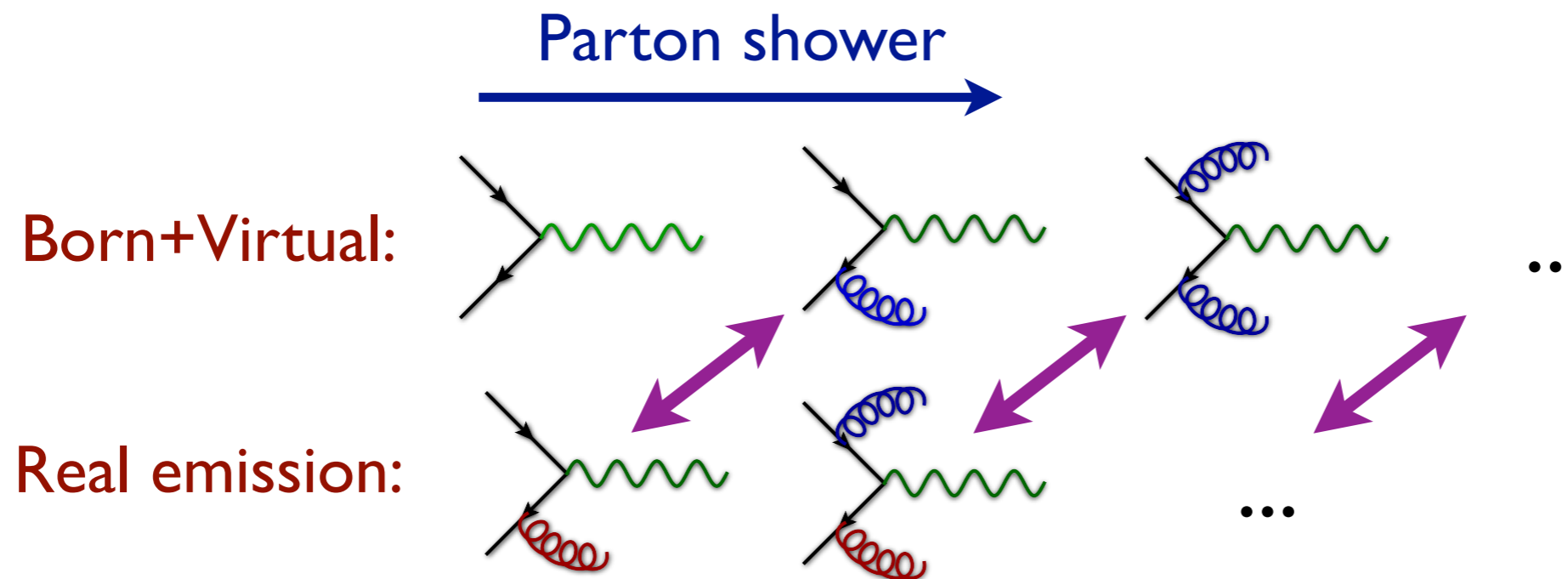

- There is double counting between the real emission matrix elements and the parton shower: the extra radiation can come from the matrix elements or the parton shower
- There is also an overlap between the virtual corrections and the Sudakov suppression in the zero-emission probability

# DOUBLE COUNTING IN VIRTUAL/SUDAKOV

- The Sudakov factor  $\Delta$  (which is responsible for the resummation of all the radiation in the shower) is the no-emission probability
- It's defined to be  $\Delta = 1 - P$ , where  $P$  is the probability for a branching to occur
- By using this conservation of probability in this way,  $\Delta$  contains contributions from the virtual corrections implicitly
- Because at NLO the virtual corrections are already included via explicit matrix elements,  $\Delta$  is double counting with the virtual corrections
- In fact, because the shower is unitary, what we are double counting in the real emission corrections is exactly equal to what we are double counting in the virtual corrections (but with opposite sign)!

# AVOIDING DOUBLE COUNTING

- There are two methods to circumvent this double counting
  - MC@NLO (Frixione & Webber)
  - POWHEG (Nason)

# MC@NLO PROCEDURE

[Frixione & Webber (2002)]

- To remove the double counting, we can add and subtract the same term to the  $m$  and  $m+1$  body configurations

$$\frac{d\sigma_{\text{NLOwPS}}}{dO} = \left[ d\Phi_m (B + \int_{\text{loop}} V + \int d\Phi_1 MC) \right] I_{\text{MC}}^{(m)}(O) \\ + \left[ d\Phi_{m+1} (R - MC) \right] I_{\text{MC}}^{(m+1)}(O)$$

- Where the  $MC$  are defined to be the contribution of the parton shower to get from the  $m$  body Born final state to the  $m+1$  body real emission final state



# MC@NLO PROCEDURE

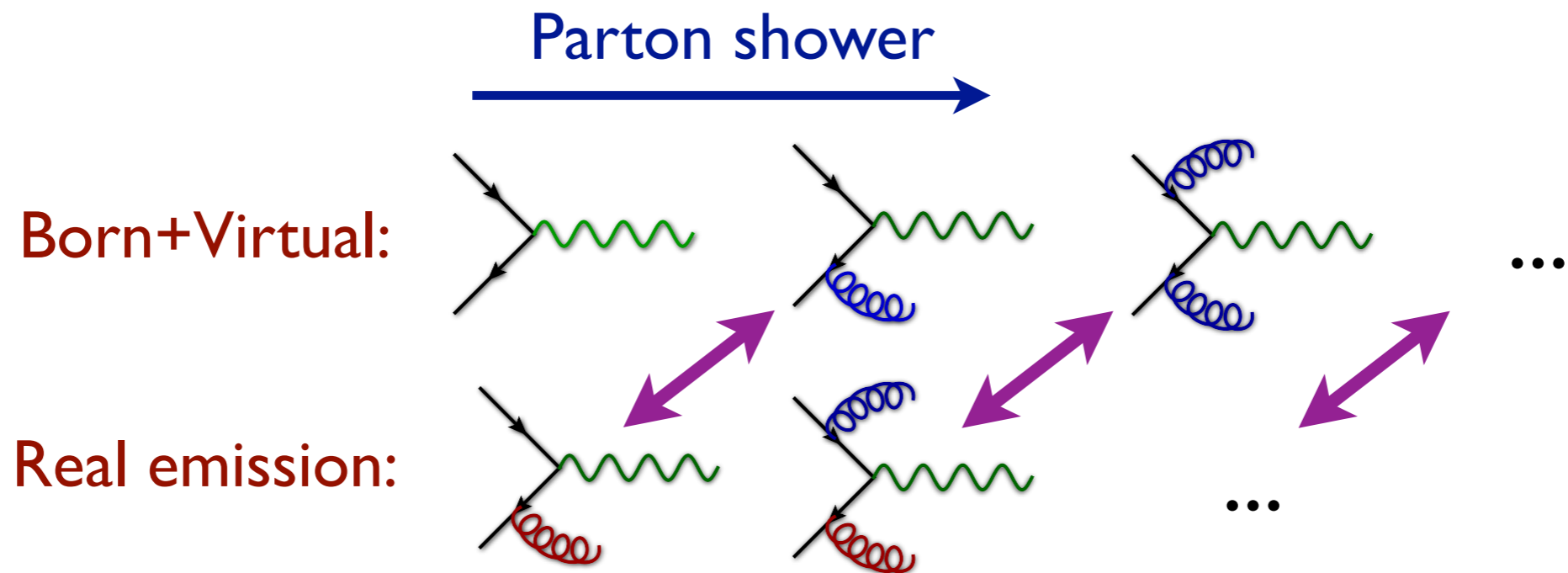

$$\frac{d\sigma_{\text{NLOwPS}}}{dO} = \left[ d\Phi_m (B + \int_{\text{loop}} V + \int d\Phi_1 MC) \right] I_{\text{MC}}^{(m)}(O) + \left[ d\Phi_{m+1} (R - MC) \right] I_{\text{MC}}^{(m+1)}(O)$$

- Double counting is explicitly removed by including the “shower subtraction terms”

# MC@NLO PROPERTIES

- Good features of including the subtraction counter terms
  1. **Double counting avoided:** The rate expanded at NLO coincides with the total NLO cross section
  2. **Smooth matching:** MC@NLO coincides (in shape) with the parton shower in the soft/collinear region, while it agrees with the NLO in the hard region
  3. **Stability:** weights associated to different multiplicities are separately finite. The **MC** term has the same infrared behavior as the real emission (there is a subtlety for the soft divergence)

## DOUBLE COUNTING AVOIDED

$$\frac{d\sigma_{\text{NLOwPS}}}{d\mathcal{O}} = \left[ d\Phi_m (B + \int_{\text{loop}} V + \int d\Phi_1 MC) \right] I_{\text{MC}}^{(m)}(\mathcal{O})$$

$$+ \left[ d\Phi_{m+1} (R - MC) \right] I_{\text{MC}}^{(m+1)}(\mathcal{O})$$

- Expanded at NLO

$$I_{\text{MC}}^{(m)}(\mathcal{O}) d\mathcal{O} = 1 - \int d\Phi_1 \frac{MC}{B} + \int d\Phi_1 \frac{MC}{B} + \dots$$

$$d\sigma_{\text{NLOwPS}} = \left[ d\Phi_m (B + \int_{\text{loop}} V + \int d\Phi_1 MC) \right] I_{\text{MC}}^{(m)}(\mathcal{O}) d\mathcal{O}$$

$$+ \left[ d\Phi_{m+1} (R - MC) \right]$$

$$\simeq d\Phi_m (B + \int_{\text{loop}} V) + d\Phi_{m+1} R = d\sigma_{\text{NLO}}$$

## SMOOTH MATCHING

$$\frac{d\sigma_{\text{NLOwPS}}}{dO} = \left[ d\Phi_m (B + \int_{\text{loop}} V + \int d\Phi_1 MC) \right] I_{\text{MC}}^{(m)}(O) \\ + \left[ d\Phi_{m+1} (R - MC) \right] I_{\text{MC}}^{(m+1)}(O)$$

- Smooth matching:

- Soft/collinear region:  $R \simeq MC \Rightarrow d\sigma_{\text{MC@NLO}} \sim I_{\text{MC}}^{(m)}(O) dO$
- Hard region, shower effects suppressed, ie.

$$MC \simeq 0 \quad I_{\text{MC}}^{(m)}(O) \simeq 0 \quad I_{\text{MC}}^{(m+1)}(O) \simeq 1$$

$$\Rightarrow d\sigma_{\text{MC@NLO}} \sim d\Phi_{m+1} R$$

## STABILITY & UNWEIGHTING

$$\frac{d\sigma_{\text{NLOwPS}}}{dO} = \left[ d\Phi_m(B + \int_{\text{loop}} V + \int d\Phi_1 MC) \right] I_{\text{MC}}^{(m)}(O) \\ + \left[ d\Phi_{m+1}(R - MC) \right] I_{\text{MC}}^{(m+1)}(O)$$

- The **MC** subtraction terms are defined to be what the shower does to get from the  $m$  to the  $m+1$  body matrix elements. Therefore the cancellation of singularities is exact in the  $(R - \text{MC})$  term: there is no mapping of the phase-space in going from events to counter events as we saw in the FKS subtraction

- The integral is bounded all over phase-space; we can therefore generate **unweighted events!**

- “S-events” (which have  $m$  body kinematics)
- “H-events” (which have  $m+1$  body kinematics)

# EXAMPLE : TTBAR PRODUCTION

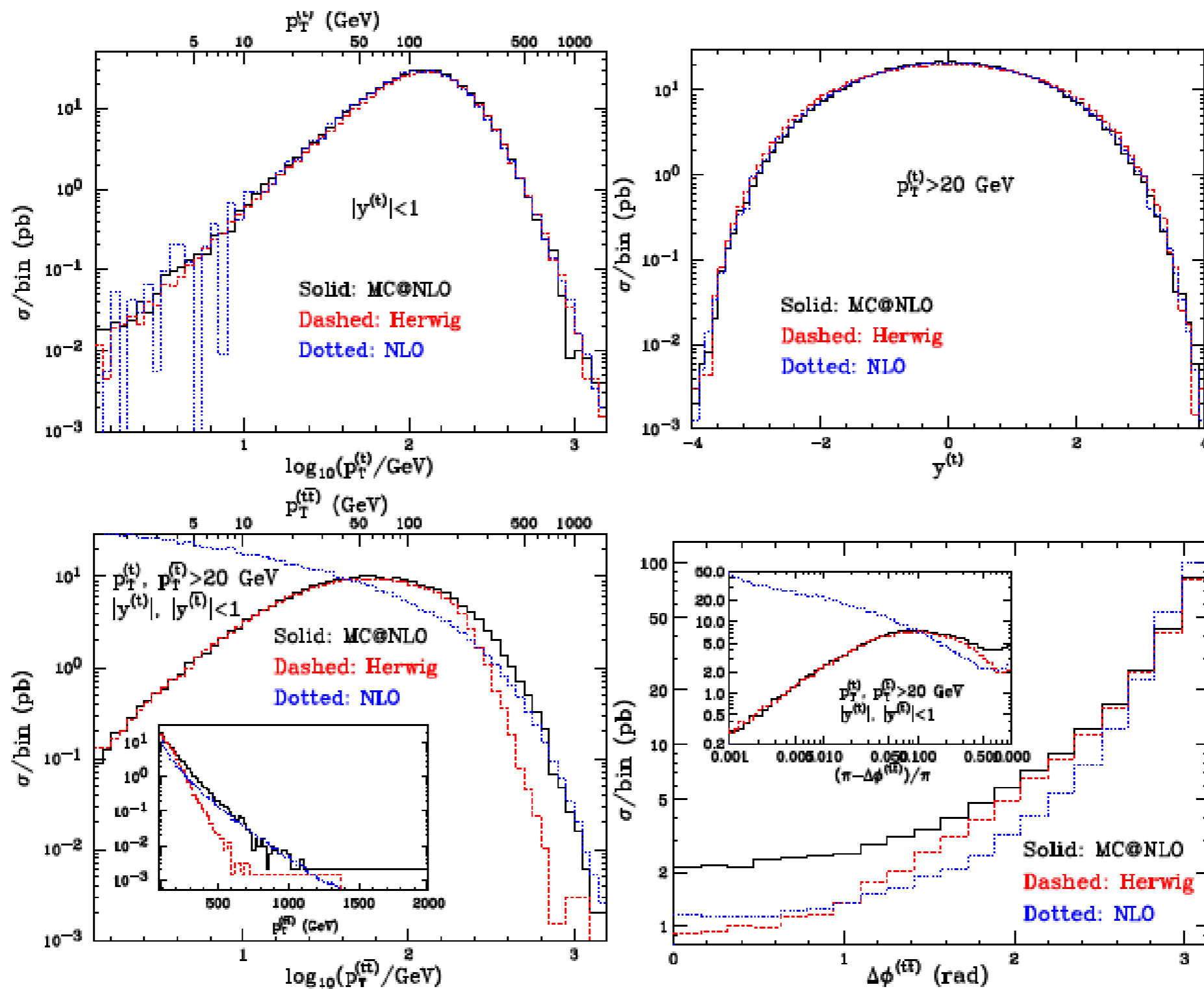

# SUMMARY

- We want to match NLO computations to parton showers to keep the good features of both approximations
- In the **MC@NLO** method:  
by including the shower subtraction terms in our process we avoid double counting between NLO processes and parton showers
- In the **POWHEG** method:  
apply an overall K-factor, and modify the (Sudakov of the) first emission to fill the hard region of phase-space according to the real-emission matrix elements
- First studies to combine NLO+PS matching with ME+PS merging have been made..

# MULTI-JET MERGING @ NLO

[Hoeche et al., 1207.5030]

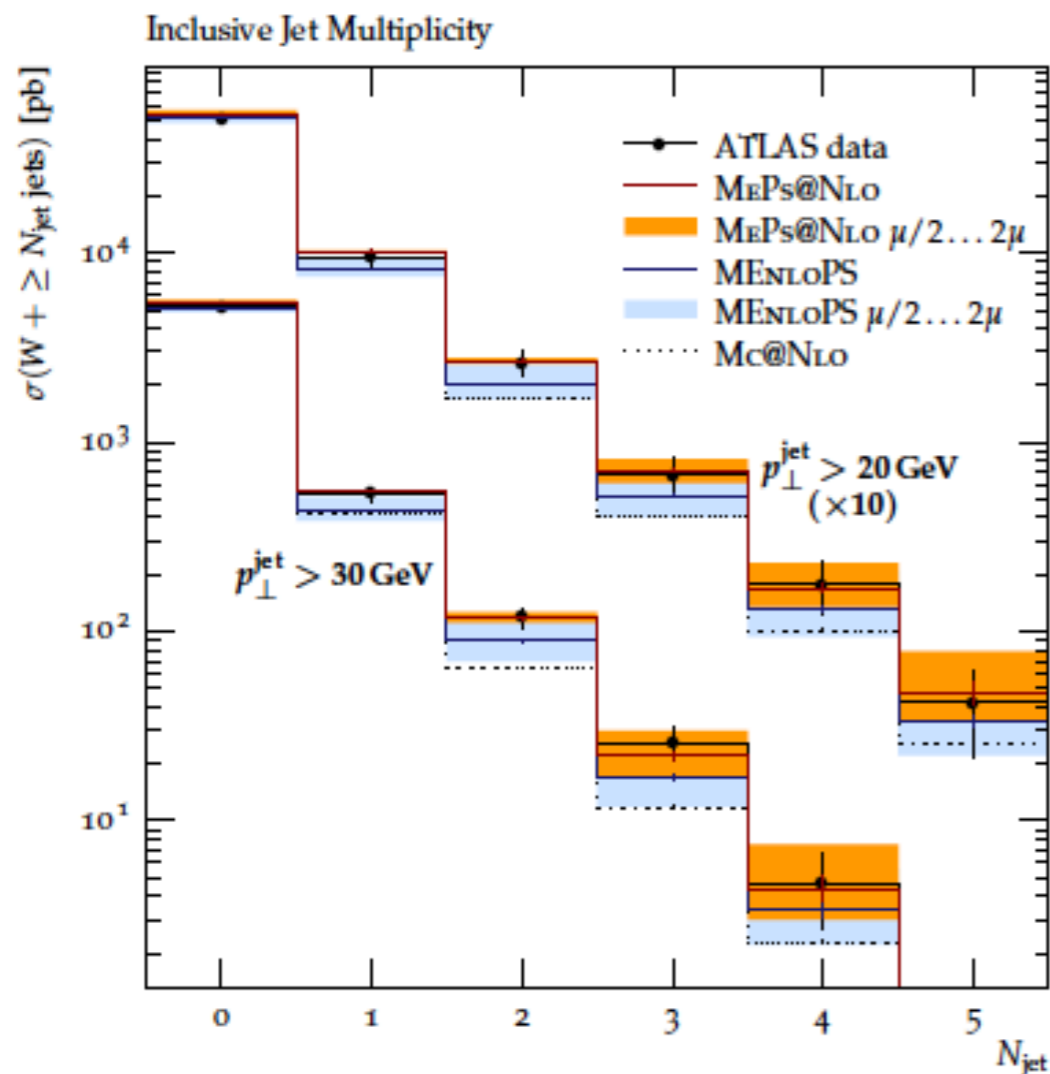

[Frederix, Frixione, 1209.6215]

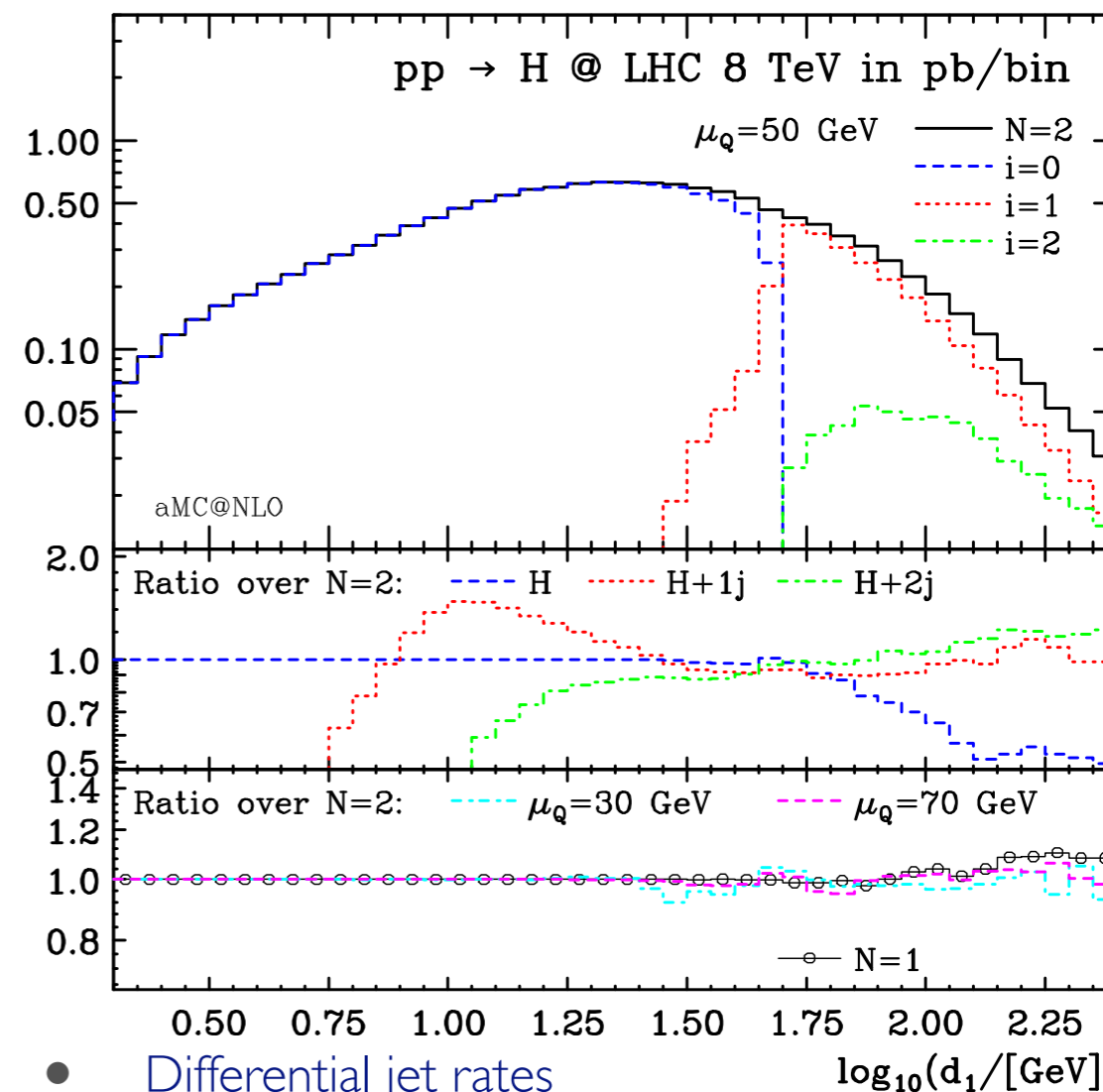

- Jet rates
- Up to 3 extra jets at NLO
- Various approaches give consistent results

- Differential jet rates
- Matching up to 2 jets at NLO : consistent with up to 1 more jet.
- Method works for  $t\bar{t}$ +jets and  $W$ +jets equally well.



# SM STATUS CIRCA 2002

$pp \rightarrow n \text{ particles}$

# SM STATUS CIRCA 2002

$pp \rightarrow n$  particles

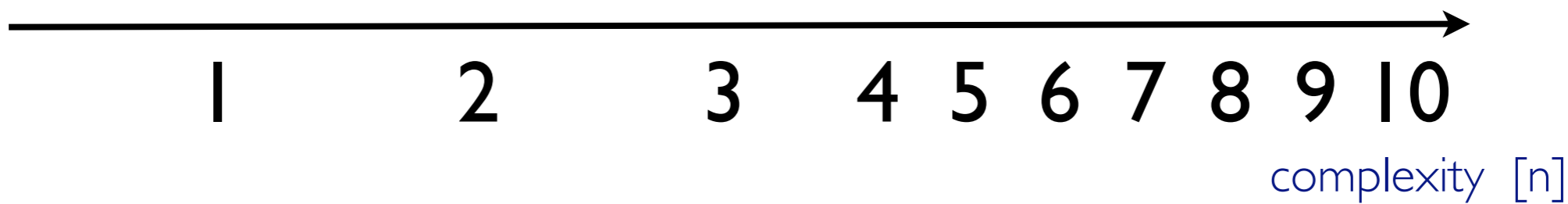

# SM STATUS CIRCA 2002

$pp \rightarrow n$  particles

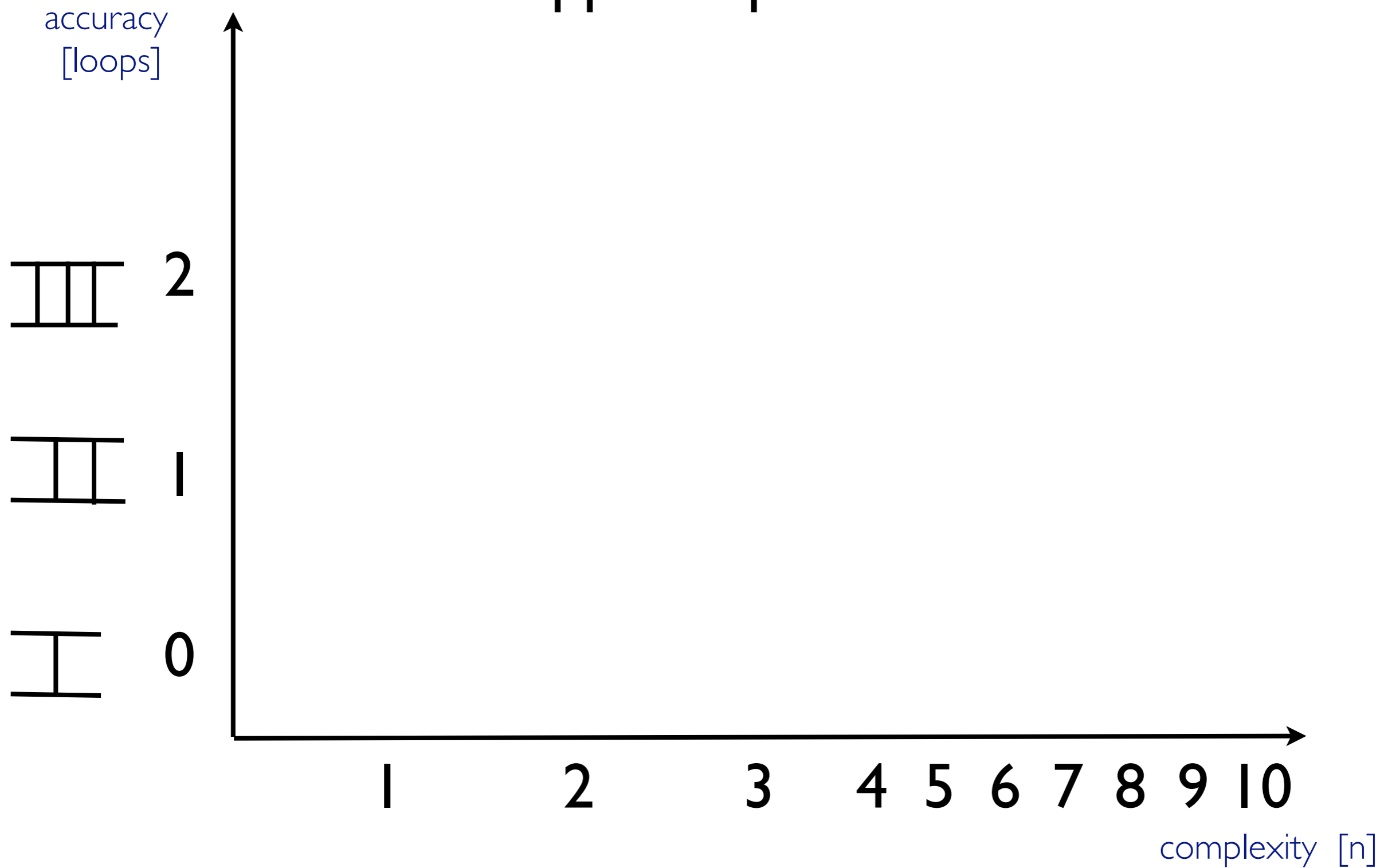

# SM STATUS CIRCA 2002

## $pp \rightarrow n$ particles

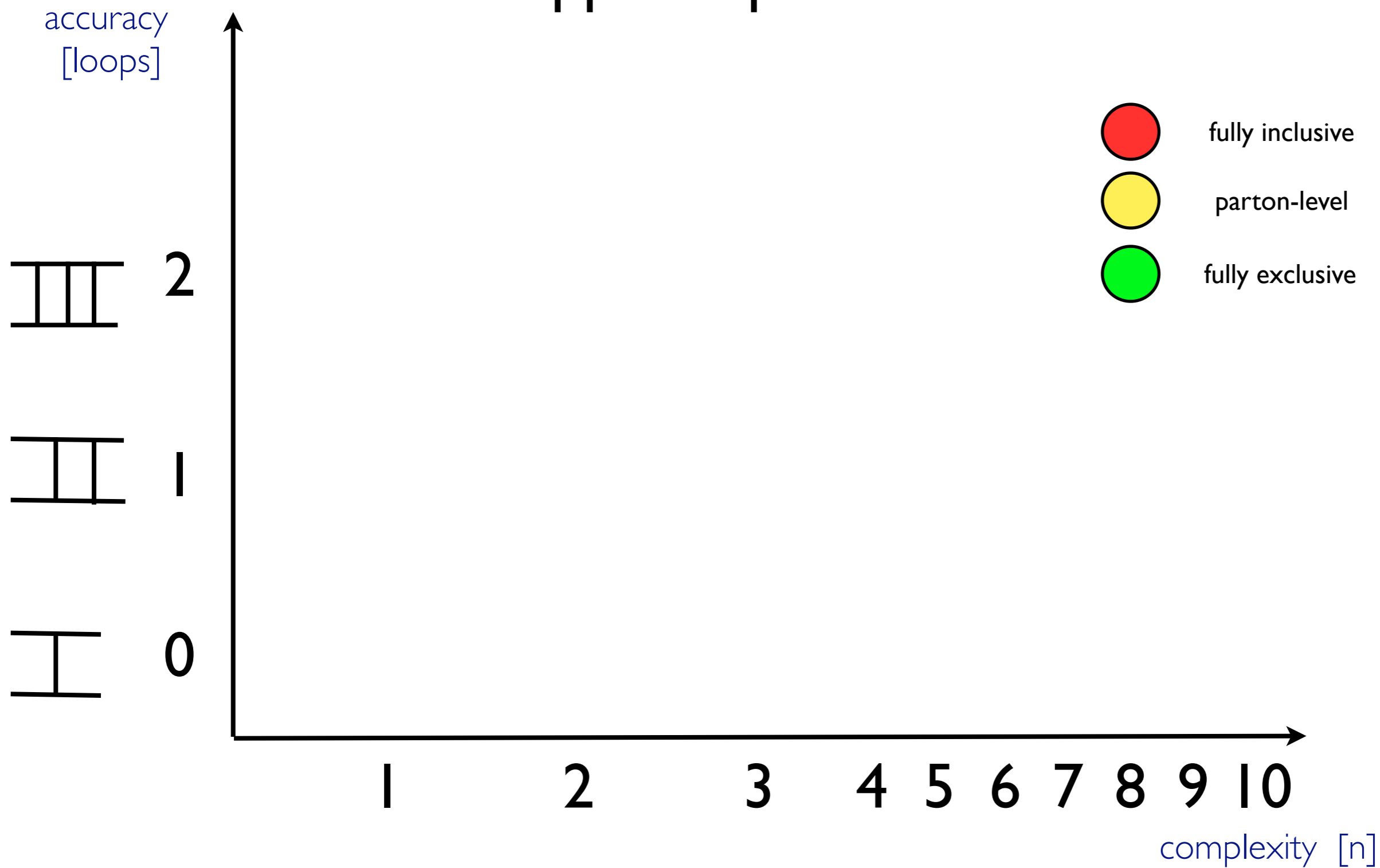

# SM STATUS CIRCA 2002

## $pp \rightarrow n$ particles

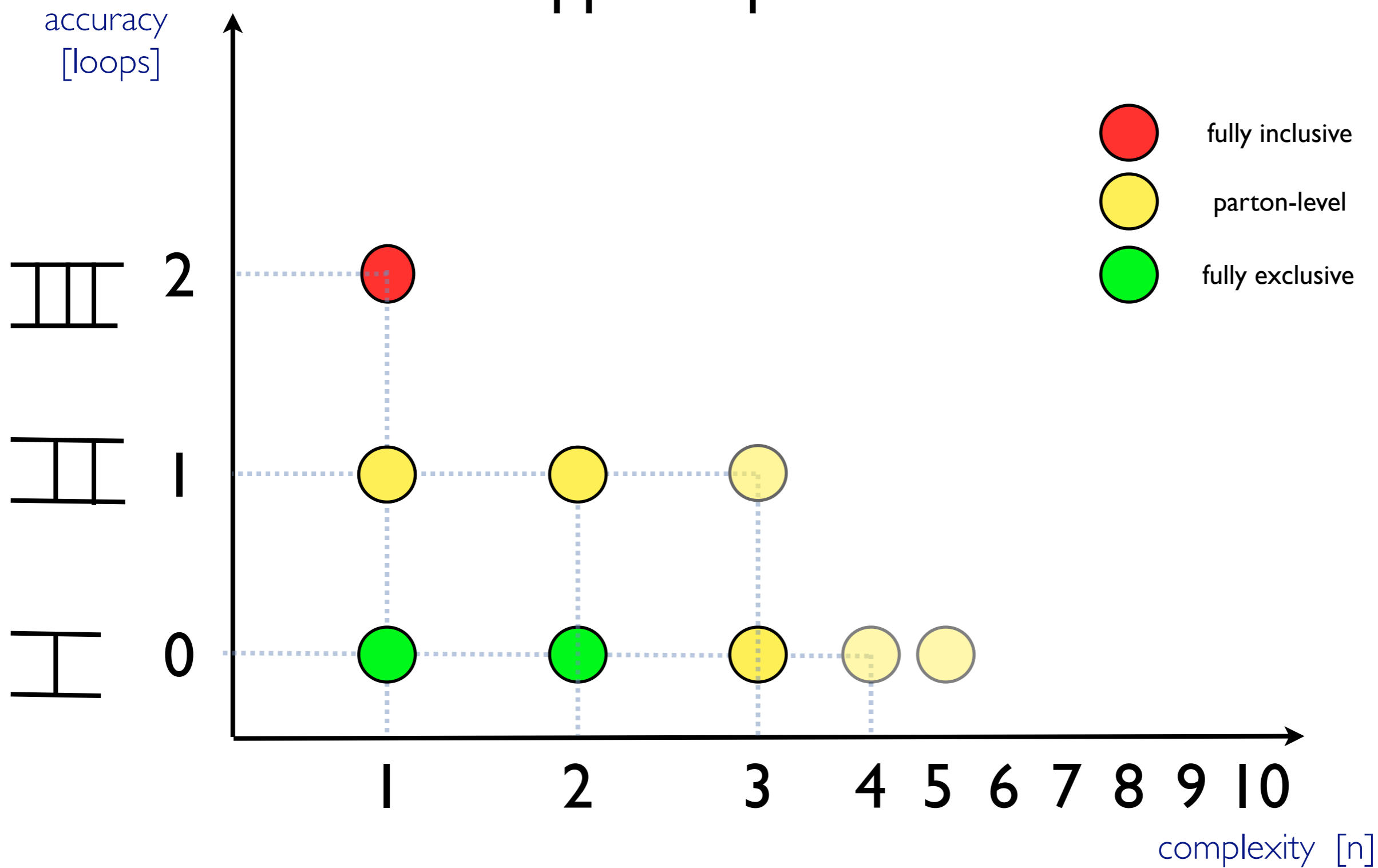

# STATUS: NOW

## $pp \rightarrow n$ particles

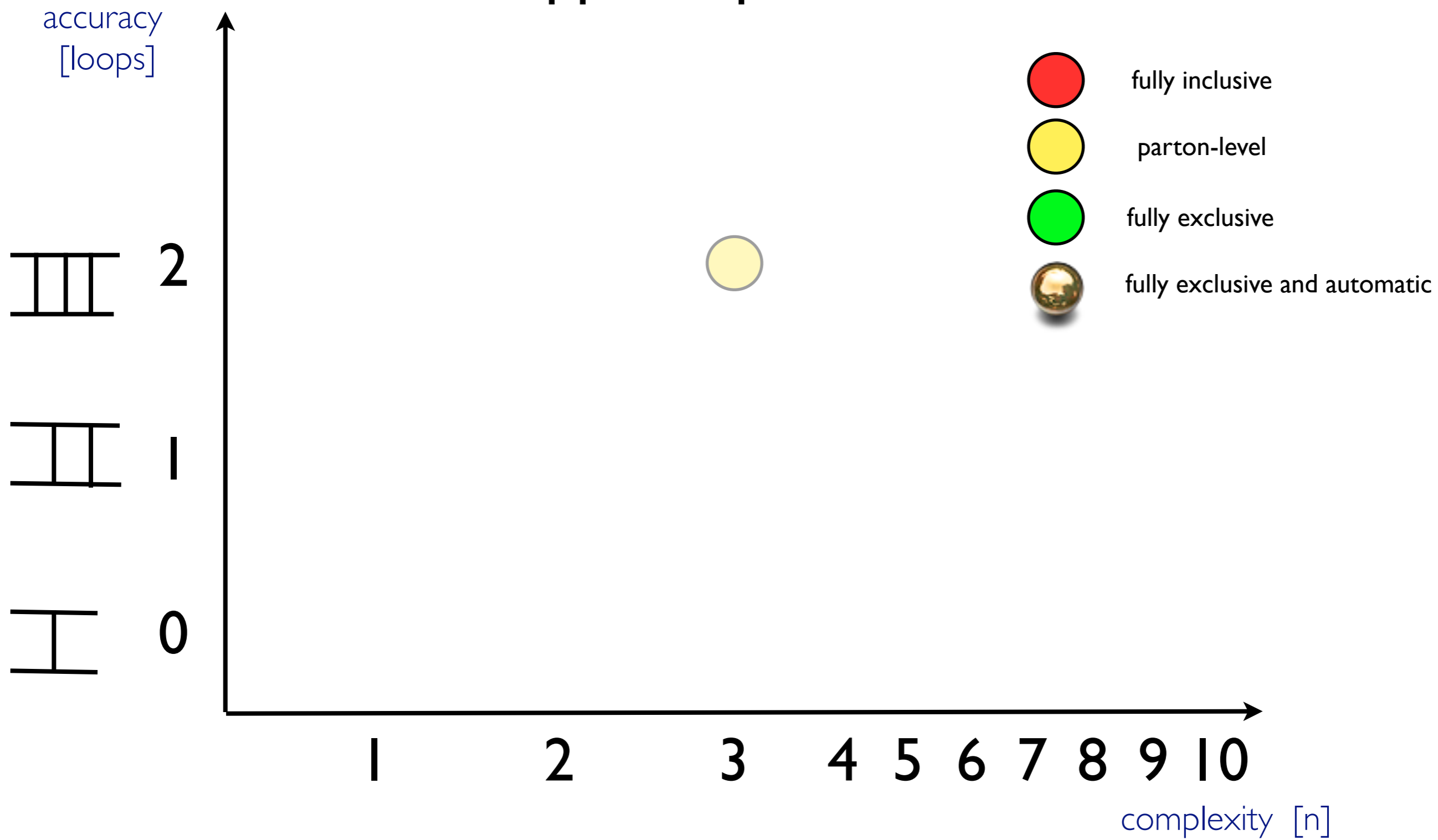

# STATUS: NOW

## $pp \rightarrow n$ particles

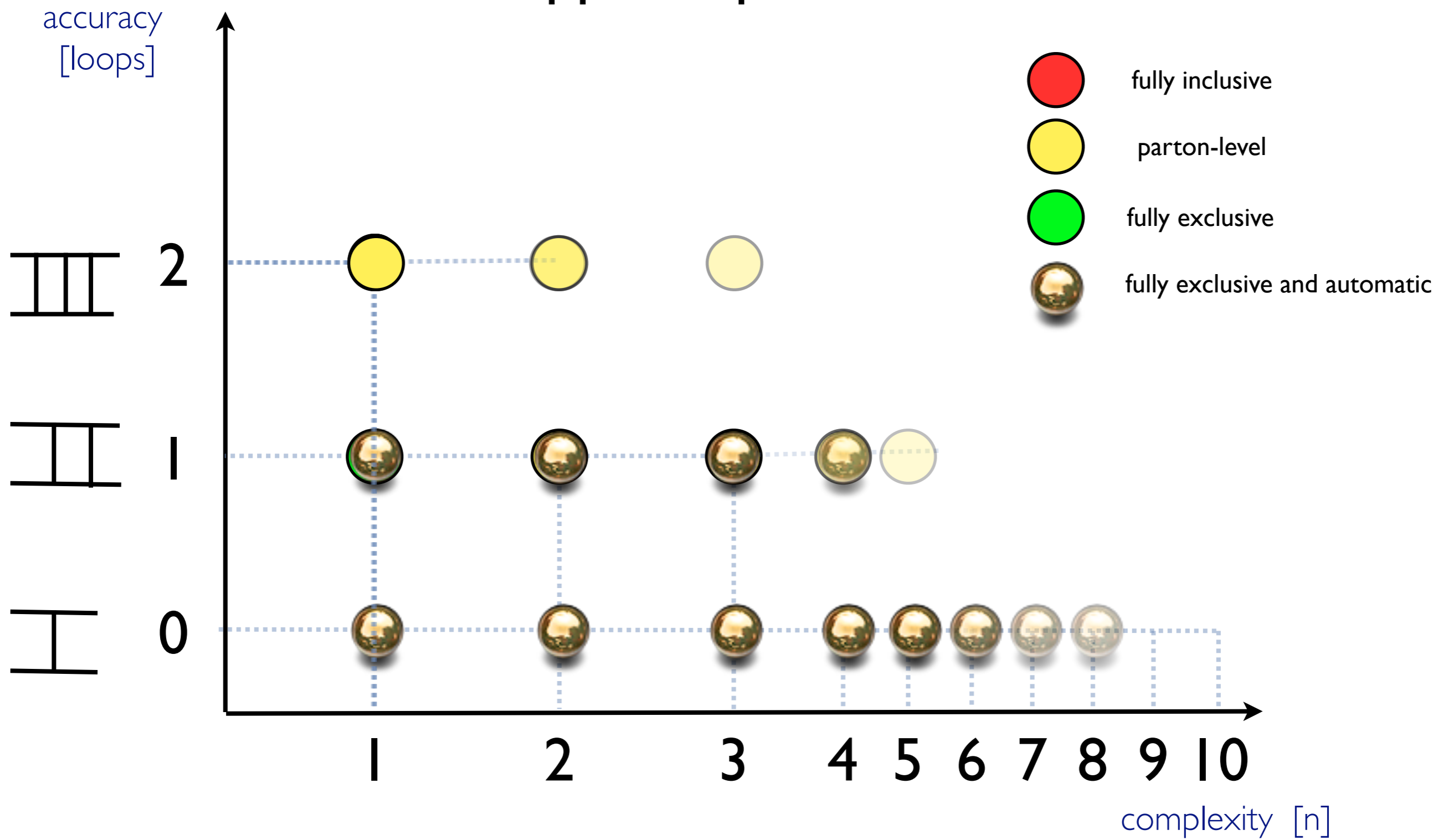

# CONCLUSIONS

- ◆ The need for better description and more reliable predictions for SM processes for the LHC has motivated a significant increase of theoretical and phenomenological activity in the last years, leading to several important achievements in the field of QCD and MC's.
- ◆ A new generation of tools and techniques is now available.
- ◆ New techniques and codes available for interfacing at LO and NLO computations at fixed order to parton-shower has been proven for SM (and BSM).
- ◆ Unprecedented accuracy and flexibility achieved.
- ◆ EXP/TH interactions enhanced by a new framework where exps and theos speak the same language.





# CREDITS

To organize this presentation I have benefited from lectures (and actual slides), talks and discussions with many people.

In particular:

- Mike Seymour (MC basics)
- Claude Duhr (FeynRules)
- Johan Alwall (ME+PS merging)
- Rikkert Frederix, Paolo Torrielli (NLO+PS)
- Stefano Frixione, Michelangelo Mangano, Paolo Nason (for QCD, PS, LO, NLO, and more...)
- ....

Whom I all warmly thank!!