

Large COMPASS polarized solid state target for Drell-Yan physics

Jaakko Koivuniemi
CERN/PH

September 15, 2015

Abstract

SPS, Drell-Yan physics, magnet, dilution cryostat, hadron absorber, target holder without hydrogen bonds, NMR, commissioning 2014, run 2015



NA58 COMPASS polarised target

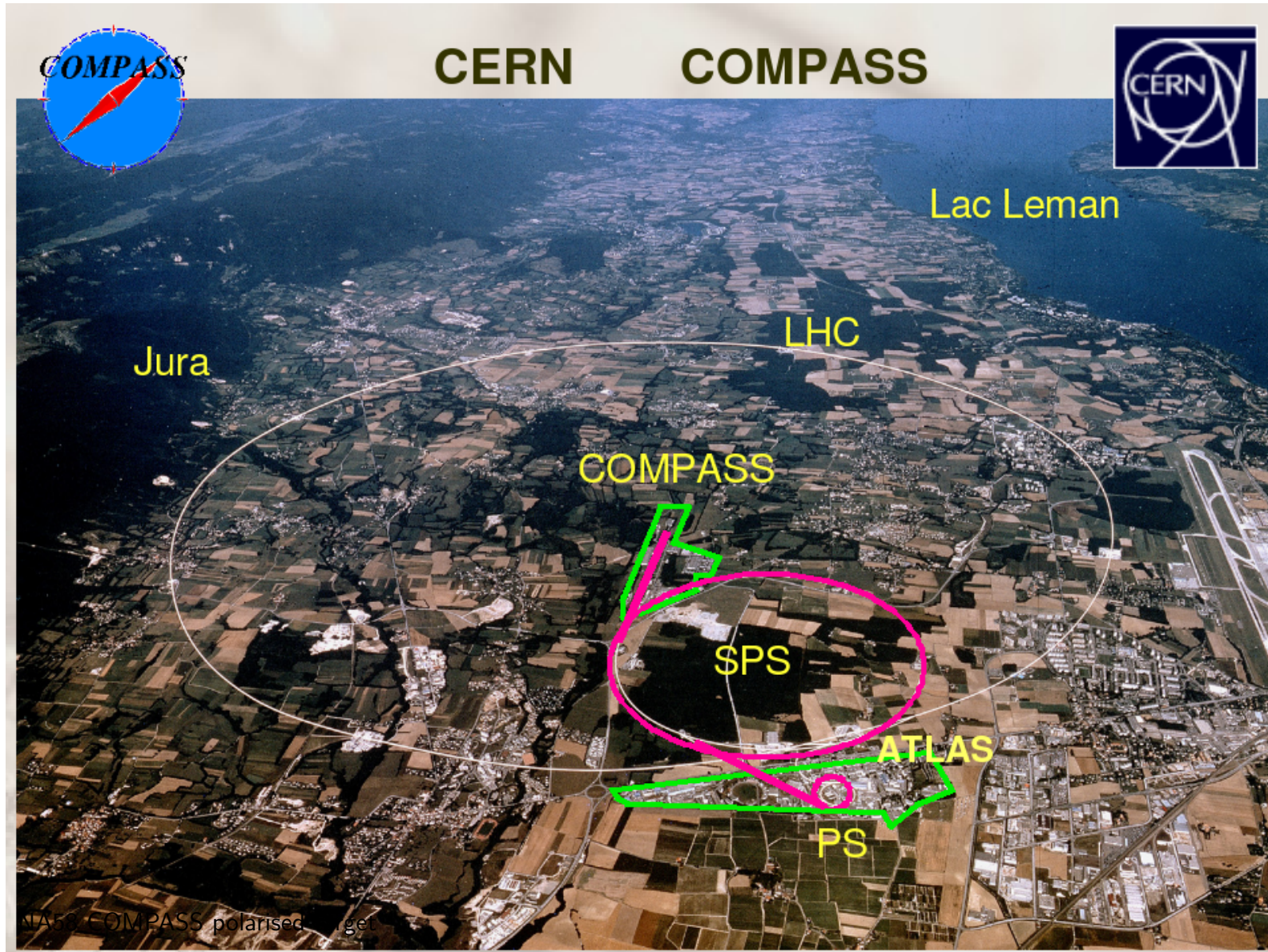

Proton: view of an artist

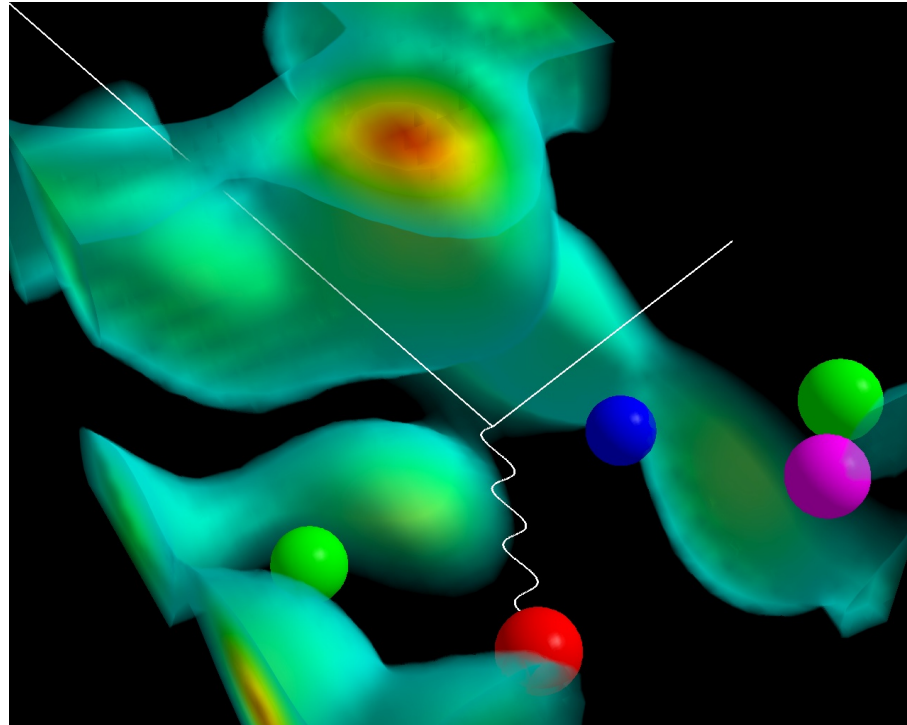

<http://www.physics.adelaide.edu.au/theory/staff/leinweber/VisualQCD/QCDvacuum/welcome.html>



NA58 COMPASS polarised target

CERN Accelerator Complex

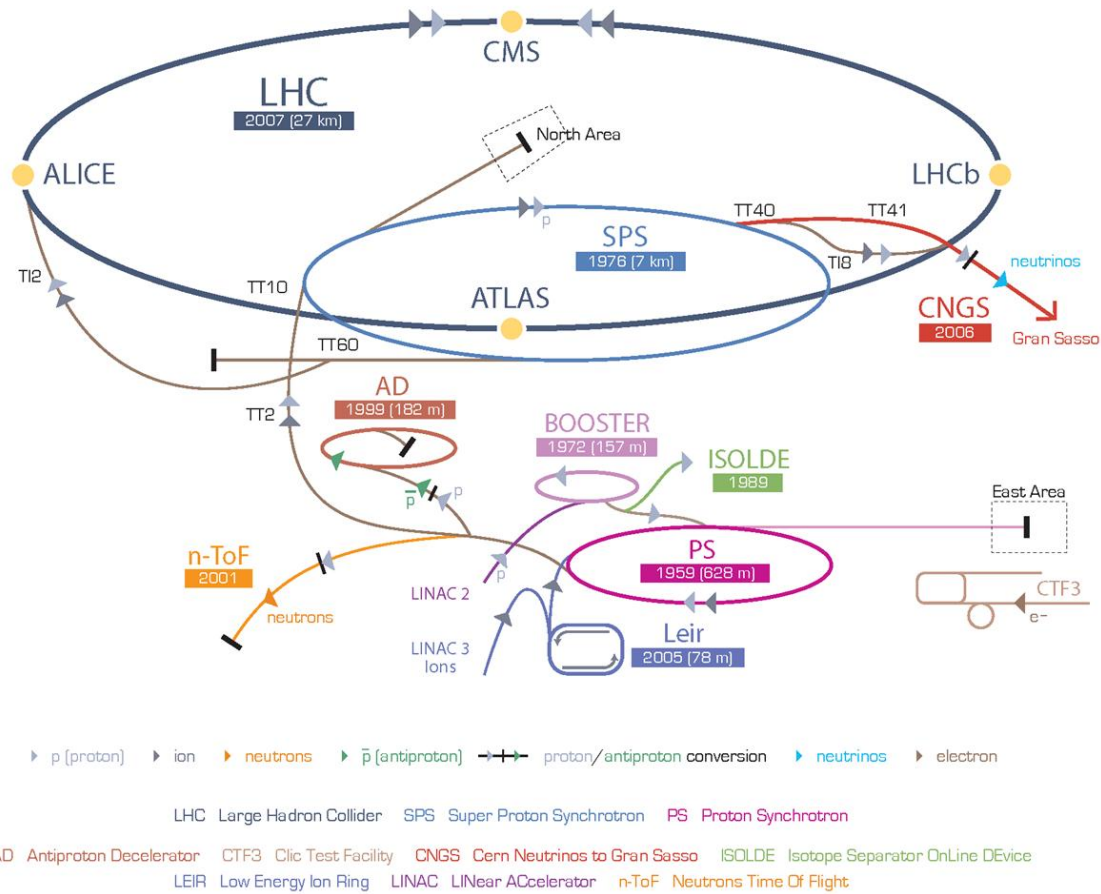

Super Proton Synchrotron (SPS) and COMPASS

- T6 Beryllium production target for North Area
- negative hadron beam with momentum 190 GeV/c: 97 % π^- , 2.5 % K^- and 0.5 % \bar{p}
- beam intensity up to 10^8 particles/s
- 2×55 cm long 4 cm diameter transversely polarized solid target with 20 cm separation
- hadron absorber aluminium and tungsten (also a target)



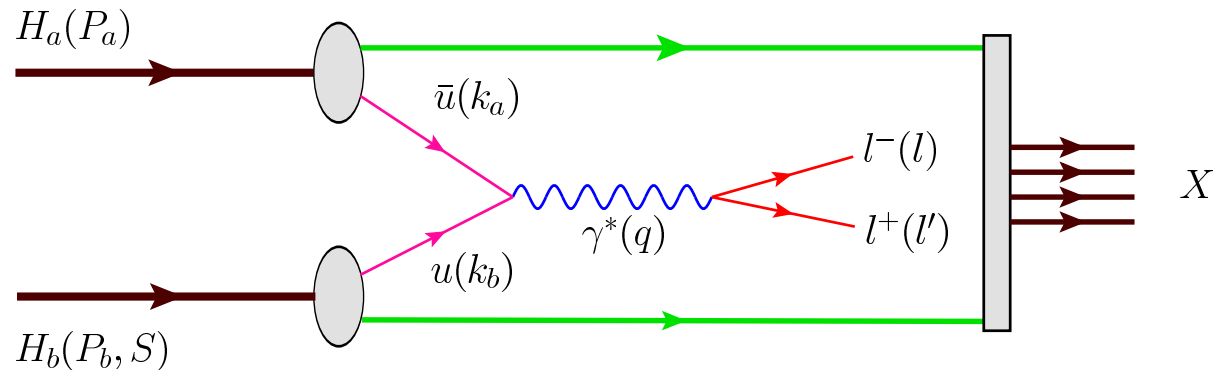

Hadron absorber

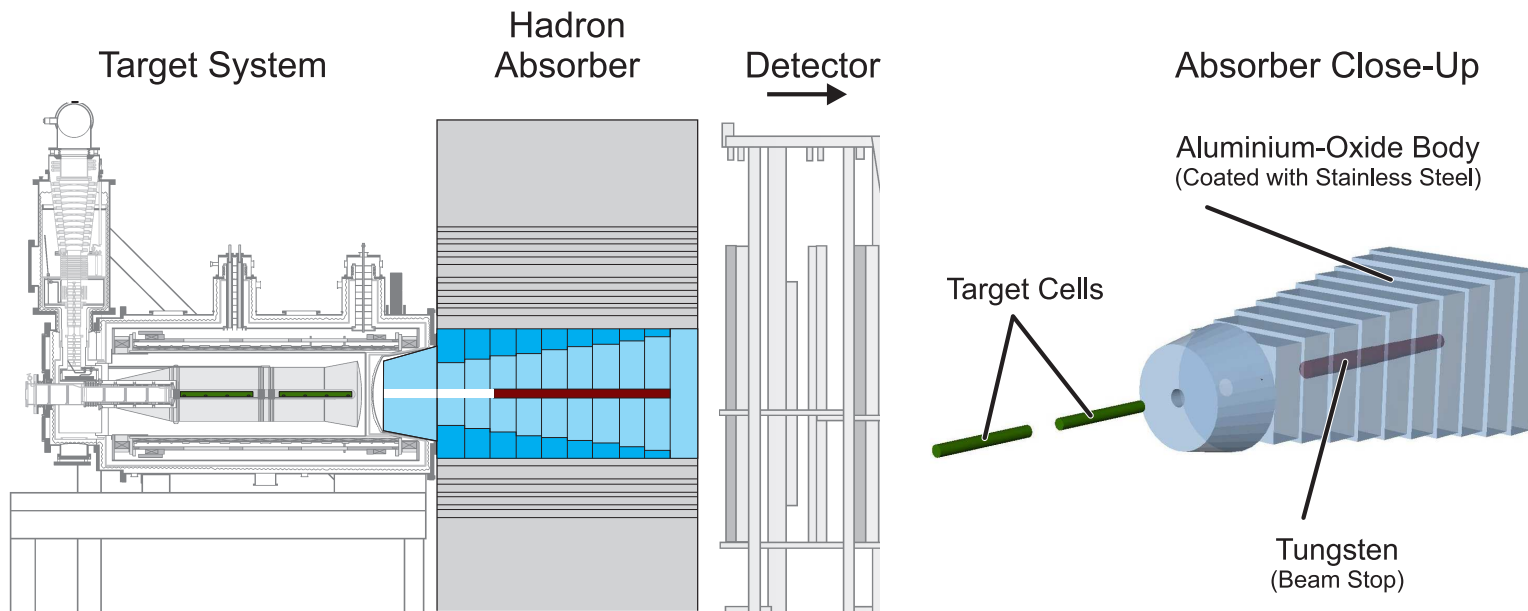

Polarizable solid ammonia production 2011

- June 2011: 9 samples were irradiated in Bonn linac
- total dose controlled from charge detector behind sample
- irradiation time 9 - 15 hours
- target cell volumes 691 ccm + 691 ccm
- material loaded for runs 2014 and 2015 with some old material
- EPR signal from $\dot{\text{N}}\text{H}_2$



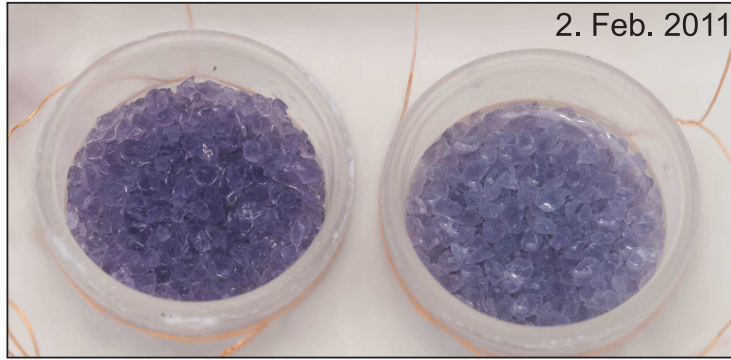

1 week ...

2 weeks ...

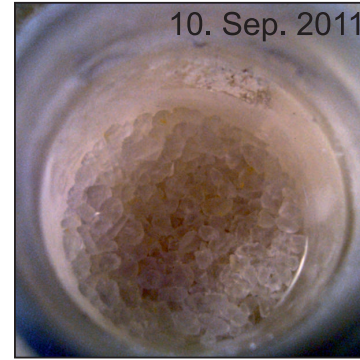

7 month ...

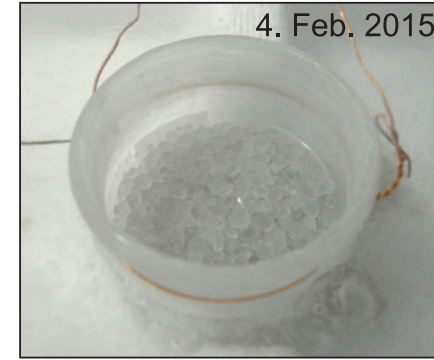

4 years ... after irradiation



Dilution cryostat

- high cooling power helium-3/4 dilution cryostat ~ 350 mW at 300 mK
- base temperature below ~ 40 mK (no calibrated thermometers below 50 mK)
- new pumping lines welded 2014
- helium-4 pump system
- helium-3 pump system new water cooled heat exchangers
- isolation vacuum pump system



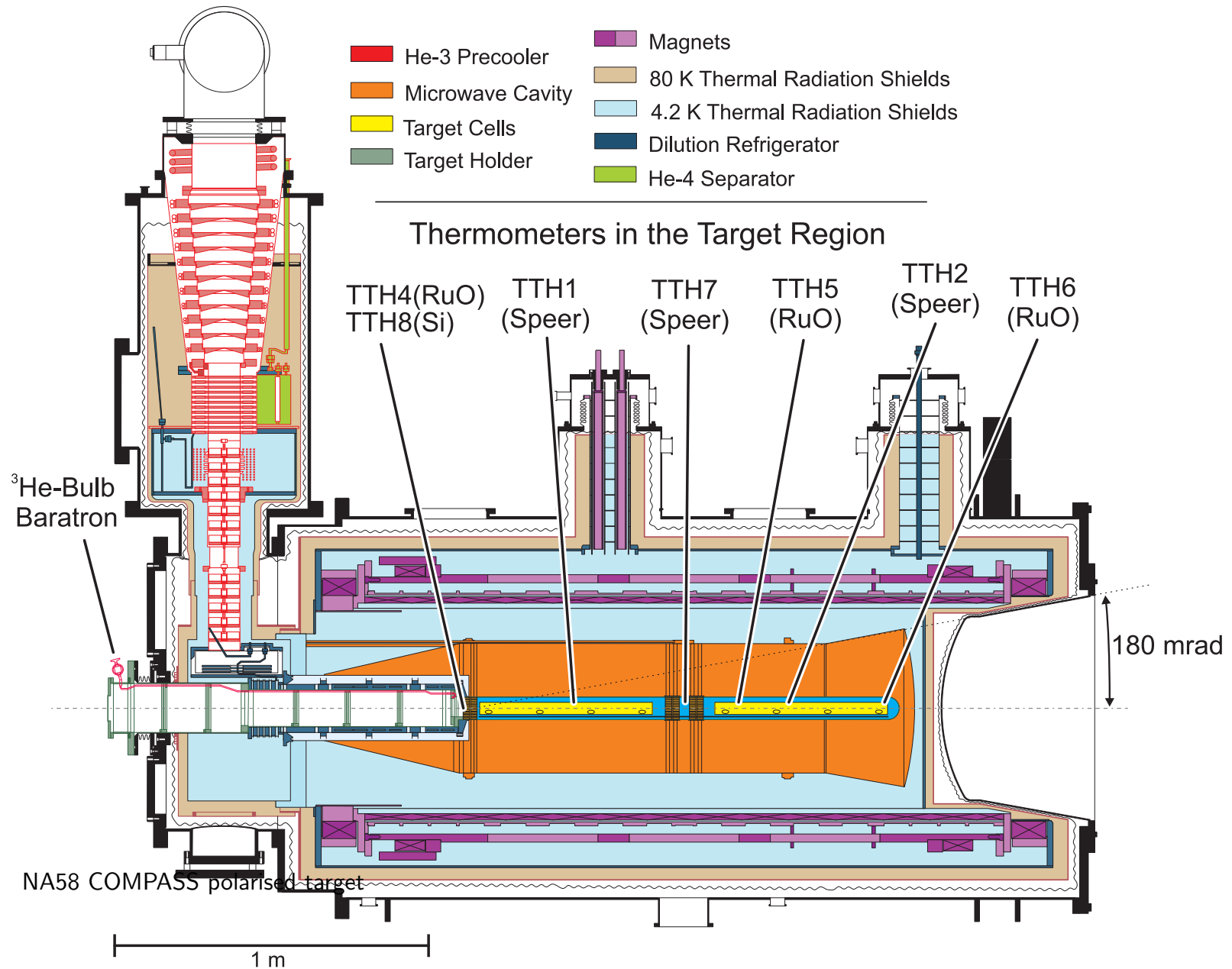

June 2014



NA58 COMPASS polarised target

March 2015

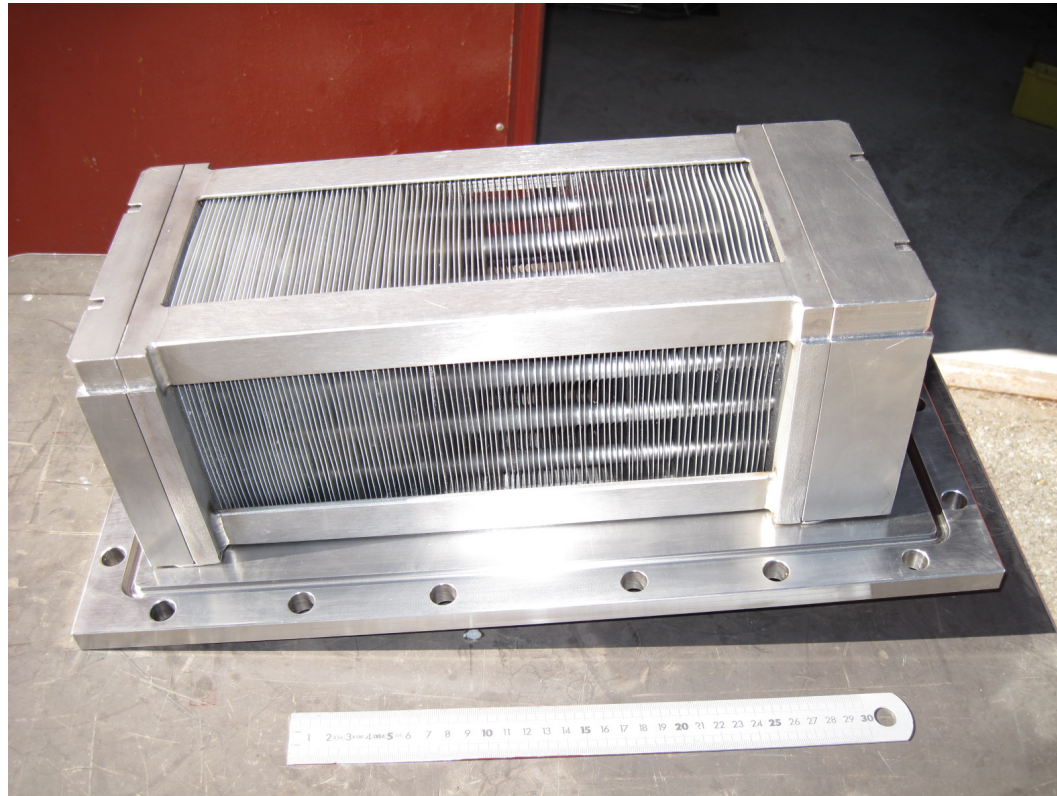

NA58 COMPASS polarised target

Applications Places System 19 °C Thu Sep 10, 14:18 jaakko

Vision_1: DCSPanel (on pccompass07.cern.ch)

DETECTOR CONTROL SYSTEM

operator Exit UI 6 14:18:10 Thursday 10.09.2015

HOME

BMS	Cedar
SCIFI	W45
GEM	Trigger
DC	MM
Straw	RWall
RICH	MWPC
MW1	MW2
HCal1	HCal2
PTgt	DAQ
Magnets	Beam
Environ	DCS

T6 head Be 500x160x2 mm3

DON'T CHANGE ELEMENTS LISTED BELOW

Beam file loaded
M2A.M2A.519: Drell-Yan

GEM1-10 centres OFF

DC centres INACTIVE

SM1 ON

SM2 ON

Target solenoid OFF

Target dipole ON

Custom Plot

ALARMS

lev	pr	time	object	alert text	value	ack	det
E	60	2015.09.10 11:50:52.852	T6 Intensity: total number of spills with non-nominal intensity	Too many bad spills	10		...

Polarized Target

Temperatures	Microwaves and NMR	Magnet	Pumps	Dilution Refrigerator
--------------	--------------------	--------	-------	-----------------------

Dilution Refrigerator

3He pumping line

4He pumping line

He return (to liquifier)

From buffer Dewar LHe

Separator

Still

Target holder vacuum

Mixing chamber

MW cavity

Legend:

- 3He gas
- 3He liquid
- He mixture
- 4He gas
- 4He liquid
- Roots pump(s)
- Rotary pump(s)
- Heat exchanger
- Needle valve
- Mass flow meter

Configurations

General views: Temperatures, Pressures

Siemens PLC

NA58 COMPASS polarised target

50 years of dilution cryostat

- H. London, G. R. Clarke and E. Mendoza, Phys. Rev. **128** (1962) 1992–2005 *Osmotic Pressure of He^3 in Liquid He^4 , with Proposals for a Refrigerator to Work below 1 K*
- P. Das, R. de Bruyn Ouboter and K. W. Taconis, Low Temperature Physics LT9 (1965) 1253–1255, *A Realization of a London-Clarke-Mendoza type refrigerator*
- T. O. Niinikoski, NIMA **97** (1971) 95–101, *A Horizontal dilution refrigerator with very high cooling power*



PCTFE target cells

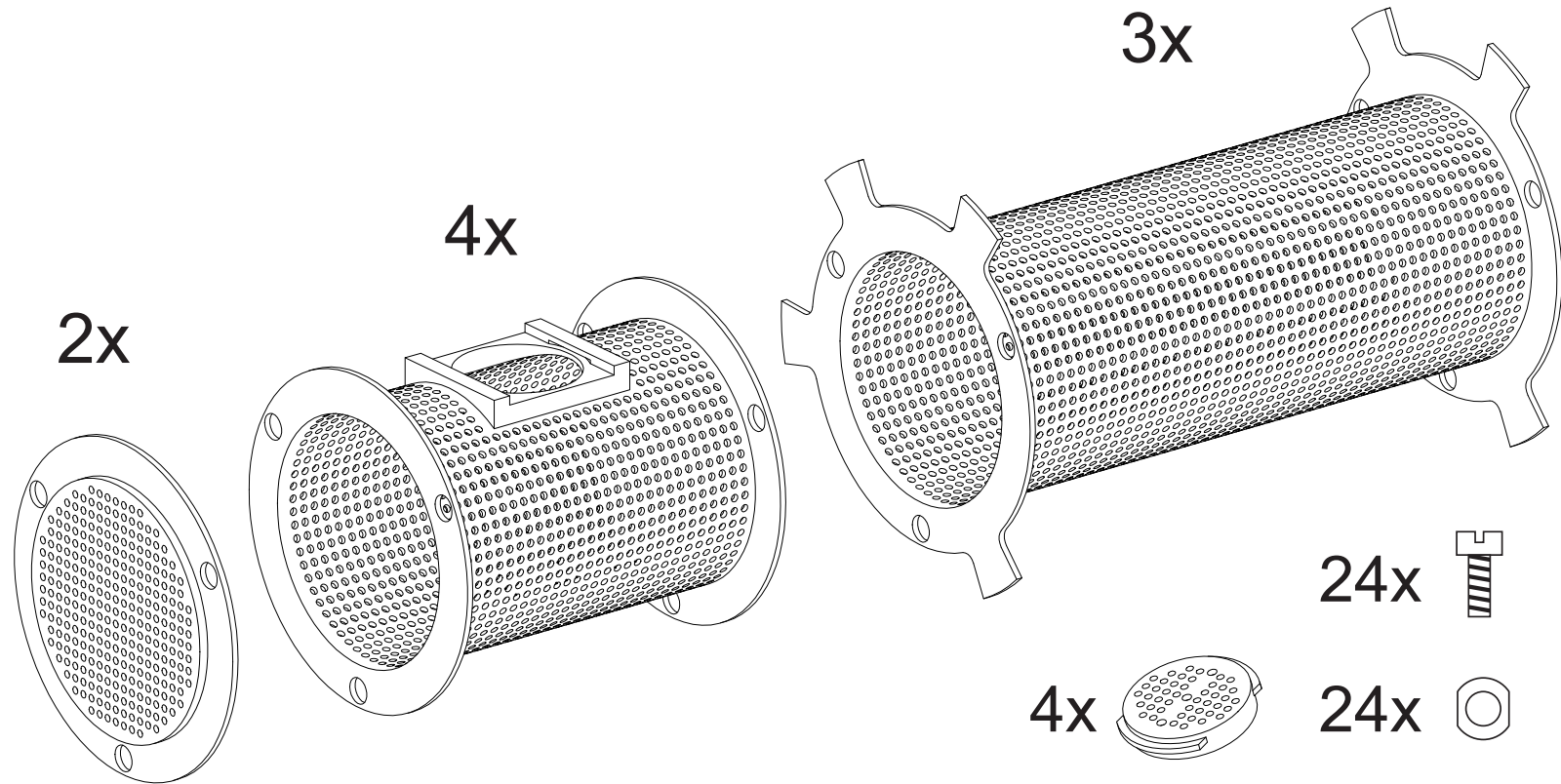

NMR system

- LabVIEW and PXI crate moved to control room (radiation)
- NMR rack moved below target platform with lead shielding
- fixed firmly on floor due to magnetic field
- Liverpool Q-meters tuned on 106 MHz still in use
- integration with new magnet control system
- stable operation without problems so far





NA58 COMPASS polarised target

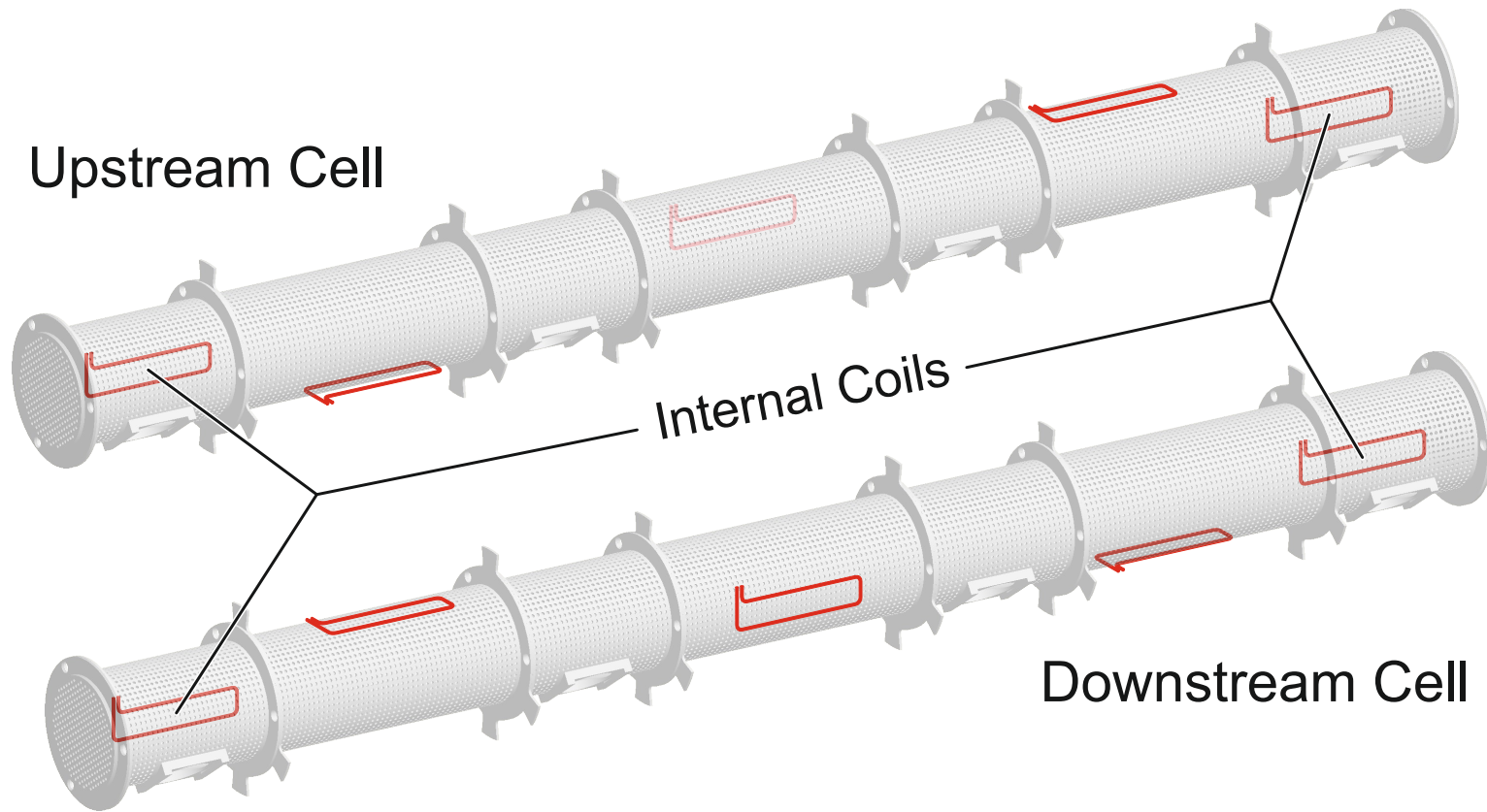

150703_211139.sig coil 3

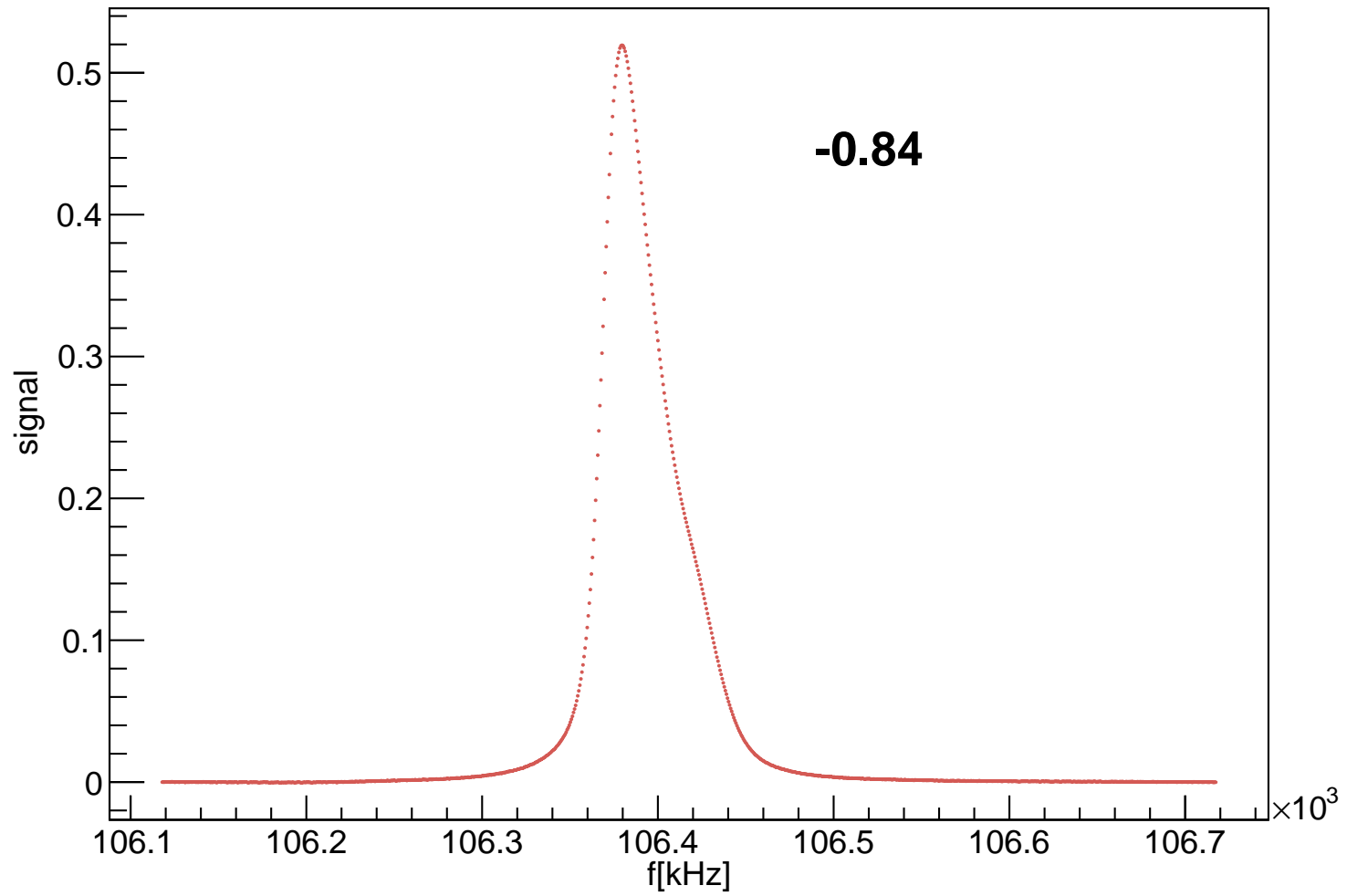

Rebuild target magnet system

- 2.5 T longitudinal solenoid field
- 0.63 T transverse dipole field
- large acceptance of 180 mrad, large bore diameter of ~ 620 mm
- run 2011: problems in magnet operation due to short in trim coils
- magnet opened, problems investigated and solved
- add cryocooler on radiation shield



- rebuild cryogenic system with integration to CERN cryogenic controls
- new Magnet Safety System (MSS)
- new power converters with CERN support
- magnet to COMPASS March 2014
- first proton NMR signals seen December 2014
- automatic field operation procedures done with scripts



March 2014



March 2014

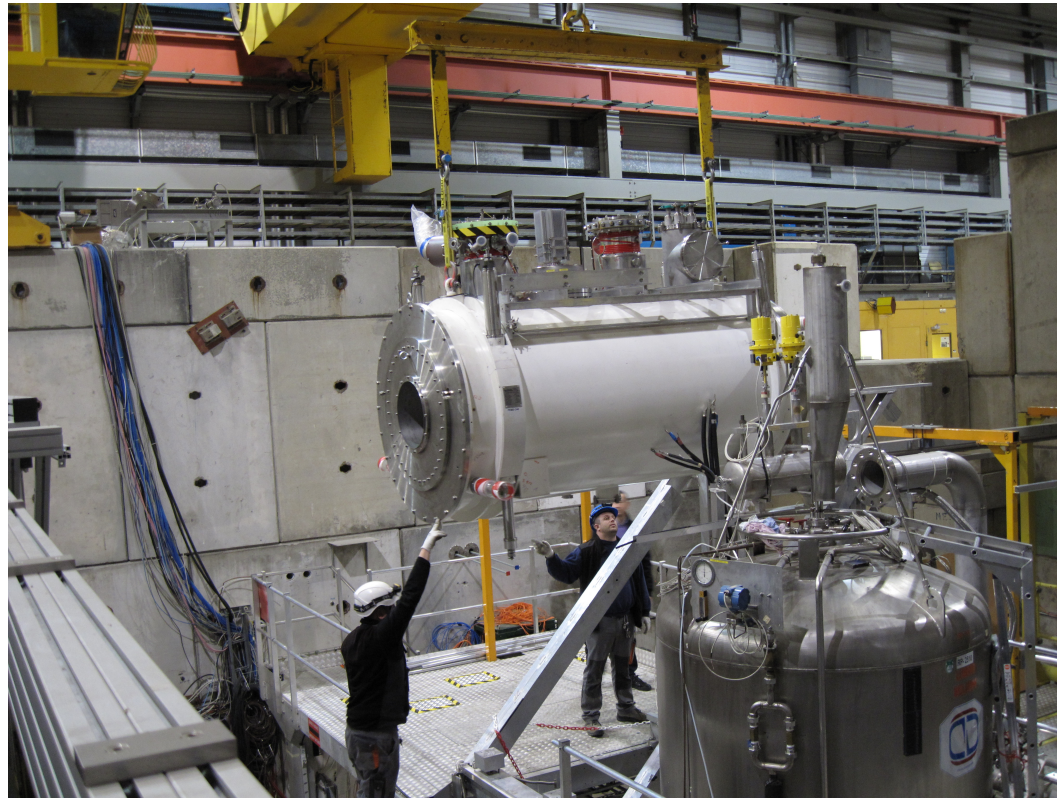

September 2015



September 2015

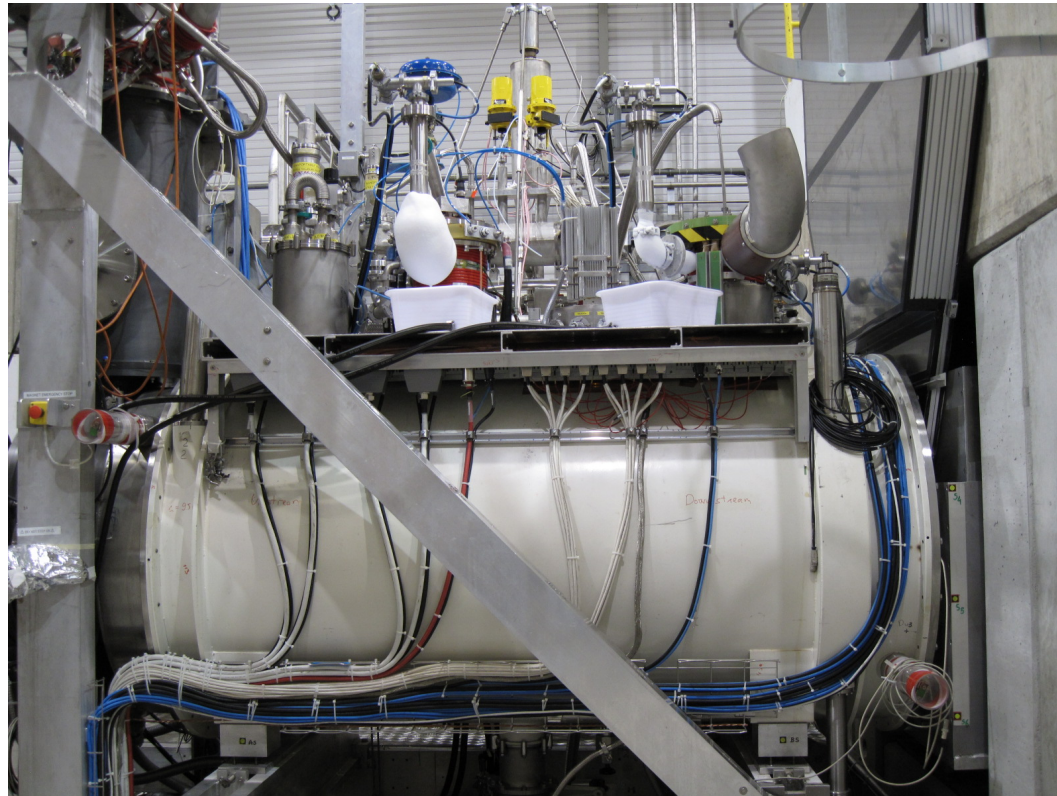

The screenshot displays the 'COMPASS Magnet Power Interface' software. The window title is 'cerntsice' and the application is 'unicoshMI_1: MCS_COMPASS'. The interface is divided into several sections:

- Navigation Panel (Left):** Includes 'System' (CoolDown, Temp + Pos, Vacuum, HEC System, Shim Coils, Main Power, Power Interface) and 'PLC Debug' (RKY0 Part1, RKY0 Part2, RKY1).
- System Information (Top):** Shows 'MCS' with a timestamp '5.09.13 08:08:41.860', 'START_TURBO', 'Full Stop Interlock Status' (FALSE), and '42 Unack.'.
- COMPASS Magnet Power Interface (Center):**
 - Dipole:** PSU Status is 'FLT_OFF'. Includes checkboxes for Power Failure, PC FastAbort, PC Permit, and Polarity (Changing, +, -).
 - Shim Coils:** A table of current values for H1(A) through H2(A), all with green status indicators.
 - MSS Status:** Shows 'IDLE' with a green indicator and buttons for 'RESET MSS' and 'SLOW DUMP'.
 - Solenoid/Dipole Operation:** A graph showing current levels over time from 9/13/2015 1:00:00 AM to 8:00:00 AM. The Y-axis ranges from -500 to 500. Below the graph, it shows 'Dipole 0.0' and 'Solenoid -647.04'.
 - Procedure Selection:** A dropdown menu with 'Please Select' and a 'Press to START' button. Below are buttons for 'NMR Baseline Ok' and 'To NMR Mode under test'.
- Input Fields (Bottom Left):** Includes 'I(A)' (-646.77), 'V(V)' (-3.70), and 'I Setting' (646.772).



NA58 COMPASS polarised target

70 GHz EIO microwave generator tubes

- two 20 W extended interaction oscillator (EIO) tubes
- Varian VPW2838 and CPI VPW2827 power supplies
- microwave guides from control room to dilution cryostat
- remote monitoring from COMPASS DCS
- [wiki/Extended_interaction_oscillator](#)



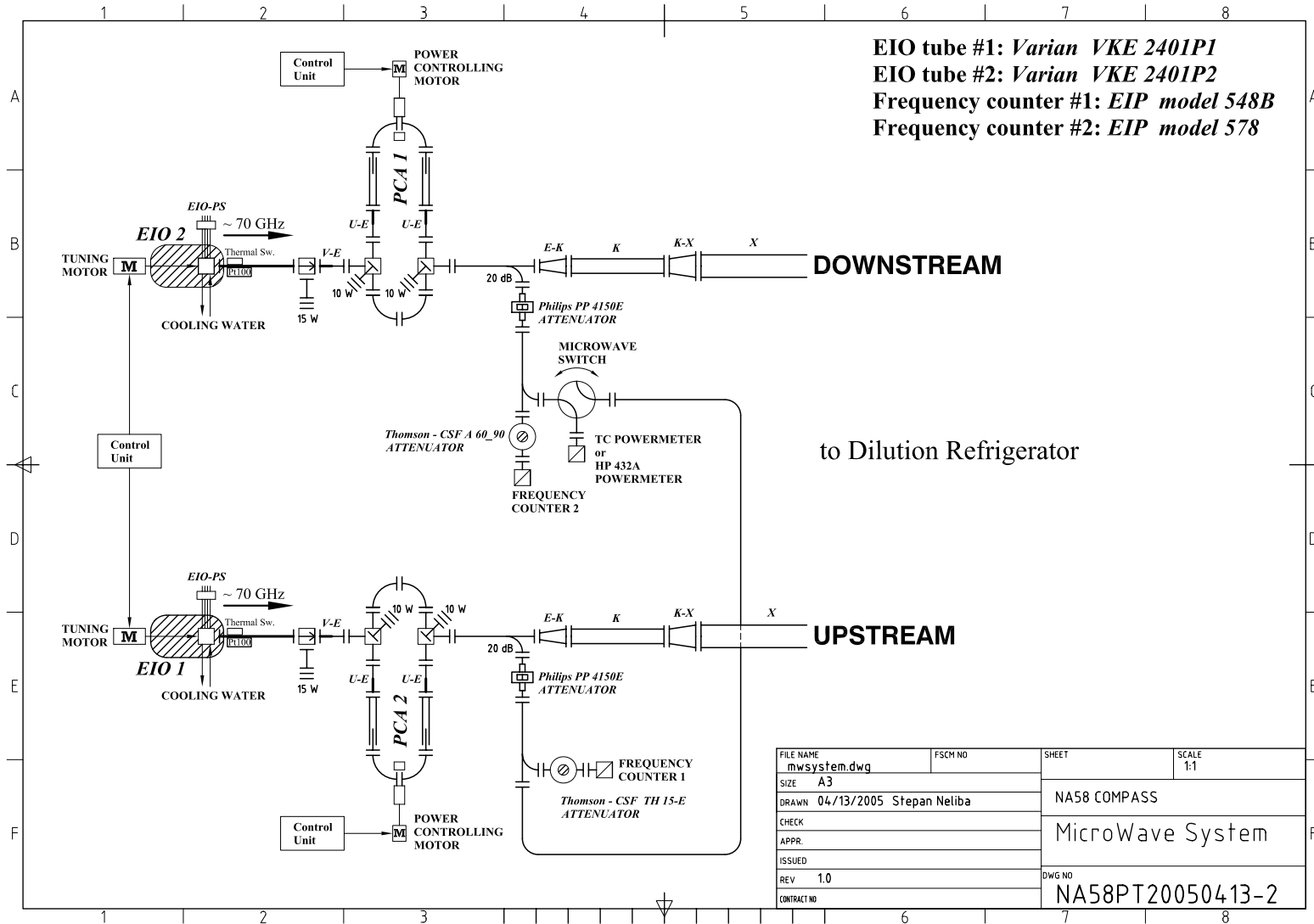

Drell-Yan 2015

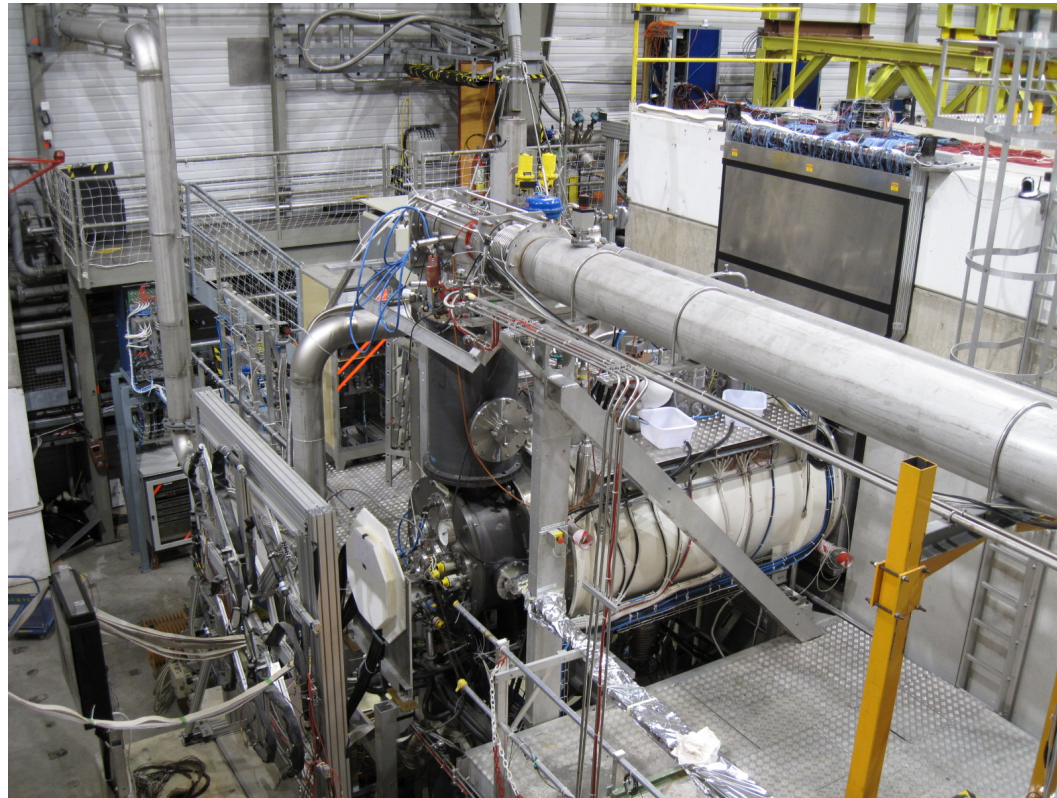

Backup slides



Three Generations
of Matter (Fermions)

	I	II	III	
mass →	2.4 MeV/c ²	1.27 GeV/c ²	171.2 GeV/c ²	0
charge →	2/3	2/3	2/3	0
spin →	1/2	1/2	1/2	1
name →	u up	c charm	t top	γ photon
	4.8 MeV/c ²	104 MeV/c ²	4.2 GeV/c ²	0
	-1/3	-1/3	-1/3	0
	1/2	1/2	1/2	1
Quarks	d down	s strange	b bottom	g gluon
	<2.2 eV/c ²	<0.17 MeV/c ²	<15.5 MeV/c ²	91.2 GeV/c ²
	0	0	0	0
	1/2	1/2	1/2	1
	ν_e electron neutrino	ν_μ muon neutrino	ν_τ tau neutrino	Z⁰ Z boson
	0.511 MeV/c ²	105.7 MeV/c ²	1.777 GeV/c ²	80.4 GeV/c ²
	-1	-1	-1	±1
	1/2	1/2	1/2	1
Leptons	e electron	μ muon	τ tau	W[±] W boson
				Gauge Bosons



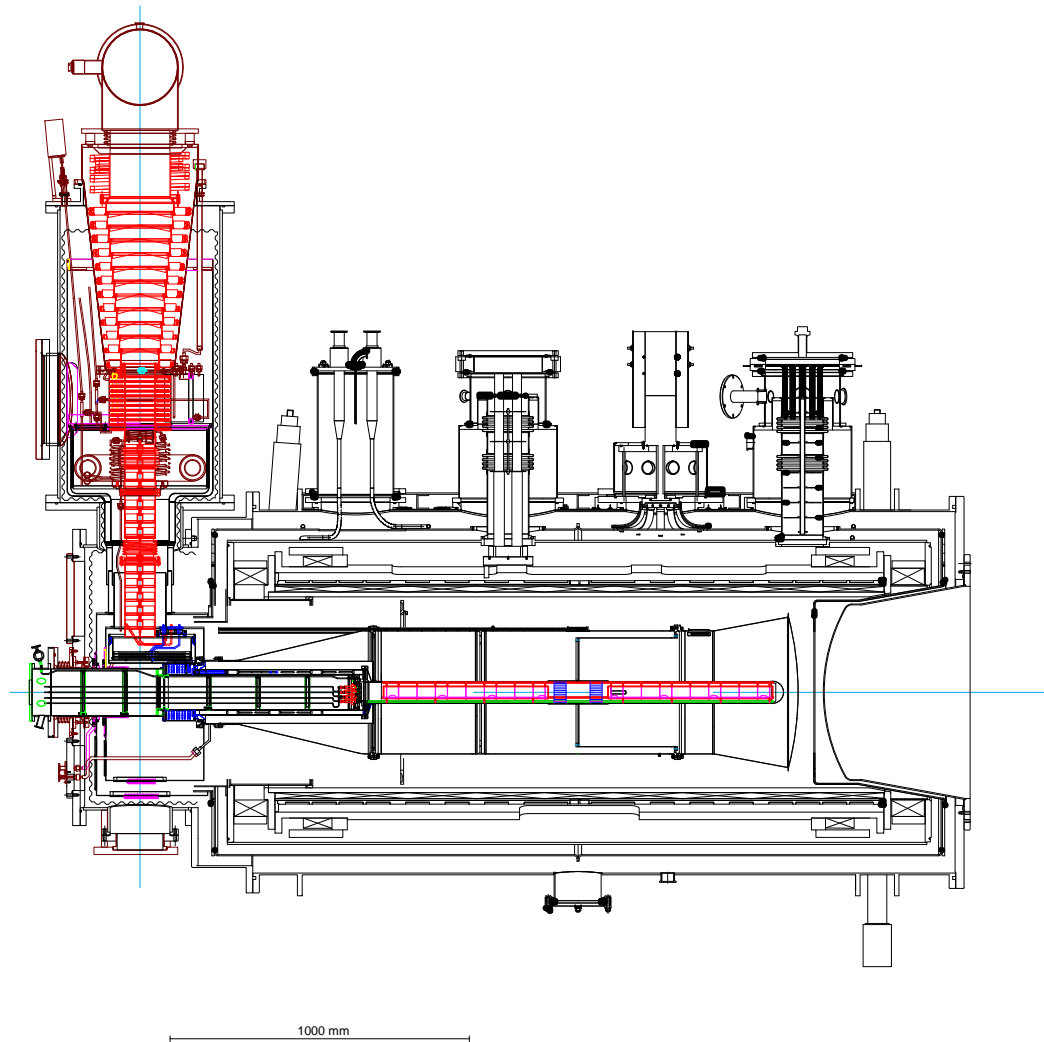

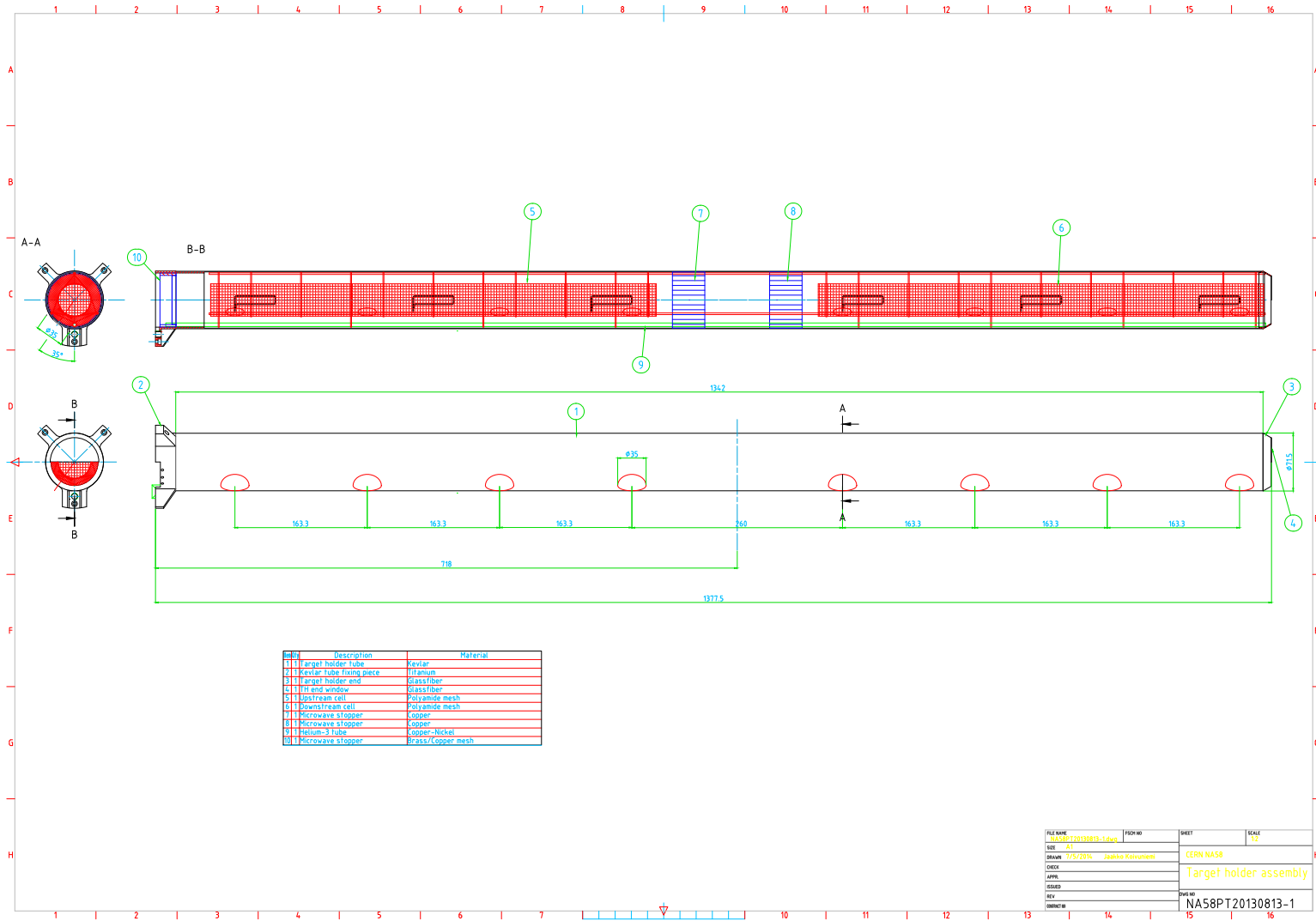

FILE NAME	NA58PT20130813-1.dwg	FIG. NO.		SHEET	12	SCALE		
REV	A1			CERN NA58				
DRAWN	7/15/2016	Jaakko Koivuniemi	Target holder assembly					
CHECK								
DATE								
ISSUED								
REV							PART NO.	
DATE							NA58PT20130813-1	



SIDIS 2007

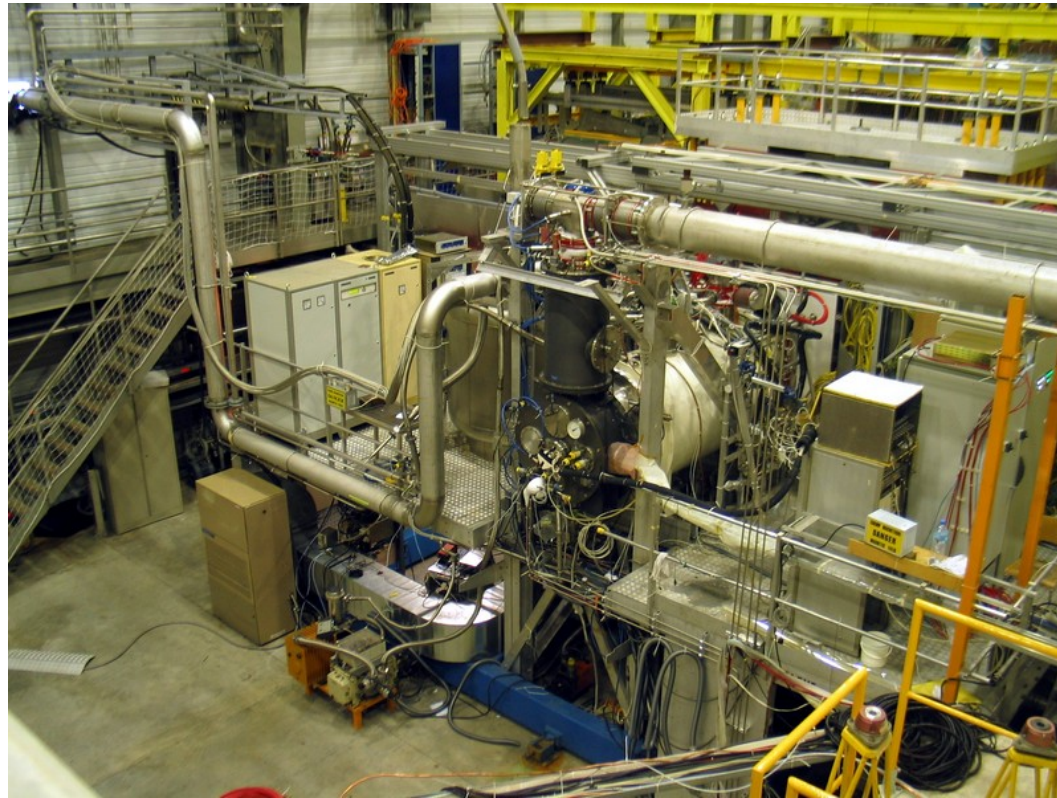

March 2015



April 2015



April 2015

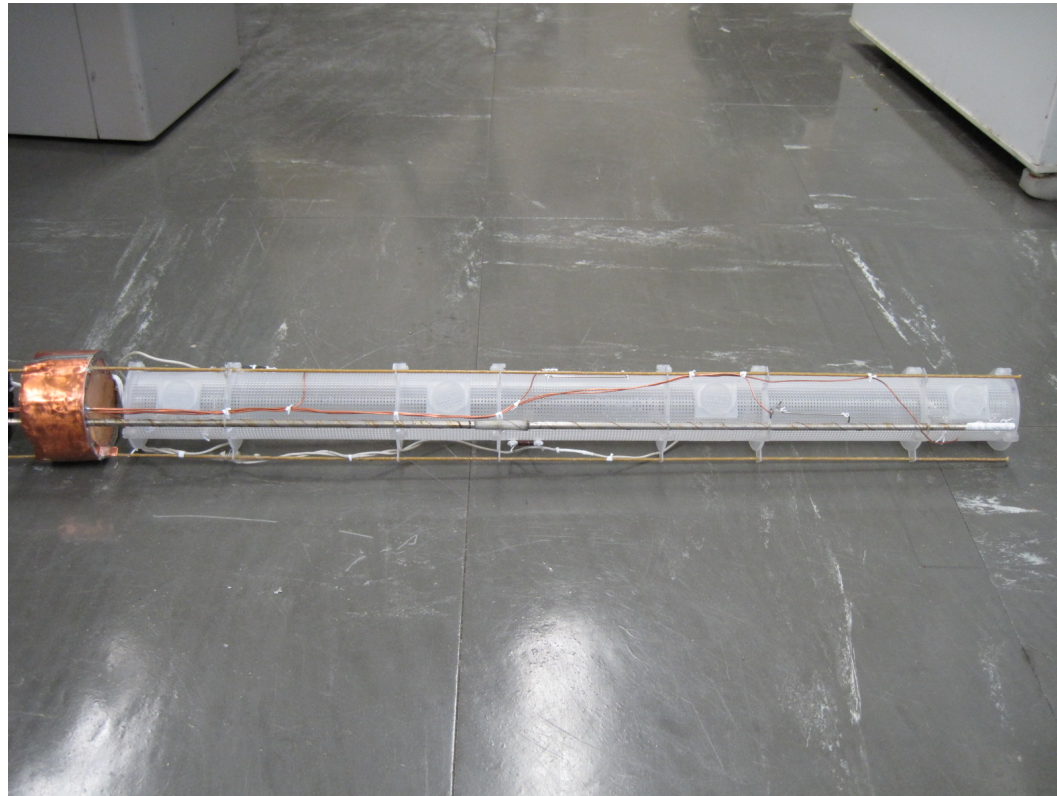

April 2015

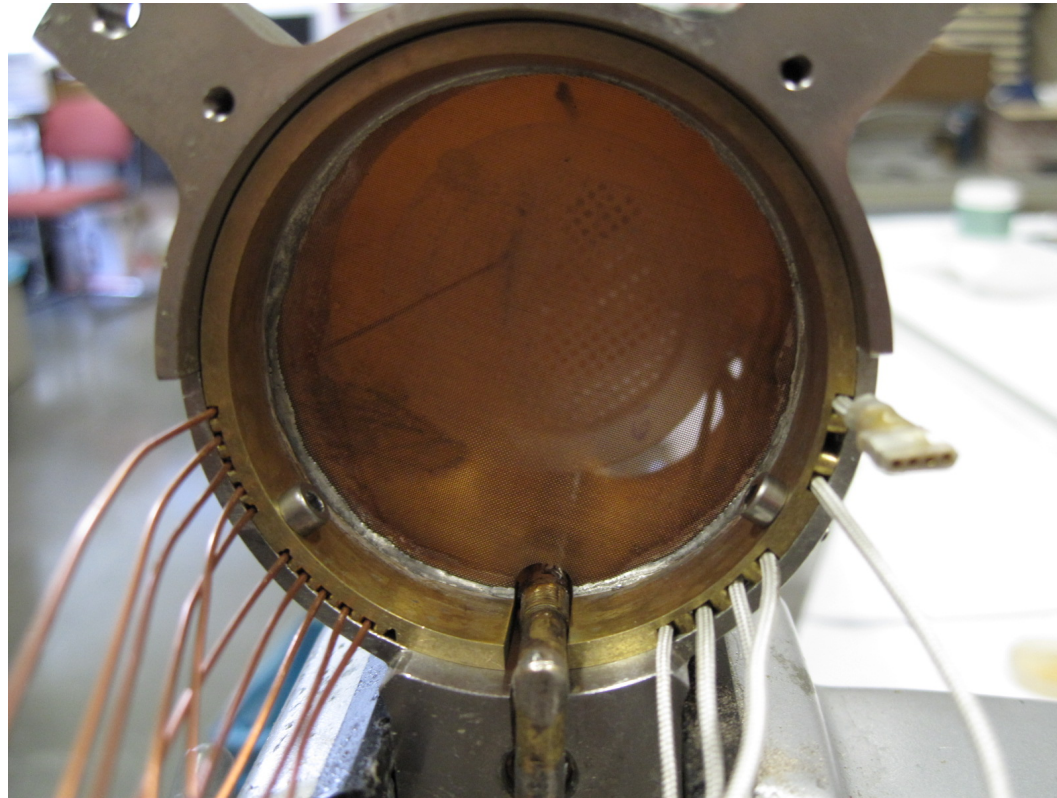

April 2015

