

MOLLER

Measurement Of a Lepton Lepton Electroweak Reaction using Parity Violating Electron-Electron Scattering

A proposed 2.4% measurement of the electron weak charge:

$$Q_W^e = -(1 - 4 \sin^2 \theta_W)$$

A test for physics beyond the Standard Model

2015 LRP Town Hall Meeting
CAP meeting 2015

Michael Gericke (University of Manitoba)

On behalf of the Canadian MOLLER group

The MOLLER Experiment

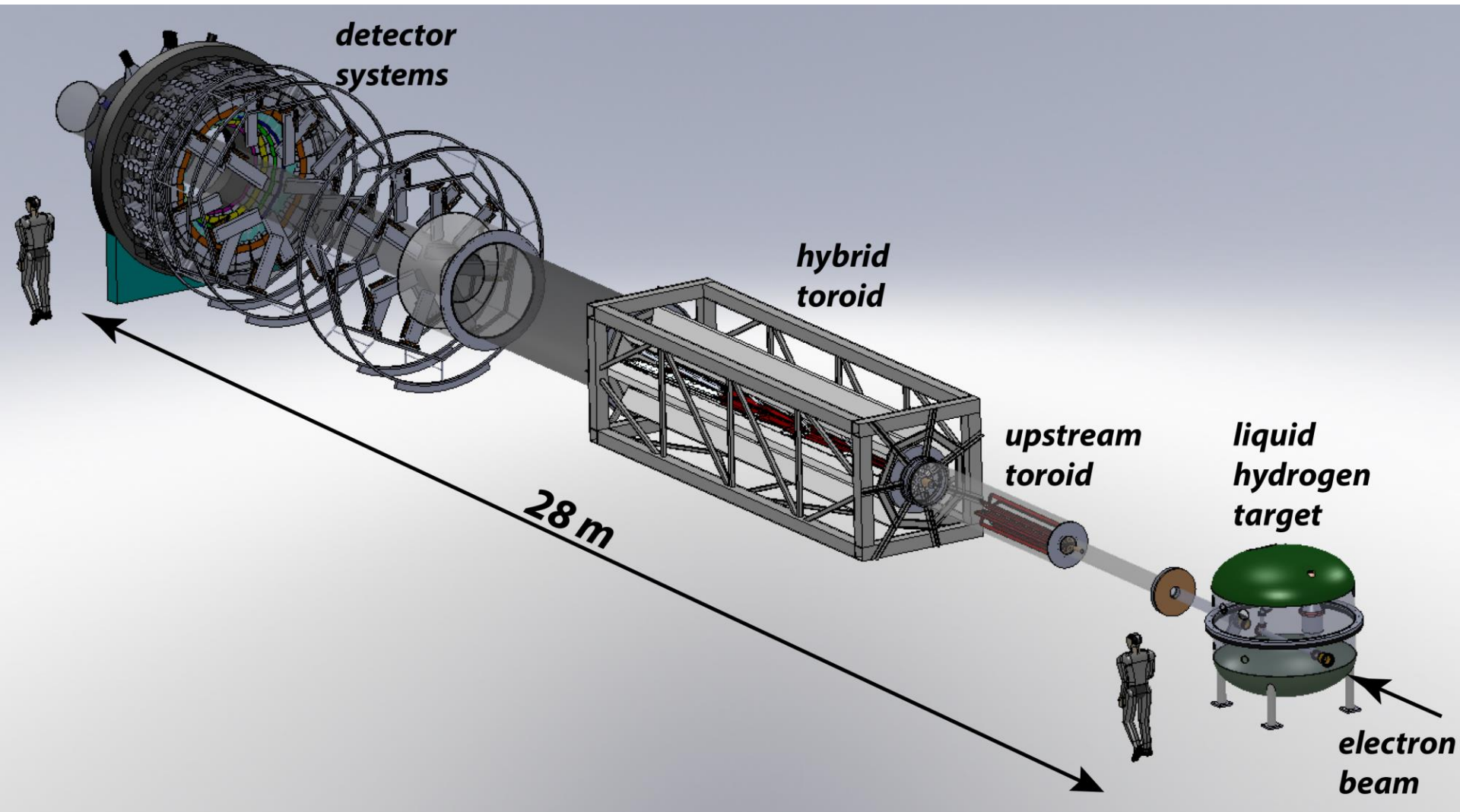

The MOLLER Experiment

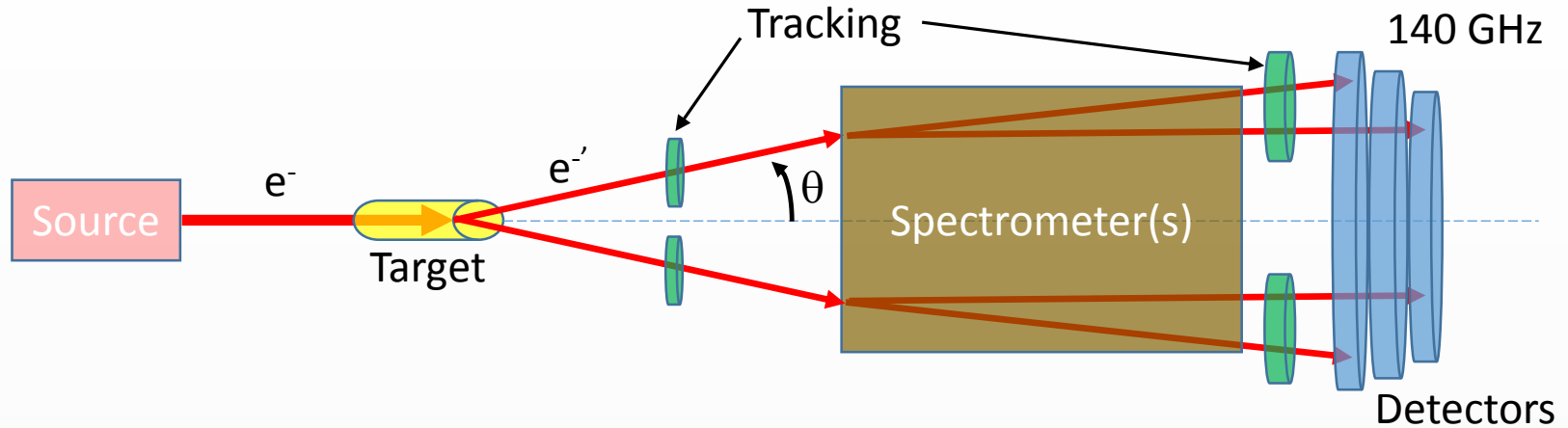

- Beam: $E = 11 \text{ GeV}$ $I = 60 \mu\text{A}$ $P_e \geq 90 \%$
- LH2 Target: $\ell = 150 \text{ cm}$ $\mathcal{L} = 3 \times 10^{39} \text{ cm}^{-2} \cdot \text{s}^{-1}$
- Scattering range: $0.3 \leq \theta \leq 1.1 \text{ deg}$ $2.75 \leq E' \leq 8.25 \text{ GeV}$
- Separate into **$e-e$** , **$e-p$** , and **inelastic** bins using two toroidal spectrometers
- Measure scattering angle with tracking detectors

The MOLLER Observable

The flux (N_{\pm}) of scattered electrons will be measured as a function of initial electron helicity (\pm) and an asymmetry is formed:

$$A_{msr} = \frac{N^+ - N^-}{N^+ + N^-} = P_e \left(f_p A_p + \sum_b A_b f_b \right) + A_i$$

P_e = electron polarization
 f_p = flux fraction from desired physics signal
 f_b = flux fraction from background signal
 A_p = physics asymmetry
 A_b = background asymmetries
 A_i = instrumental (false) asymmetries

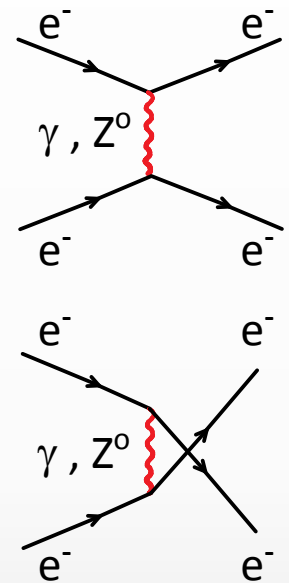

SM predicted asymmetry 35 ppb - directly related to the weak charge of the electron:

$$A_p = mE \frac{G_F}{\sqrt{2}\pi\alpha} \frac{4 \sin^2 \theta}{(3 + \cos^2 \theta)^2} Q_W^e$$

$$Q_W^e = (1 - 4 \sin^2 \theta_W)$$

At tree level, with no new physics

MOLLER Physics

Propose to measure A_p to 2% (0.73 ppb)

$$\delta(Q_W^e) = \pm 2.1\%(\text{stat.}) \pm 1.1\%(\text{syst.})$$

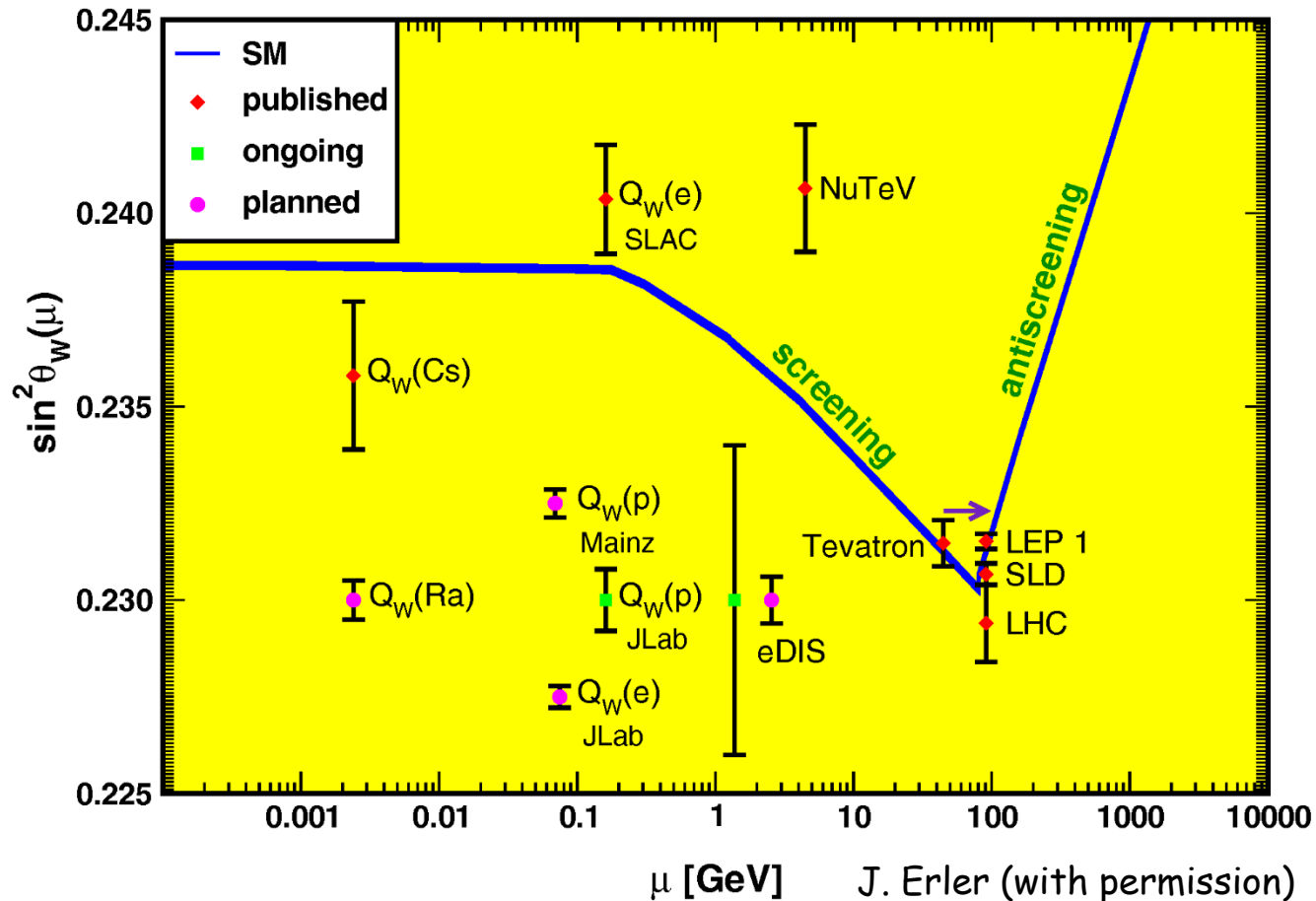

MOLLER Physics

Propose to measure A_p to 2% (0.73 ppb)

$$\delta(Q_W^e) = \pm 2.1\%(\text{stat.}) \pm 1.1\%(\text{syst.})$$

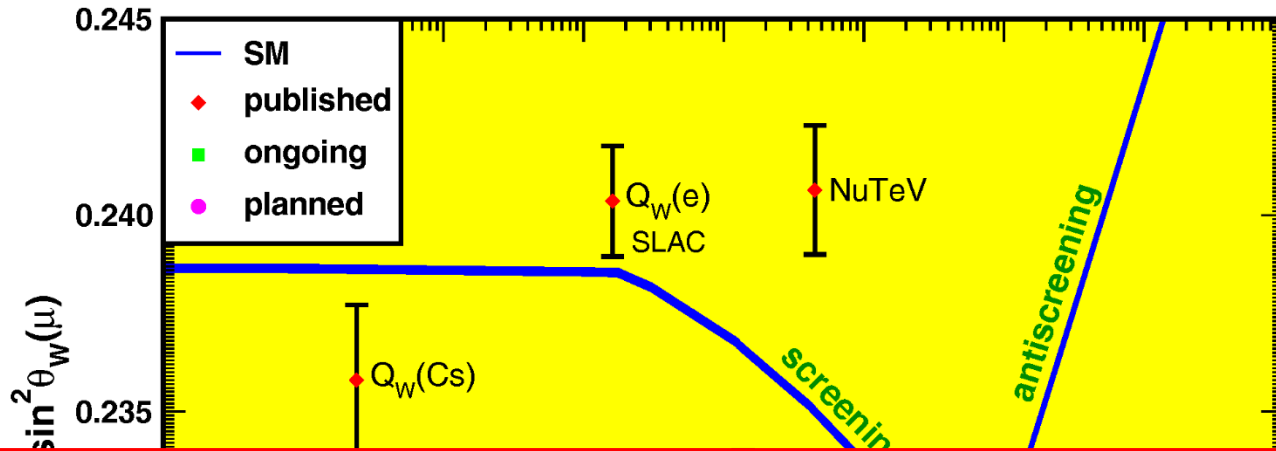

$$\delta(\sin^2 \theta_W) = \pm 0.00024(\text{stat.}) \pm 0.00013(\text{syst.}) \Rightarrow \sim 0.1\%$$

Would match best collider (Z-pole) measurements.
Best contact interaction reach for leptons at low OR high energy.

To do better for a 4-lepton contact interaction would require:
Giga-Z factory, linear collider, neutrino factory or muon collider

MOLLER Physics

Propose to measure A_p to 2% (0.73 ppb)

$$\delta(Q_W^e) = \pm 2.1\%(\text{stat.}) \pm 1.1\%(\text{syst.})$$

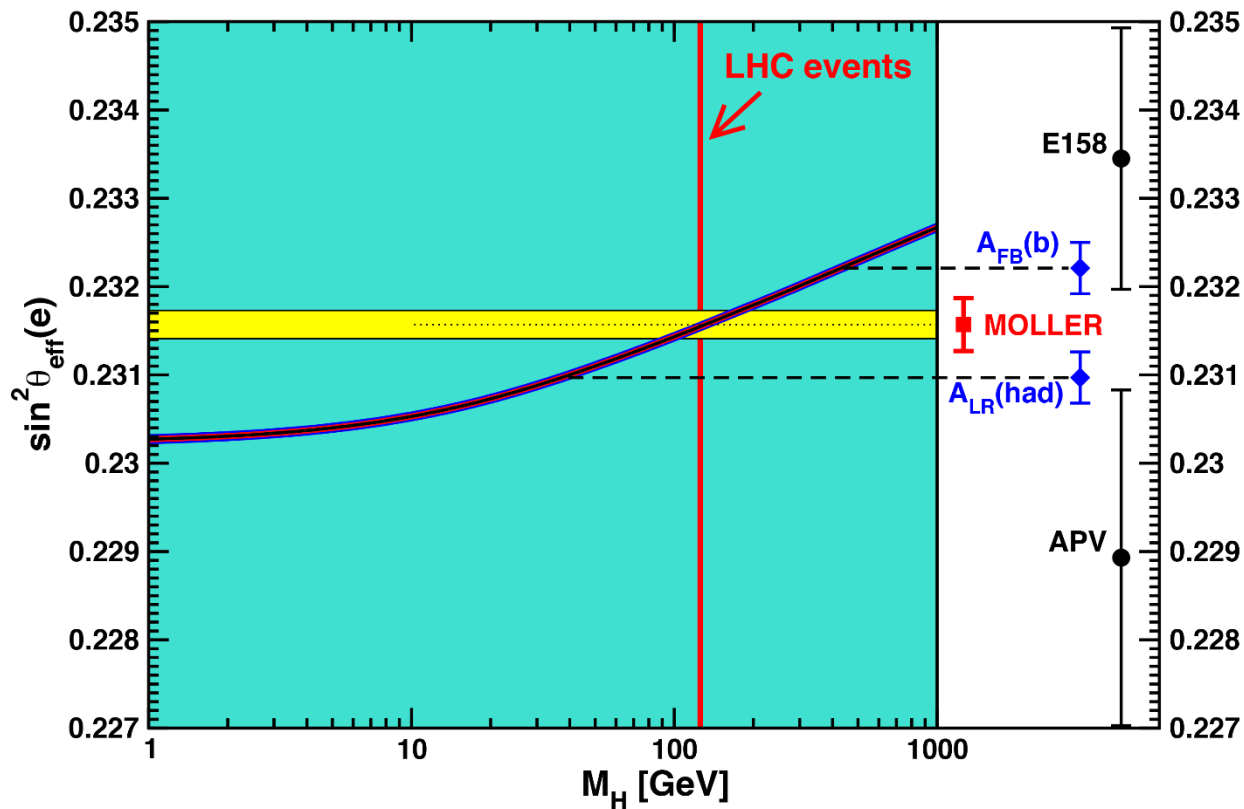

New Physics Sensitivities

New (effective) Contact Interactions:

Induced by a range of new physics scenarios:

- low scale quantum gravity with large extra dimensions
- composite fermions,
- leptoquarks,
- heavy Z_0 bosons

$$\mathcal{L}_{eff} = \frac{g^2}{\Lambda^2} \sum_{i,j=L,R} n_{ij}^f \bar{e}_i \gamma_\mu e_i \bar{e}_j \gamma_\mu e_j$$

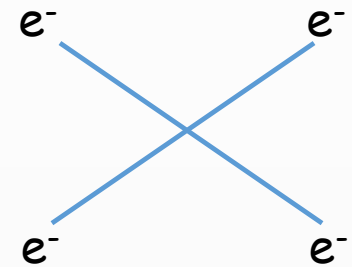

$$\frac{\delta Q_W^e}{Q_W^e} = 2.4\% \Rightarrow A_{new} \sim 10^{-3} G_F \quad \text{Unprecedented Sensitivity!}$$

Model	η_{LL}^f	η_{RR}^f	η_{LR}^f	η_{RL}^f
LL^\pm	± 1	0	0	0
RR^\pm	0	± 1	0	0

$$\frac{\Lambda}{\sqrt{|g_{RR}^2 - g_{LL}^2|}} \approx 7.5 \text{ TeV}$$

$$\Lambda_{LL}^{ee} \sim 27 \text{ TeV}$$

New Physics Complementarity

QM: Common language across energy scales: $|A_Z + A_{new}|^2 \Rightarrow A_Z^2 \left[1 + \left(\frac{A_{new}}{A_Z} \right)^2 \right]$

For resonances (Z_0) A_Z is imaginary  No interference term!

Additionally, A_{new} could be mediated by a new light boson: "dark Z"

$$\delta(\sin^2 \theta_W) = \pm 0.00024(\text{stat.}) \pm 0.00013(\text{syst.}) \Rightarrow \sim 0.1\%$$

Other measurements on the same time scale:

Mainz P2: ~ 0.00036

Final Tevatron: ~ 0.00041

LHC 14 TeV, 300 fb⁻¹ : ~ 0.00036

Equipment...

The Spectrometer / Collimator (J. Mammei)

Separate events into **e-e** , **e-p** , and **inelastic** bins, using two spectrometers.

Moller and elastic ep electron tracks

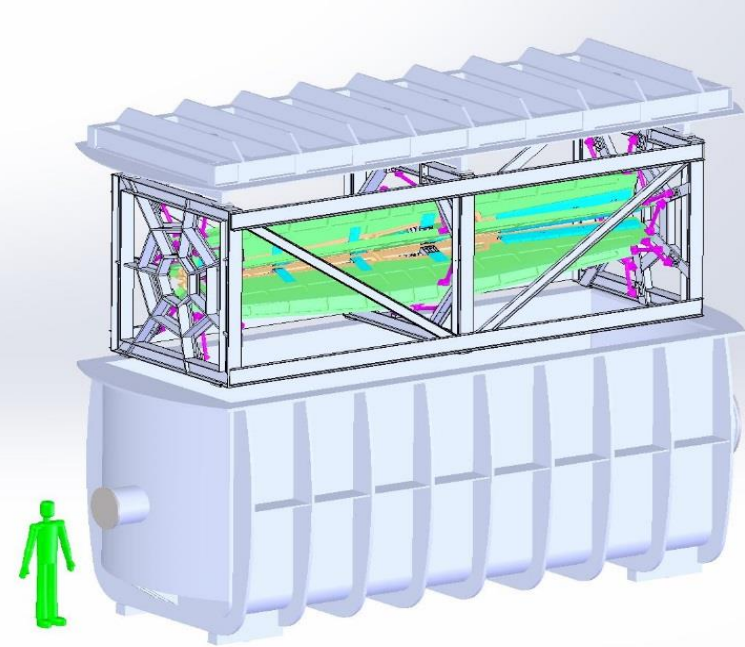
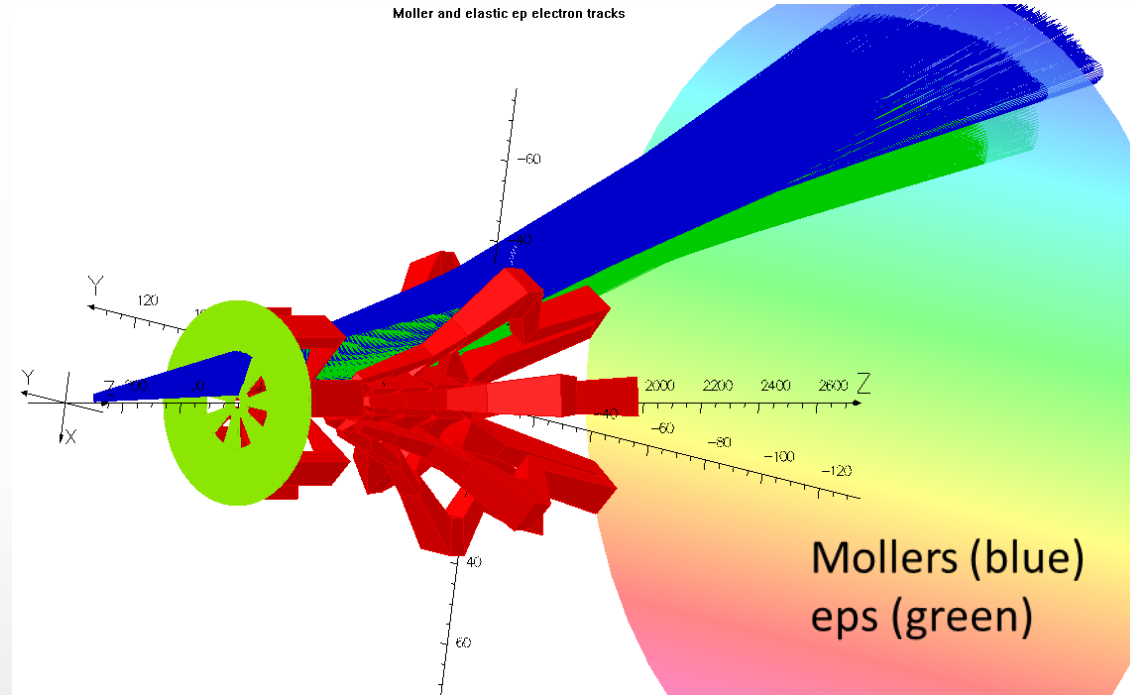

- Accept all (forward and backward) Møllers in the range $60 \leq \theta_{COM} \leq 120 \text{ deg}$
- Clean separation of elastic and inelastic electron-proton scattering events
- Placement of detectors out of the line-of-sight of the target
- Clean channel for the degraded beam and the bremsstrahlung photons to beam dump
- Minimization of soft photon backgrounds by designing a “two-bounce” system

The Detectors (M. Gericke)

Measure events in 6 radial bins:

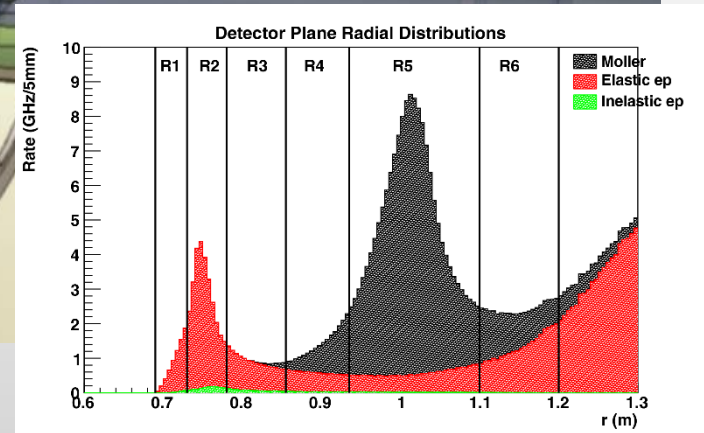
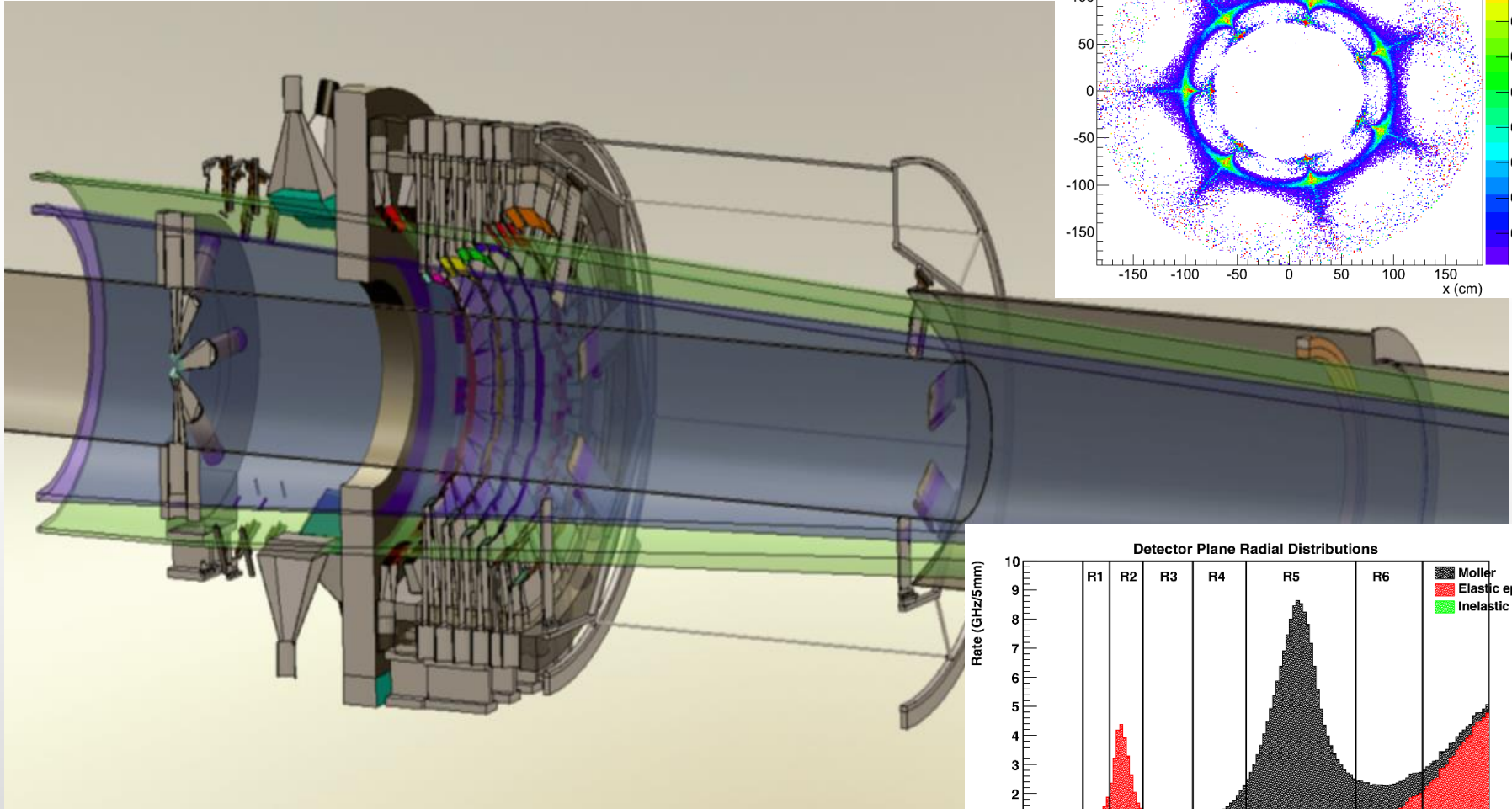

The Detectors

Divide each ring into azimuthal sectors:

Current design calls for 224 channels

Rate per channel: \sim few MHz to GHz

Acquisition mode: Flux Integrating

→ No event cuts possible

→ Low background by design

Radiation dose: 15 to 50 Mrad

→ Quartz DIRC + Air-Core light guide with PMT (or better alternatives)

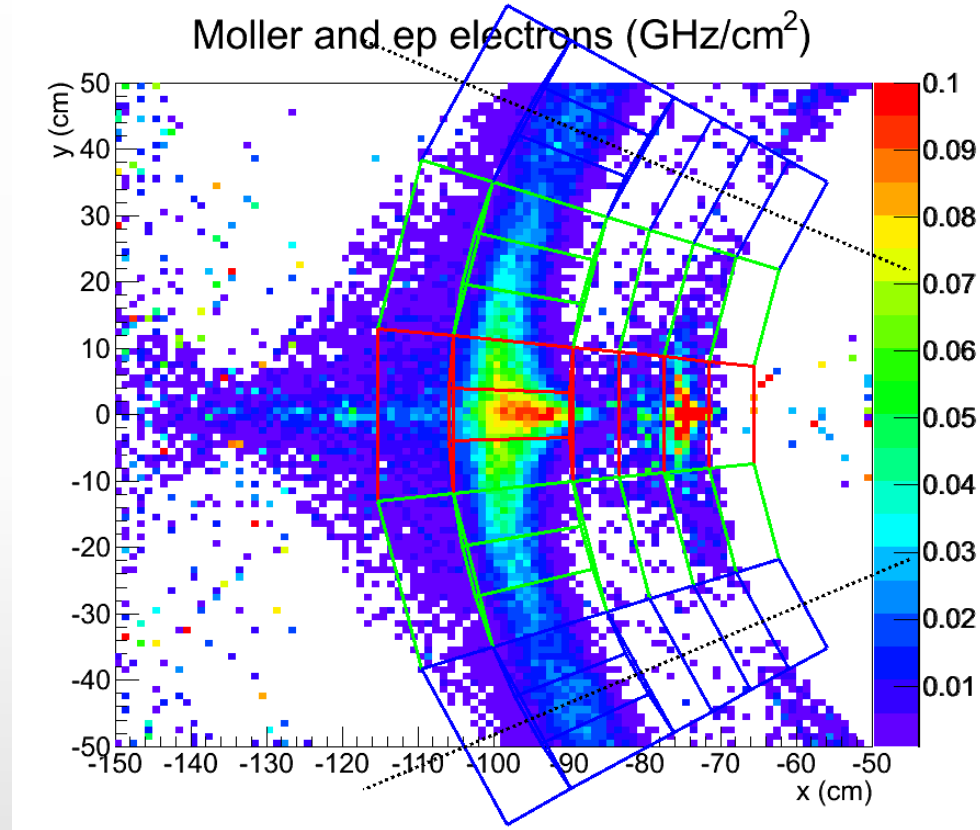

Tracking

Ideally want to measure vertex angle and energy:

$$K_{\text{vertex}} \equiv E_{\text{vertex}} \frac{4 \sin^2 \theta_{\text{vertex}}}{\left(3 + \cos^2 \theta_{\text{vertex}}\right)^2}$$

$$A_p = m \frac{G_F}{\sqrt{2\pi\alpha}} \left(E \frac{4 \sin^2 \theta}{\left(3 + \cos^2 \theta\right)^2} \right) Q_W^e$$

Challenge of high rate, high radiation environment

→ do dedicated tracking runs at lower current

Downstream spectrometer technology:

GEMs (triple stack)

Resolution: 200 μm in radius , 1 mm in ϕ

Rates: 20 kHz / cm²

Active Area: 60 cm \times 20 cm

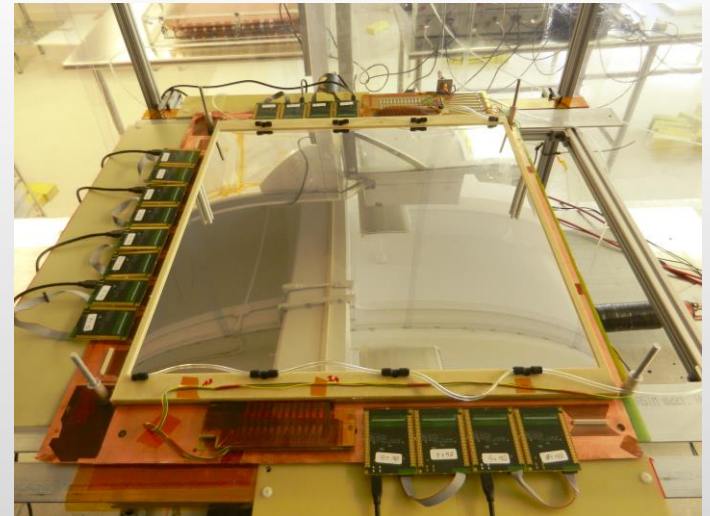

Tracking

Ideally want to measure vertex angle and energy:

$$K_{\text{vertex}} \equiv E_{\text{vertex}} \frac{4 \sin^2 \theta_{\text{vertex}}}{\left(3 + \cos^2 \theta_{\text{vertex}}\right)^2}$$

Upstream tracker not yet proposed (but needed) !

Rad hard CMOS Si ?

Other ?

Would be nice to run those at higher rates ...

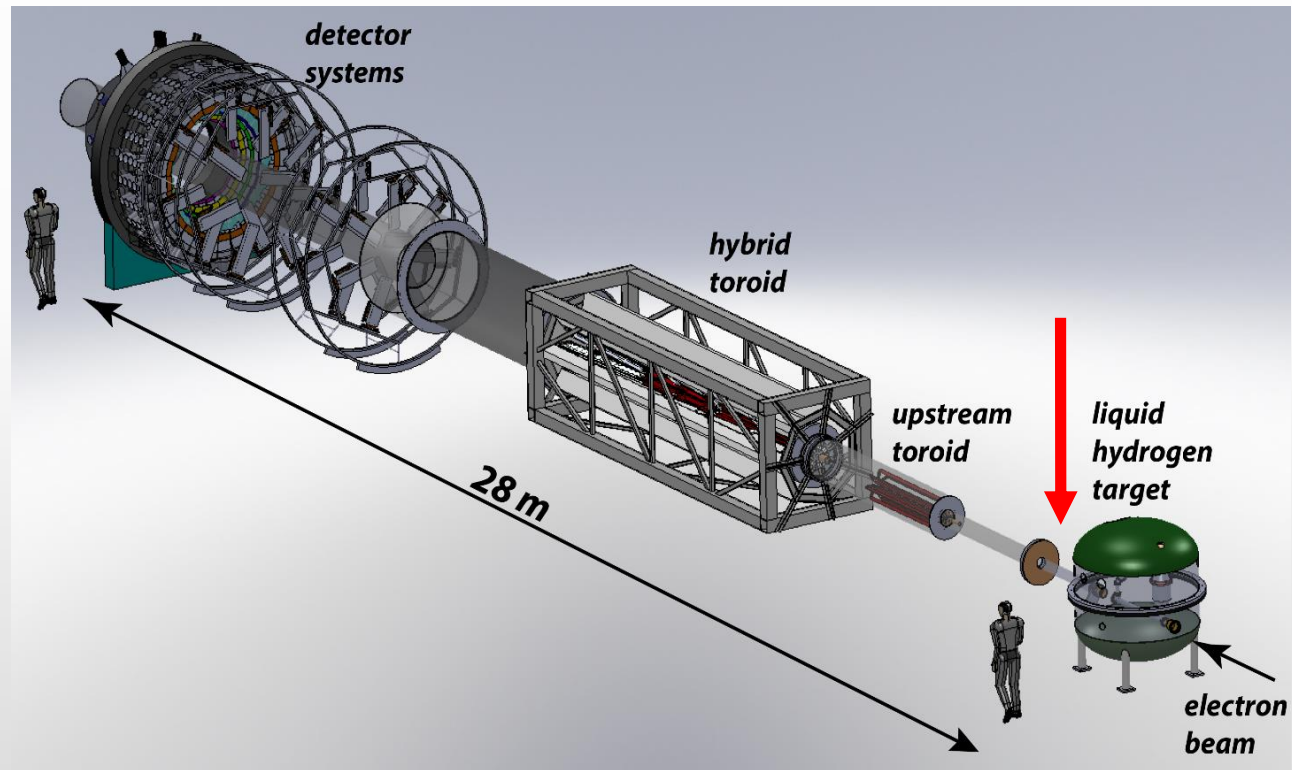

Polarimetry

Compton polarimeter (also Møller, not shown here):

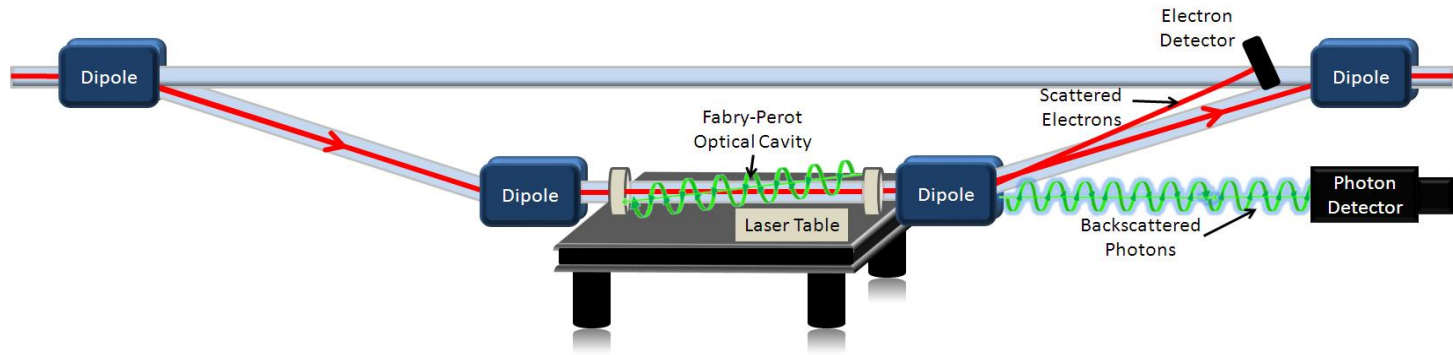

Stable beam polarization at Jefferson Lab has been measured to be up to 89%.
The experimental requirement for relative accuracy in beam polarization is 0.4%

The currently installed:

GSO crystal scintillator Photon calorimeter
4 planes of silicon micro-strip electron detectors

Possible upgrades:

Diamond detectors / new electronics

Polarimetry

Compton polarimeter:

Due to background rejection and radiation hardness requirements, an upgrade to diamond-strip detectors is considered:

Sample detector:

10 mm x 10 mm x 0.5 mm
polycrystalline Chemical Vapor Deposition
(pCVD) diamond

Strip pitch
Strip width
Gap

200 μm
175 μm
25 μm

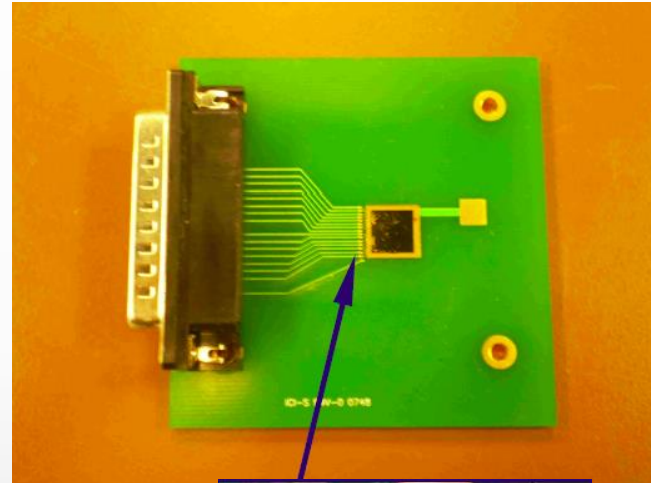

Univ. of Winnipeg
QWeak prototype

Status and Outlook

- MOLLER has high priority in the US NSAC LRP
- \$25M Scale (\$20M from DOE MIE)
- US groups have R&D funding from NSF, DOE and Jefferson Laboratory
- Successful DOE science review in September 2014
- Technical Feasibility and Directors reviews scheduled for 2015
- Projected construction funding in 2017
- Projected date for start of installation: 2019-2020 (+3-4 years running)
- Canadian group currently holds a two year R&D NSERC grant
- R&D in full swing on spectrometer and detectors
- We will go back for NSERC R&D (Operating & RTI) ... CFI later ?

Canadian Effort

- Juliette Mammei (U. Manitoba) is a member of the MOLLER Executive Board
- Spectrometer design and optics: Juliette Mammei work package leader (WPL)
- Integrating detectors: Michael Gericke (WPL)
- Integrating electronics: Michael Gericke (TRIUMF... hopefully... cont. Qweak)
- Compton polarimeter electron detectors: Juliette Mammei
- Theory: A. Aleksejevs, S. Barkanova (in Canada)
- Upstream tracking: ?????
- Other good (Canadian) ideas: ?????

Canadian Effort

Table 1: *Current Canadian Effort and Manpower*

Researcher	Institution	FTE	Effort
A. Aleksejevs	Grenfell	0.2	2-loop Calculations Specific to MOLLER
S. Barkanova	Acadia	0.2	2-loop Calculations Specific to MOLLER
J. Birchall	Manitoba	0.2	Systematics Studies
M. Gericke	Manitoba	0.5	Detectors
B. Jamieson	Winnipeg	0.1	Detectors
E. Korkmaz	UNBC	0.1	Data Collection
J. Mammei	Manitoba	0.5	Spectrometer, Detectors, Systematics
R. Mammei	Winnipeg	0.1	Spectrometer
J. Martin	Winnipeg	0.1	Detectors
S. Page	Manitoba	0.1	Detectors, Spectrometer
J. Pan (RA)	Manitoba	0.5	Detectors,
S. Rahman (Student)	Manitoba	1.0	Spectrometer, Detectors
M. Shabestari (RA)	Manitoba	1.0	Detectors
R. Spiers (Student)	Manitoba	0.5	Detectors
W.T.H van Oers	Manitoba	0.1	Advisory
S. Arbabi (Student)	Manitoba	1.0	Detectors, Systematics

Canadian Effort

Table 2: *Projected needed manpower additions to what is listed above for 2017 and beyond.*

Researcher	FTE	Effort	Cost/Year
Continued or new RA	1.0	Detectors or spectrometer	\$75k (including benefits)
Continued or new RA	1.0	Detectors or spectrometer	\$75k (including benefits)
Continued or new Student	1.0	Detectors	\$21k
Continued or new Student	1.0	Spectrometer	\$21k
new Student	1.0	Detectors	\$21k
new Student	1.0	Spectrometer	\$21k

Canadian Effort

Table 3: *Estimated Optimum MOLLER Funding Levels.*

Funding Year	Amount	Comments
2017-18	\$330k \$ 50k \$325k	4 students, 2 RAs, \$96k in travel First half of the integrating ADC channels (RTI or maybe par of a CFI) First half of the the quartz bars (most likely would have to be a CFI)
2018-19	\$330k \$ 50k \$325k	4 students, 2 RAs, \$96k in travel Second half of the integrating ADC channels (RTI or maybe par of a CFI) Second half of the the quartz bars (most likely would have to be a CFI)
2019-23	\$426k	4 students, 2 RAs, \$192k in travel
2023-24	\$334k	4 students, 2 RAs, \$100k in travel
2024-25	\$239k	4 students, 1 RA, \$80k in travel
2025-26	\$157k	2 students, 1 RA, \$40k in travel

This will grow accordingly, if we are able to grow the Canadian collaboration.

Thank You!

Additional slides for your reference to
follow ...

The MOLLER Experiment

Technical Challenges:

- ❑ 150 GHz scattered electron rate (up to 0.1 GHz/cm²)
 - 2 kHz beam helicity reversal
 - 80 ppm pulse-to-pulse statistical fluctuations

- ❑ 1 nm control of beam centroid on target
 - Improved methods of “slow helicity reversal”

- ❑ Liquid hydrogen target with $\rho > 10 \text{ gm/cm}^2$
 - 1.5 m: $\sim 4 \text{ kW @ } 60 \mu\text{A}$

- ❑ Full Azimuthal acceptance with $\theta_{\text{lab}} \sim 5$ milliradians
 - novel two-toroid spectrometer
 - radiation hard, highly segmented integrating detectors

- ❑ Robust and Redundant 0.4% beam polarimetry
 - Pursue both Compton and Atomic Hydrogen techniques

The Facility

Parity Violating Electron Scattering (PVeS) at JLAB

A 4th generation JLab PVeS Experiment, with expertise from:

MIT Bates, SLAC E158, JLab GO HAPPEX, PREX and QWeak.

There is a lot of expertise within the JLab user community, but ...

MOLLER is more challenging than previous PVeS experiments and would greatly benefit from HEP expertise!

Hall A



Event Distribution

In the "focal plane":

Simulated radial distribution, as a function of distance from the center of the beam line:

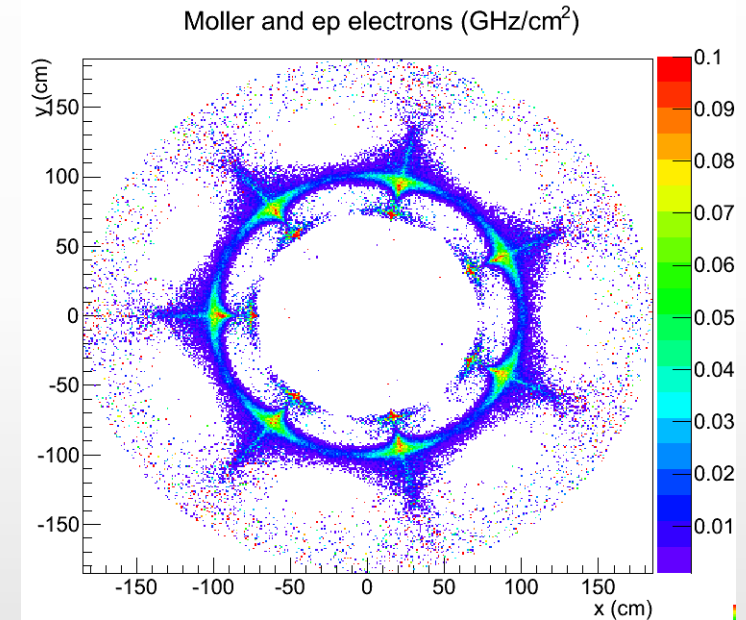
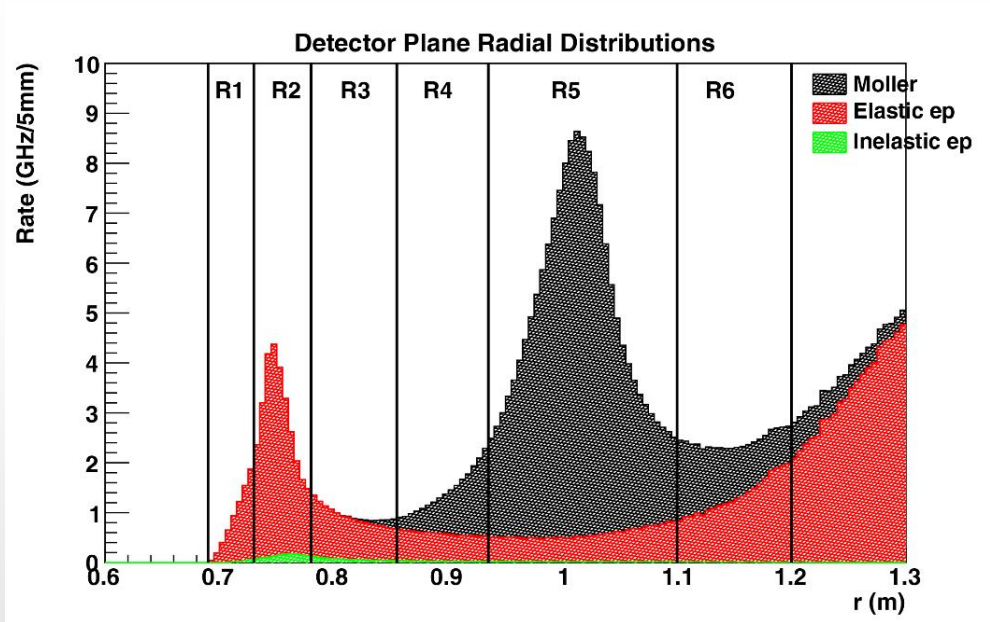

Proper separation of e-e , e-p , and inelastic events requires radial and azimuthal detector segmentation ...

Kinematics and Collimators

The proposed collimator /spectrometer design aims to accept all (forward and backward) Møller-scattered electrons in the range:

$$60 \leq \theta_{COM} \leq 120 \text{ deg}$$

With 100% azimuthal acceptance.

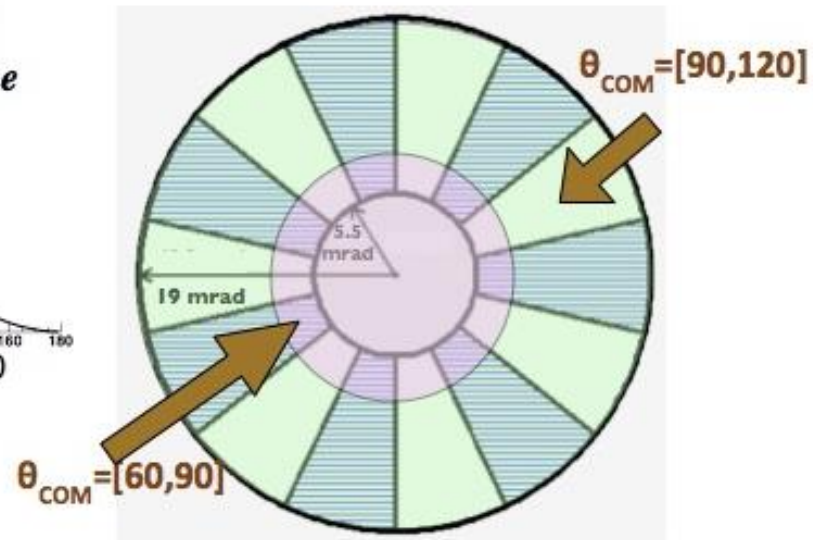
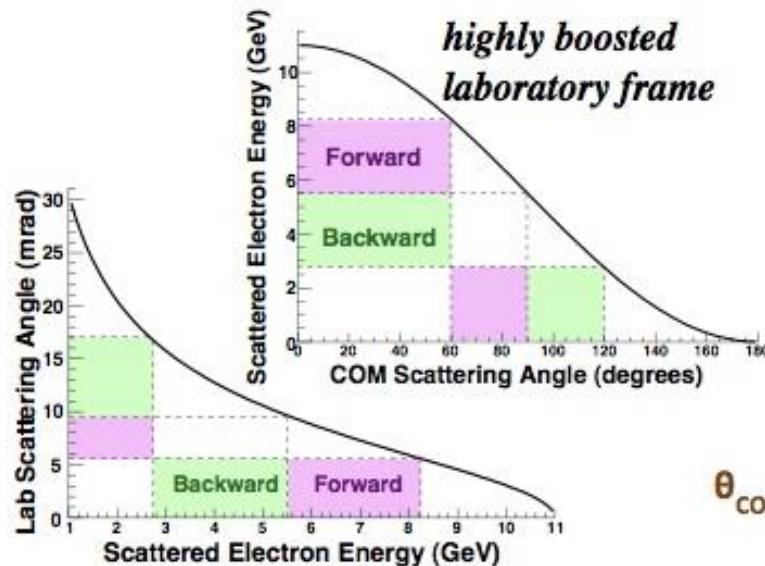
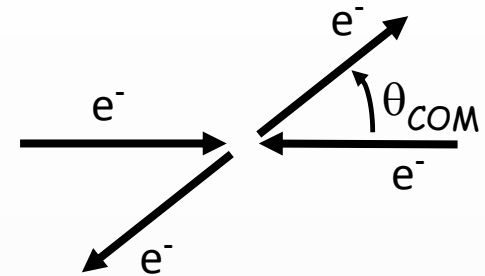

New Physics Sensitivities

New heavy spin 1 gauge boson $U(1)'$:

Assume LHC
discovers a new
spin 1 gauge boson
with $M = 1.2$ TeV

If the SM value is
measured

MOLLER can
distinguish
between models

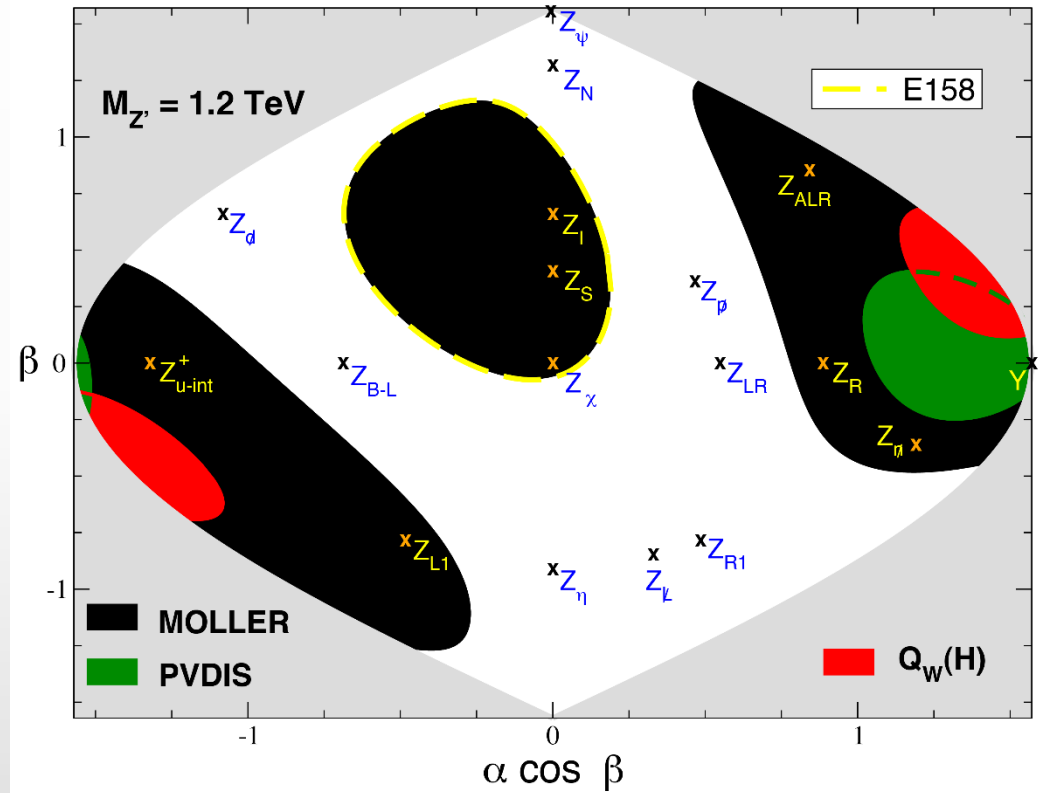

$\alpha = 0 \rightarrow E6$ models, $\alpha \neq 0$ describes kinetic mixing

$\beta = 0 \rightarrow SO(10)$ (including those based on LR symmetry)

New Physics Sensitivities

New heavy spin 1 gauge boson $U(1)'$:

Assume LHC
discovers a new
spin 1 gauge boson
with $M = 1.2$ TeV

Half-way between
SM and E158
central value

MOLLER can
distinguish
between models

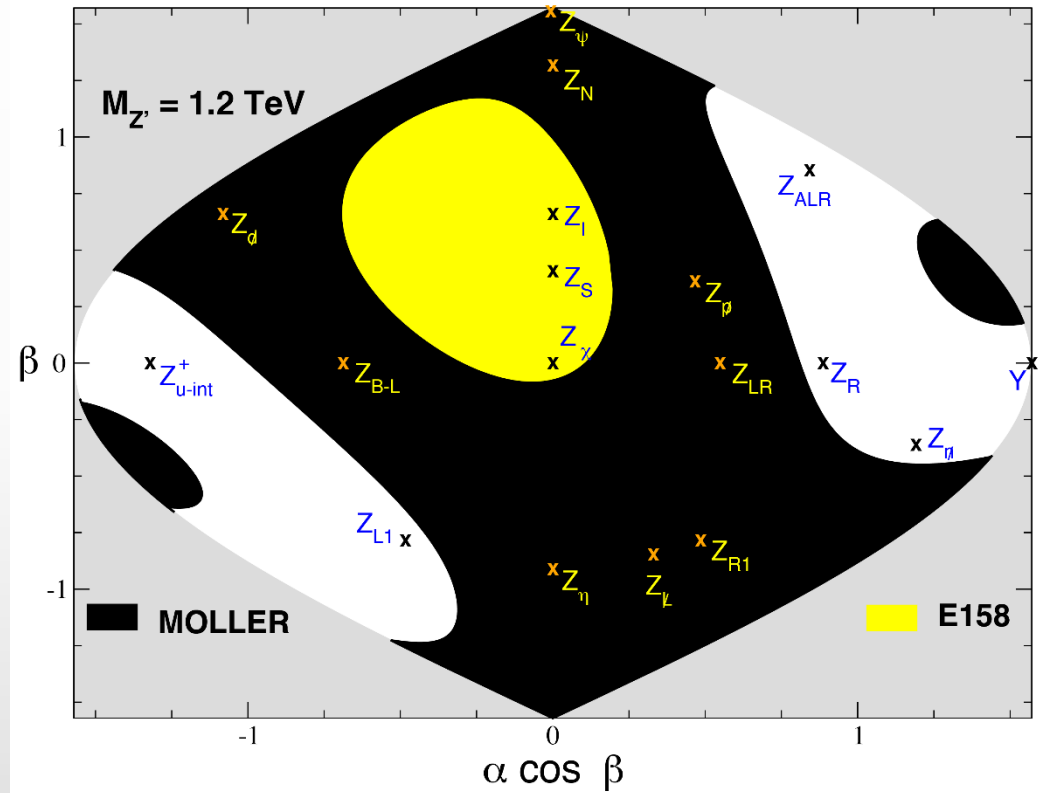

$\alpha = 0 \rightarrow E6$ models, $\alpha \neq 0$ describes kinetic mixing

$\beta = 0 \rightarrow SO(10)$ (including those based on LR symmetry)

The Spectrometer

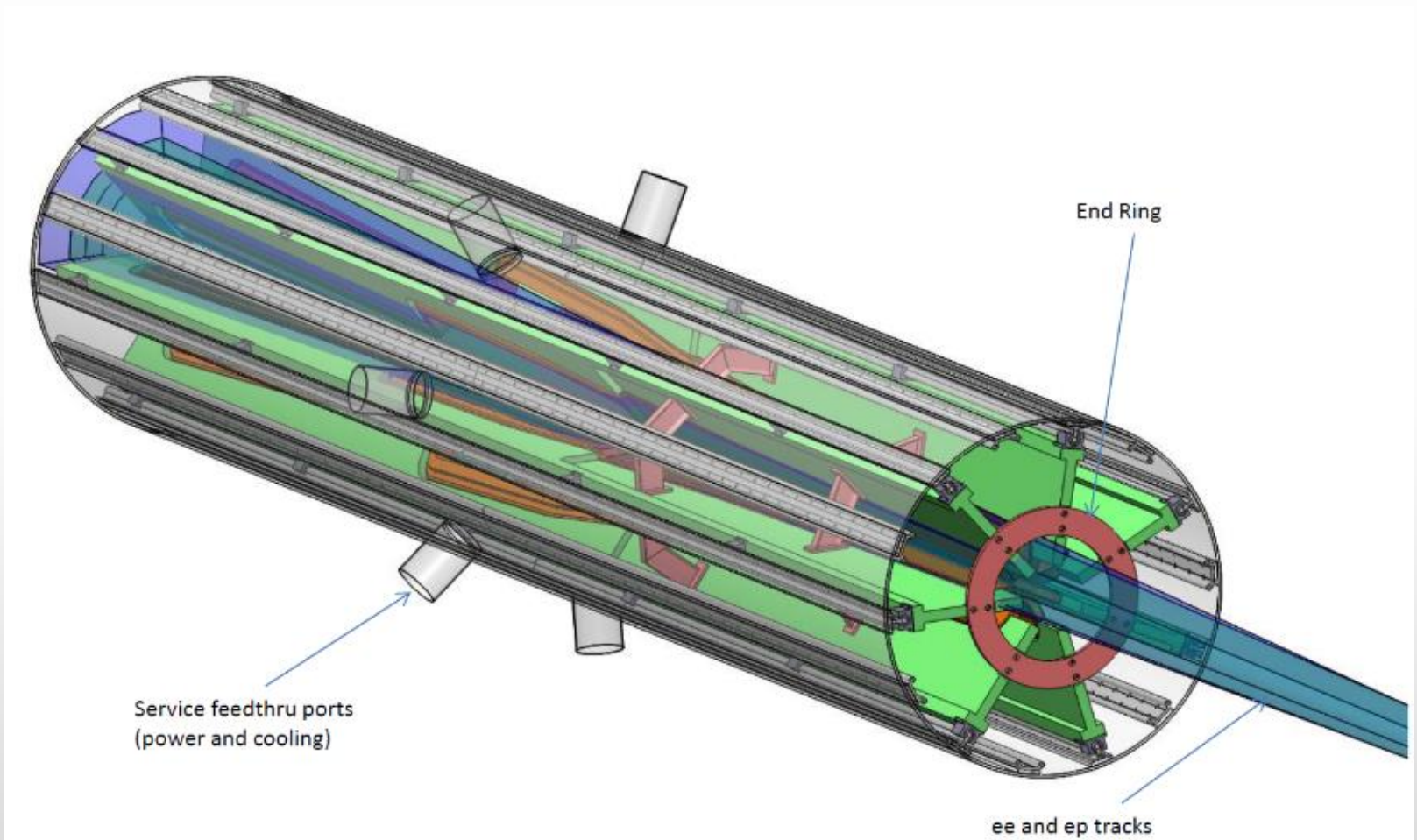

The Spectrometer

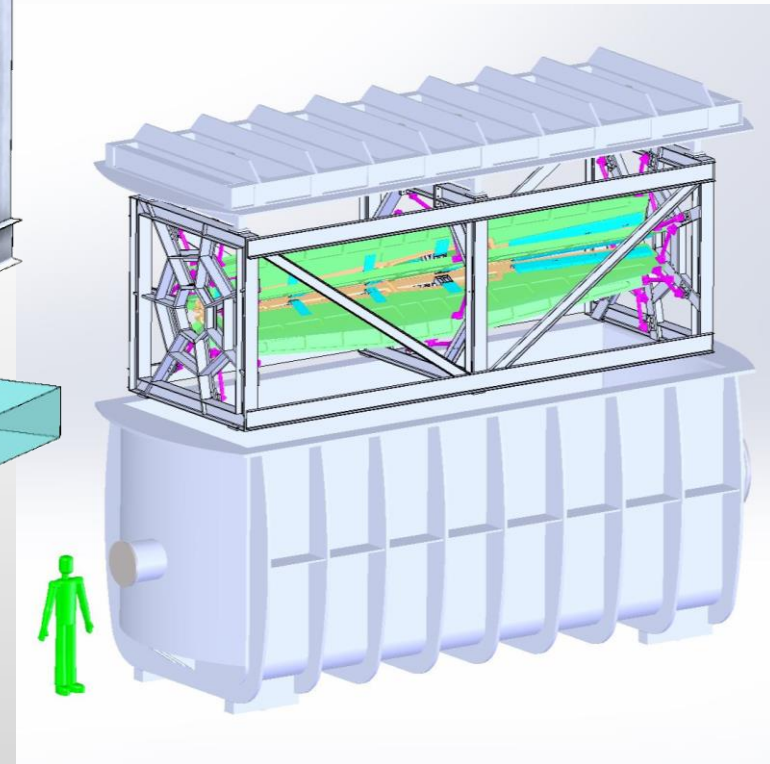
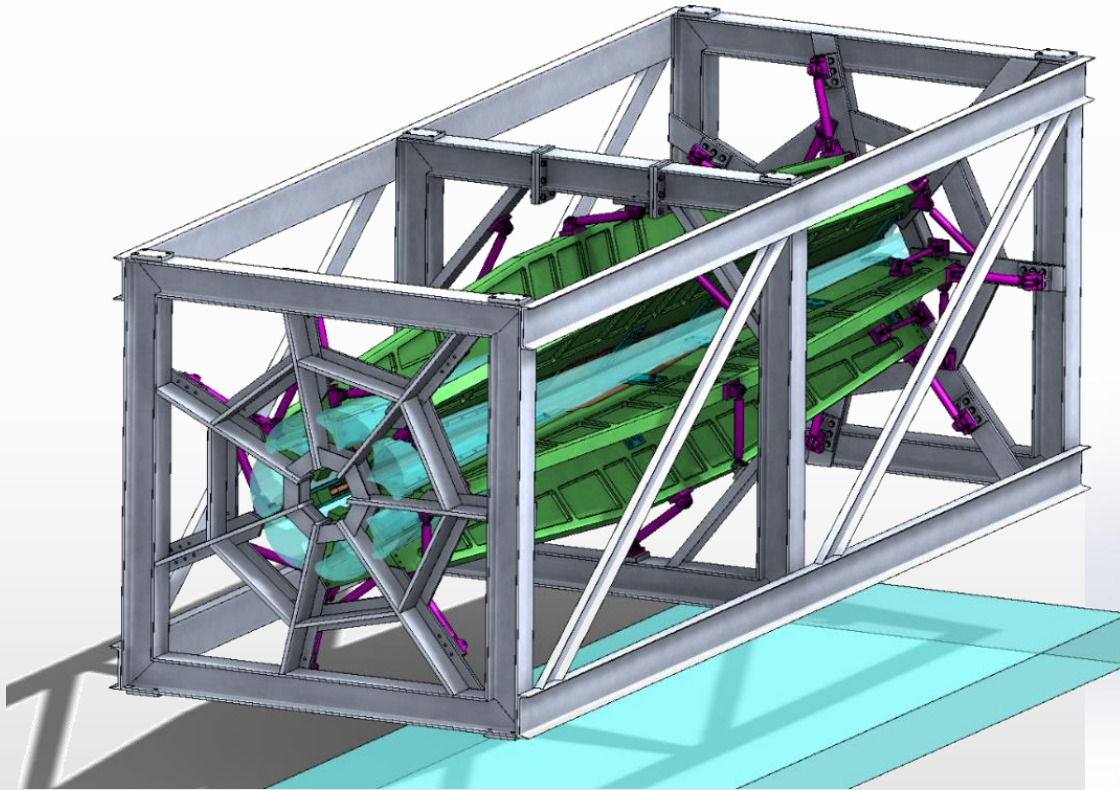

Experiment Overview

For MOLLER the facility is an integral part of the experiment!

Determined (primarily) at the source:

- Fast helicity reversal
- High polarization
- Charge Asymmetry

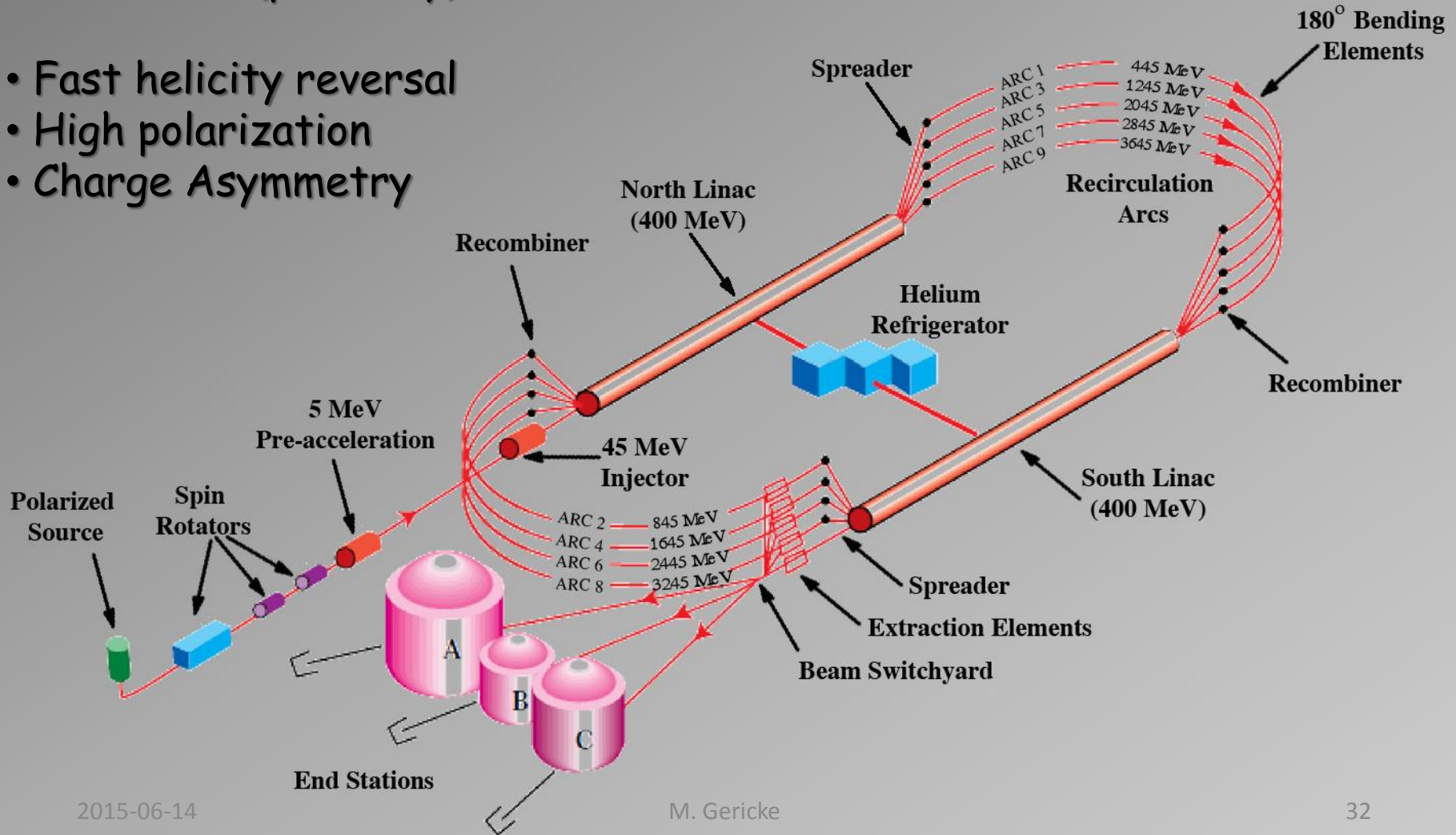

Experiment Overview

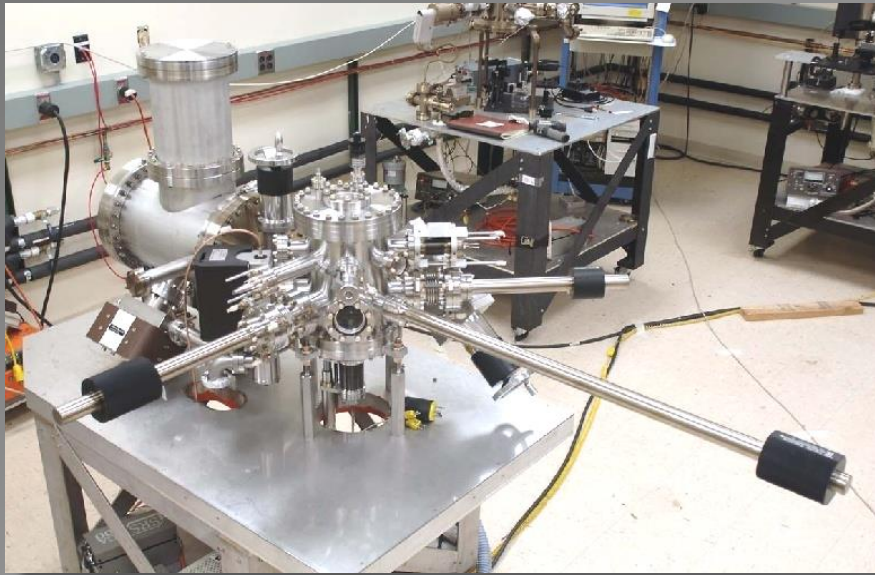

Helicity reversal:

- Continuously at 2 kHz, with Pockels cell
- Every 4 to 8 hours with insertable half-wave plate
- Every Couple of weeks with a spin rotation (Wein flip)

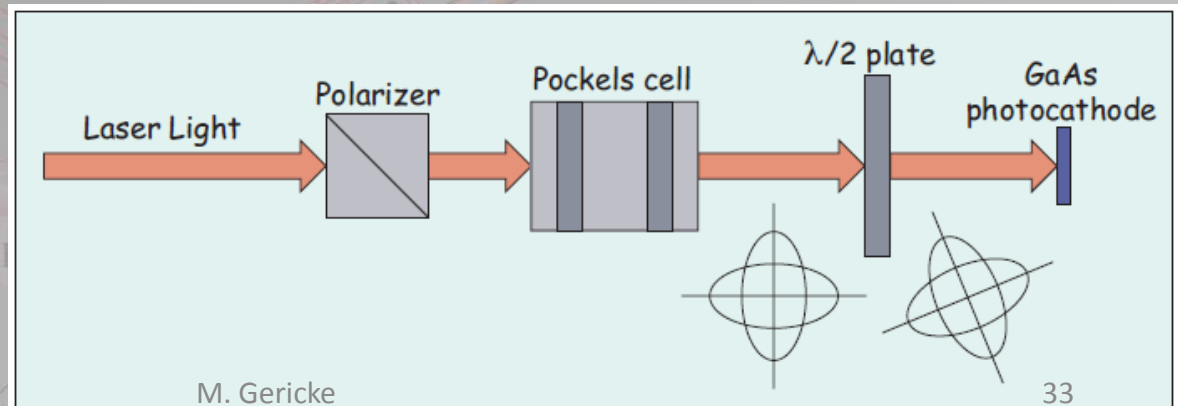
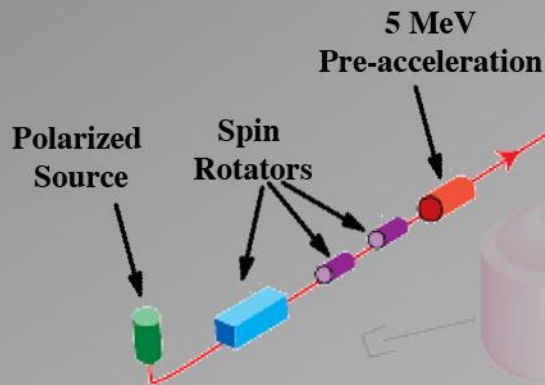

The Detectors

Current detector reference design: **DIRC**

Synthetic Quartz:

- Radiation hard
- High threshold for hadrons
- No scintillation
- UV light sensitive readout (PMT)
- Air-core lightguide (**problematic**)
- Possible alternatives now exist (rad hard UV sensitive CMOS based Si detectors ?)

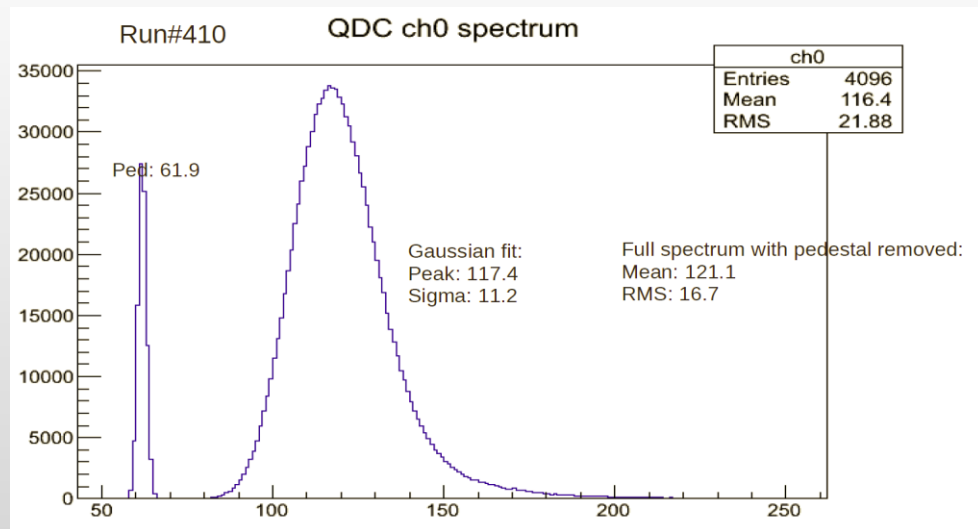
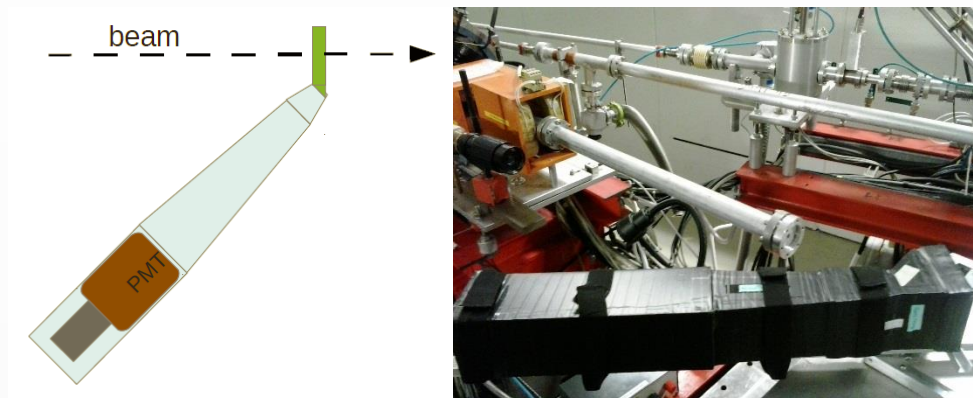

Integrating Detector Signals

Signal Chain:

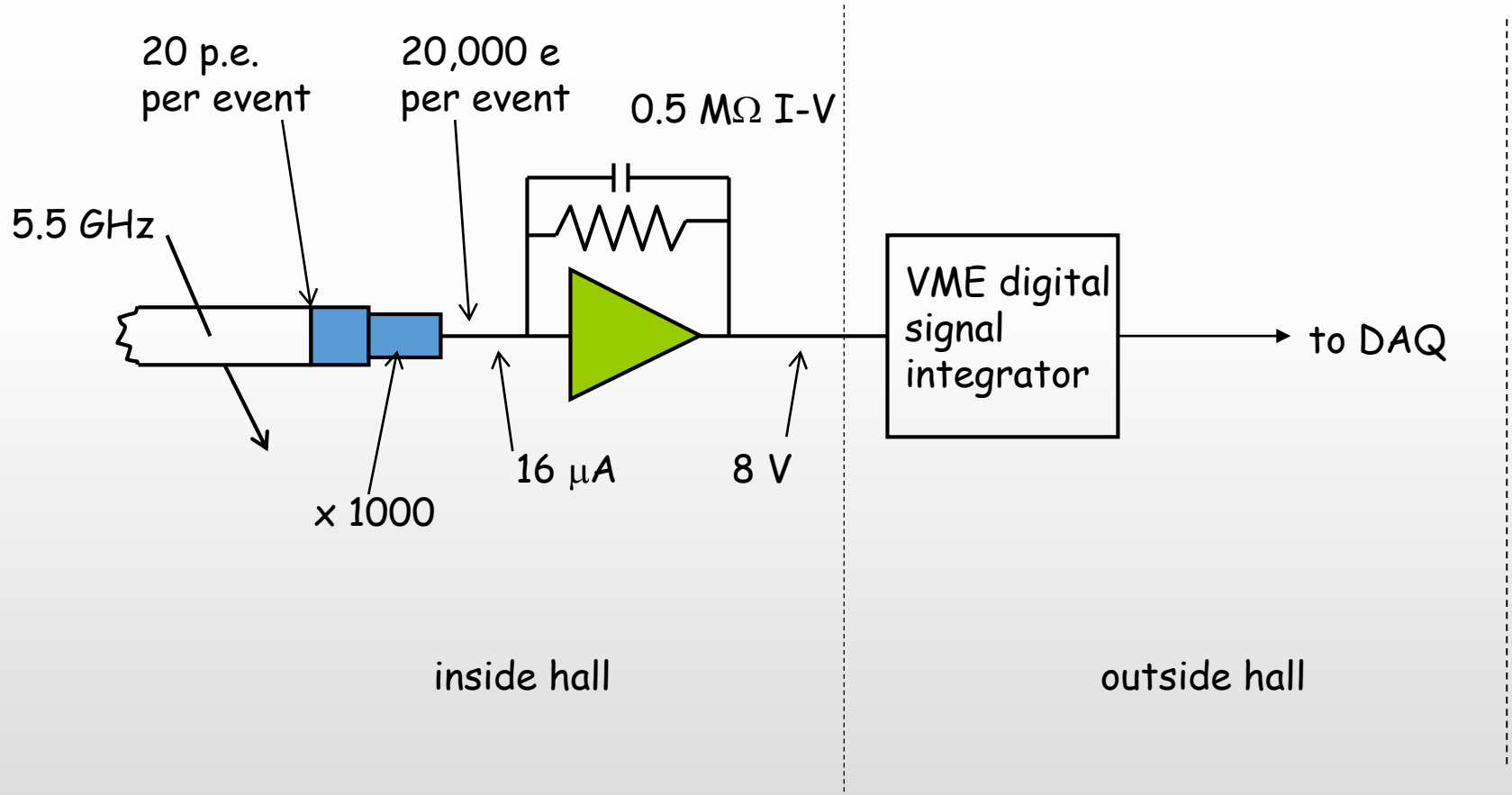

Integrating Detector Project

Bandwidth Issues:

ADC range and resolution (0 suppressed)

$$\Delta V = \frac{10V}{2^{18}} \approx 40 \mu V$$

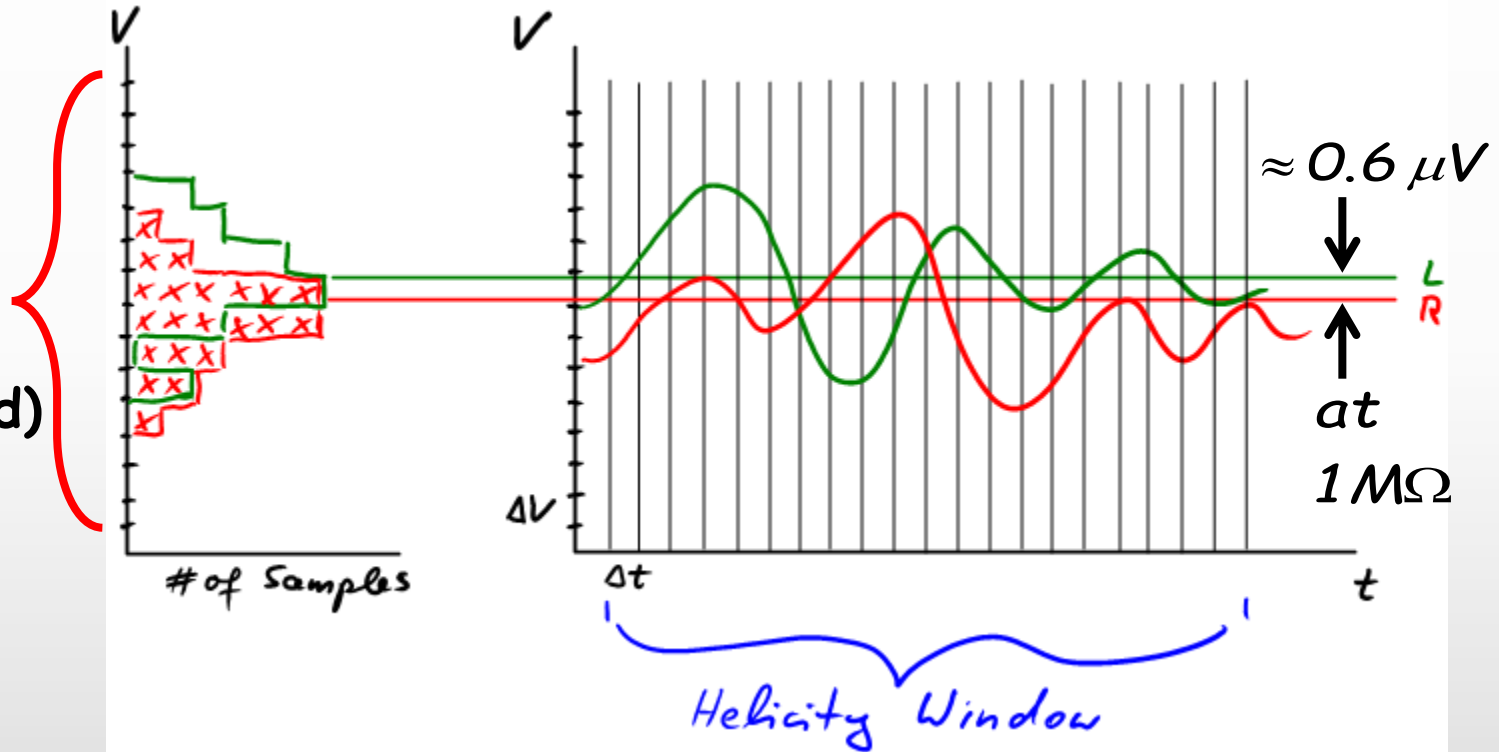

Integrating Detector Project

Competing Bandwidth Considerations:

Favoring Large Bandwidth :

- provides ADC sample distribution large enough to average out the bit noise
- allows the sampling to follow the signal during helicity state transitions
- Since the asymmetry is much smaller than the ADC resolution, filtering away the "high" frequency components leads to random loss of helicity information.
- If the helicity reversal rate goes up, then the analog bandwidth has to go up as well: need a large enough spread to determine the helicity variation for each window
- Satisfying the Nyquist rule up to the frequencies we care about

Integrating Detector Project

Competing Bandwidth Considerations:

Favoring "Smaller" Bandwidth :

- the analog bandwidth one can handle is limited by the maximum sampling rate in the module
- large bandwidths pick up high frequency, large amplitude signals and increase the data RMS and/or introduce systematic effects (non-Gaussian)

Integrating Detector Project

RMS width in the data stream:

Example: $G_{PMT} = 1000$ $G_{AMP} = 0.5 \text{ M}\Omega$

$$N_{pe} \approx 20 \quad \Rightarrow \quad q = 32 \times 10^{-16} \text{ C / track}$$

$$i_A = 1.6 R_e N_{pe} G_{PMT} \times 10^{-10} \text{ nA} = 16 \mu\text{A}$$

$$B = \frac{1}{2} \cdot 2000 \text{ Hz} \quad \text{equivalent noise bandwidth}$$

$$\sigma_{Shot} = \sqrt{2 q i_A} \cdot \sqrt{B} \approx 10 \text{ nA} \approx 5 \text{ mV}$$

Note that: $\frac{1}{\sqrt{N}} = \sqrt{\frac{2000 \text{ Hz}}{R_e}} = 632 \text{ ppm}$

and $\frac{\sigma_{Shot}}{i_A} = \frac{0.01 \mu\text{A}}{16 \mu\text{A}} = 625 \text{ ppm}$

Integrating Detector Project

Preamplifier

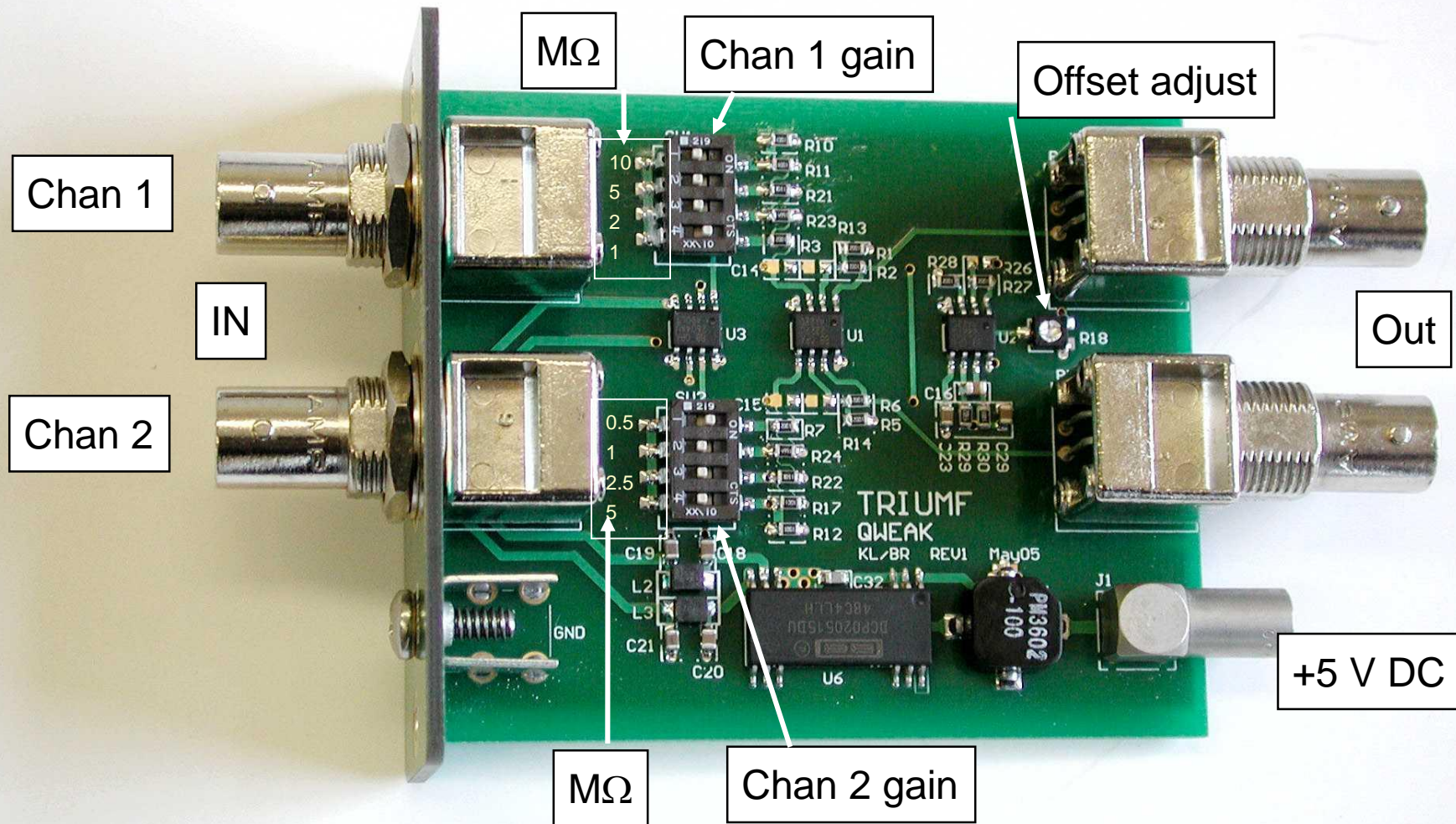

- Reduced power supply noise
- Switchable gains

Integrating Detector Project

TRIUMF VME integrator

component side:

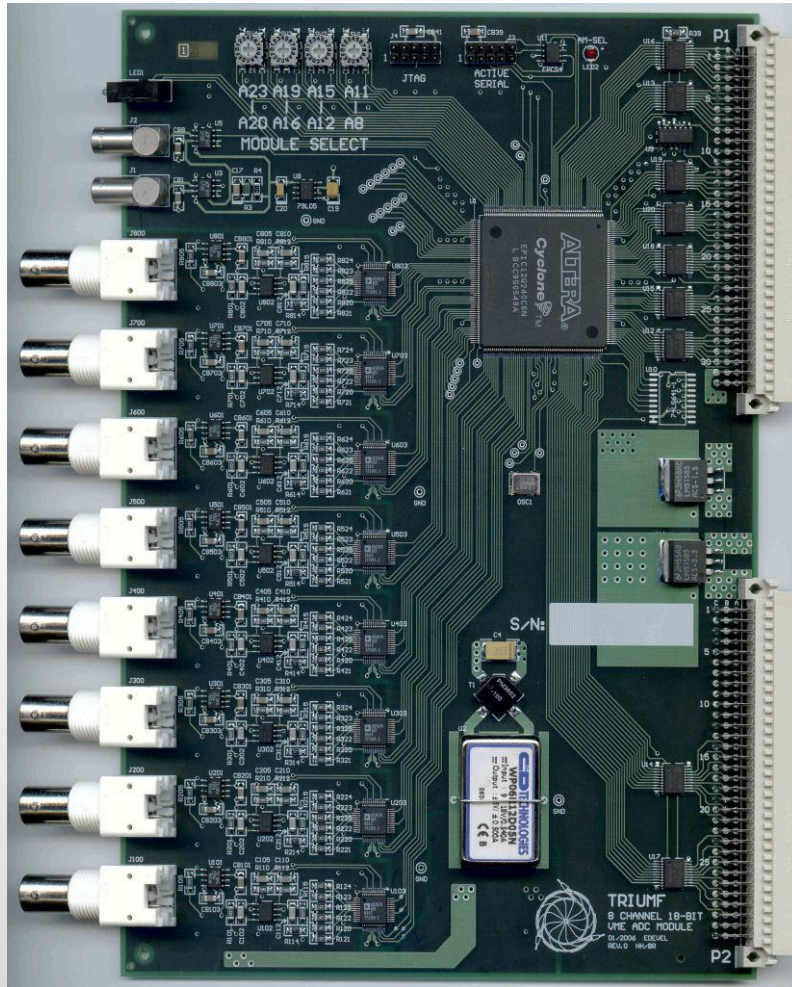

solder side:

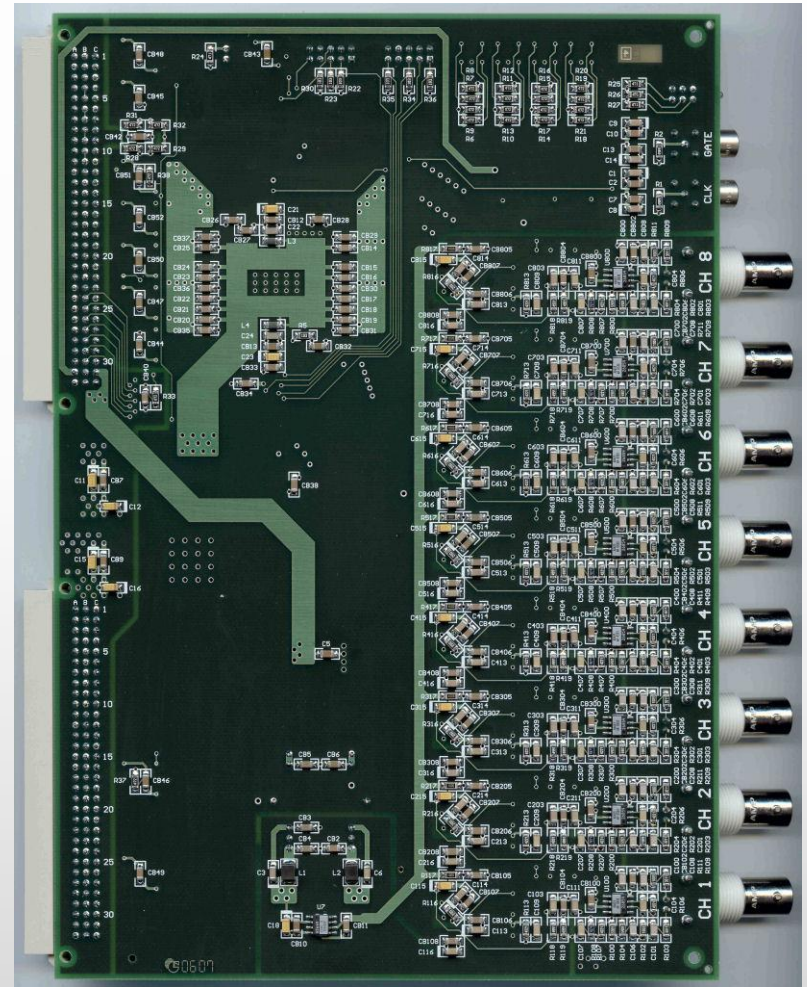

Fast Spin Reversal

The faster the helicity reversal the better the approximation of the signal as a linear drift for many experimental effects.

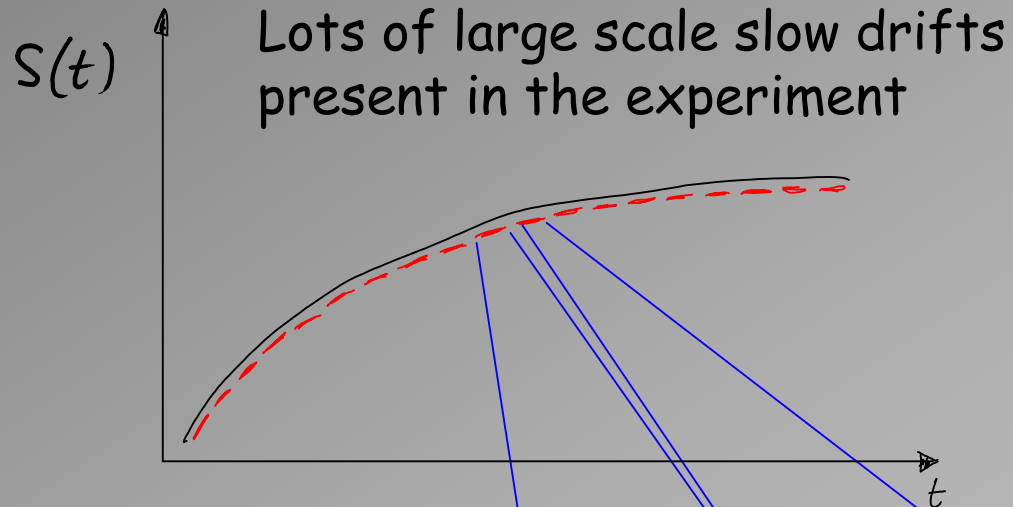

Locally the signal "looks like" a linear function of time:

$$S_{\pm}(t) \approx \left(a + \frac{\Delta S}{\Delta t} t \right) (1 \pm A)$$

The quartet helicity pattern removes linear drifts:

$$A = \frac{\sum_{+} S_{+} - \sum_{-} S_{-}}{\sum_{+} S_{+} + \sum_{-} S_{-}}$$

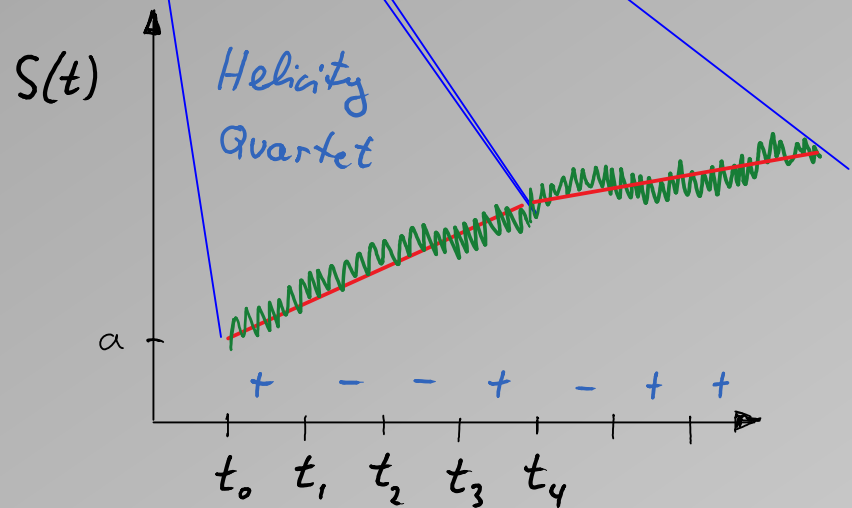

Asymmetry Data

Asymmetry Data Collection:

- Detector yields are integrated over 1 ms for each helicity state
- Raw asymmetries are formed from differences between positive and negative helicity states within a quartet
- Quartet asymmetries are histogrammed

$$A_{msr} = \frac{\sum_{+} N_{+} - \sum_{-} N_{-}}{\sum_{+} N_{+} + \sum_{-} N_{-}}$$

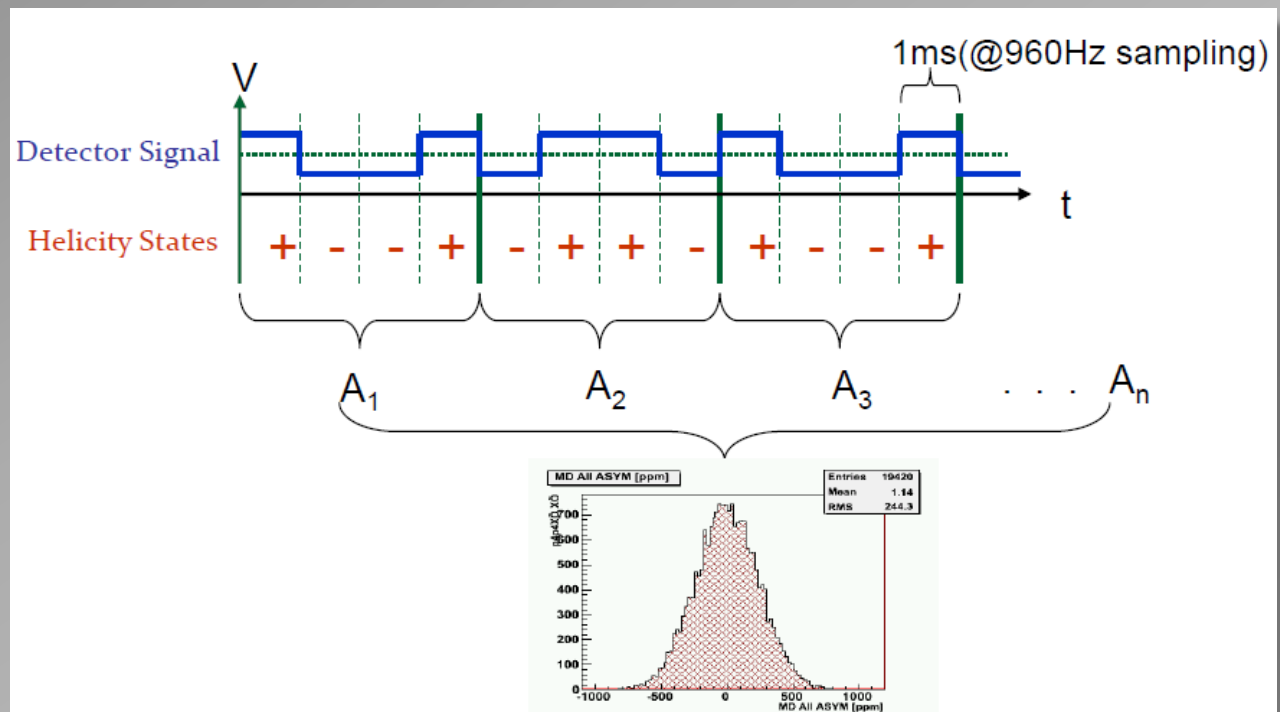

Data Size

Estimate 6 crates, ~10 x Qweak data rate

75 - 100 Qweak ADCs (equivalent).

5 MBytes/sec per crate → 30 MB/sec total → 100 GB/hour

WANT

- Real-time helicity-correlated feedback on Qasy (& possibly other parameters)
- Online Analysis checks of data quality.
- Prompt Analysis of 100% data with full corrections.

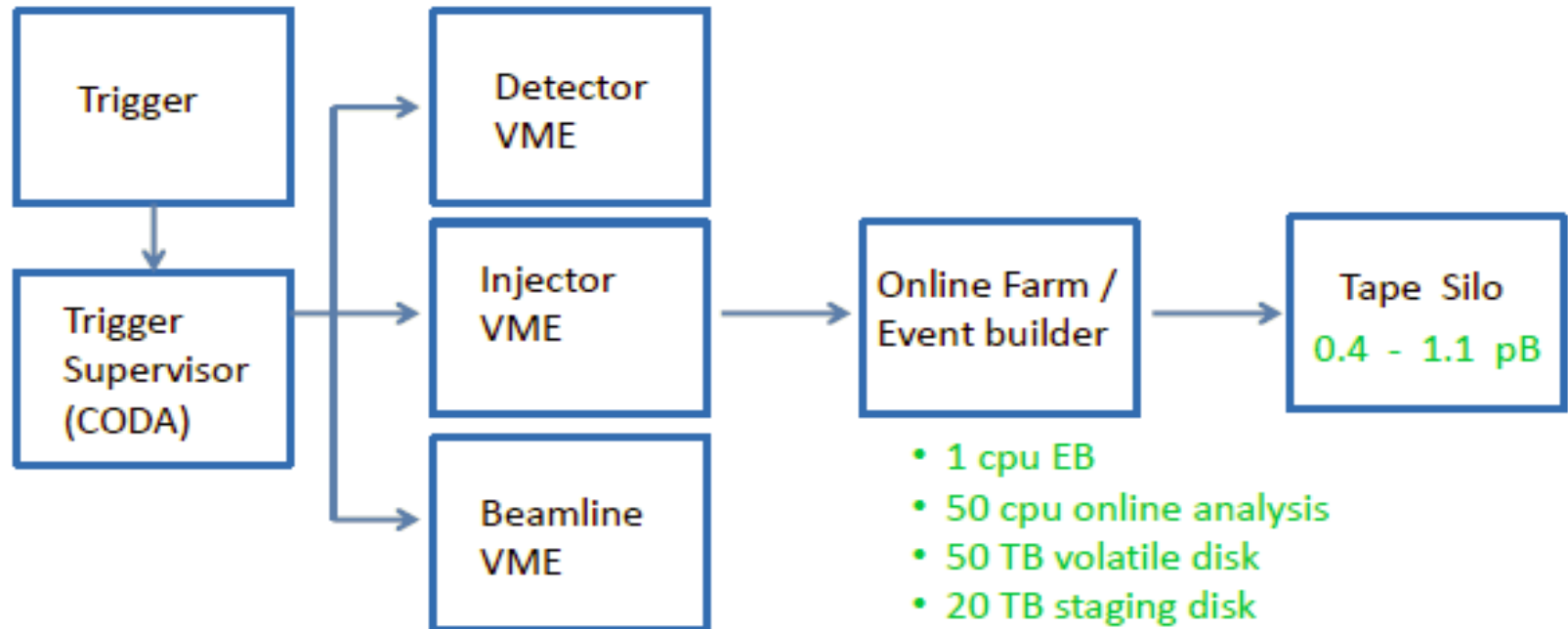

New Physics Sensitivities

New massive boson (dark photon) $U(1)_d$ (not a contact interaction):

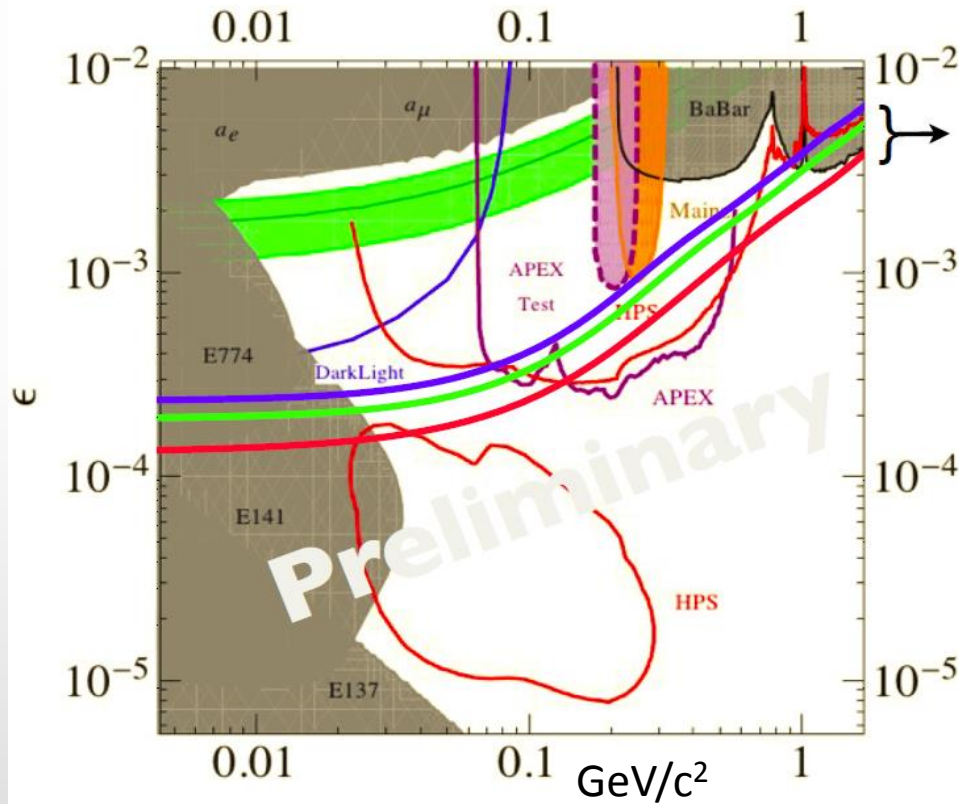

MOLLER (1%, 2%, 3%)

A. Aleksejevs, S. Barkanova and W. Shihao

The mixing of the new $U(1)$ and $U(1)_Y$ of the Standard Model is induced by loops of heavy particles, coupling to both fields.

We assume minimal coupling for X_μ to all charged Standard Model fermions ψ , with effective charge $e_\psi \equiv e$, and e_ψ being the fermionic charge under $U(1)$ QED.

$$\mathcal{L} = \mathcal{L}_{SM} - \frac{1}{4} X_{\mu\nu} F^{\mu\nu} + \underline{\varepsilon e \bar{\psi} \gamma_\mu \psi X^\mu} + \frac{m_{\gamma'}^2}{2} X_\mu X^\mu$$

The Current Canadian Group

University of Manitoba: Jim Birchall, Michael Gericke, Juliette Mammei, Shelley Page, Willem van Oers

University of Winnipeg: Blair Jamieson, Jeff Martin, Russel Mammei

University of Northern British Columbia: Elie Korkmaz

Acadia University: Svetlana Barkanova

Memorial University: Aleksandrs Aleksejevs

The Canadian contingent needs to grow. We would welcome more collaborators !

Contributions could be made in:

- **Detector Design / Construction**
- **Tracking**
- **Simulations**

The MOLLER Collaboration

J. Benesch, P. Brindza, R.D. Carlini, J-P. Chen, E. Chudakov, S. Covrig, C.W. de Jager, A. D'neur, D. Gaskell, J. Gomez, D.W. Higinbotham, J. LeRose, D. Mack, R. Michaels, B. Moffit, S. Nanda, G.R. Smith, P. Solvignon, R. Suleiman, B. Wojtsekhowski (**Jefferson Lab**), H. Baghdasaryan, G. Cates, D. Crabb, D. Day, M.M. Dalton, C. Hanretty, N. Kalantarians, N. Liyanage, V.V. Nelyubin, B. Norum, K. Paschke, M. Shabestari, J. Singh, A. Tobias, K. Wang, X. Zheng (**University of Virginia**), J. Birchall, M.T.W. Gericke, W.R. Falk, L. Lee, S.A. Page, W.T.H. van Oers, (**University of Manitoba**), S. Johnston, **K.S. Kumar**, J. Mammei, L. Mercado, R. Miskimen, S. Riordan, J. Wexler (**University of Massachusetts, Amherst**), V. Bellini, A. Giusa, F. Mammoliti, G. Russo, M.L. Sperduto, C.M. Sutura (**INFN Sezione di Catania and Universita' di Catania**), D.S. Armstrong, T.D. Averett, W. Deconinck, J. Katich, J.P. Leckey (**College of William & Mary**), K. Grimm, K. Johnston, N. Simicevic, S. Wells (**Louisiana Tech University**), L. El Fassi, R. Gilman, G. Kumbartzki, R. Ransome (**Rutgers University**), J. Arrington, K. Hafidi, P.E. Reimer, J. Singh (**Argonne National Lab**), P. Cole, D. Dale, T.A. Forest, D. McNulty (**Idaho State University**), E. Fuchey, F. Itard, C. Muñoz Camacho (**LPC Clermont, Université Blaise Pascal**), J.H. Lee, P.M. King, J. Roche (**Ohio University**), E. Cisbani, S. Frullani, F. Garibaldi (**INFN Gruppo Collegato Sanita' and Istituto Superiore di Sanità**), R. De Leo, L. Lagamba, S. Marrone (**INFN, Sezione di Bari and University di Bari**), F. Meddi, G.M. Urciuoli (**Dipartimento di Fisica dell'Universita' la Sapienza and INFN Sezione di Roma**), R. Holmes, P. Souder (**Syracuse University**), G. Franklin, B. Quinn (**Carnegie Mellon University**), W. Duvall, A. Lee, M. Pitt (**Virginia Polytechnic Institute and State University**), J.A. Dunne, D. Dutta (**Mississippi State University**), A.T. Katramatou, G. G. Petratos (**Kent State University**), A. Ahmidouch, S. Danagoulian (**North Carolina A&T State University**), S. Kowalski, V. Sulkosky (**MIT**), P. Decowski (**Smith College**), J. Erler (**Universidad Autónoma de México**), M.J. Ramsey-Musolf (**University of Wisconsin, Madison**), Yu.G. Kolomensky (**University of California, Berkeley**), K. A. Aniol (**California State U.(Los Angeles)**), C.A. Davis, W.D. Ramsay (**TRIUMF**), J.W. Martin (**University of Winnipeg**), E. Korkmaz (**University of Northern British Columbia**), T. Holmstrom (**Longwood University**), S.F. Pate (**New Mexico State University**), G. Ron (**Hebrew University of Jerusalem**), D.T. Spayde (**Hendrix College**), P. Markowitz (**Florida International University**), F.R. Wesselmann (**Xavier University of Louisiana**), F. Maas (**Johannes Gutenberg Universitaet Mainz**), C. Hyde (**Old Dominion University**), F. Benmokhtar (**Christopher Newport University**), E. Schulte (**Temple University**), M. Capogni (**Istituto Nazionale di Metrologia delle Radiazioni Ionizzanti ENEA and INFN Gruppo Collegato Sanità**), R. Perrino (**INFN Sezione di Lecce**)