

Etude d'Implantation

equipement "cv" (TK back up chiller)
usc55

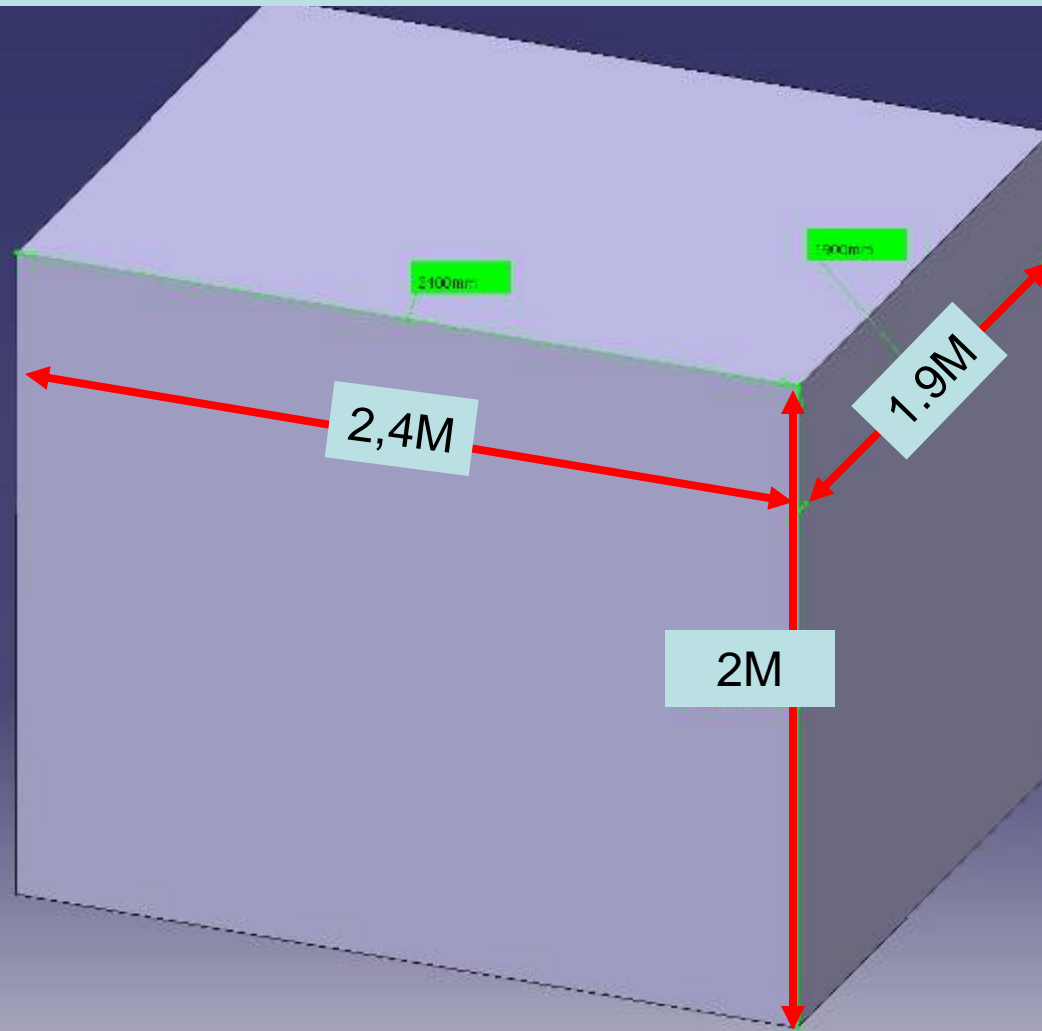



1,8M!!!

PLUSIEURS PROPOSITION DE
ZONES D'IMPLANTATION POSSIBLE

SOUS ESCALIER

SOUS ESCALIER

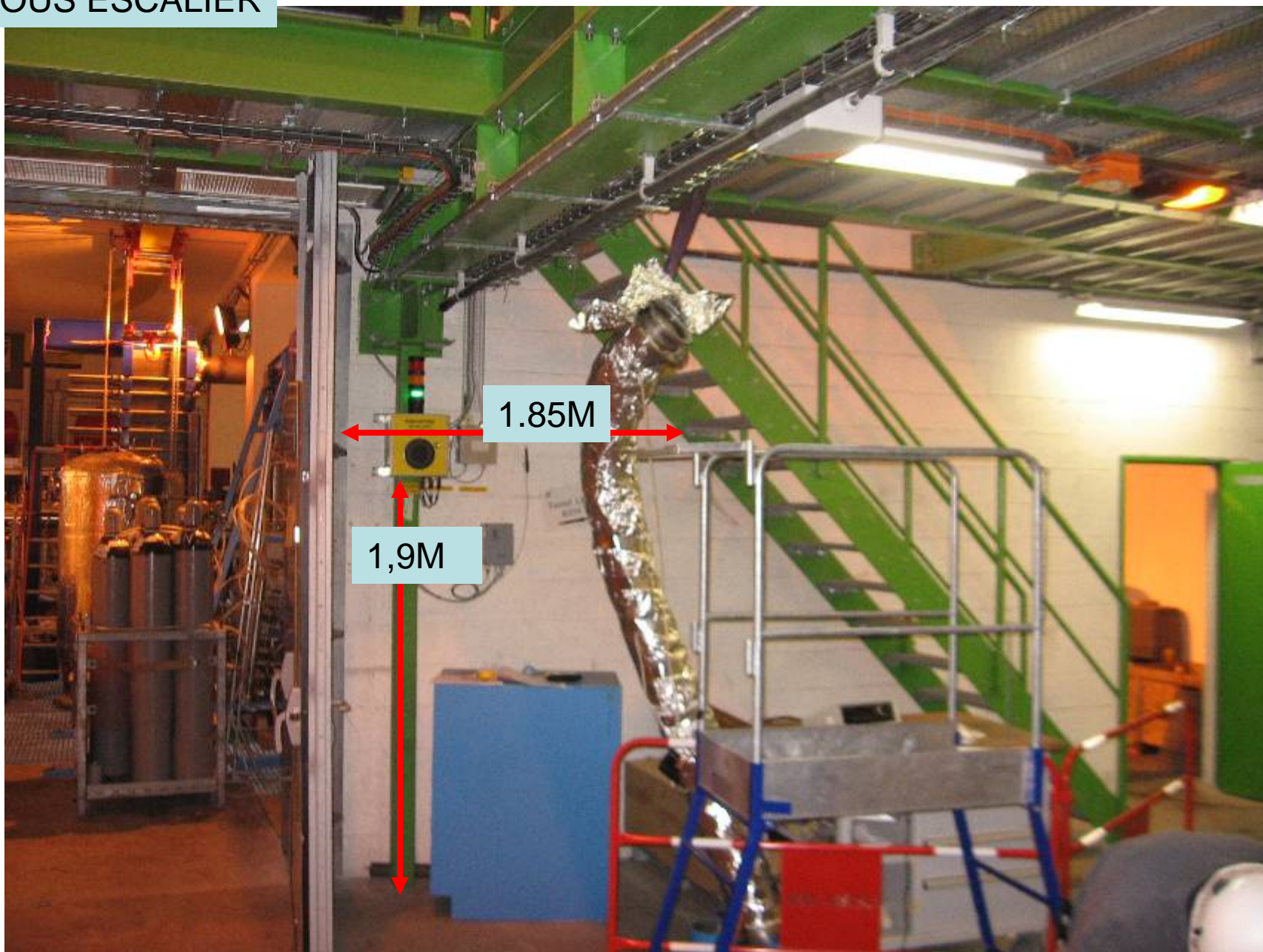

250 mm mini du mur

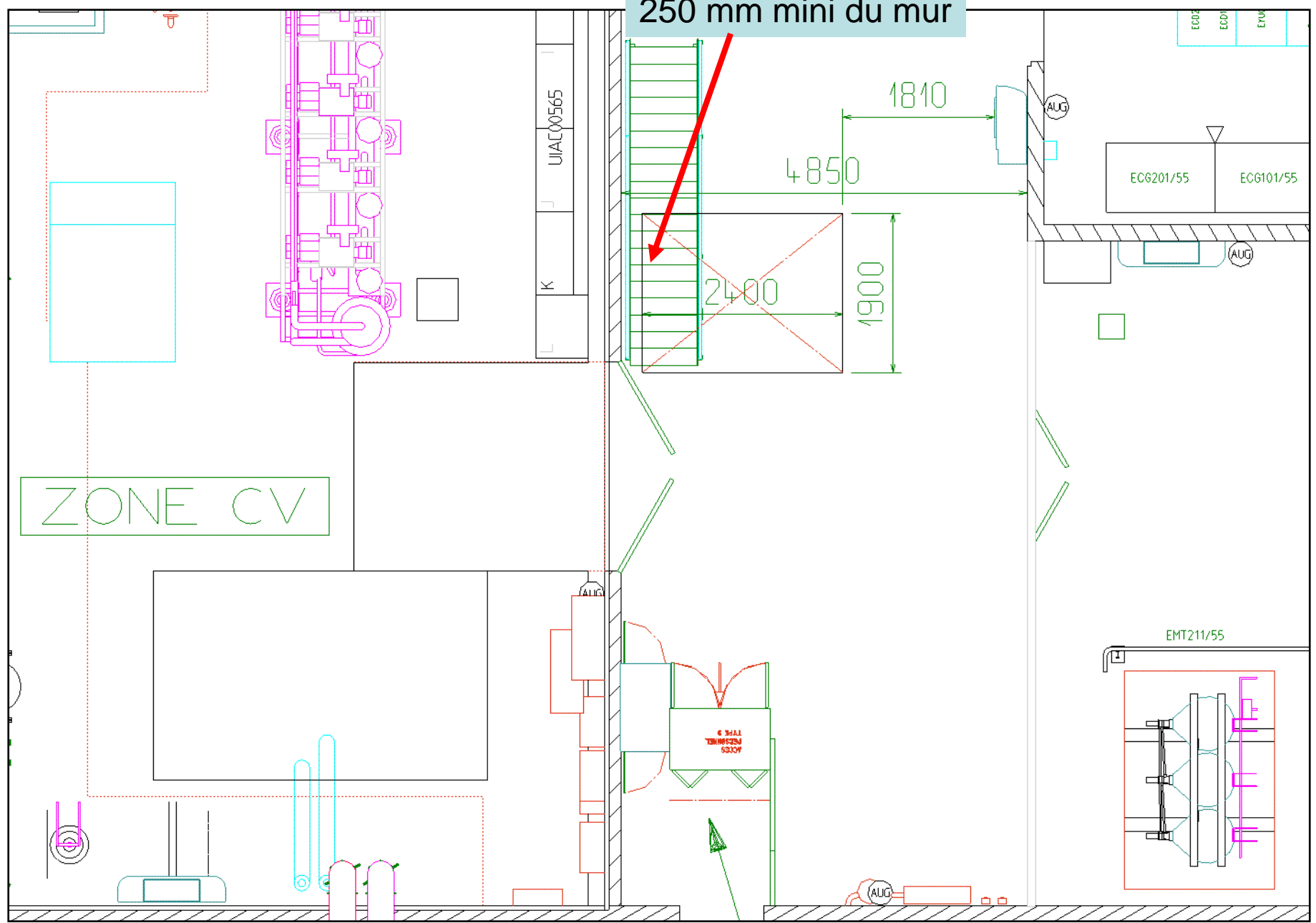

SOUS ESCALIER

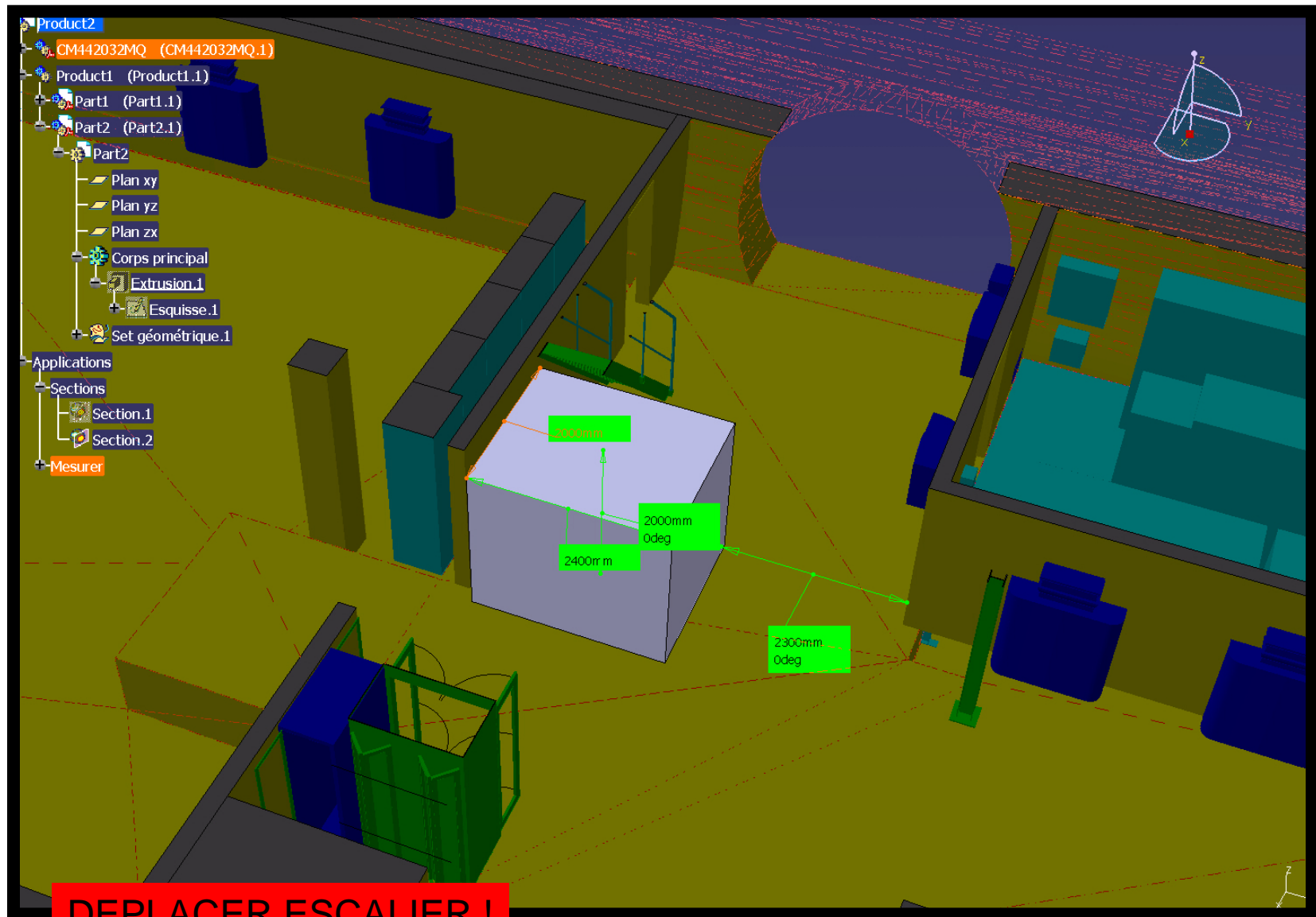

SOUS ESCALIER

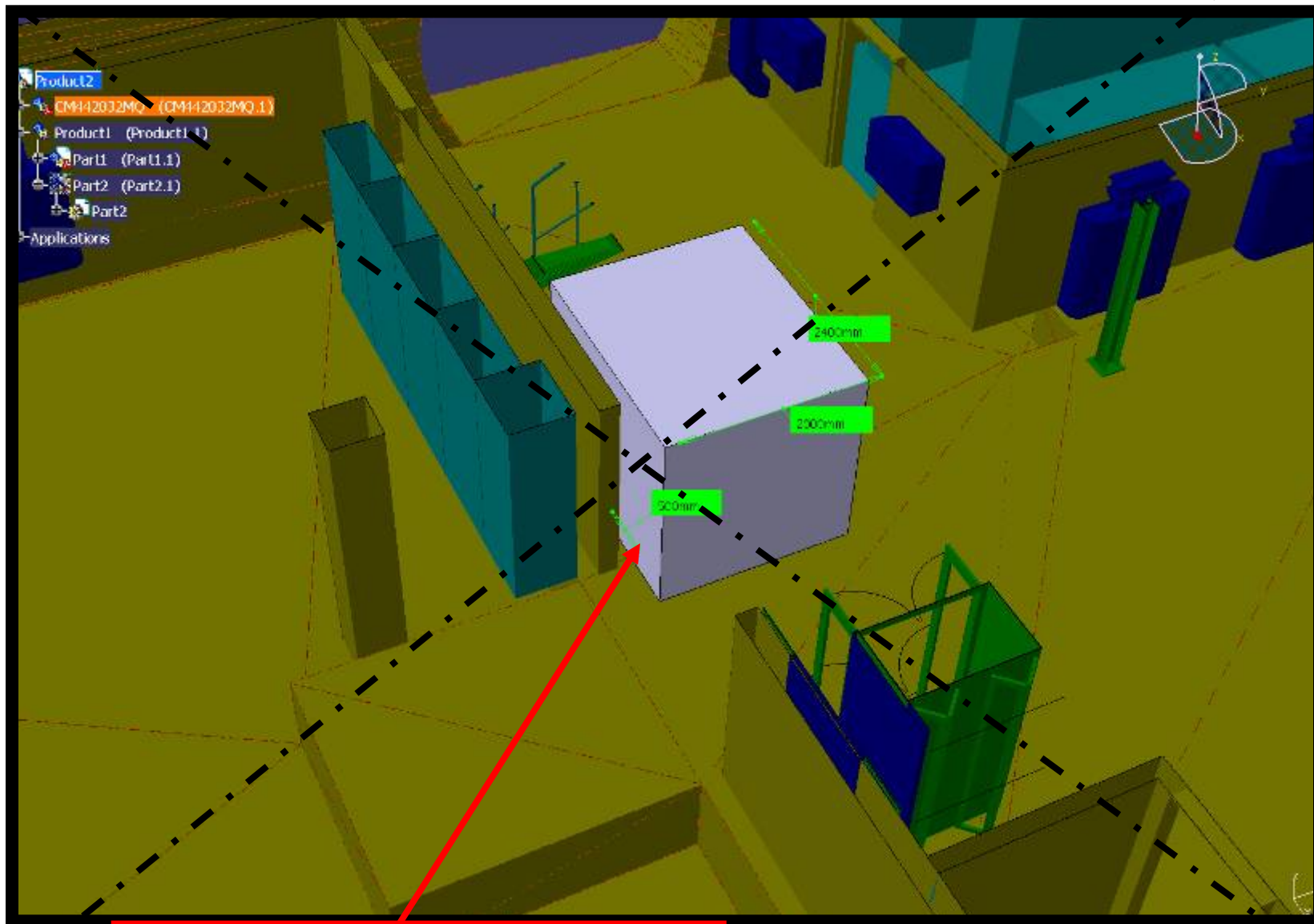

BLOCAGE OUVERTURE PORTE



ZONE “LOCAL CV”



ZONE LIBRE ???

ZONE TREMIS/“MAD/PAD”

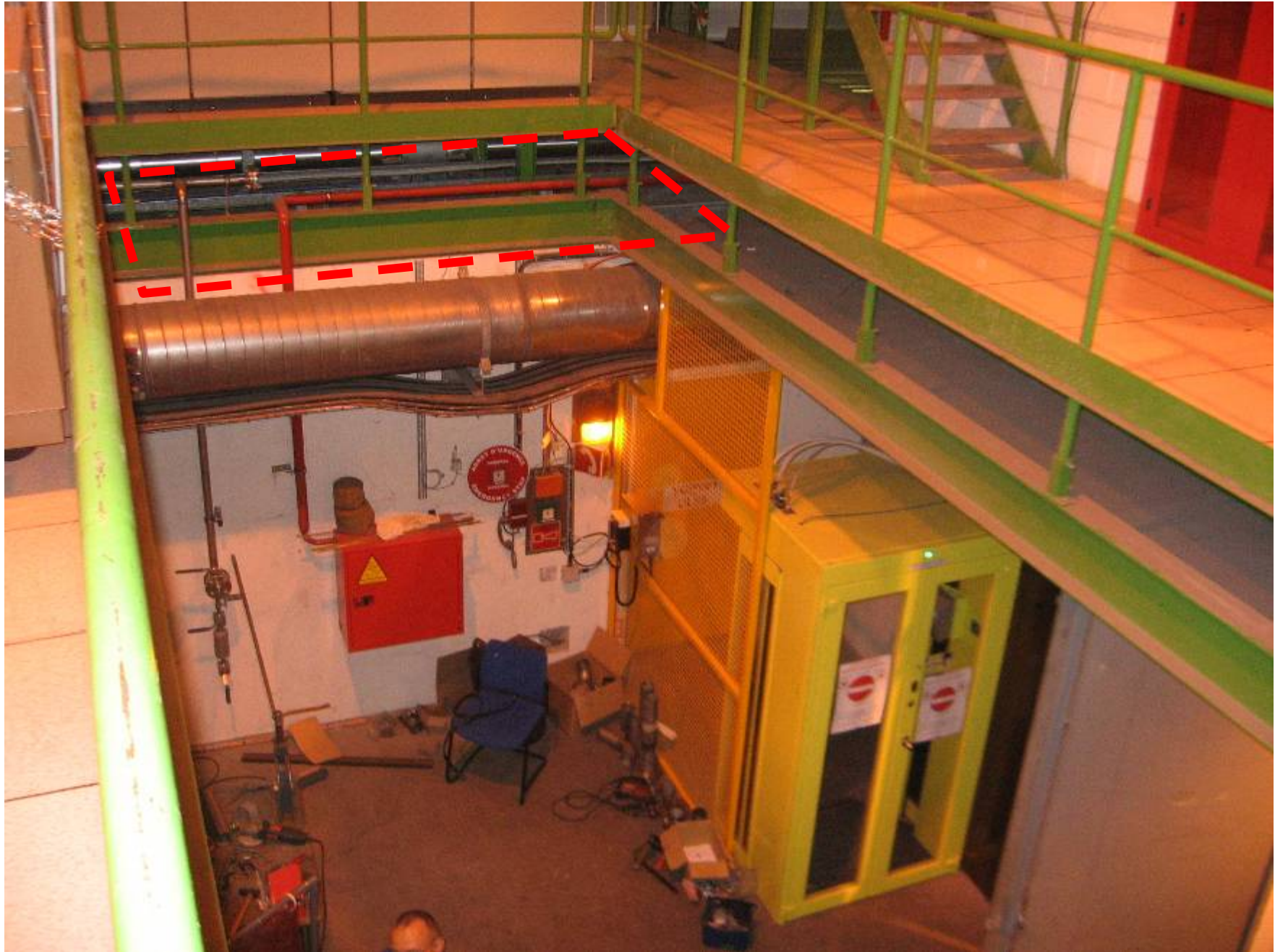



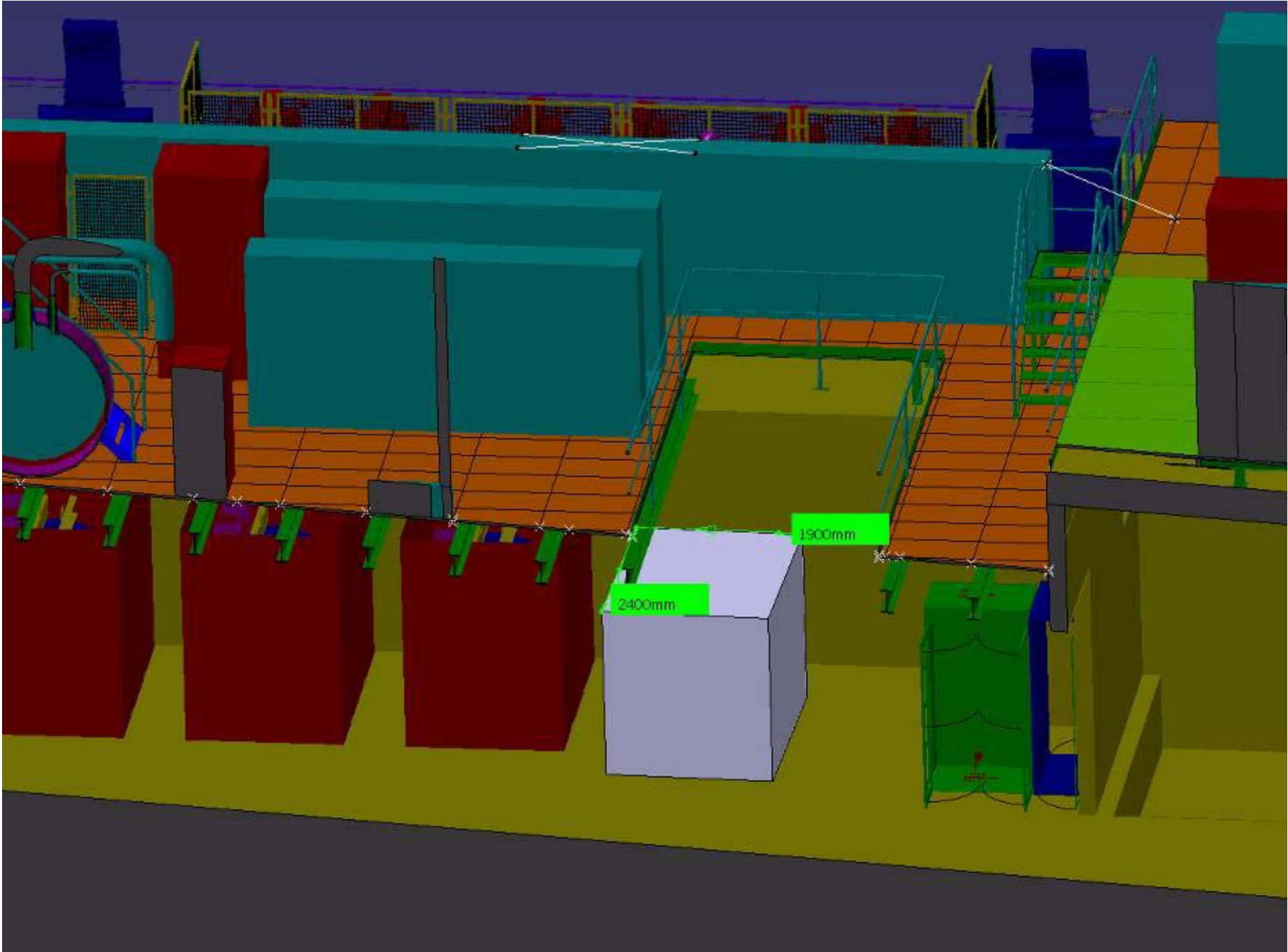

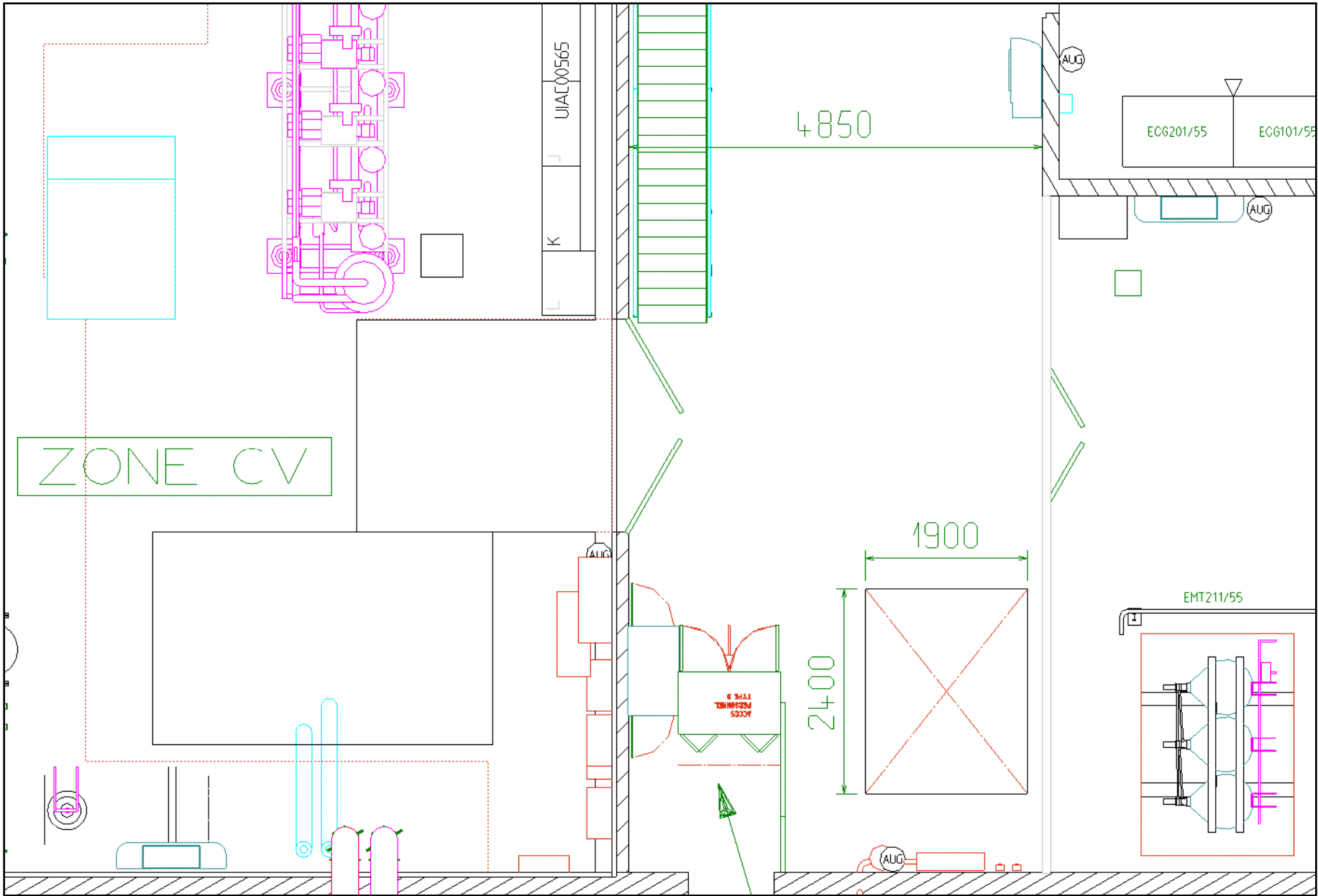

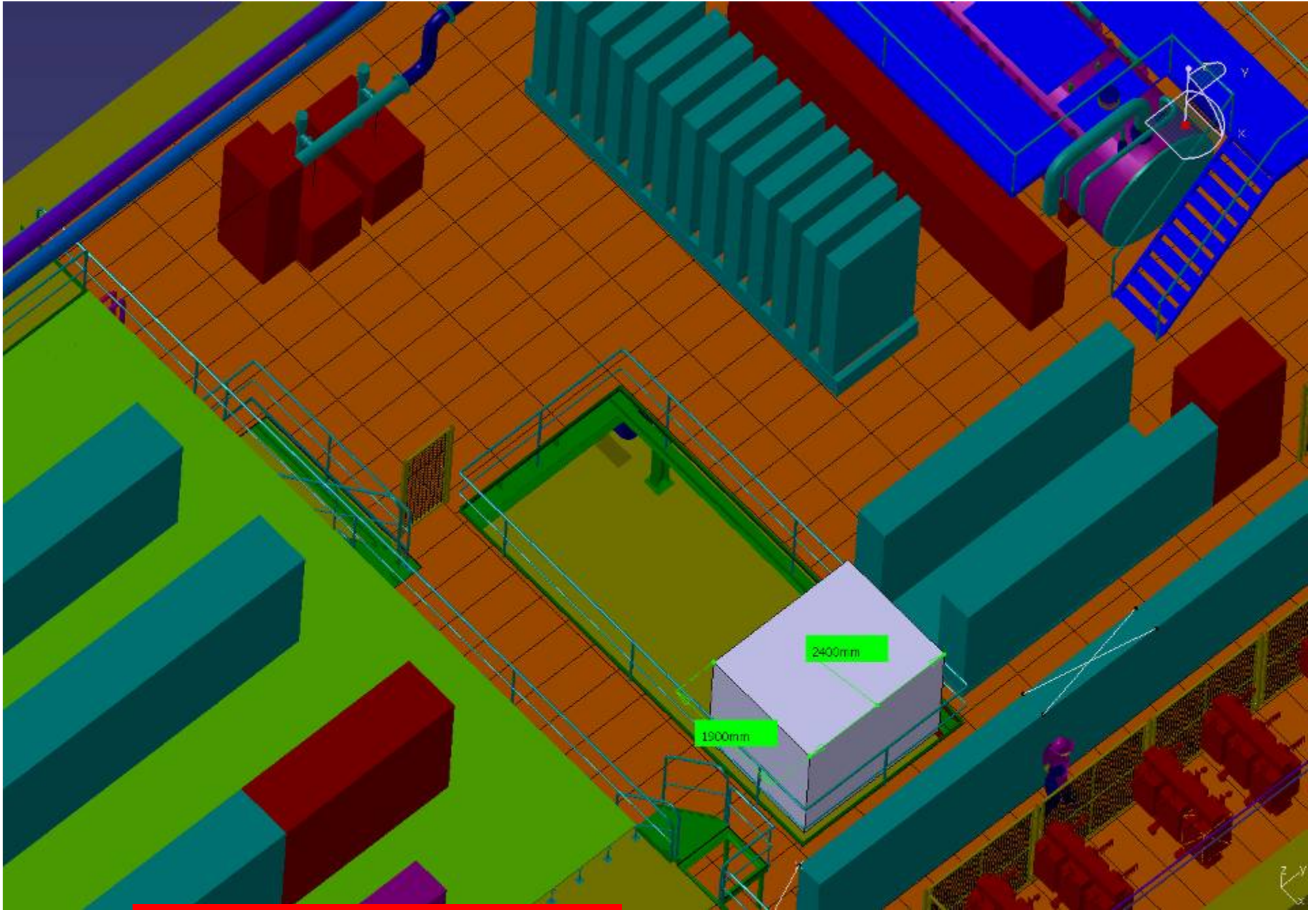

CREER UN CADRE SUPPORT

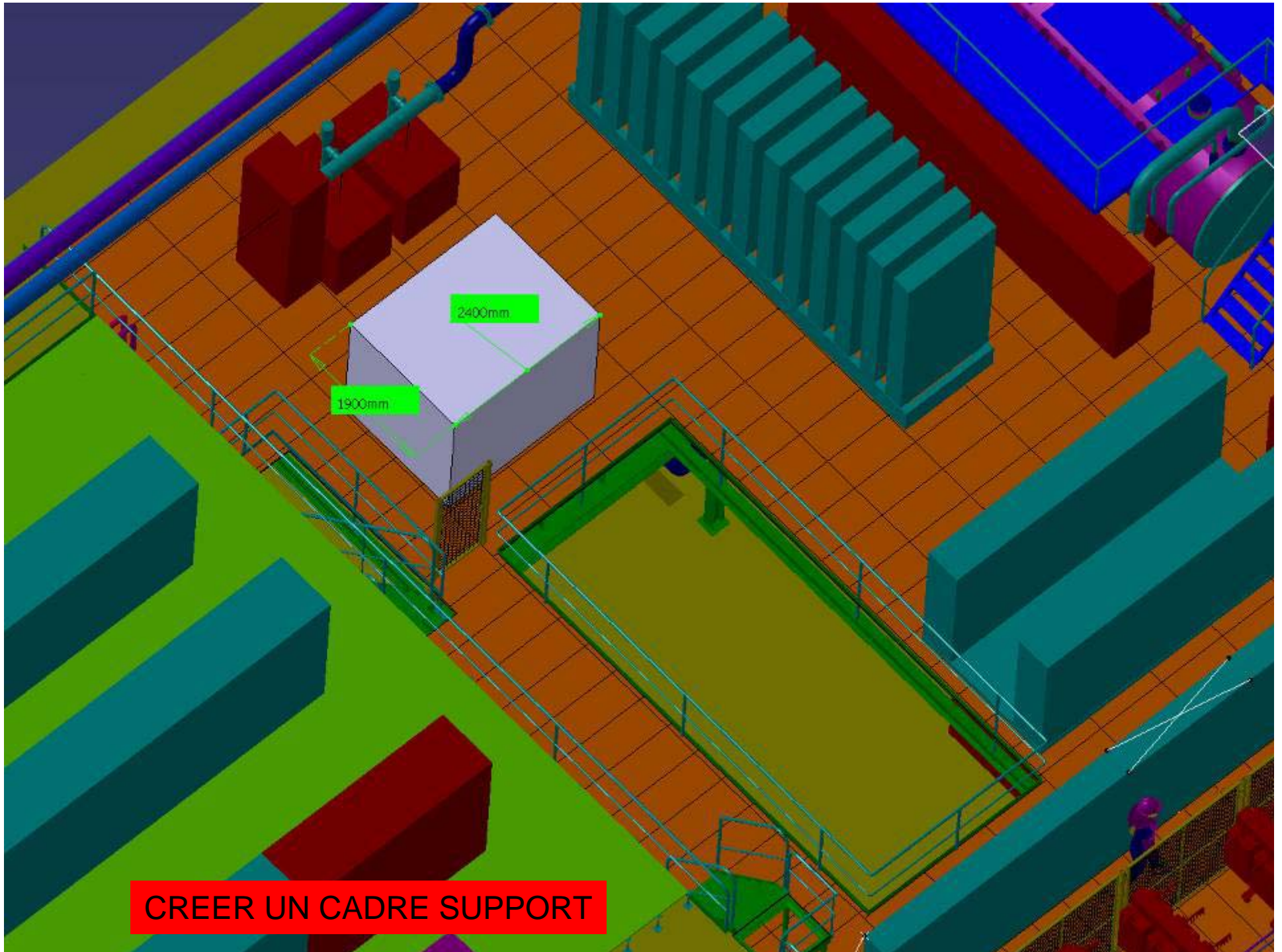

CREER UN CADRE SUPPORT



- ETUDE DE CHEMINEMENT DEPUIS
TREMIS DU PUIT

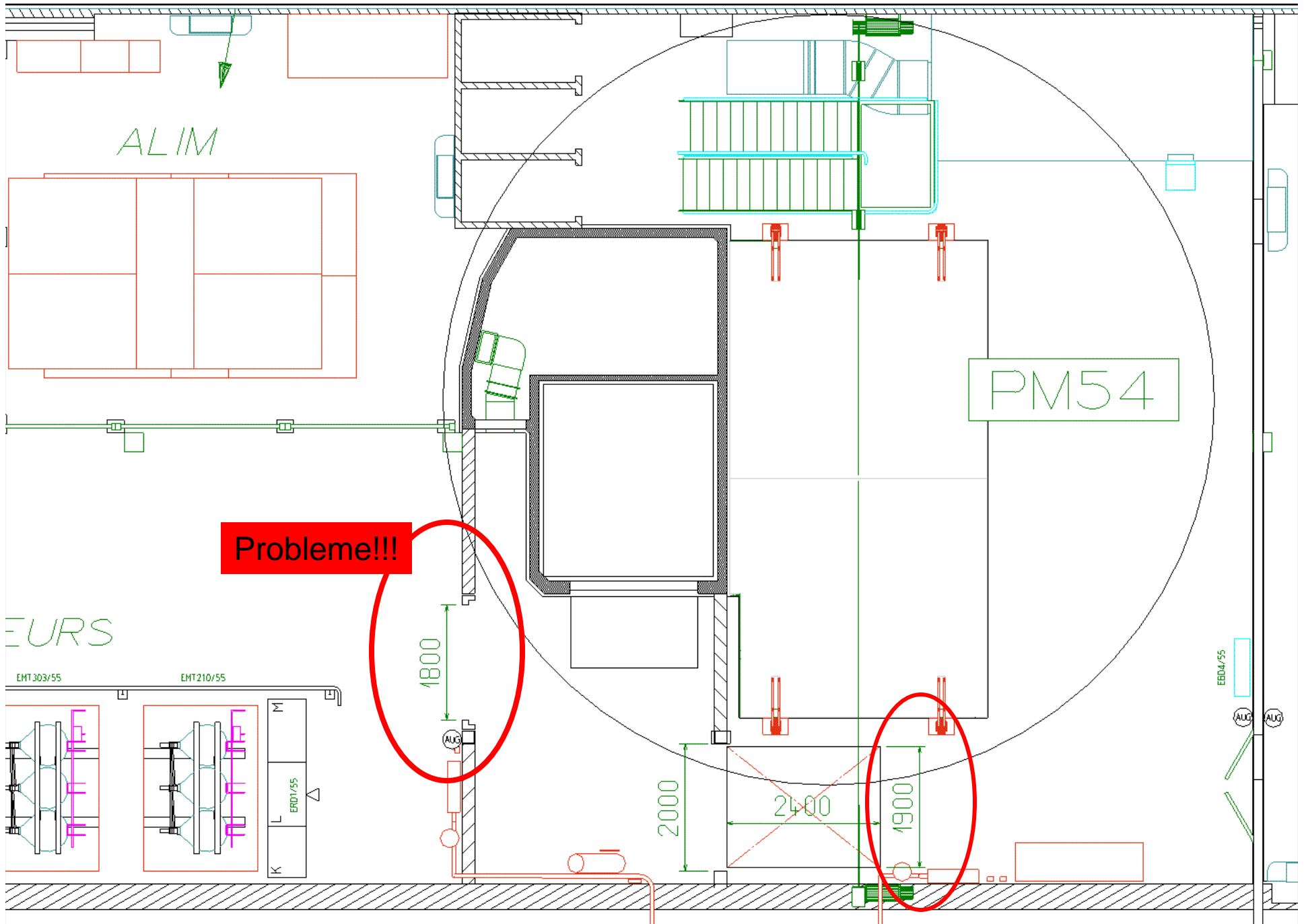

ALIM

PM54

EURS

Probleme!!!

1800

2000

2400

1900

