

LTD AND ITS APPLICATION TO NLO COMPUTATIONS



Germán F. R. Sborlini

in collaboration with R. Hernández-Pinto and G. Rodrigo



*Institut de Física Corpuscular
UV-CSIC (Spain)
and
Departamento de Física
FCEyN, UBA (Argentina)*



QCD@LHC 2015 Queen Mary University of London
1st - 5th September 2015



QCD@LHC 2015 (London-UK) – 09/04/2015

Content

2

- Introduction to Loop-tree duality (LTD)
- IR regularization
 - ▣ Threshold and IR singularities
 - ▣ Finite real+virtual integration
- UV renormalization
- Conclusions

Based on:

Catani *et al.*, *JHEP* 09 (2008) 065

Bierenbaum *et al.*, *JHEP* 1010 (2010) 073; *JHEP* 03 (2013) 025

Buchta *et al.*, *JHEP* 11 (2014) 014

Hernández-Pinto, Rodrigo and GS, [arXiv:2015.04617 \[hep-ph\]](https://arxiv.org/abs/2015.04617)

Rodrigo *et al.*, in preparation (to be published soon...)

Loop-tree duality (LTD)

3 Introduction and motivation

- KLN theorem suggests that **virtual and real** contributions have the **same IR divergent structure** (because they cancel in IR-safe observables)
- **Cut contributions** are similar to **tree-level** scattering amplitudes, if all the loops are cut. At one-loop, **1-cuts are tree-level objects** (higher-cuts are products of unconnected graphs)
- **Objective:** Combine real and virtual contributions at **integrand level** and perform the **computation in four-dimensions** (take ε to 0 with DREG)
 - Write virtual contributions as real radiation phase-space integrals of «*tree-level*» objects  *1-cut = sum over «tree level» contributions*
 - *Loop measure is related with extra-radiation phase-space*

 **Loop-Tree Duality**

Catani et al, JHEP 09 (2008) 065

Loop-tree duality (LTD)

4

Dual representation of one-loop integrals

**Loop
Feynman
integral**

$$L^{(1)}(p_1, \dots, p_N) = \int_{\ell} \prod_{i=1}^N G_F(q_i) = \int_{\ell} \prod_{i=1}^N \frac{1}{q_i^2 - m_i^2 + i0}$$



**Dual
integral**

$$L^{(1)}(p_1, \dots, p_N) = - \sum_{i=1}^N \int_{\ell} \tilde{\delta}(q_i) \prod_{j=1, j \neq i}^N G_D(q_i; q_j)$$

**Sum of phase-
space integrals!**

$$G_D(q_i, q_j) = \frac{1}{q_j^2 - m_j^2 - i0\eta(q_j - q_i)}$$

$$\tilde{\delta}(q_i) = i2\pi \theta(q_{i,0}) \delta(q_i^2 - m_i^2)$$

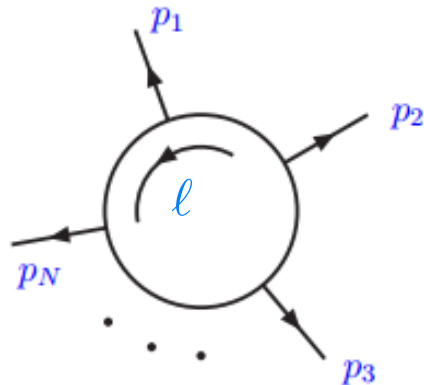

$$= - \sum_{i=1}^N$$

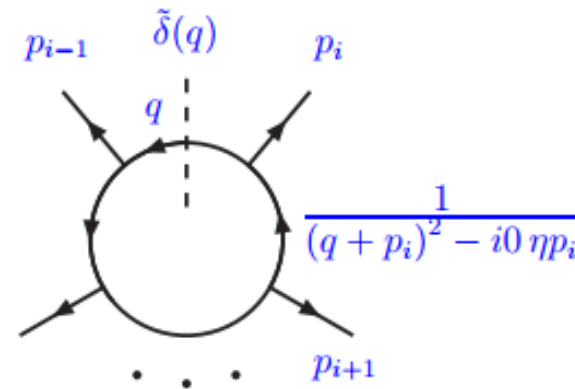

Loop-tree duality (LTD)

5

Derivation

- **Idea:** «Sum over all possible 1-cuts» (but with a **modified i0 prescription...**)
 - Apply Cauchy residue theorem to the Feynman integral:

$$L^{(N)}(p_1, p_2, \dots, p_N) = \int_{\mathbf{q}} \int dq_0 \prod_{i=1}^N G(q_i) = \int_{\mathbf{q}} \int_{C_L} dq_0 \prod_{i=1}^N G(q_i) = -2\pi i \int_{\mathbf{q}} \sum \text{Res}_{\{\text{Im } q_0 < 0\}} \left[\prod_{i=1}^N G(q_i) \right]$$

- Select the residue of the poles with negative imaginary part:

$$\text{Res}_{\{i\text{-th pole}\}} \left[\prod_{j=1}^N G(q_j) \right] = \left[\text{Res}_{\{i\text{-th pole}\}} G(q_i) \right] \left[\prod_{\substack{j=1 \\ j \neq i}}^N G(q_j) \right]_{\{i\text{-th pole}\}}$$

$$\left[\text{Res}_{\{i\text{-th pole}\}} \frac{1}{q_i^2 + i0} \right] = \int dq_0 \delta_+(q_i^2) \quad \left[\prod_{j \neq i} G(q_j) \right]_{\{i\text{-th pole}\}} = \prod_{j \neq i} \frac{1}{q_j^2 - i0 \eta(q_j - q_i)}$$

Set internal propagators on-shell

Introduction of «dual propagators» (η prescription, a future- or light-like vector)

Loop-tree duality (LTD)

6 Threshold and IR singularities

- Feynman integrands develop singularities when propagators go on-shell. LTD allows to understand it as soft/collinear divergences of real radiation.

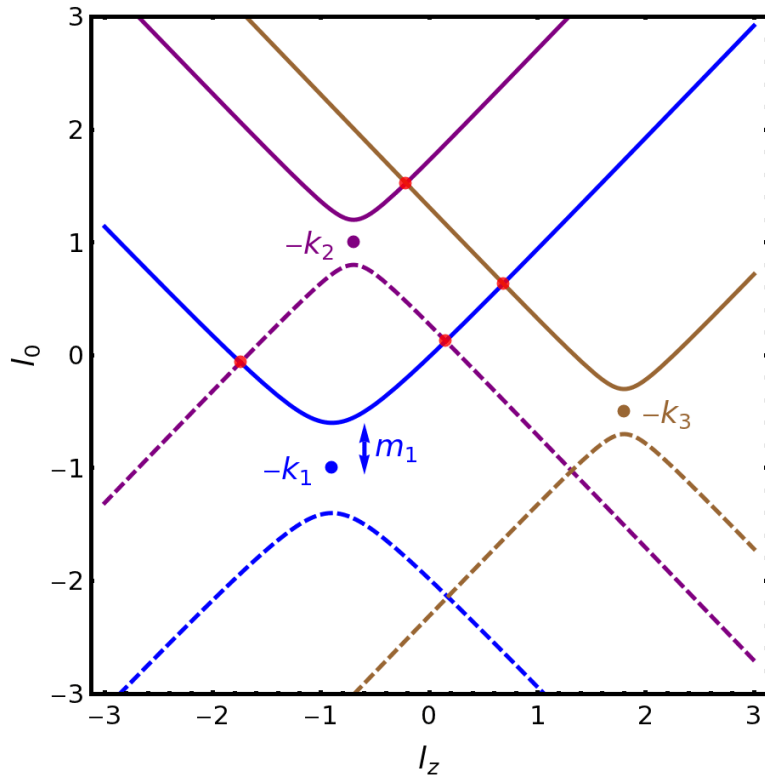

Massive case: hyperboloids

- Forward (backward) on-shell hyperboloids associated with positive (negative) energy solutions.

$$G_F^{-1}(q_i) = q_i^2 - m_i^2 + i0 = 0$$

$$q_{i,0}^{(\pm)} = \pm \sqrt{\mathbf{q}_i^2 + m_i^2 - i0}$$

- LTD equivalent to integrate along the forward on-shell hyperboloids.
- Degenerate to light-cones for massless propagators.
- Dual integrands become singular at intersections (two or more on-shell propagators)

Loop-tree duality (LTD)

7 Threshold and IR singularities

- Feynman integrands develop singularities when propagators go on-shell. LTD allows to understand it as soft/collinear divergences of real radiation.

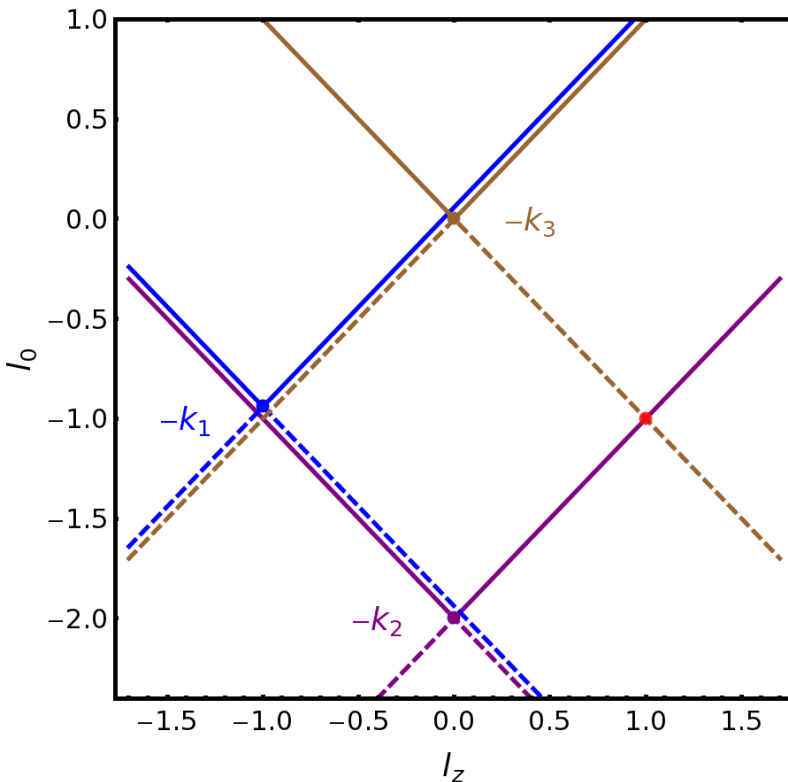

Massless case: light-cones

- Forward (backward) on-shell hyperboloids associated with positive (negative) energy solutions.

$$G_F^{-1}(q_i) = q_i^2 - m_i^2 + i0 = 0$$

$$q_{i,0}^{(\pm)} = \pm \sqrt{\mathbf{q}_i^2 + m_i^2 - i0}$$

- LTD equivalent to integrate along the forward on-shell hyperboloids.
- **Degenerate to light-cones for massless propagators.**
- Dual integrands become singular at intersections (two or more on-shell propagators)

IR regularization in LTD

8

IR singularities

- Reference example: Massless scalar three-point function in the time-like region

$$L^{(1)}(p_1, p_2, -p_3) = \int_{\ell} \prod_{i=1}^3 G_F(q_i) = -\frac{c_{\Gamma}}{\epsilon^2} \left(-\frac{s_{12}}{\mu^2} - i0 \right)^{-1-\epsilon} = \sum_{i=1}^3 I_i$$

Original loop integral (internal momenta flows counter-clockwise)

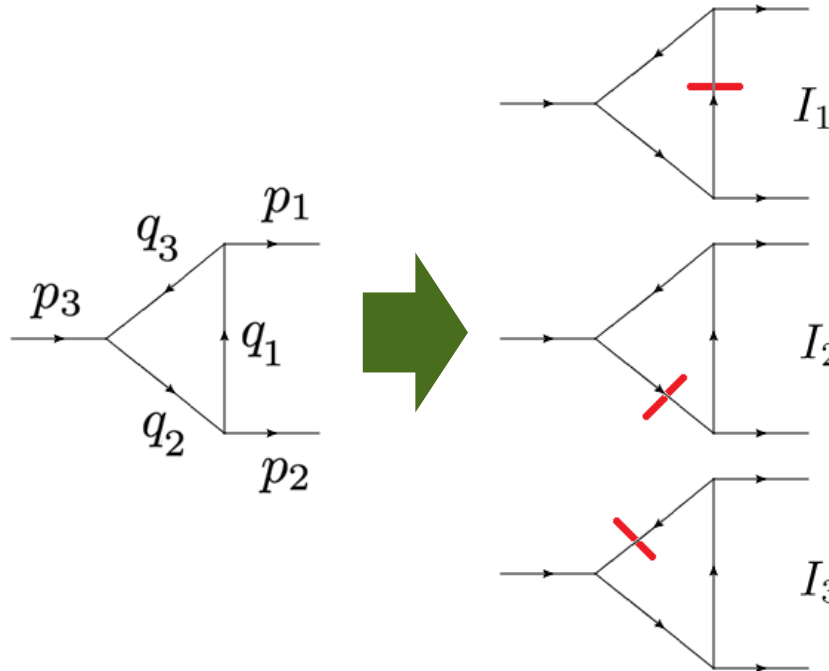

Dual integrals
(graphical definition)

IR regularization in LTD

9

IR singularities

- Reference example: Massless scalar three-point function in the time-like region

$$L^{(1)}(p_1, p_2, -p_3) = \int_{\ell} \prod_{i=1}^3 G_F(q_i) = -\frac{c_{\Gamma}}{\epsilon^2} \left(-\frac{s_{12}}{\mu^2} - i0 \right)^{-1-\epsilon} = \sum_{i=1}^3 I_i$$



$$I_1 = \frac{1}{s_{12}} \int d[\xi_{1,0}] d[v_1] \xi_{1,0}^{-1} (v_1(1-v_1))^{-1}$$

$$I_2 = \frac{1}{s_{12}} \int d[\xi_{2,0}] d[v_2] \frac{(1-v_2)^{-1}}{1-\xi_{2,0} + i0}$$

$$I_3 = \frac{1}{s_{12}} \int d[\xi_{3,0}] d[v_3] \frac{v_3^{-1}}{1+\xi_{3,0} - i0}$$

$$d[\xi_{i,0}] = \frac{\mu^{2\epsilon} (4\pi)^{\epsilon-2}}{\Gamma(1-\epsilon)} s_{12}^{-2\epsilon} \xi_{i,0}^{-2\epsilon} d\xi_{i,0}$$

$$d[v_i] = (v_i(1-v_i))^{-\epsilon} dv_i$$

To regularize
threshold
singularity

Integration measure in DREG:
loop energy and polar angle

- This integral is UV-finite; there are only IR-singularities, associated to soft and collinear regions
- OBJECTIVE:** Define a *IR-regularized* loop integral by adding real corrections at integrand level (i.e. no epsilon should appear, 4D representation)

IR regularization in LTD

10

IR singularities

- Analyze the integration region: Application of LTD converts loop-integrals into PS: integrate in forward light-cones.

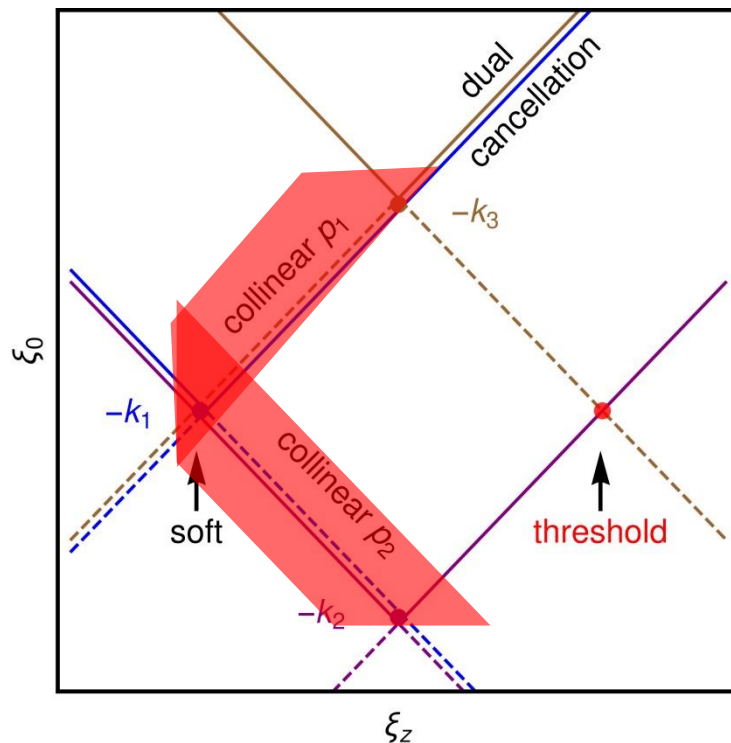

- Only **forward-backward** interference originate **threshold or IR poles**.
- **Forward-forward** cancel among dual contributions
- Threshold and IR singularities associated with finite regions (i.e. contained in a **compact region**)
- No threshold or IR singularity at large loop momentum

- This structure suggests how to perform real-virtual combination! Also, how to overcome threshold singularities (integrable but numerically unstable)

IR regularization in LTD

11

IR singularities

- Analyze the integration region: Application of LTD converts loop-integrals into PS: integrate in forward light-cones.

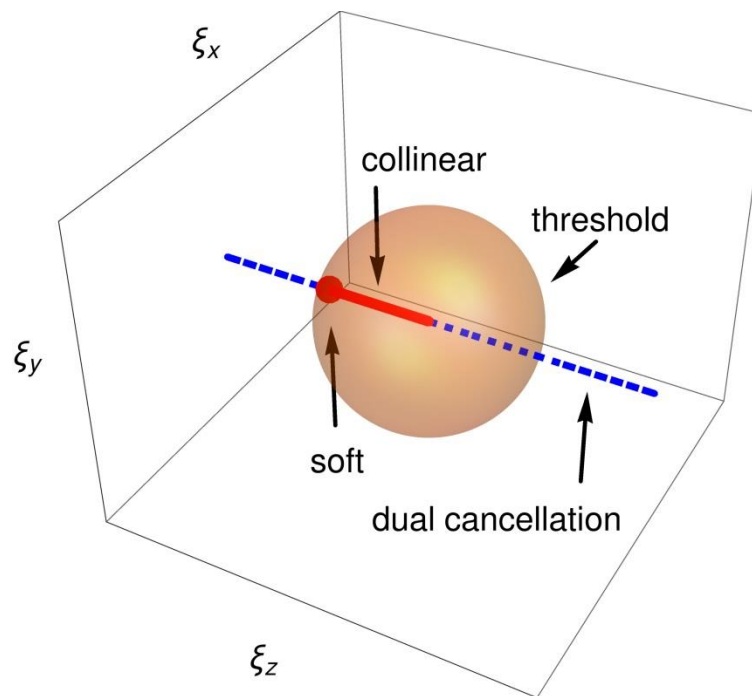

- Only **forward-backward** interference originate **threshold or IR poles**.
- **Forward-forward** cancel among dual contributions
- Threshold and IR singularities associated with finite regions (i.e. contained in a **compact region**)
- No threshold or IR singularity at large loop momentum

- This structure suggests how to perform real-virtual combination! Also, how to overcome threshold singularities (integrable but numerically unstable)

IR regularization in LTD

12

IR singularities

- From the previous plot, we define three contributions:

IR-divergent contributions ($\xi_0 < 1+w$)

- Originated in a **finite region** of the loop three-momentum
- All the IR singularities of the original loop integral



$$I^{\text{IR}} = I_1^{(s)} + I_1^{(c)} + I_2^{(c)} = \frac{c_\Gamma}{s_{12}} \left(\frac{-s_{12} - i0}{\mu^2} \right)^{-\epsilon} \times \left[\frac{1}{\epsilon^2} + \left(\ln(2) \ln(w) - \frac{\pi^2}{3} - 2\text{Li}_2 \left(-\frac{1}{w} \right) + v\pi \ln(2) \right) \right] + \mathcal{O}(\epsilon)$$

Forward integrals ($v < 1/2, \xi_0 > 1$)

- Free of IR/UV poles
- Integrable in 4-dimensions!



$$I^{(f)} = \sum_{i=1}^3 I_i^{(f)} = c_\Gamma \frac{1}{s_{12}} \left[\frac{\pi^2}{3} - v\pi \log(2) \right] + \mathcal{O}(\epsilon)$$

Backward integrals ($v > 1/2, \xi_0 > 1+w$)

- Free of IR/UV poles
- Integrable in 4-dimensions!



$$I^{(b)} = c_\Gamma \frac{1}{s_{12}} \left[2\text{Li}_2 \left(-\frac{1}{w} \right) - \ln(2) \ln(w) \right] + \mathcal{O}(\epsilon)$$

IR regularization in LTD

13

IR singularities

- Let's stop and make some remarks about the structure of these expressions:
 - ▣ Introduction of an **arbitrary cut** w to **include threshold regions**.
 - ▣ Forward and backward integrals can be performed in 4D because the sum does not contain poles.
 - ▣ Presence of extra Log's in (F) and (B) integrals. They are originated from the expansion of the measure in DREG, i.e.

$$\xi_r^{-1-2\epsilon} = -\frac{Q_S^{-2\epsilon}}{2\epsilon} \delta(\xi_r) + \left(\frac{1}{\xi_r}\right)_C - 2\epsilon \left(\frac{\ln(\xi_r)}{\xi_r}\right)_C + \mathcal{O}(\epsilon^2)$$

for both v and ξ (keep finite terms only). **It is possible to avoid them!**

- ▣ IR-poles isolated in I^{IR}  **IR divergences originated in compact region of the three-loop momentum!!!**

$$\underbrace{L^{(1)}(p_1, p_2, -p_3)}_{\substack{\text{Explicit poles} \\ \text{still present...}}} = I^{\text{IR}} + \underbrace{I^{(b)} + I^{(f)}}_{\substack{\text{Can be} \\ \text{done in 4D!}}$$

IR regularization in LTD

- Now, we must add **real** contributions. Suppose **one-loop** scalar scattering amplitude given by the triangle

Virtual

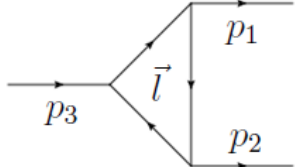

$$\begin{aligned}
 |\mathcal{M}^{(0)}(p_1, p_2; p_3)\rangle &= ig \\
 |\mathcal{M}^{(1)}(p_1, p_2; p_3)\rangle &= -ig^3 \Gamma^{(1)}(p_1, p_2, -p_3) \Rightarrow \text{Re} \langle \mathcal{M}^{(0)} | \mathcal{M}^{(1)} \rangle
 \end{aligned}$$

- 1->2 one-loop process**  **1->3 with unresolved extra-parton**
- Add scalar tree-level contributions with one extra-particle; consider interference terms:

Real

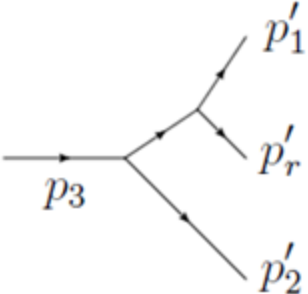

$$|\mathcal{M}_{ir}^{(0)}(p'_1, p'_2, p'_r; p_3)\rangle = -ig^2/s'_{ir} \Rightarrow \text{Re} \langle \mathcal{M}_{ir}^{(0)} | \mathcal{M}_{jr}^{(0)} \rangle = \frac{g^4}{s'_{ir} s'_{jr}}$$

Opposite sign!

- Generate 1->3 kinematics starting from 1->2 configuration plus the loop three-momentum \vec{l} !!!

IR regularization in LTD

- **Mapping of momenta:** generate **1->3 real** emission kinematics (**3 external on-shell momenta**) starting from the variables available in the dual description of **1->2 virtual** contributions (**2 external on-shell momenta and 1 free three-momentum**)

$$\begin{aligned}
 p_r'^{\mu} &= q_1^{\mu} & p_1'^{\mu} &= -q_3^{\mu} + \alpha_1 p_2^{\mu} = p_1^{\mu} - q_1^{\mu} + \alpha_1 p_2^{\mu} \\
 p_2'^{\mu} &= (1 - \alpha_1) p_2^{\mu} & \alpha_1 &= \frac{q_3^2}{2q_3 \cdot p_2} & q_1 &= \ell + p_1
 \end{aligned}
 \quad \longrightarrow \quad
 \begin{aligned}
 p_3 &\rightarrow p_1 + p_2 \Rightarrow p_3 \rightarrow p_1' + p_2' + p_r' \\
 & & & & & + \vec{l}
 \end{aligned}$$

- Mapping optimized for $y'_{1r} < y'_{2r}$; analogous expression in the complement
- Express interference terms using this map  **Real and virtual contributions are described using the same integration variables!**

Only required for I_1 and I_2 (I_3 singularities cancel among dual terms)

$$\begin{aligned}
 \tilde{\sigma}_{i,R} &= \sigma_0^{-1} 2\text{Re} \int d\Phi_{1 \rightarrow 3} \langle \mathcal{M}_{2r}^{(0)} | \mathcal{M}_{1r}^{(0)} \rangle \theta(y'_{jr} - y'_{ir}) \\
 \tilde{\sigma}_{i,V} &= \sigma_0^{-1} 2\text{Re} \int d\Phi_{1 \rightarrow 2} \langle \mathcal{M}^{(0)} | \mathcal{M}_i^{(1)} \rangle \theta(y'_{jr} - y'_{ir})
 \end{aligned}
 \quad \longrightarrow \quad
 \begin{aligned}
 \tilde{\sigma}_1 &= \tilde{\sigma}_{1,V} + \tilde{\sigma}_{1,R} = \mathcal{O}(\epsilon) \\
 \tilde{\sigma}_2 &= \tilde{\sigma}_{2,V} + \tilde{\sigma}_{2,R} = -c_{\Gamma} \frac{g^2}{s_{12}} \frac{\pi^2}{6} + \mathcal{O}(\epsilon)
 \end{aligned}$$

IR regularization in LTD

□ **Mapping of momenta: crucial for the cancellation of IR singularities!**

- ▣ It relates IR singular regions in real and dual contributions. A precise definition is requested to achieve exact cancellation. *Extensible for n-particle final states!*
- ▣ **Allows to recover the finite result by taking the limit $\epsilon \rightarrow 0$ at integrand level!**

$$\tilde{\sigma}_1 = \int_0^1 dv_1 \int_0^1 d\xi_1 \xi_1^{-1-2\epsilon} v_1^{-1-\epsilon} \left[\xi_1 v_1 (1-v_1)^{-\epsilon} \mathcal{R}_1(\xi_1, v_1) \left(I_1^{\text{dual}} + |\mathcal{M}_3^{(0)}|^2 \Big|_{M_1} \mathcal{J}_{M_1} \right) \right]$$

$$\tilde{\sigma}_2 = \int_0^1 dv_2 \int_0^1 d\xi_2 \xi_2^{-1-2\epsilon} (1-v_2)^{-1-\epsilon} \left[\xi_2 (1-v_2) v_2^{-\epsilon} \mathcal{R}_2(\xi_2, v_2) \left(I_2^{\text{dual}} + |\mathcal{M}_3^{(0)}|^2 \Big|_{M_2} \mathcal{J}_{M_2} \right) \right]$$

Implemented directly in 4D!

□ **Remainders of the dual integrals: only partial use of dual integrands to cancel real IR singularities; define backward and forward integrals!**

- ▣ Cross-cancellation of collinear and UV singularities among dual integrands.
- ▣ Unify the coordinate system to avoid the introduction of extra Log's terms and **take the limit $\epsilon \rightarrow 0$ at integrand level!**

$$\begin{aligned} (\xi_1, v_1) &\rightarrow \left(\sqrt{\xi^2 + 2\xi(1-2v) + 1}, \frac{1}{2} \left(1 - \frac{1 + \xi(1-2v)}{\sqrt{\xi^2 + 2\xi(1-2v) + 1}} \right) \right) \\ (\xi_2, v_2) &\rightarrow (\xi, v), \quad (\xi_3, v_3) \rightarrow (\xi, v) \end{aligned}$$

UV renormalization in LTD

17

UV singularities

- Reference example: two-point function with massless propagators

$$L^{(1)}(p, -p) = \int_{\ell} \prod_{i=1}^2 G_F(q_i) = \frac{c_{\Gamma}}{\epsilon(1-2\epsilon)} \left(-\frac{p^2}{\mu^2} - i0 \right)^{-\epsilon} = \sum_{i=1}^2 I_i$$



$$I_1 = - \int_{\ell} \frac{\tilde{\delta}(q_1)}{-2q_1 \cdot p + p^2 + i0}$$

$$I_2 = - \int_{\ell} \frac{\tilde{\delta}(q_2)}{2q_2 \cdot p + p^2 - i0}$$

To regularize
threshold
singularity

- In this case, the integration regions of dual integrals are two energy-displaced forward light-cones. This integral contains UV poles only
- **OBJECTIVE:** Define a *UV-regularized* loop integral by adding unintegrated UV counter-terms, and find a purely 4-dimensional representation of the loop integral

UV renormalization in LTD

18

UV counter-term

- Divergences arise from the high-energy region (UV poles) and can be cancelled with a suitable renormalization counter-term. For the scalar case, we use

$$I_{\text{UV}}^{\text{cnt}} = \int_{\ell} \frac{1}{(q_{\text{UV}}^2 - \mu_{\text{UV}}^2 + i0)^2}$$

Becker, Reuschle, Weinzierl,
JHEP 12 (2010) 013

- Dual representation (**new: double poles in the loop energy** Bierenbaum *et al.* JHEP 03 (2013) 025)

$$I_{\text{UV}}^{\text{cnt}} = \int_{\ell} \frac{\tilde{\delta}(q_{\text{UV}})}{2 \left(q_{\text{UV},0}^{(+)} \right)^2}$$

$$q_{\text{UV},0}^{(+)} = \sqrt{\mathbf{q}_{\text{UV}}^2 + \mu_{\text{UV}}^2 - i0}$$

- Loop integration for loop energies larger than μ_{UV}

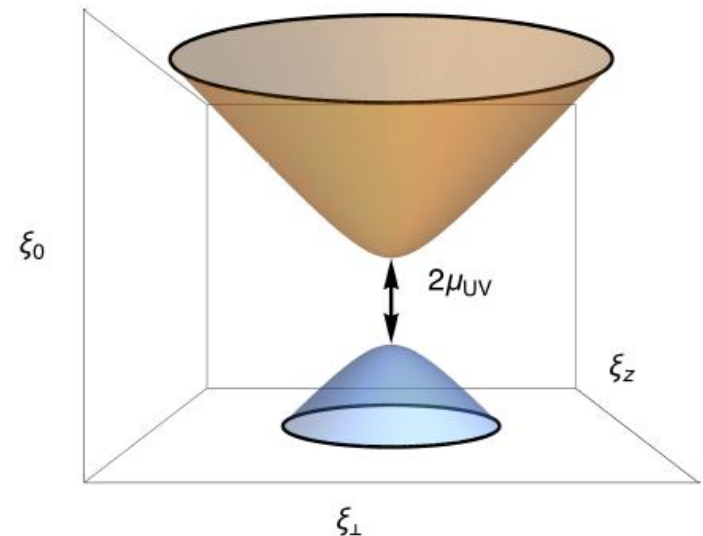

UV renormalization in LTD

19

Cancellation of UV singularities

- Using the standard parametrization we define

**Regularized
two-point
function**

$$L^{(1)}(p, -p) - I_{\text{UV}}^{\text{cnt}} = c_{\Gamma} \left[-\log \left(-\frac{p^2}{\mu_{\text{UV}}^2} - i0 \right) + 2 \right] + \mathcal{O}(\epsilon)$$

- Since it is finite, we can express the regularized two-point function in terms of 4-dimensional quantities (i.e. no epsilon required!!)
- **Physical interpretation of renormalization scale:** Separation between on-shell hyperboloids in UV-counterterm is $2\mu_{\text{UV}}$. To avoid intersections with forward light-cones associated with I_1 and I_2 , the renormalization scale has to be larger or of the order of the hard scale. So, the minimal choice that fulfills this agrees with the standard choice (i.e. $\frac{1}{2}$ of the hard scale).

Conclusions

20

- Introduced new method based on the Loop-Tree Duality (LTD) that allows to treat **virtual** and **real** contributions in the **same way**: simultaneous implementation and **no need of IR subtraction**
- Physical interpretation of **IR/UV singularities** in loop integrals
- **Presented proof of concept of LTD with reference examples**

- **Perspectives:**
 - Apply the technique to compute full multileg NLO physical observables
 - Extend the procedure to higher orders: NNLO and beyond

Thanks!!!