

Development of gaseous PMT with bialkali photocathode

T. Sumiyoshi (Tokyo metropolitan Univ.)

H. Sugiyama, T. Okada (Hamamatsu Photonics)

F. Tokanai (Yamagata Univ.)



RD51 Academia-Industry Matching Event
Special Workshop on Photon Detection with MPGDs
10-11 June 2015 @ CERN
A. Ochi (Kobe Univ.) presents instead of authors

Advantage of gaseous PMT

Sensor type	Sensitivity	Position Resolution	Timing Resolution	Uniformity	Price	Magnetic Field	Effective Area
Vacuum PMT	⊙	△	⊙	△	○	△	○
CCD / CMOS	△	⊙	✕	⊙	△	⊙	✕
Gaseous PMT	○	○	○	○	⊙	⊙	⊙

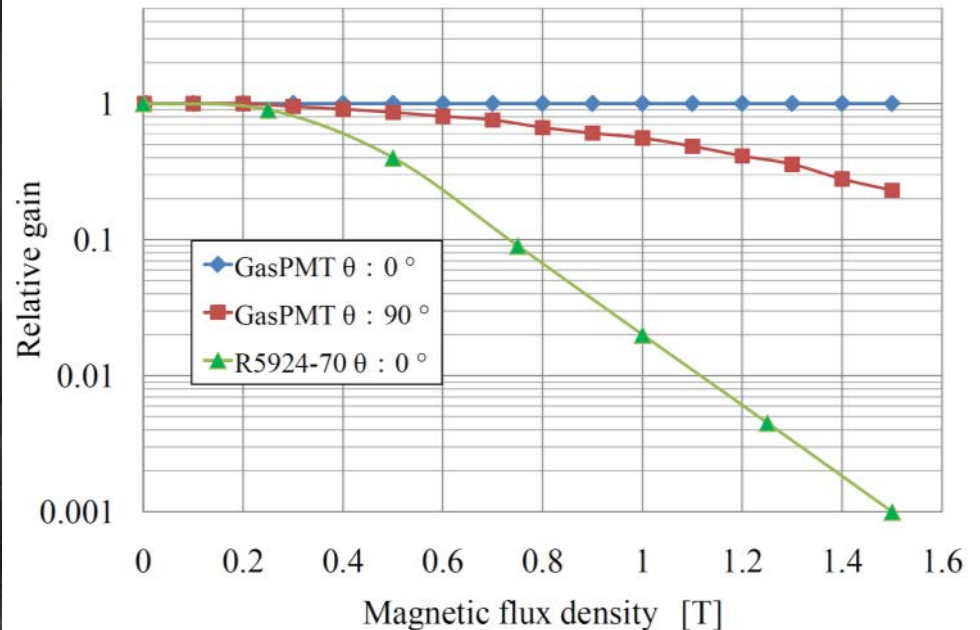
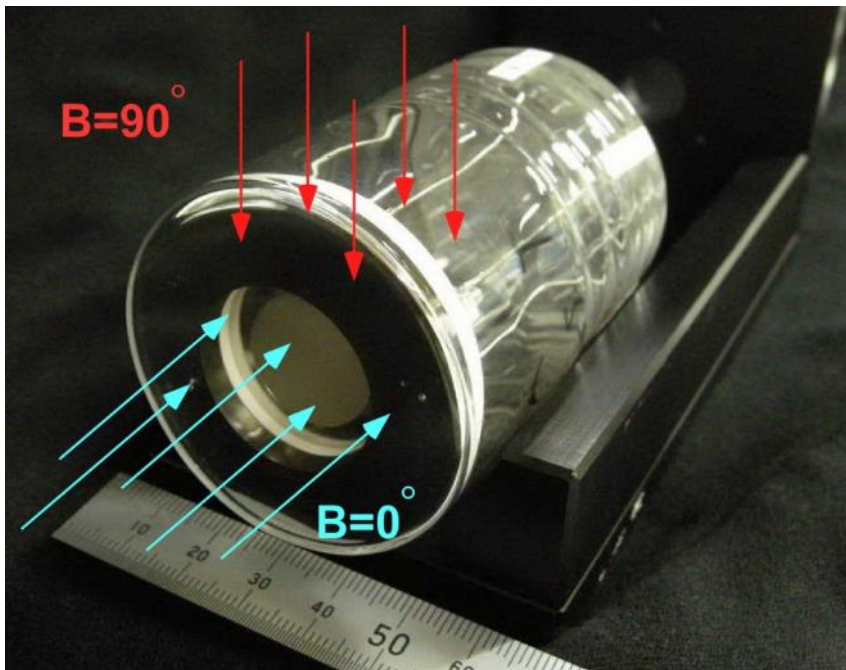

T. Sumiyoshi et al., NIMA, 639 (2011) 121.

Quantum efficiency in gas

Bi-alkali Photocathode in Ar(90%) + CH₄(10%) 0.9 atm

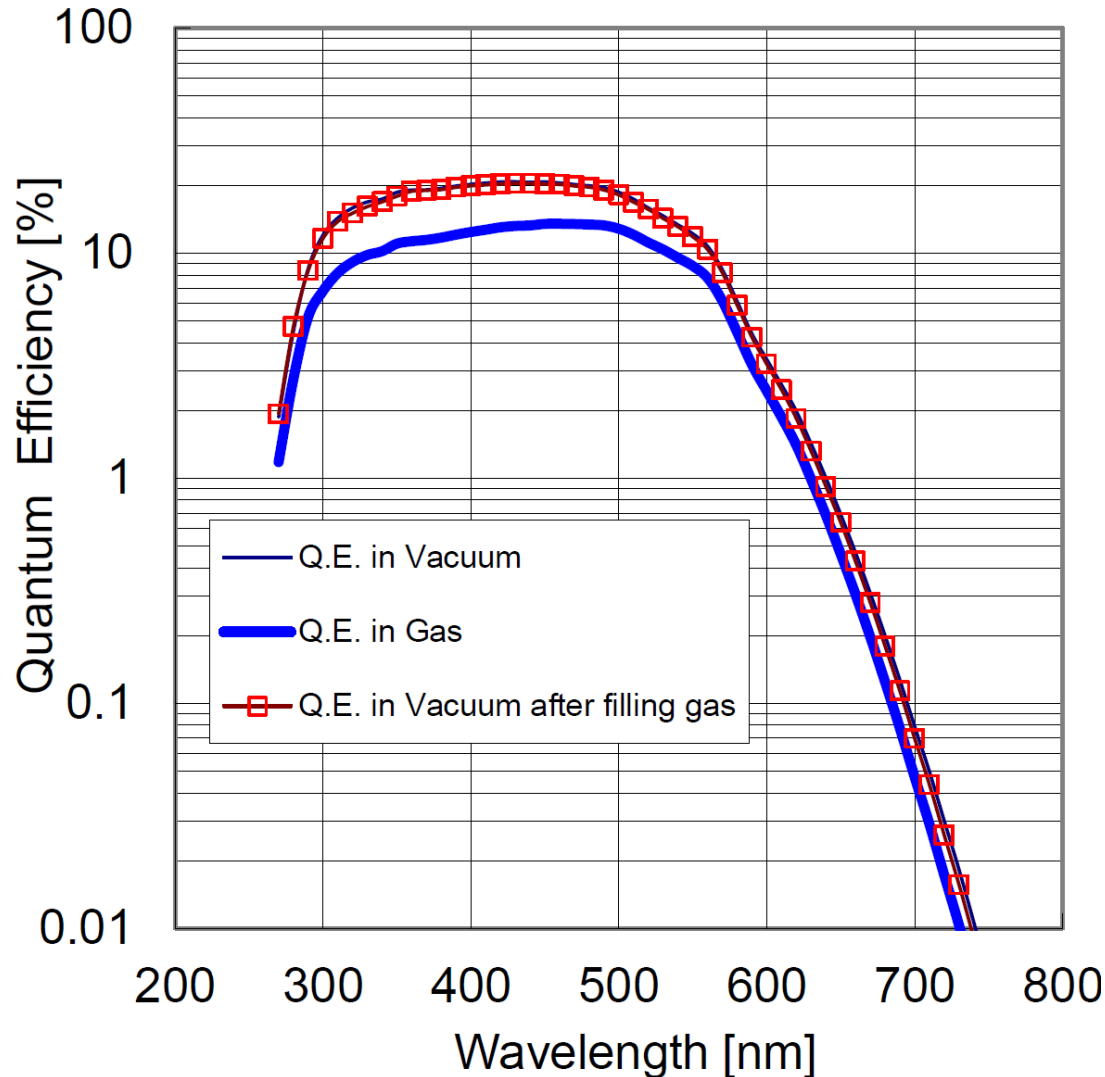

QE in vacuum ~ 20%

QE in the gas ~ 12%



After evacuation QE recovered to ~20%.

F. Tokanai et al., NIMA, 610 (2009) 164.

Photoelectron-collection efficiency from bialkali photocathode in each gas

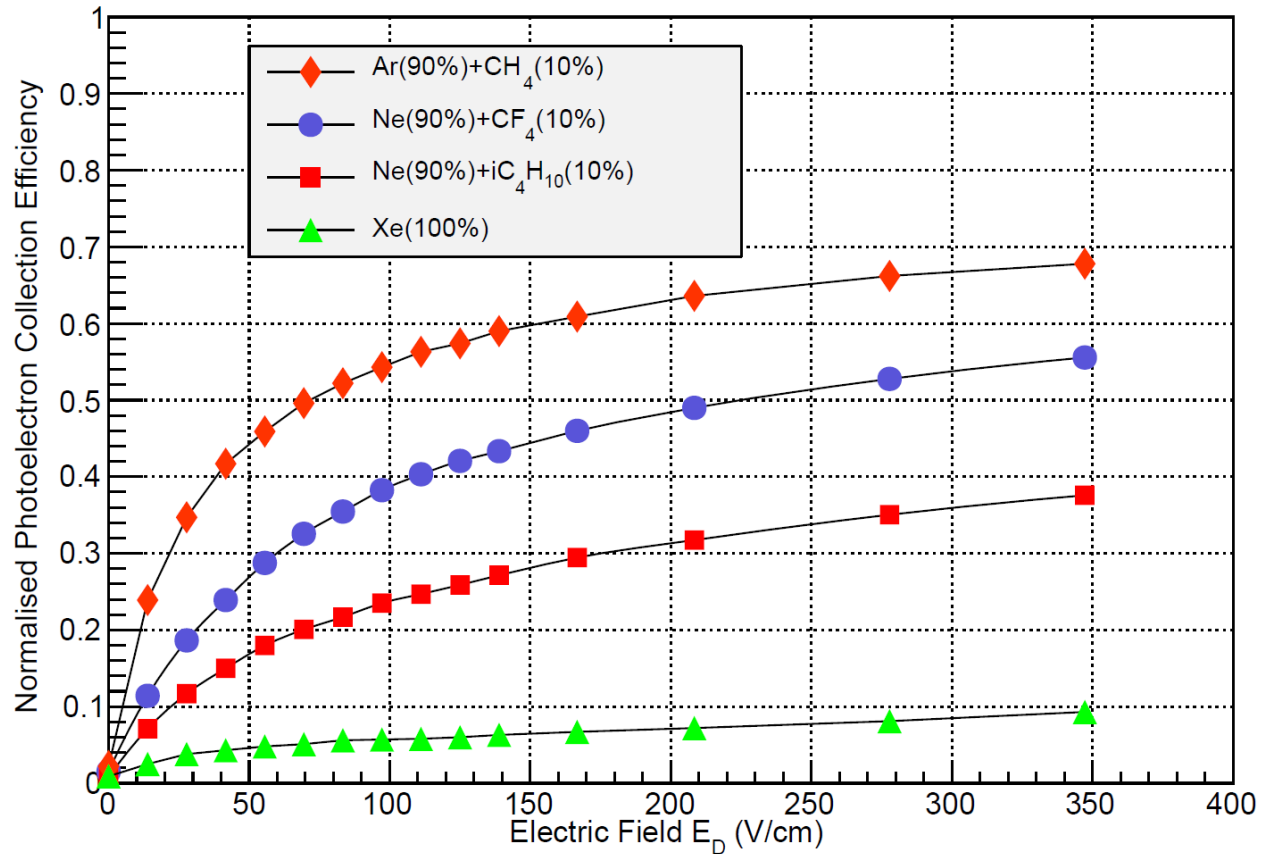
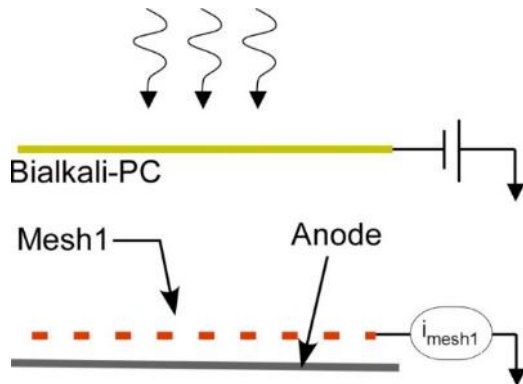
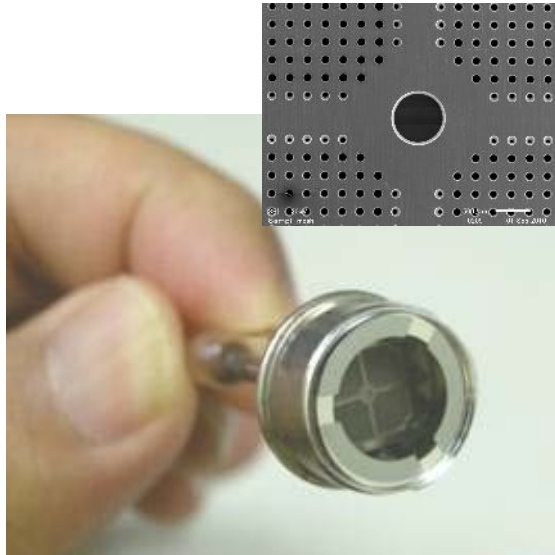

Photoelectron-collection efficiency as a function of the electric field.

Ar + CH₄

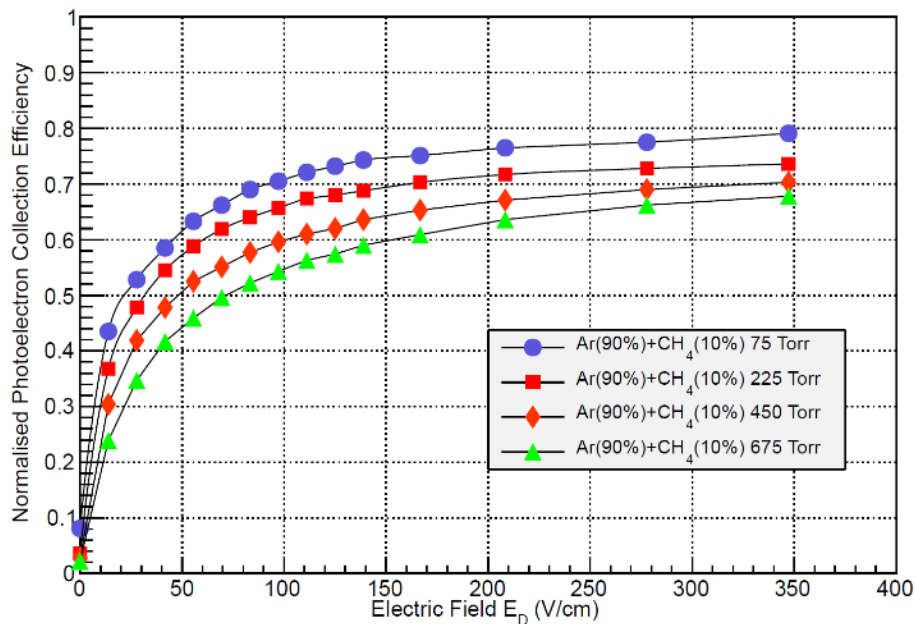

Ne + CF₄

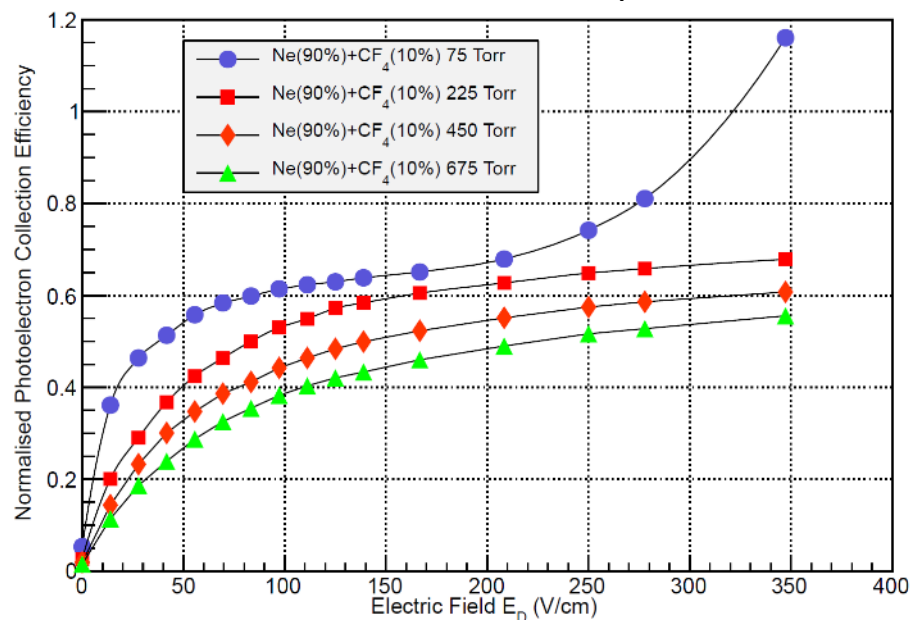

The photoelectron collection efficiency increases with decreasing pressure.

Long term stability of the quantum efficiency

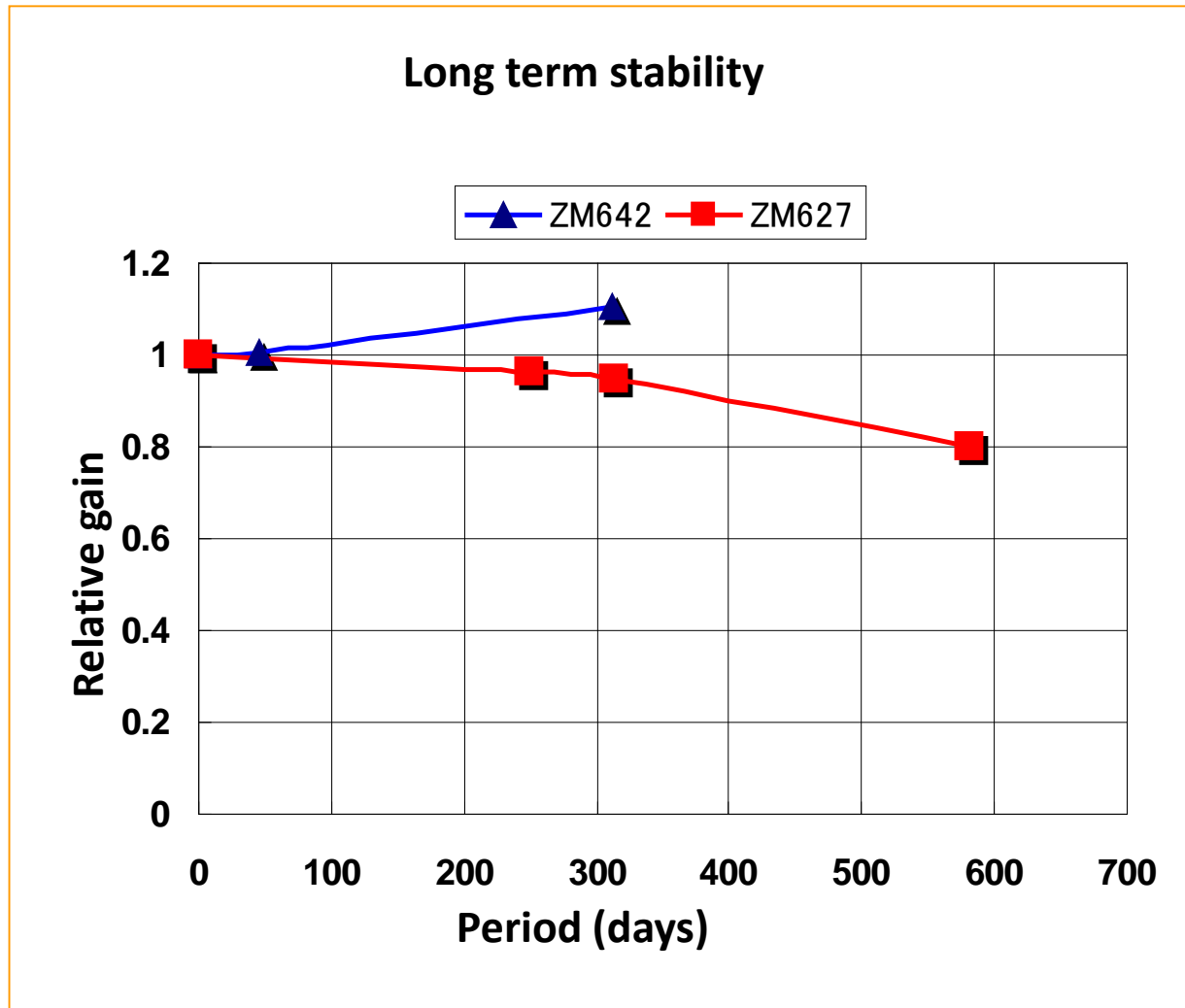

QE maintains almost the same value after 581 days in gas.

Bi-alkali photocathode with GEM



	glass CP	Kapton-GEM
PC Sensitivity ($\mu\text{A} / \text{Im}$)	56.3	1.5

Sensitivity of the photocathode for Kapton-GEM dropped to less than 3% of that for CP.

Material of GEM made chemical reaction with alkali metals used for the photocathode and we could not make a normal photocathode.

Materials used for Gaseous PMT

Effects of alkali vapors (K and Cs) on kapton were tested using a small ampoule.



Upon an evaporation of K the colour of kapton changed to grey and immediately after the evaporation of Cs it became dark brown.

This indicates that bi-alkali metals deteriorate the quality of kapton.

Kapton GEMs could not be used in a gaseous PMT for a long term operation.

We started to develop a new **MPGD** with **other material** that allow the problem-free production of bi-alkali photocathodes.



Kapton with K vapor



Kapton with K-Cs vapor

Suggested by Peskov in IEEE 1999.

New MPGD for Gas PMT

■ Why need "New MPGD" ?

➤ Limitation of materials.

required for the production of photocathodes.

➤ Limitation of the ion feedback

required for the maximum gain and the lifetime of the photocathode.

Hole-type MPGD

by MicroBlasting(MB) technique

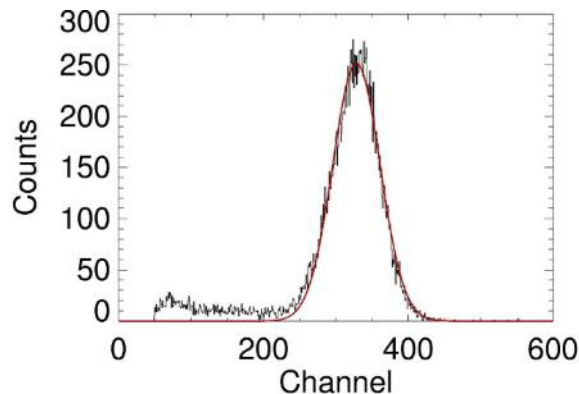
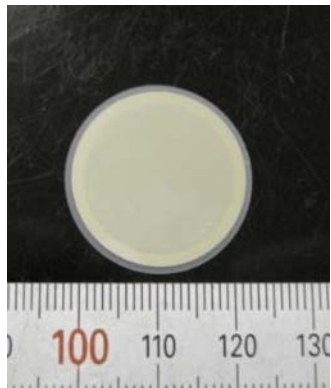

X-ray@6keV
•Gain > 10^3
•E-Res = 19%

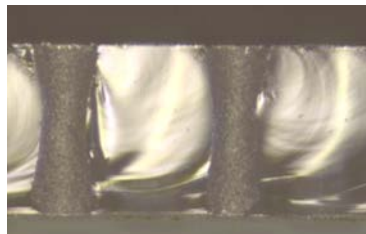

Mesh-type MPGD

by chemically etched alloy plate and inorganic spacers .

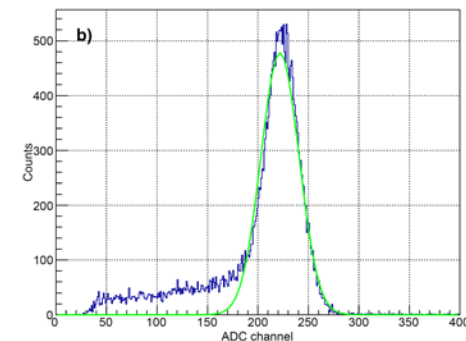
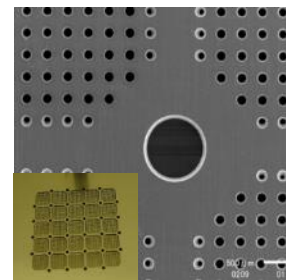

X-ray@6keV
•Gain > 10^3
•E-Res = 18%

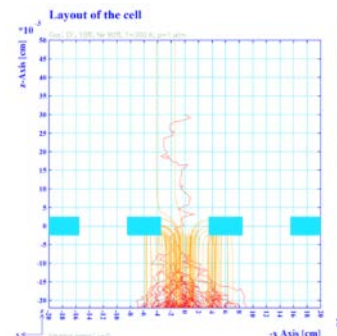

Gaseous PMT with MPGD

(appropriate for the production of bialkali photocathode)

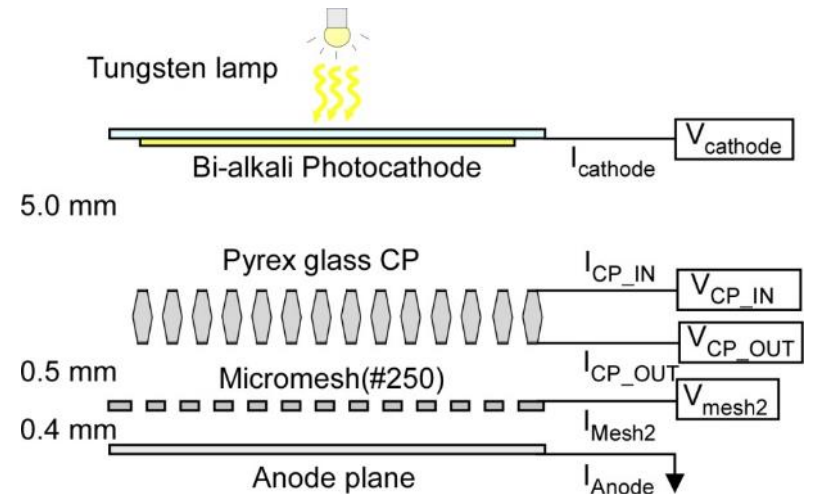
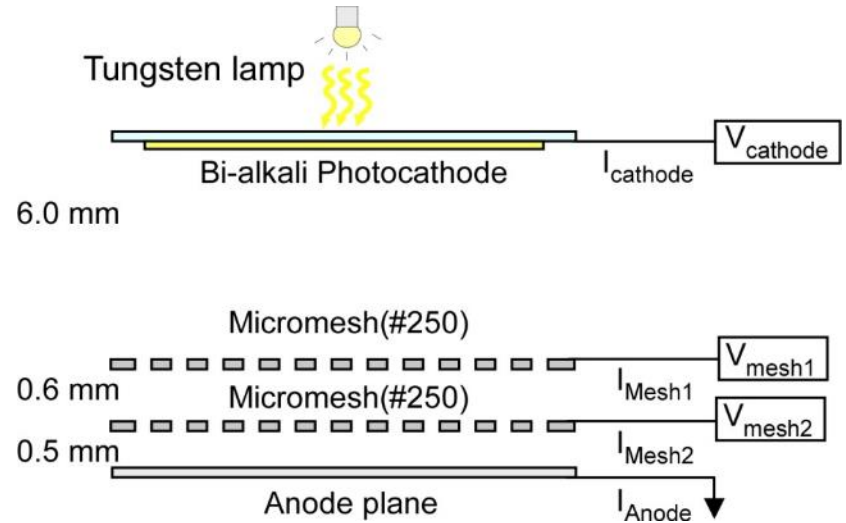
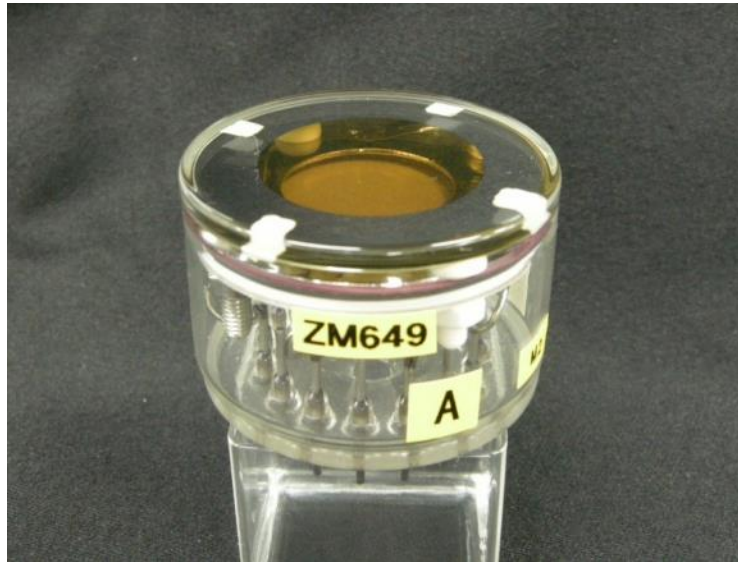

A Pyrex CP gas detector for the gaseous PMT

By employing a **novel technique**, we successfully produced a **new CP** using **Pyrex glass**.

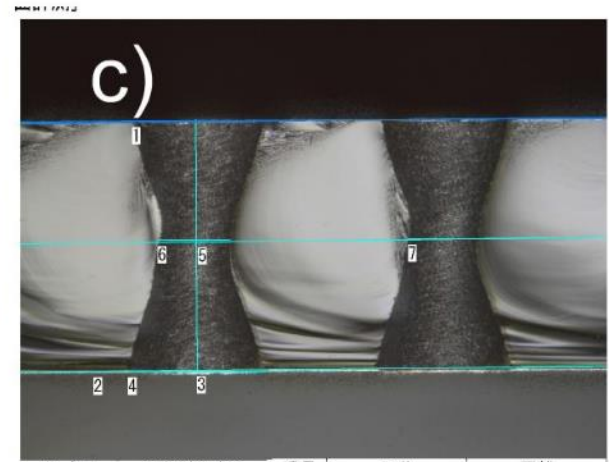
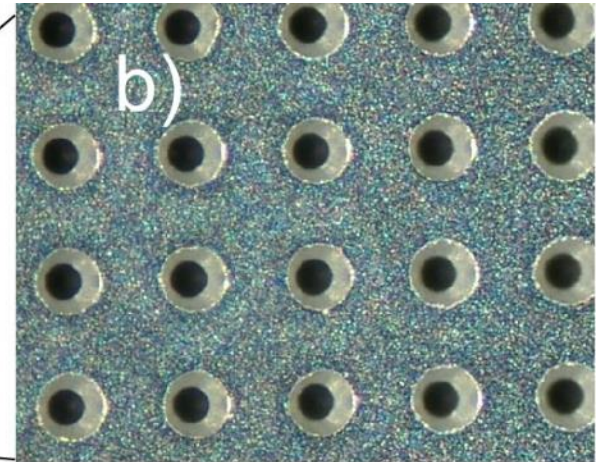
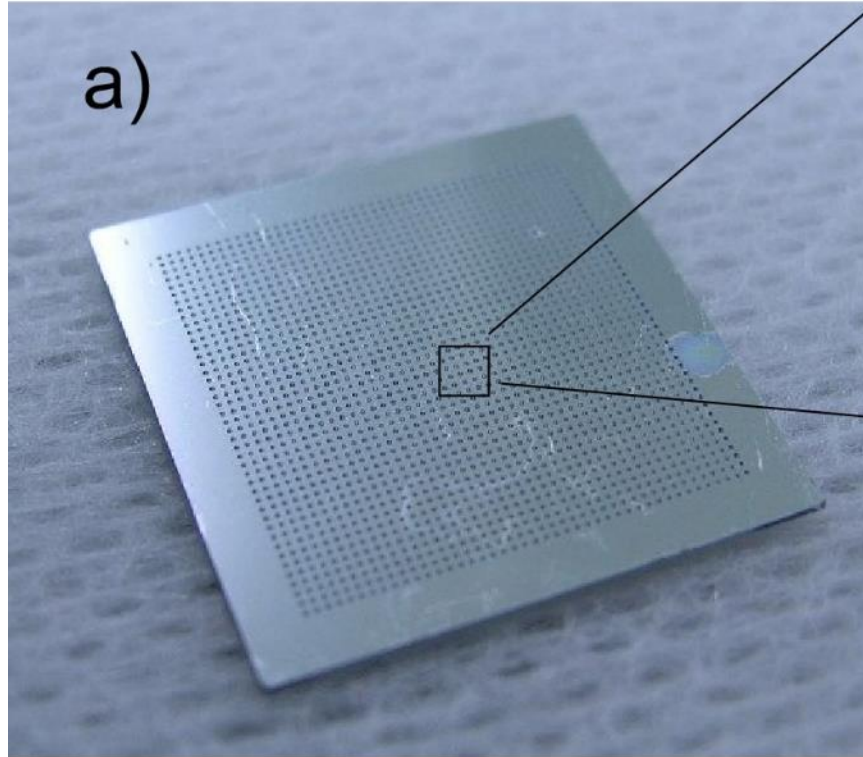

thickness	300 μm
diameter at entrance	160 μm
diameter at center	124 μm
pitch	300 μm

Each hole has a double-conical shape.

Pyrex glass CP : Performance test using X-rays

Basic performance tests were carried out by irradiating 5.9 keV X-rays.

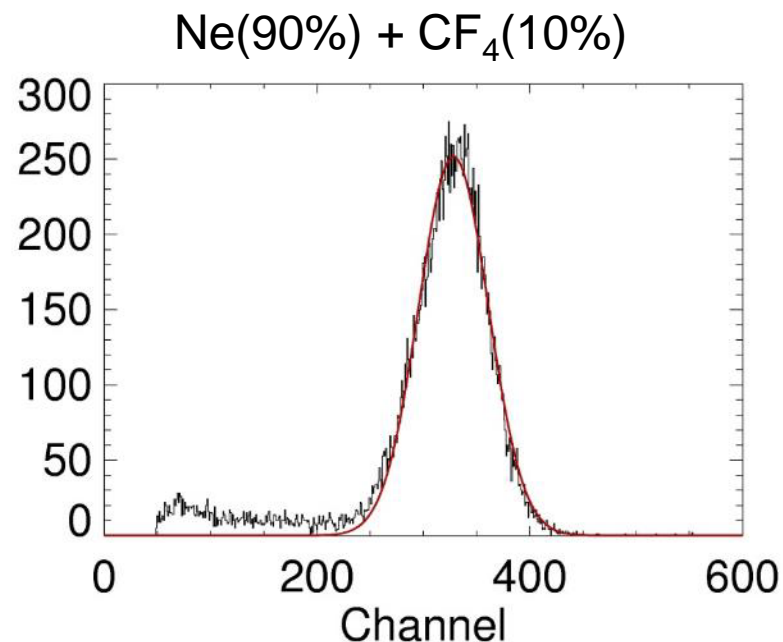
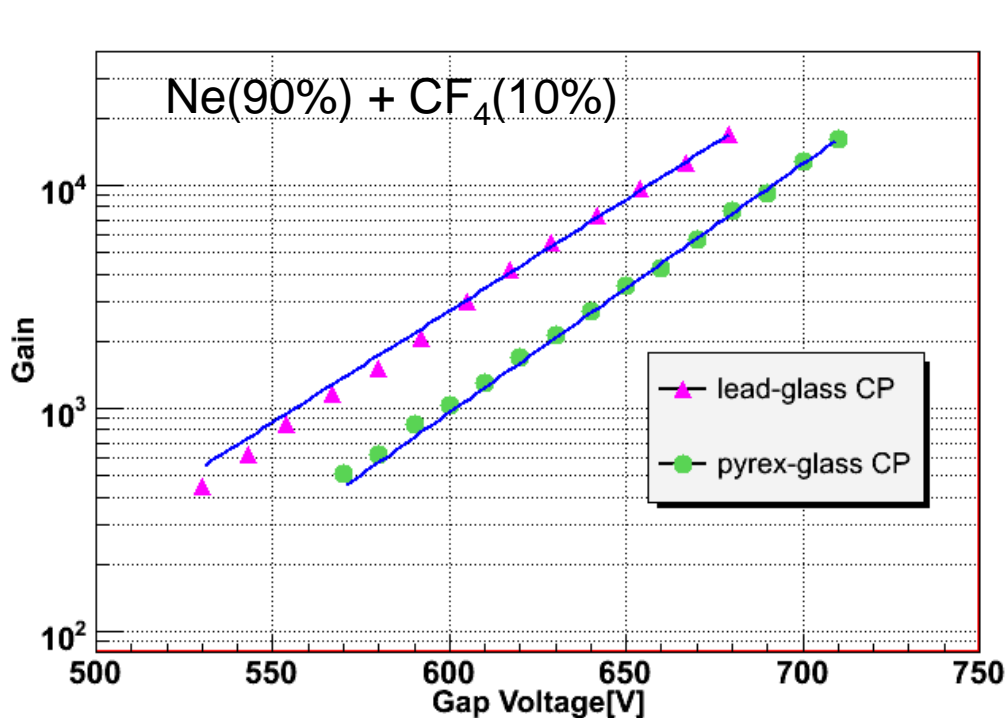

- ✓ Gains of up to 10^4 are safely achieved using a CP.
- ✓ Energy resolution is 23% , which agrees with the result obtained by the lead glass CP.
- ✓ Pyrex glass CP can act as a hole-type MPGD.

Development of GasPMT with bi-alkali photocathode

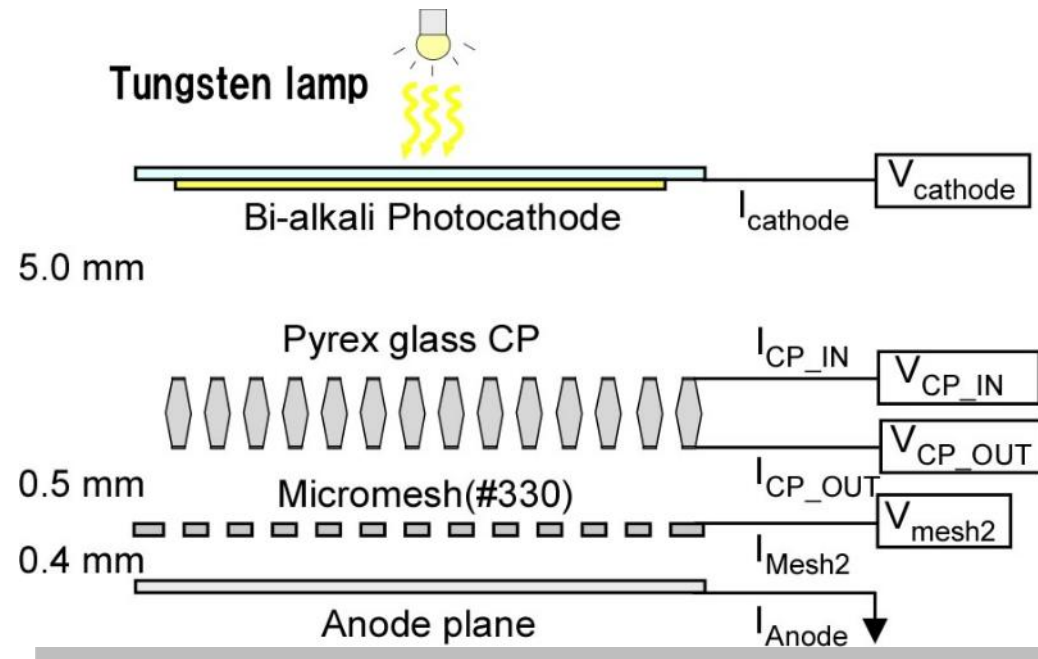

> No change in the resistance of CP after the evaporation of bi-alkali metals.

> The measured QE is almost same as that obtained by the tandem Micromegas structure.

Gain of the GasPMT with Pyrex glass CP

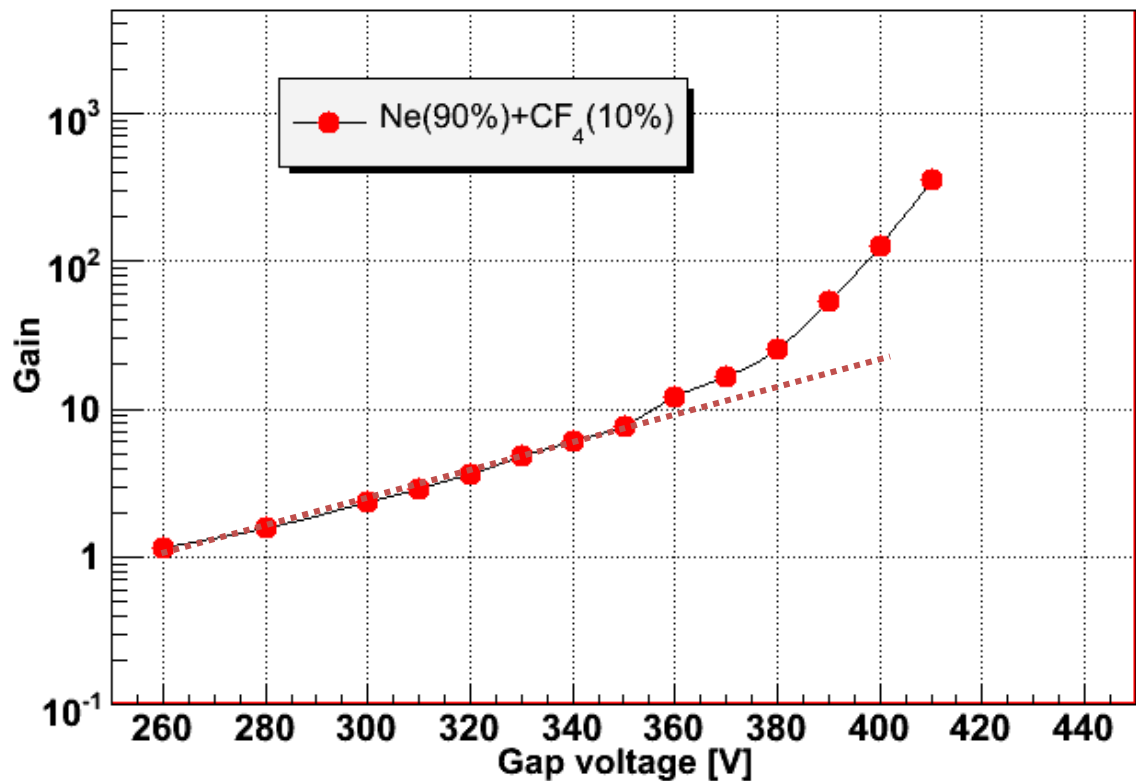

Clear deviation from exponential line was observed at $G \sim 10$.

As reported by Mörmann et al (2003)

It is inferred that the ion/photon feedback occur during this operation.

Gaseous PMT with Mesh –type MPGD

J. Va'vra and T. Sumiyoshi, NIMA, 535,(2004),334
 K. Matsumoto, et al., Phys. Proc. 37 (2012) 499.
 F. Tokanai et al., NIMA, 766,(2014),176

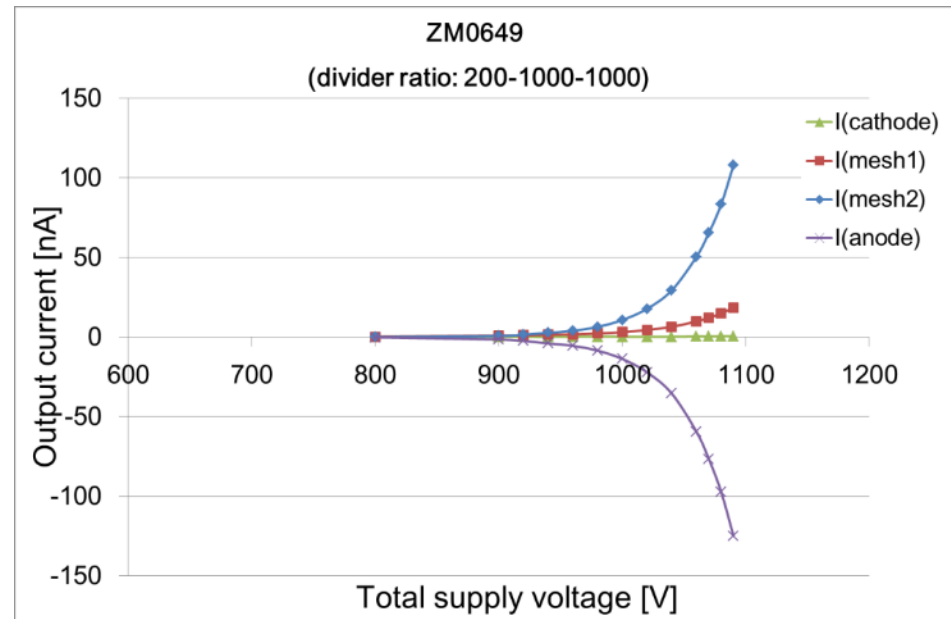
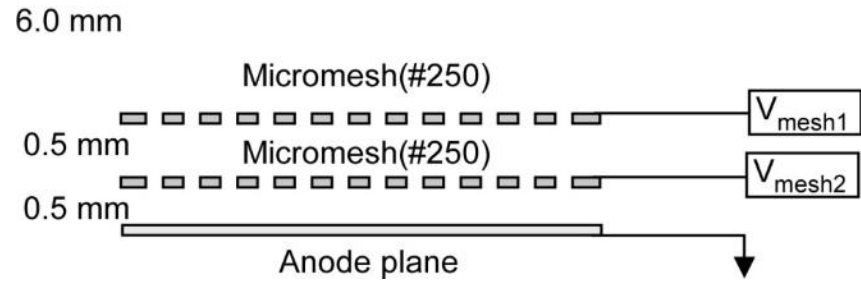
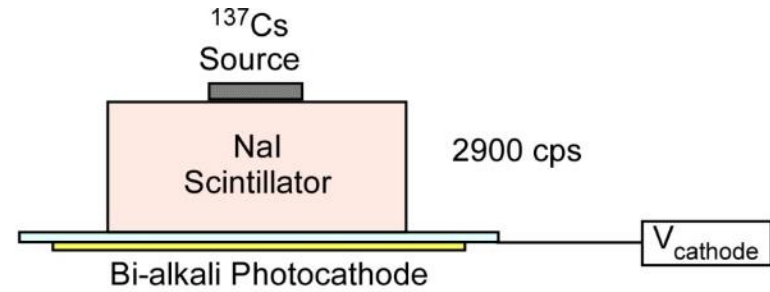

Gas multiplications with a tandem Micromegas.

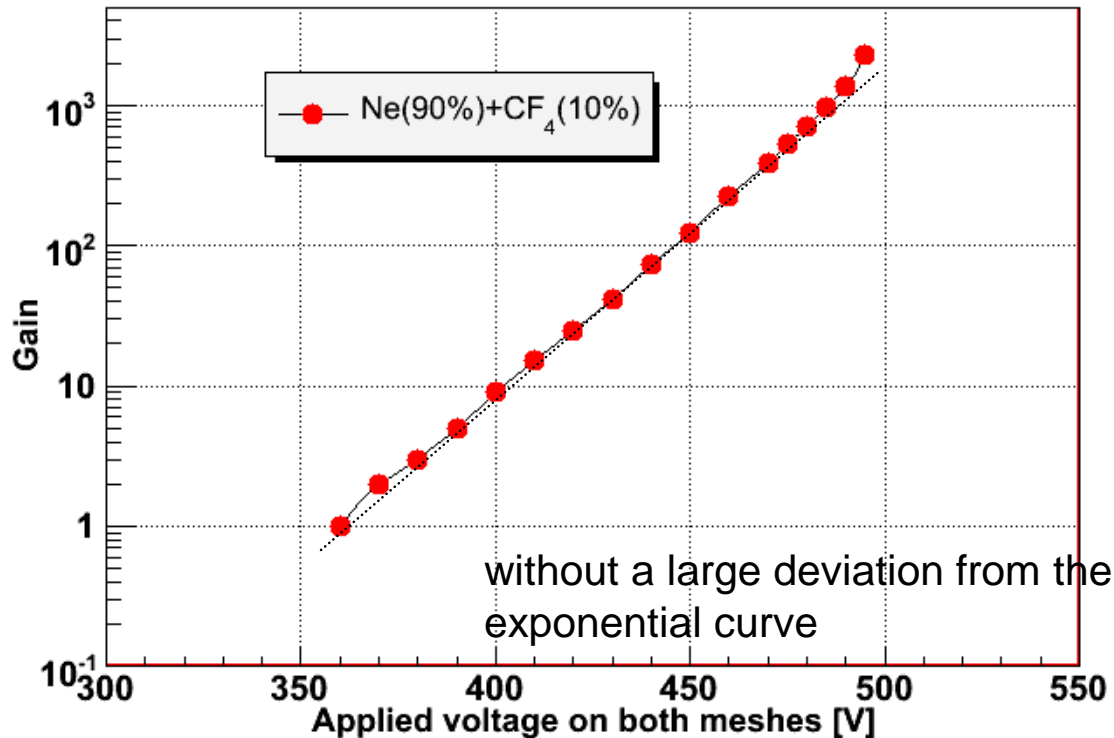

We found a gain rise in the Ne gas mixture at around 2×10^3 .
→ This phenomenon is also observed in the Ar gas mixture.

Tandem Micromegas structure may not be suitable for a single photon detection.

Long-time operation of the gaseous PMT

ZM0649 NaI+Cs137

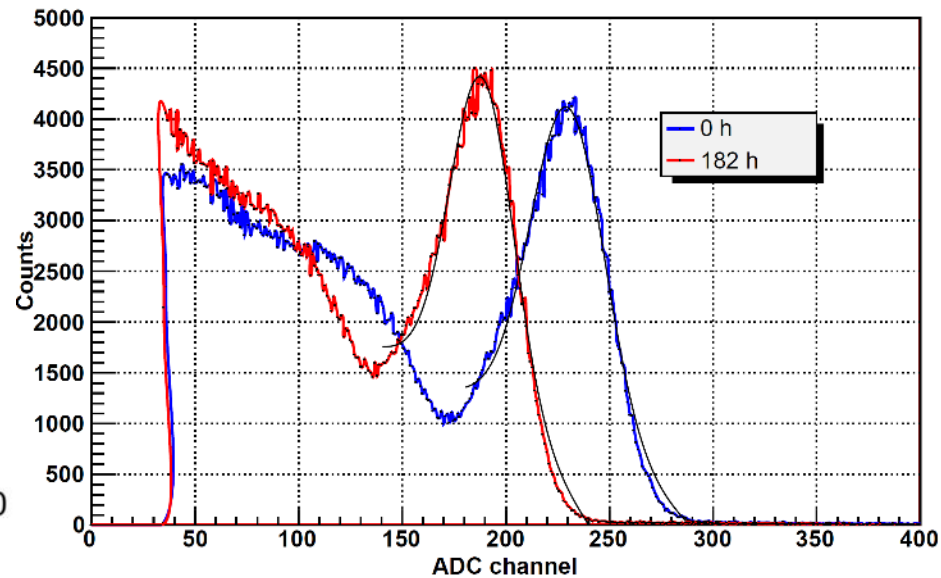
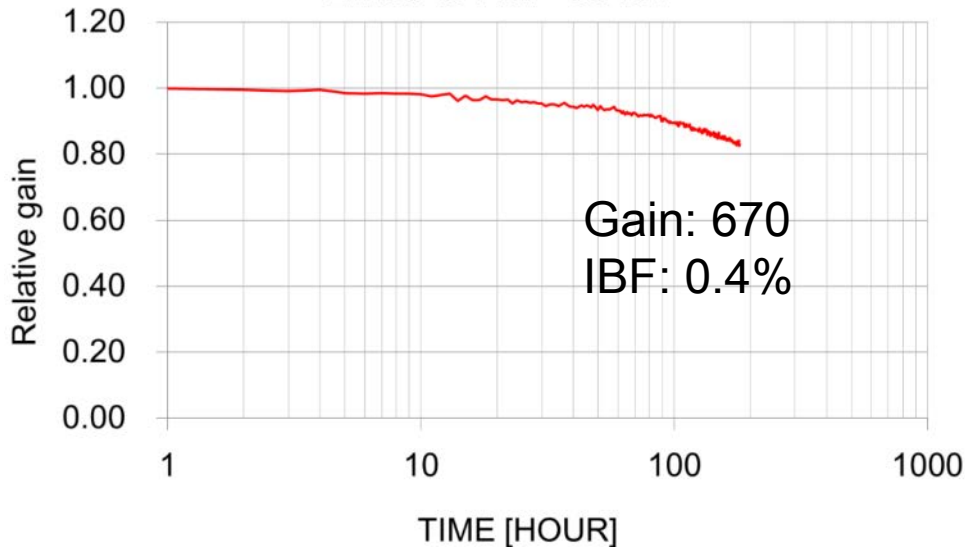

✓ After **182 h** of operation, **20% decrease** of the signal output was observed.

✓ The charge accumulated on the bialkali photocathode was estimated to be **0.4 $\mu\text{C}/\text{mm}^2$** , taking into account the gain of 640, the ion feedback of 4% and the event rate of 2940 counts/s for the gaseous PMT.

■ The peak channel was also shifted to lower channel (about **20%**) than that obtained at 0 h.

■ The energy resolution were **18.2%** (FWHM) and **19.0%** (FWHM), respectively, for 0 h and 180 h after operation.

Long-time operation of the gaseous PMT

Ne (90%) + CF₄ (10%) at 0.9 atm

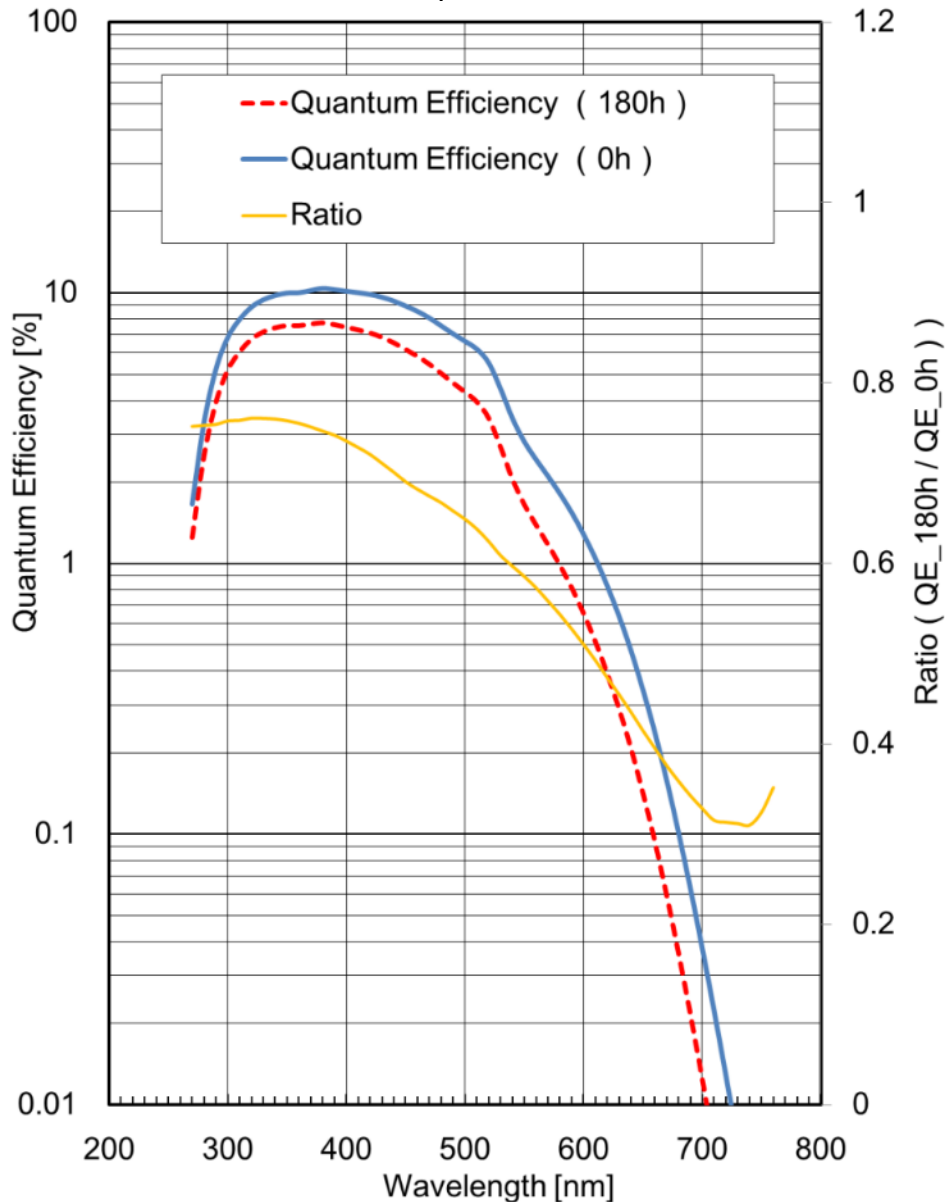

- The QE was degraded in the wavelength range from 270 nm to 770 nm after the 182 h operation.
- The QEs at a wavelength of 380 nm were 10.4% and 7.8% at 0 h and after 182 h of operation, respectively.
- The ratio of the QEs before and after 182 h of operation decreased with increasing wavelength.
- This result indicates that the accumulated ions (CF₄⁺) may affect the electron affinity of the bialkali material of the photocathode.

Newly developed gaseous PMT with mesh-type MPGD

Flat-pixel gaseous PMT

Photocathode

Mesh1

Mesh2

Anode

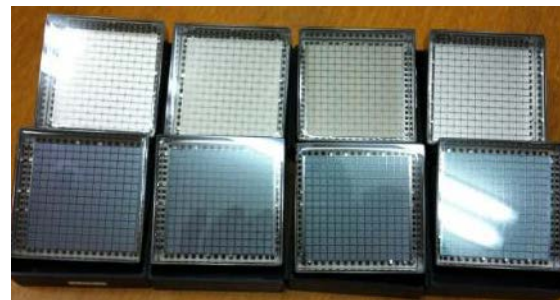
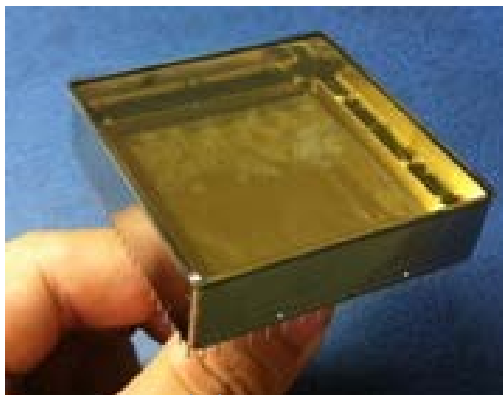
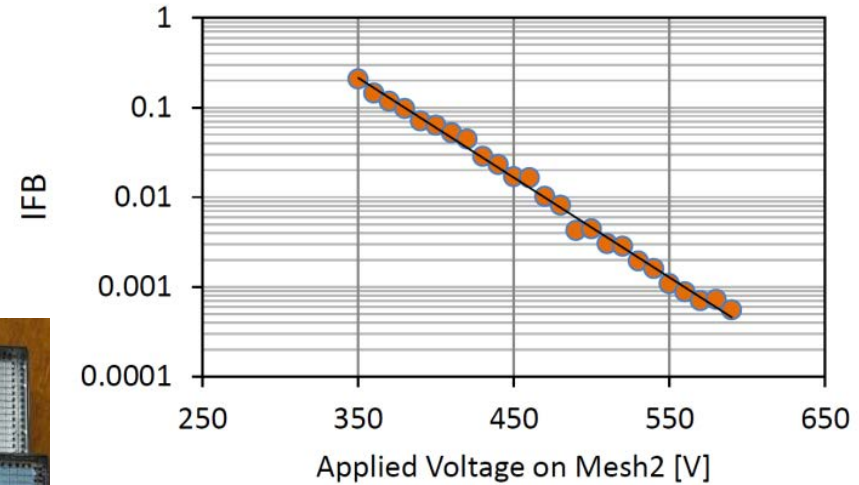
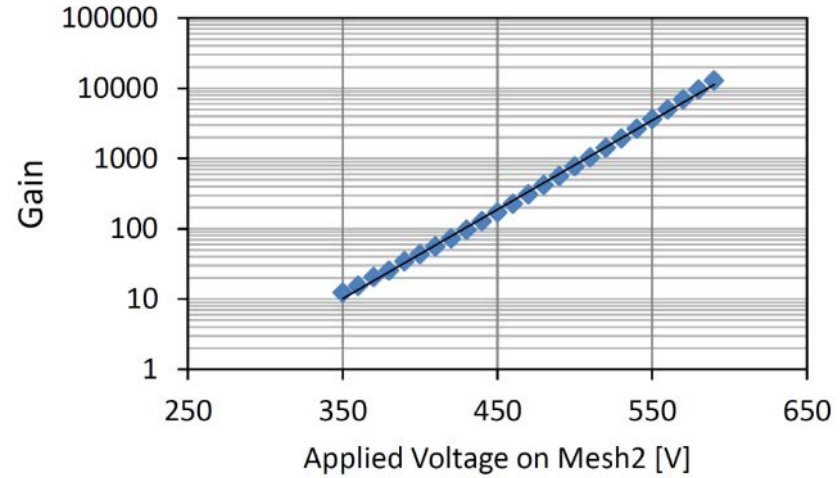
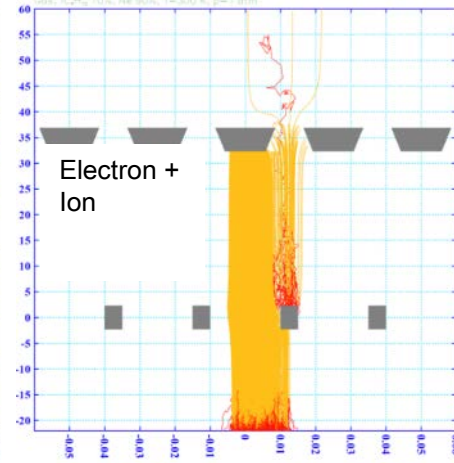
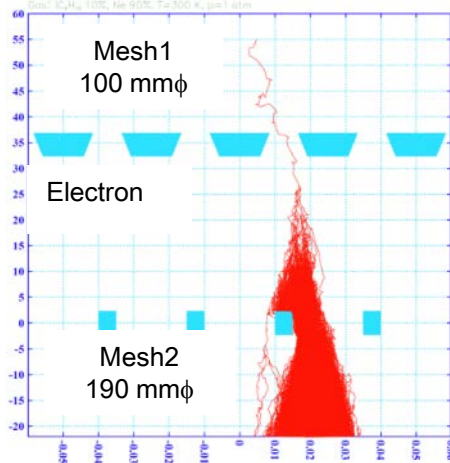
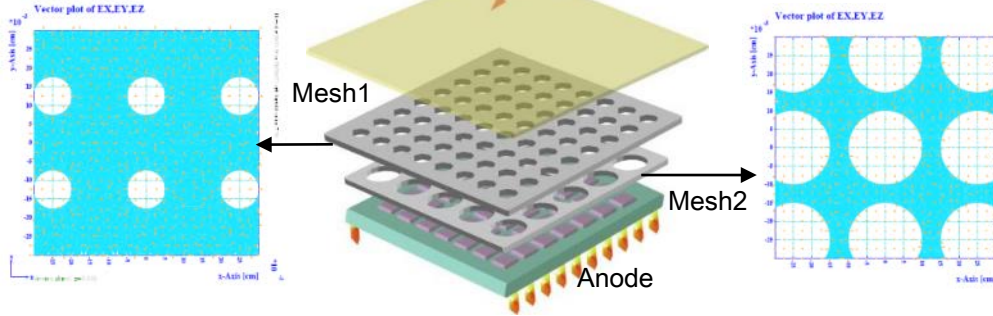

Newly developed Gas PMT

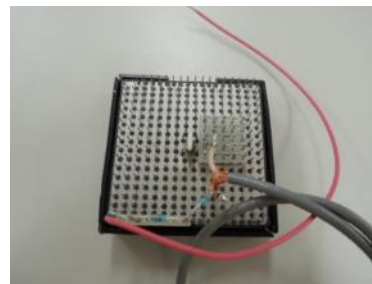
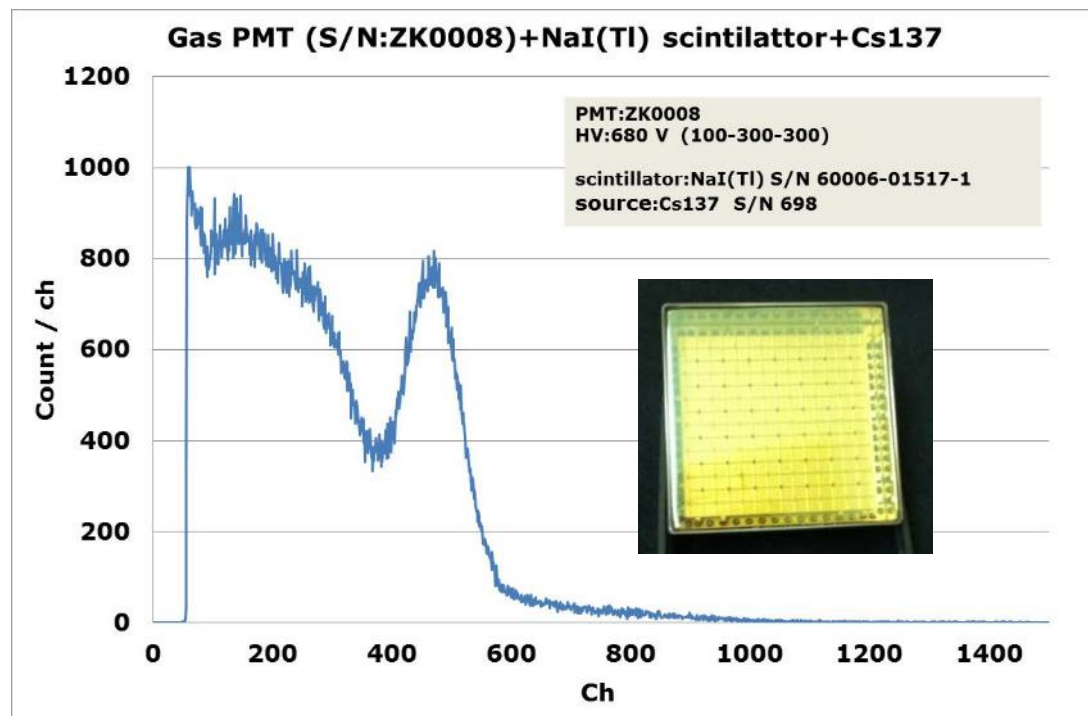
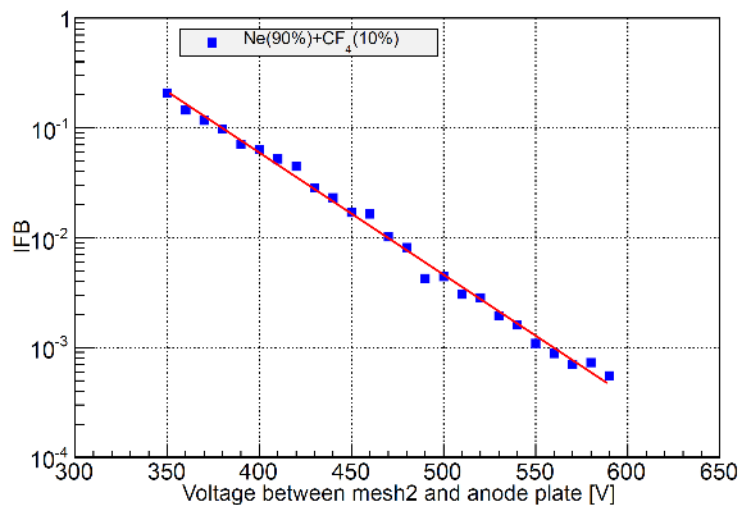
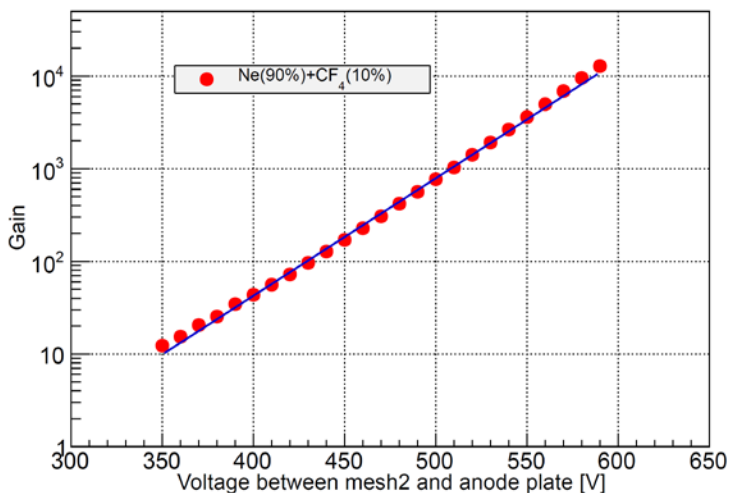

5*5ch (約15mm)を短絡して使用

K. Matsumoto, et al., Phys. Proc. 37 (2012) 499.

T. Ito, et al., IEEE NSS-MIC 2013 Conference Record.

F. Tokanai et al., NIMA, 766 (2014) 176.

2015/6/11

A. Ochi, RD51 Special WS on PD

20

Future development

Gas proportional counter + Mesh + Bialkali photocathode

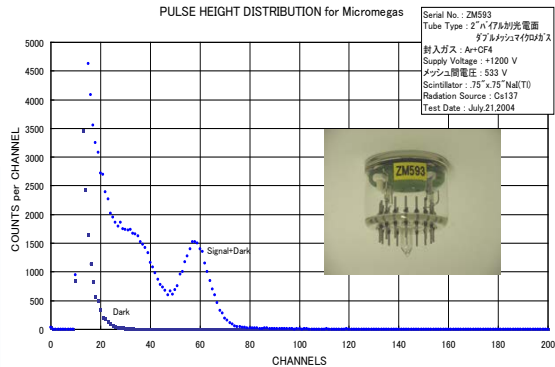

J. Va'vra and T. Sumiyoshi,
NIMA, 535, (2004), 334

(Photocathode) + (MPGD) "Gas PMT"

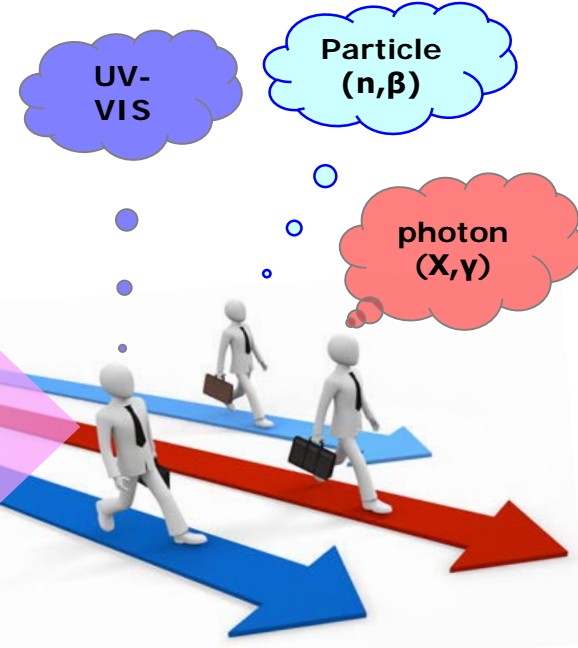
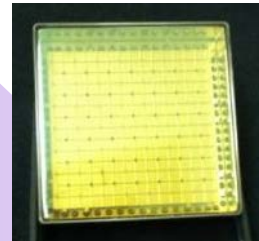
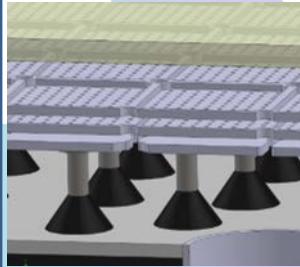

- T. Ito, et al., IEEE NSS-MIC 2013 Conf.
- T. Moriya et al., submitted to NIMA
- K. Matsumoto et al., Physics Procedia, 37 (2012) 499
- F. Tokanai et al., NIMA, 628 (2011) 190
- T. Sumiyoshi et al., NIMA, 639 (2011) 121

特願2008-155772, 特願2008-155788
特願2011-185208

Capillary Plate gas detector

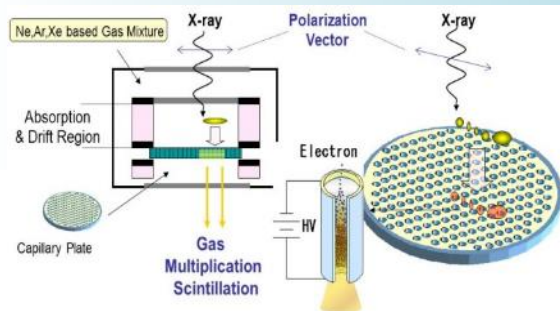

H. Sakurai et al., NIMA, 374 (1996) 341.

F. Tokanai et al., NIMA, 571 (2007) 289.

特願2003-030797, 特願2006-209071

Conclusion

We have been developing the gaseous PMTs with a bialkali photocathode combined with the MPGDs.

The gaseous PMT can be operated in high magnetic field.

Quantum efficiencies (QEs) of up to 12% were obtained for the gaseous PMT, and it was very stable in the gas (without gas multiplication).

After 182h of operation, when the accumulated charge exceeded $0.4 \mu\text{C}/\text{mm}^2$, about 20% decrease in the QE was observed for the gaseous PMT.

We have developed a gaseous PMT with double mesh type MPGD and a maximum gain of up to 10^4 and ion feedback of less than 1×10^{-3} were obtained.

For practical application, the higher gain and less ion feedback are required. We are currently developing a new MPGD. These developments are also useful for other applications such as X-ray and neutron imaging.

X-ray imaging with gas scintillation

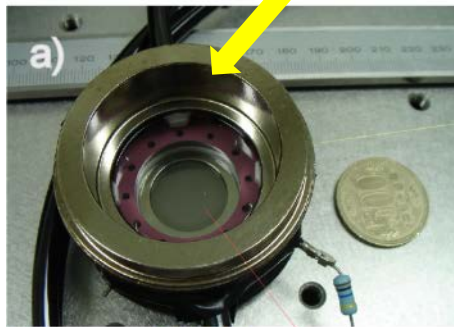
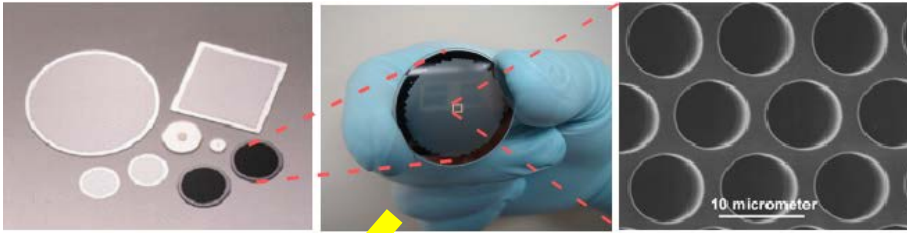

Compact CP Gas Detector

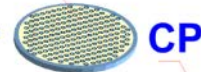

cooled CCD C4742-95

Micro-focus X-ray Beam (80 kV L6731-01 HAMAMATSU)

c)

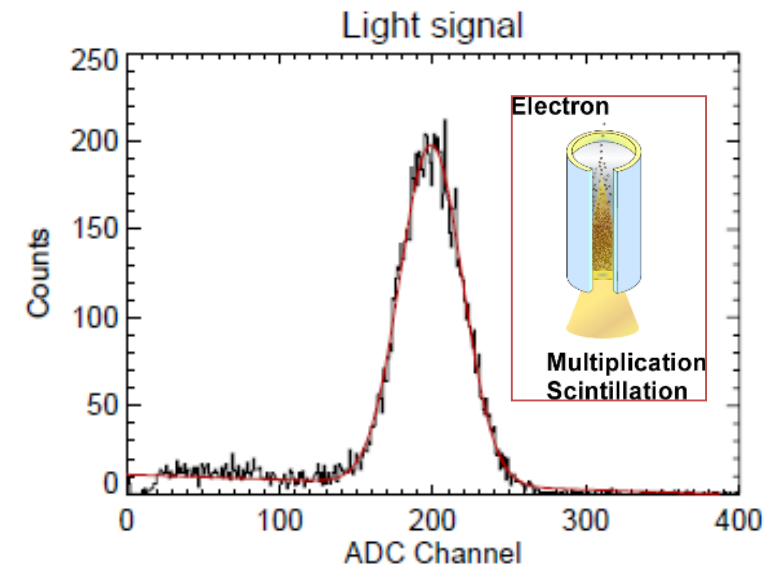
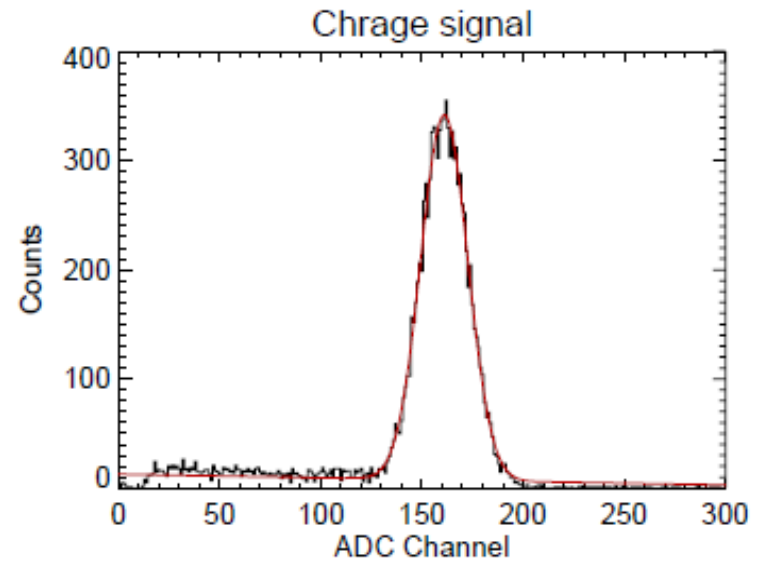
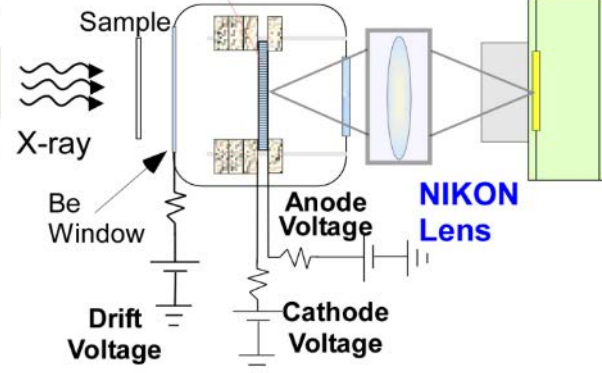

X-ray Images

Ar(90%)+CF₄(10%)
at 1 atm.

Micro-foucs X-ray
Generator

- Anode Voltage: 15 kV
- Current : 10 mA

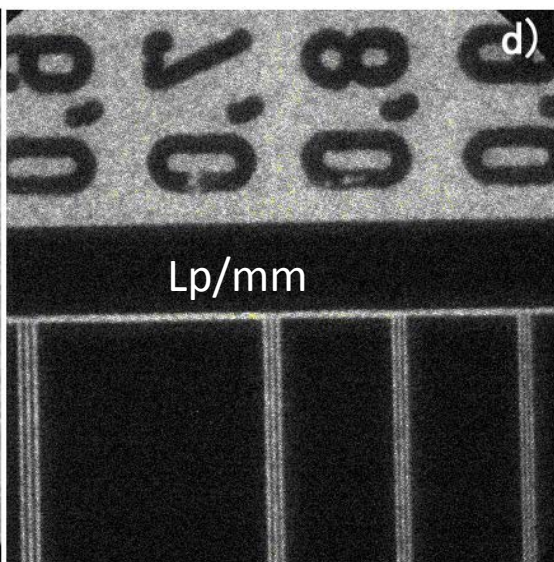
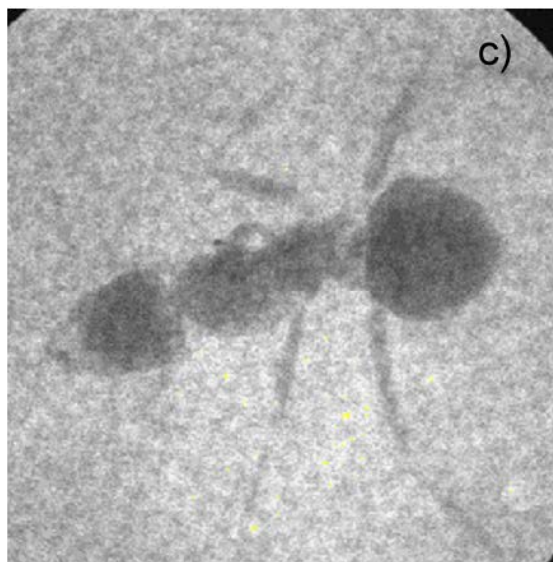
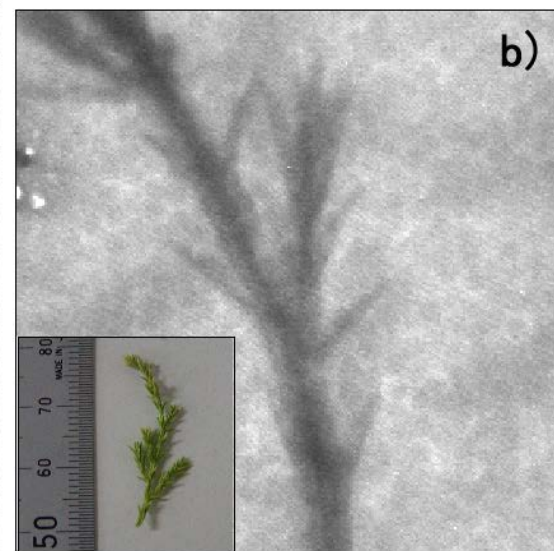
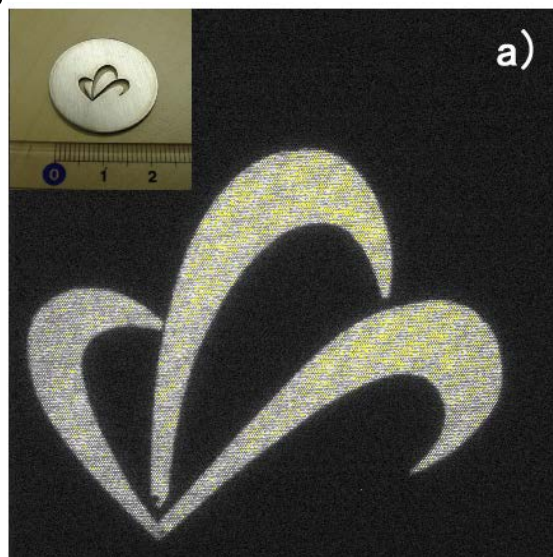

Excellent imaging capability and **high signal to noise ratio** are demonstrated for these X-ray images.

X-ray photoelectron track image (Optical imaging CP gas detector)

Ar(90%)+CH₄(8%)+TMA(2%)

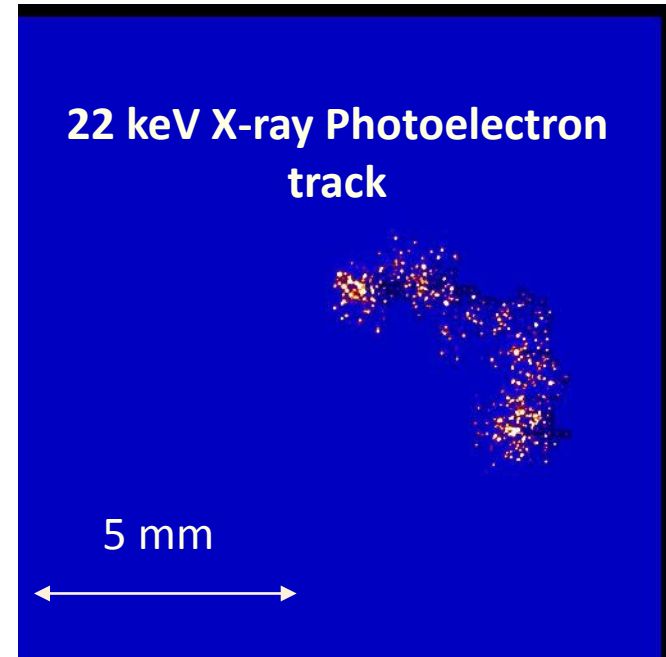
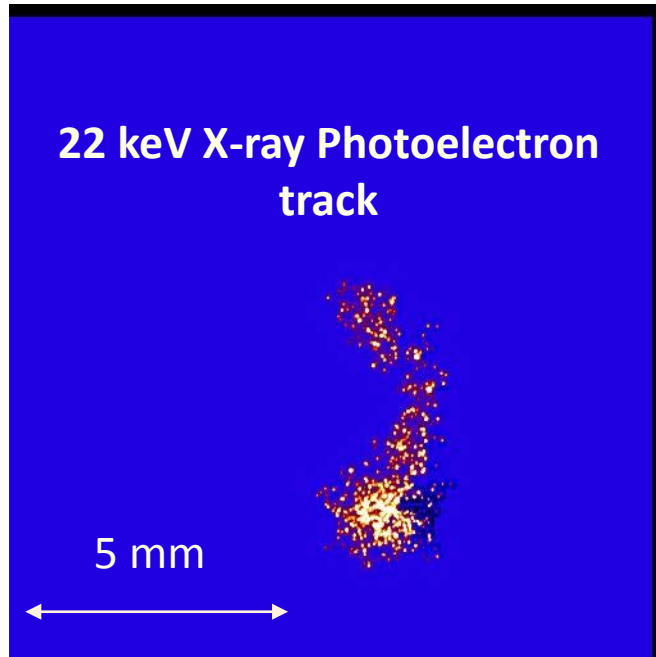

*Imaging of photoelectron track is
a powerful tool for
cosmic X-ray polarimetry.*

H. Sakurai et al. NIM A 513, p. 282, 2003
H. Sakurai et al. NIM A 525, p. 6, 2004
F. Tokanai et al., IEEE TNS 53 p. 1634, 2006