

RICH 2016

9th International Workshop on Ring Imaging Cherenkov Detectors, Bled, Slovenia, Sept 5-9 2016

RICH-related data analysis, and its use for physics

Peter Križan

University of Ljubljana and J. Stefan Institute

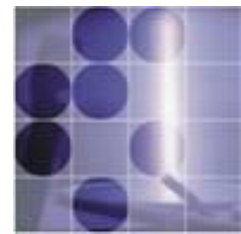
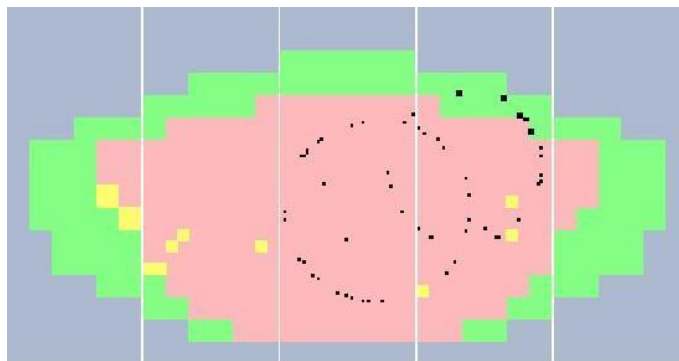

Contents

Why particle identification?

Alignment and calibration

Event analysis

Impact on physics

Summary

Mostly covering topics presented at this workshop

Why particle ID?

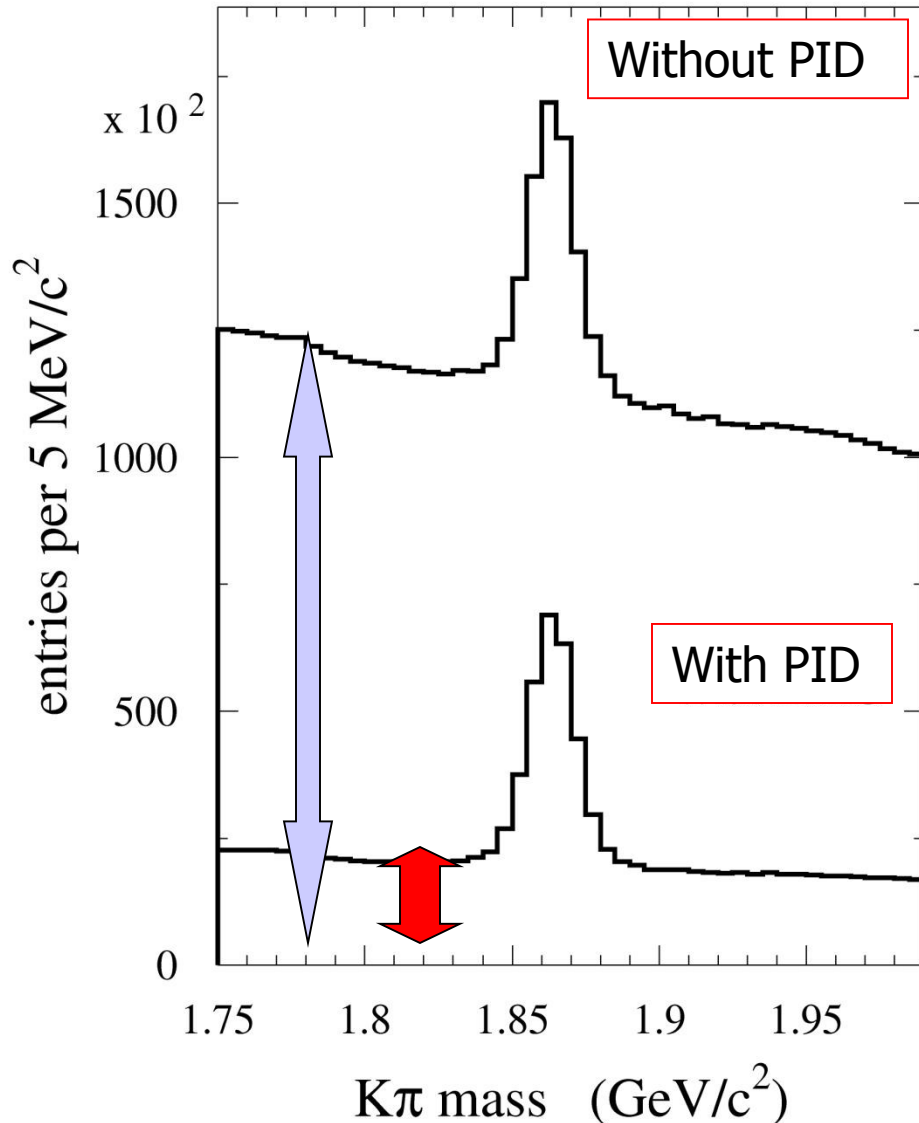

Example 1: B factory

Particle identification reduces the fraction of wrong $K\pi$ combinations (combinatorial background) by $\sim 5x$

Why particle ID?

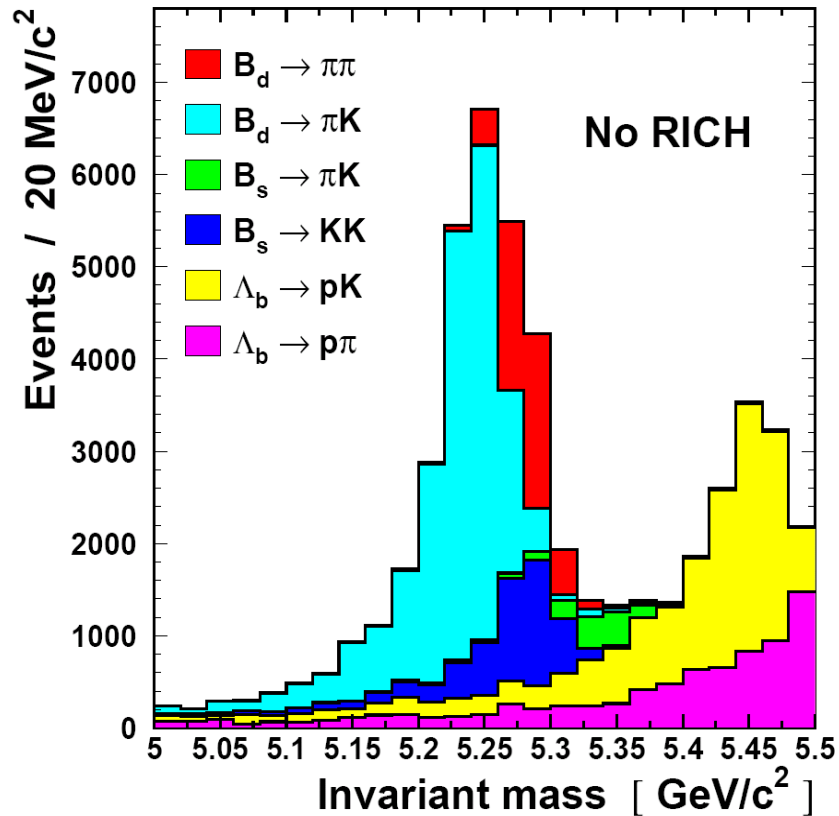

Example 3: LHCb

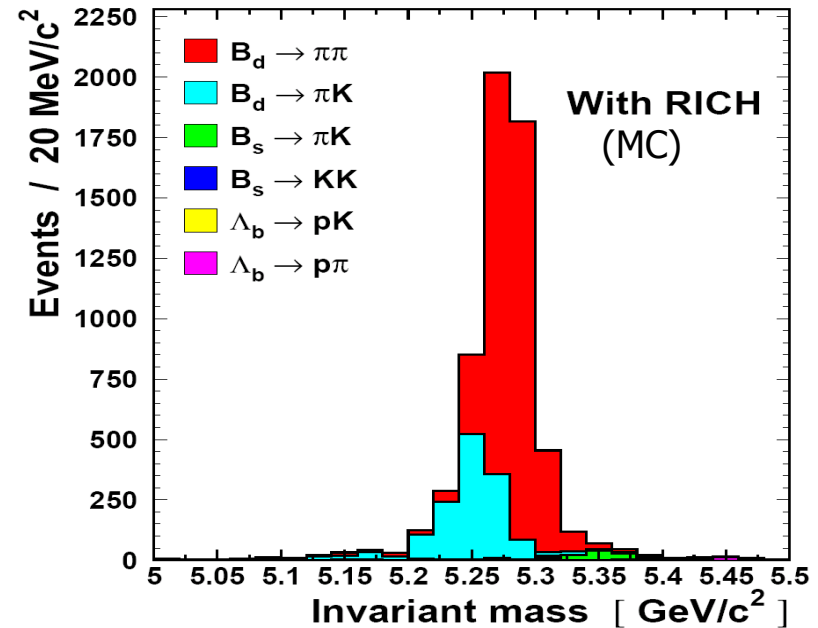

Need to distinguish $B_d \rightarrow \pi\pi$ from other similar topology 2-body decays and to distinguish B from anti-B using K tag.

Why particle ID?

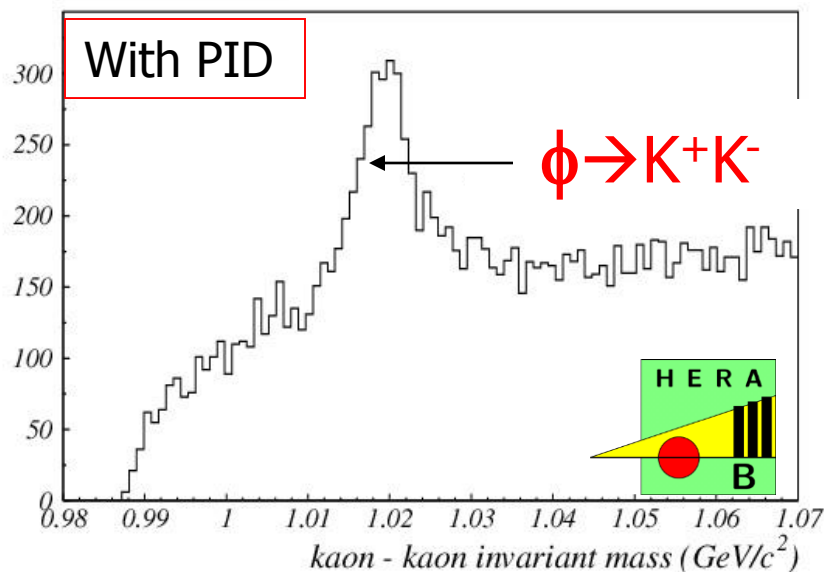
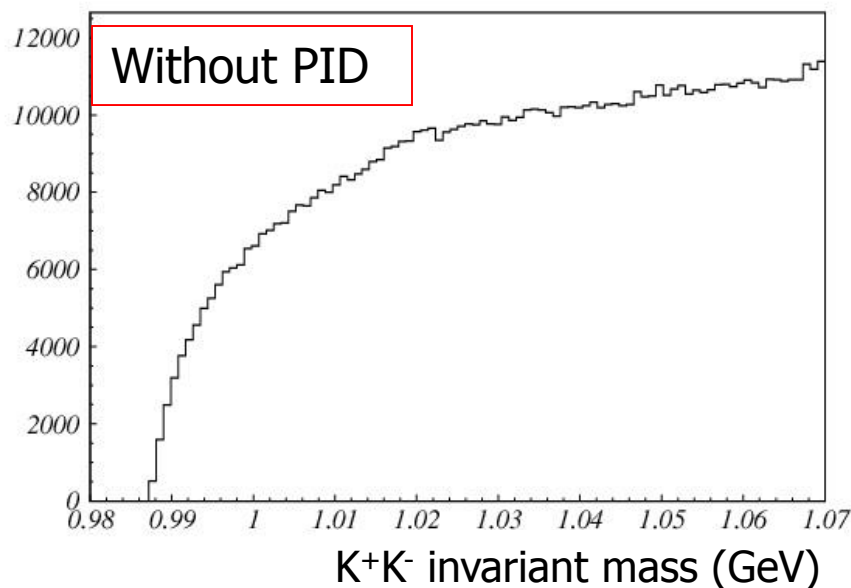

Example 2: HERA-B

K⁺K⁻ invariant mass.

The inclusive $\phi \rightarrow K^+K^-$ decay only becomes visible after particle identification is taken into account.

Why particle ID?

PID is also needed in:

- General purpose LHC experiments: final states with electrons and muons
- Searches for exotic states of matter (quark-gluon plasma)
- Spectroscopy and searches for exotic hadronic states
- Studies of fragmentation functions
- Identification of neutrino flavour in neutrino mixing experiments

Cherenkov detectors

Provide particle identification over huge kinematic regions

Provide a detector medium for neutrinos

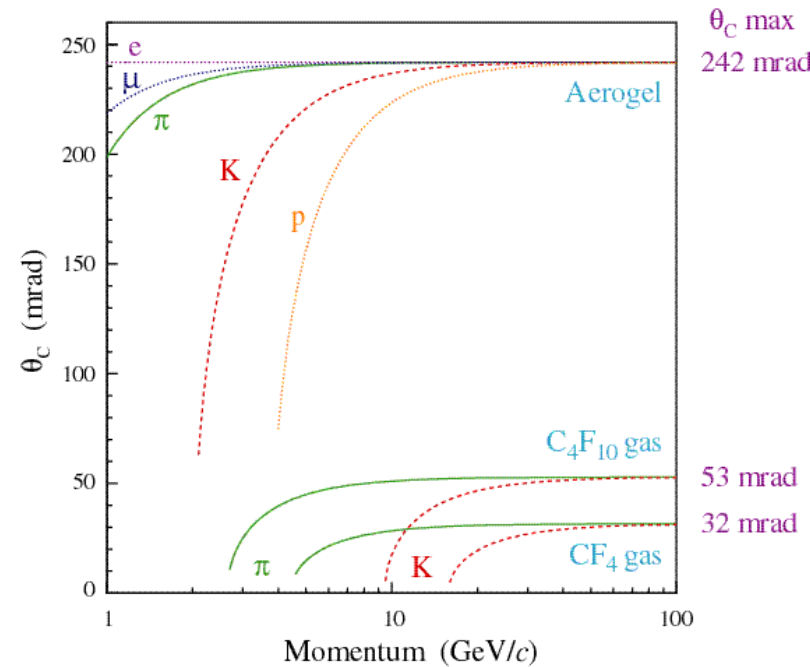

Two out of three recent Nobel Prizes in particle physics got essential experimental support from Cherenkov detectors

Neutrino detection and identification: Supekamiokande

Muon-electron discrimination based on the patterns at the sensor walls.

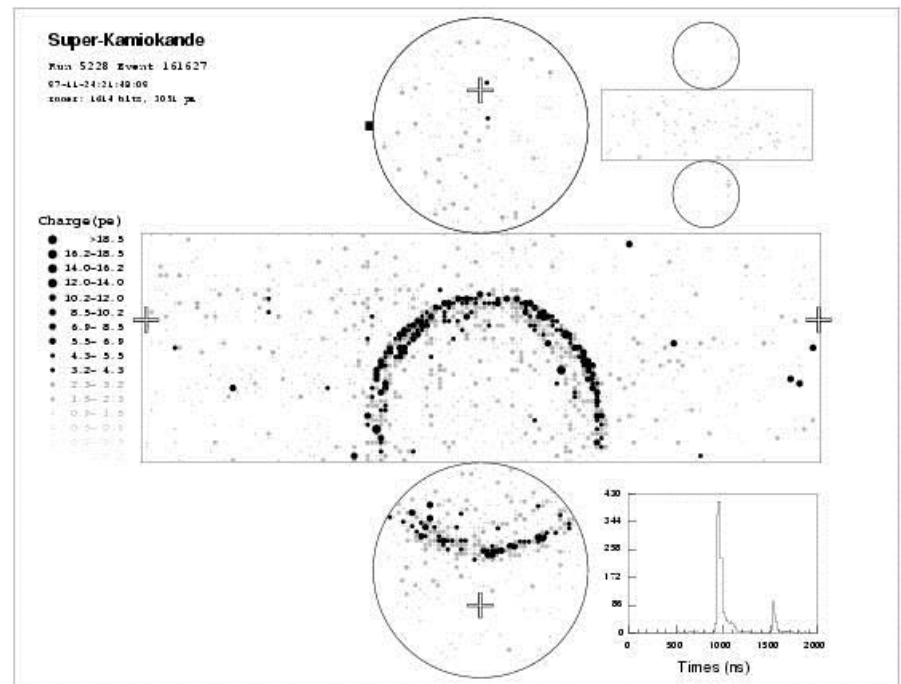
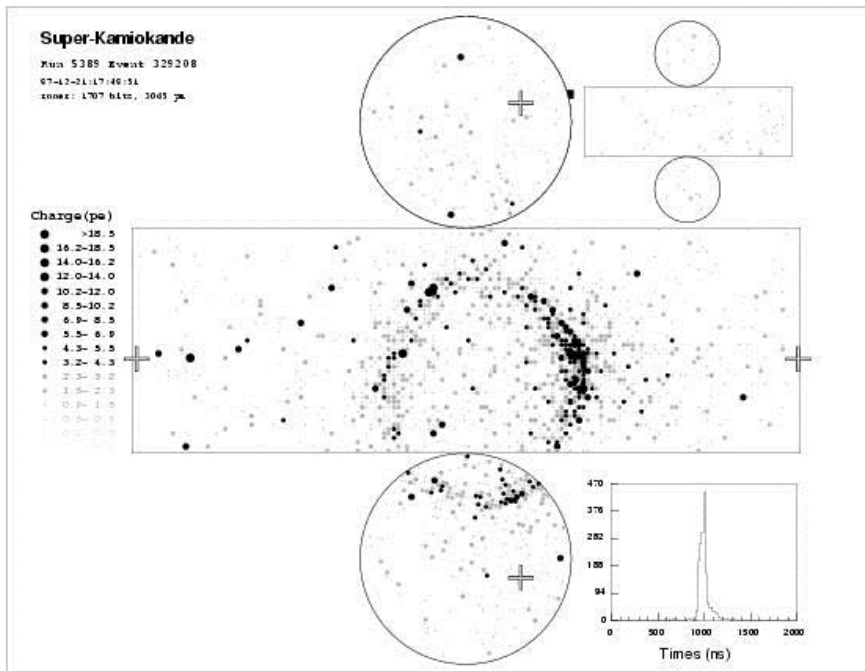
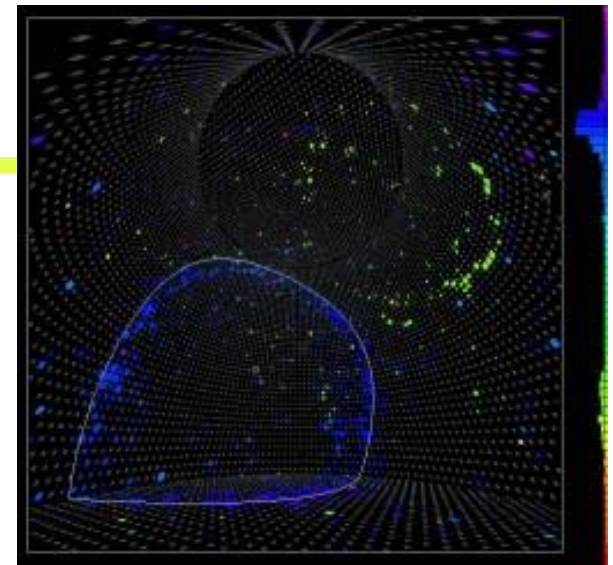

Cherenkov detectors in flavour physics

Particle identification at B factories (Belle and BaBar):
was essential for the observation of **CP violation in the B**
meson system.

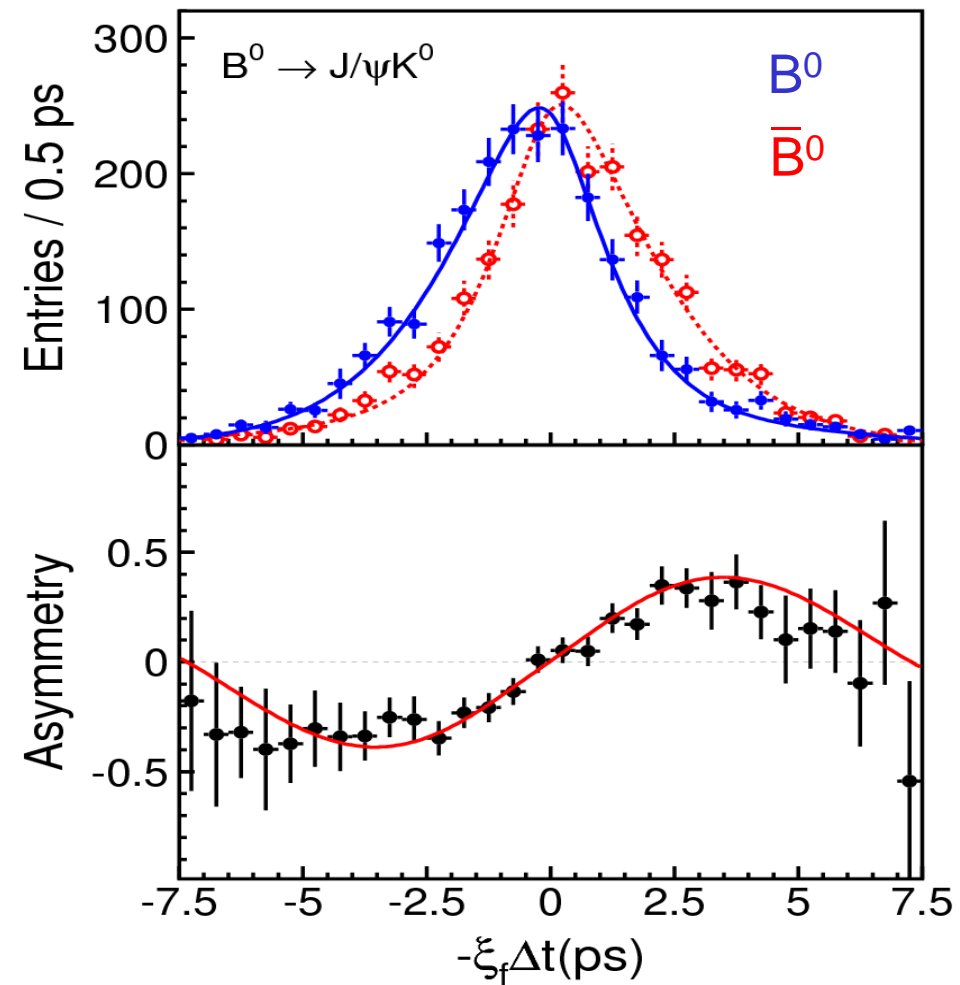

B^0 and its **anti-particle**
decay differently to the
same final state $J/\psi K^0$

Flavour of the B: from decay
products of the other B,
charge of the **kaon**, electron,
muon

Example: Belle

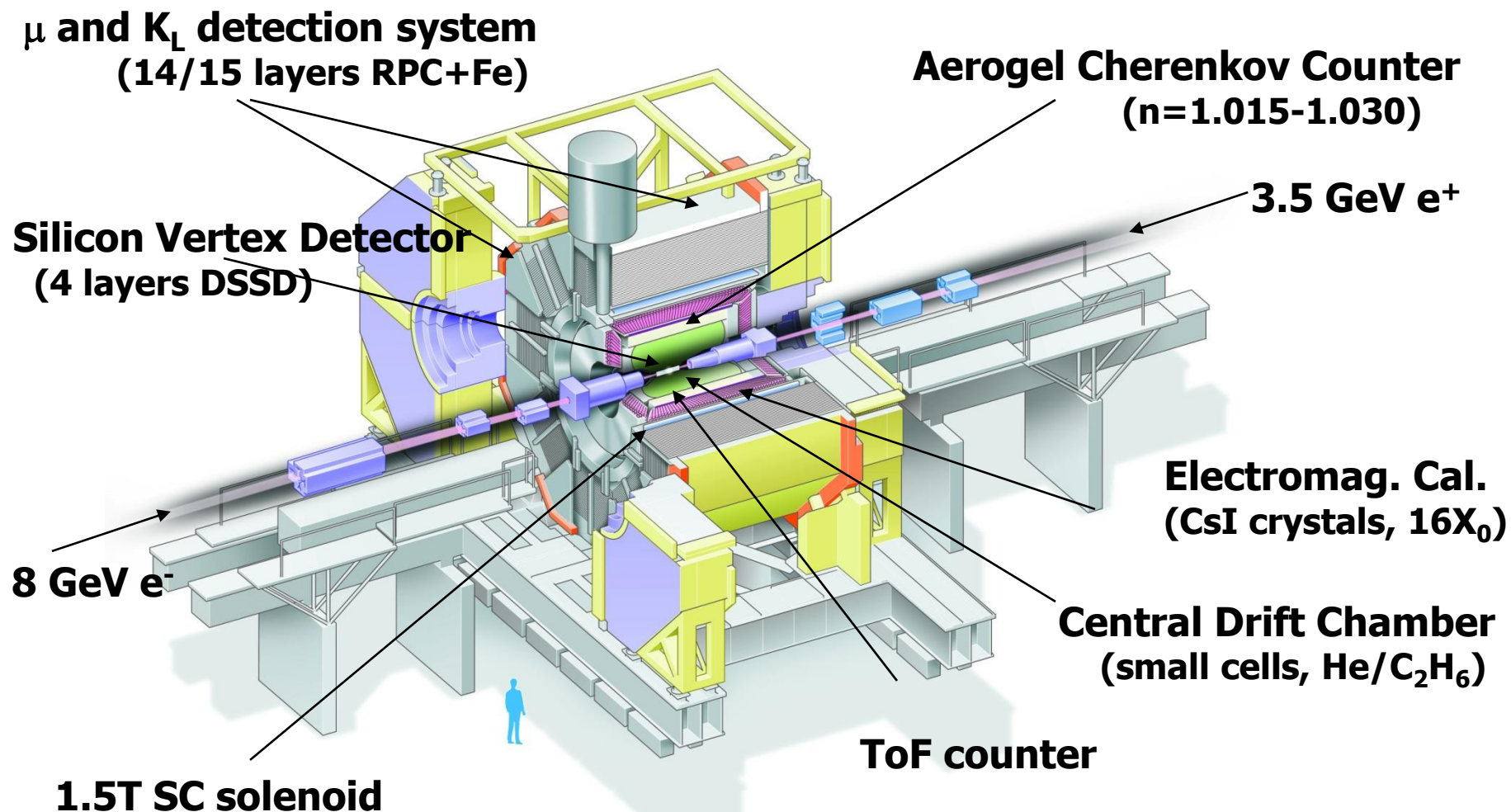

Particle identification systems in Belle

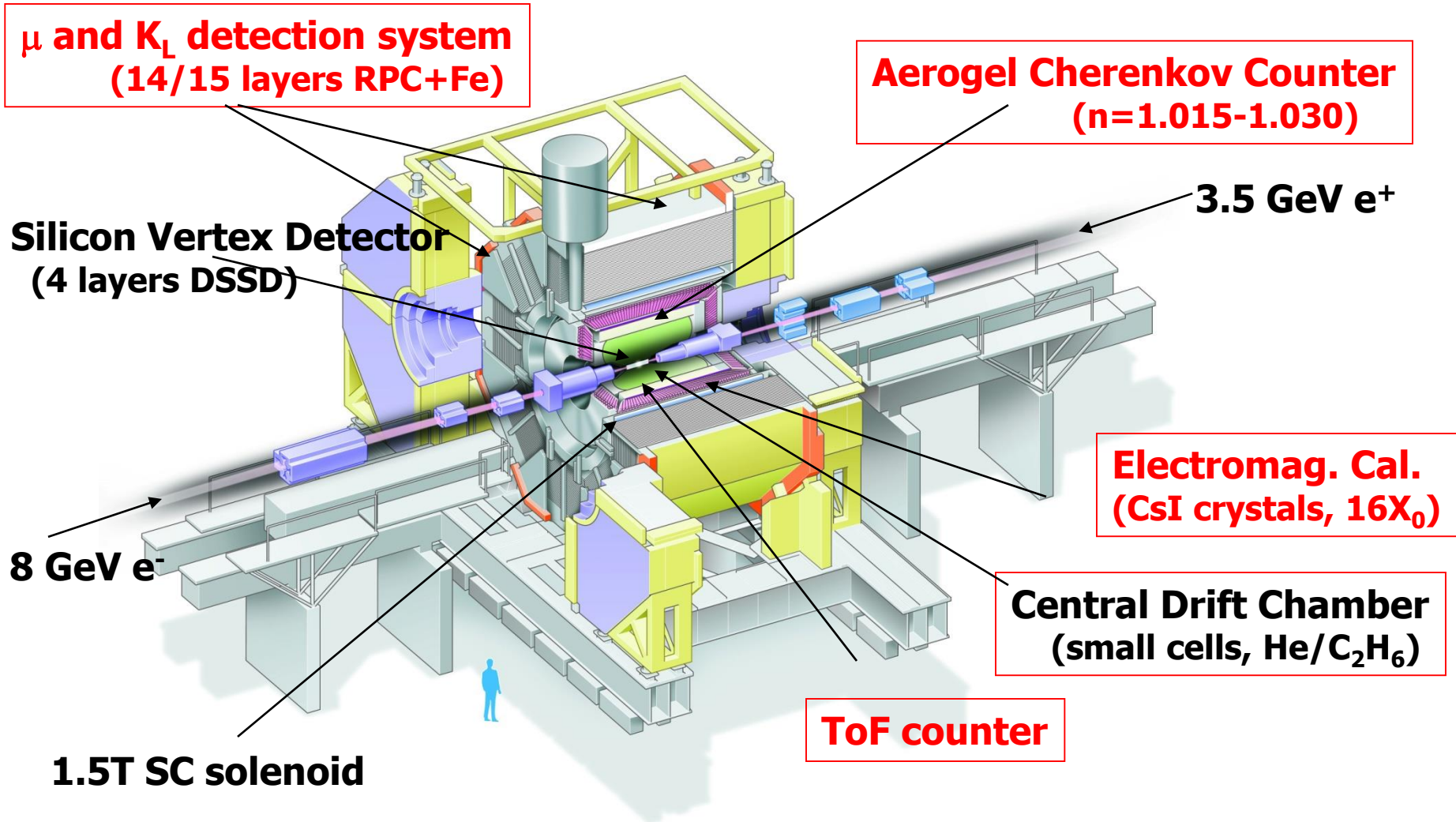



DIRC - detector of internally reflected Cherenkov light

BaBar spectrometer at PEP-II

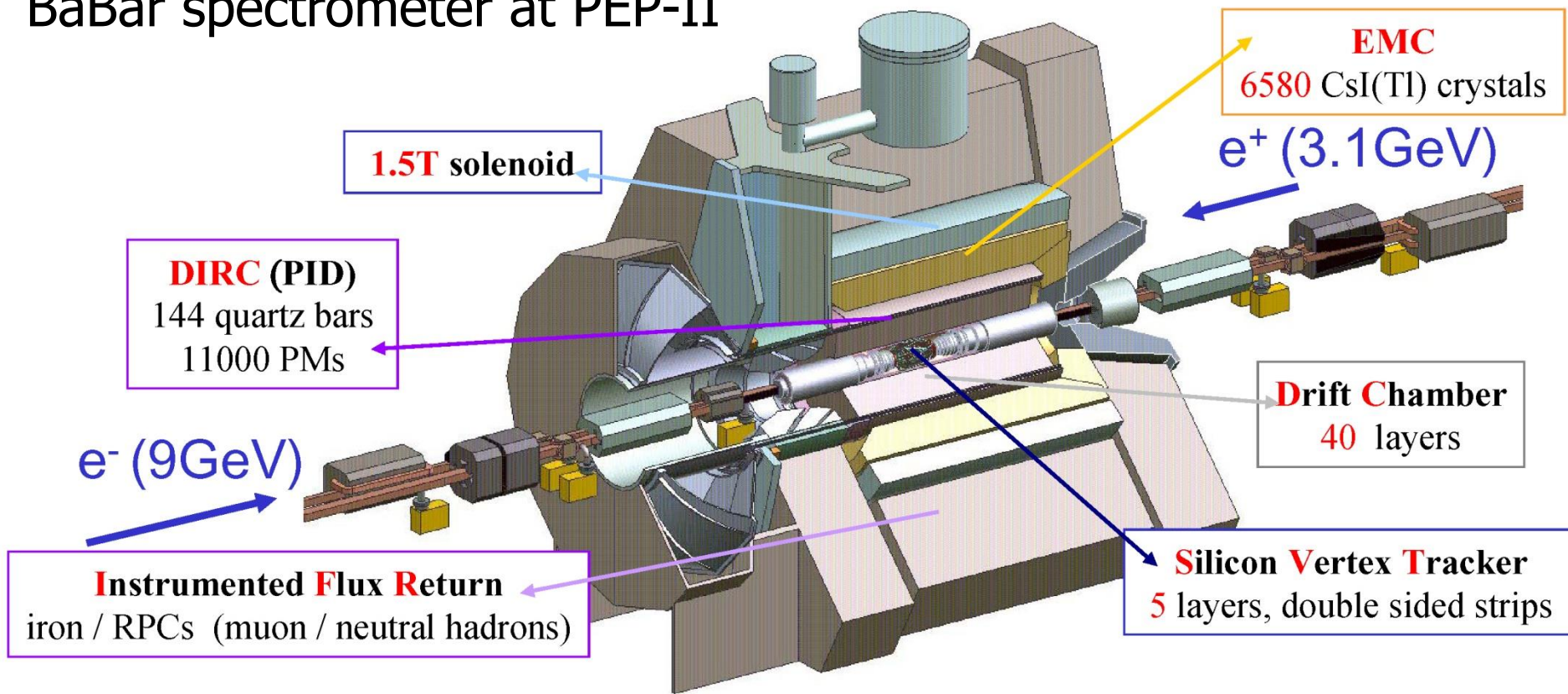

PID coverage of kaon/pion spectra in Belle

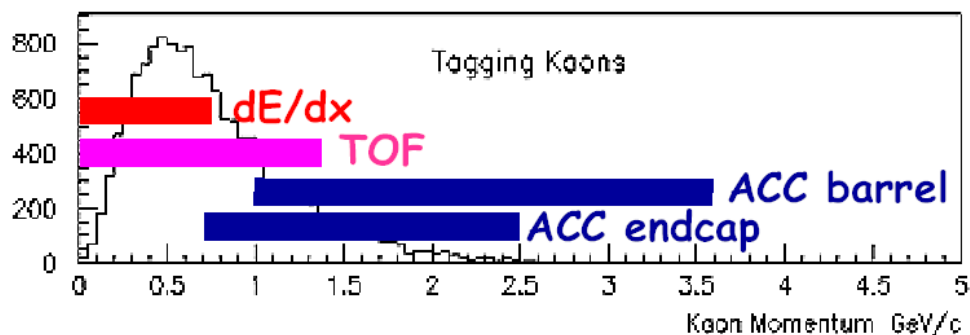

Tagging Kaons

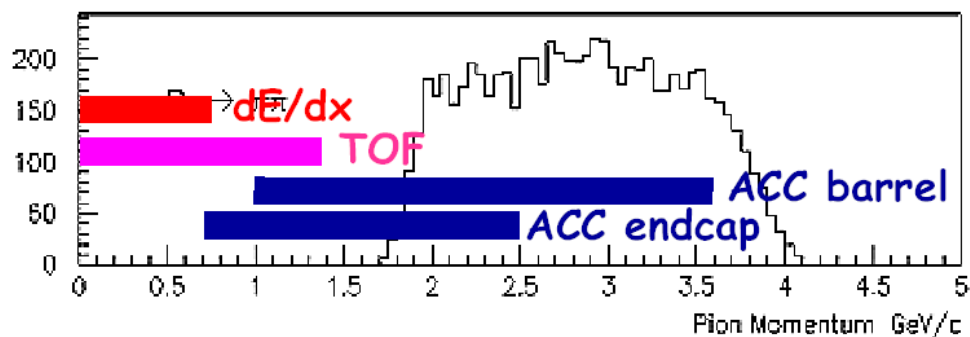

$B \rightarrow \pi\pi$

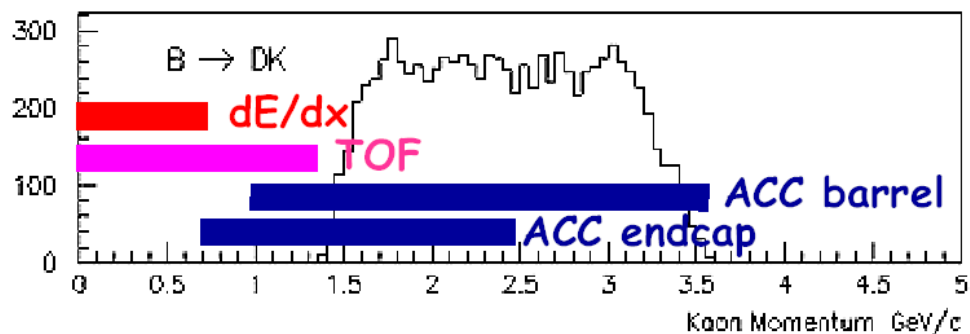

$B \rightarrow DK$

PID coverage of kaon/pion spectra in BaBar

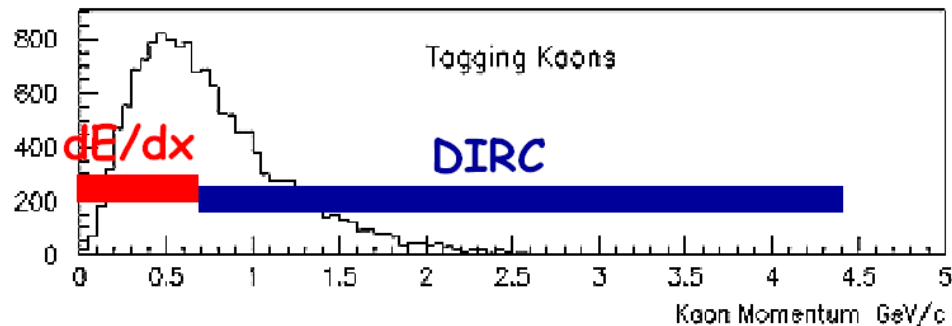

Tagging Kaons

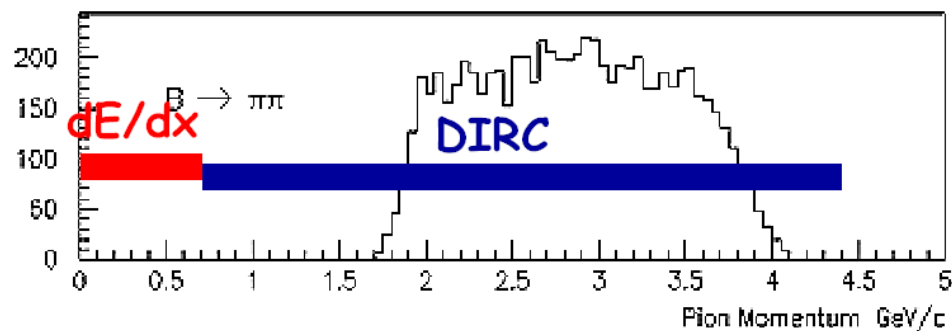

$B \rightarrow \pi\pi$

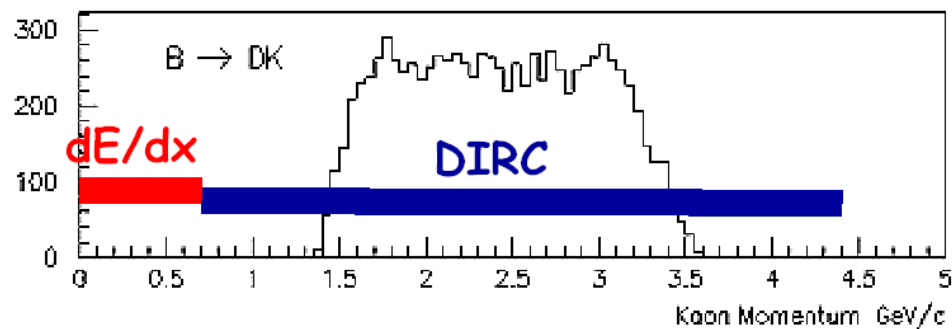

$B \rightarrow DK$

Calibration and alignment

Mirror alignment

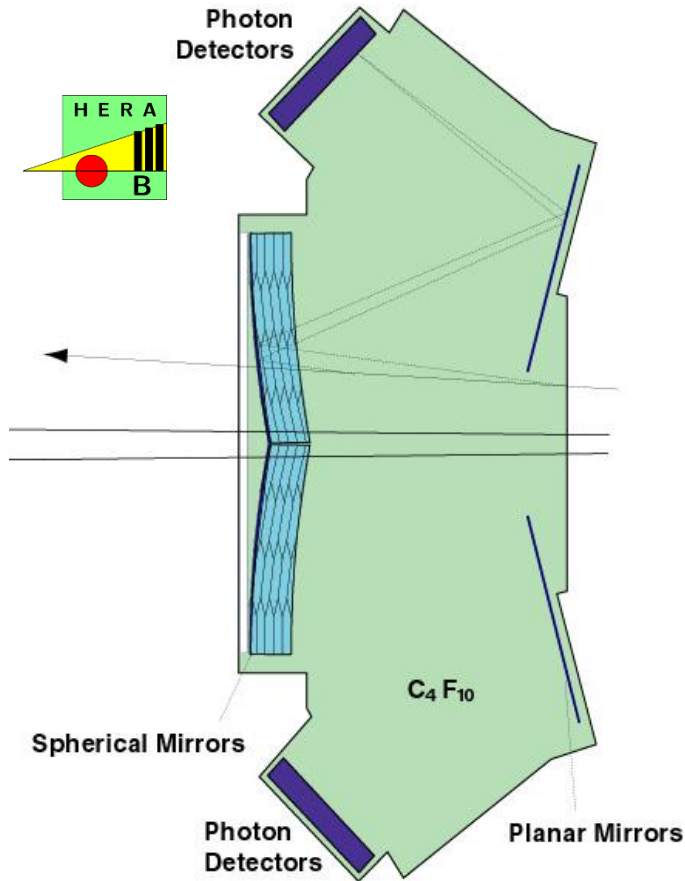

Gas based RICHes: large mirrors \rightarrow segments
 \rightarrow relative alignment

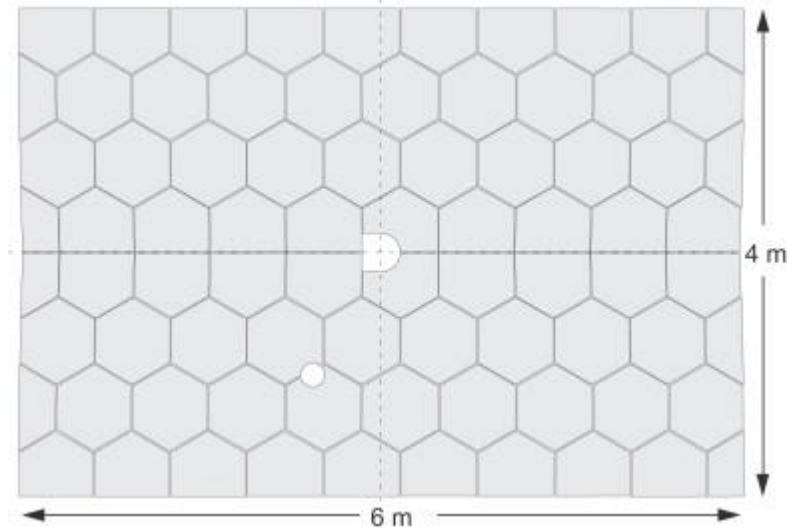

- Spherical mirror: 80 hexagonal segments
- Planar mirrors: 2x 18 rectangular segments

Aligning pairs of spherical and planar segments by using unambiguous photons.

Mirror alignment

Misalignment: Cherenkov angle depends on the azimuthal angle around the track

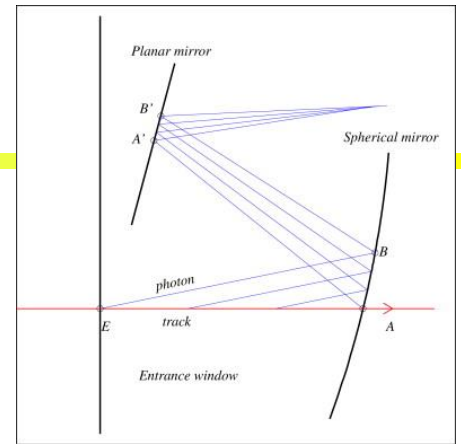

Use unambiguous photons.

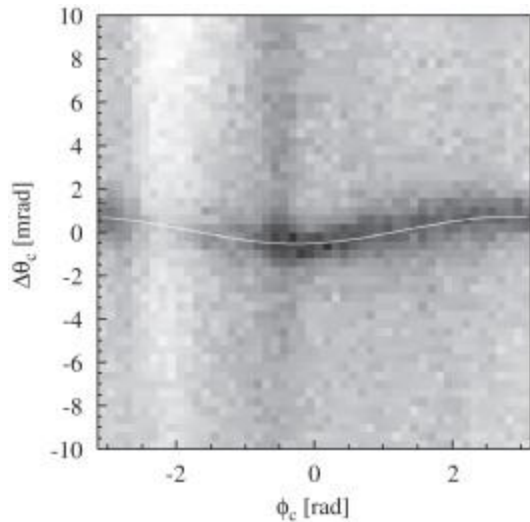
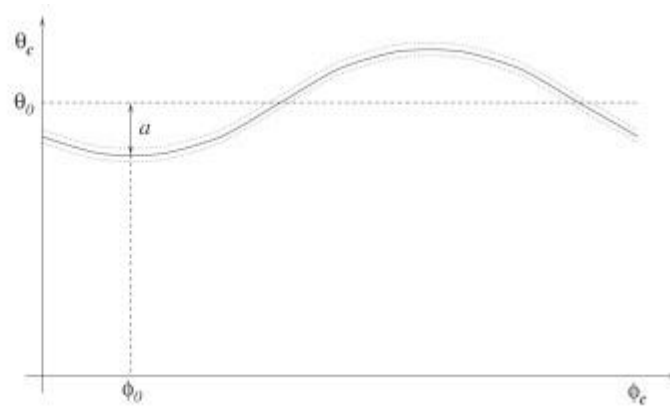
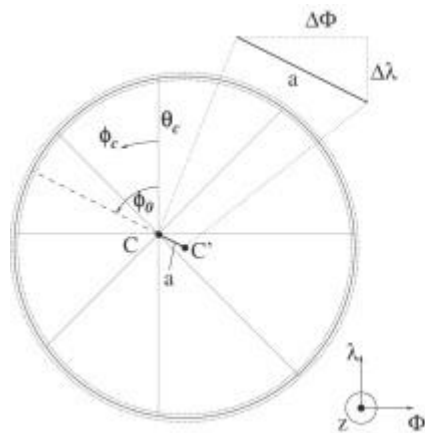

mirrors 34 14

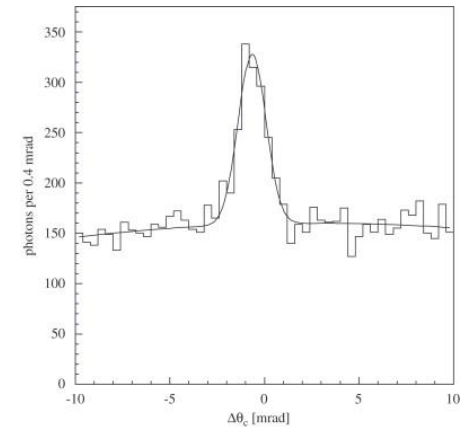
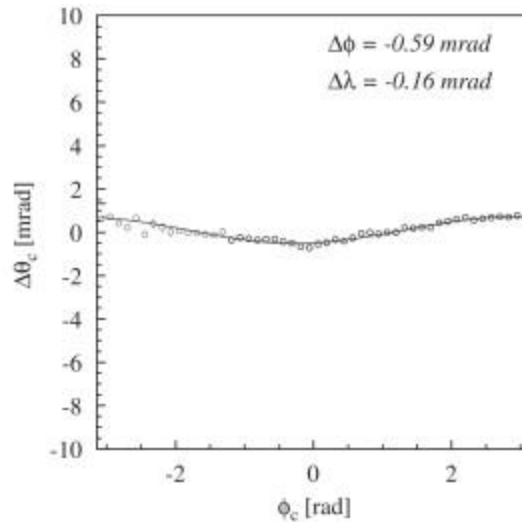

Slice in phi_c

Mirror alignment

Initial mirror system alignment:
with optical methods, theodolite.

Alignment with data: tells you the
ultimate truth...

Combine all alignment data for all
(possible) pairs of segments →
solve a system of linear equations

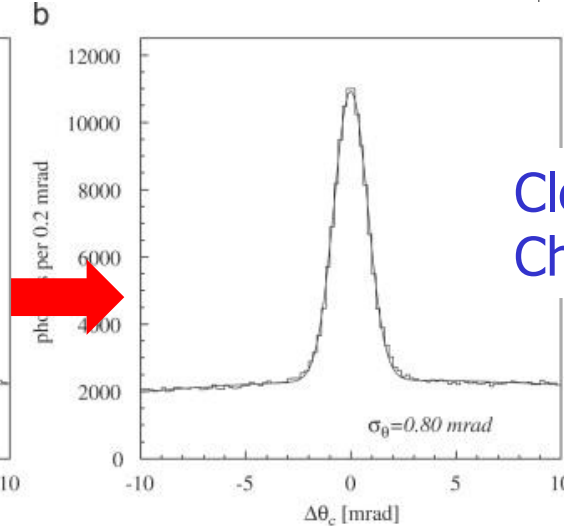
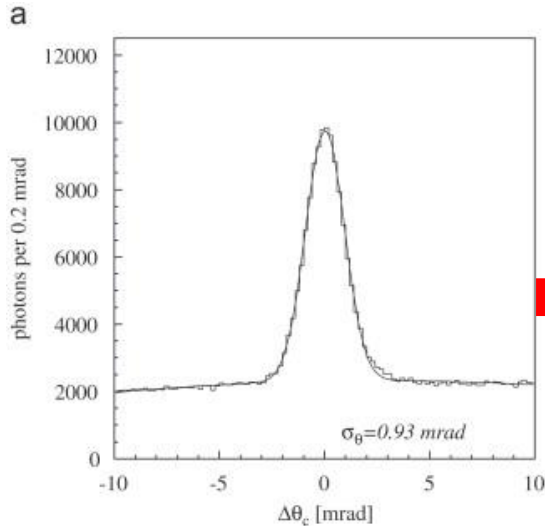
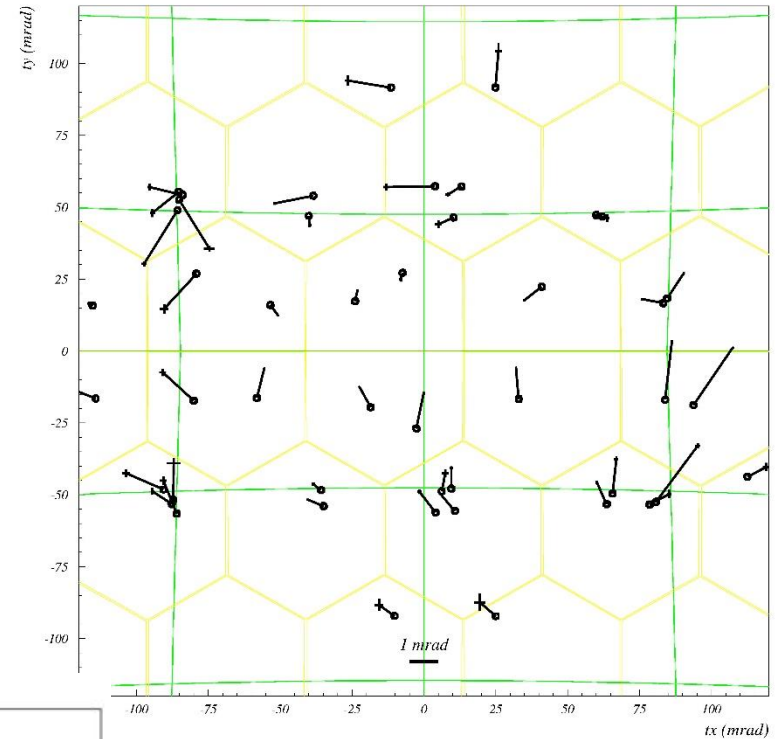

Clear improvement in
Cherenkov angle resolution

→ NIMA 586 (2008) 174

LHCb initial alignment

A. Papanestis (RICH2007)

Initial mirror alignment
(50 μrad)

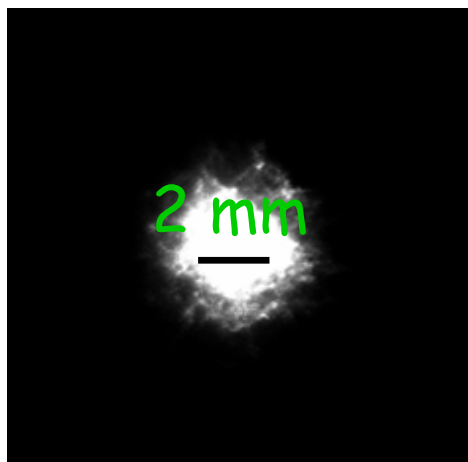

Mirror movement during transport and installation

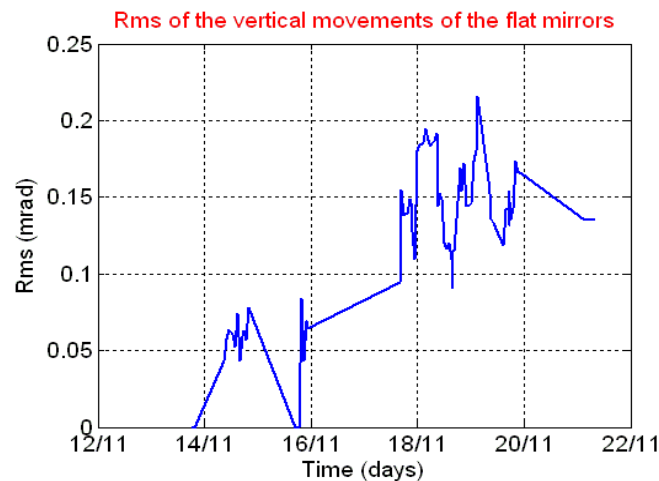
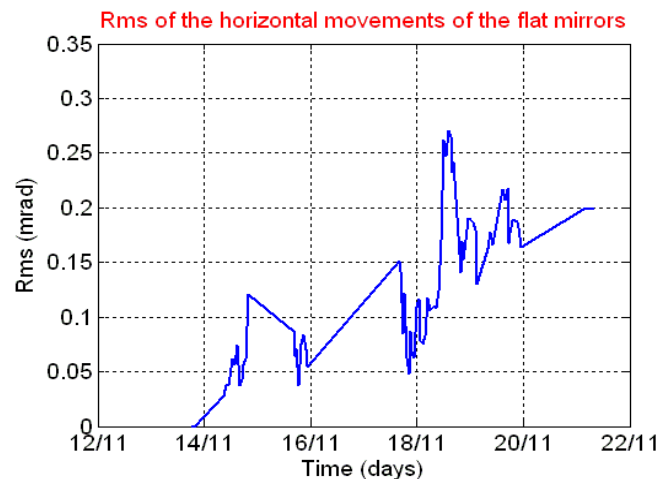

New LHCb Trigger: need online detector calibration



Run I

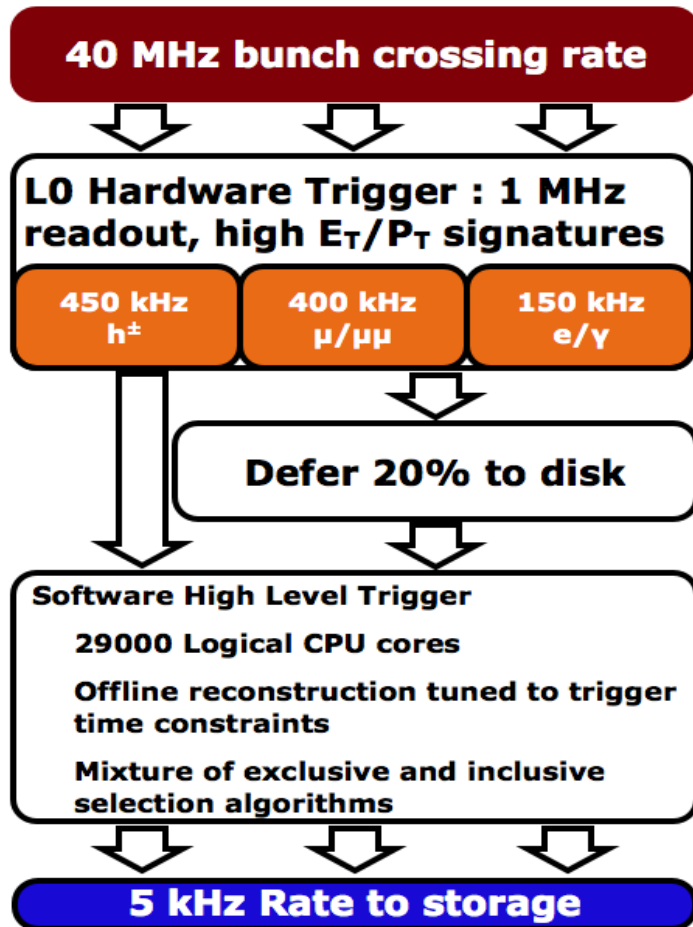

Run II

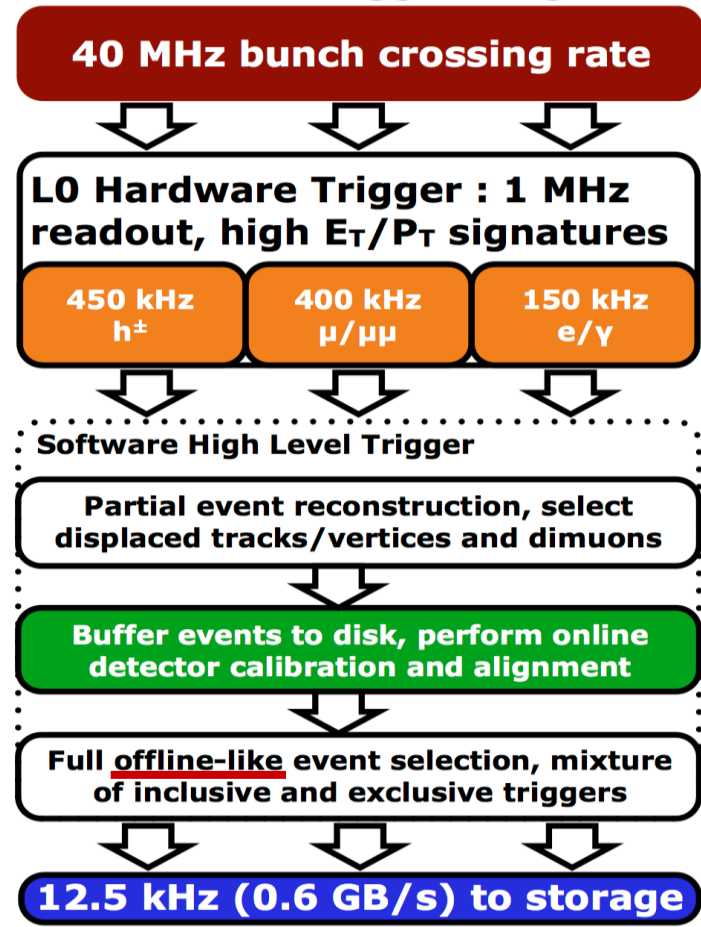

LHCb calibration

Key points to monitor - All time-dependent!

Cherenkov angle

- RICH mirrors / detector planes alignment
- Tracking system alignment
- HPD image calibration
- Refractive index (Cherenkov angle)

Number of photons

- Refractive index

→ Talk by Jibo He

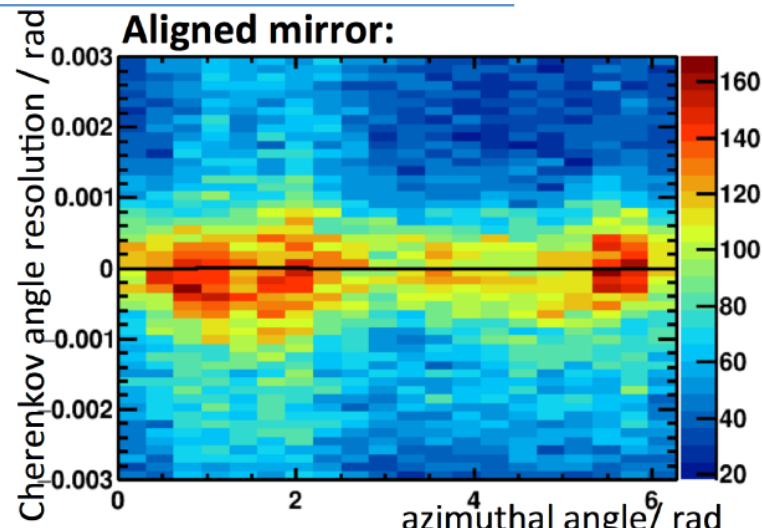
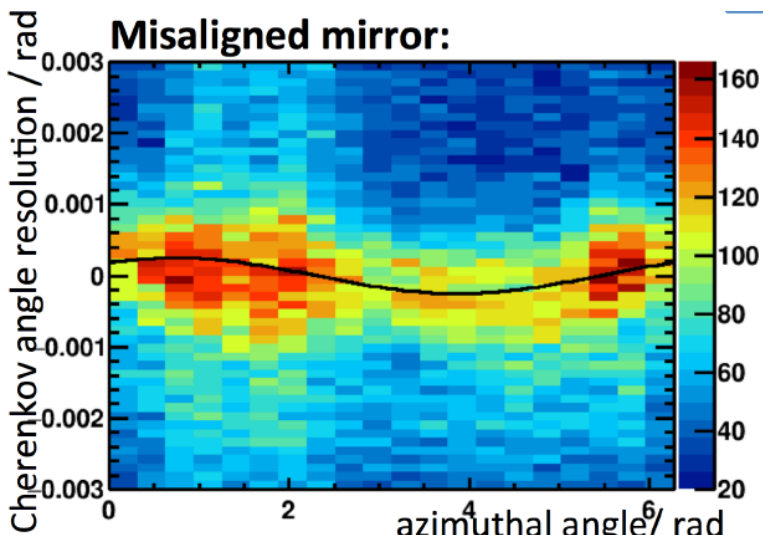

Resolution stability: RICH2

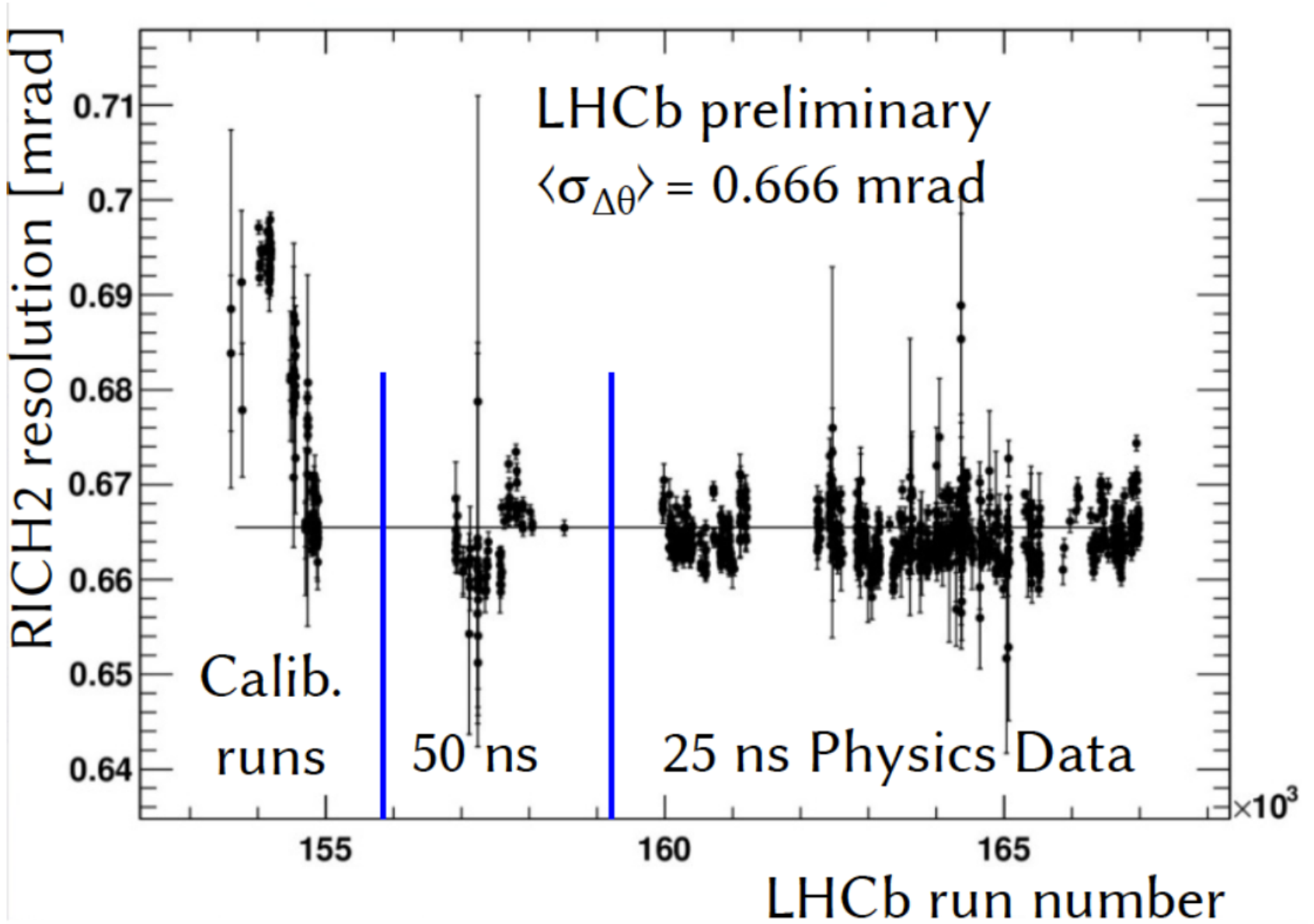

Calibration sample

- Collect pure samples of known-ID particles
- There is a main trigger line for each particle and possibly another one for cross-checks and systematic studies

Species	Low $p - p_T$	High p and p_T
e^\pm	—	$J/\psi \rightarrow e^+ e^-$
μ^\pm	$D_s^+ \rightarrow \mu^+ \mu^- \pi^+$	$J/\psi \rightarrow \mu^+ \mu^-$
π^\pm	$K_S^0 \rightarrow \pi^+ \pi^-$	$D^* \rightarrow D^0 (K^- \pi^+) \pi^+$
K^\pm	$D_s^+ \rightarrow K^+ K^- \pi^+$	$D^* \rightarrow D^0 (K^- \pi^+) \pi^+$
p^\pm	$\Lambda^0 \rightarrow p \pi^-$	$\Lambda^0 \rightarrow p \pi^-$, $\Lambda_c^+ \rightarrow p K^- \pi^+$

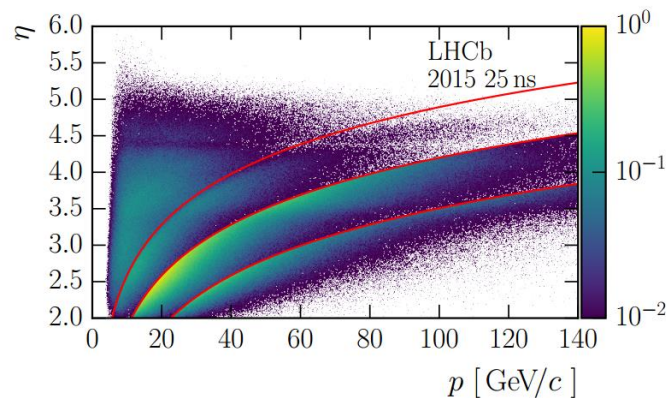
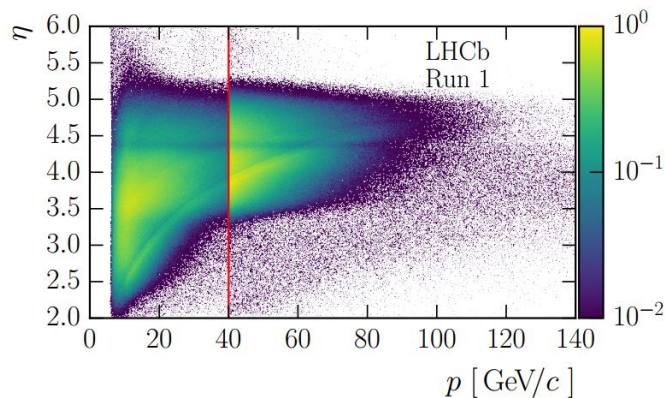

New selections designed to improve the kinematic coverage

Mass distributions of PID samples

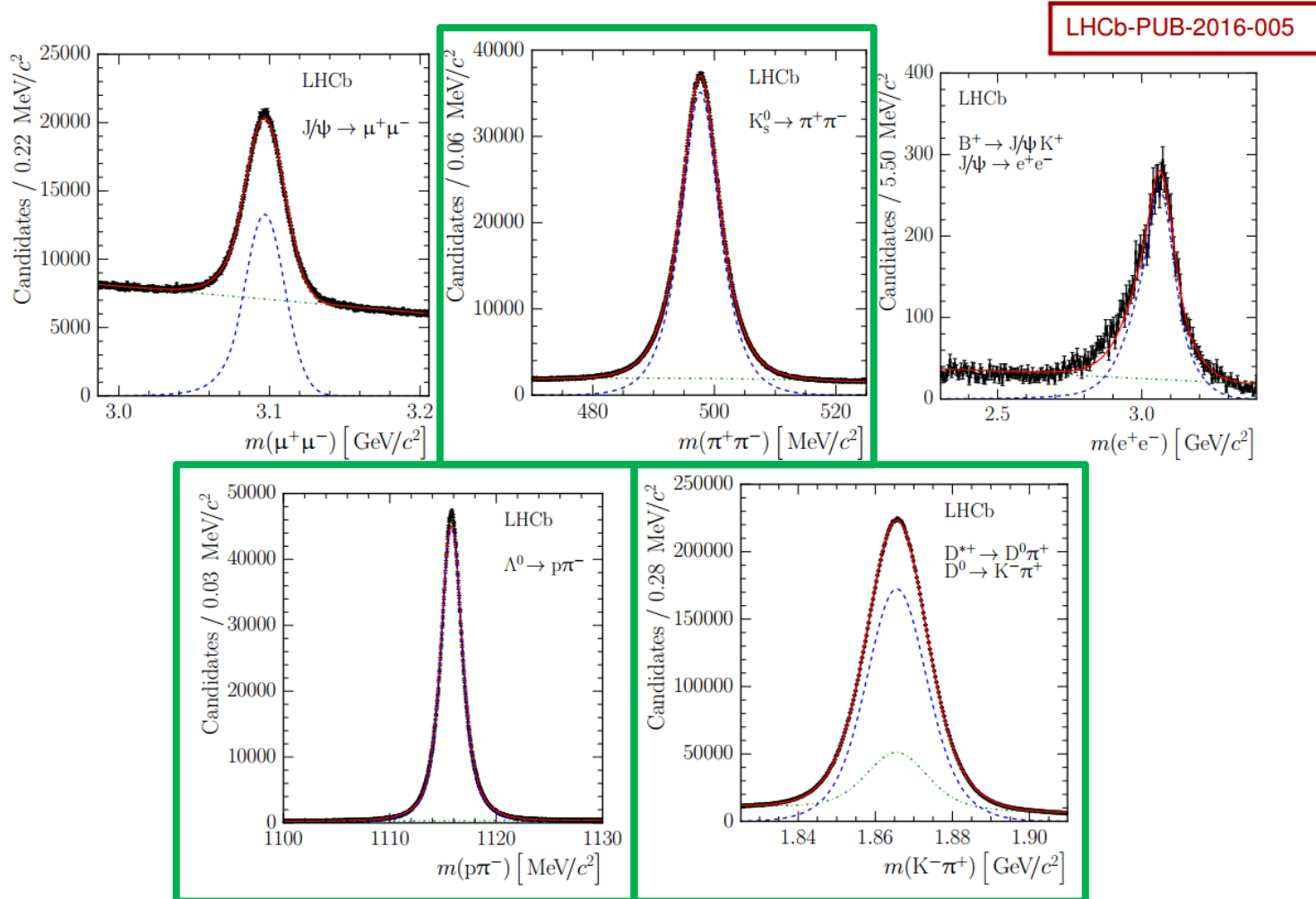

Reconstruction and likelihood calculation

- Track based (global and local likelihood)
- Track based ring search (no time → backup slides)
- Stand-alone ring search

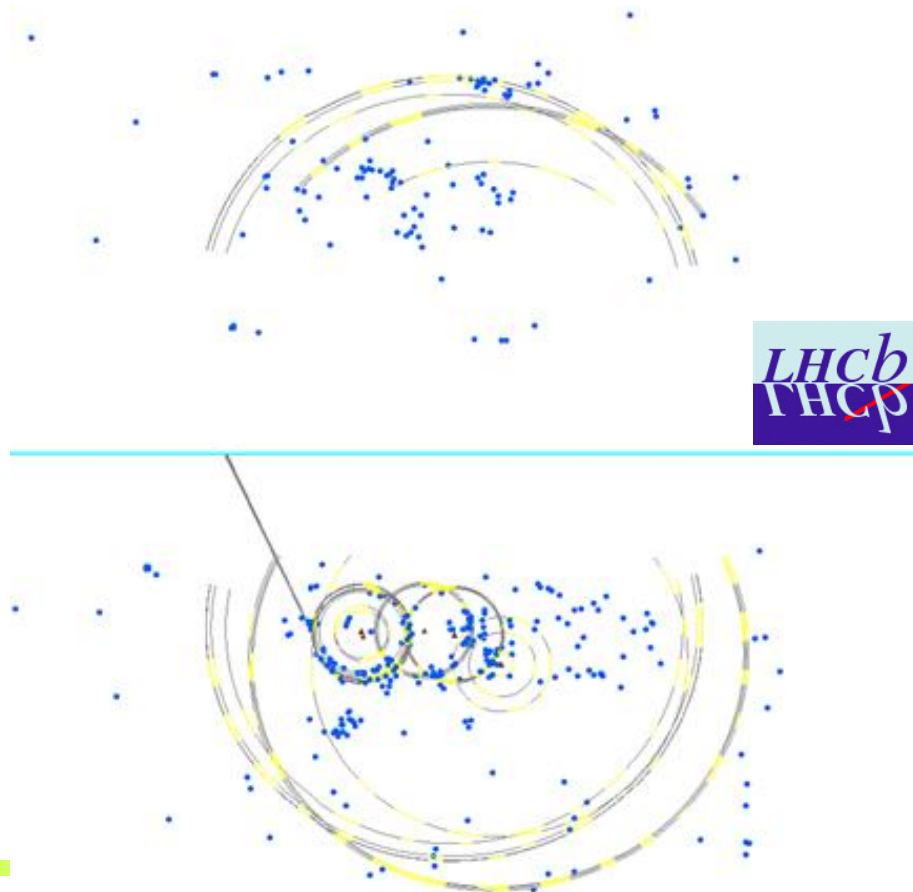

Global likelihood PID algorithm



Take all pixels hit *and* all tracks *and* all radiators, and maximize

$$L = L (n_{pixel}, \sum e_{pixel,track}, b_{pixel})$$

1. Assume all particles to be pions (or seed from previous reconstruction).
Estimate background parameter b_{pixel}

2. Calculate likelihood of given pixel distribution

3. Iterate

- change PID hypothesis for one track at a time
- recalculate likelihood
- choose change, that had biggest (positive) impact
- assign new PID to that track until no positive change is found

With improved PID hypotheses, background estimate can be updated, and next iteration can start (2nd is usually final).

The best you can do when most of the hits come from reconstructed tracks.

→ R. Forty, NIMA 433 (1999) 257-261

LHCb RICHes: performance

Comparison between:

Run I

Run II (2015)

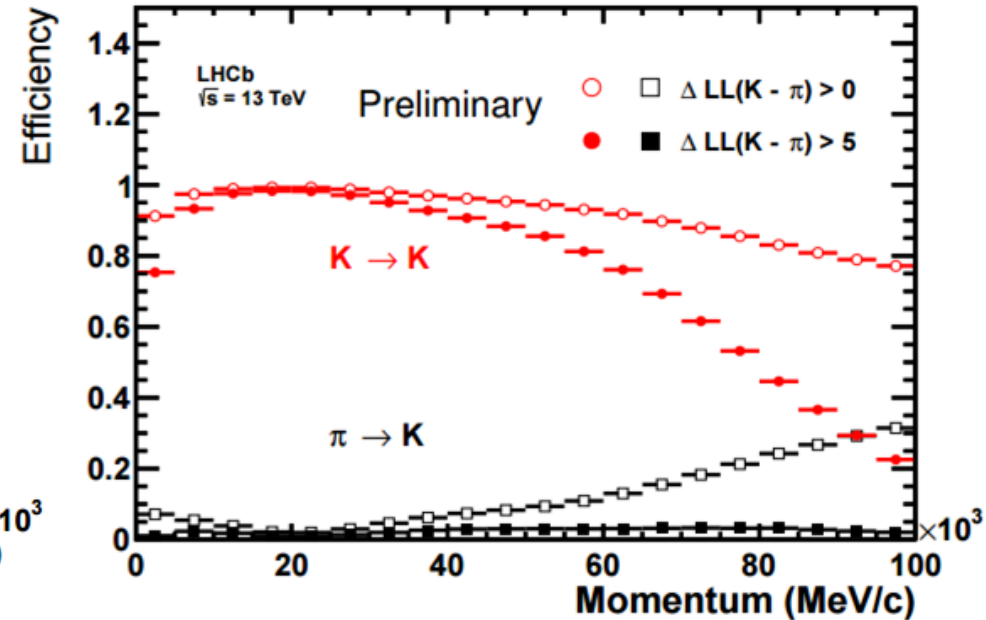
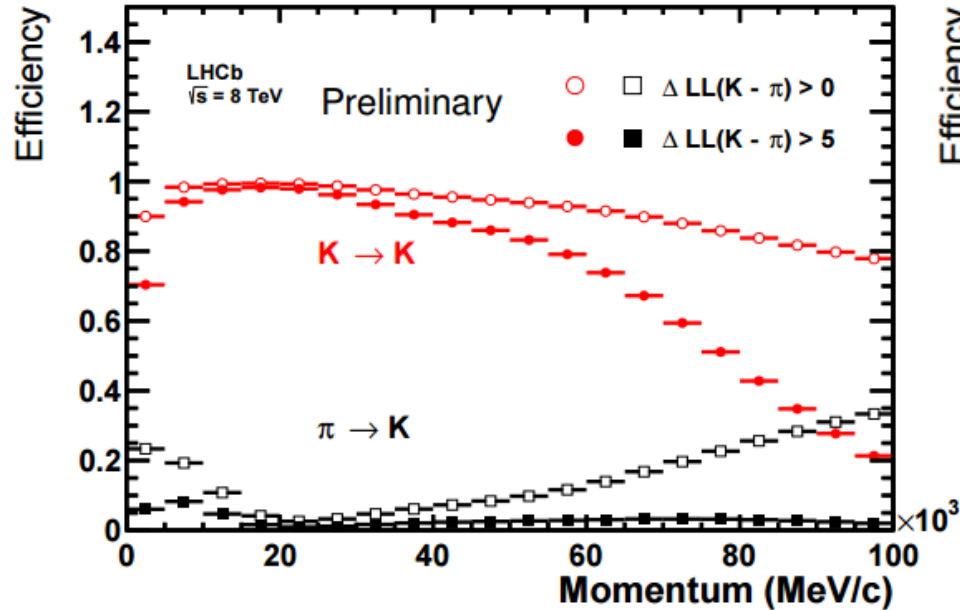

Belle II PID system

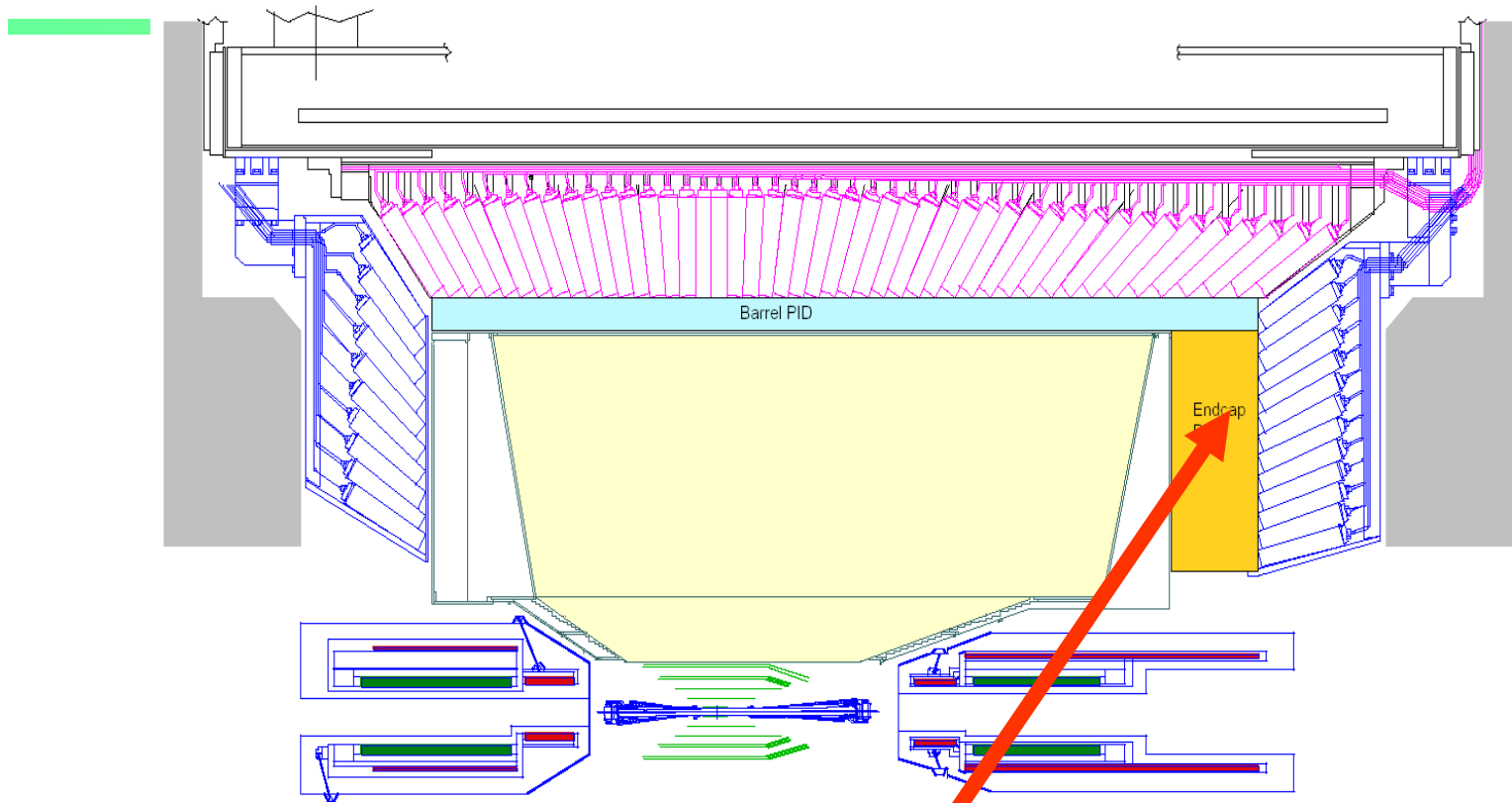

Two new particle ID devices, both RICHes:

Barrel: Time-of-propagation counter (TOP) counter

Endcap: proximity focusing RICH

Aerogel RICH of Belle II

Lower track densities, no overlap of rings
→ track based local likelihood calculation

- reconstructed tracks are extrapolated from the tracking chamber to the ARICH volume.
- construct likelihood function for 6 particle type hypotheses for each track (independently)

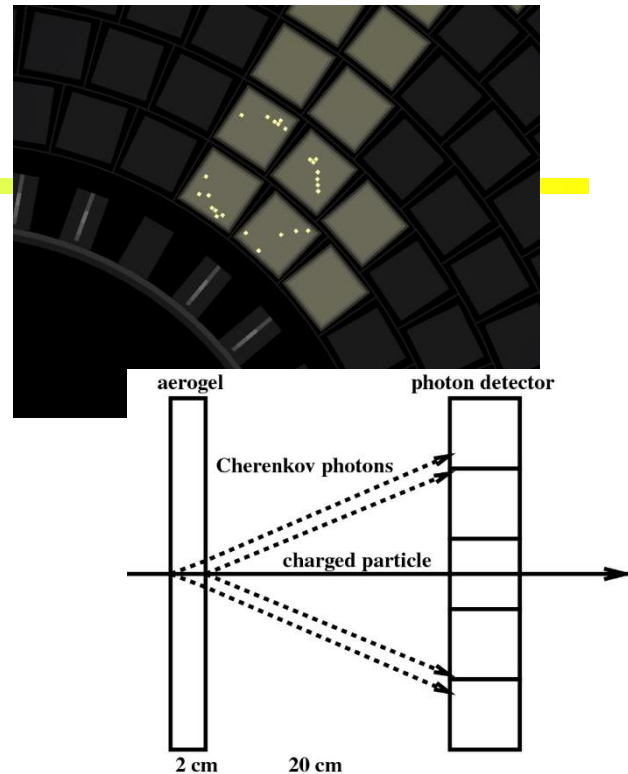

For each particle hypothesis h

$$\ln \mathcal{L}^h = -N^h + \sum_{\text{hit } i} \left[n_i^h + \ln(1 - e^{-n_i^h}) \right]$$

Expected total number of hits

Expected number of hits on pixel i

Radiator with multiple refractive indices

How to increase the number of photons without degrading the resolution?

normal

→ stack two tiles with different refractive indices:
“focusing” configuration

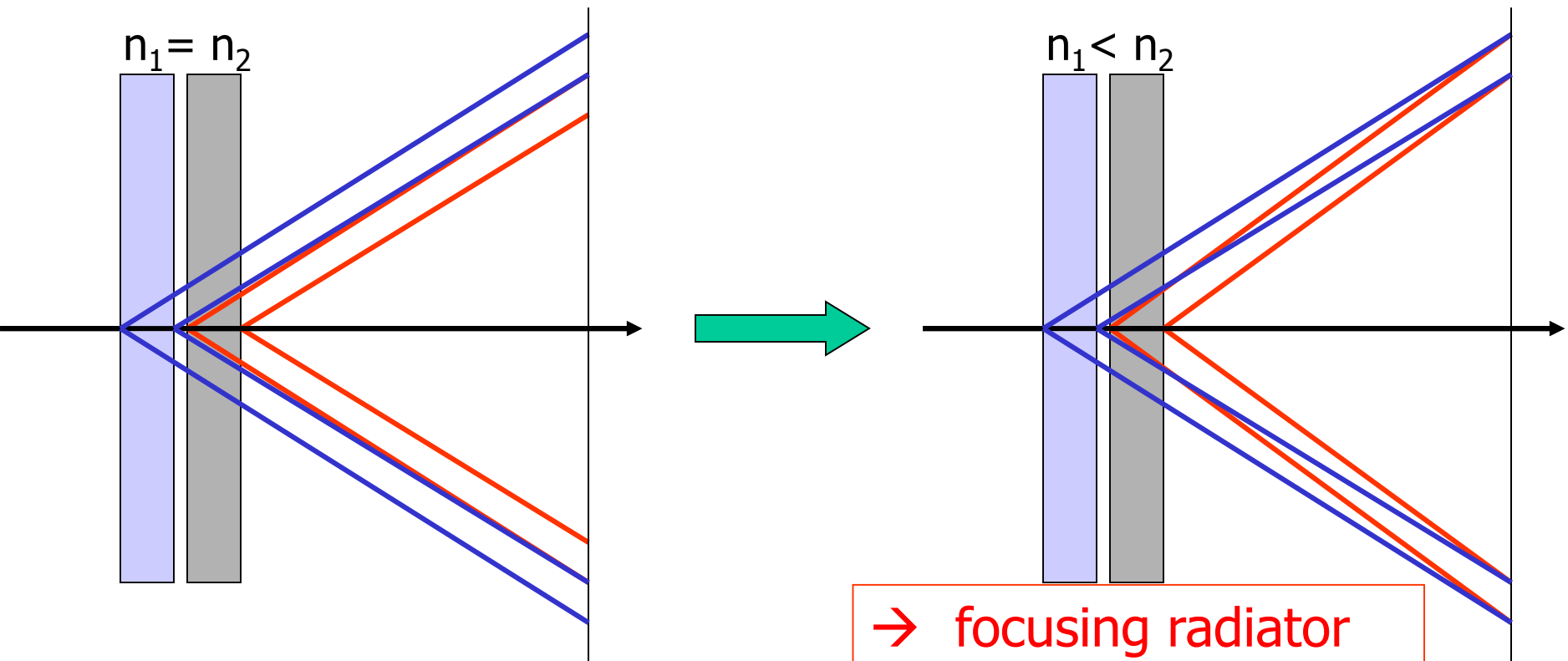

→ focusing radiator

Belle II PID systems – side view

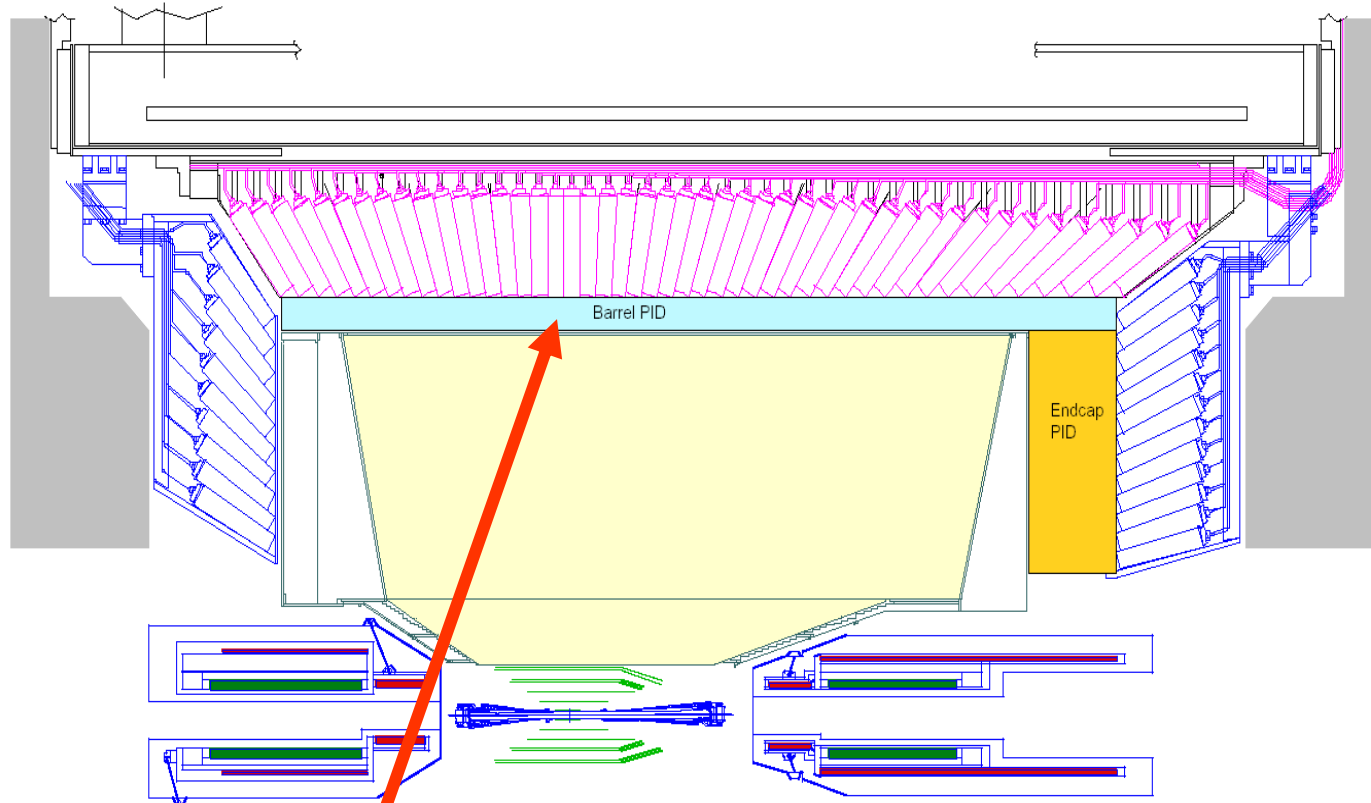

Two new particle ID devices, both RICHes:

Barrel: **time-of-propagation (TOP) counter**

Endcap: **proximity focusing RICH**

Barrel PID: Time of propagation (TOP) counter

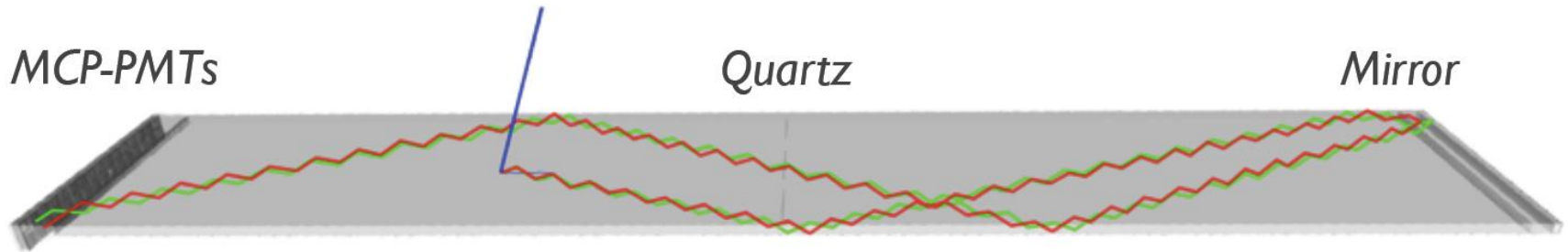

Example of Cherenkov-photon paths for 2 GeV/c π^\pm and K^\pm .

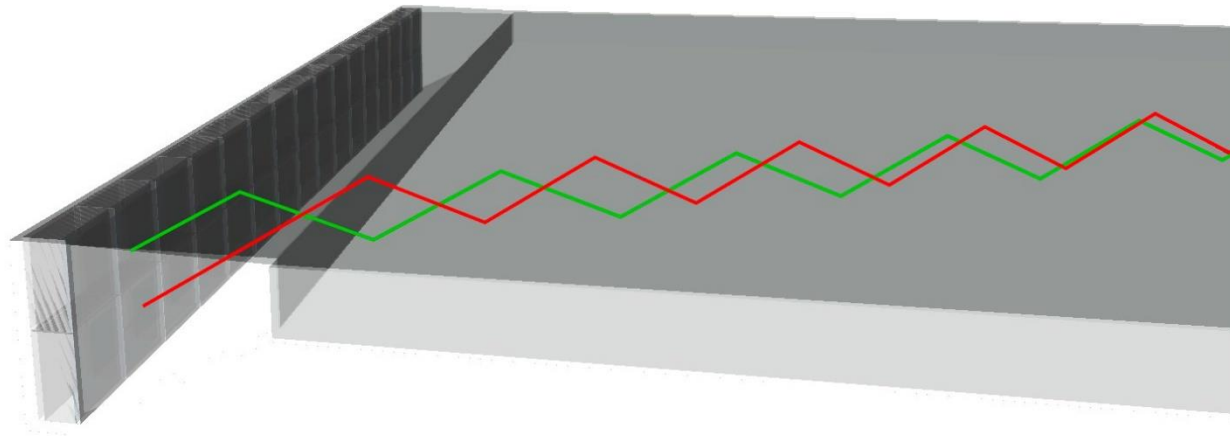

Similar to DIRC, but instead of two coordinates measure:

- One (or two coordinates) with a few mm precision
- Time-of-arrival with excellent time resolution

TOP image

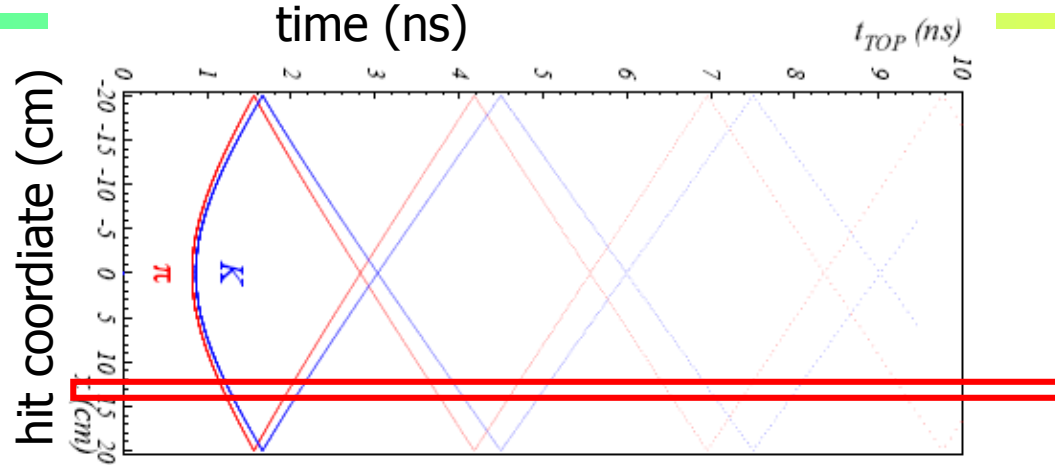

Pattern in the coordinate-time space ('ring') of a pion and kaon hitting a quartz bar

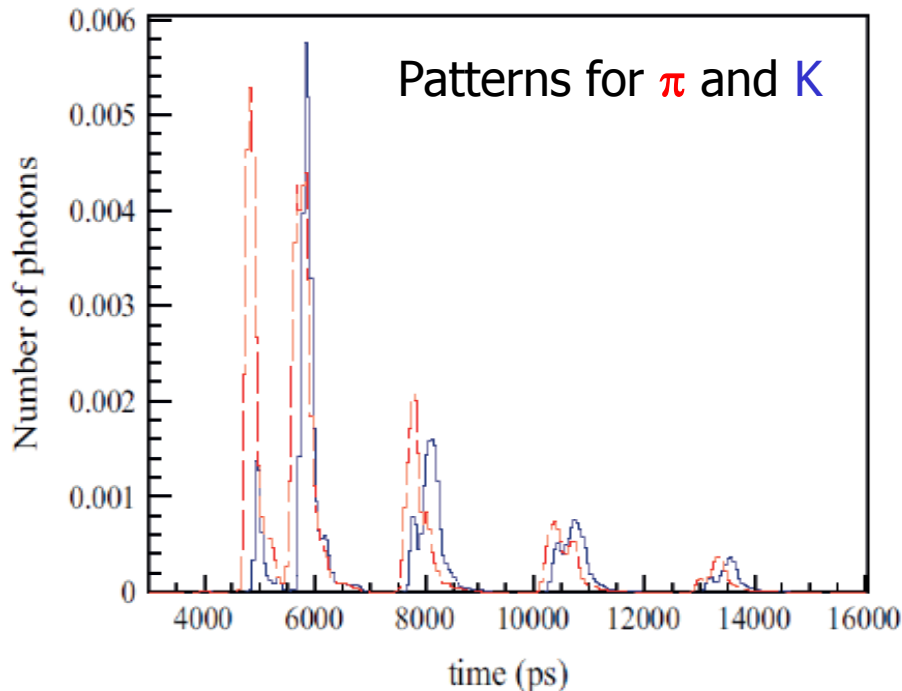

Time distribution of signals recorded by one of the PMT channels: different for π and K (\sim shifted in time)

TOP: likelihood construction

For a given mass hypothesis $h = e, \mu, \pi, K, p$:

$$\log \mathcal{L}_h = \sum_{i=1}^N \log\left(\frac{S_h(x_i, t_i) + B(x_i, t_i)}{N_e}\right) + \log P_N(N_e)$$

- N ... number of detected photons
- $N_e = N_h + N_B$... expected number of photons
- $S_h(x, t)$... signal distribution for mass hypothesis h
- $B(x, t)$... distribution of background photons
- $P_N(N_e)$... Poisson probability of mean N_e to obtain N photons

Distributions normalized as:

$$\sum_{j=1}^{n_{ch}} \int_0^{t_m} S(x_j, t) dt = N_h, \quad \sum_{j=1}^{n_{ch}} \int_0^{t_m} B(x_j, t) dt = N_B$$

TOP: likelihood construction II

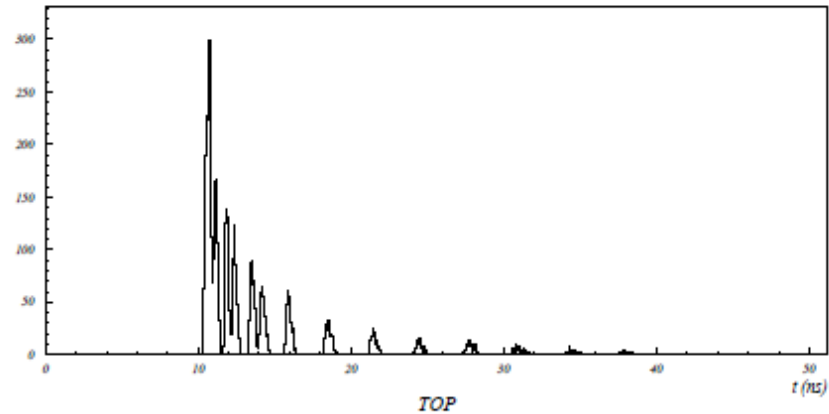
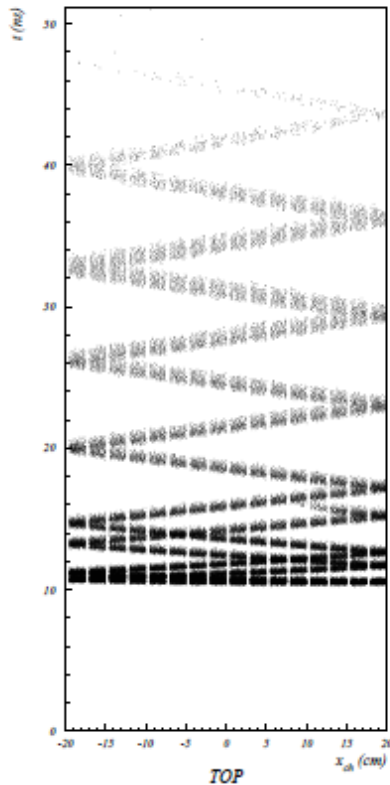

$$S_h(x_j, t) = \sum_{k=1}^{m_j} n_{kj} g(t - t_{kj}; \sigma_{kj})$$

- n_{kj} ... number of photons in the k -th peak
- t_{kj} ... position of the k -th peak
- σ_{kj} ... width of the k -th peak
- $g(t - t_{kj}; \sigma_{kj})$... normalized Gaussian

TOP: likelihood construction III

Time distribution in a single channel

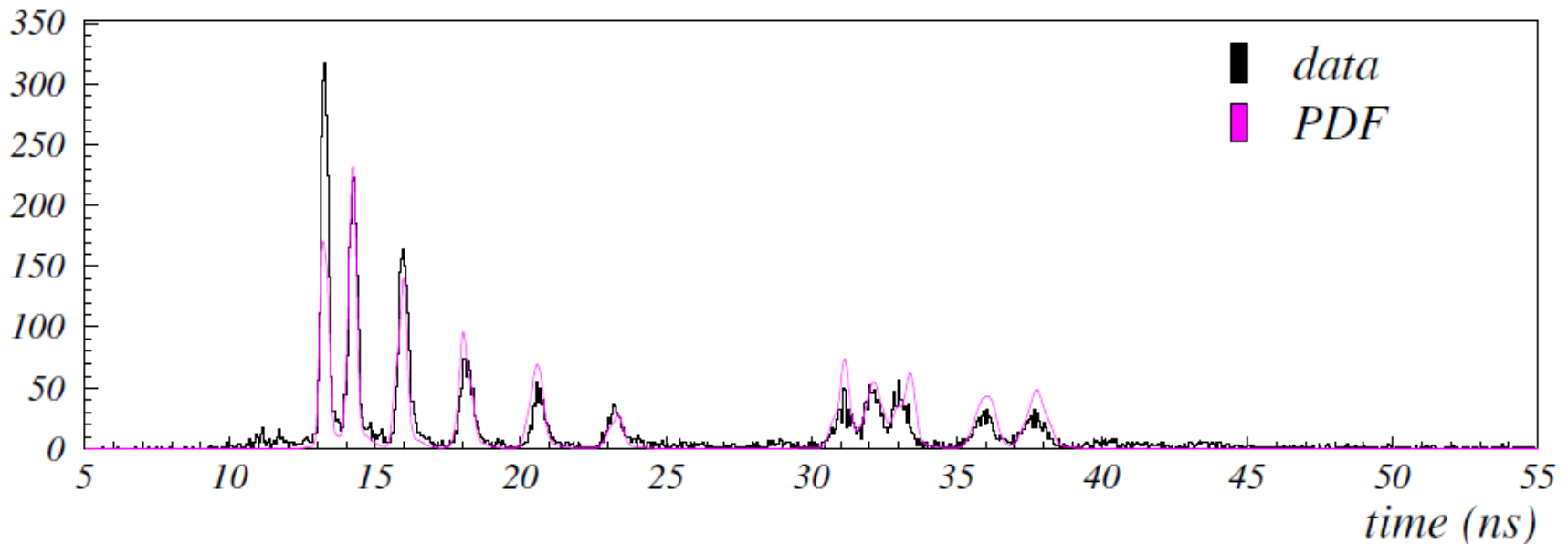

Analytic expression can be derived in spite of the complexity of the problem!

→ M. Starič at RICH2010 (NIM A 639 (2011) 252-255)

This likelihood calculation is also employed in TOP calibration/alignment

Reconstruction: PANDA Disc DIRC

Disc DIRC: Optical concept and analytic photon reconstruction

7 of 30

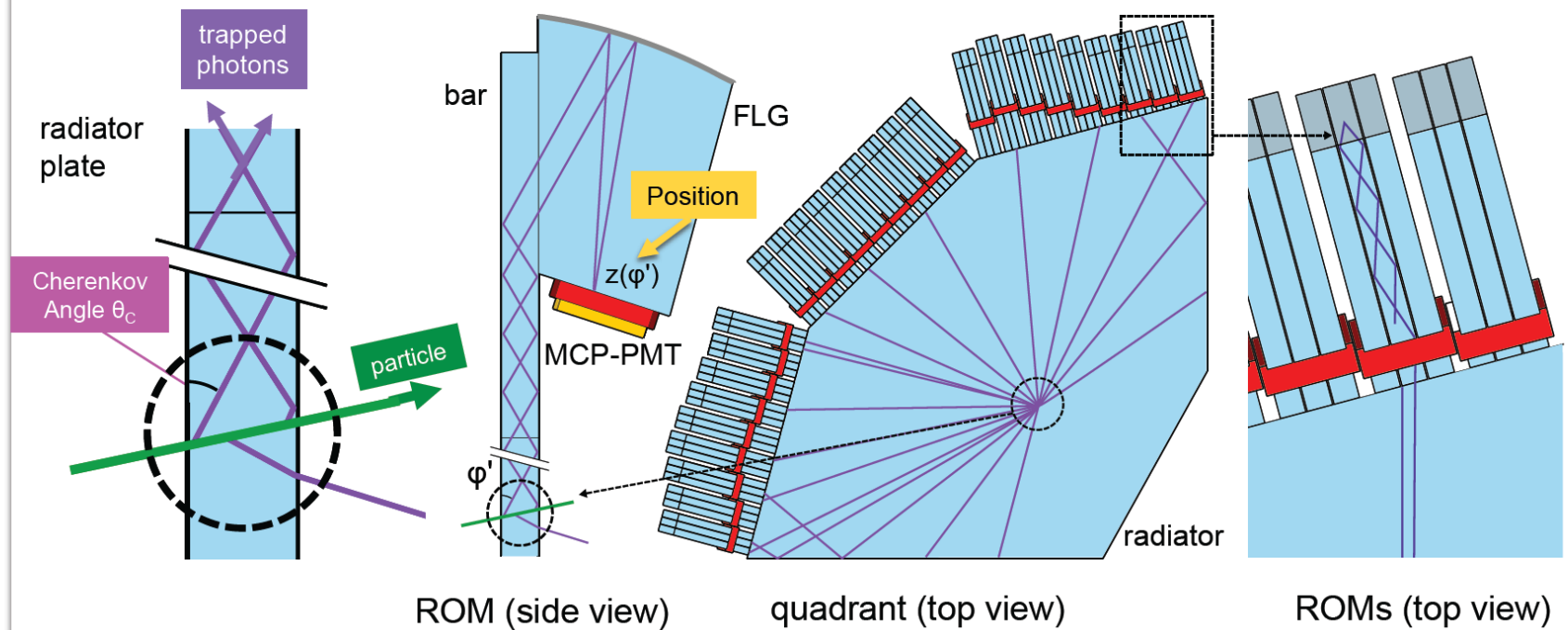

Analytic reconstruction formula:

$$z(\varphi') = z(\varphi, \alpha_{FEL}) = z\left(\arctan\left(\frac{\tan \varphi}{\cos \alpha_{FLG}}\right)\right)$$

Stand-alone ring search

Hough transform: e.g. when looking for saturated rings (unknown parameters x_c , y_c of the ring)

→ used in CBM

Two algorithms (Histogram and Almagest) adopted to running at a GPU farm for triggering in NA62

→ talk by M. Fiorini

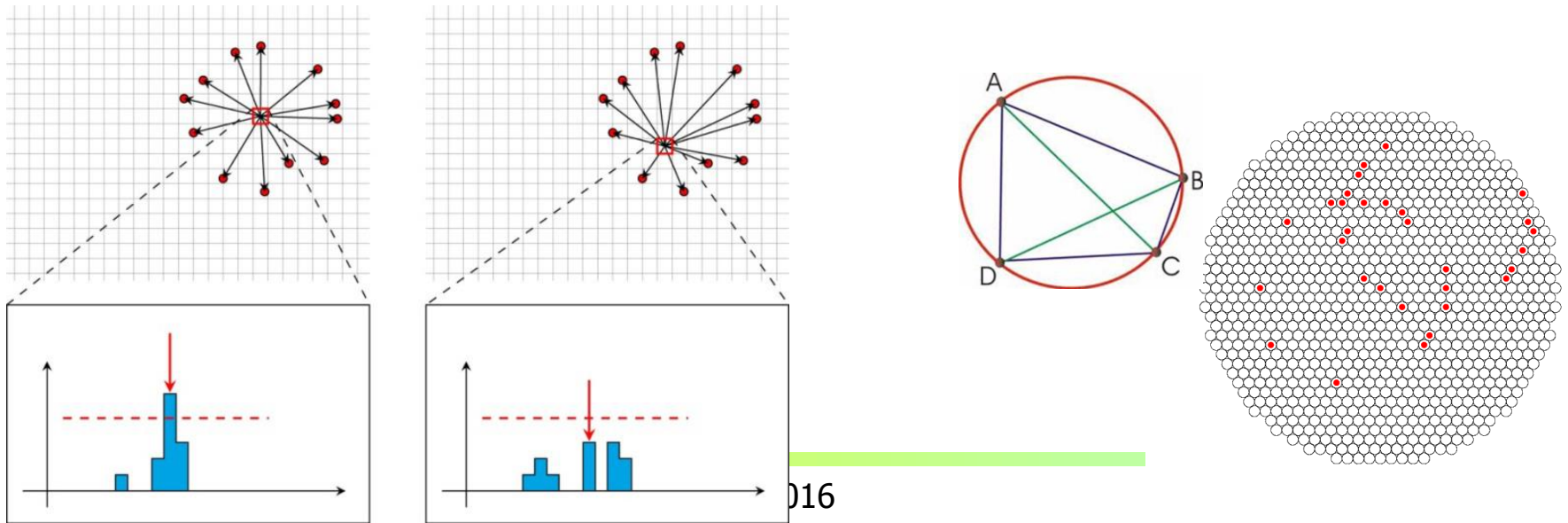

Physics impact

- LHCb
 - NA62
 - ALICE
 - Belle II
 - PANDA
 - GlueX and CLAS12
-
- Neutrino and astroparticle physics experiments: to be covered today and tomorrow

NA62 - Experimental principles

- ❖ Goal \longrightarrow 10% precision Branching Ratio measurement
- ❖ $O(100)$ $K^+ \rightarrow \pi^+ \nu \bar{\nu}$ events in \sim three years of data taking

Very challenging experiment
Weak signal signature

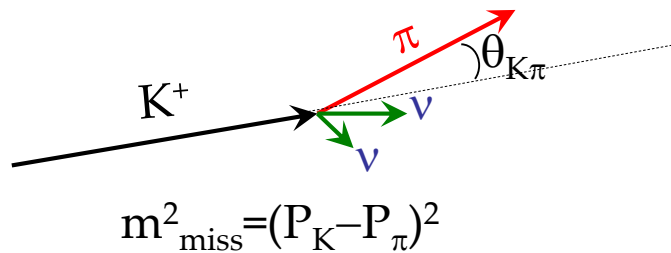

\longrightarrow Statistics

- \triangleright BR(SM) $\sim 8.4 \times 10^{-11}$
- \triangleright Acceptance: 10%
- \triangleright K decays: 10^{13}

Huge background

Decay	BR
$\mu^+ \nu$ ($K_{\mu 2}$)	63.5%
$\pi^+ \pi^0$ ($K_{\pi 2}$)	20.7%
$\pi^+ \pi^+ \pi^-$	5.6%
$\pi^0 e^+ \nu$ ($K_{e 3}$)	5.1%
$\pi^0 \mu^+ \nu$ ($K_{\mu 3}$)	3.3%

- ❖ Main background:

$K^+ \rightarrow \mu^+ \nu$ ($K_{\mu 2}$) BR = 63.4%

- ❖ Rejection factor at least 10^{-12}

- ❖ Kinematics : $10^{-4} \div 10^{-5}$

- ❖ Veto for muons $\sim 10^{-5}$

- ❖ Particle Identification:

μ suppression $< 10^{-2}$

\longrightarrow RICH

ALICE: PID performance on pp $\sqrt{s} = 13$ TeV and Pb-Pb $\sqrt{s_{NN}} = 5.02$ TeV

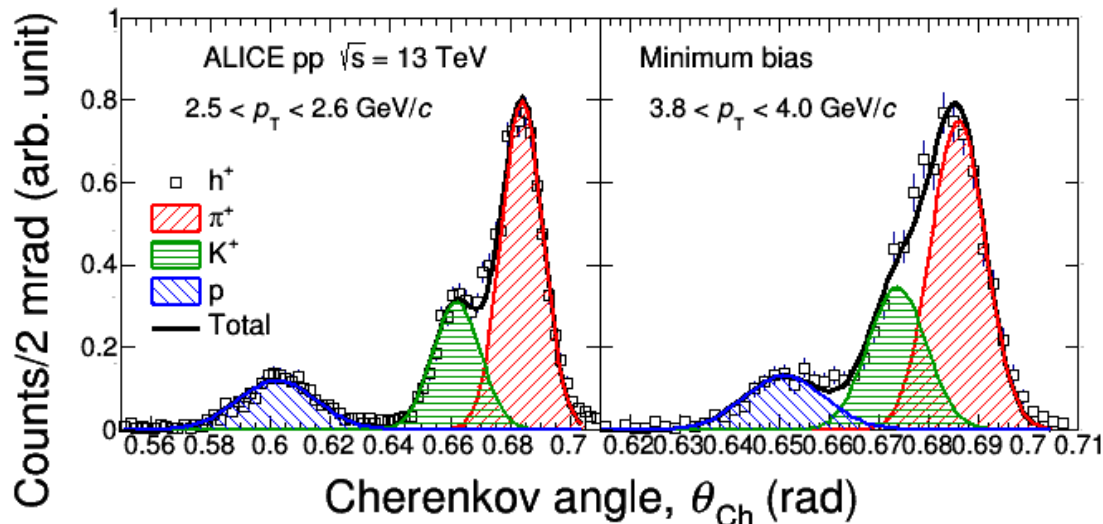
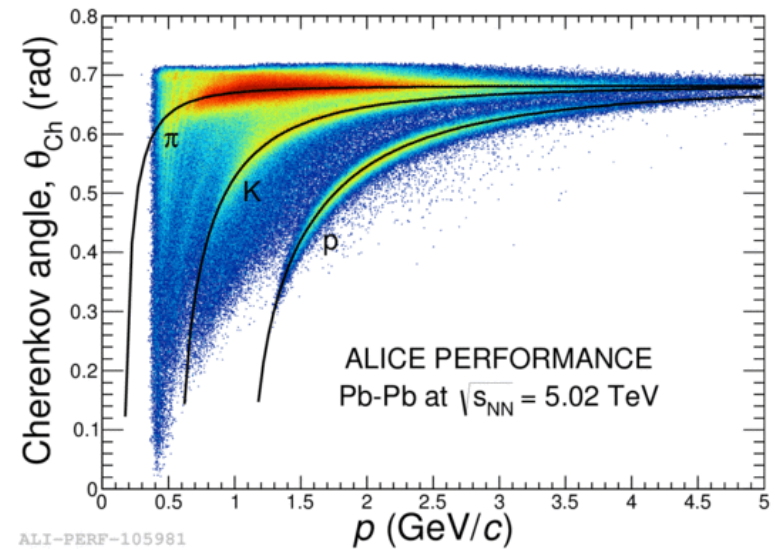
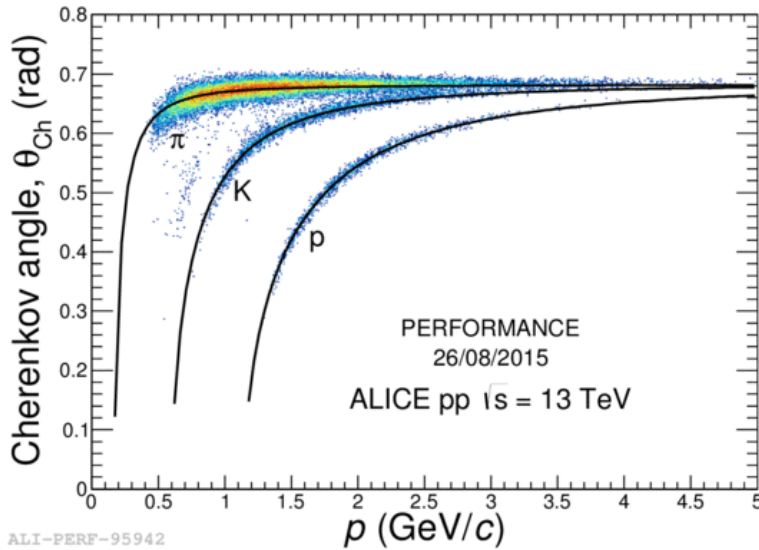

→ Talks by De Cataldo, G. Volpe

RICH detectors in LHCb

RICHes at LHCb are an absolutely vital part of the experiment.

Incredible harvest over the last few years, impossible to summarize all – so just a few examples, where RICHes are clearly indispensable

- Angle $\gamma \setminus \phi_3$
- Two-body charmless decays

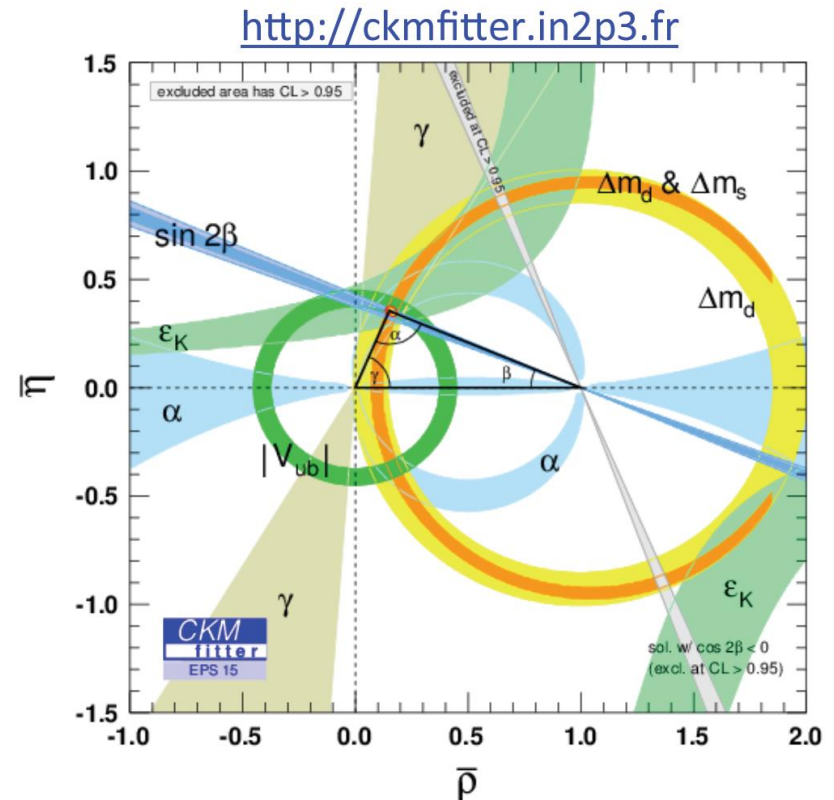

Experimental status for γ

- New combination of all available measurements from LHCb

LHCb measurements used in the combination

B decay	D decay	Method
$B^+ \rightarrow Dh^+$	$D \rightarrow h^+h^-$	GLW/ADS
$B^+ \rightarrow Dh^+$	$D \rightarrow h^+\pi^-\pi^+\pi^-$	GLW/ADS
$B^+ \rightarrow Dh^+$	$D \rightarrow h^+h^-\pi^0$	GLW/ADS
$B^+ \rightarrow DK^+$	$D \rightarrow K_s^0 h^+h^-$	GGSZ
$B^+ \rightarrow DK^+$	$D \rightarrow K_s^0 K^+\pi^-$	GLS
$B^+ \rightarrow Dh^+\pi^-\pi^+$	$D \rightarrow h^+h^-$	GLW/ADS
$B^0 \rightarrow DK^{*0}$	$D \rightarrow K^+\pi^-$	ADS
$B^0 \rightarrow DK^+\pi^-$	$D \rightarrow h^+h^-$	GLW-Dalitz
$B^0 \rightarrow DK^{*0}$	$D \rightarrow K_s^0 \pi^+\pi^-$	GGSZ
$B_s^0 \rightarrow D_s^\mp K^\pm$	$D_s^+ \rightarrow h^+h^-\pi^+$	TD

- Significantly more precise than previous results from the B -factories and the Tevatron

Phys. Rev. D87 (2013) 052015

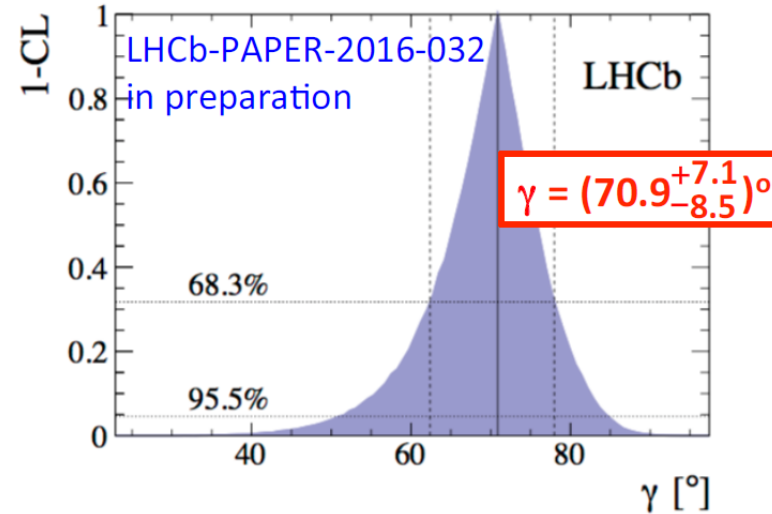
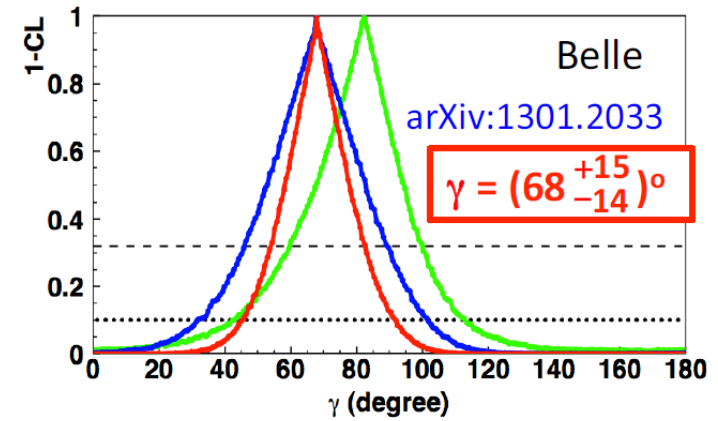
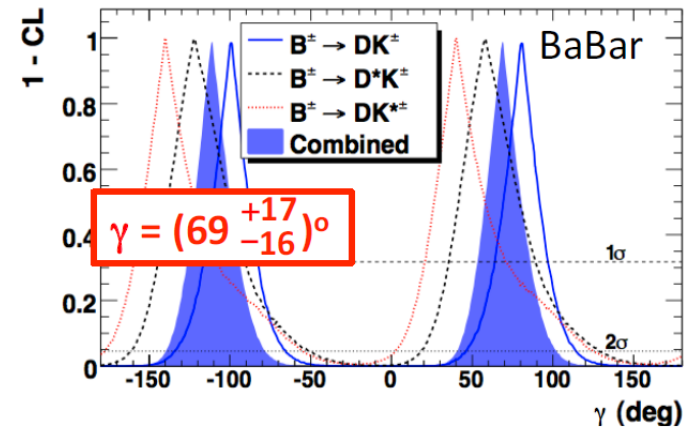

Charmless two-body B decays

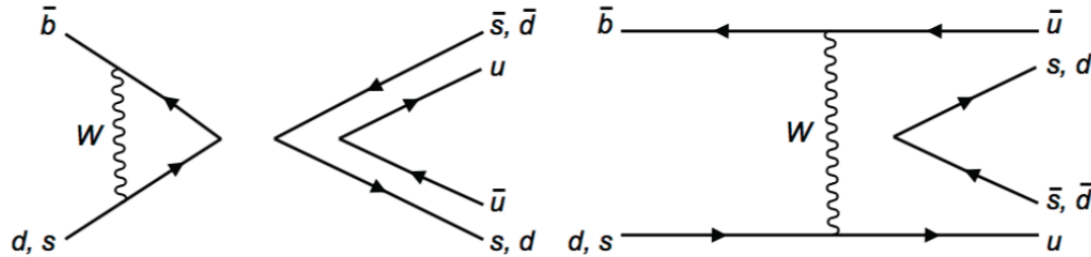

- Particular class of decays that can proceed only through so-called annihilation diagrams
 - Very useful to test QCD calculations
- $B^0 \rightarrow K^+ K^-$ decay observed for the first time after many years of searches
 - Significance 5.8σ

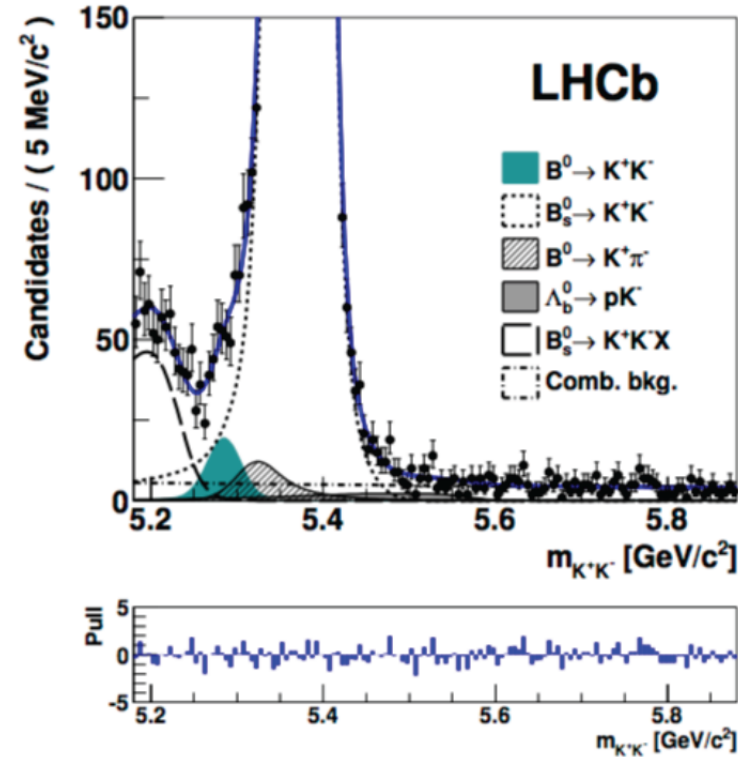

$$\mathcal{B}(B^0 \rightarrow K^+ K^-) = (7.80 \pm 1.27 \pm 0.81 \pm 0.21) \times 10^{-8}$$

$$\mathcal{B}(B_s^0 \rightarrow \pi^+ \pi^-) = (6.91 \pm 0.54 \pm 0.63 \pm 0.19 \pm 0.40) \times 10^{-7}$$

V. Vagnoni at ICHEP 2016.

- The $B^0 \rightarrow K^+ K^-$ is the rarest B -meson decay into a fully hadronic final state ever observed

RICHes at Belle II

Again, without RICHes there is very little you can do in Belle II.

Most important: of course the pion-kaon separation up to 4 GeV/c to cover

- Few body charmless decays
- Measure $B \rightarrow \rho \gamma$ and discriminate it against $B \rightarrow K^* \gamma$
- Identify tagging kaons
- Identify low momentum muons and electrons

Hot topic: $B \rightarrow D^{(*)}\tau\nu$ decays

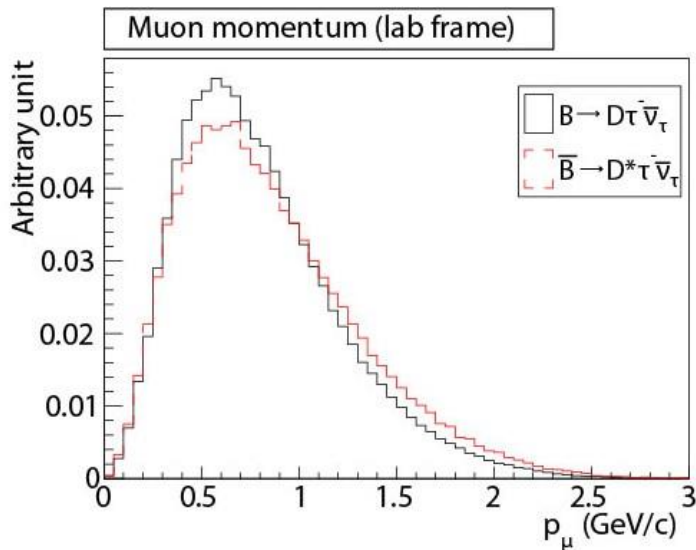

...where $\tau \rightarrow \mu\nu\nu$

→ At Belle II, a sizable fraction of muons is soft, not covered by the muon detection system

→ Identify them in a Cherenkov counter, π/μ Cher. angle difference at 0.5 GeV/c is similar as for K/π at 3 GeV/c

Example: single Cher. photons from π, μ, e in the aerogel RICH at a 0.5 GeV/c test beam; better for full rings →

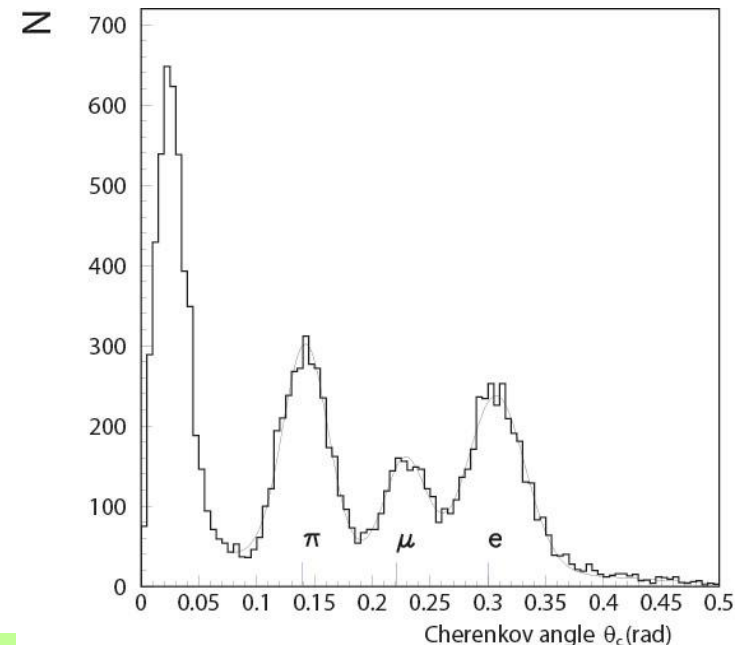

Muon identification performance in a B factory / Super B factory

Standard method: RPCs in the return yoke, efficient for $p > 0.7$ GeV/c

efficiency

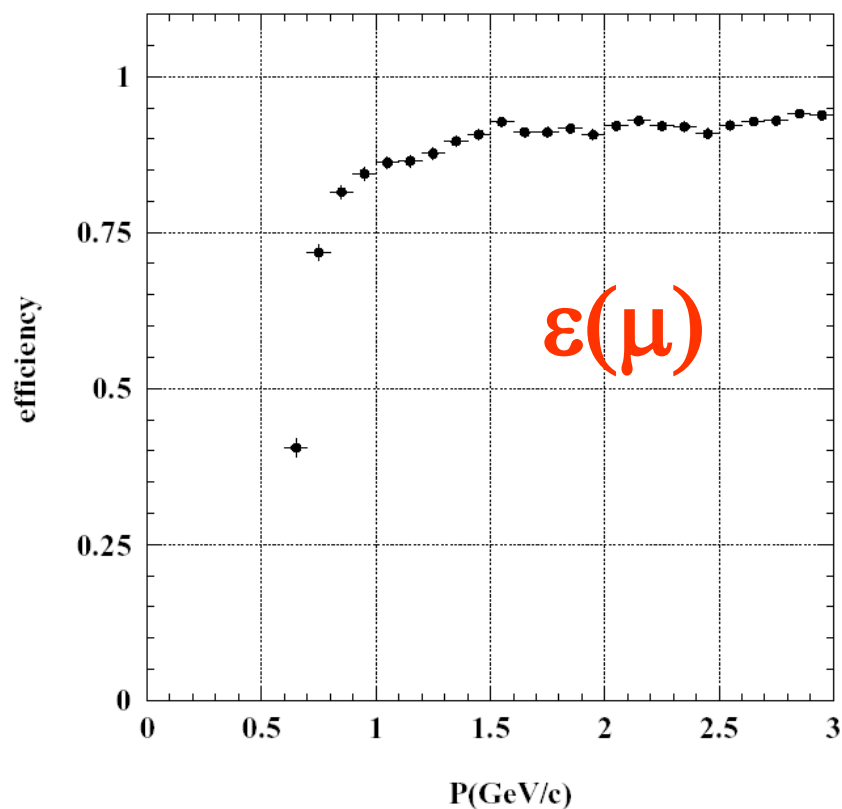

Fig. 109. Muon detection efficiency vs. momentum in KLM.

fake probability

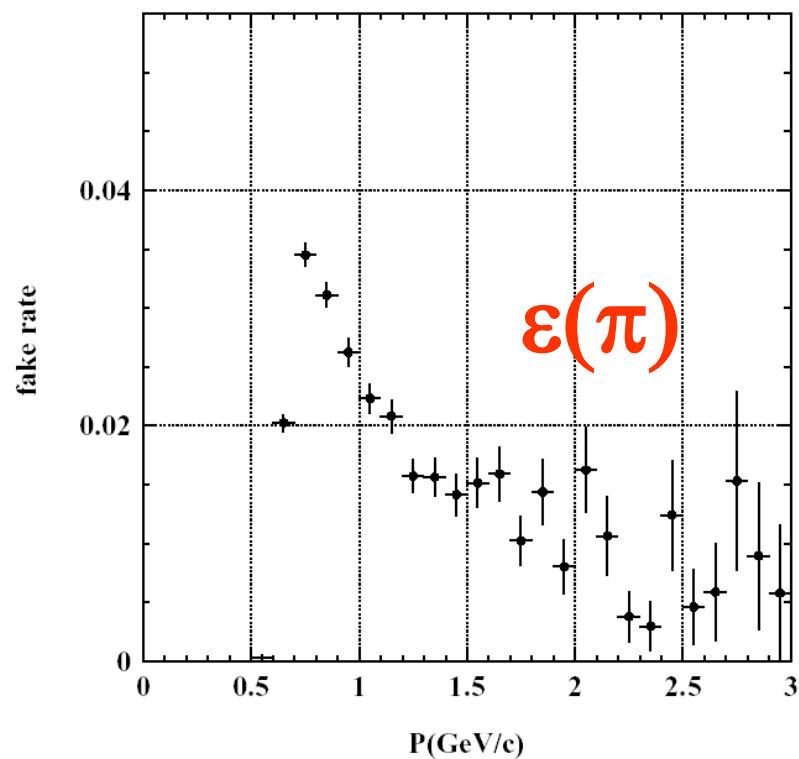

Fig. 110. Fake rate vs. momentum in KLM.

PANDA: two DIRC detectors for hadronic PID

- Barrel DIRC

German in-kind contribution to PANDA

Goal: 3 s.d. π/K separation up to 3.5 GeV/c

- Endcap Disc DIRC

➤ M. Dueren, Mon 16:45

Goal: 4 s.d. π/K separation up to 4 GeV/c

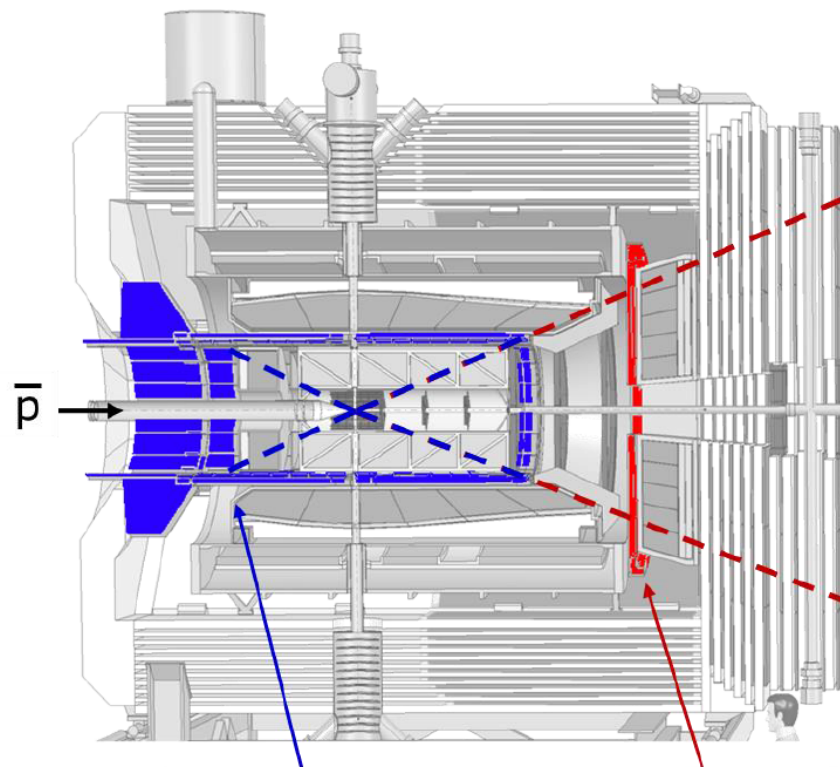

Barrel DIRC
(22° - 140°)

Endcap Disc DIRC
(5° - 22°)

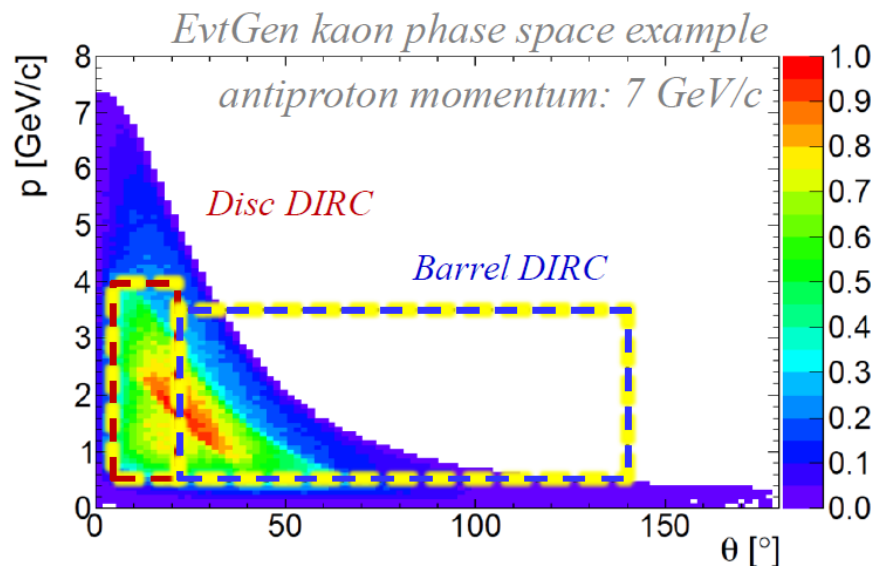

PANDA is back on track;
installation to start in 2021.

➔ Talk by J. Schwiening

GlueX: complement TOF from 2 GeV/c up to 4 GeV/c

GlueX DIRC design

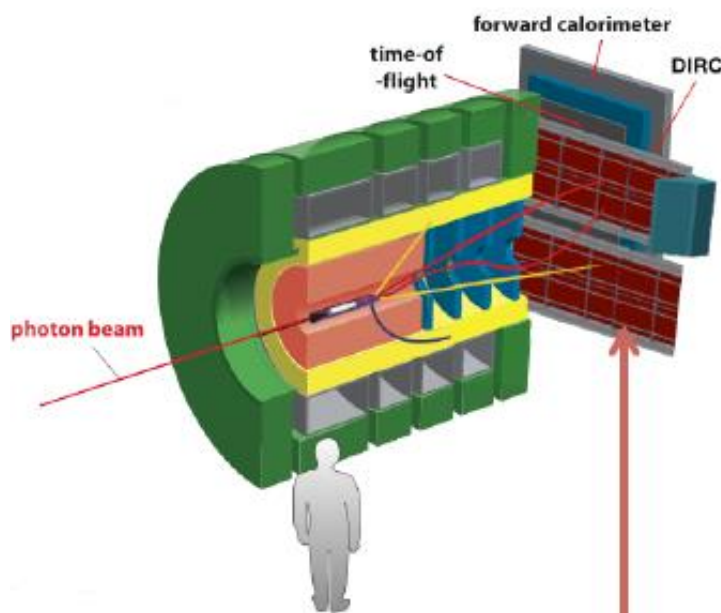

Forward wall made of four unaltered BaBar DIRC bar boxes

Two separate photon cameras each couples to two BaBar bar boxes

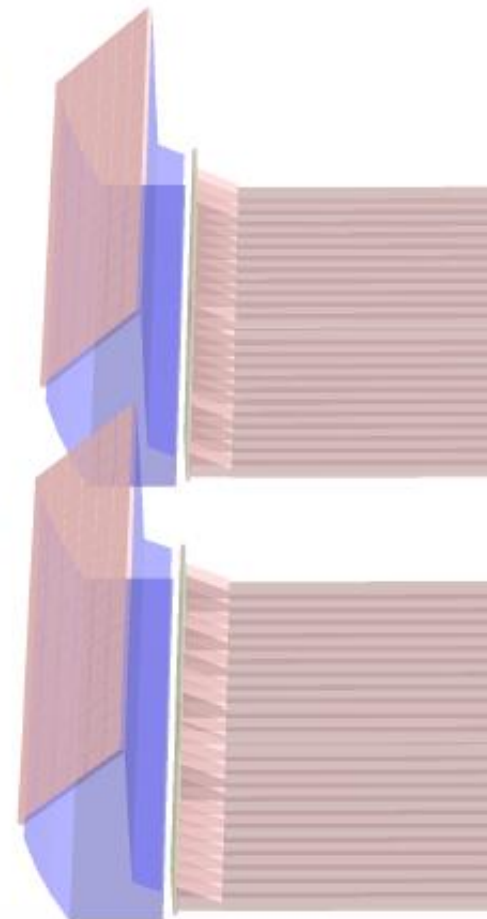
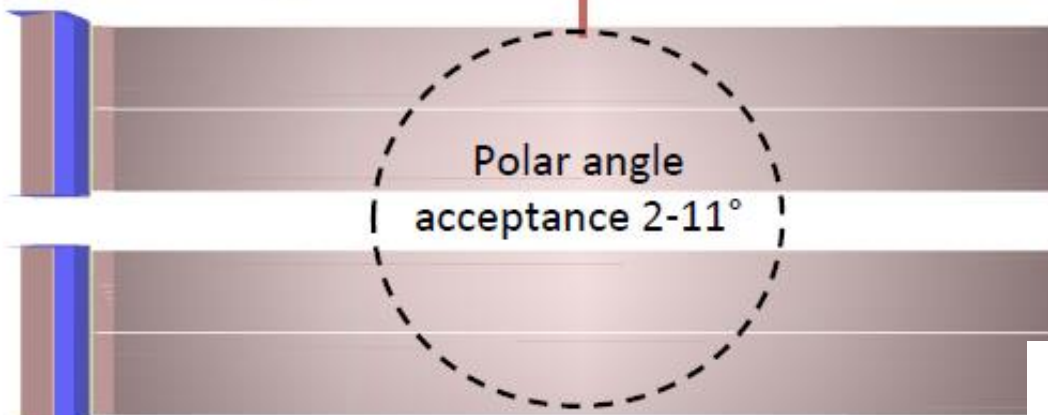

Summary

Particle identification is an essential part of several experiments, and has contributed substantially to our present understanding of elementary particles and their interactions, and will continue to have an important impact in searches for new physics.

A large variety of Cherenkov radiation based techniques has been developed for different kinematic regions and different particles.

Novel analysis methods are becoming available, and are expected to further boost the performance of Cherenkov radiation based detectors.

We are looking forward to hearing more about the progress and impact of Cherenkov detection methods in neutrino and astroparticle physics experiments in the coming two days.

Back-up slides

- ❖ Measurements: hits in the RICH, reconstructed tracks
 - ▷ Čerenkov angles θ_i of pairs (hit, track)
 - ▷ right and wrong combinations
 - ▷ distribution (1D) of θ_i for a given track:
 - peak (right combinations) above background (wrong combinations).
 - ▷ search for the peak in the θ_i distribution ($\theta_i < \theta_m$)
- ❖ The peak is searched by maximizing unbinned log likelihood of the form:

$$\log L(\theta) = \sum_{i=1}^{N_{ph}} \log \left(p(\theta) \frac{1}{\sqrt{2\pi}\sigma_i} e^{-\frac{(\theta_i - \theta)^2}{2\sigma_i^2}} + (1 - p(\theta)) \frac{2}{\theta_m^2} \theta_i \right)$$

where

$$p(\theta) = \frac{N(\theta)}{N_{ph}}, \quad N(\theta) = A_{geo} N_0 l \theta^2$$

and σ_i is the resolution of single photon Čerenkov angle (incl. RICH and track)

- ❖ If the peak is found, its “significance” is calculated:

$$\log L_{sign} = \log P_{N_{ph}}(N(\theta) + N_{bgr}) - \log P_{N_{ph}}(N_{bgr})$$

- ▷ the number of background photons inside the signal window N_{bgr} is estimated from side bands.

Track based ring search - performance

- ◆ Efficiency and mass resolution for protons (real data)
- ◆ Protons from reconstructed $\Lambda \rightarrow p\pi^-$ decays used
- ◆ Significance cut: $\log L_{sign} > 4$

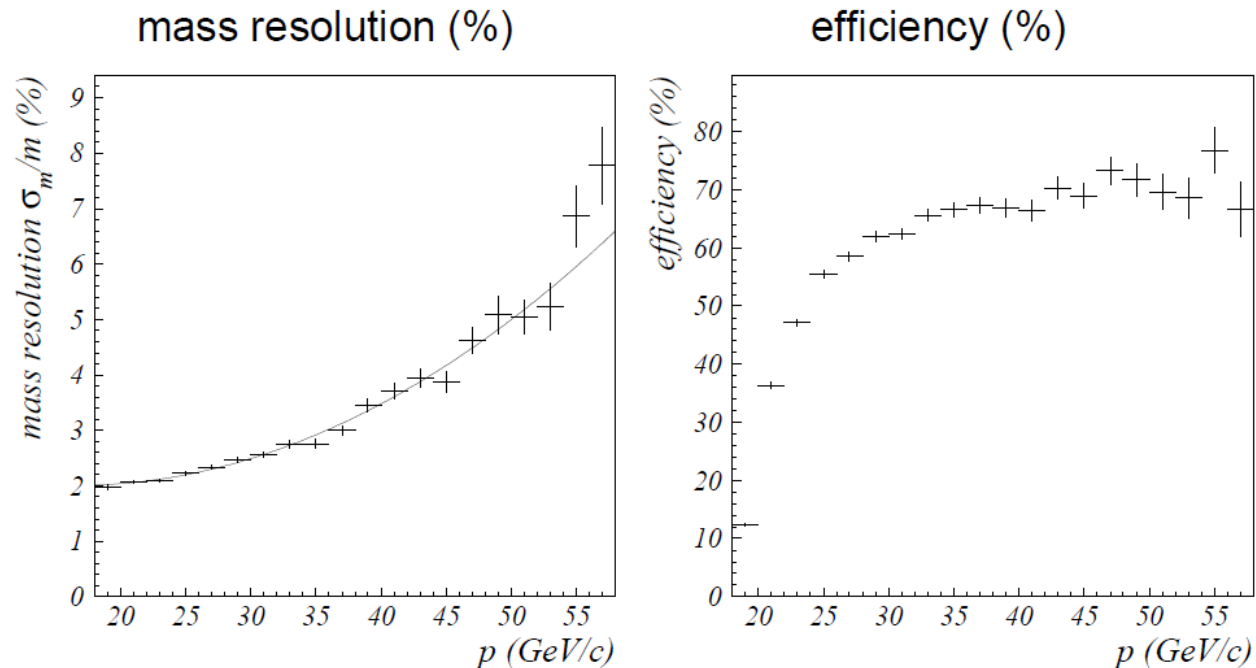

Track based ring search – example: exclude pion, kaon and proton hypotheses

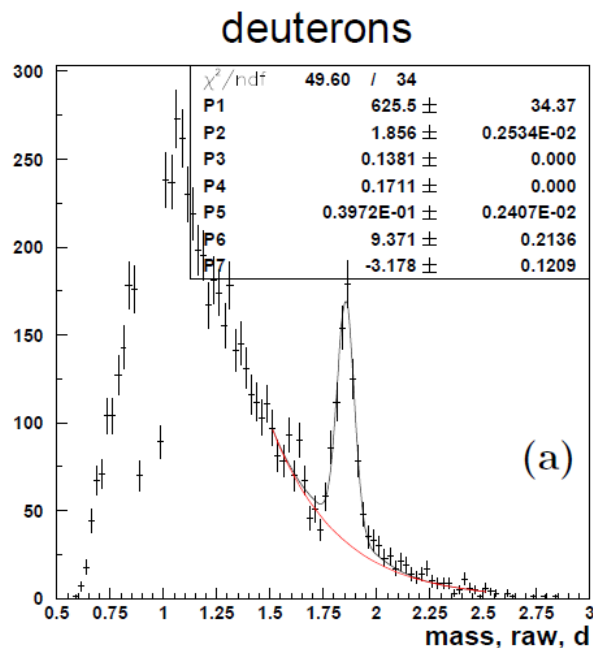

$$N_d = 626$$

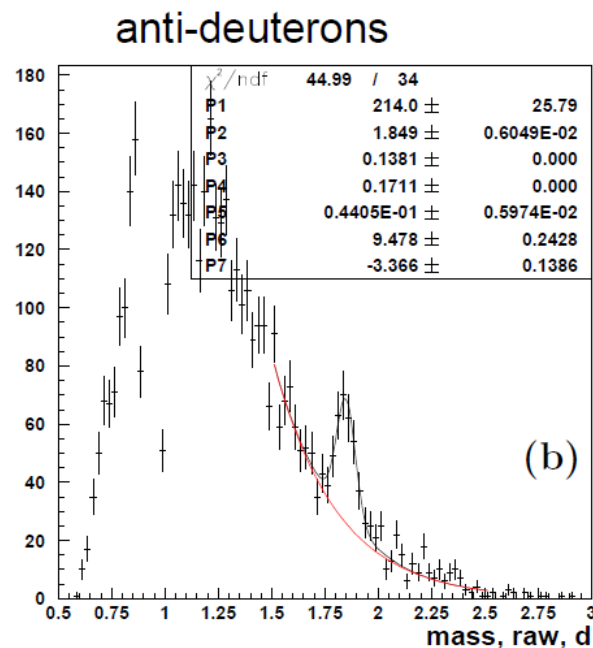

$$N_{\bar{d}} = 214$$

◆ Measurements to be published:

- ▷ Coalescence parameter B_2 for d and \bar{d}
- ▷ d/\bar{d} cross section ratio
- ▷ A dependence of d and \bar{d} production

Iterative analysis

- Assign weights to photon-track pairs according to the histograms of hits.
- Iterate.

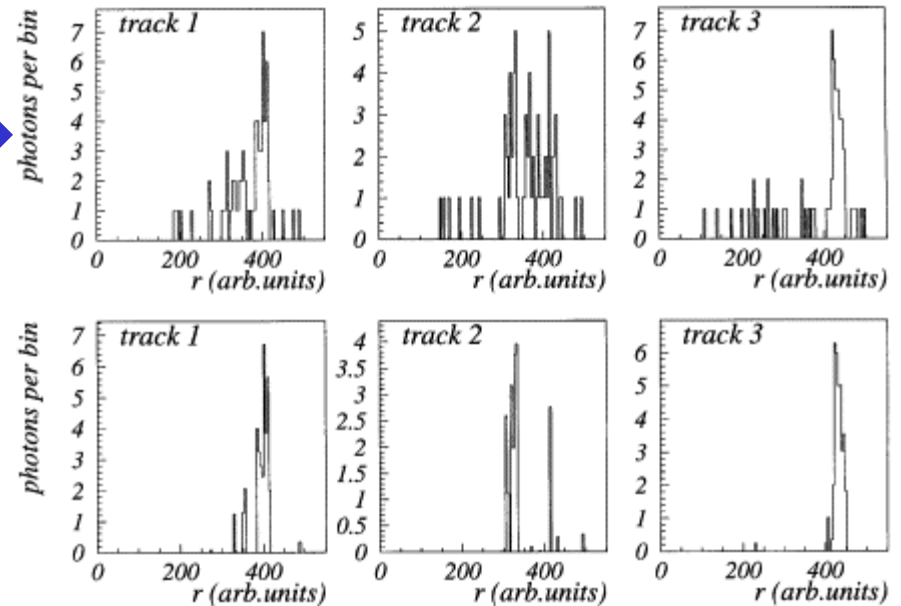
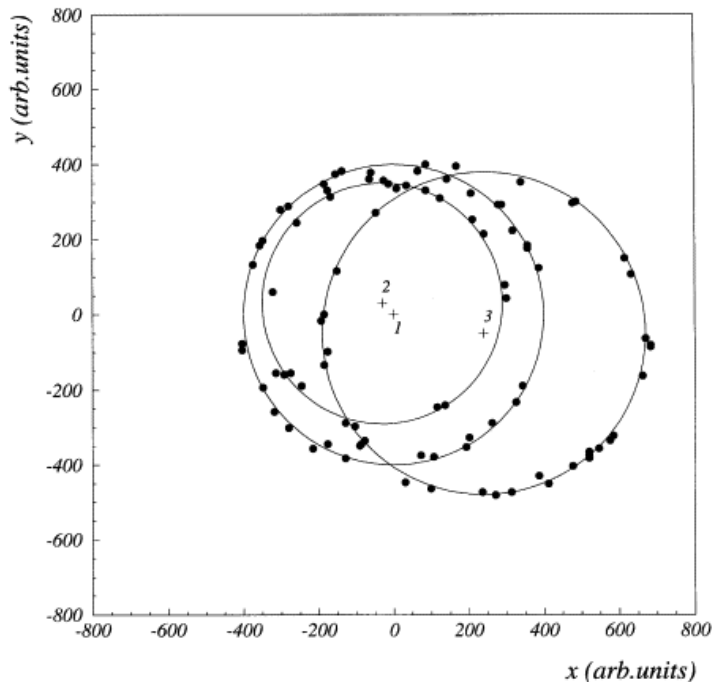

Threshold Cherenkov counter

$\cos\theta = c/nv = 1/\beta n$ → Separate **K** (below threshold) from π (above) by properly choosing **n**

Photon yield vs p

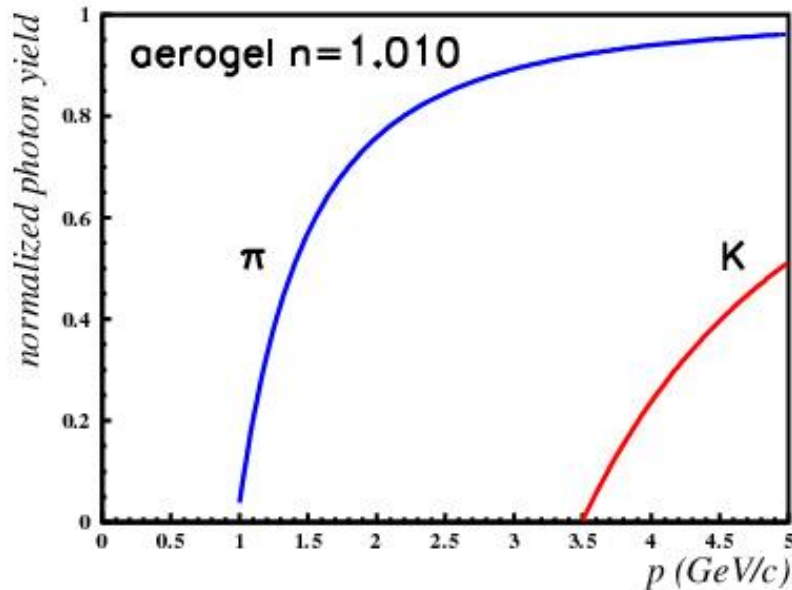

Choice of n: depends on the momentum range.

→ Good separation between pions (light) and kaons (no light) between ~ 1.5 GeV/c and 3.5 GeV/c

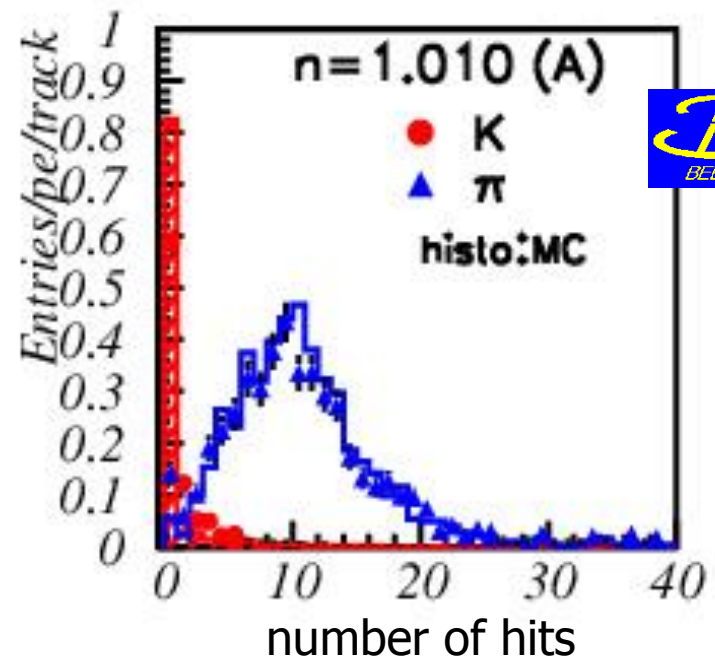

Belle: Threshold Cherenkov counter, ACC (aerogel Cherenkov counter)

K (below threshold) vs. π (above) by properly choosing n for a given kinematic region

→ more energetic particles fly in the 'forward region' → lower n

Detector unit: a block of aerogel and two fine-mesh PMTs

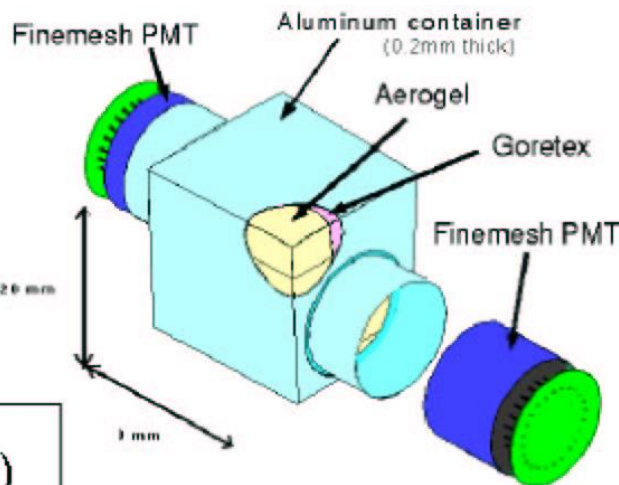
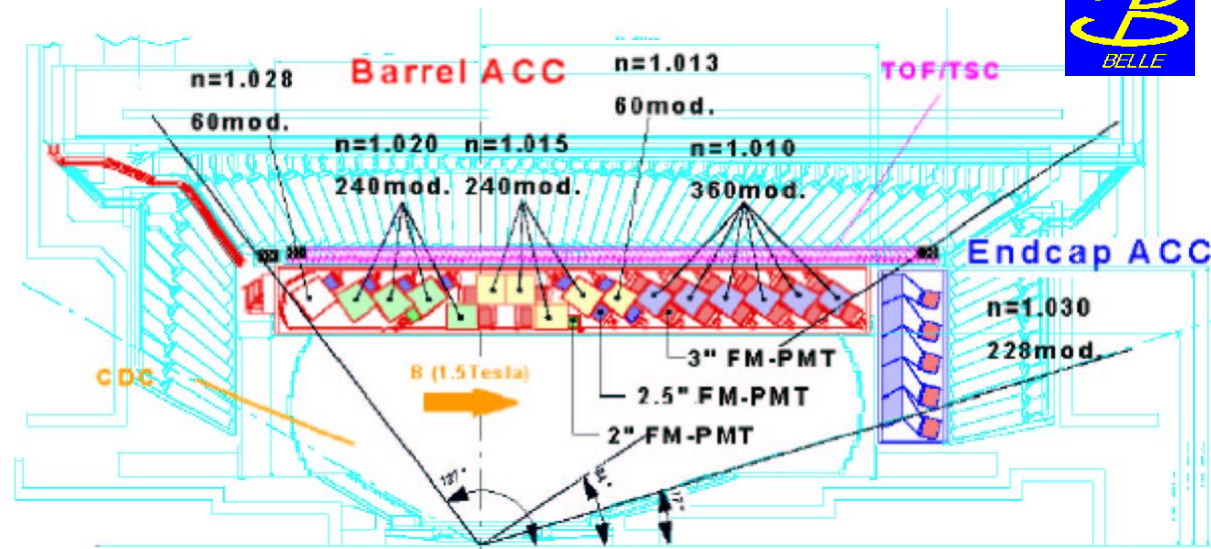

Fine-mesh PMT: works in high B fields (1.5 T)

Measuring Cherenkov angle

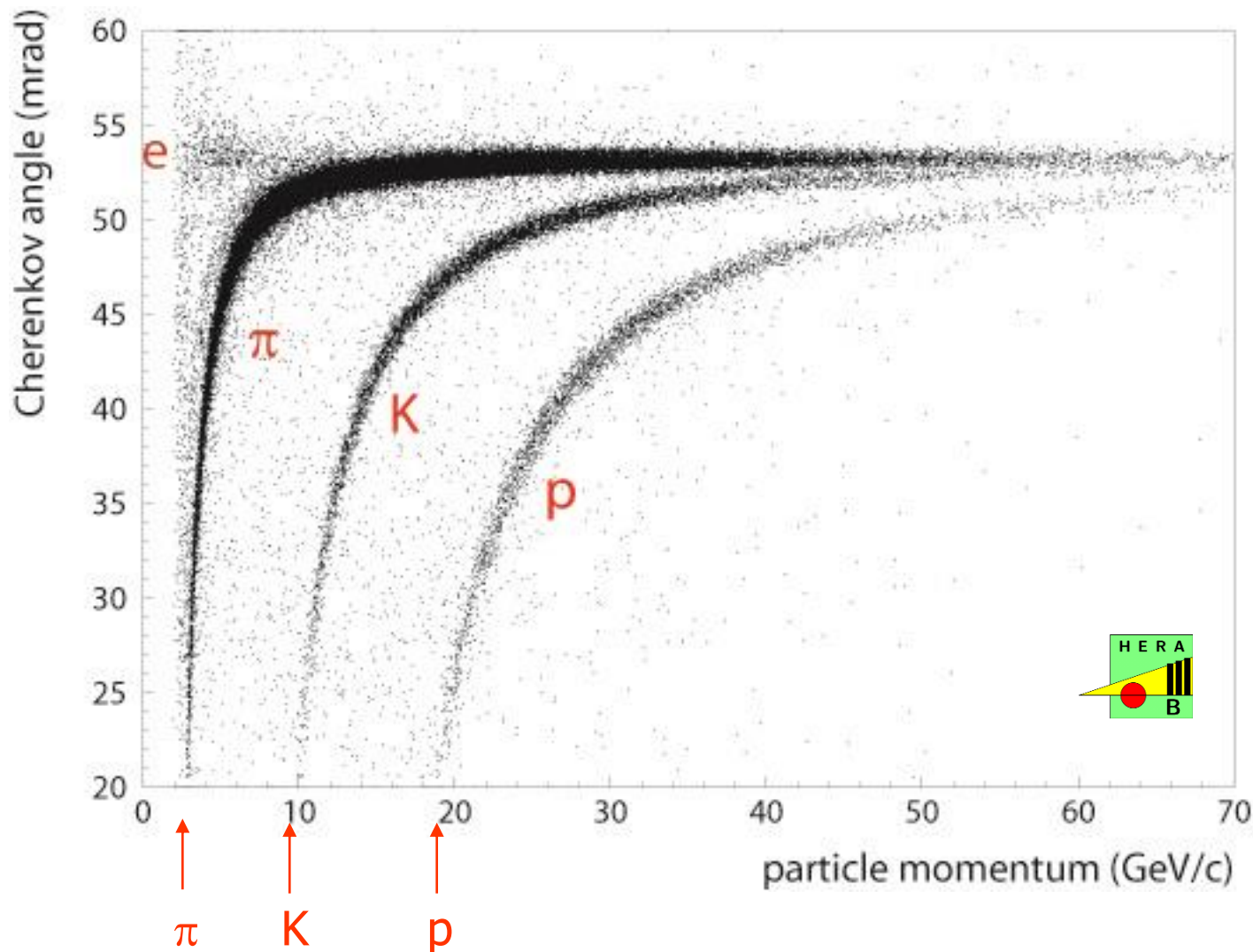

Radiator:
 C_4F_{10} gas

HERA-B RICH

← Little noise, ~30 photons per ring

Typical event →

Worked very well!

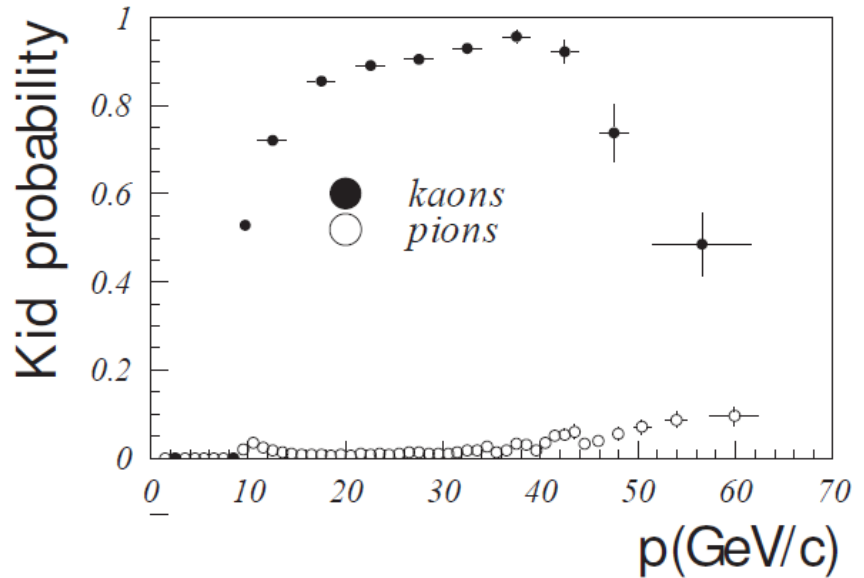
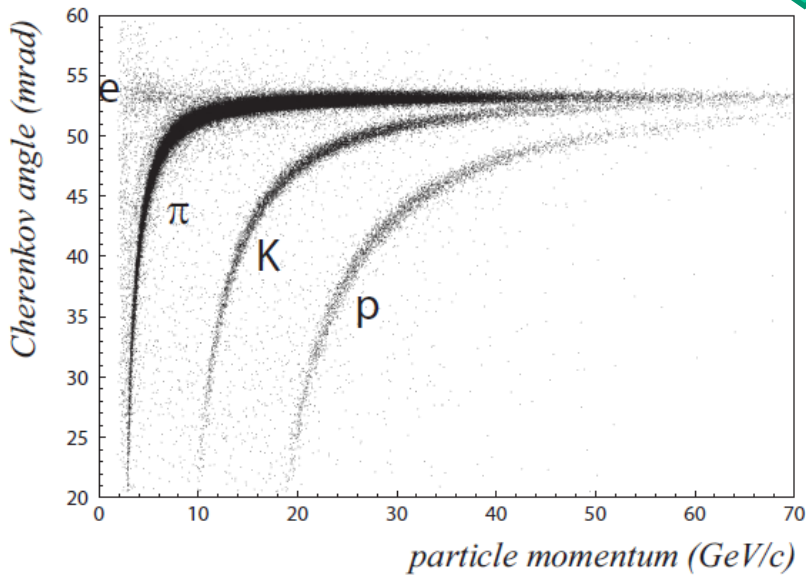

Kaon efficiency and pion fake probability

Belle → Belle II

B factory → Super B factory

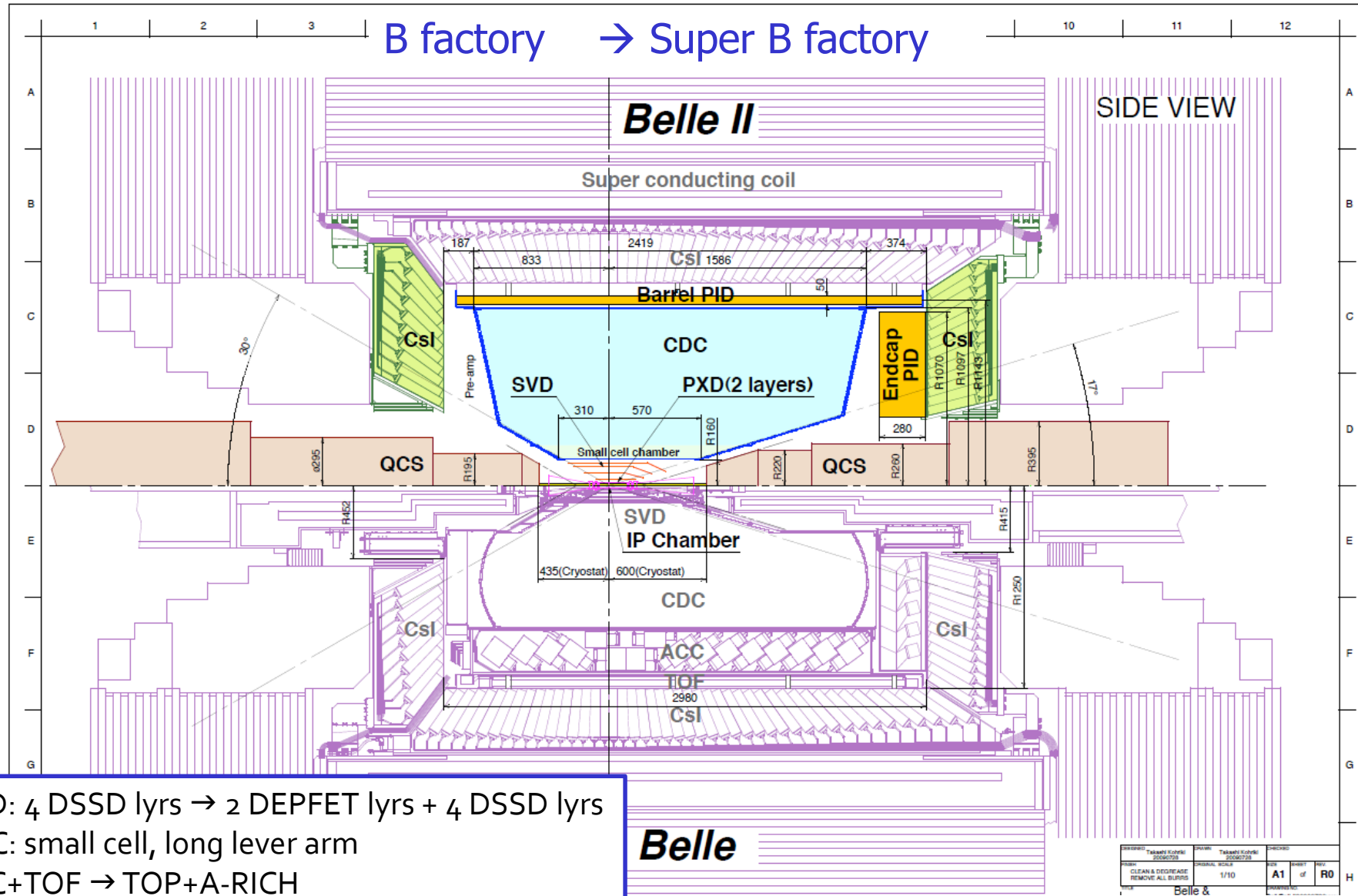

- SVD: 4 DSSD lyrs → 2 DEPFET lyrs + 4 DSSD lyrs
- CDC: small cell, long lever arm
- ACC+TOF → TOP+A-RICH
- ECL: waveform sampling, pure CsI for end-caps
- KLM: RPC → Scintillator + SiPM (end-caps)

Belle

New components in colour.

DESIGNED	Takashi Fukuda	DRAWN	Takashi Fukuda	CHECKED	
REVISION		ORIGINAL SCALE	2004/07/28	REV	Sheet of R0
REVISION	CLEAN & DECREASE REMOVE ALL BLURS		1/10		