

“aerogel as radiator of RICHs”

R. DE LEO, Bari Univ., deleo@ba.infn.it
ERICE, Oct.1st, 2003



- Optical properties of aerogel
- Aerogel: radiator of Cherenkov counters & focalized RICH
- contributions to $\delta\theta_C$ from aerogel in a focalized RICH
- performance of the aerogel focalized RICH of HERMES
- performance of the aerogel focalized RICH-1 of LHCb
- BELLE: aerogel radiator in a proximity focus RICH

aerogel: nicknames, structure

- “A little bit of almost nothing”
(the lightest solid, ρ : 3-350 mg/cc)
- “Frozen smoke” (much akin to air, up to 99.5%)
- “Holy grail” (Fortune Magazine: aerogel is used in >800 different applications)

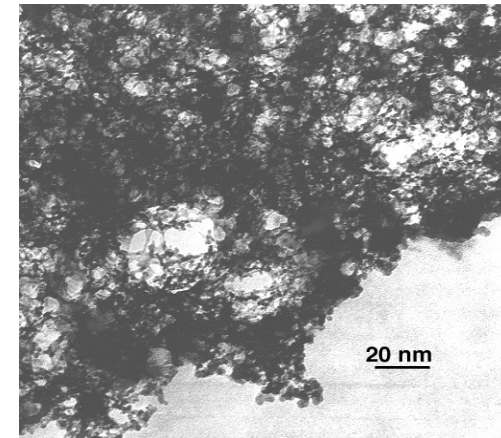
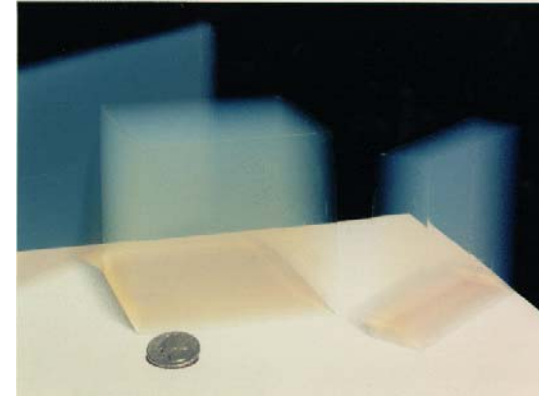

transm. elect. micrograph
<d>=20 nm micropores

a bit of history

- 1931: S.Kistler: **aerogel** has the same solid structure of the wet-gel supercritical drying to avoid shrinkage due to surface tension
- Late '70s: S.Teichner (Lyon) sol-gel **1-step** method hydrolyzing toxic TMOS in a methanol solution (alcogel) (240 C, 100 Atm)
- Early '80s: **1700 liters** of aerogel used at DESY, TASSO exp.
- '83: A.Hunt (Berkeley): TMOS replaced by TEOS
alcohol replaced by liquid CO₂ (31 C, 100 Atm)
- '85: J.Fricke: 1st **Symp.** on aerogels in Wurzburg
- '91: L.Hrubesh (LLNL): **2-step** method
1st step: a condensed silica oil is prepared from TEOS with a non-alcohol solvent (precursor)
2nd step: precursor is processed to gel

aerogel in space

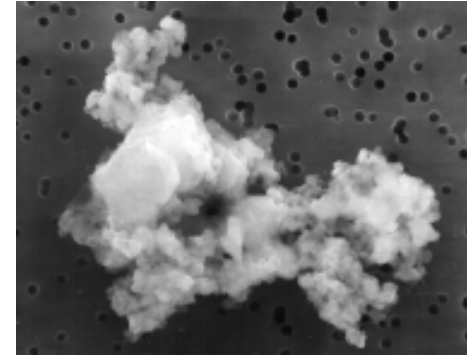

10 micron
cosmic dust

cosmic dust or meteoroids
softly captured
(impact damage minimized)

thermal properties

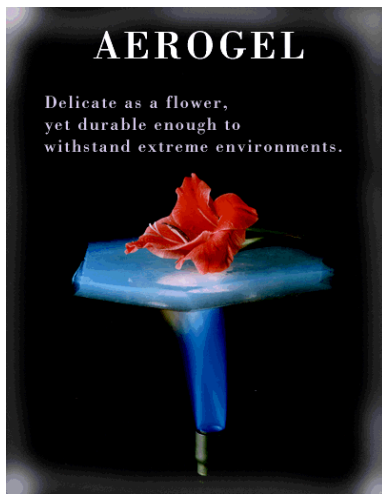
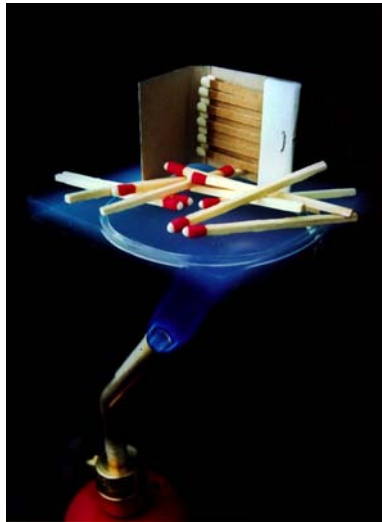

thermal conductivity ~ 0.017 W/m K

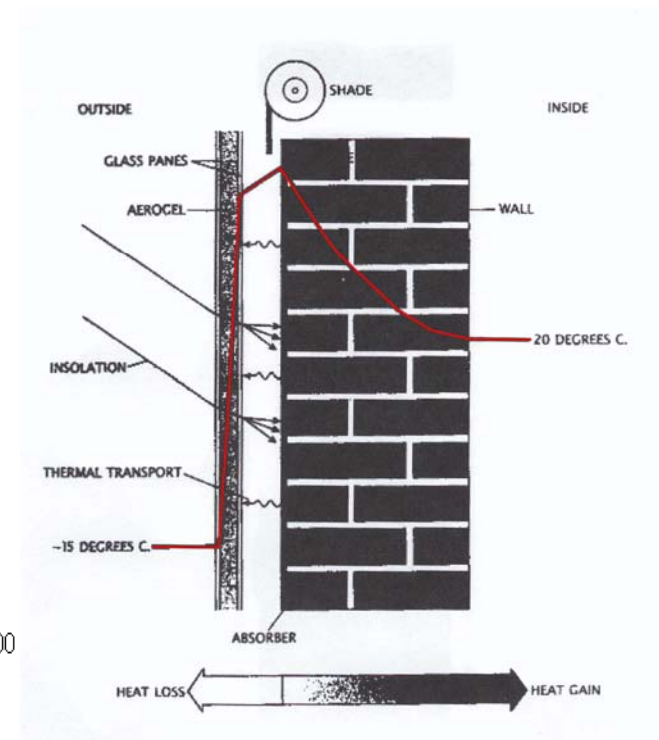
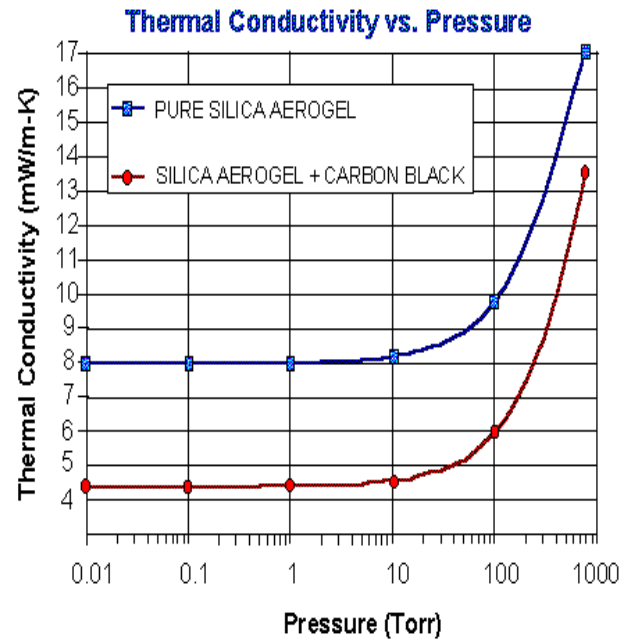

optical properties

UV-VIS-NIR Spectrum of Silica Aerogel

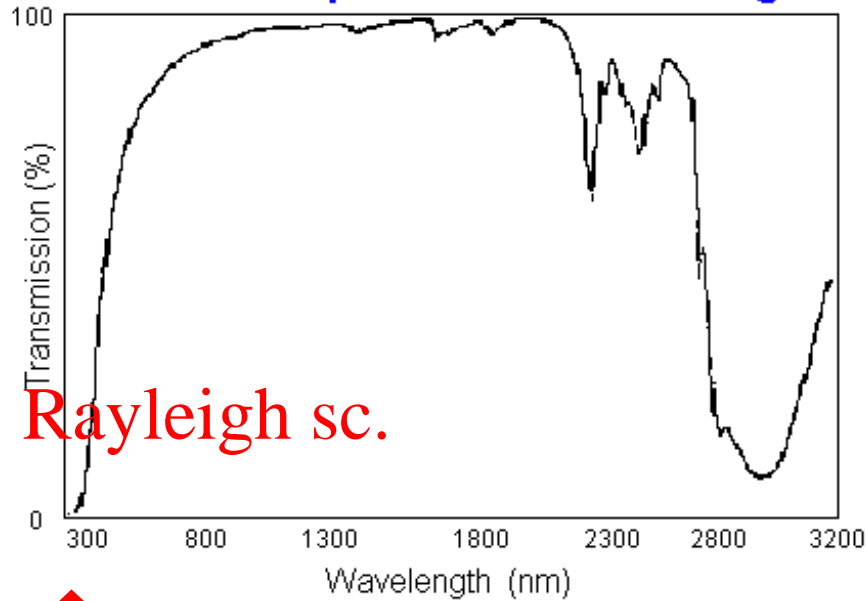

T up to 2 μm :
Hunt formula
 $T = A * \exp(-Ct/\lambda^4)$

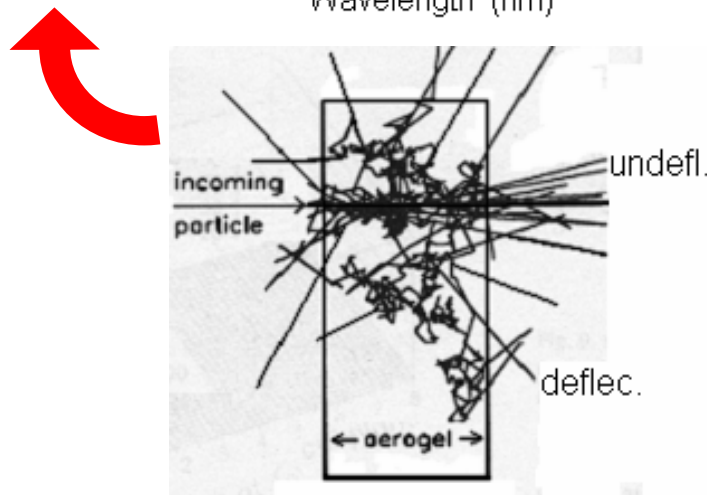

Airglass ('80s):
 $A = 0.8$ (opaque)

$C = 0.02 \mu\text{m}^4/\text{cm}$ (diffusing)

→ Aerogel in Cher. counters

aerogel refractive index controlled by alcohol volume

$$n = 1 + 0.26 * \rho$$

$$n: 1.008 - 1.08$$

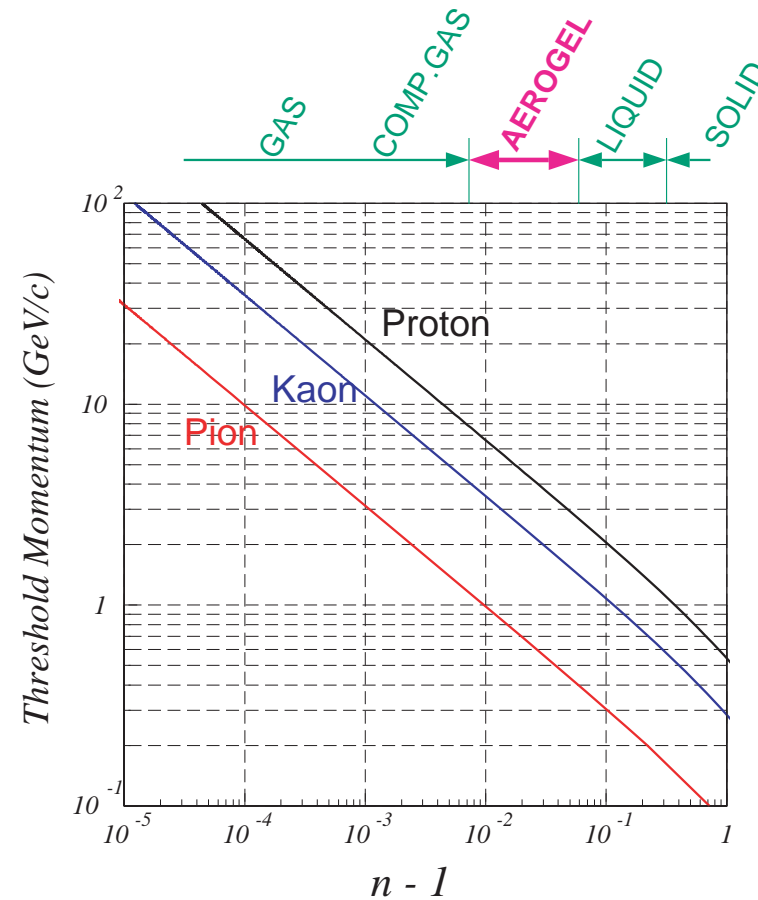
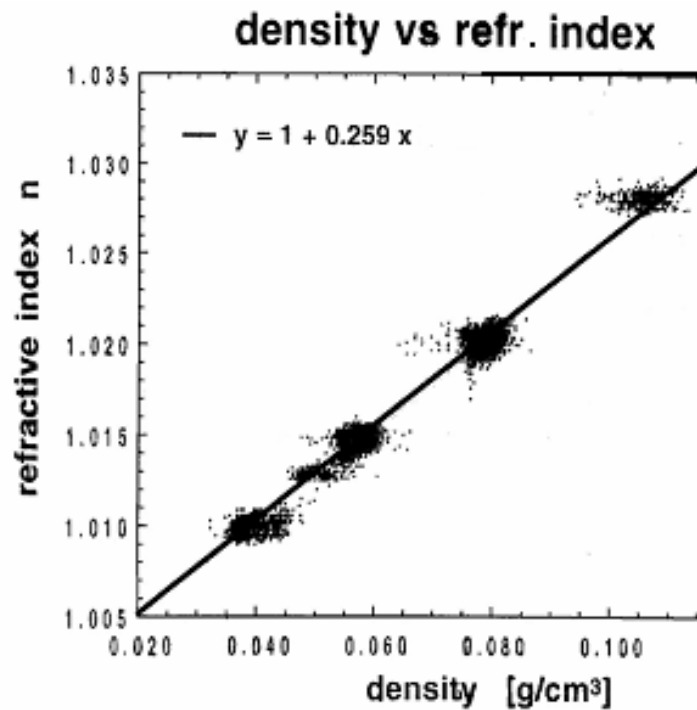

hygroscopic aerogel (Aerglass)

12 h at 500 °C baking, 3% of tile weight (water) removed

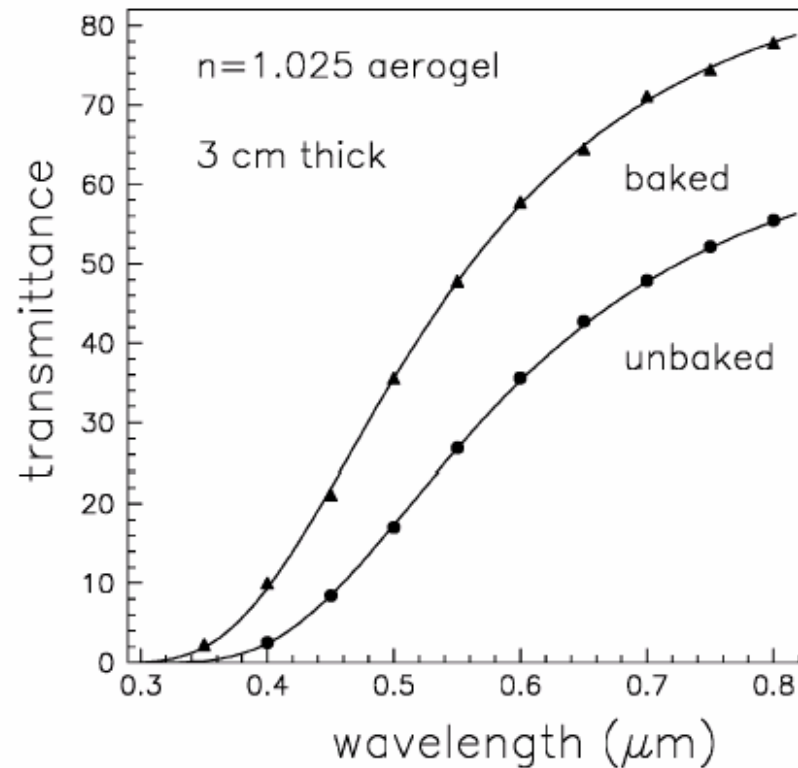

improve of transmittance: $n=1.03$, $t=1\text{cm}$

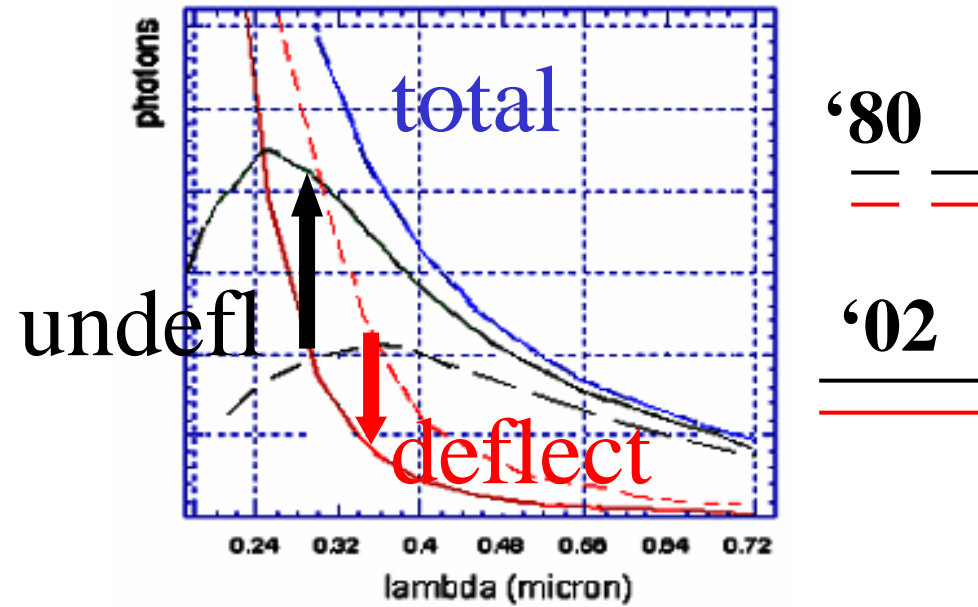
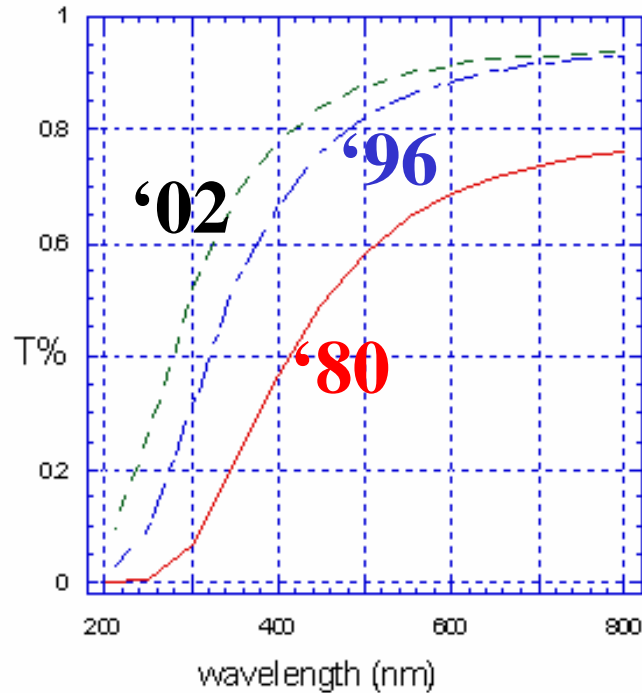

| year | A | C | producer | $\Lambda(0.4\mu\text{m})$ |
|------|------|-------|-------------|---------------------------|
| '02 | 0.96 | 0.005 | Novosibirsk | 4 cm |
| '96 | 0.95 | 0.01 | Matsushita | 2.3 cm |
| '80 | 0.8 | 0.02 | Airglass | 1 cm |

aerogel as focalized RICH radiator

- V.I.Voboriov & al., (1990) 350 MeV e^- at Novosibirsk
- D.Fields, H.v.Hecke & al.NIMA349(1994)
450 GeV protons at CERN (NA44 exp.)

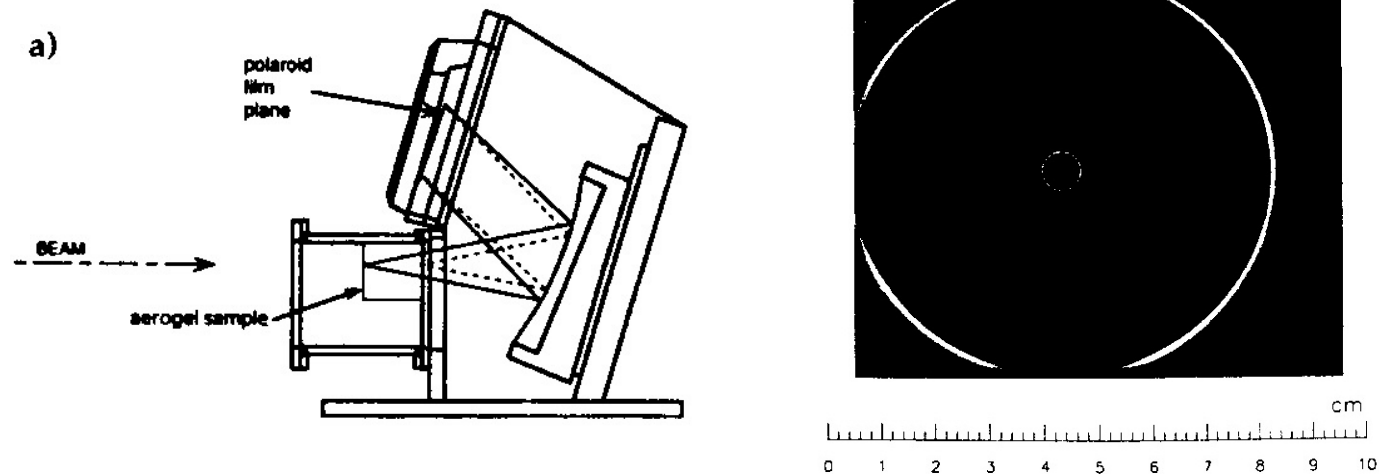

'96 KEK & Matsushita Co.

- new development for BELLE at KEKb
- new 1 step: precursor **methylsilicate 51**
- high opt. quality: $\Lambda(400 \text{ nm}) = 2.3 \text{ cm}$
- long term stability
- rad. hardness: No deterioration of **T & n**
up to **10 MRad** @ Nat'l Tsing Hua Univ.
- surface treatment: **hydrophobic**

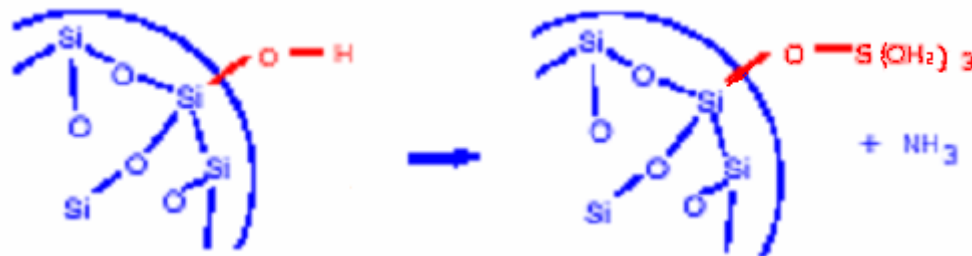

OH on the surface replaced by **TMS** (trimethylsilyl)

focalized RICH with aerogel

- T.Ypsilantis & J.Seguino, NIMA368(1995)
- T.Ypsilantis, J.Seguino & al., NIMA401(1997),
(CERN-Bari-Milan-Rome-Coll.de France coll. @ PS-T9)

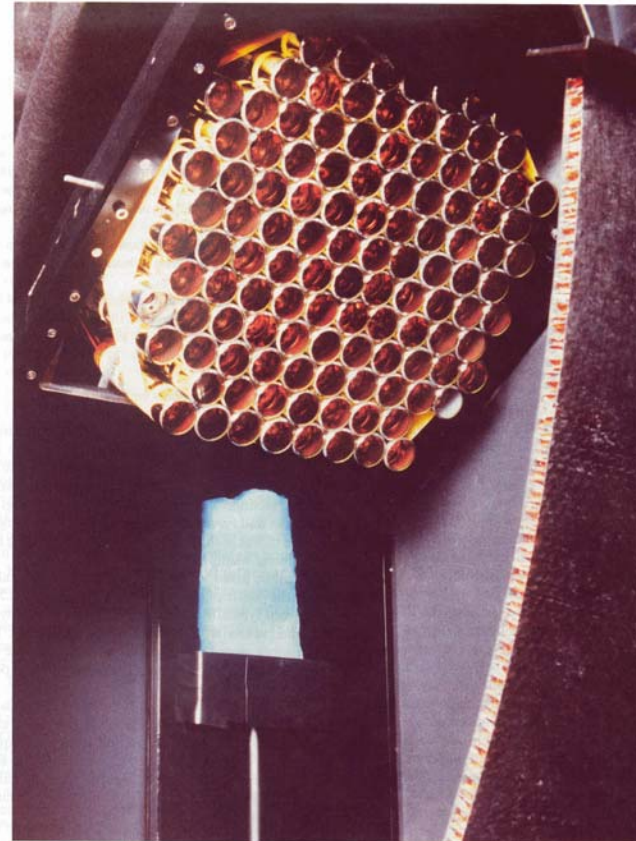
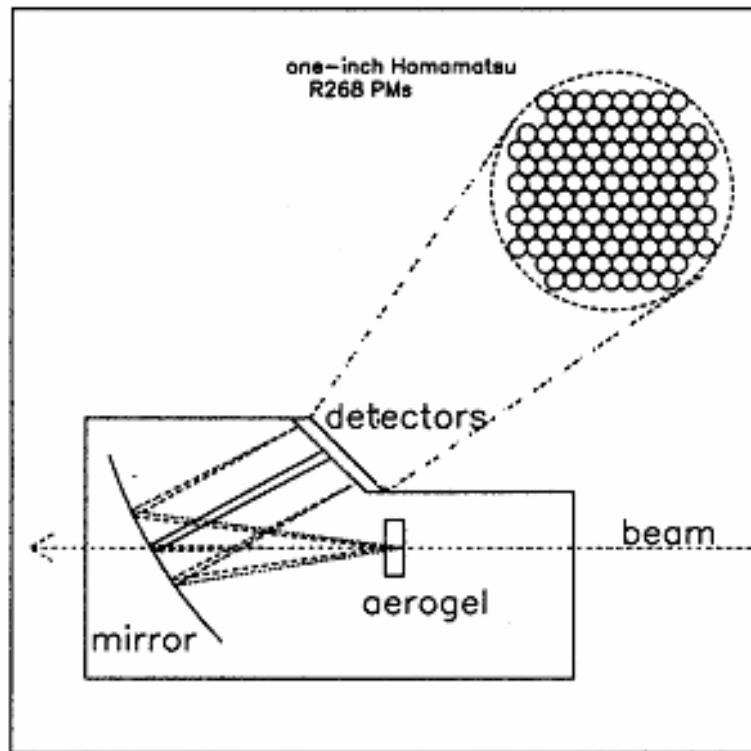

5 cm of KEK aerogel, π^- 10 GeV/c

one event

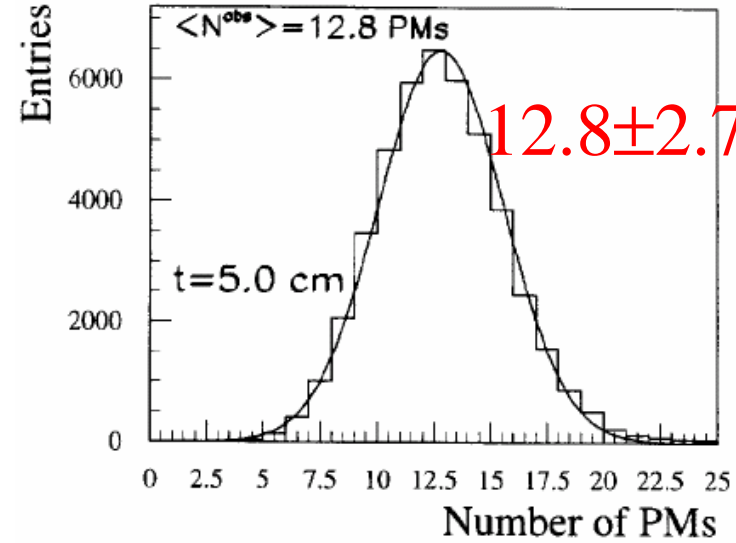
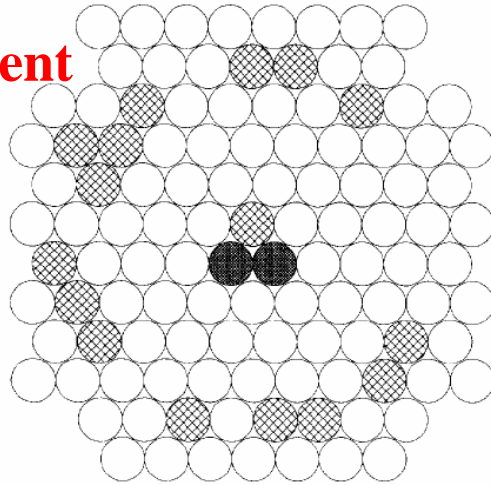

many events

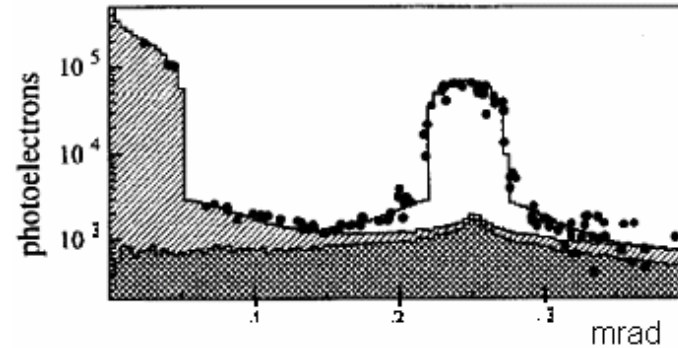
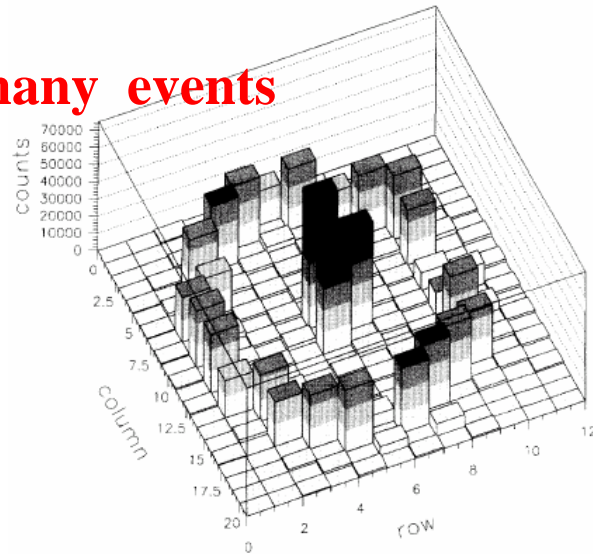

$$\delta\theta/\theta = 8\% / \text{pe}$$
$$\delta\theta/\theta = 2.3\% / \text{ring}$$

HERMES DIS 27.5 GeV e on p

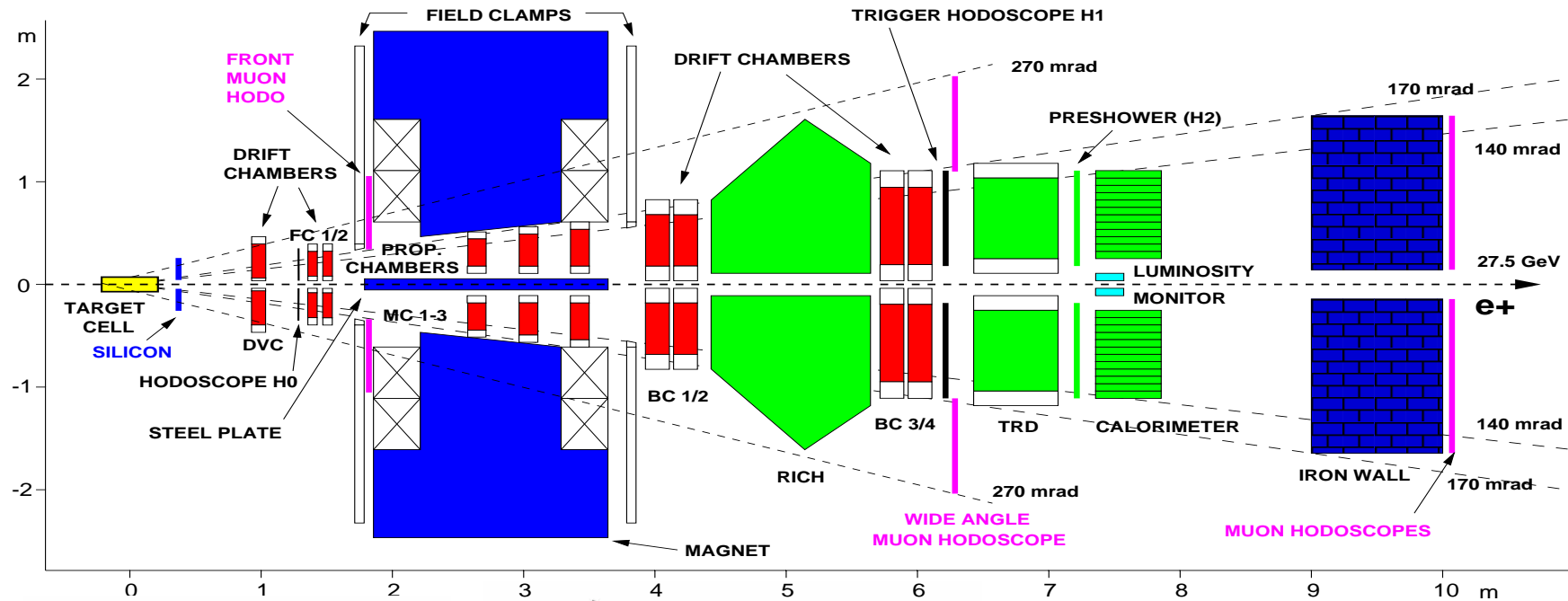

95% of hadrons 1-15 GeV/c

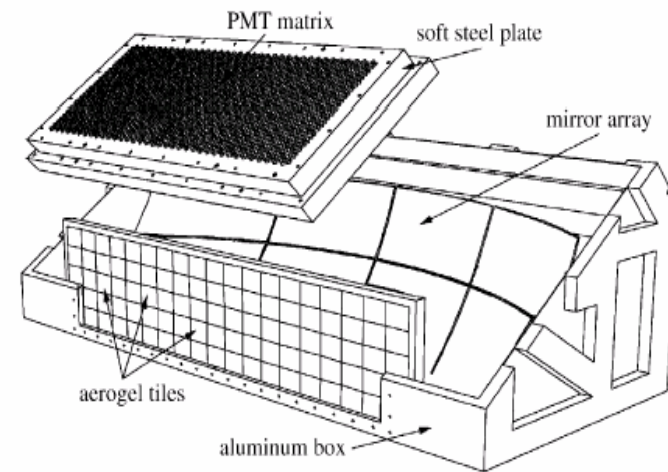
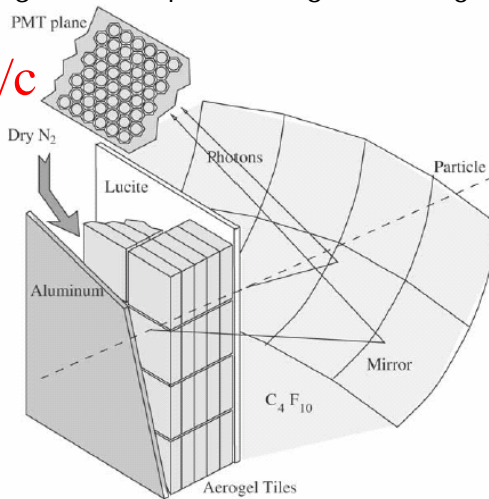
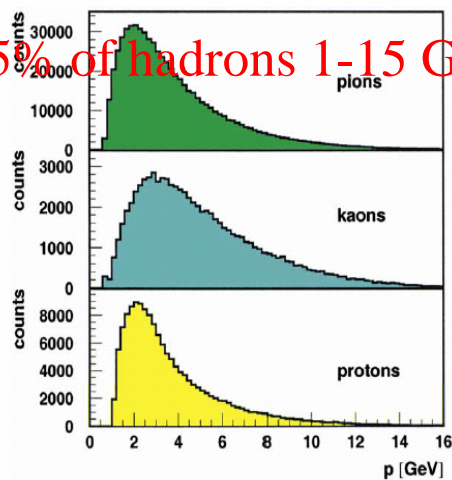

HERMES dual radiator RICH

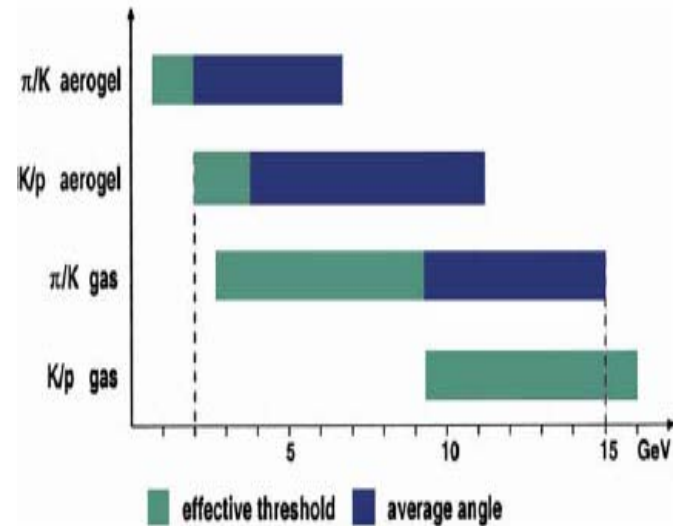
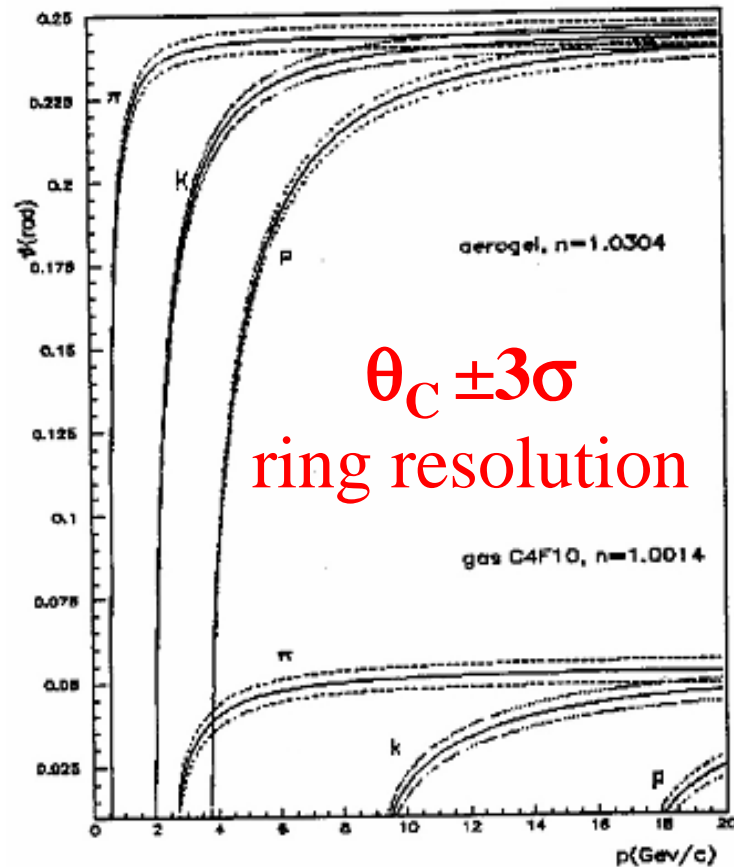

- focalized $R = 2.2$ m
- $n(\text{aerogel})=1.03$, $\theta_C=242$ mrad
- $n(\text{C}_4\text{F}_{10})= 1.00137$
- $N_{pe}(\text{aerogel}) = 12$
- $\delta\theta/\theta(\text{/ring}) = 1.2$ % (4.1% / pe)
- $\delta\theta(\text{/ring}) = 3$ mrad
- $\theta_C^\pi - \theta_C^k(7\text{GeV}, n=1.03) = 9$ mrad

2*1934 3/4" PMTs

1" Al mylar funnels

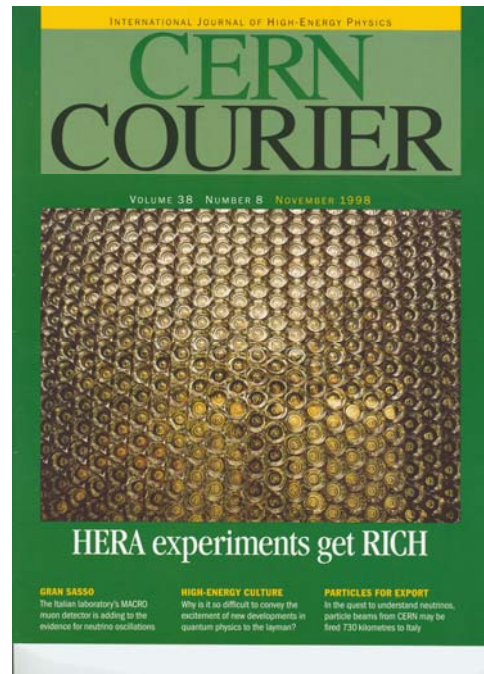
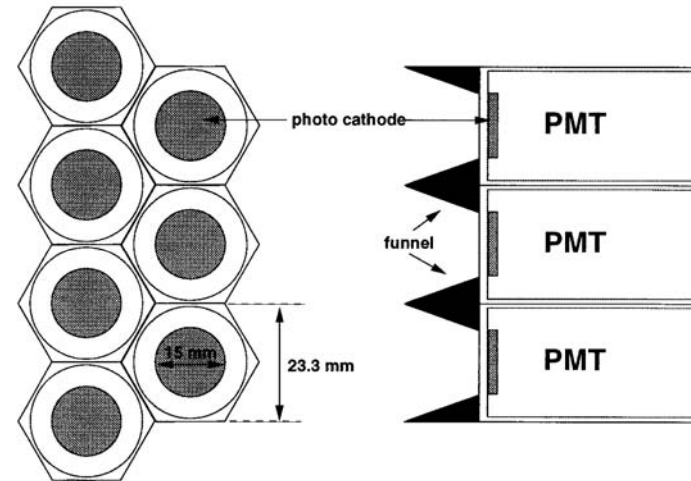
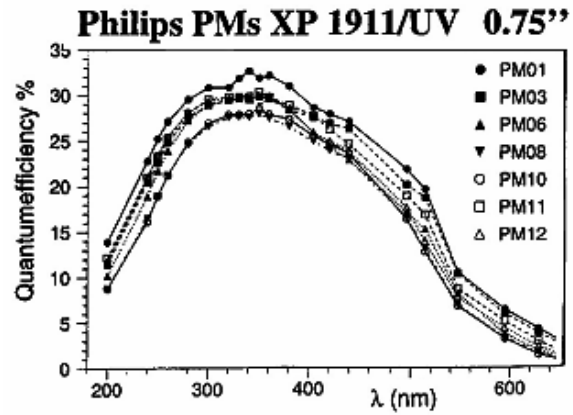

T → Cher. γ 's → photoelectrons

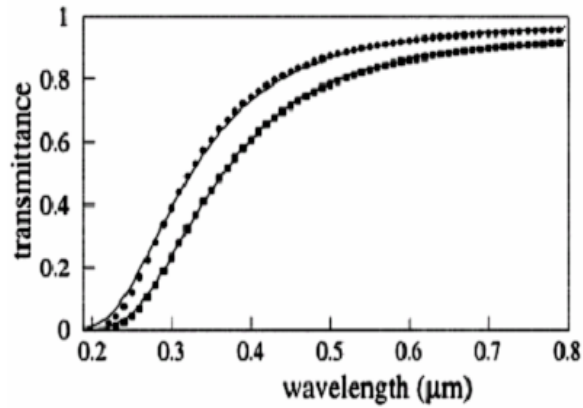

| Hunt par | Av.value | σ (%) |
|--------------------------|----------|--------------|
| A | 0.964 | 2.4 |
| Ct (μm^4) | 0.0094 | 8.3 |

Λ (400 nm) = 2.3 cm

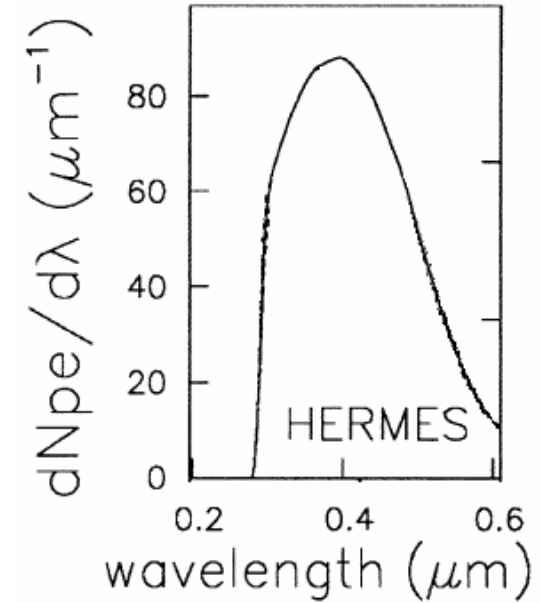
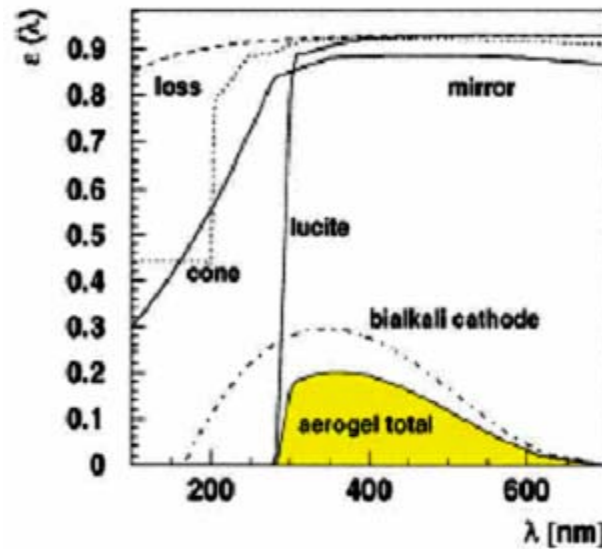
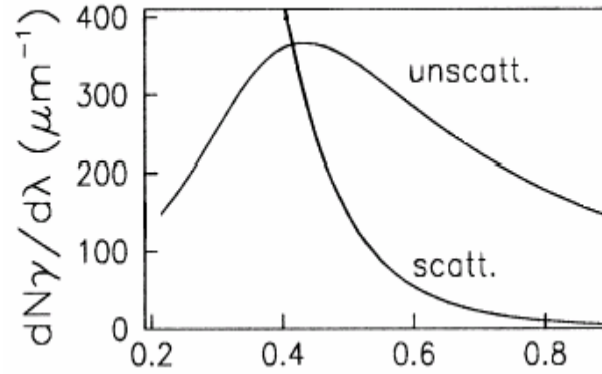

N_{pe} (calc.)
12±2

geometrical contributions to $\delta\theta_c$

1) pixel $\left(\frac{\delta\theta}{\theta}\right)_{\text{pixel}} = \left(\frac{D}{4R}\right) = 2.30 \text{ \% / pe}$

2) focal plane

a) $(\vartheta\theta/\theta)_{\text{opt.aber.}} = (d/R)^2 = 0.5\%$

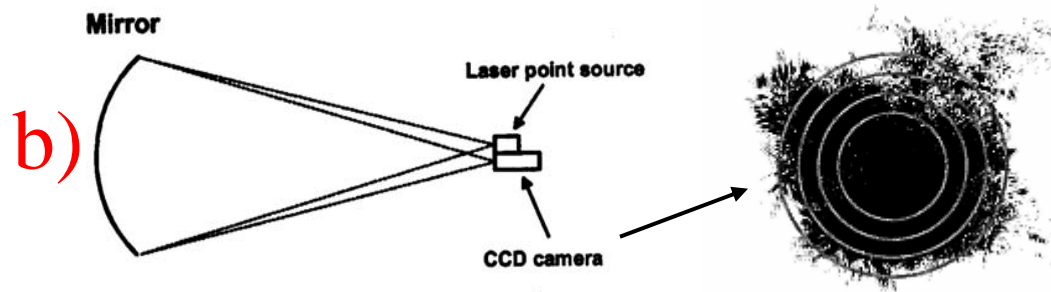

$\vartheta\theta = \sigma/2R(\vartheta\theta/\theta)_{\text{surf.imp.}} = 0.3 \text{ \%}$

a)+b) $(\vartheta\theta/\theta)_{\text{mirror}} = 0.6 \text{ \% / pe}$

3) point emiss. $(\vartheta\theta/\theta)_{\text{point}} = 0.7 \text{ \% / pe}$

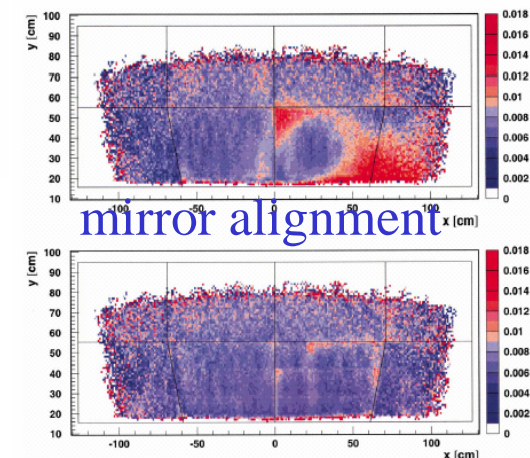

aerogel opt. properties contrib.s to $\delta\theta_c$

- 1) n dispersion in the different tiles
- 2) chromatic dispersion $n(\lambda)$
- 3) forward scattering
- 4) tile surface irregularities

aerogel Selected 850 tiles over 1200
11x11x1 cc from Matsushita
2 planes, 5 rows, 17 columns, 5 layers

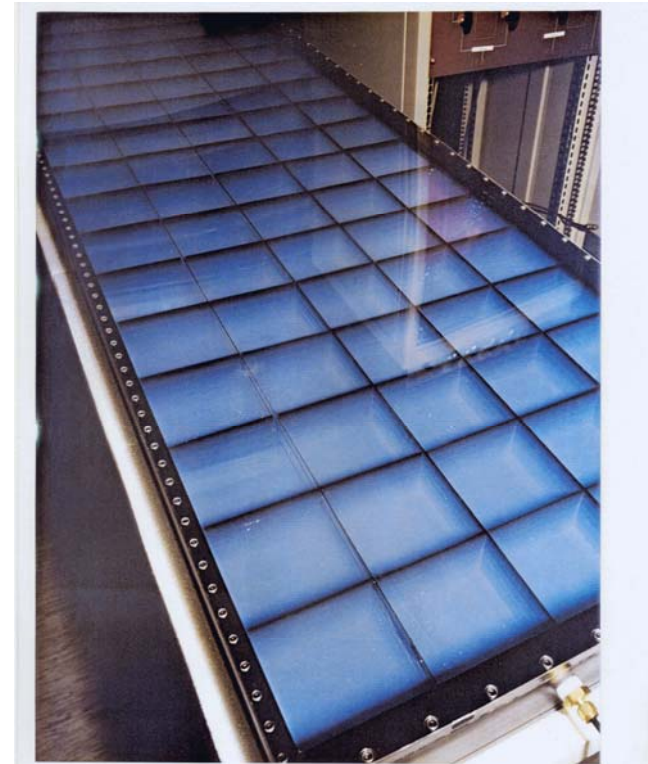

one aerogel radiator

1) n dispersion

minim.deflec.

$$l = 4\text{m} \rightarrow \delta n/n = 10^{-4}$$

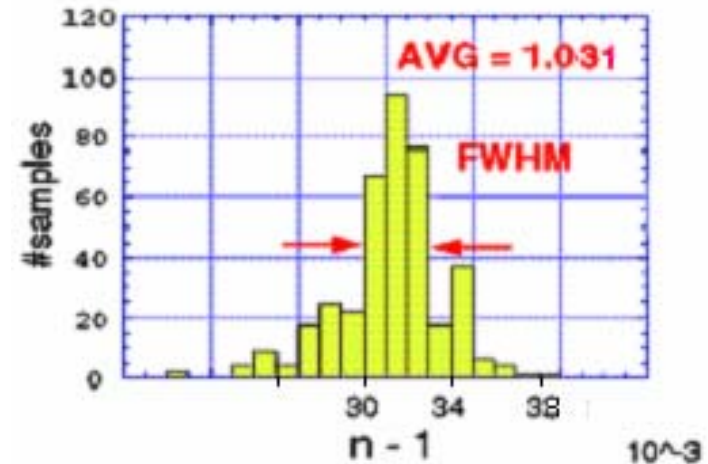
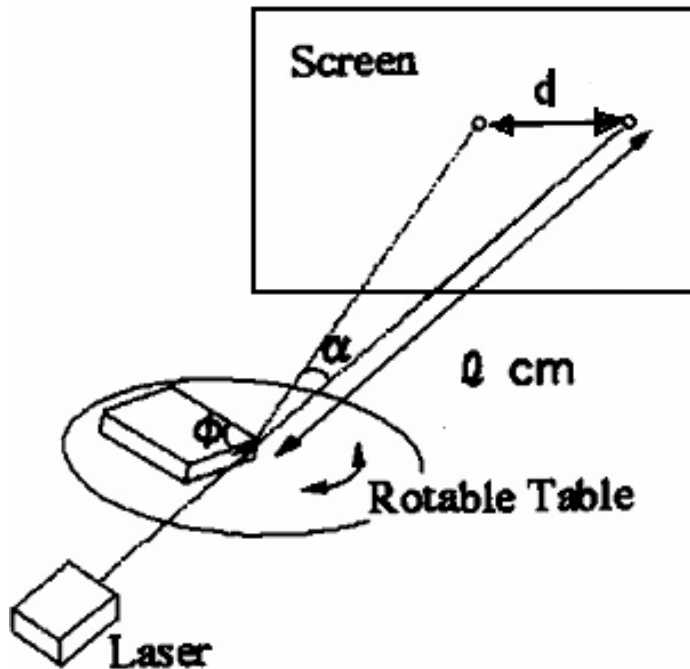

$\delta n/(n-1) = 1.5\%$
 reduced to 1.0%
 by sorting similar- n tiles

$$\left(\frac{\delta\theta}{\theta}\right)_n = \frac{1}{2} \frac{\delta n}{n-1} = 0.5\% / \text{pe}$$

2) chromatic dispers.: $n(\lambda)$ meas.

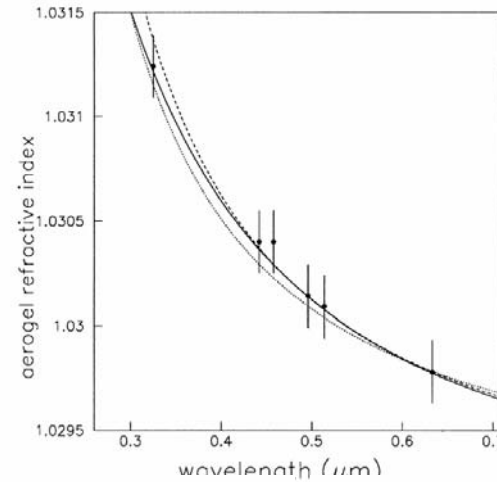
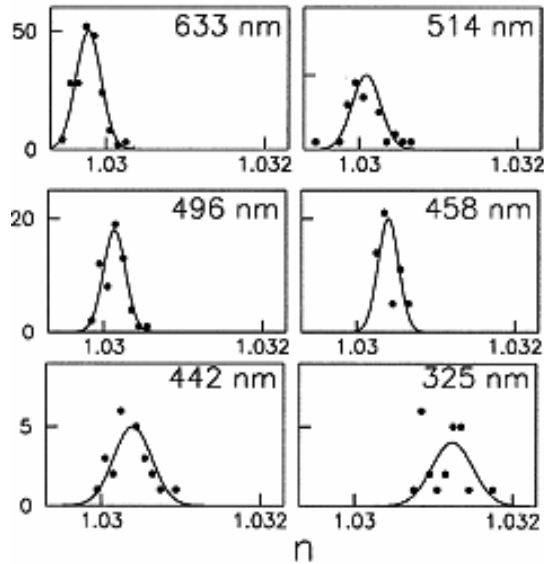

$$n = C + C'/\lambda^x \quad x = 1.2 \pm 0.2.$$

$$n_{\text{aerogel}}(\lambda) = An_{\text{SiO}_2}(\lambda) + (1 - A)n_{\text{air}}(\lambda)$$

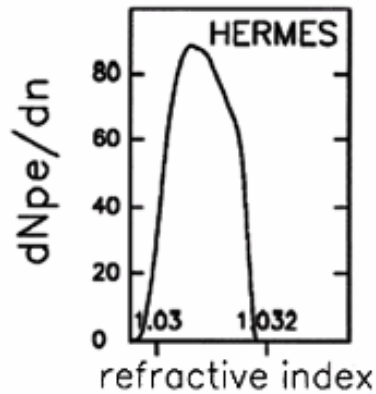

$$n_{\text{aver}} \pm \sigma_n = 1.0312 \pm 0.0008$$

$$\left(\frac{\delta\theta}{\theta}\right)_{\text{chromatic}} = \frac{1}{2} \left(\frac{\sigma_n}{n_{\text{aver}} - 1}\right) = 1.3 \% / \text{pe}$$

3) forward scattering

- due to large inhomogeneities of ϵ , mostly on the surfaces
- responsible of fuzzy vision of objects through aerogel
- influence $dN_{pe}/d\vartheta$ not N_{pe}
- forward peaked (\neq Rayleigh isotropic)
- dep. on pH of solvent used in gel



Rayleigh-Debye (Mie) scattering theory

$$\frac{d^2 T_{FS}}{d\theta dx} = \frac{(1 + \cos^2 \theta)}{\lambda^4} (\sin \theta) w f.$$

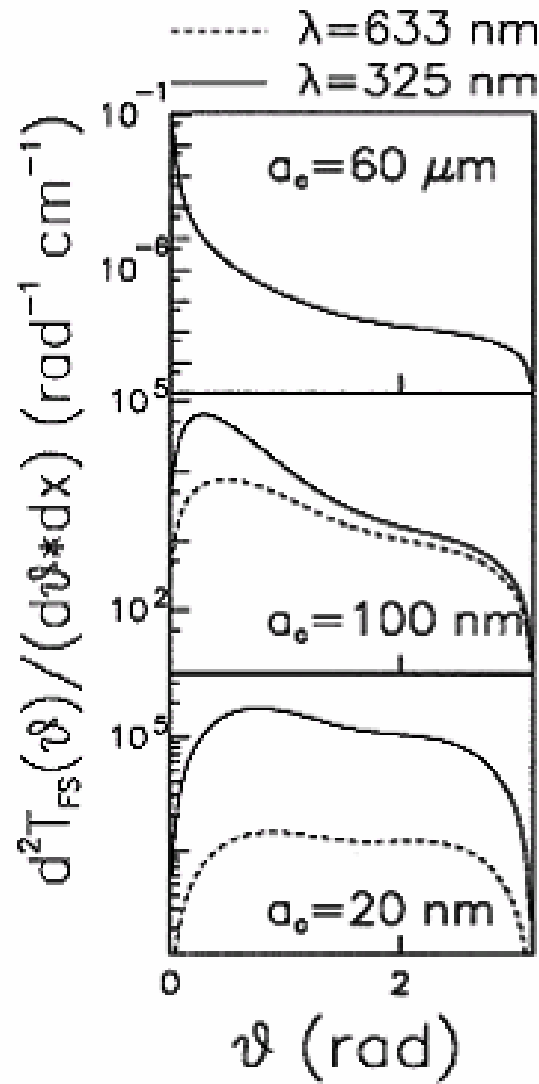

$w \propto a_C$ (inhomog.)

$a_C > \lambda$ FS

$a_C < \lambda$ Rayleigh

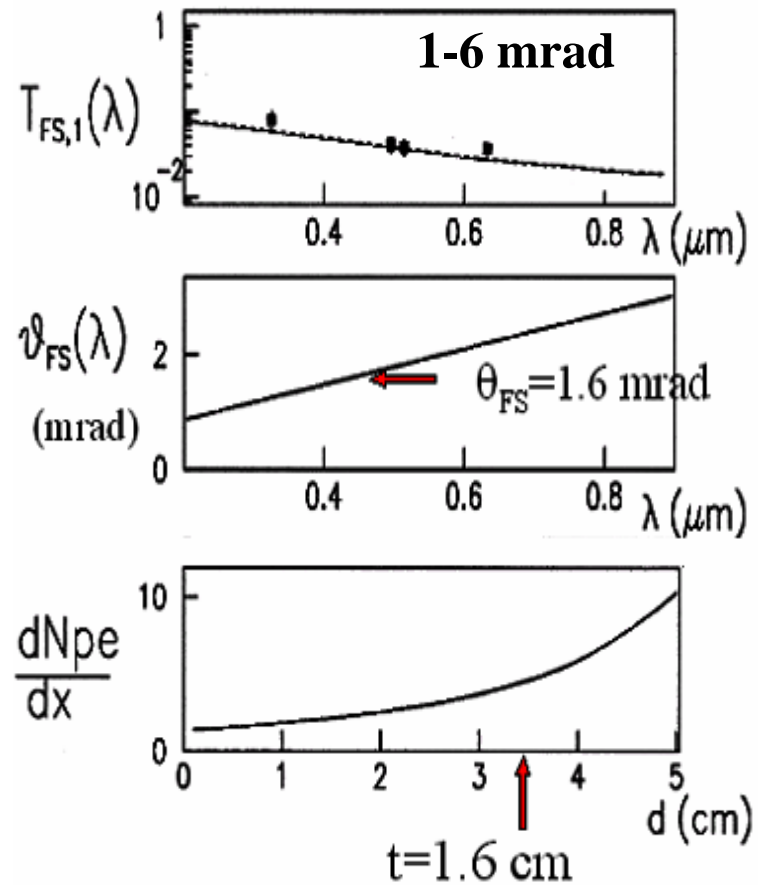
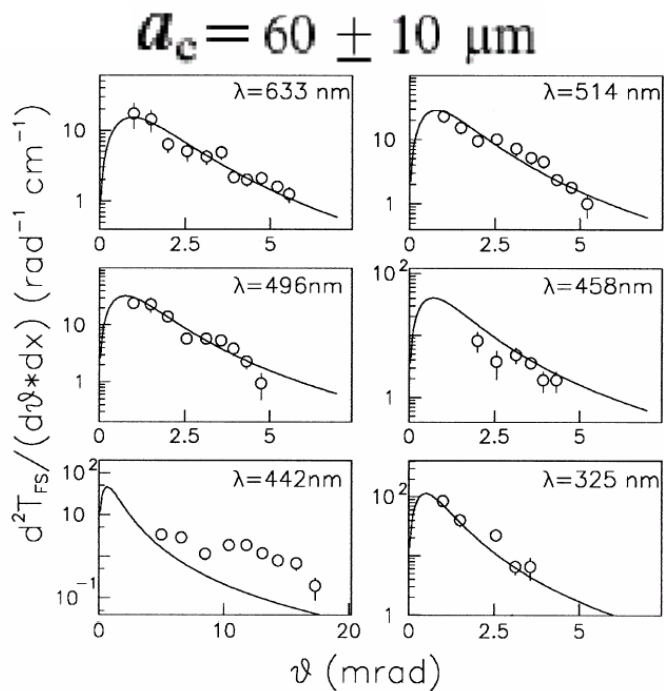
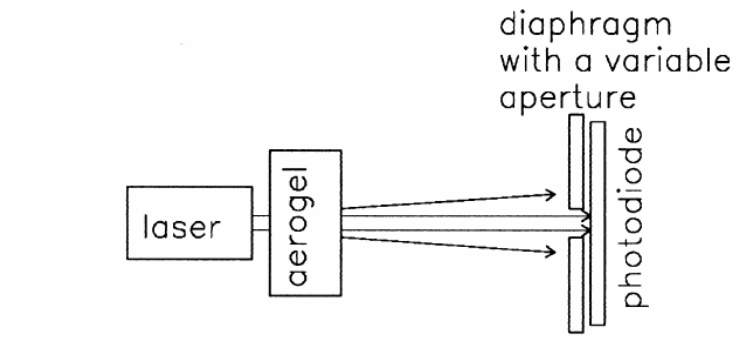

23% of Cher.ph. are FS $\rightarrow \delta\theta_{FS}$

$$\left(\frac{\delta\theta}{\theta}\right)_{FS} = \left(\frac{\delta\theta_{FS}}{\theta_C}\right) = 0.4 \% / \text{pe}$$

4) surface irregularities

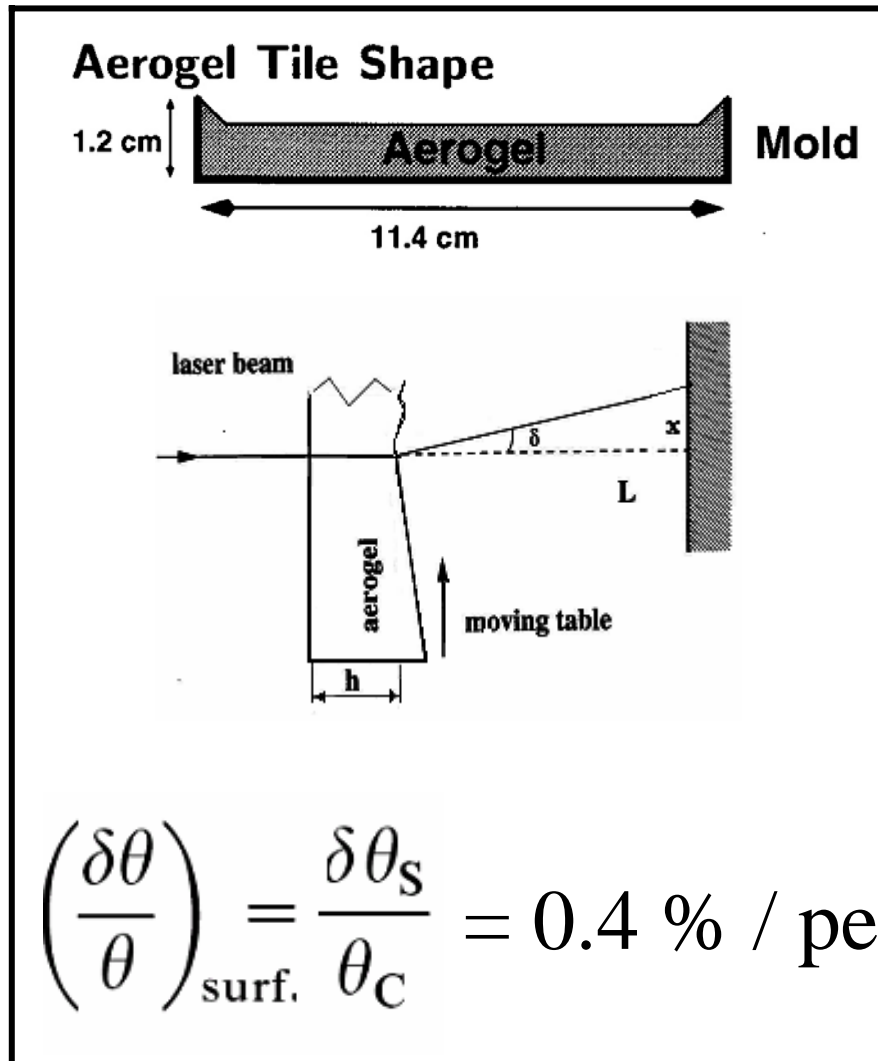

avoid internal reflections
black tape on lateral surfaces

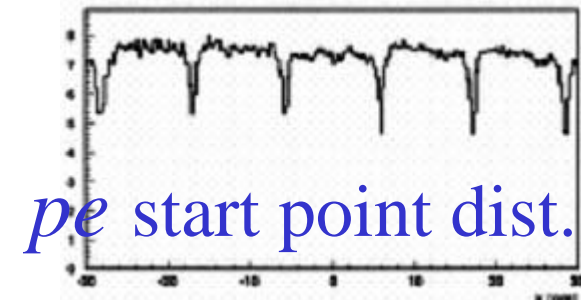
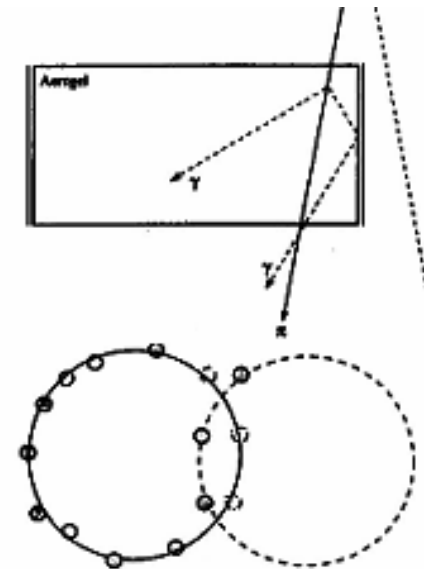

on-line display

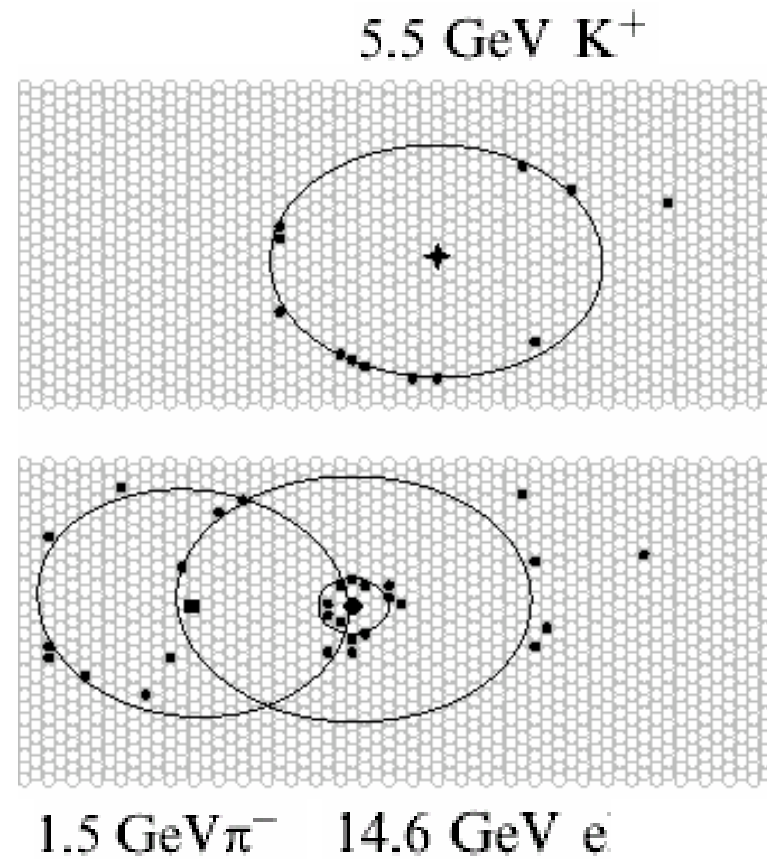
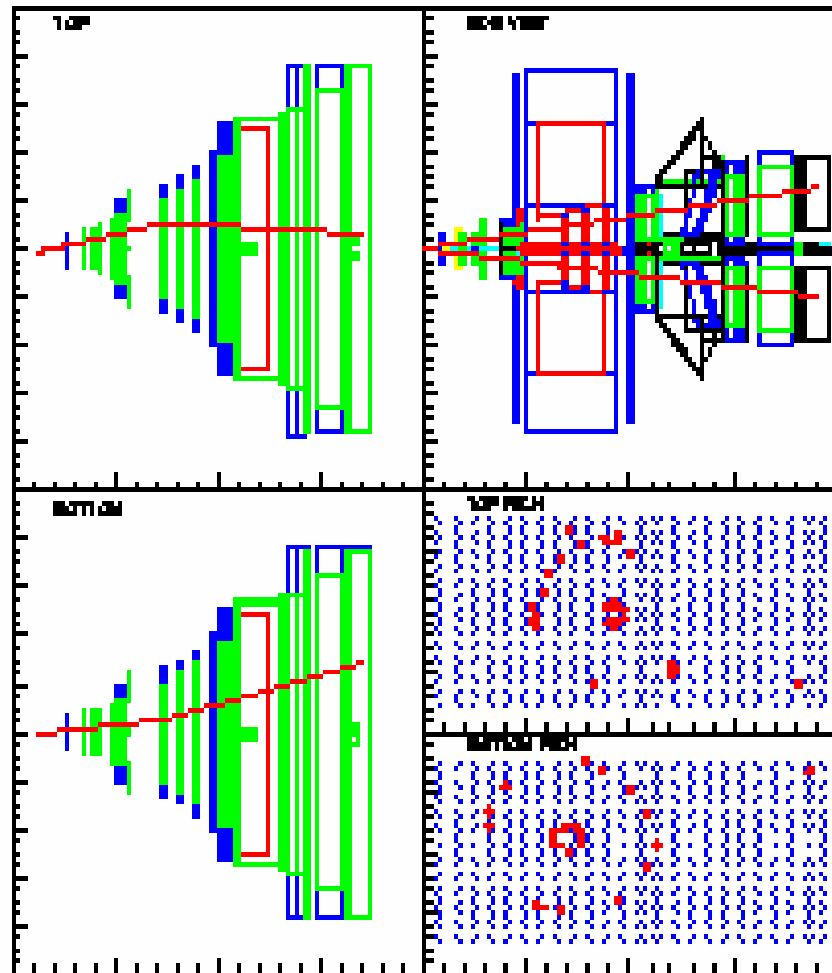

exp.-calc. angle resolution (%)

- HERMES
- Pixel 2.3 ←
 - Mirror 0.6
 - Point emiss. 0.7
 - n disp. 0.5
 - Chromatic 1.3
 - Forw.Scatt. 0.4
 - Surface 0.4
 - Total (calc.)/pe 2.9
 - Total (exp.)/pe 3.3
 - Npe (exp.) 10

θ_c for single pe

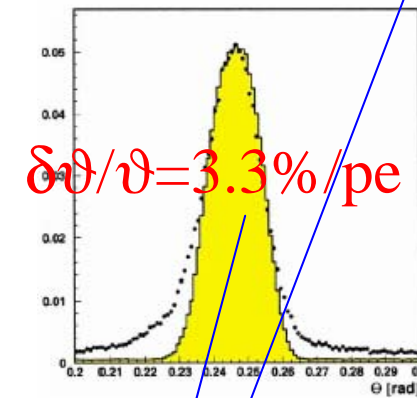
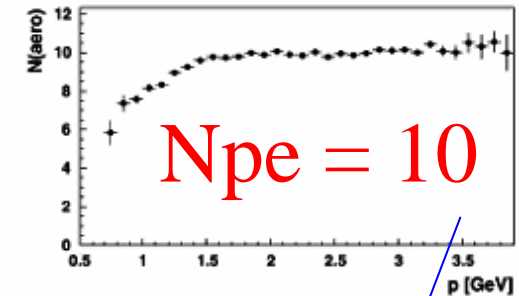
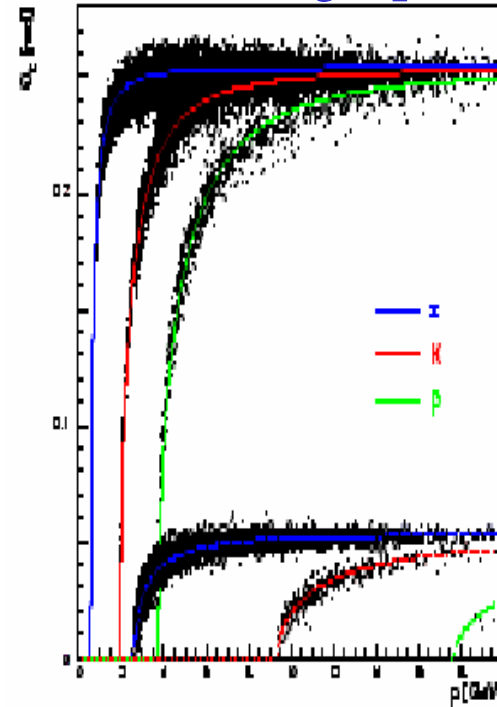

$\delta\theta/\theta = 1.1\% / \text{ring}$

The LHCb detector

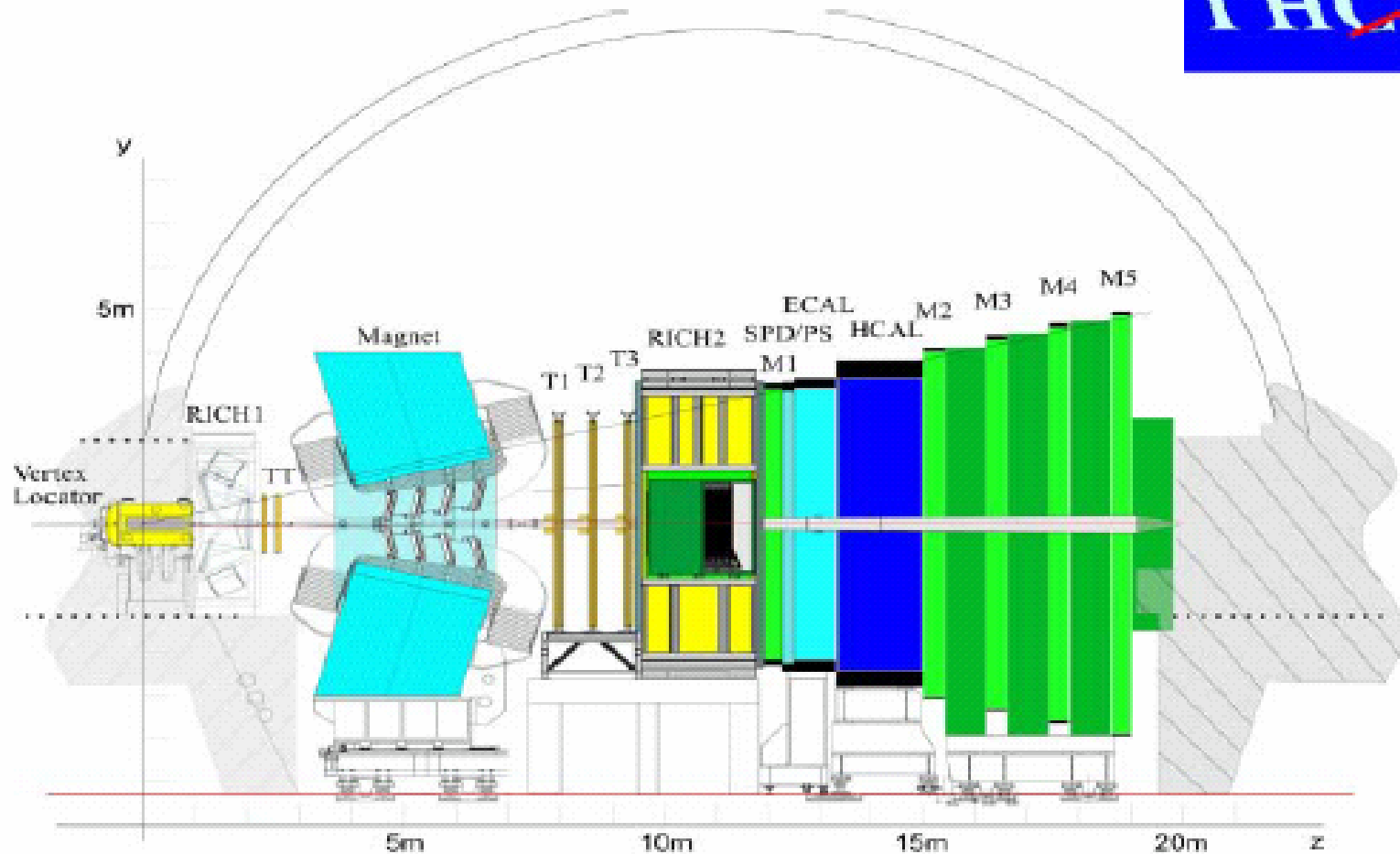

K/π separation 2-150 GeV/c

RICH-1 LHCb

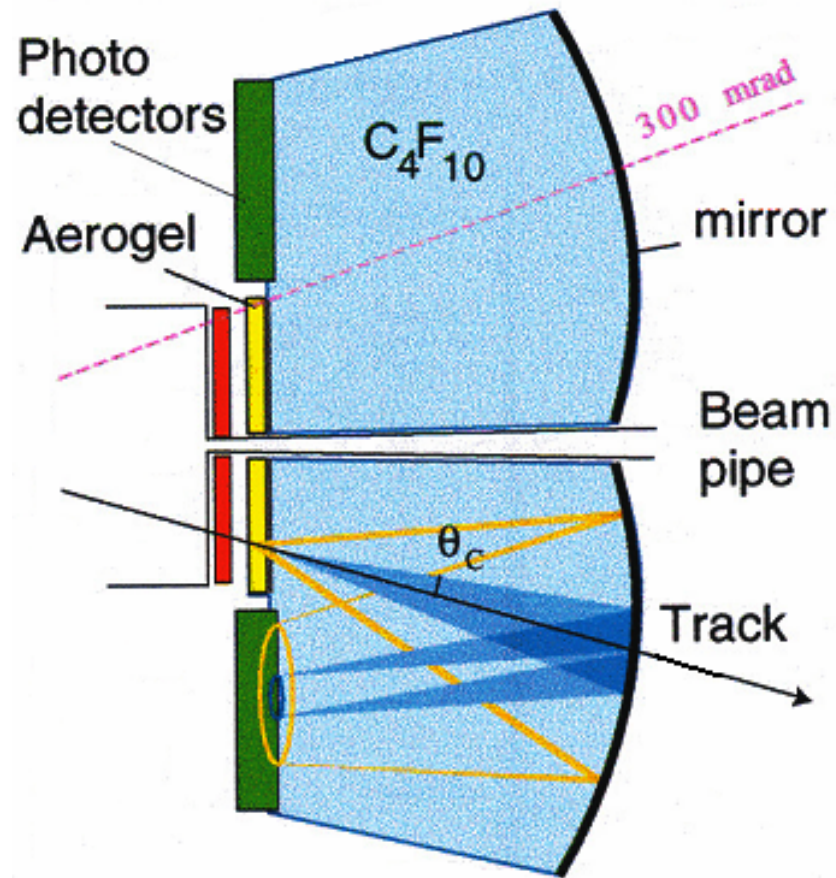

BINP-Novosibirsk:

$20 \times 20 \times 4 \text{ cm}^3$

$n=1.03$ **hygroscopic**

$A=0.96$ $C=0.005$ ($t=1 \text{ cm}$)

$\Lambda(400 \text{ nm}) = 4 \text{ cm}$

Clarity measurements



Sezione di Milano
C.Matteuzzi

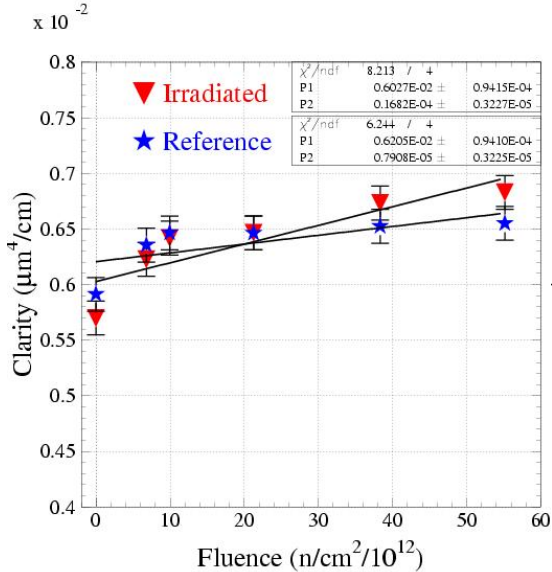

neutrons from IRRAD-2

protons from IRRAD-1

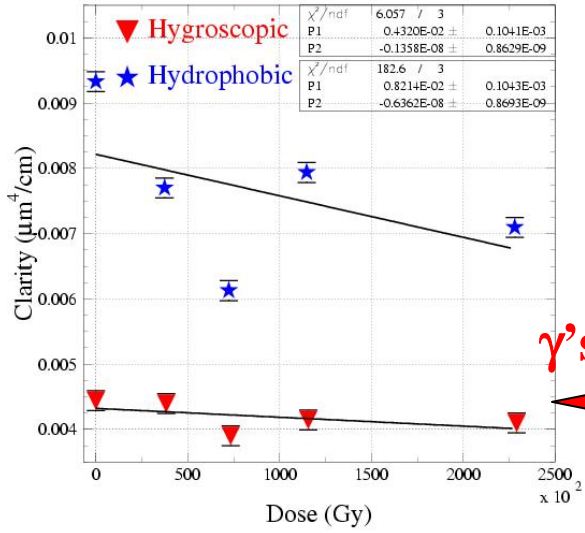
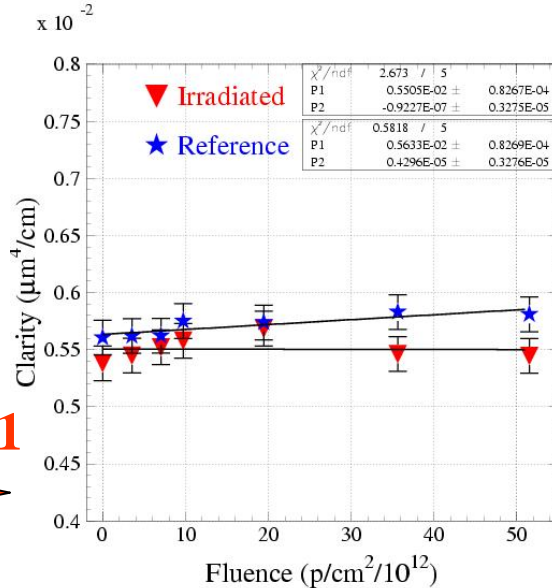

humidity absorption

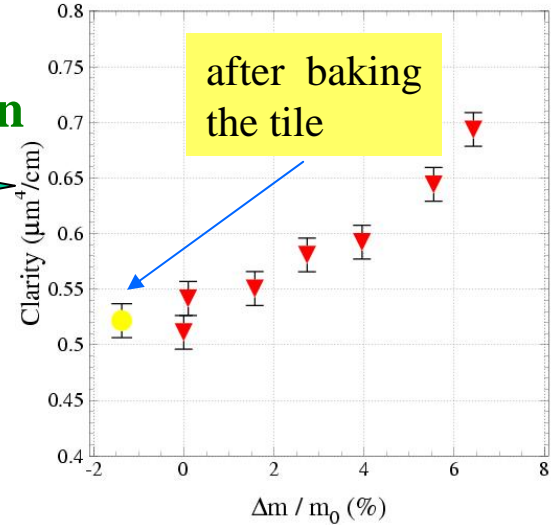

The PhotoDetectors

HPD

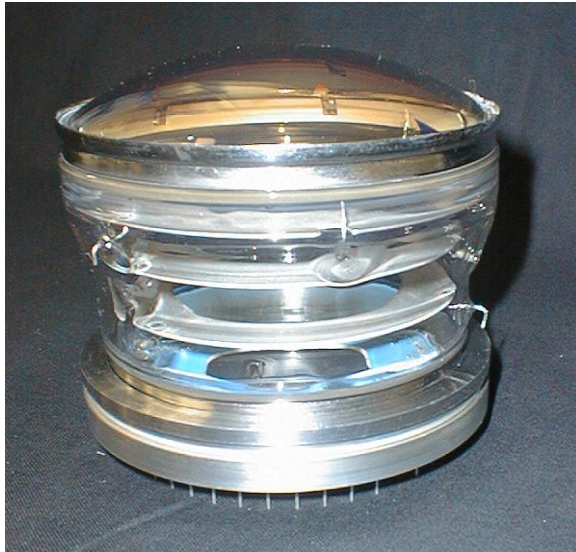

- Bialkali Photocath. $D=110$ mm, $QE(320nm)>20\%$
- Overall $D=125$ mm 82% active area
- voltage **-16 KV**
- Electron optics: **cross-focussed**
- demagnification **2.3**
- Anode: Si pixel : **1 mm x 1 mm** (320x32 matrix)
2048 pixels, size at photocath. **2.5 x 2.5 mm²**

MaPMT

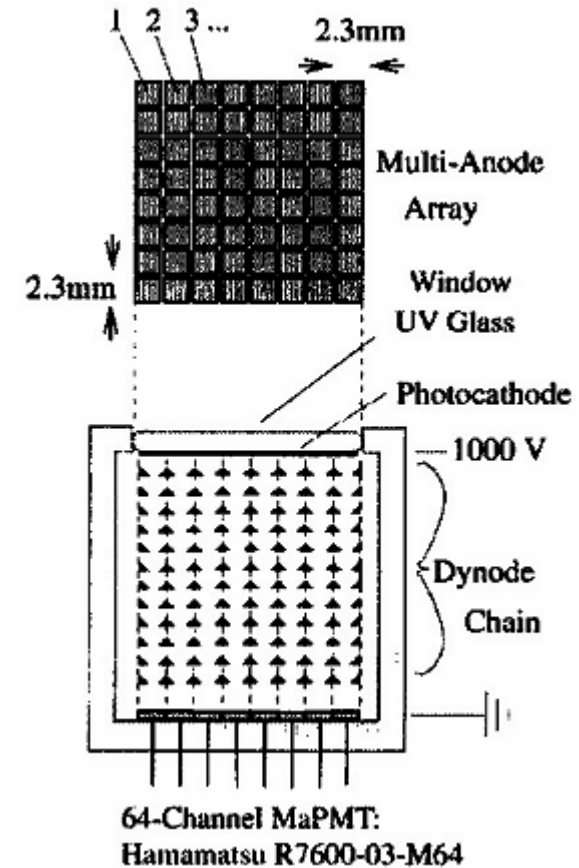

4 HPD & AEROGEL from Novosibirsk: test beam

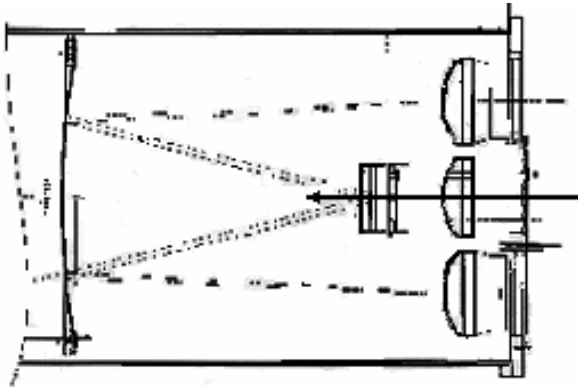

Angular resolution

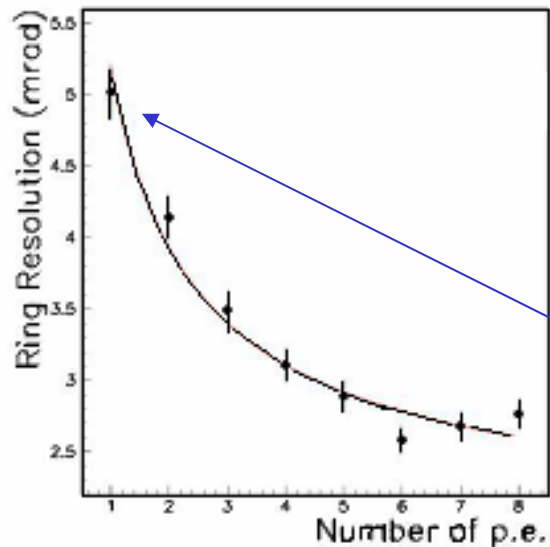

N_{pe} yield

| | No filter | Filter D263 (0.3 mm) |
|---------|-----------|-------------------------|
| 4 cm | | |
| DATA MC | 9.7 11.5 | 6.3 7.4 |
| 8 cm | | |
| DATA MC | 12.2 14.7 | 9.4 10.1 |

$t=4$ cm $N_{pe} \sim 10$

$$\delta\vartheta/\vartheta = 2.0 \% / pe$$

LHCb RICH-1 $\delta\vartheta/\vartheta$ (/pe)(%) and Npe from HERMES

| | HERMES | LHCb |
|--------------------|--------|------|
| • Pixel | 2.3 | 0.3 |
| • Mirror | 0.6 | 0.5 |
| • Point emiss. | 0.7 | 0.6 |
| • n disp. | 0.5 | 0.5 |
| • Chromatic | 1.3 | 1.4 |
| • Forw.Scatt. | 0.4 | 0.4 |
| • Surface | 0.4 | 0.4 |
| • Total (calc.)/pe | 2.9 | 1.8 |
| • Total (exp.)/pe | 3.3 | 2.0 |
| • Npe (calc.) | 12 | 18 |
| • Npe (exp.) | 10 | 10 |

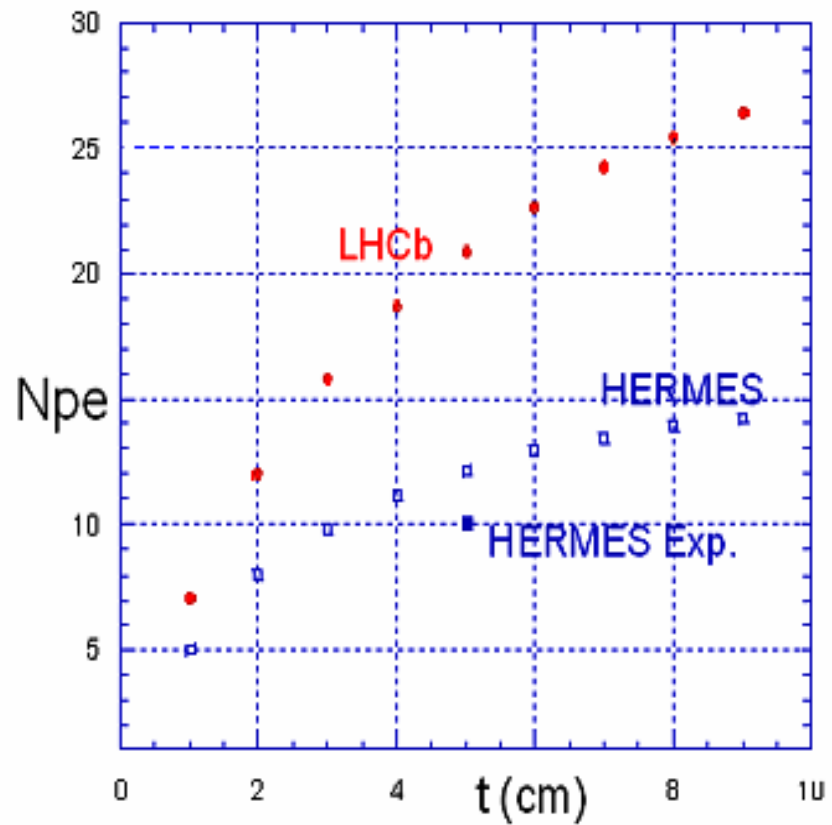

BELLE upgrade (KEK $L=10^{34} \rightarrow \approx 2*10^{35}$)

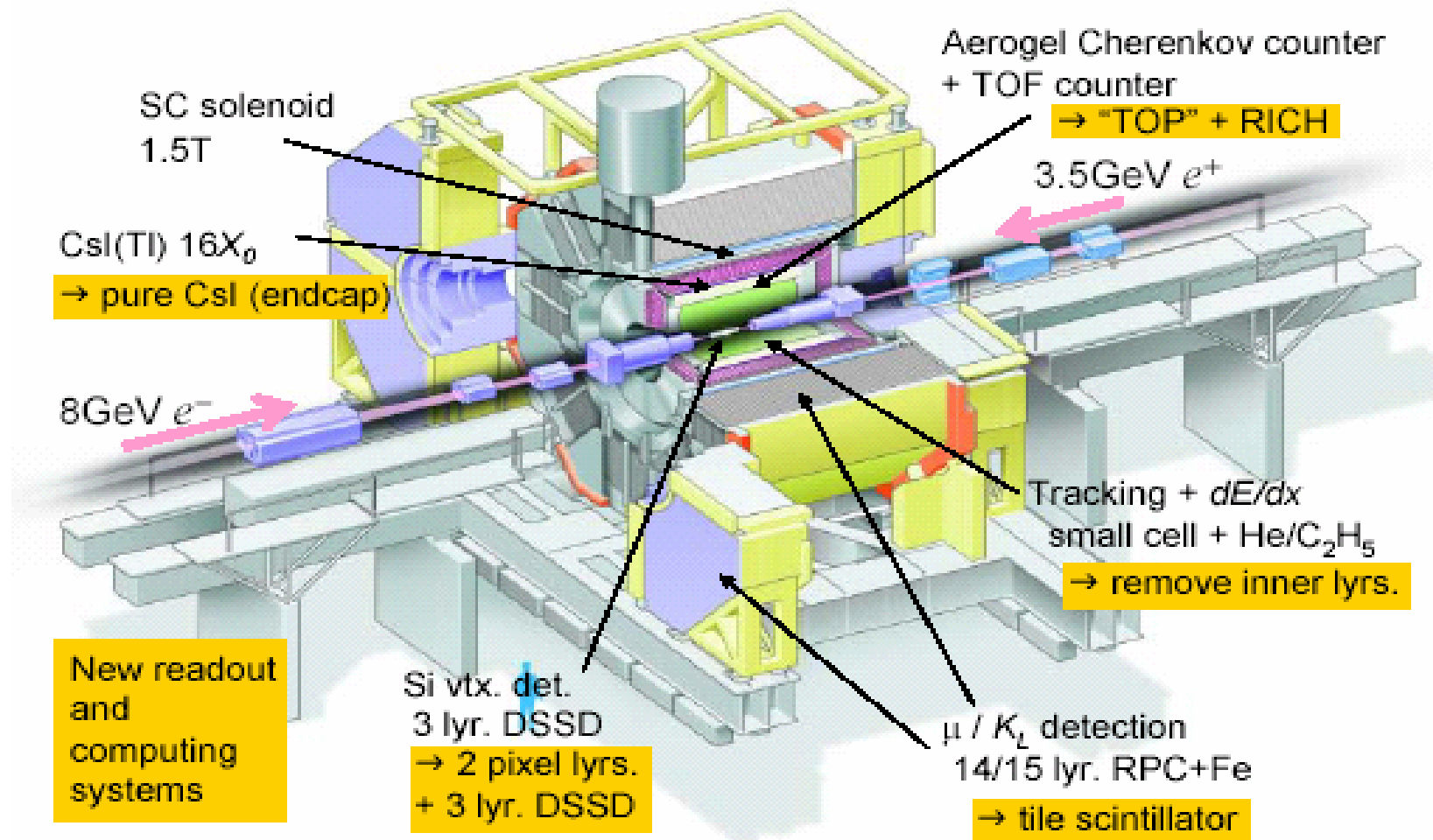

BELLE Aerogel RICH R&D

Chiba-KEK-Nagoya-Ljubljana coll.

■ focusing

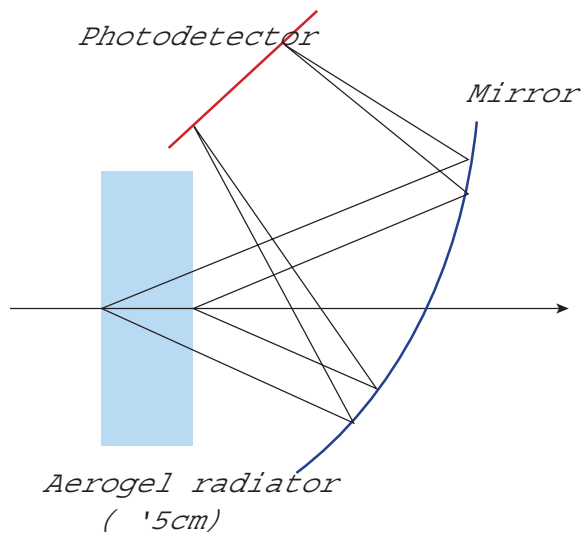

proximity focus

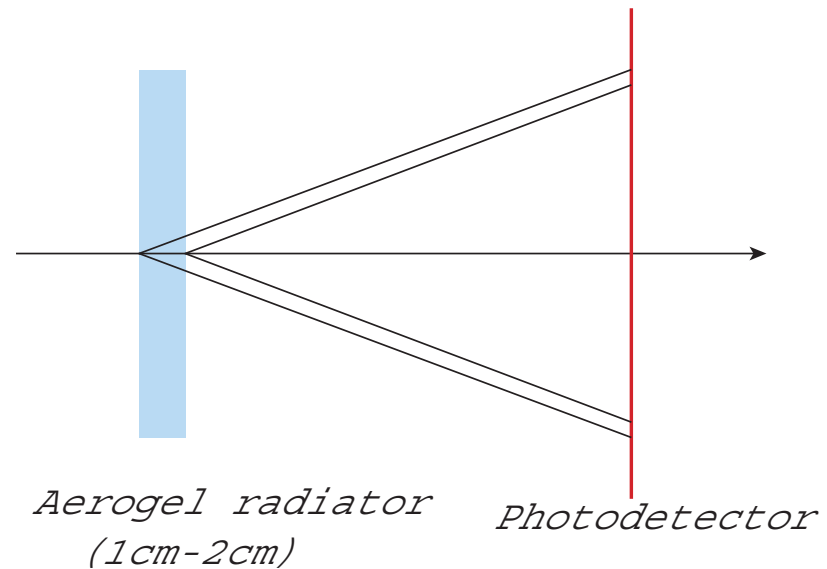

'02 beam test at $\pi 2$ KEK-PS

- New aerogel from Matsushita & Chiba-U.
- Precursor: same Methylsilicate-51 but new supplier
- Solvent: di-methyl-formamide (DMF) instead of Methyl-alcohol
- $\Lambda(400\text{nm}) = 3$ cm, $n = 1.05$, $t = 2$ cm
- H8500-M64 PMT flat panel, 6×6 mm² pixel, 84% cov.area, $\text{QE}(400\text{nm}) = 25\%$, sensit. to 1.5T

'02 beam test results

- very **clean rings** observed !
- $\delta\vartheta/\vartheta = 4.5$ %/pe, $N_{pe} = 6.3$, $\delta\vartheta(/ring) = 5.6$ mrad
- $\theta_{\pi} - \theta_K$ (4GeV, $n=1.05$) = 23 mrad \rightarrow 4 σ sep. possible
- $\delta\vartheta/\vartheta(/pe)$ accounted by **point-emiss.** & **pixel** contr.s

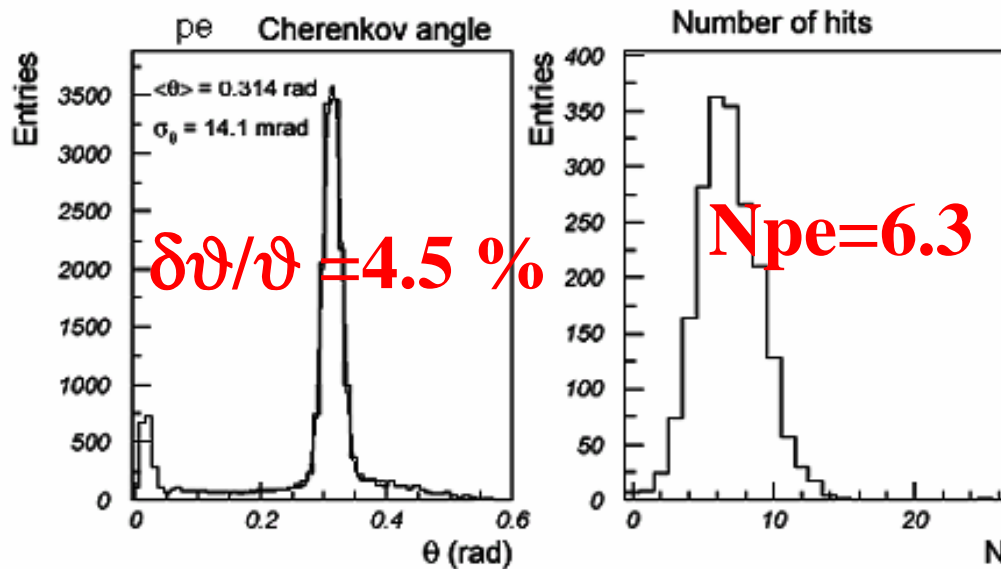

$\delta\vartheta/\vartheta = 1.8$ %/ring

■ $\sigma(/pe)$ vs t

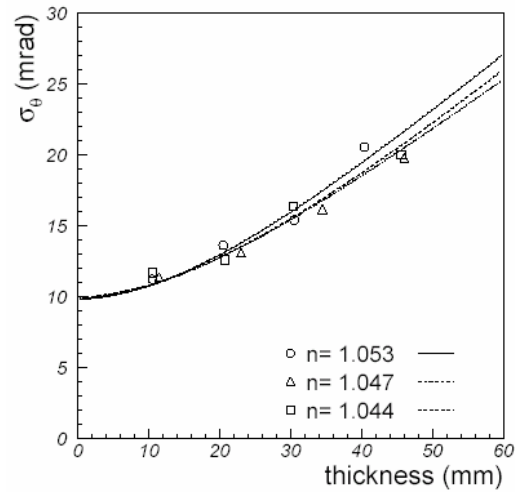

$\sigma(/pe)$ vs n

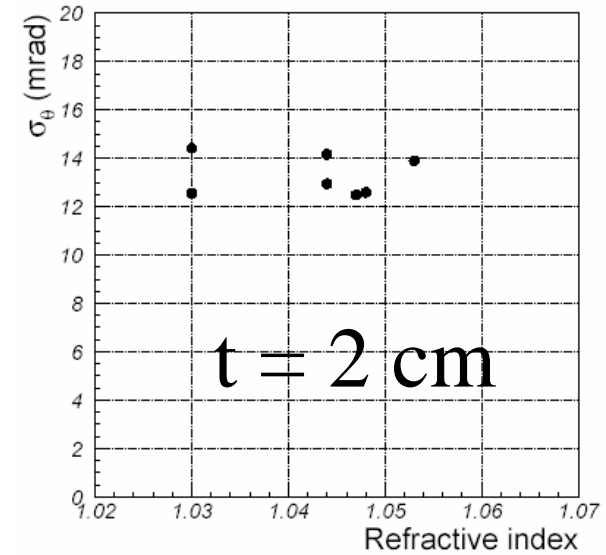

$$\sigma_{emp} = d \sin \theta_c \cos \theta_c / L \sqrt{12}$$

$$\rightarrow \sigma_{pix} = a \cos^2 \theta_c / L \sqrt{12}$$

■ e^- , μ^- , π^- at 0.5 GeV

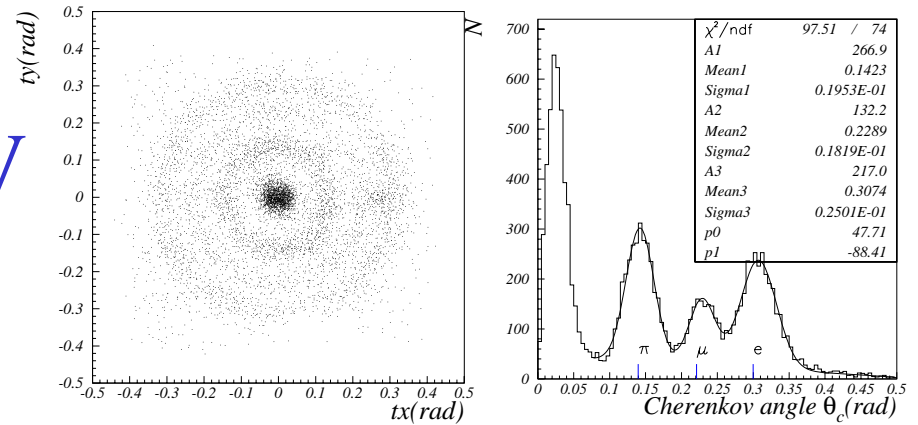

Λ vs n in new Matsushita aerogel

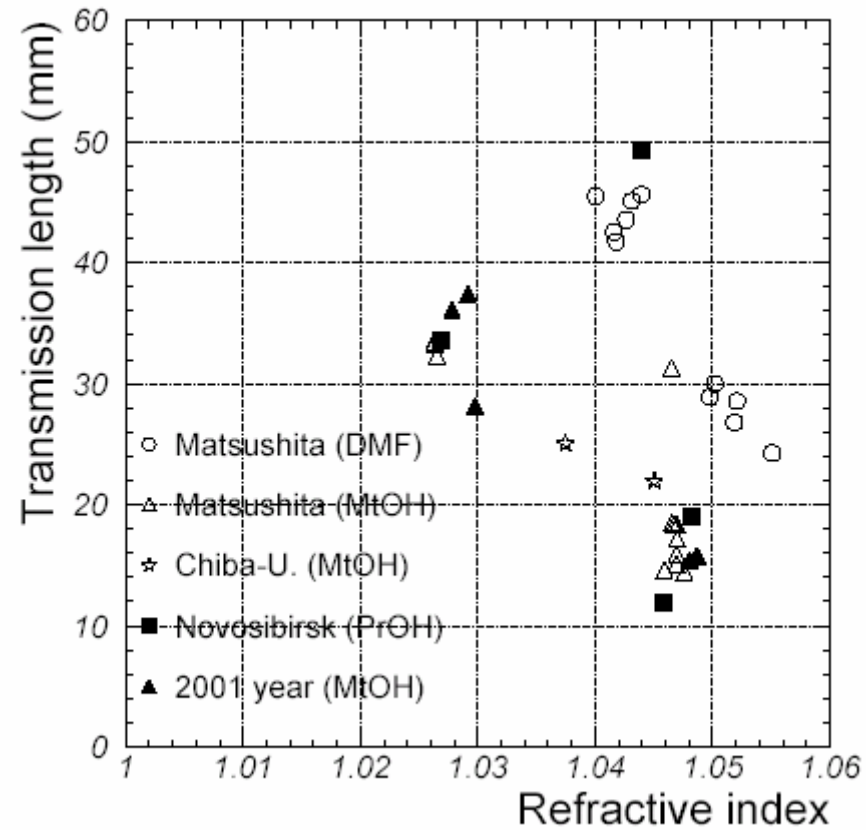

aerogel RICH summary

| aeroRICH | CERN-test | HERMES | LHCb | BELLE |
|----------------------------------|-----------|--------|------|-------|
| year | '97 | '99 | '02 | '02 |
| type | foc. | foc. | foc. | prox. |
| n | 1.03 | 1.031 | 1.03 | 1.5 |
| Λ (cm) | 2.3 | 2.3 | 4 | 4.5 |
| t (cm) | 5 | 5 | 4 | 2 |
| $\delta\theta/\theta$ (%)(/pe) | 8 | 3.3 | 2.0 | 4.5 |
| Npe | 12.8 | 10 | 10 | 6.3 |
| $\delta\theta/\theta$ (%)(/ring) | 2.3 | 1.1 | 0.6 | 1.8 |