

# LHC Computing Grid Project – LCG

## UK DTI Visit to CERN 29 June 2004

Les Robertson – LCG Project Leader  
CERN – European Organisation for Nuclear Research  
Geneva, Switzerland

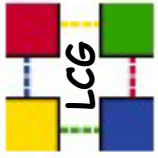



- Characteristics of HEP Computing
- Preparing the Computing Environment for LHC

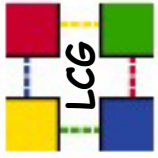

# The ATLAS Detector

- The ATLAS collaboration is
  - ~2000 physicists from ..
  - ~ 150 universities and labs
  - from ~ 34 countries
  - **distributed resources**
  - **remote development**
  
- The ATLAS detector is
  - 26m long,
  - stands 20m high,
  - weighs 7000 tons
  - has 200 million read-out channels

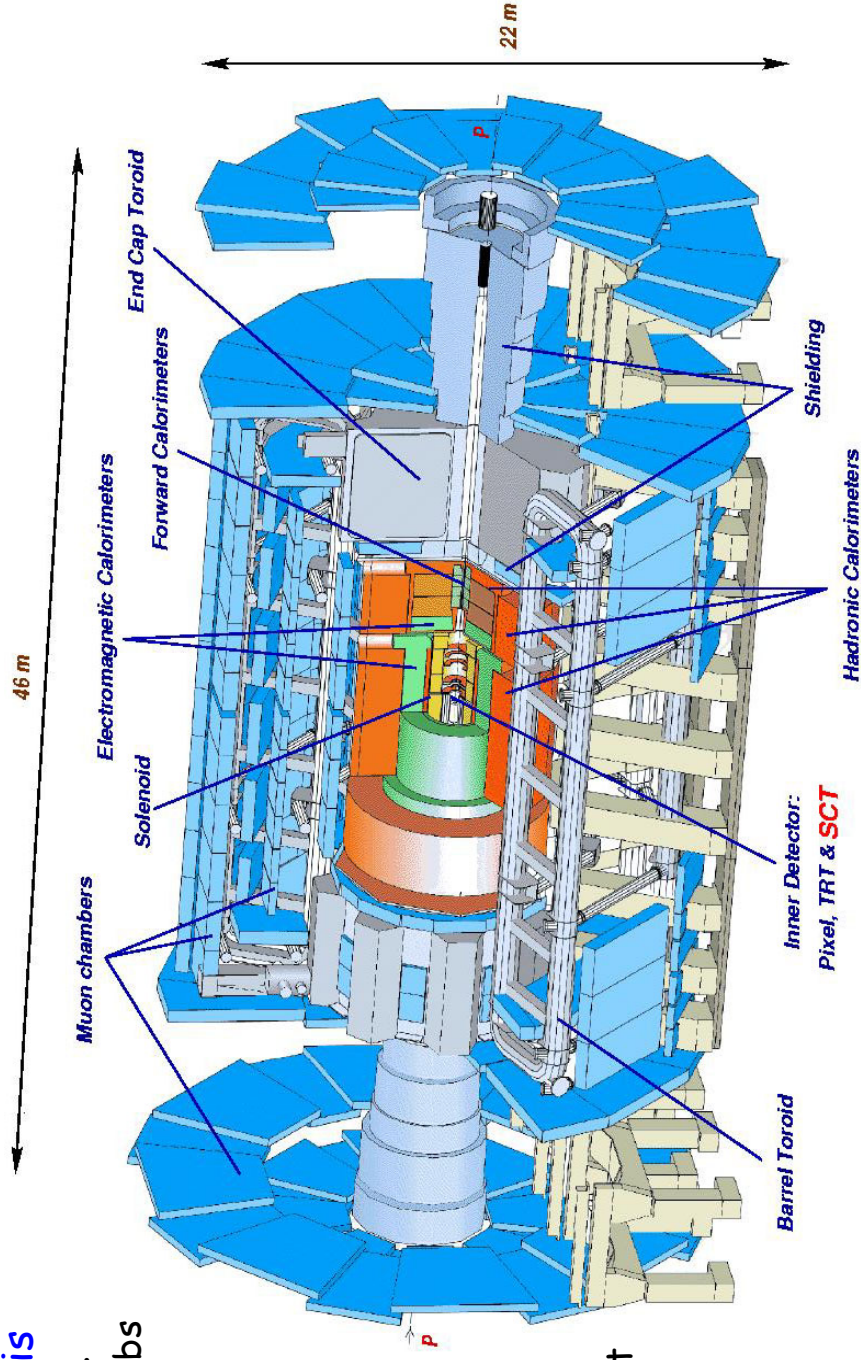



# Data Handling and Computation for Physics Analysis

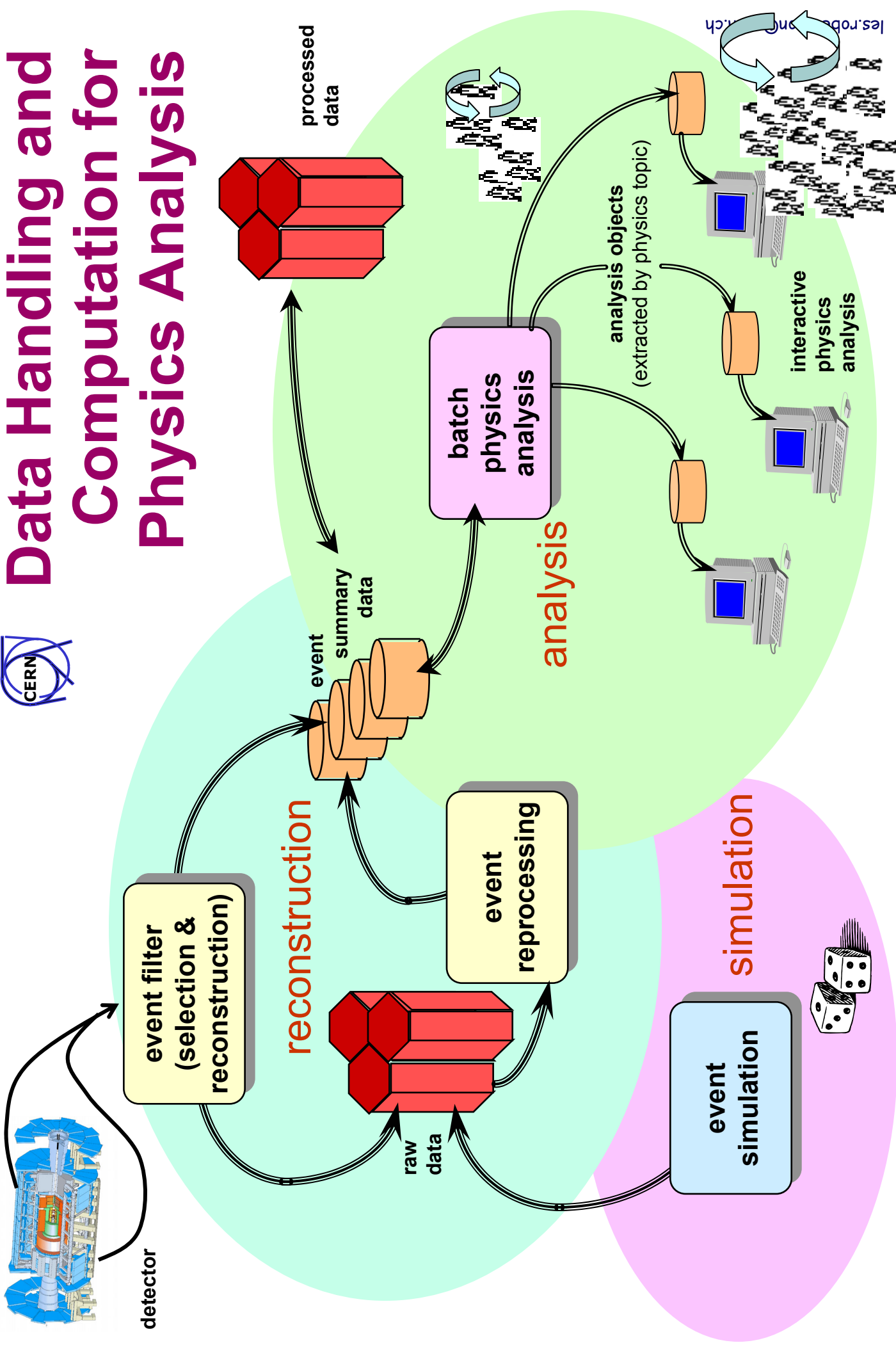

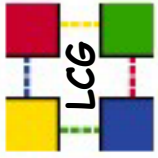

# Data Hierarchy

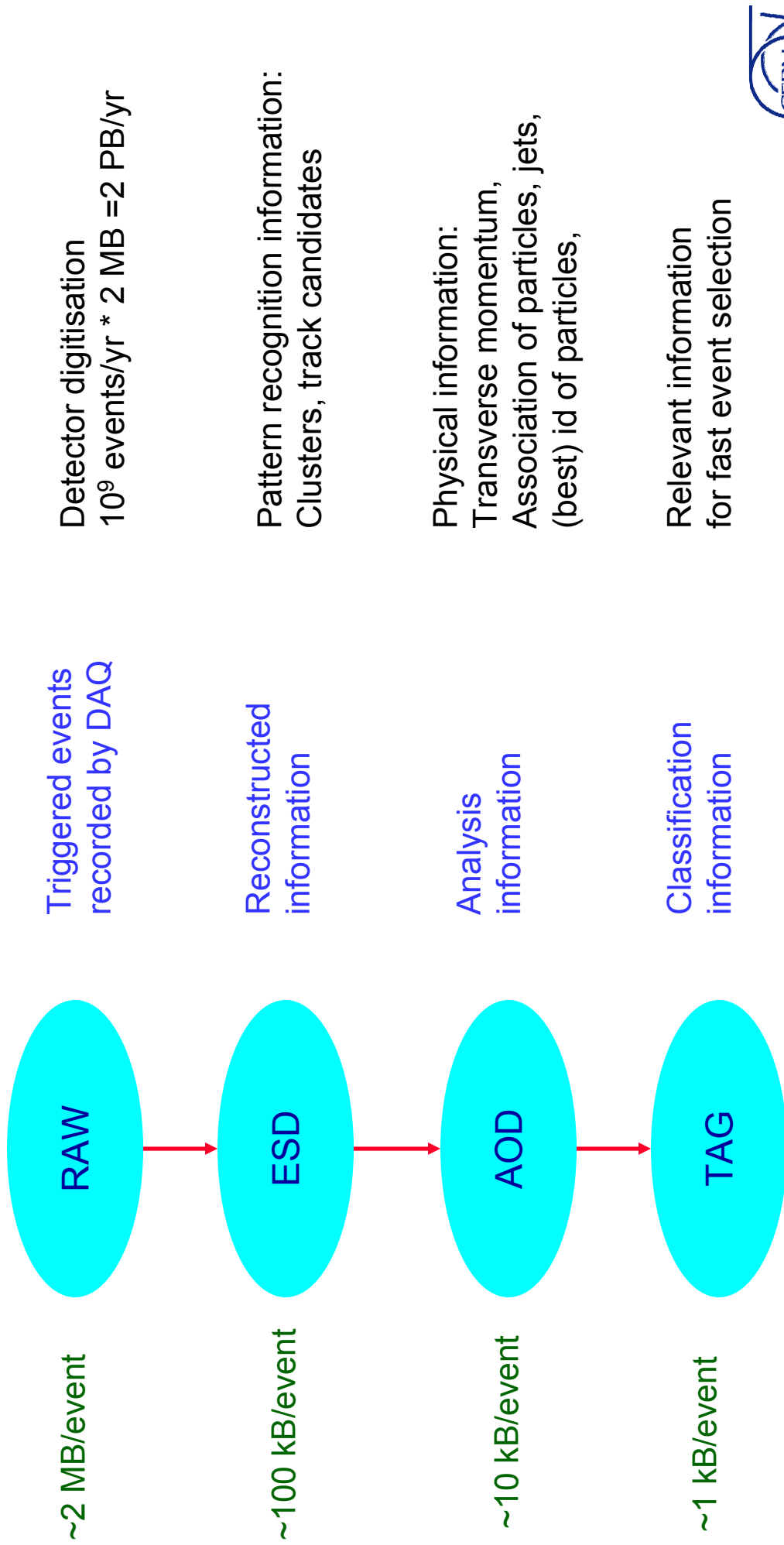

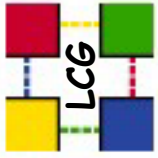

# Event Data

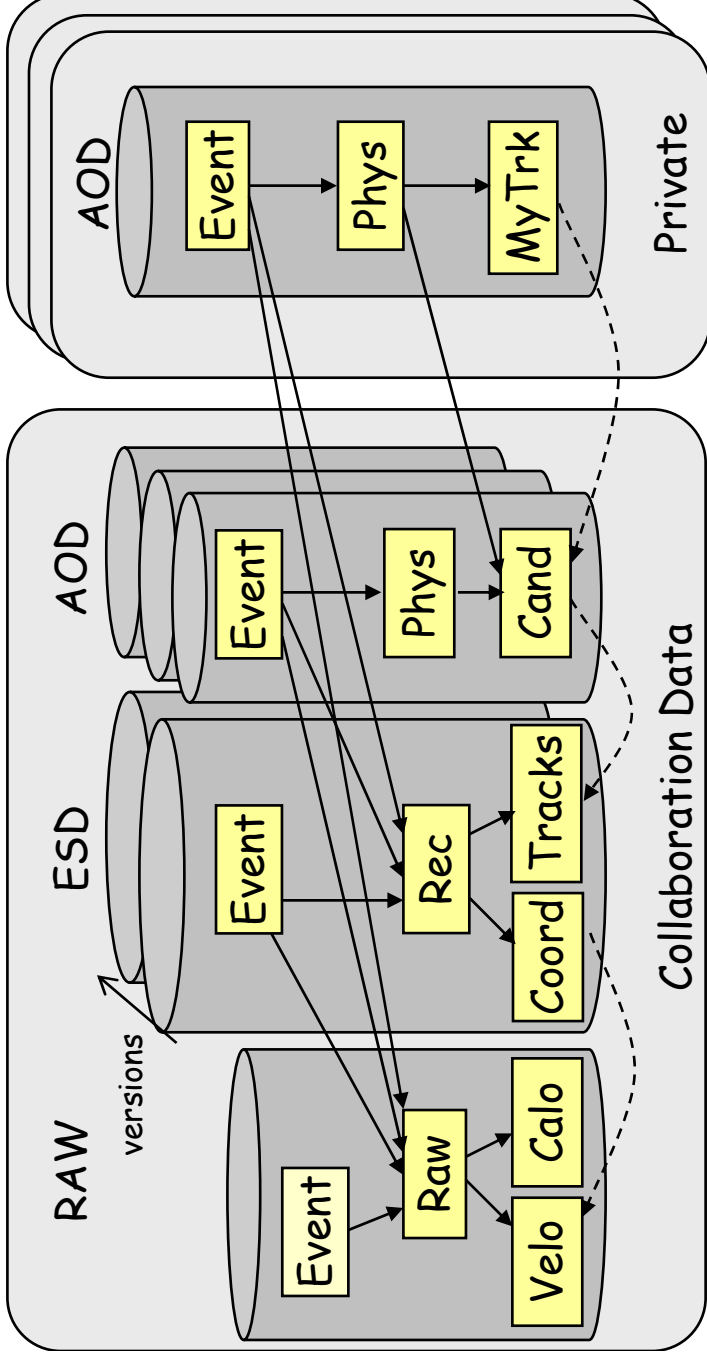

- **Complex data models**
  - ~500 structure types
- **References to describe relationships between event objects**
  - unidirectional
- **Need to support transparent navigation**
- **Need ultimate resolution on selected events**
  - need to run specialised algorithms
  - work interactively
- **Not affordable if uncontrolled**



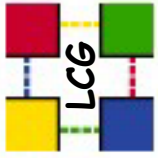

# Summary of Computing Characteristics

- small records - and most of the data is read-only
  - versions rather than updates
- meta-data (few %) in databases
- Modest I/O rates - few MB/sec per fast processor
- Modest floating point requirement - SPECint performance
- **very large aggregate requirements** - computation, data, i/o
  - need to martial the resources of many computer centres
- **chaotic workload** -
  - batch & interactive
  - research environment
    - physics analysis by collective iterative discovery
      - **unpredictable data access**
      - **no practical limit to the requirements**

Good fit for clusters of PCs





# LHC Computing Grid Project

## Aim of the project

To prepare, deploy and operate the computing environment for the experiments to analyse the data from the LHC detectors

**Applications development environment, common tools and frameworks**

**Build and operate the LHC computing service**

*The Grid is just a tool towards achieving this goal*



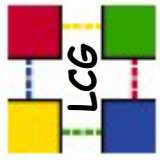

# LHC Computing Grid Project - a Collaboration

Building and operating the LHC Grid – a collaboration between

- The physicists and computing specialists from the LHC experiments
- The projects in Europe and the US that have been developing Grid middleware
- The regional and national computing centres that provide resources for LHC
- The research networks

Researchers

Software Engineers

Service Providers

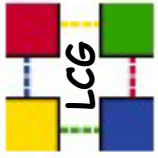

# Grid → The virtual LHC Computing Centre

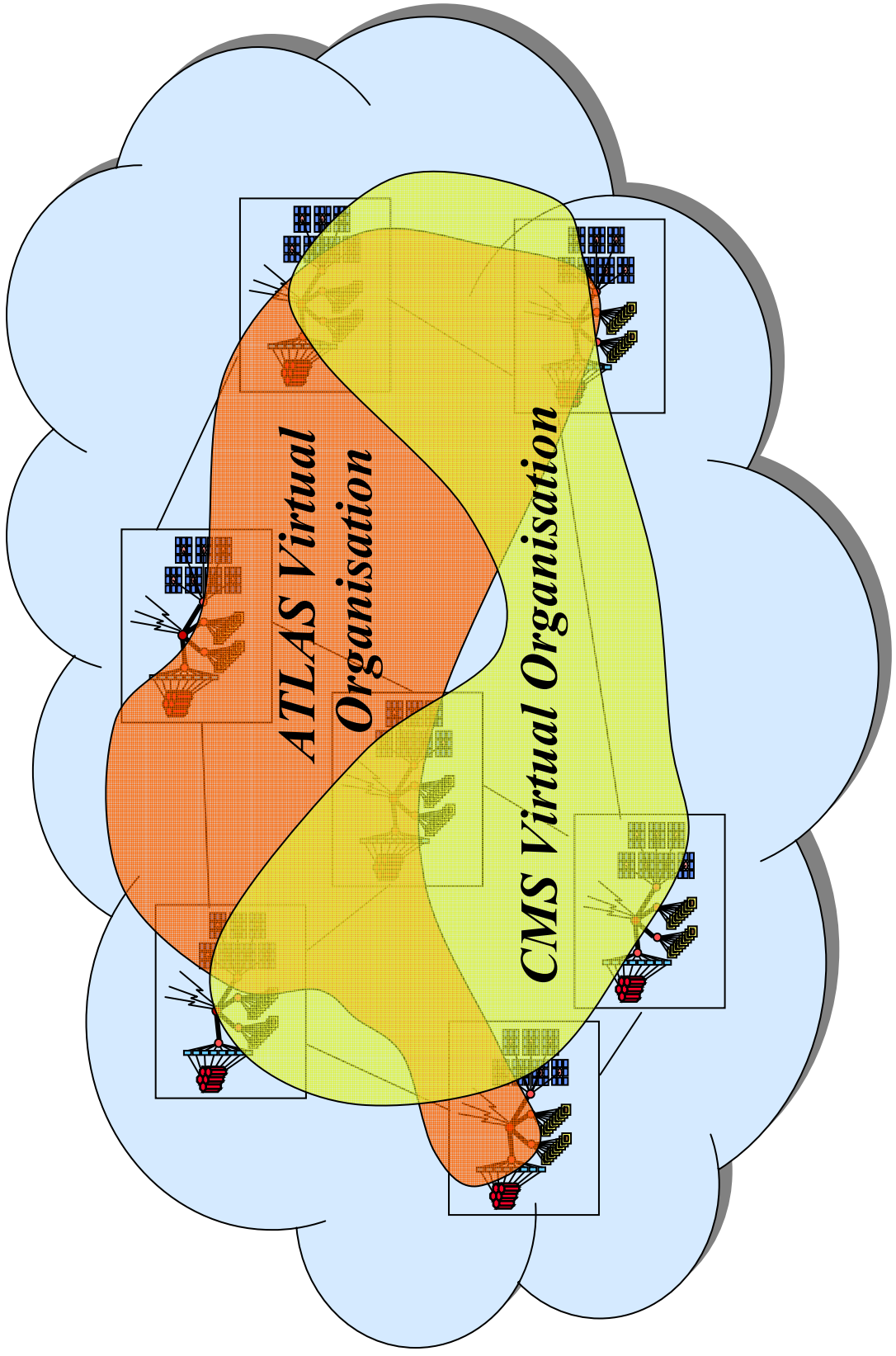

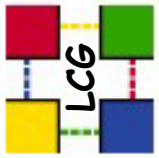

desktops  
portables

small  
centres

## LHC Computing Model (simplified!!)

- Tier-0 - the accelerator centre
  - Filter → raw data
  - Reconstruction → summary data (ESD)
  - Record raw data and ESD
  - Distribute raw and ESD to Tier-1

### Tier-1 -

- **Managed Mass Storage** – permanent storage raw, ESD, calibration data, meta-data, analysis data and databases  
→ **grid-enabled data service**
  - Data-heavy analysis
  - Re-processing raw → ESD
  - National, regional support

“online” to the data acquisition process  
high availability, long-term commitment

### Tier-2

### Tier-1

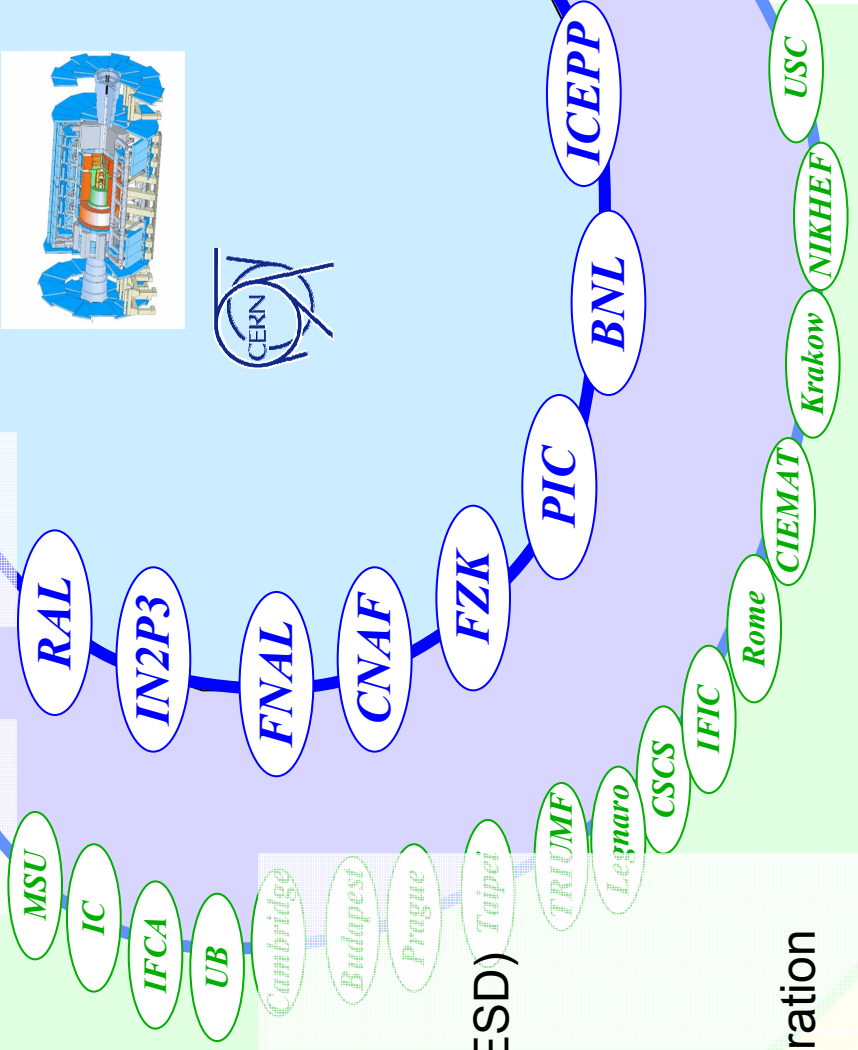

### Tier-2 -

- Well-managed disk storage – grid-enabled
- Simulation
- End-user analysis – batch and interactive
- High performance parallel analysis (PROOF)

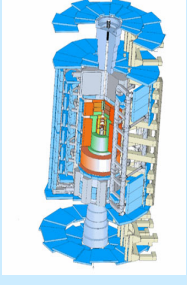
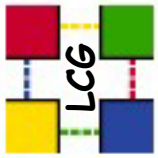

# Current estimates of Computing Resources needed at Major LHC Centres

First full year of data - 2008

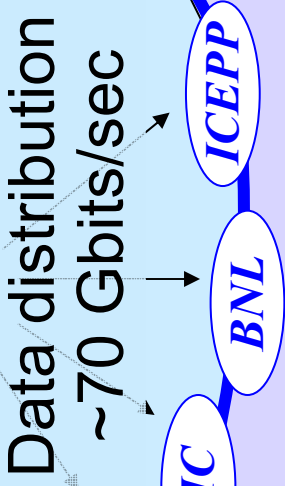

Processing  
M SI2000\*\*

Disk  
PetaBytes

Storage  
PetaBytes

CERN	20	5	20
Major data handling centres (Tier 1)	45	20	18
Other large centres (Tier 2)	40	12	5
<b>Totals</b>	<b>105</b>	<b>37</b>	<b>43</b>

\*\* Current fast processor ~1K SI2000

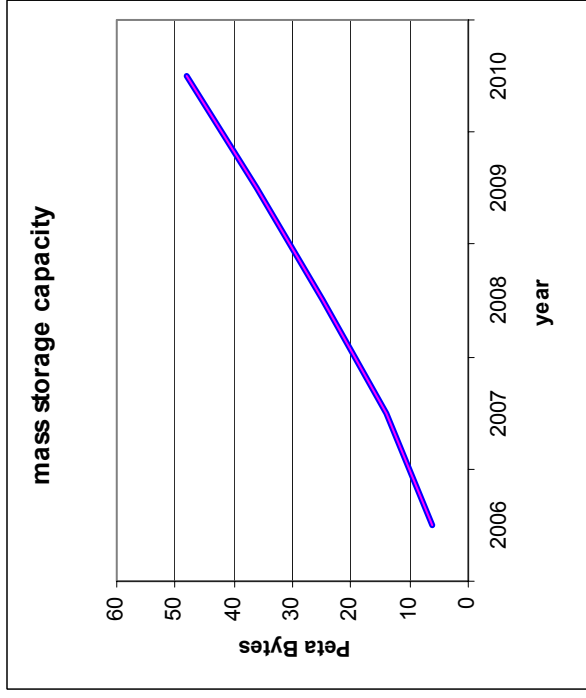
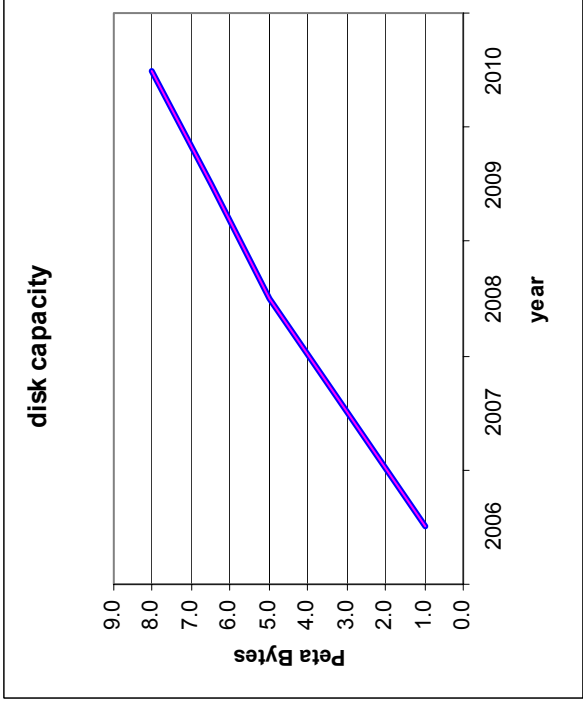
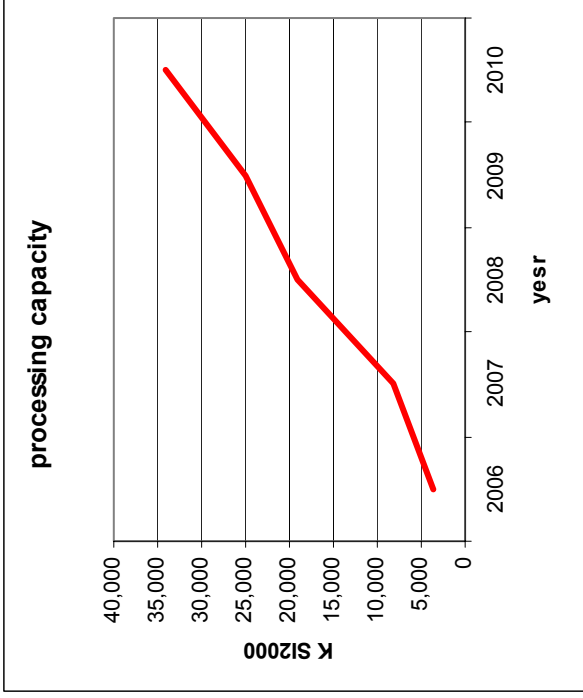
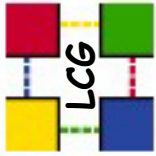

# Planned evolution of capacity at CERN for LHC experiments



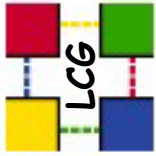

## Estimated Resources Required by LHC Experiments in 2008

First full year of data - 2008

Resource	Alice	Atlas	CMS	LHCb	Sum
<b>CERN Tier 0 + Tier 1</b>					
<i>Disk PetaBytes</i>	0.5	2.0	1.8	0.3	<b>5</b>
<i>Mass Storage PetaBytes</i>	2.3	7.6	9.2	1.0	<b>20</b>
<i>Processing M SI2000**</i>	5.6	5.4	5.7	2.7	<b>19</b>
<b>Sum of resources at all Tier1 centres</b>					
<i>Expected number of centres</i>	3	6	6	5	
<i>Disk PetaBytes</i>	3.0	6.8	8.7	1.3	<b>20</b>
<i>Mass Storage PetaBytes</i>	3.6	7.2	6.6	0.4	<b>18</b>
<i>Processing M SI2000**</i>	9.1	13.6	12.6	9.5	<b>45</b>
<b>Sum of resources at all Tier2 centres</b>					
<i>Expected number of centres</i>	16	24	25	15	
<i>Disk PetaBytes</i>	3.0	3.8	5.0	0.6	<b>12</b>
<i>Mass Storage PetaBytes</i>	0.0	1.6	2.9	0.0	<b>5</b>
<i>Processing M SI2000**</i>	7.2	8.4	7.5	16.4	<b>40</b>

\*\* Current fast processor ~1K SI2000

Estimates prepared as input to the MoU Task Force  
Computing models under active development



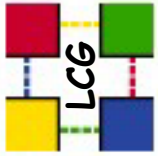

## Estimated Network Bandwidth in 2008 between Tier-1s and Tier-0

Gbits/sec	Tier-1 Centre	RAL	Fermilab	Brookhaven	Karlsruhe	IN2P3	CNAF	PIC (Barcelona)	T0 Total
<b>Estimated T1</b>									
<b>Bandwidth Needed**</b>	6.9	1.7	4.2	6.9	6.9	6.9	6.9	4.4	38
<b>Assumed Bandwidth</b>									
<b>Provisioned</b>	10	10	10	10	10	10	10	10	70

\*\* Does not include traffic between Tier-1s and with Tier-2s

Assumes that all Tier-1s share the load equally





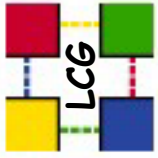

# LHC Grid Service

[http://goc.grid-support.ac.uk/gppmonWorld/gppmon\\_maps/lcg2.html](http://goc.grid-support.ac.uk/gppmonWorld/gppmon_maps/lcg2.html)

**> 60 sites**  
**> 4K cpus**

*In process of being connected:*

IHEP, Beijing  
TIFR, Mumbai  
NCP, Islamabad

H-P Puerto Rico

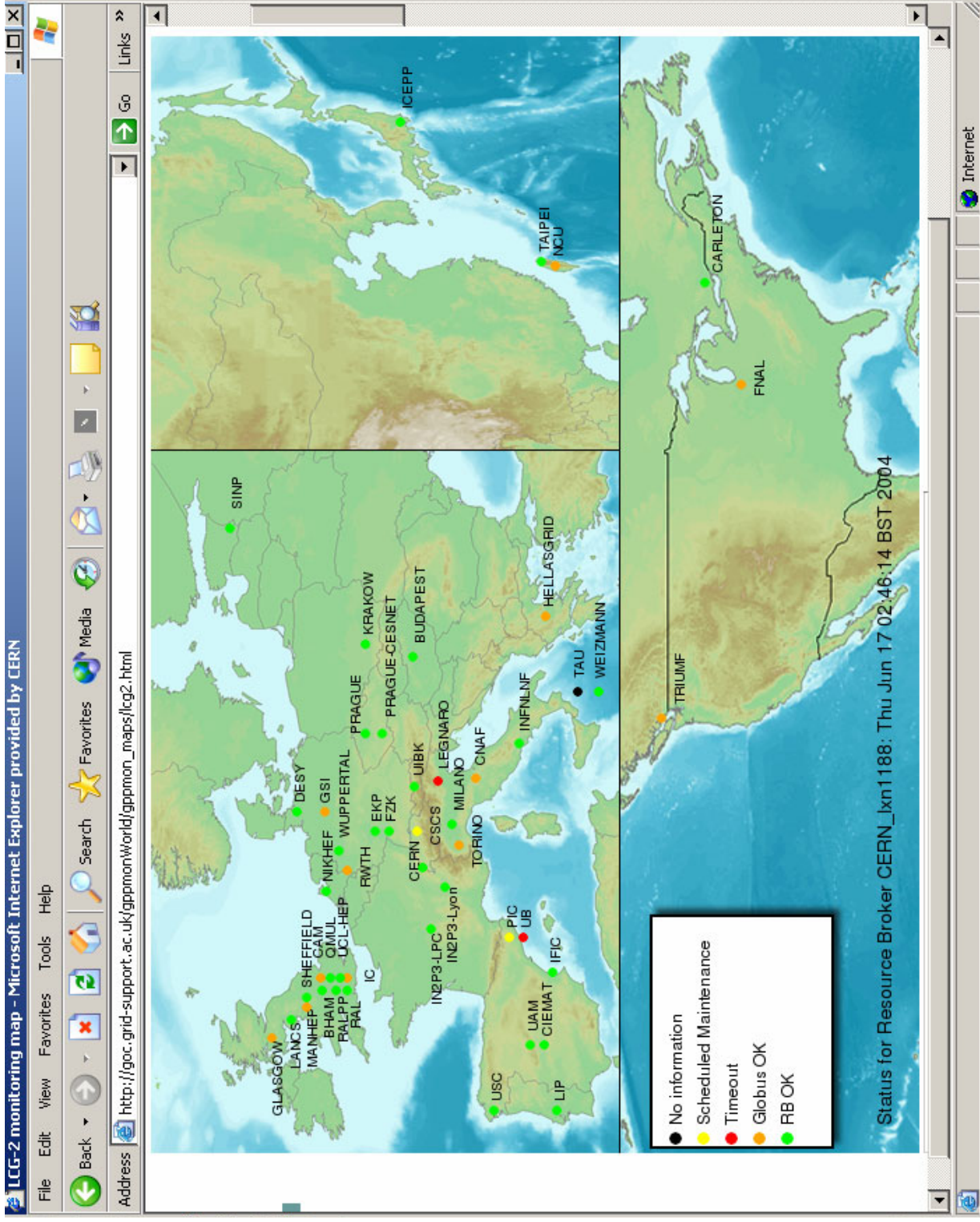

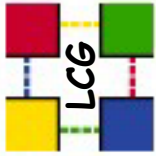

# Sites in LCG-2 - 4 June 2004

<b>Austria</b>	U -Innsbruck			Switzerland	<b>CERN</b>
<b>Canada</b>	<b>Triumf</b> Alberta Carleton Montreal Toronto			Taiwan	<b>CSCS</b> <b>ASCC</b> NCU
<b>Czech Republic</b>	Prague - FZU Prague - CESNET			UK	<b>RAL</b> RAL - Physics Universities: Birmingham Cambridge Glasgow Imperial Lancaster Manchester Queen Mary Sheffield UCL
<b>France</b>	<b>CC-IN2P3</b> Clermont - Ferrand	Italy	<b>CNAF</b> Frascati Legnaro Milano Napoli Roma Torino		<b>BNL</b> <b>FNAL</b>
<b>Germany</b>	<b>FZK</b> Aachen DESY Wuppertal HellasGrid	Japan	<b>Tokyo University (ICEPP)</b>		
		Netherlands	NIKHEF		
		Pakistan	NCP		
		Poland	CYFRONET (Krakow)		
		Portugal	LIP		
		Russia	SINP - Moscow JINR - Dubna		
<b>Greece</b>		Spain	<b>PIC</b> Univ. Autonoma de Madrid Univ. Santiago de Compostela Univ. Barcelona IFCA Santander CIEMAT Madrid IFIC Valencia	US	
<b>Hungary</b>	Budapest (KFK)				
<b>Israel</b>	Tel - Aviv Weizmann				

In preparation/certification –

- India – Tata Institute, Mumbai
- China – IHEP, Beijing
- New Zealand
- HP – Puerto Rico (and other HP sites)

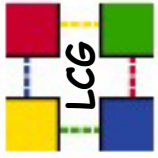

# The LCG-2 service for the 2004 Data Challenges

- **LCG-2 target**
  - the 2004 “**LHC Data Challenges**”
- Large-scale tests of the experiments’ computing models, processing chains, grid technology readiness, operating infrastructure
- ALICE and CMS data challenges started at the beginning of March
- LHCb and ATLAS – started at the beginning of May
- **The big challenge for this year** –
  - **data** –
  - file catalogue,
  - replica management,
  - database access,
  - integrating mass storage

**Grid Operations Centre  
at RAL**



**User Support Centre  
at FZK**



**Planning for a second operations  
& support centre in Taipei**



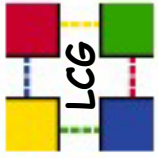

# The Challenges of Grid

*Keeping the expectations  
in line with reality!*

- **Middleware maturity -**
  - Service quality - standards  $\leftrightarrow$  innovation
  - a second (or third) generation of middleware will be needed before LHC starts
- **Grid operation -**
  - There is not yet any significant experience to build on
- **Data migration**
  - Replication, caching, security, policies
- **Collaboration**
  - From independent computer centres to a **federation**
  - **Consensus rather than control**
- **International research networking**
- **Security - our biggest risk**
- **Standards**
  - In the short-term there will be many grids and middleware implementations

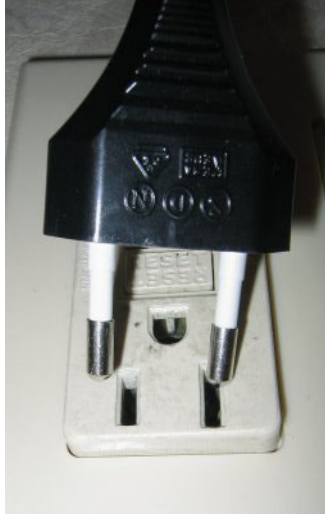



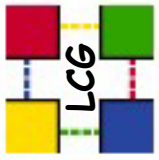

LCG-2

focus on production,  
large-scale data handling

- The service for the 2004 data challenges
- Provides experience on operating and managing a global grid service
- Strong development programme driven by data challenge experience
- Evolves to LCG-3 as components progressively replaced with new middleware

# LCG-2 and Next Generation Middleware

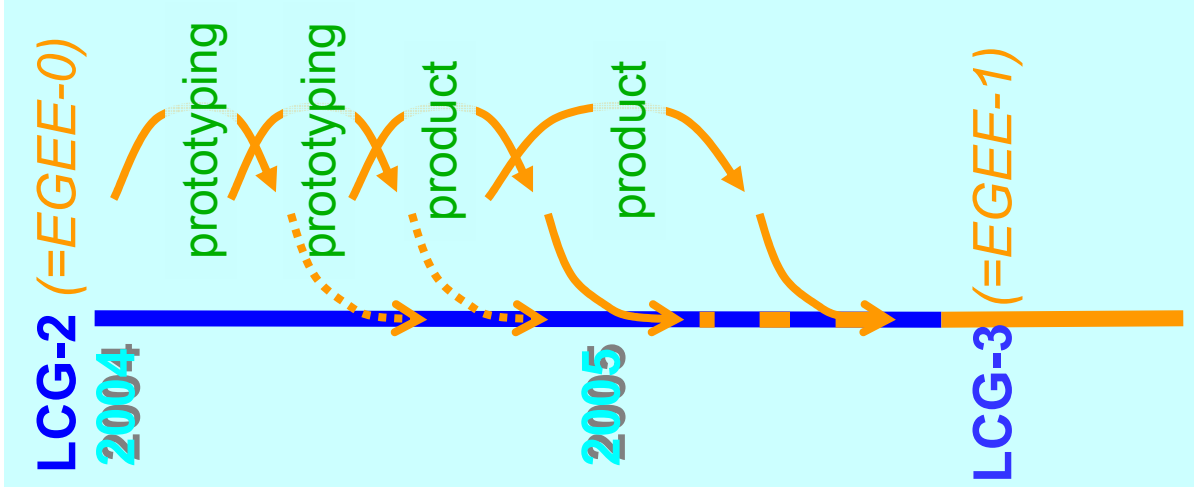

Next generation middleware  
focus on analysis

- Developed by EGEE project in collaboration with VDT (US)
- LHC applications and users closely involved in prototyping & development (ARDA project)
- Short development cycles
- Completed components integrated in LCG-2



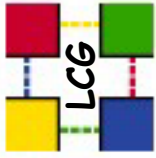

# Preparing for 2007

- 2003 – has demonstrated event production
- In 2004 we must show that we can also handle the data – even if the computing model is very simple
- This is a key goal of the 2004 Data Challenges
- Target for end of this year –
  - Basic model demonstrated using **current grid middleware**
  - All Tier-1s and ~25% of Tier-2s operating a reliable service
  - Validate security model, understand storage model
  - Clear idea of the performance, scaling, operations and management issues

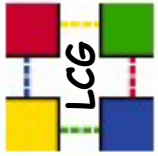

# LCG Timeline

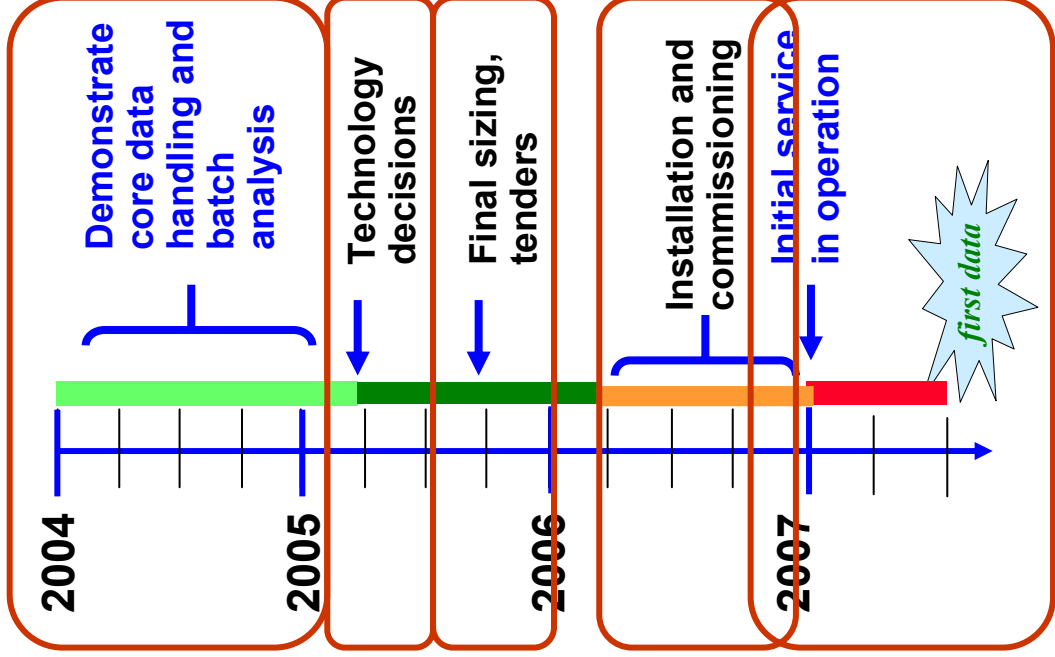



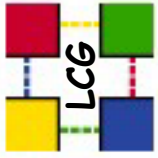

# Summary

- LHC computing -
  - Geographically distributed
  - Independent regional centres
  - **Data intensive**
- LCG-2 -
  - Reliable environment for batch work
  - Already more than 60 sites, global reach
  - Just beginning to get experience with data handling .. and grid operation and management
  - An early example of a working grid
- **Tight timescale to ramp up for LHC**

