

Dynamic Modeling and Simulation of LER-HER PEP II Rings

J. Fox, T. Mastorides, C. Rivetta, D. Teylteman, D. Van Winkle

- **Outline**
 - Goals
 - Modeling Issues
 - Dynamic Model
 - Validation
 - Results
 - Conclusion & Future lines

Goals

- Develop a reduced model of the LER-HER complex to analyze via simulation the interaction between RF cavity stations / LLRF feedback / Beam dynamics.
 - Predict high-current system behavior.
 - Understand LLRF limits.
 - Test stand for alternative LLRF processing techniques, including hardware and software concepts.
 - Test on-line algorithms for diagnostic.
 - Analysis of sensitivity of parameter / 'off-sets'.

Modeling Issues

- Beam dynamics in both rings is affected by N stations configured at different operating conditions.
- Stations are not equal: 2 - 4 Cavities per Klystron.
 - Detailed model - Very slow / Parameters - Compromise

LER-HER

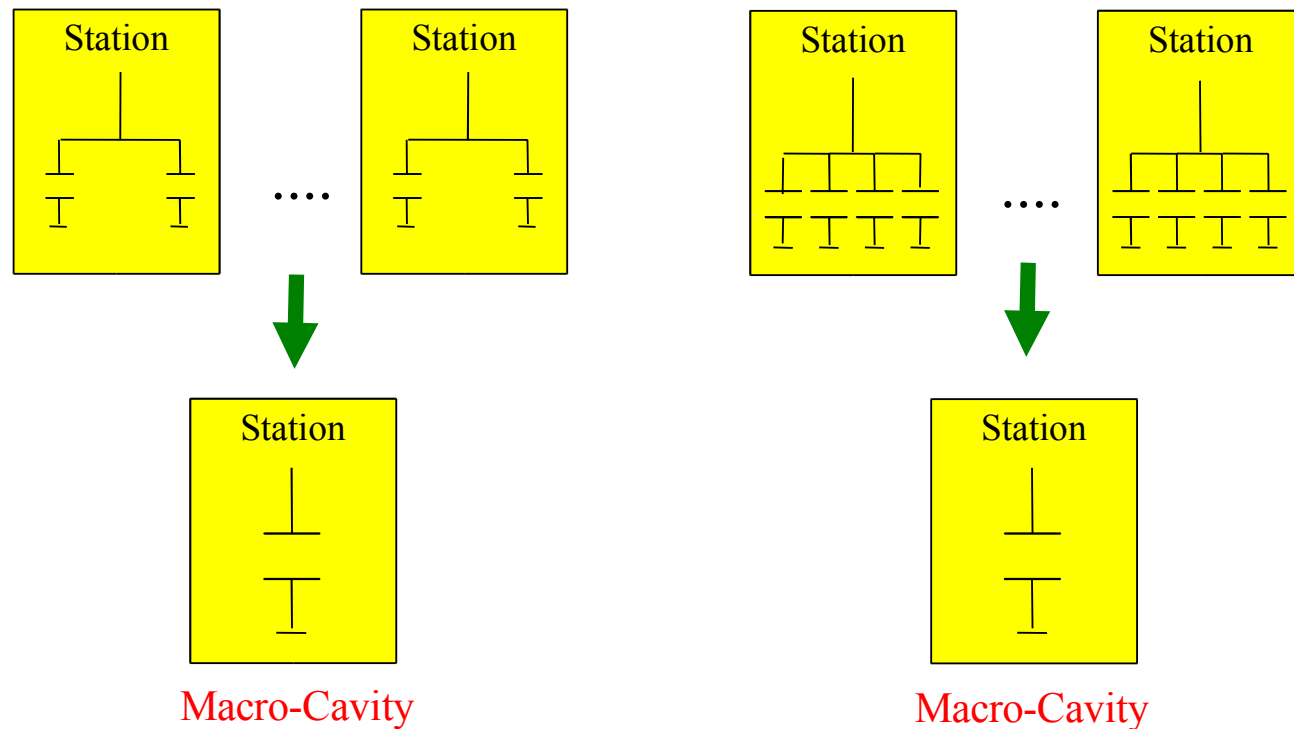

Modeling Issues

- Each station has different feedback loops operating at different 'time scale'.
 - Reduced model to improve convergence / speed
 - Slow-Fast time scale separation.
 - Slow: Blocks with time constant of several seconds/minute.
 - Fast: Include all the blocks with time constant of the order of the beams dynamic.
- Model Approach:
 - Time domain simulation (Non Linearities).
 - Macro-Cavities per 2 – 4 Cavity stations for LER-HER.
 - Linear / Non Linear Klystron.
 - Beam modeled by macro-bunches (Low Order Modes).
 - Validate parameters.

Dynamic Model

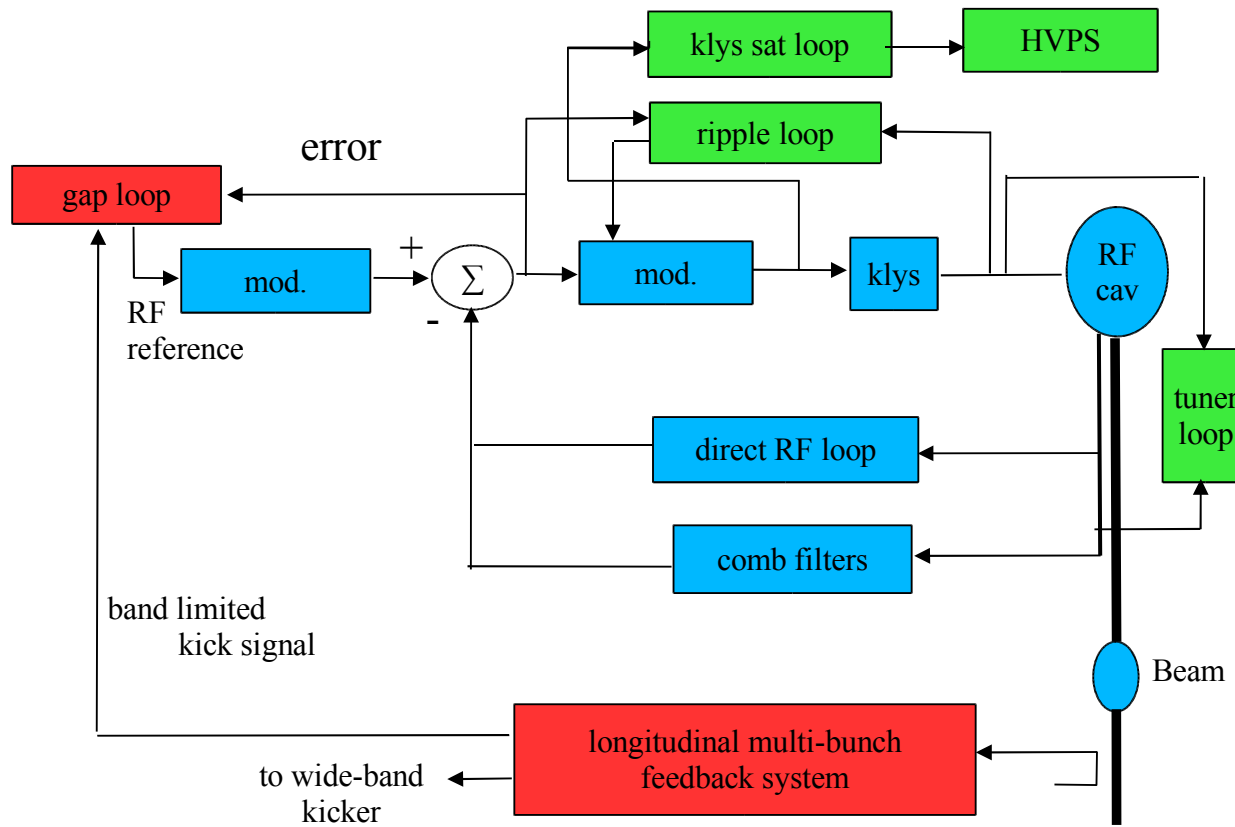

Legend
 Blue – Fast Loops
 Green – Slow Loops
 Red – Not Implemented

Dynamic Model

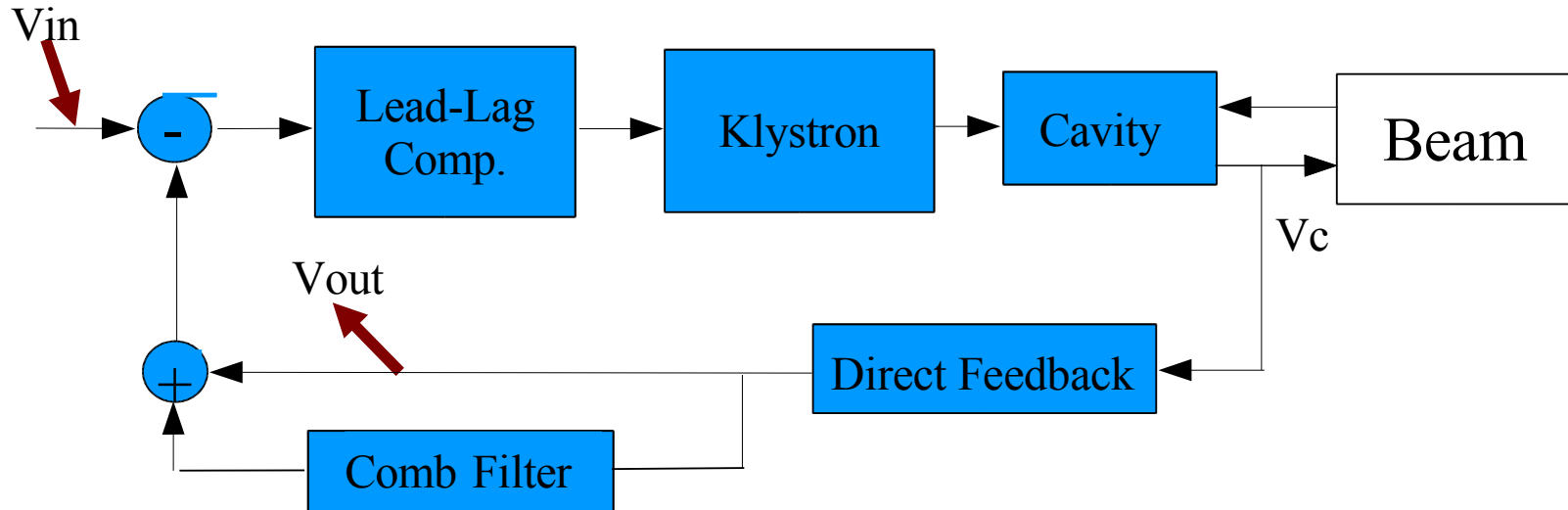

- Define the operation point of each station per ring.
- Define the parameters for the macro-cavities, feedback loops and beam to run time domain simulation.
- Estimate beam growth rates of low order modes. Analyse parameters sensitivities and performance limits.

Validation

- Compare the actual “linear TF fit” measured from the station with respect to the simulation model.

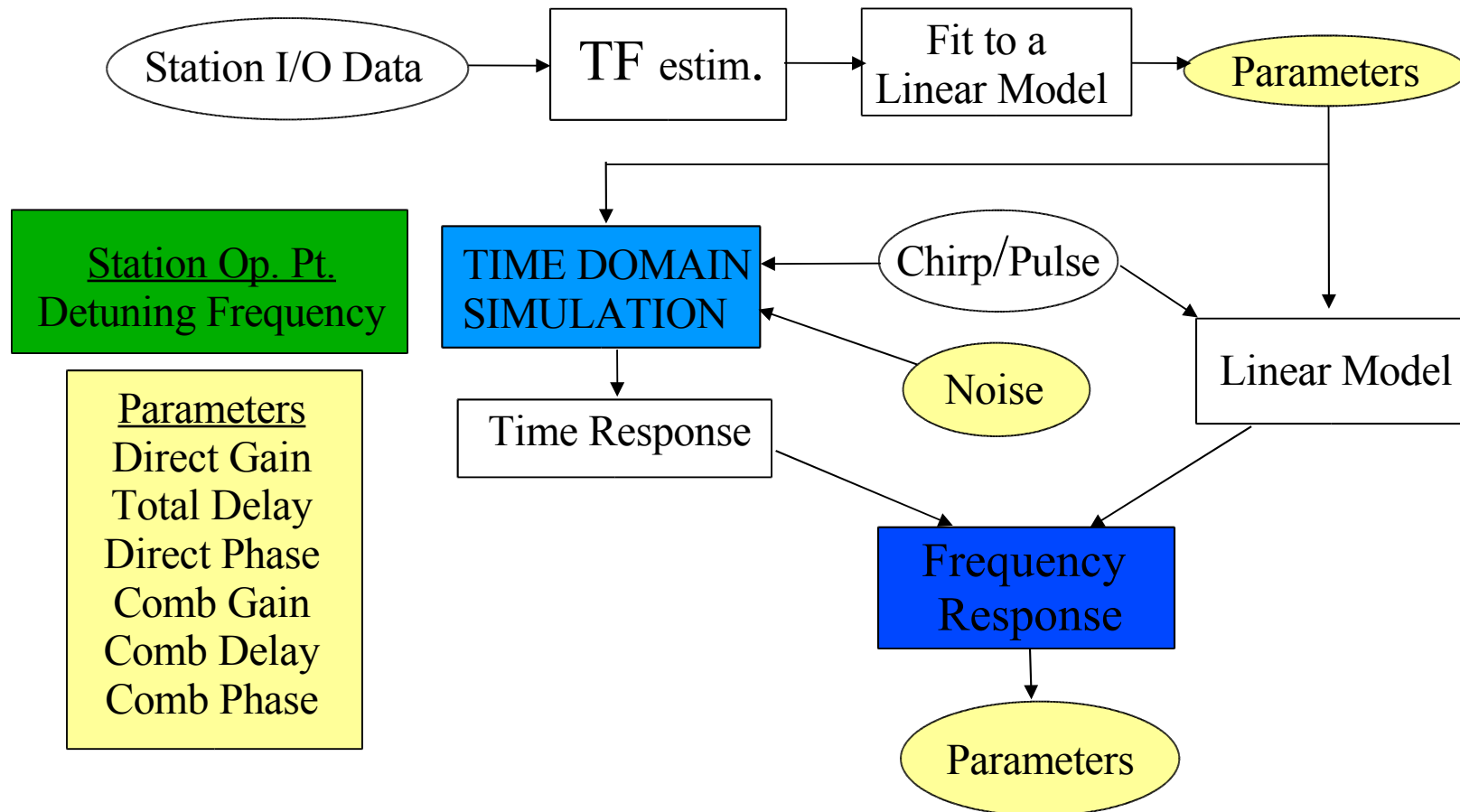

Results

- Transfer function estimate using frequency sweep – (No beam)

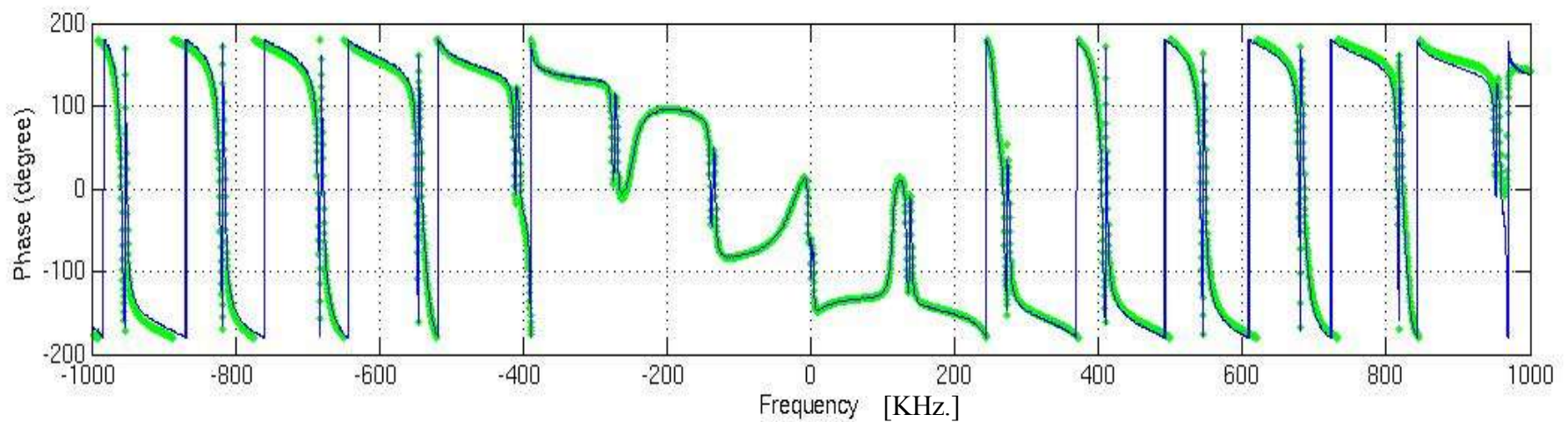
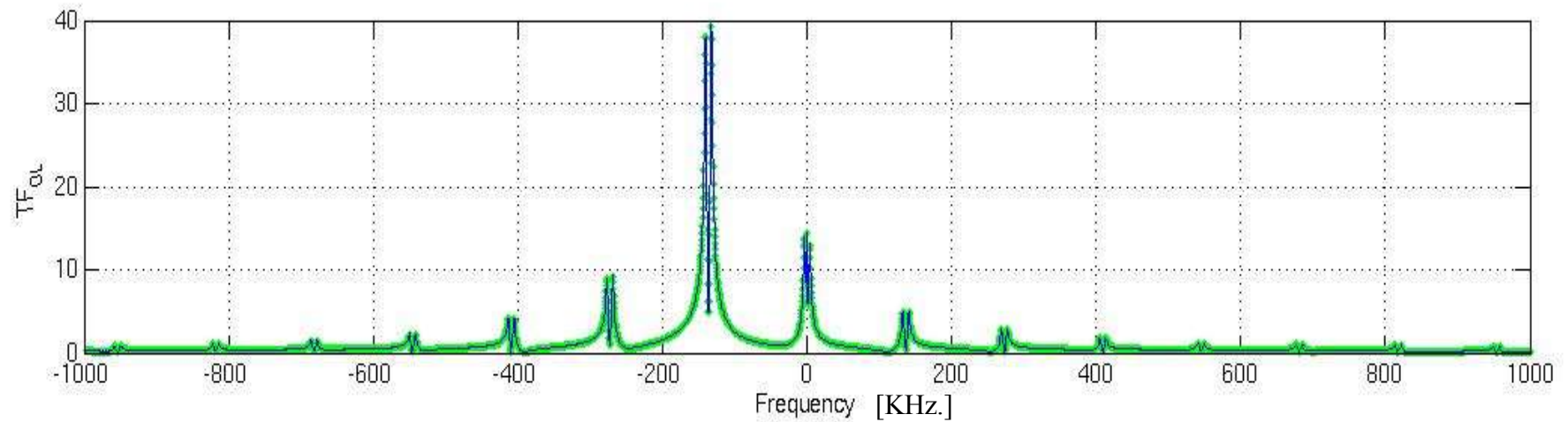

Results

- Transfer function estimate error – (Frequency sweep - No beam)

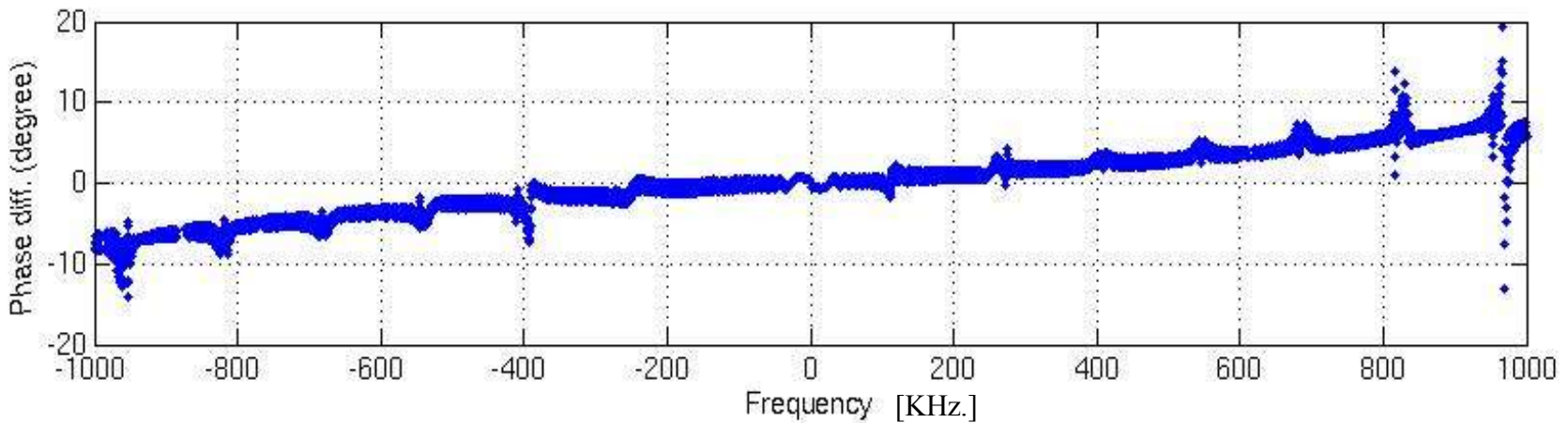
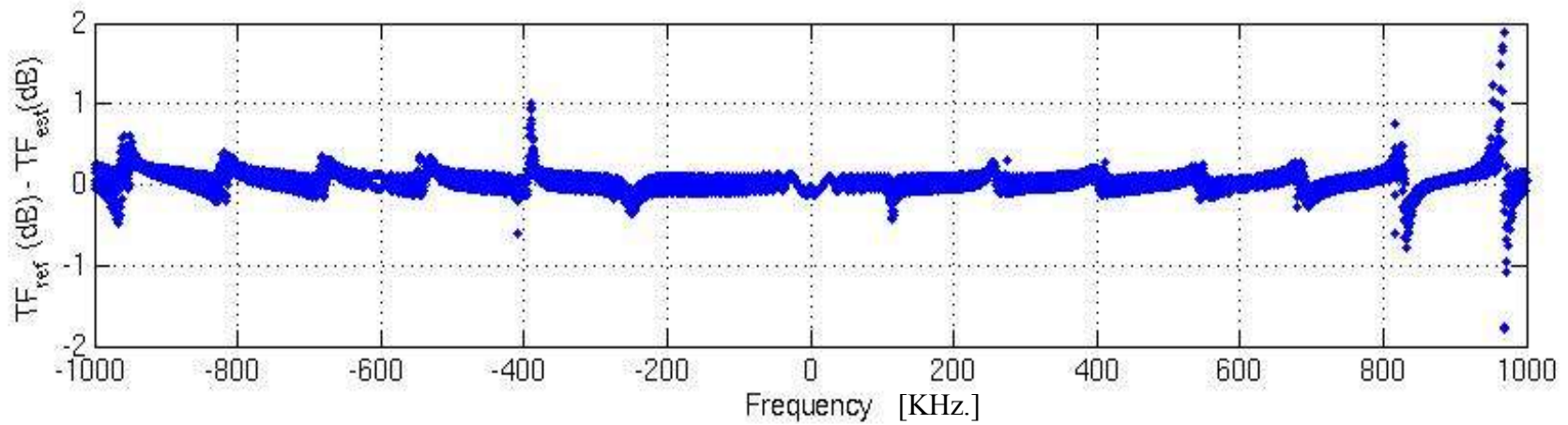

Results

- Transfer function estimate via noise injection – (No beam)

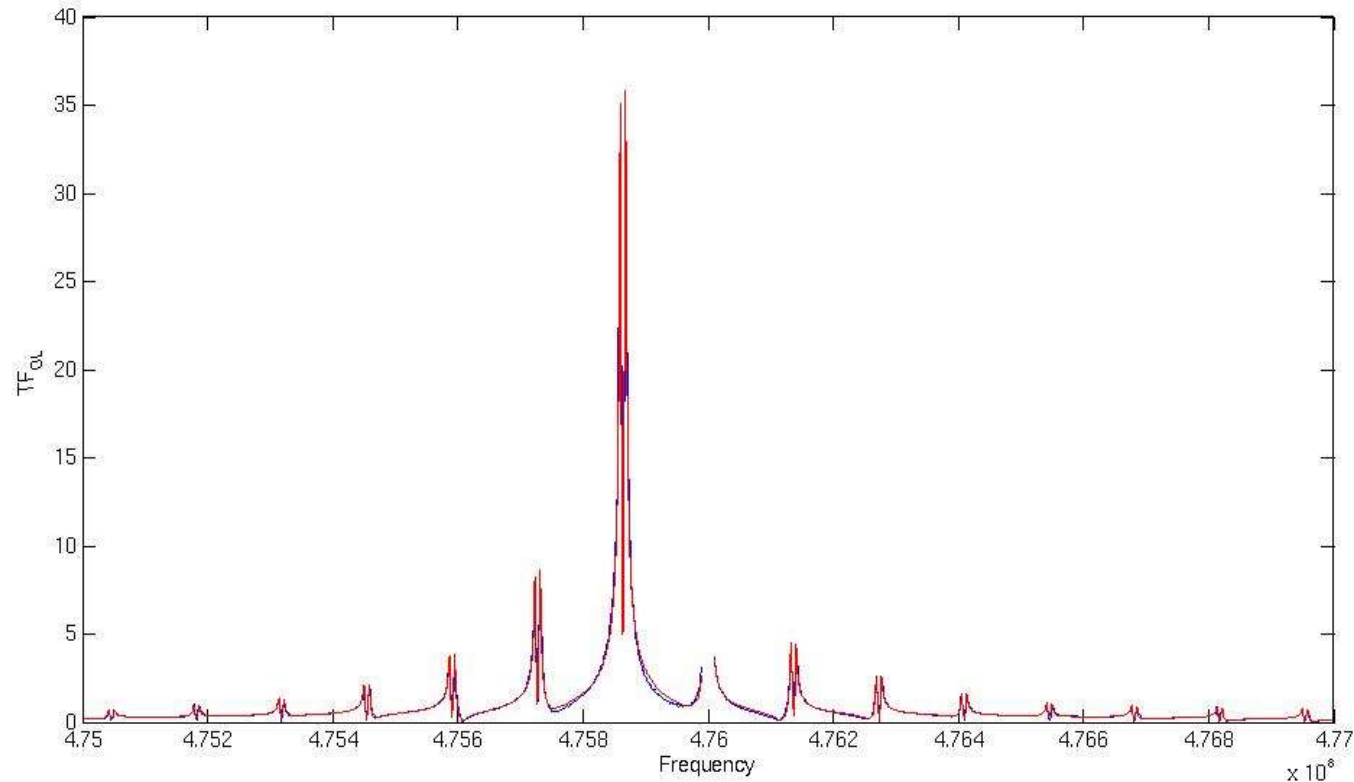

	Loaded Prms	Estimated Prms	Error %
direct gain	5.3	5.54	4.49
direct delay	3.62E-007	3.79E-007	4.87
direct phase	2.88	2.88	0.1
comb gain	0.18	0.17	4.36
comb delay	5.48E-006	5.49E-006	0.16
comb phase	0.47	0.46	3.17

Results

- LER Growth Rates ($V_g = 4.05\text{MV}$, $I_b = 2000\text{mA}$, 3 Active Stations (2 Cav/st.), 1 Parked Station.

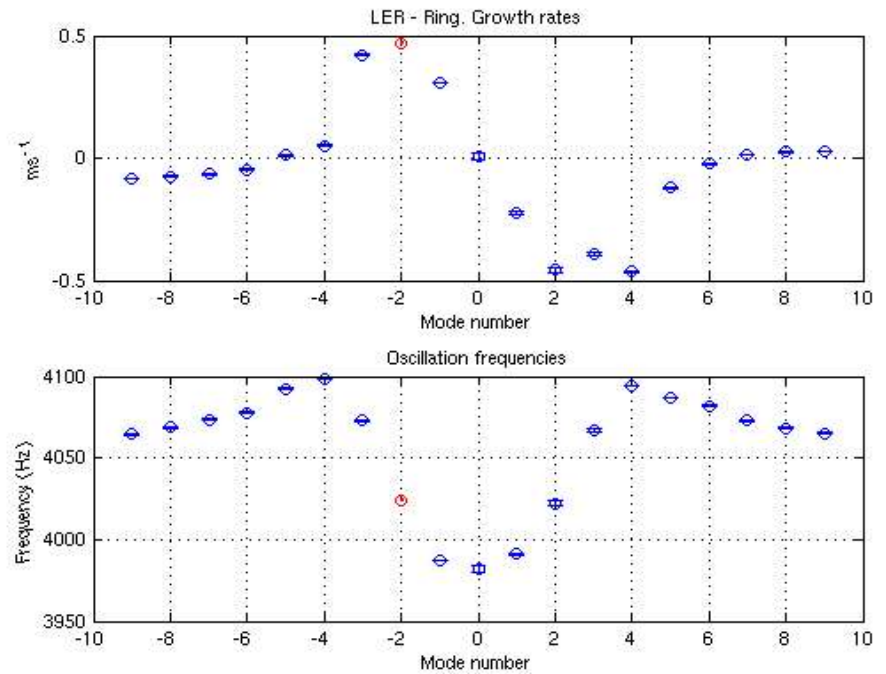
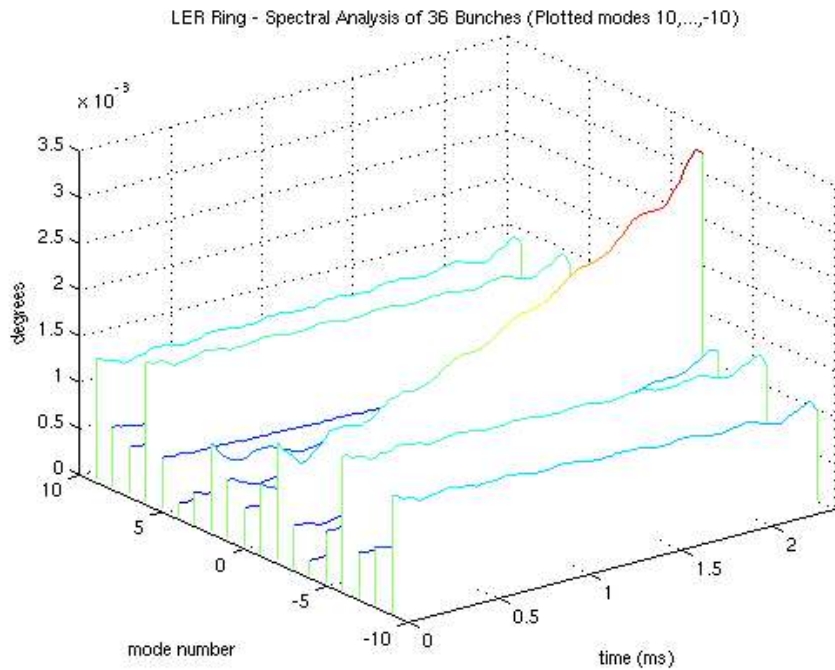

Results

- LER Growth Rates ($V_g = 4.05\text{MV}$, $I_b = 2000\text{mA}$, 3 Active Stations (2 Cav/st.), 1 Parked Station (wrong position)).

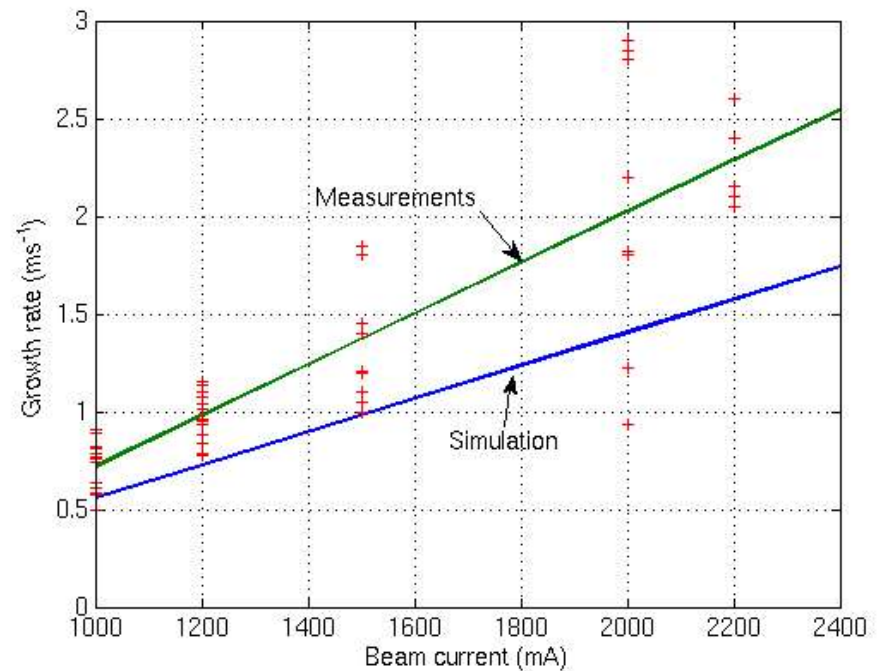
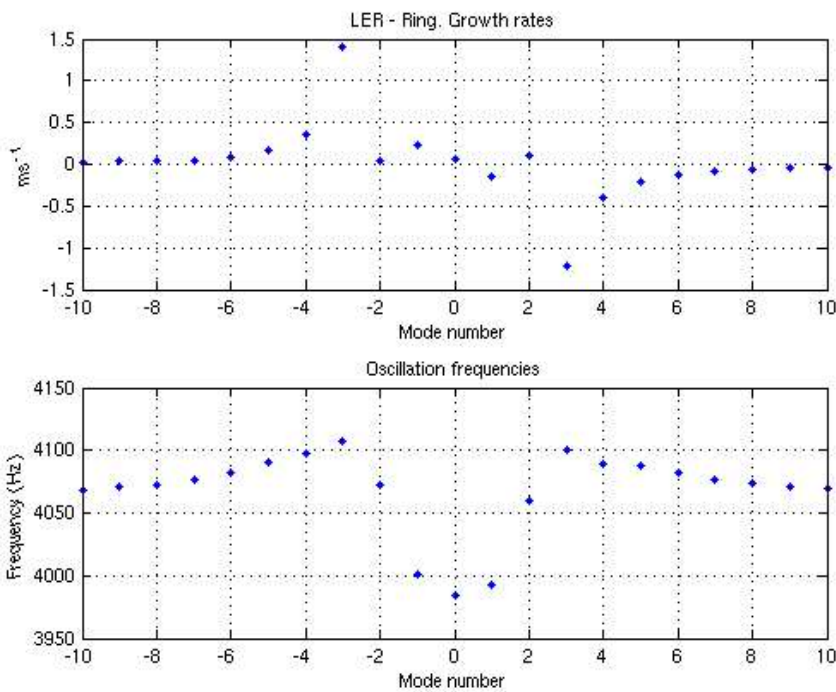

Conclusions & Future Lines

- A simulation tool is being developed to predict the behavior and limits of the LER-HER complex at high beam currents. It started from previous work developed by Richard Tighe.
- The reduced model captures both the behavior of the multiple stations defining 'macro-cavities' and the low order modal behavior of the beam by 'macro-bunches'.
- HER & LER rings have included non linear klystron models.
- Good overall agreements between simulations and measurements performed at LER ring.
- Needs better understanding in the parameter definition corresponding to the macro-cavities and feedback loops.
 - Analysis of sensitivities and error bounds.
- Still in process of validation of growth rates.