

Progress on VirCol

A Parton Shower MC based on Antenna Formalism

W. Giele (Fermilab), D. Kosower (Saclay), P. Skands (Fermilab)

QCD at High Energies

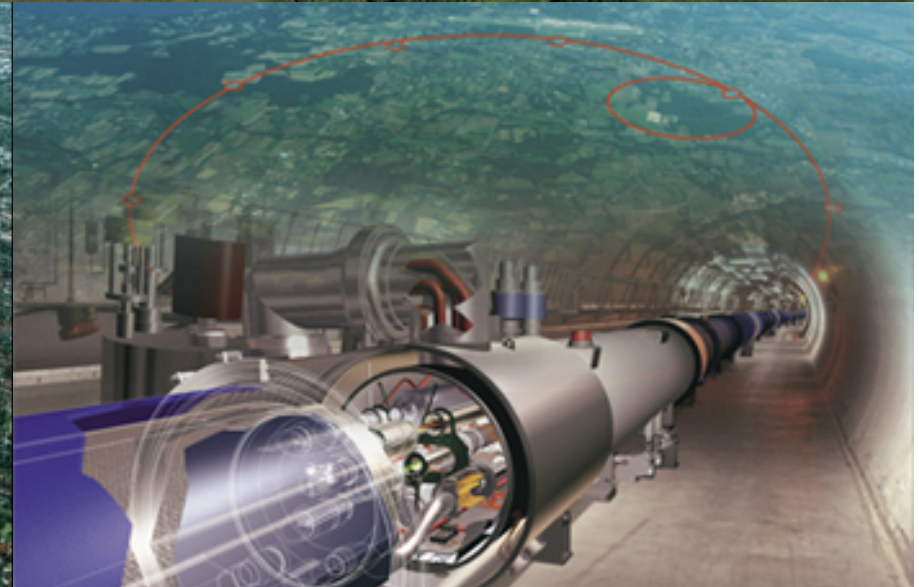
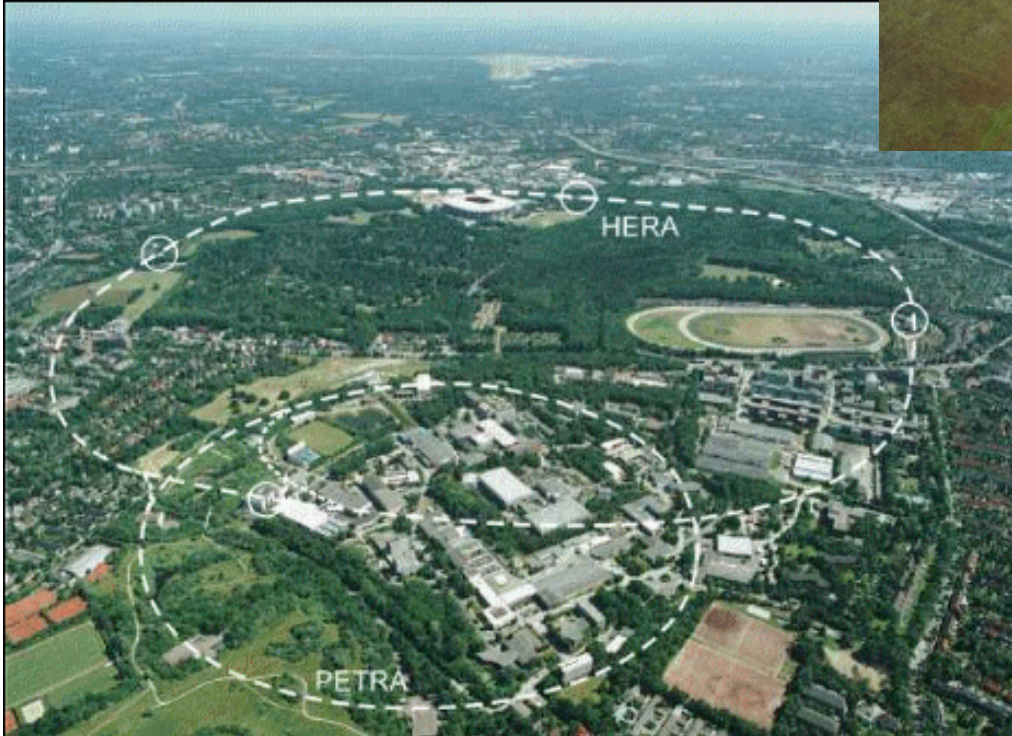
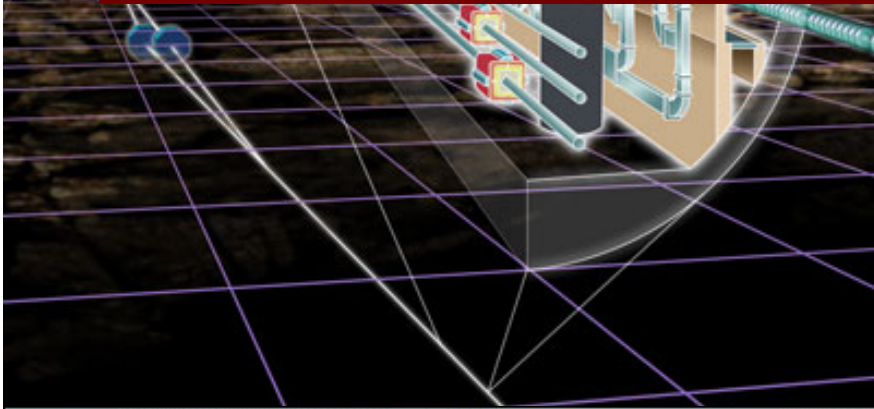

QCD at High Energies

EW/BSM/Higgs (+ Jets)
EW/BSM/Higgs precision

Parton Showers
ME/PS Matching

LO
NLO
NNLO
...

DGLAP
BFKL

LL
NLL
NNLL
...

Event Generators

Flavour Physics

Diffraction
Rapidity Gaps

Underlying Event
Beam Remnants

Hadronisation
Hadron Decays

PETRA

QCD at High Energies

EW/BSM/Higgs (+ Jets)
EW/BSM/Higgs precision

Parton Showers
ME/PS Matching

LO
NLO
NNLO
...

DGLAP
BFKL

LL
NLL
NNLL
...

Event Generators

Flavour Physics

Diffraction
Rapidity Gaps

Underlying Event
Beam Remnants

Hadronisation
Hadron Decays

PETRA

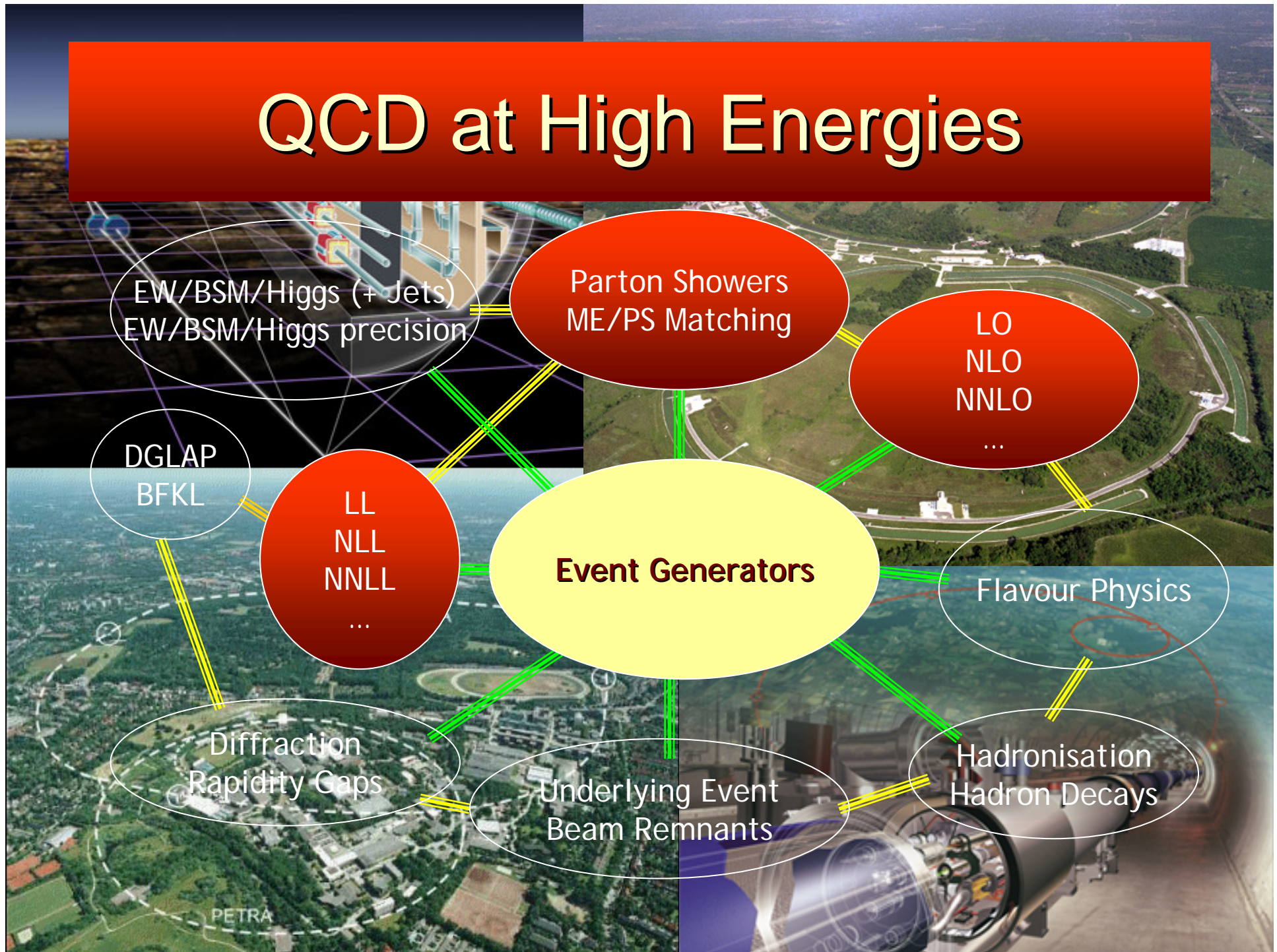

Hard & Soft

Matrix Elements (Fixed Order):

- Fixed order in α -> Exact interference, helicity, loops, ...
- At present can do 2->5/6 (less with loops)
- Perturbative expansion better at higher energy (asymptotic freedom)
- Multiple soft emissions important for full event structure = exclusive observables
- Widely separated scales -> big logs / big truncation errors.
- Phase space for soft emissions increases at high energies

Hard & Soft

Matrix Elements (Fixed Order):

- Fixed order in α -> Exact interference, helicity, loops, ...
- At present can do 2->5/6 (less with loops)
- Perturbative expansion better at higher energy (asymptotic freedom)
- Multiple soft emissions important for full event structure = exclusive observables
- Widely separated scales -> big logs / big truncation errors.
- Phase space for soft emissions increases at high energies

Parton Showers:

- Derived in universal limit of QCD \rightarrow depend on universal parameters
- Exponentiate \rightarrow infinite $O(\alpha)$ \rightarrow ideal for widely separated scales (logs resummed)
- Arbitrary number of partons in final state \rightarrow match to hadronisation descriptions
- Derived in limit (collinear) of QCD \rightarrow approx. for wide-angle / hard emissions.

Hard & Soft

Matrix Elements (Fixed Order):

- Fixed order in α -> Exact interference, helicity, loops, ...
- At present can do 2->5/6 (less with loops)
- Perturbative expansion better at higher energy (asymptotic freedom)
- Multiple soft emissions important for full event structure = exclusive observables
- Widely separated scales -> big logs / big truncation errors.
- Phase space for soft emissions increases at high energy



Marriage desirable!!

Parton Showers:

- Derived in universal limit of QCD -> depend on universal parameters
- Exponentiate -> infinite $O(\alpha)$ -> ideal for widely separated scales (logs resummed)
- Arbitrary number of partons in final state -> match to hadronisation descriptions
- Derived in limit (collinear) of QCD -> approx. for wide-angle / hard emissions.

Possible Ceremonies

1. Merging (old) (HERWIG, PYTHIA, ARIADNE)

- C

2. Tree (ARIADNE, SHERPA, PATRIOT)

- In
- re

3. NLO

- M
 - 1
- hardwired to HERWIG + formalism so
cumbersome.

4. + new ideas ... (Kramer+Soper, Nagy, Collins et al)



Vircol – Basic SKETCH

- Perturbative expansion for some observable J ,

$$d\sigma = \sum_{m=0} d\sigma_m \quad ; \quad d\sigma_m = d\Pi_m |M|^2 \delta(J - J(k_1, k_2, \dots, k_m))$$
- Assume we know some Matrix Elements

$$d\sigma_0, d\sigma_1, \dots, d\sigma_n \quad (\text{w or w/o loops})$$
- And we have some approximation $T_{n \rightarrow n+1}$, so that

$$d\sigma_{n+1} \sim T_{n \rightarrow n+1} d\sigma_n \quad (\sim \text{parton shower})$$
- A 'best guess' cross section is then:

$$d\sigma \sim d\sigma_0 + d\sigma_1 + \dots + d\sigma_n (1 + T_{n \rightarrow n+1} + T_{n \rightarrow n+1} T_{n+1 \rightarrow n+2} + \dots)$$

→ $d\sigma \sim d\sigma_0 + d\sigma_1 + \dots + d\sigma_n S_n \quad ; \quad S_n = 1 + T_{n \rightarrow n+1} S_{n+1}$
- For this to make sense, the $T_{n \rightarrow n+1}$ have to at least contain the correct singularities (in order to correctly sum up all logarithmically enhanced terms), but they are otherwise arbitrary.
- We will now reorder this series in a useful way ...

Reordering example: $h \rightarrow gg$

- Assume we know ME for $H \rightarrow gg$ and $H \rightarrow ggg$. Then reorder:

$$\text{Use } 1 = S_n - T_{n \rightarrow n+1} S_{n+1}$$

- $$\begin{aligned} d\sigma &\sim d\sigma_{gg} + d\sigma_{ggg} S_{ggg} \\ &= S_{gg} d\sigma_{gg} + S_{ggg} (d\sigma_{ggg} - T_{gg \rightarrow ggg} d\sigma_{gg}) \\ &= S_{gg} d\sigma_{gg} + S_{ggg} d\chi_{ggg} \quad (\text{generalises to } n \text{ gluons}) \end{aligned}$$

- I.e shower off gg and modified ggg matrix element.
- Double counting avoided** since singularities/shower subtracted in $d\chi_{ggg}$.

What IS THE Difference?

CKKW (& friends) in a nutshell:

1. Generate a n-jet Final State from n-jet (singular) ME.
2. Construct a "fake" PS history.
3. Apply Sudakov weights on each "line" in history \rightarrow from inclusive n-jet ME to exclusive n-jet (i.e. probability that n-jet FS remains n-jet above cutoff) \rightarrow gets rid of double counting when mixed with other ME's (Sudakov wt dampens singularity).
4. Apply PS with no emissions above cutoff.

VirCol in a nutshell:

1. Subtract PS singularities from n-jet ME (antenna subtraction)
2. Generate a n-jet Final State from the subtracted (finite) ME.
3. Apply PS \rightarrow Leading Logs resummed.

+ full NLO: divergent part already there = unitarity of shower assumption \rightarrow just include extra finite contribution in $d\sigma_0$:

$$d\sigma = d\sigma_0^{(0)} + d\sigma_1^{(0)} + \text{sing}[d\sigma_0^{(1)}] + F^{(1)} + \dots$$

+ now NNLO/NLL possible \rightarrow talks by Gehrmann, Gehrmann-De Ridder

The ANTENNA Shower

- So far, we have written a C++ code that (for the moment) generates a pure gluon cascade ordered in:

$$y_R = 4s_{a1}s_{1b}/s_{a1b}^2 = 4p_{T;ARIADNE}^2/s_{a1b}$$

- ...with the antenna / subtraction function:

$$|A(a,b \rightarrow a,1,b)|^2 =$$

$$2(s_{a1b}(s_{a1}+s_{1b})+s_{ab}^2)^2/(s_{a1}s_{1b}(s_{a1b}s_{ab}+s_{a1}s_{1b})s_{a1b})$$

→ “usual” collinear limit, but different outside.

- This gives an analytical Sudakov integral

= [Mathematica output] .

- (No Matrix Elements yet ... but work in progress).

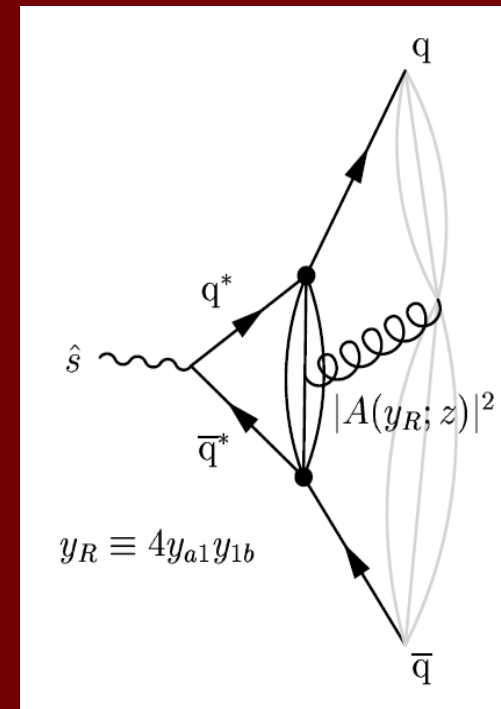

The ANTENNA Shower

- So far, we generate

$$y_R = 4s_{a1}s_{a2}$$

- ...with the

$$|A(a,b \rightarrow a)$$

$$2(s_{a1b}(s_{a1} +$$

→ “usual

- This gives

$$= [M$$

- (No Matr

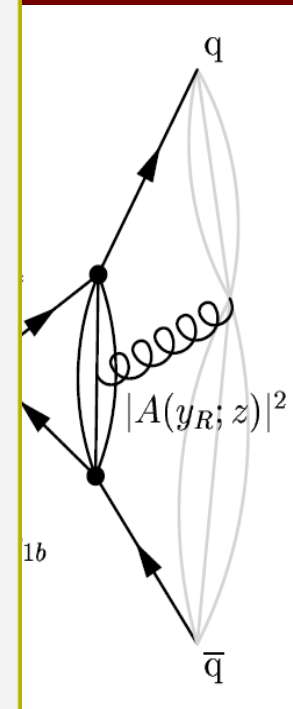
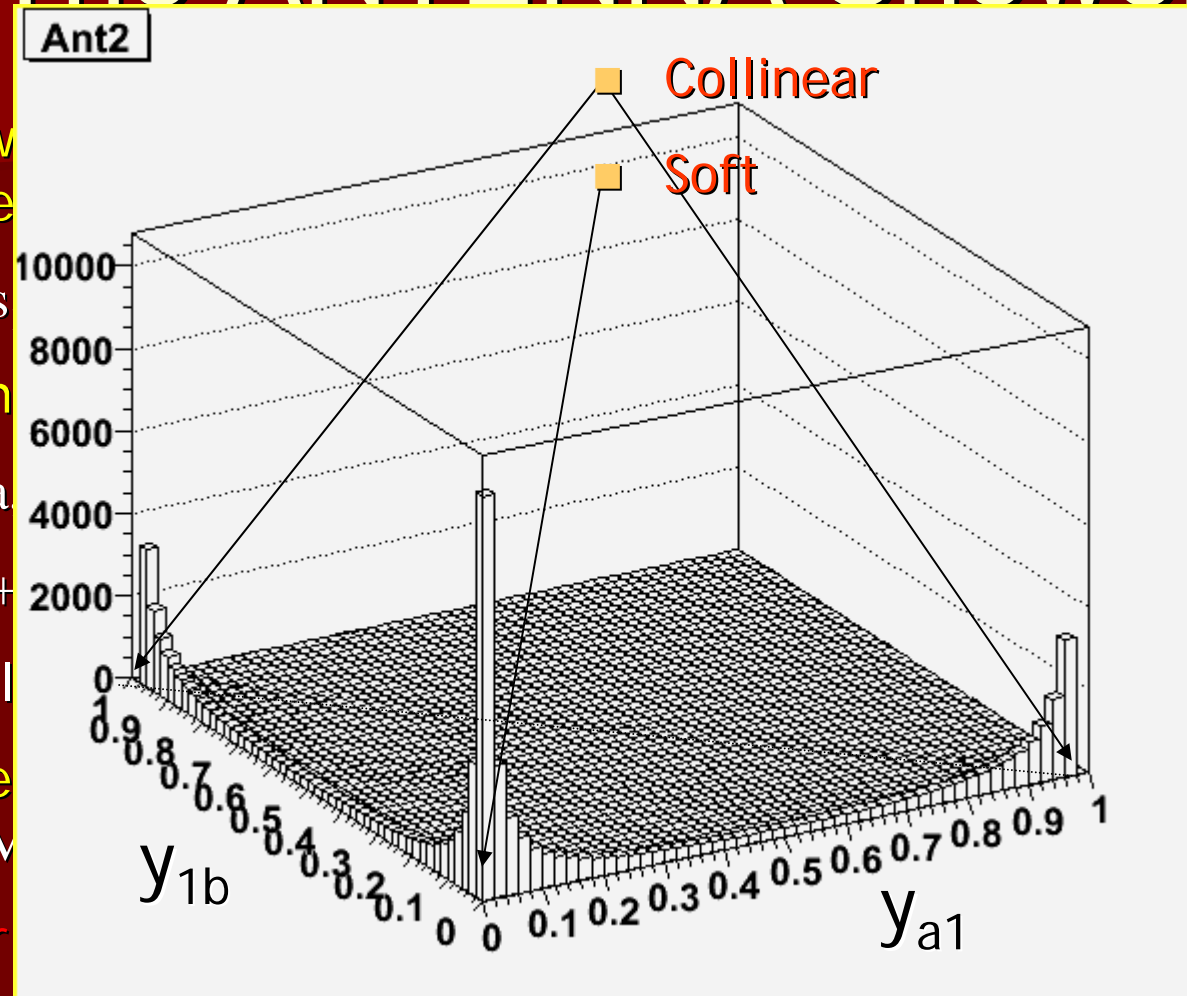

Resolution & sharing

- Sudakov $\rightarrow y_R$ for next branch \rightarrow select phase space point along **iso- y_R** contour:

1. Rewrite Antenna function in terms of $y^2=y_R$;

$$\xi = (s_{a1} + s_{1b})/y : \int_0^{R_1} dy \frac{1}{y} \int_1^{R_1=y} d\mu \frac{(\mu y + (1 - \mu y)^2)^2}{1 + y^2 = 4\mu y} \mathcal{P} \frac{1}{\mu^2 - 1}$$

2. Partial-fraction singular structure + overestimate numerators \rightarrow generate uniform R and solve for ξ_R :

$$R = \int_1^{R \gg R} d\mu \frac{A(y; \mu)}{1 - \mu y + y^2 = 4} + \mathcal{P} \frac{B(y; \mu)}{\mu^2 - 1}$$

Resolution & sharing

1st Branching: y1b vs ya1

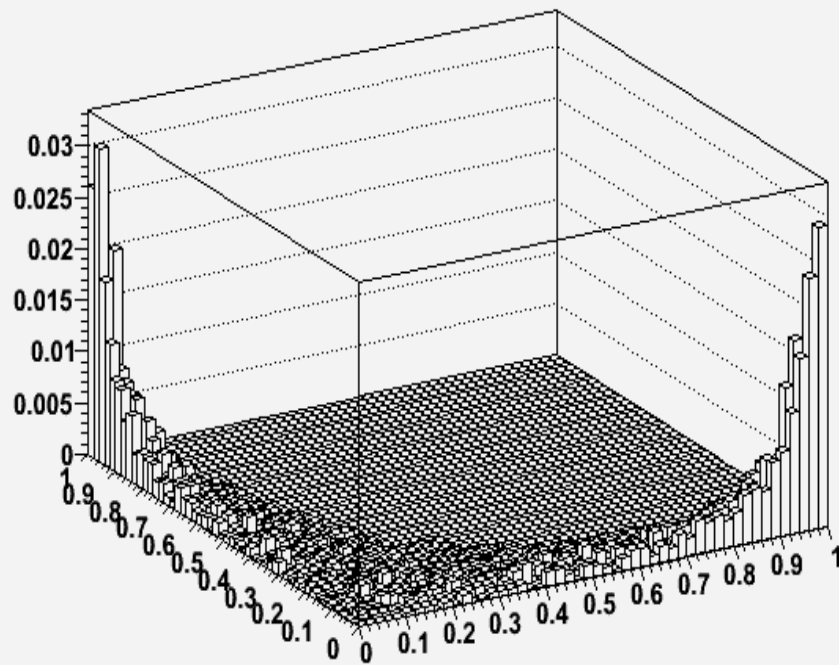

1st Branching: y1b vs ya1

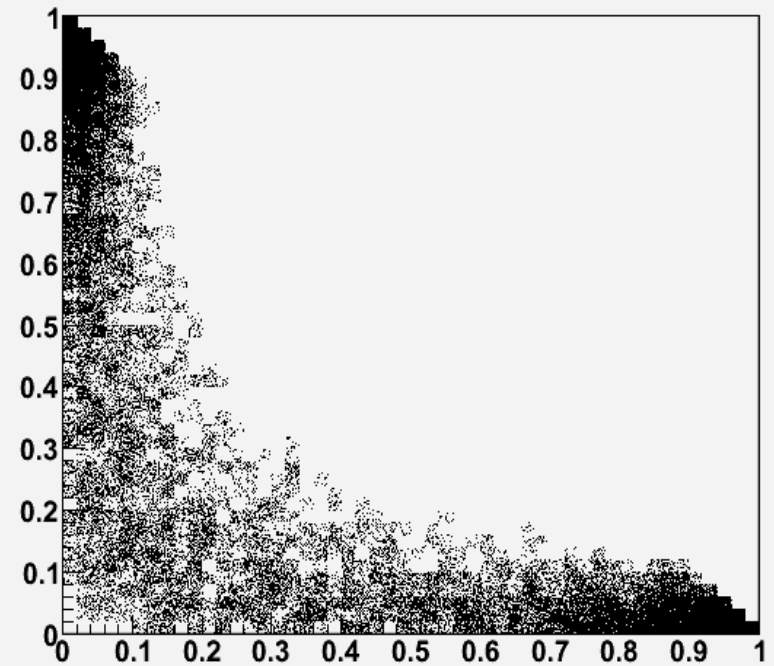

Resolution & sharing

- Q1: Where's the soft singularity?

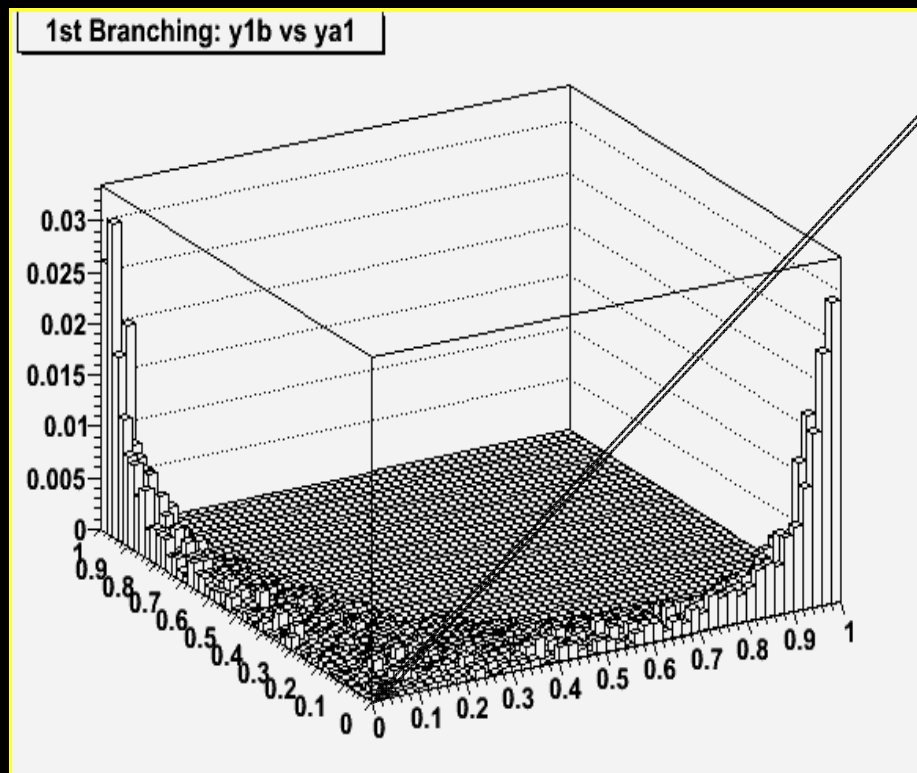

Resolution & sharing

- Q1: Where's the soft singularity?

1st Branching: y_{1b} vs y_{a1}

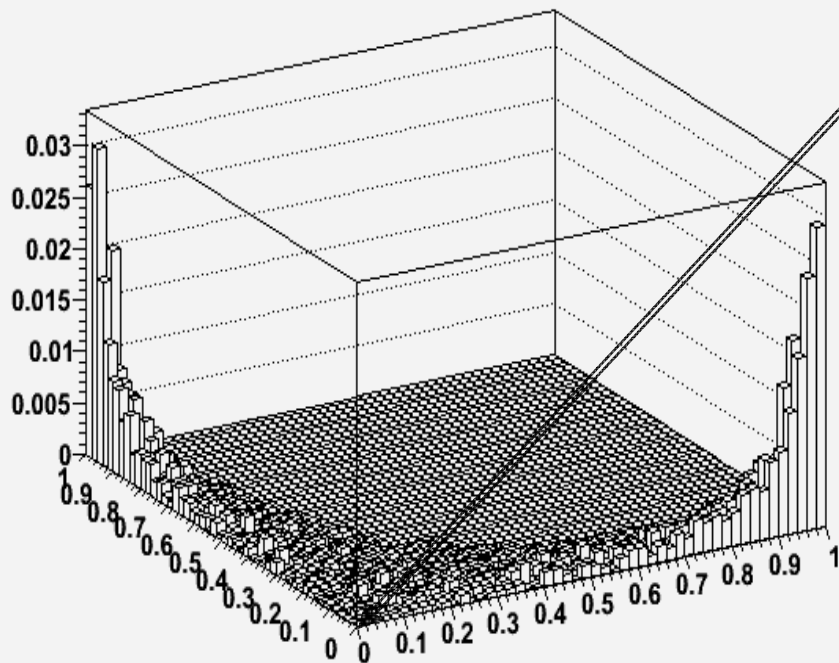

- A1: Sudakov suppressed, (sum of ordered branching probs \rightarrow unordered probability)

y_{1b} vs y_{a1}

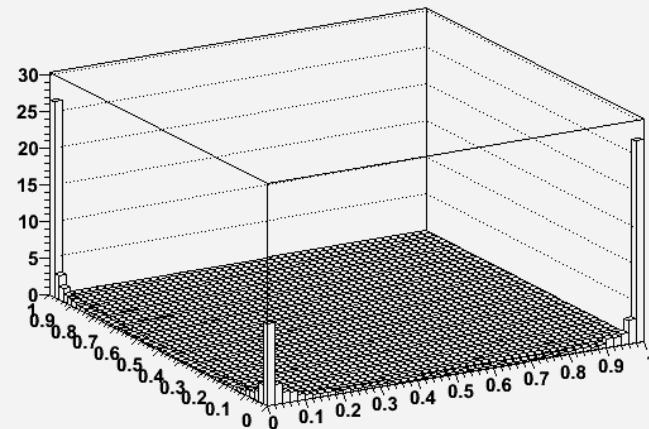

Resolution & sharing

- Q1: Where's the soft singularity?
- Q2: Is that a 'dead region' ?

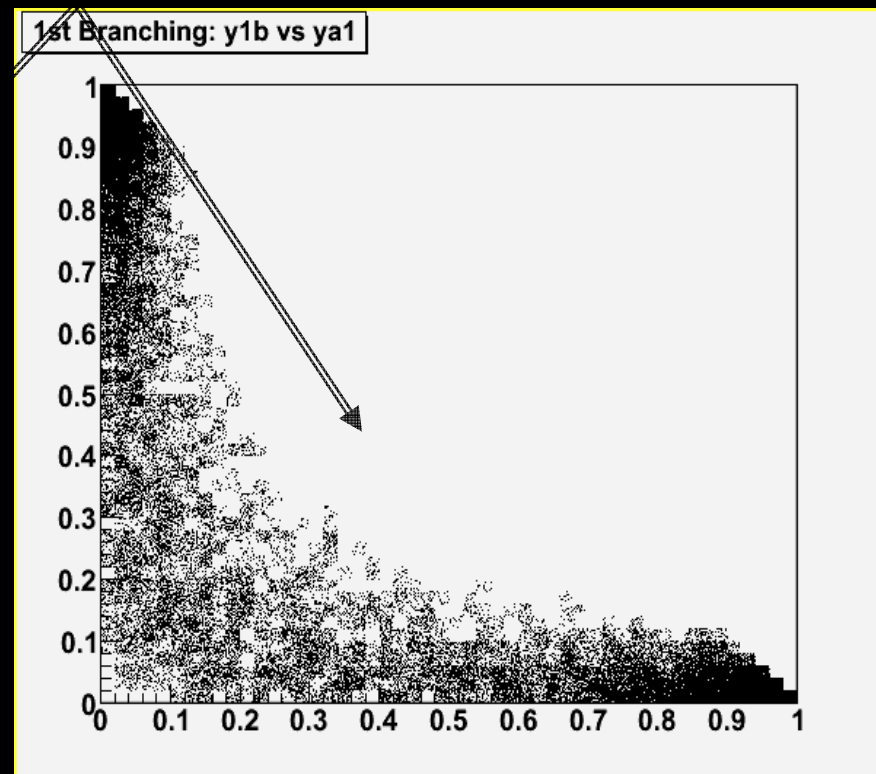

Resolution & sharing

- Q1: Where's the soft singularity?
- Q2: Is that a 'dead region' ?

- A2: Yes, it is cut out by 'unresolution criterion', i.e. that neighbour dipoles remain resolved after branching.
- Due to $H \rightarrow gg$ in colour singlet state! (pathological)
- Eventually, could be filled by Matrix Elements and/or by changing evolution var.

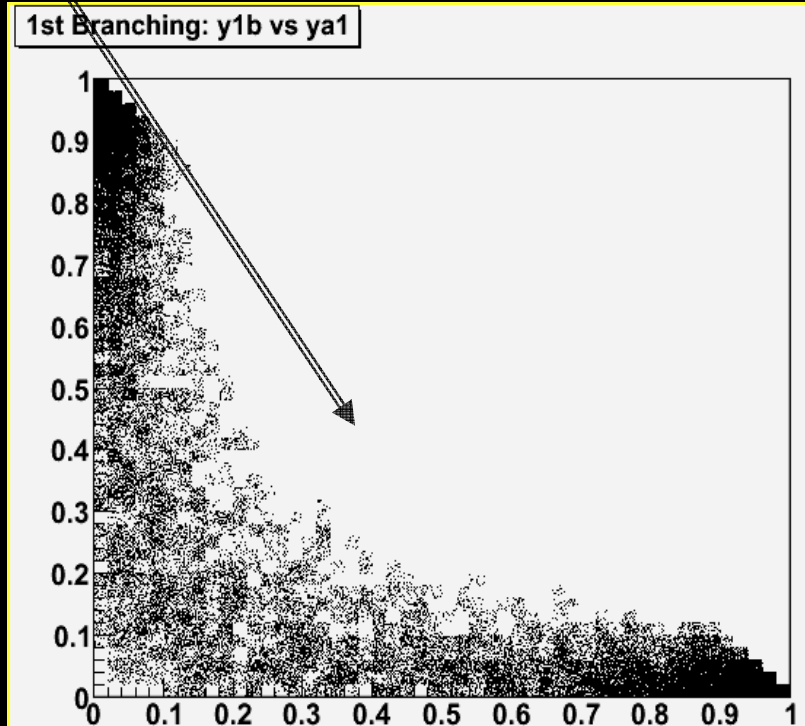

Preliminary Results

- Thrust and 3-jet rate, compared to Q^2 -ordered and p_T^2 -ordered PYTHIA showers.

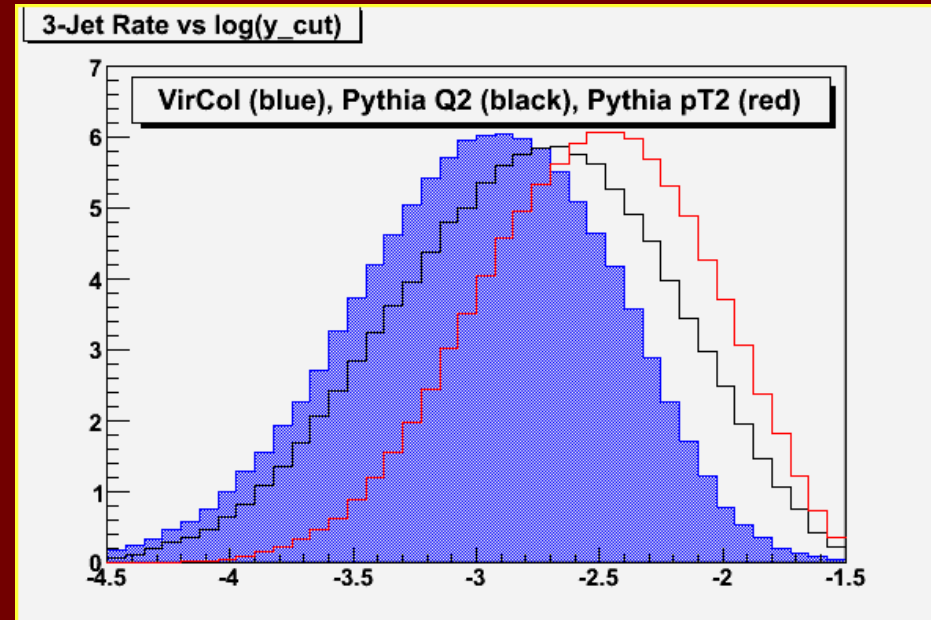
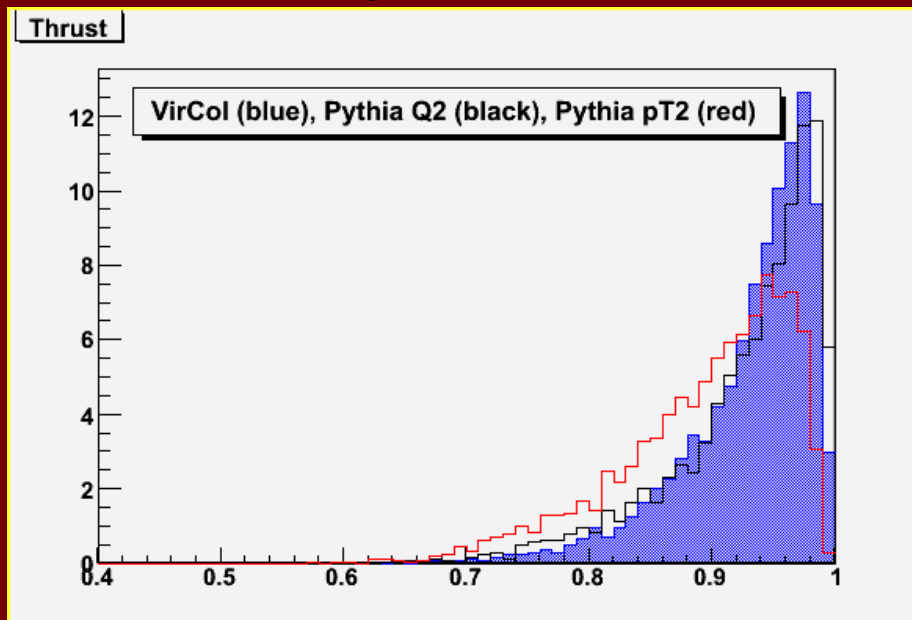

- Preliminary: matrix elements should be added and parton-level matched to hadronisation models eventually + all showers only include gluons here...

Conclusion & Outlook

- Construction of VIRCOL shower monte carlo:
 - gluons shower MC (based on LO, **done!**)
 - gluons shower MC (based on NLO)
 - parton shower MC (LO/NLO(/NNLO))
 - parton shower MC (NLL + NLO/NNLO)
 - Hadron collider shower MC's
 - Higher order Sudakov factor calculations (this will reduce a lot of implicit and explicit uncertainties: e.g. renormalization scale, choice of subtraction function,...)