

WORKING GROUP 4 – S'COOL LAB



THE PARTICLE DETECTOR

GIORGIO VACCHIANO
LEAH PEDDER
MARINA SILVA



THE ION TRAP

MAREK BALAZOVIC
MARKUS FRANSSON
HAMDAN DRAGHMEH

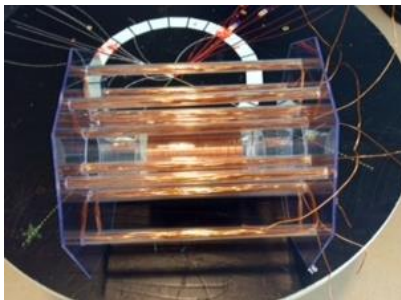

THE ATLAS MAGNET

LIZELLE SWANEPOEL
MIRIAM ROSENFELD
JULIA ALDEHOFF

SUPPORT: ALEXANDRA FEISTMANTL - VINCENT DARRAS - JULIA WOITHE

PARTICLE DETECTOR



HST 2015

GIORGIO VACCHIANO (IT)

LEAH PEDDER (USA)

MARINA SILVA (PT)



SUBJECT



**Particle camera MX-10 JABLOTRON
BASED ON PIXEL DETECTOR IN LHC**

<http://www.jablotron.com/en/about-jablotron-1/about-us/international-cooperation/jablotron-mx-10-1.aspx>

- Characteristics
- Edu-kit



[Alarms](#)[Automation](#)[Car accessories](#)[Regulation](#)[Personal security](#)My **JABLOTRON**[» About Jablotron](#) [» About us](#) [» International cooperation](#) [» JABLOTRON MX-10](#)

JABLOTRON MX-10

The MX-10 Digital particle camera is a state-of-the-art educational tool for demonstrating radiation and analyzing radioactive sources.

It can record and recognize different kinds of ionizing particles (α, β, γ) and provides you with a lot of information to study. The accompanying Pixelman software, with easy installation on your PC, instantly displays and allows you to export all the acquired data.

Main features of MX-10

- instant display – unlike traditional quantum detectors (GM tubes, scintillators) , this device is virtually a digital radiation video camera
- clear recognition of particles - α , β , γ , MIP particles (e.g. muons from cosmic rays)
- easy-to-use in classroom experiments



The basic MX-10 set

The basic MX-10 set contains:

- MX-10 camera
- Pixelman software and Experiment Guide on a memory stick
- USB connecting cable

All packed in a hard case.

SOFTWARE

Pixelman Simple Preview (MX-10 D05-W0257)

File View Tools Options Help

1

Y

256

0 146.291 292.582 438.873 585.164

X (column number)

0 1

START ← 1 →

E 135781 N 301 P 3015

Acquisition

Finite count of steps

Integral mode

Exp. count: 2,000

Exp. time: 0.1

Delay [s]: 0

Acq. progress: 315/2000

59.57 s

Mode: Spectrometer

Picture settings

Min. level: 0

Max. level: 585

Set colormap: Hot

Auto range: Min-max

XY: [12,130]

Value: 0.0

Min: 0.0

Max: 585.1639

Pixel count: 3015

Energy - frame: 135781

Energy - select...: 135781

Frames count: 315

Radiation source: Other

Analysis

Frame	Actual	All
Alpha	0	24
Beta	1	206
Gamma	0	70
Other	0	1
All	1	301

CURRICULA

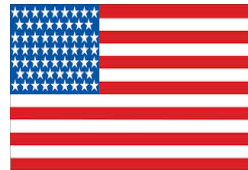

	USA	PORTUGAL	ITALY
AGE	15-18	13-14	18-19
COMPULSORY	No	Yes	No
CONTENTS	Electromagnetic spectrum Energy Nuclear physics Modern physics	Electromagnetic spectrum Technology and equipment using radiation	Electromagnetic spectrum Nuclear physics Radioactivity

STUDENTS' CONCEPTIONS

- Don't know the meaning of "radioactivity", misunderstanding with radio waves
- "Radiation" has a frightening connotation
- No natural sources emit radiation, only the industrial because radiation is artificial
- There is no background radiation, we live in a free radiation environment
- Radioactivity is unstoppable
- Natural radiation is different from the one from radioactive sources
- Radiation is carried by the wind
- Radiation is danger because it is invisible
- Irradiation of objects results in radioactive objects

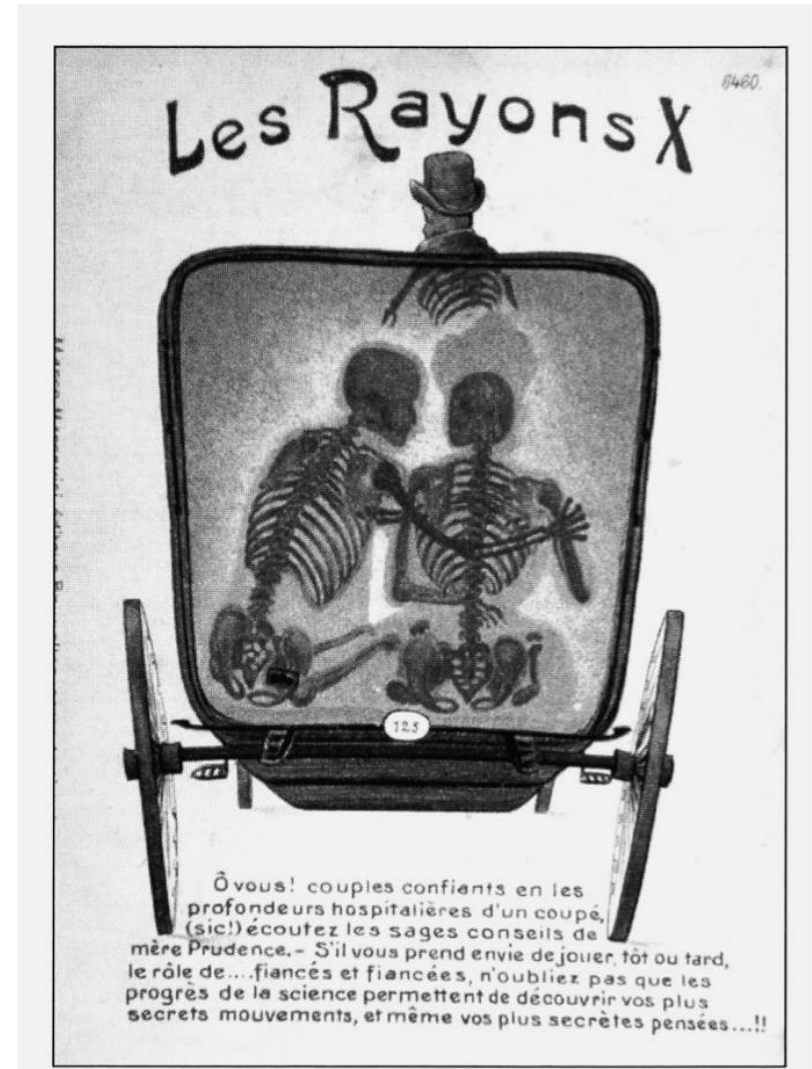

OUR PROPOSAL

Shielding test

- **Al shielding**
- **Pb shielding**
- **Paper shielding**
- **Distance**
- **Thickness of Al**

Tape X-rays



PROTOCOLS

MX-10 Particle Detector Shielding Test

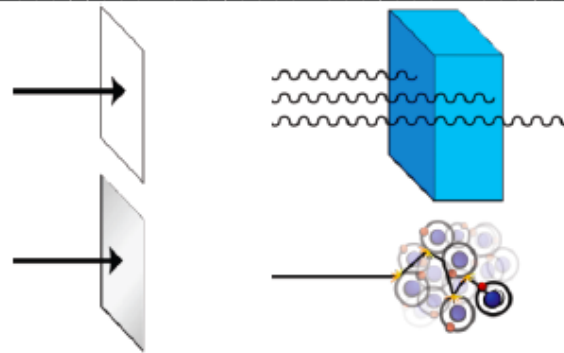

Theory

- Make predictions using what you already know
- Explain why you think what you do
- Think about what makes sense to you



Experiment

- Perform measurements
- Record observations
- Prove (or disprove) your predictions



If you notice that your predictions differ from what you see in your experiment, makes sure that you suggest why this might be the case.

Prior Knowledge:

1. How is radiation¹ shielded?
2. Why do we need radiation shielding?

SHIELDING TEST

Radioactive source

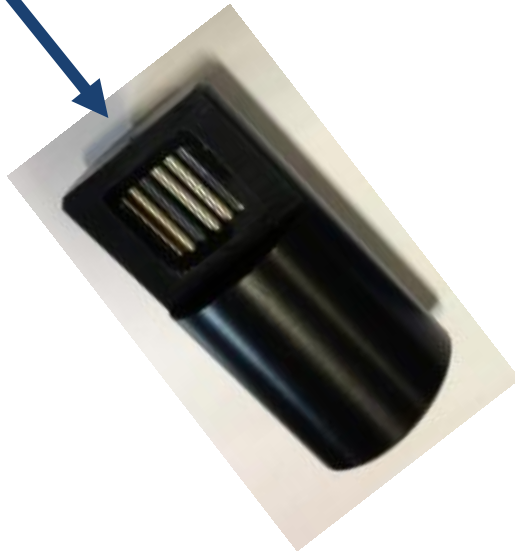

Aluminium foil

Paper

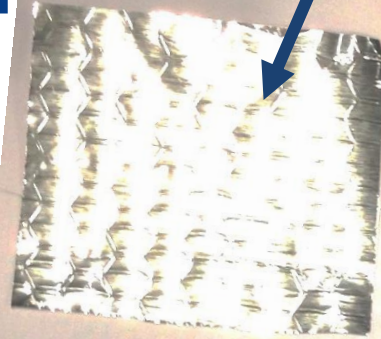

Aluminium shielding

CERN S'Cool LAB



Lead shielding

SHIELDING TEST

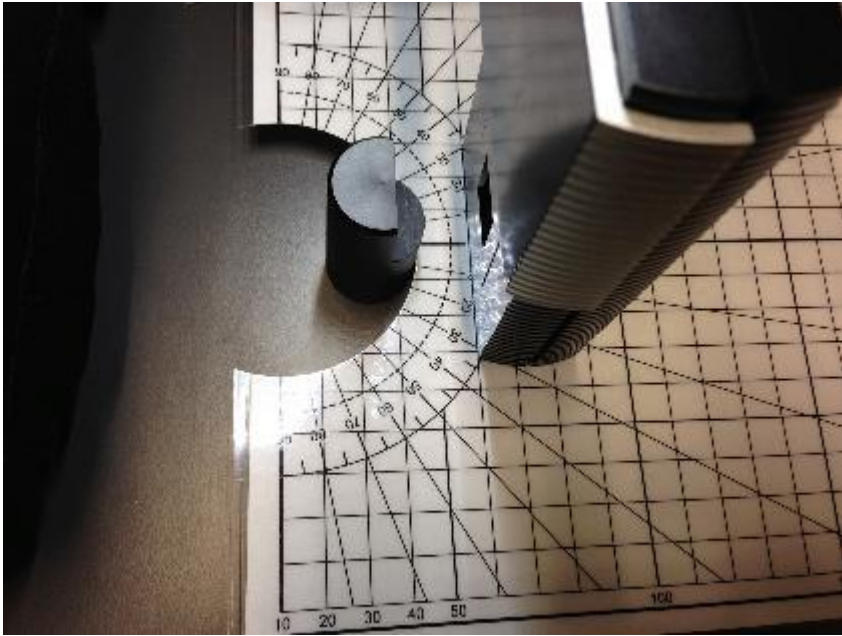

Without shielding



With shielding

SHIELDING TEST

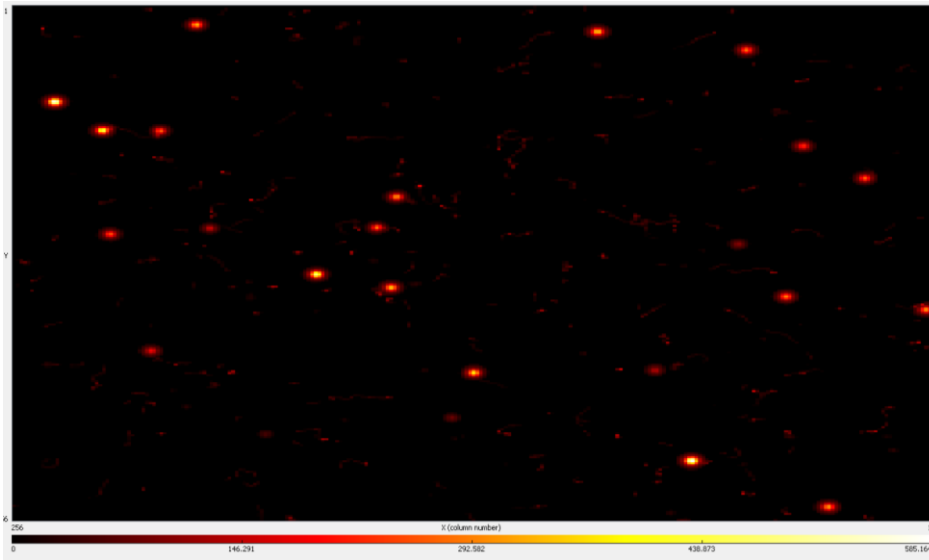

Without shielding

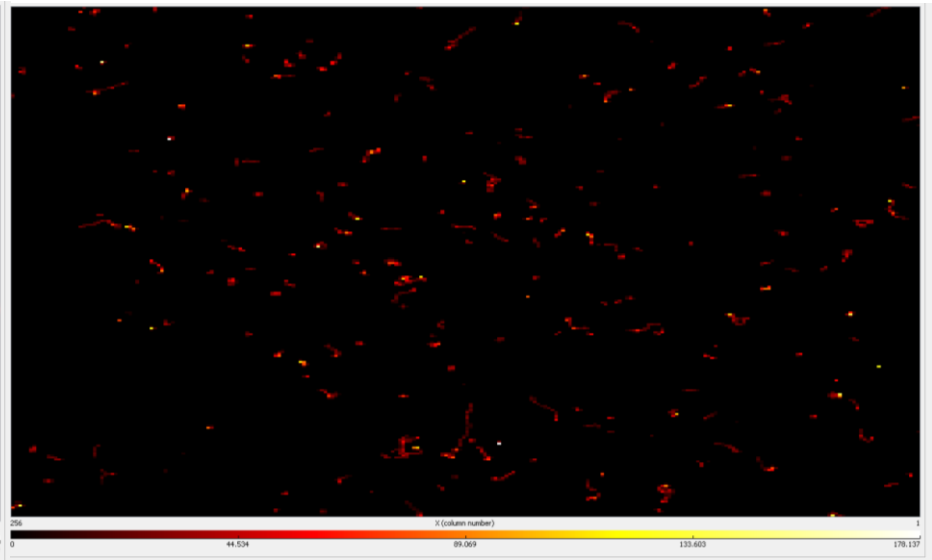

With paper shielding

SHIELDING TEST

Total energy as function of distance to the source of radiation

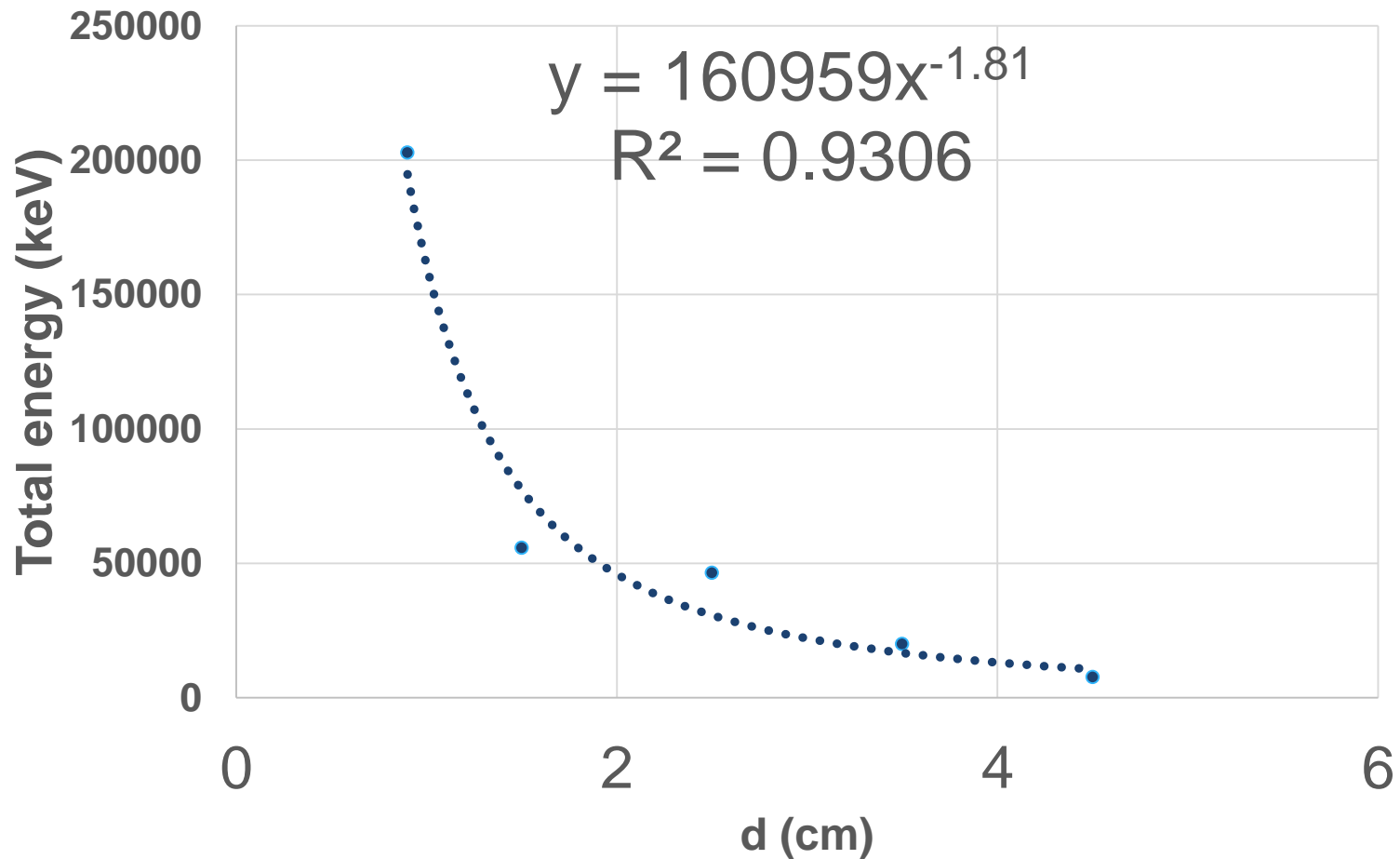

SHIELDING TEST

Total energy as function of thickness of aluminum foil

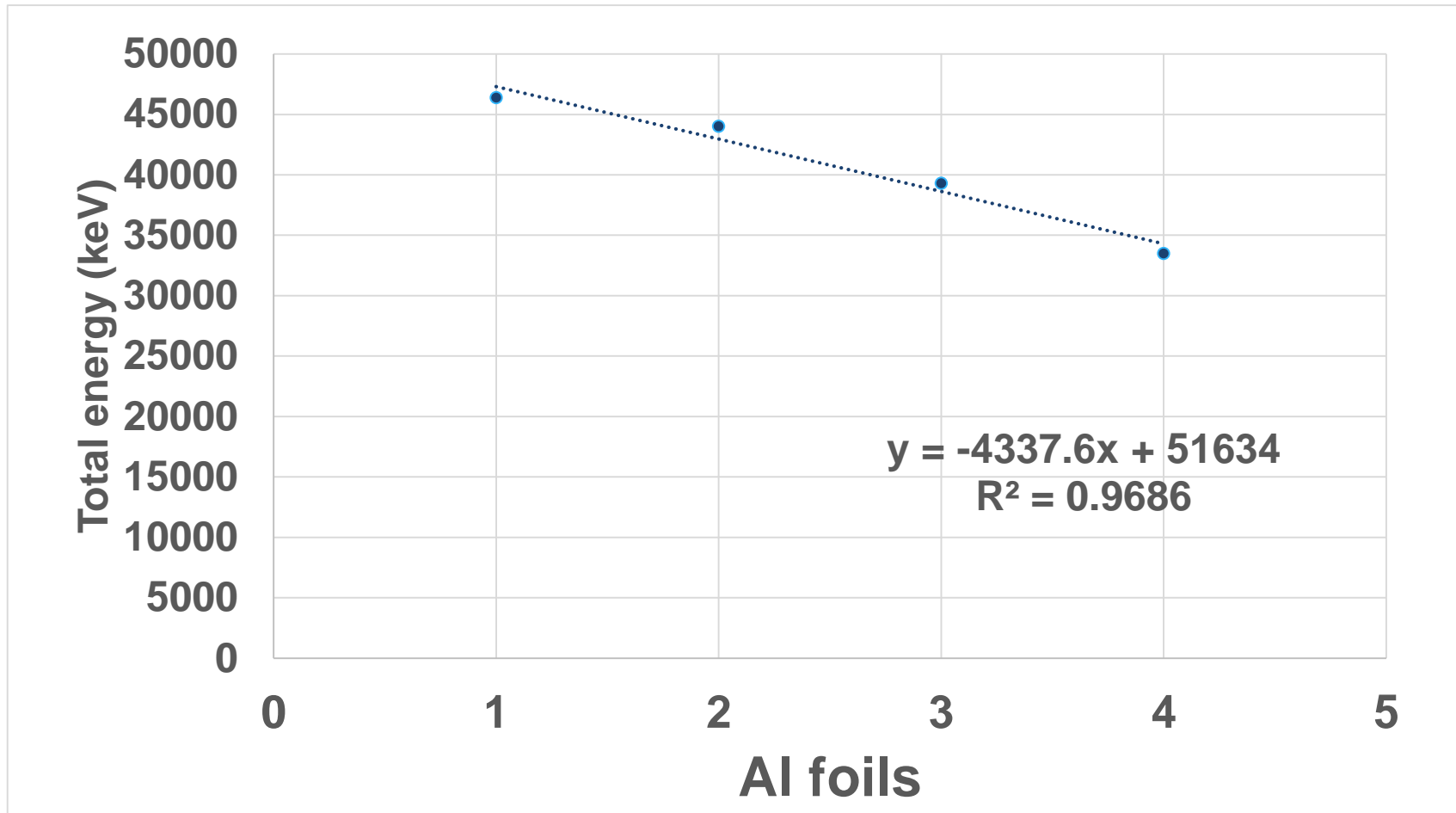

SHIELDING TEST

Total energy with different shielding

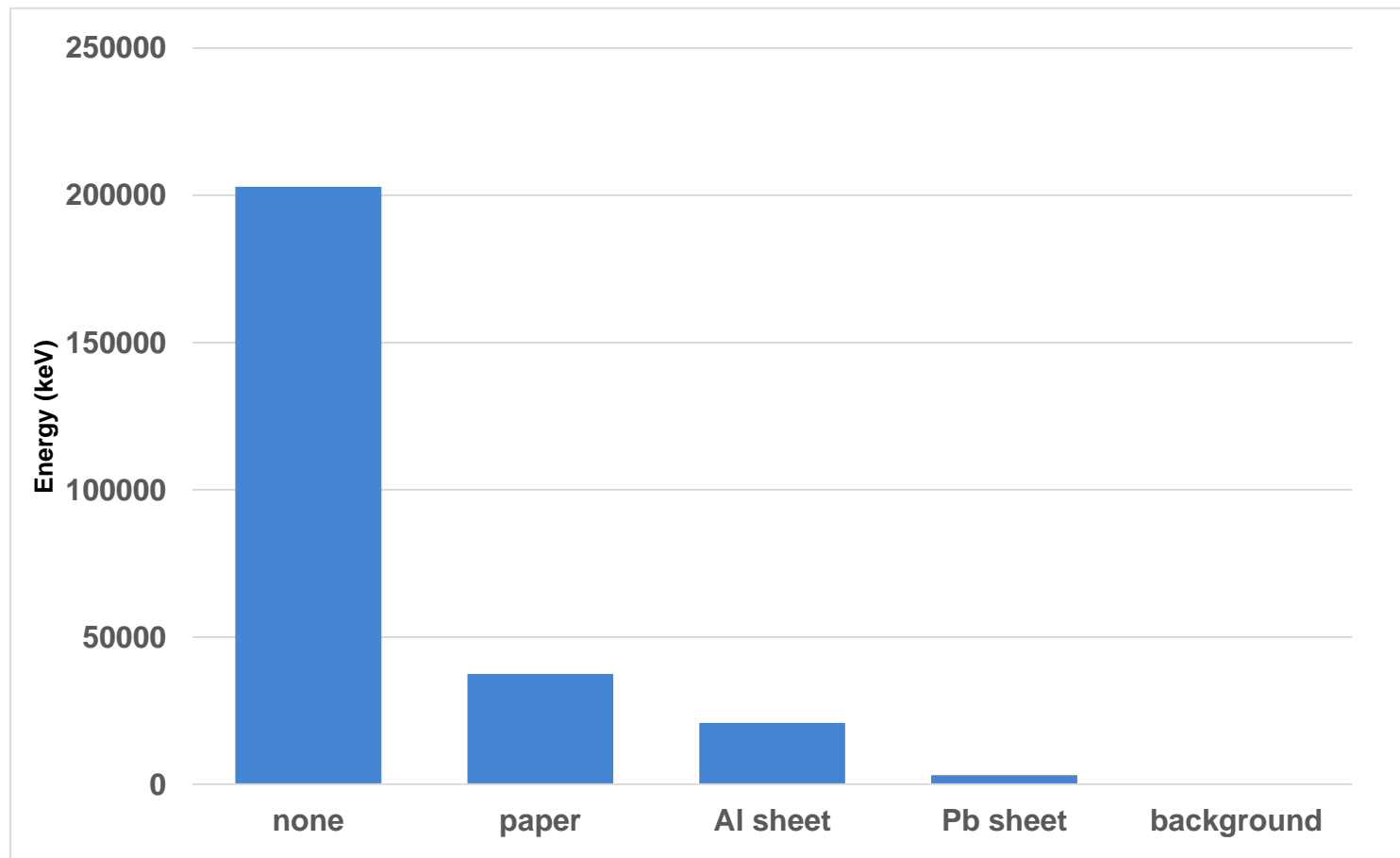

SHIELDING TEST

Number of particles detected with different shielding

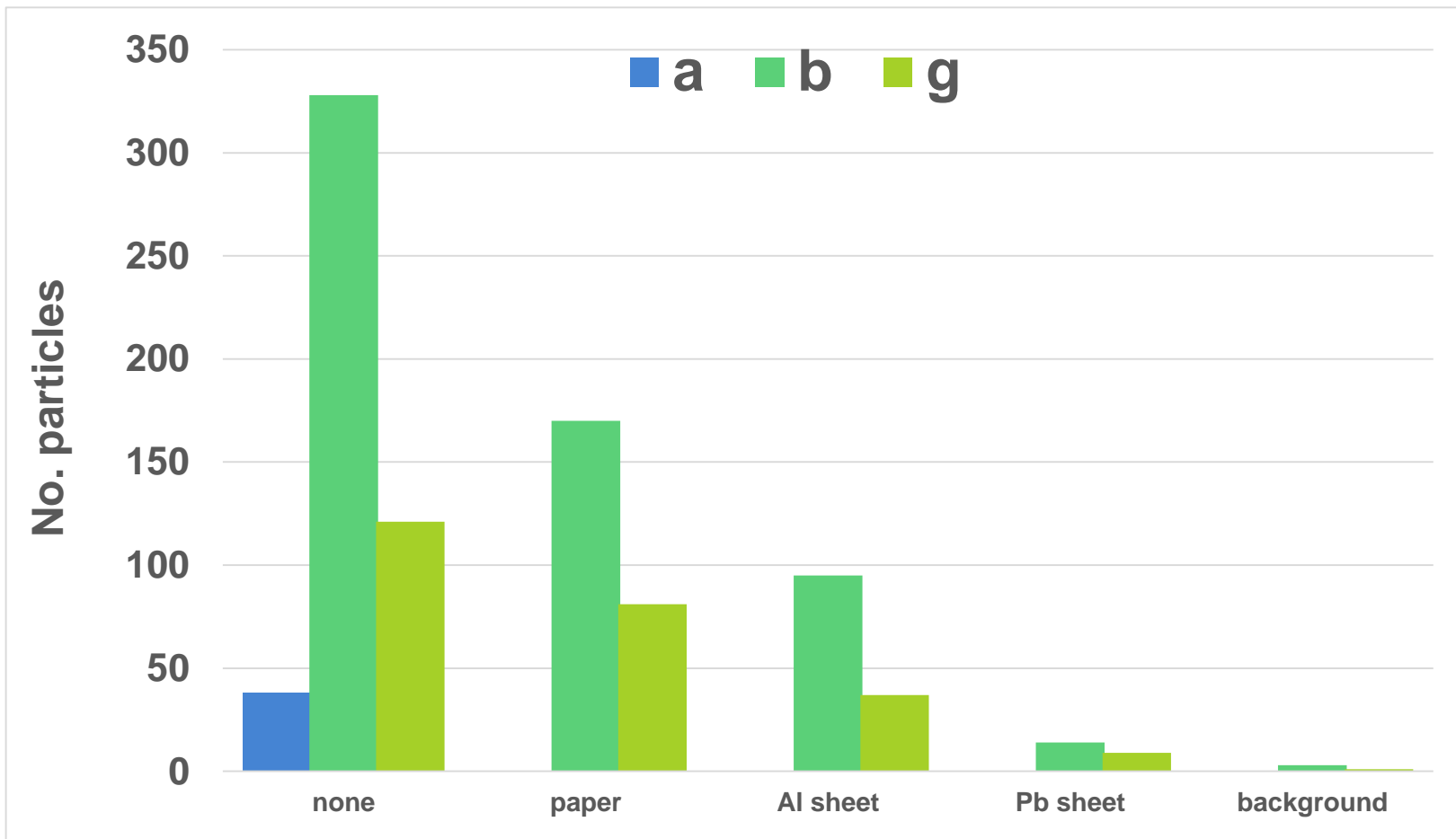

TAPE X-RAYS



TAPE X-RAYS

Pixelman Simple Preview (MX-10 D05-W0257)
File View Tools Options Help

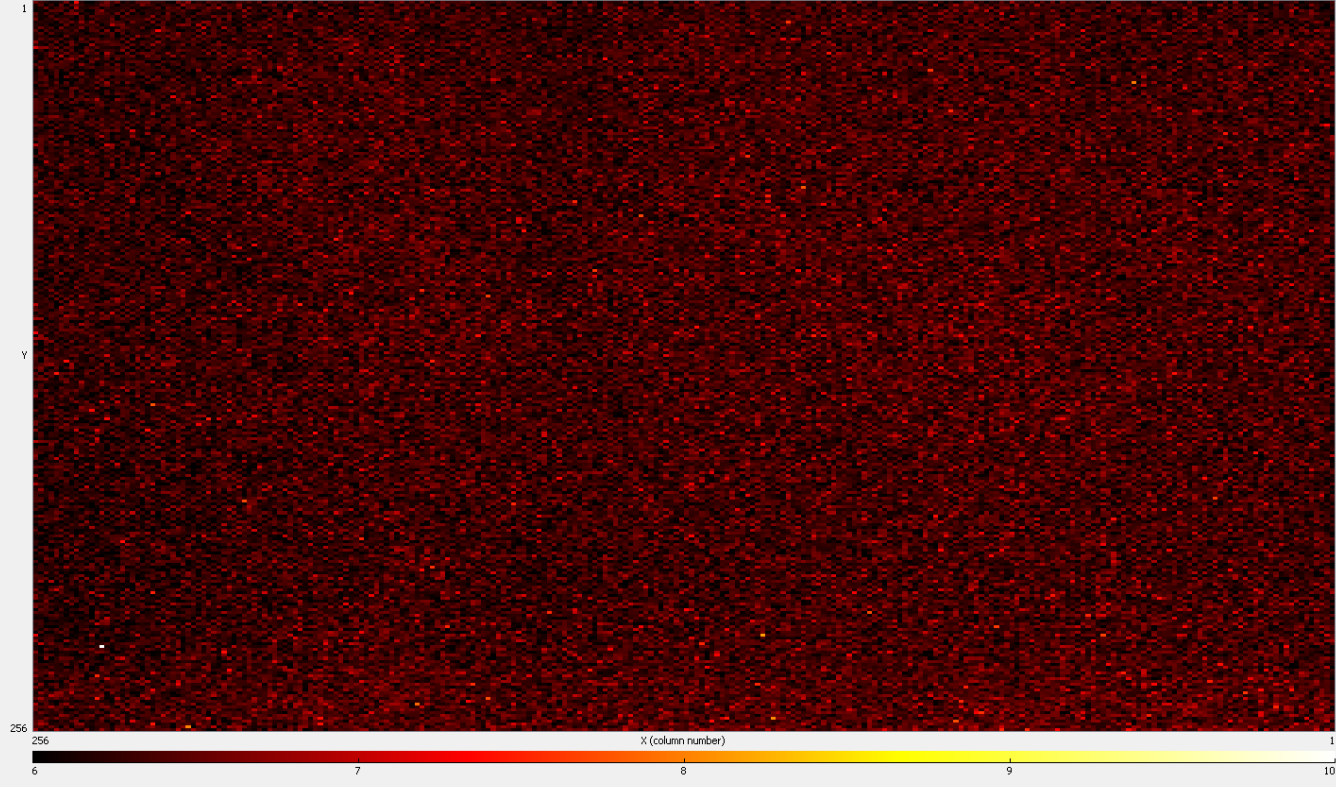

Acquisition

- Finite count of steps
- Integral mode
- Exp. count: 2,000
- Exp. time: 1
- Delay [s]: 0
- Acq. progress: 18/2000
- 19.734 s
- Mode: Spectrometer

Picture settings

- Min. level: 6
- Max. level: 10
- Set colormap: Hot
- Auto range: Min-max

Analysis

Frame	Actual	All
Alpha	0	1
Beta	0	0
Gamma	0	1
Other	0	0
All	0	2

XY	[239,218]
Value	6.444
Min	5.7143
Max	81.8011
Pixel count	65536
Energy - frame	415709
Energy - select...	415709
Frames count	18
Radiation source	Other

START [←] 1 [→]

E 415709 N 2 R 65536

TAPE X-RAYS

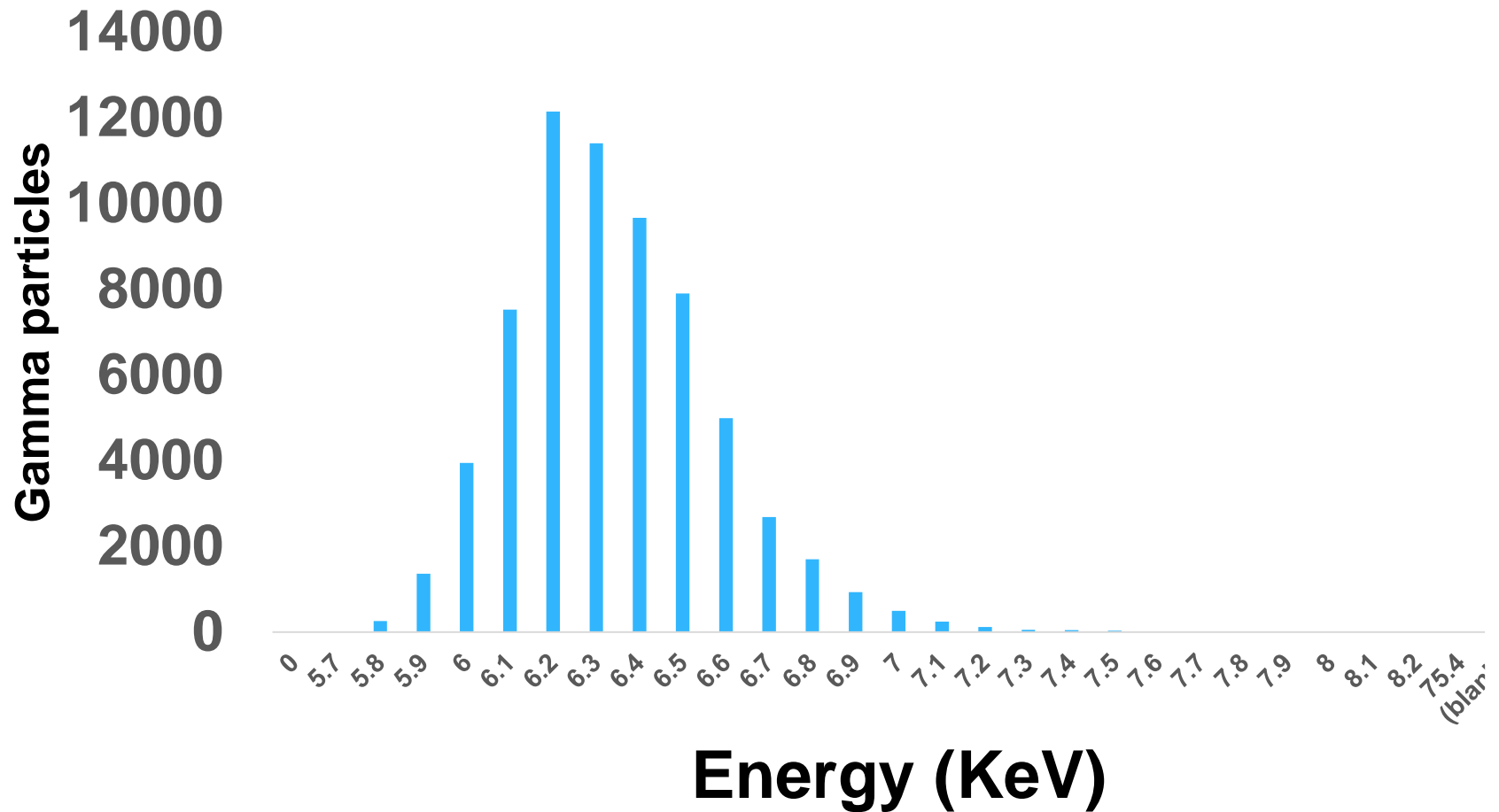

ALTERNATIVE

- Android app for cosmic rays detection
 - <http://wipac.wisc.edu/deco>
- App with built in particle detector
 - <https://youtu.be/9ibceYbzScw>

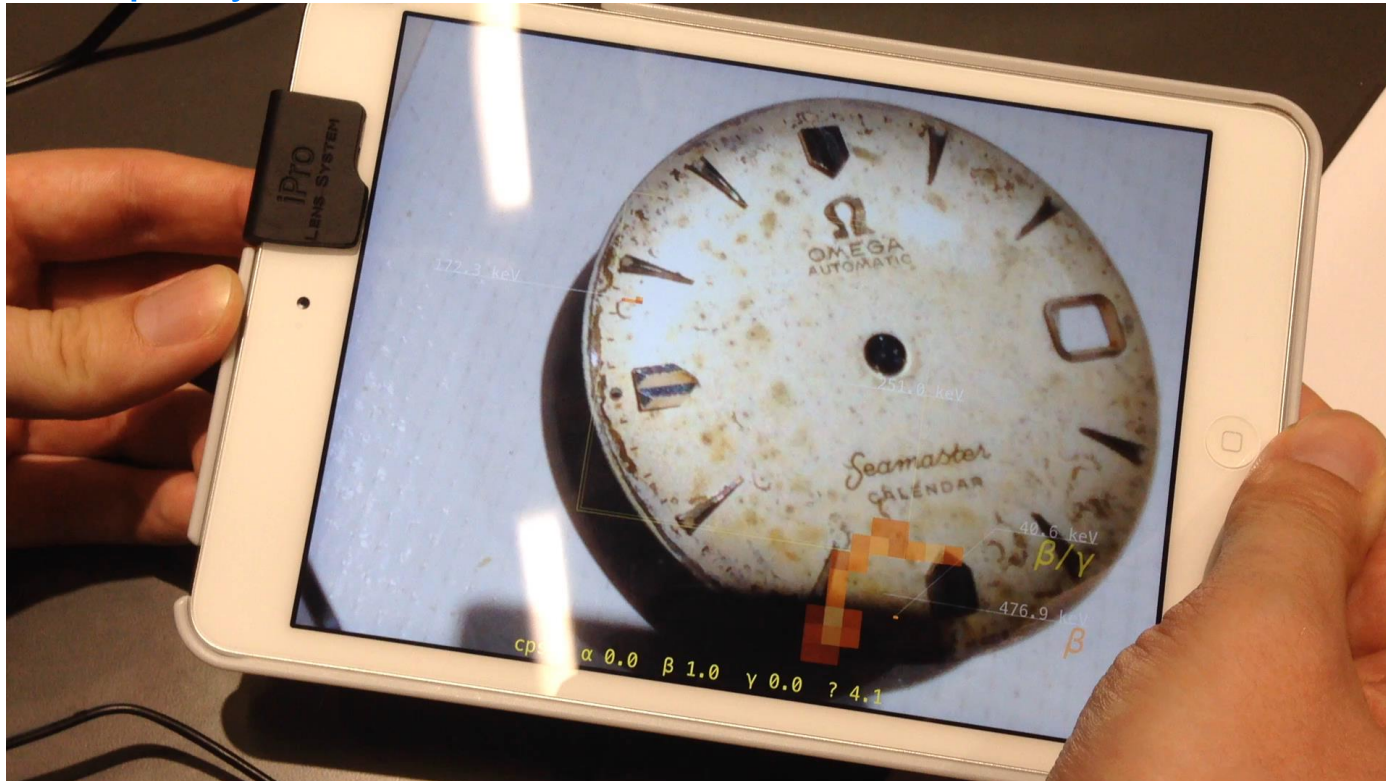

SOURCES

- **Sticky tape generates X-rays, Nature, 22-oct-2008**
 - <http://www.nature.com/news/2008/081022/full/news.2008.1185.html>
- **Becky Parker**
 - You're never too young to be a research scientist
 - TEDxCERN
 - <https://www.youtube.com/watch?v=MTv1N-BLTiM>
- **Eijkelhof, H. (1990), Radiation and risk in physics education**
 - <http://rpd.oxfordjournals.org/content/68/3-4/273.full.pdf+html>
- **Neumann, S. (2014). Three Misconceptions About Radiation – And What We Teachers Can Do To Confront Them. *The Physics Teacher*, 52, doi:10.1119/1.4893090**
 - <http://scitation.aip.org/docserver/fulltext/aapt/journal/tpt/52/6/1.4893090.pdf?expires=1437573291&id=id&accname=2098973&checksum=8E4CFEB927CAA55165B5947116D63681>
- **Rego, F. & Peralta, L. (2006). Portuguese students' knowledge of radiation physics. *Physics Education*, 41 (3).**
 - http://iopscience.iop.org/0031-9120/41/3/009/pdf/0031-9120_41_3_009.pdf

DISCUSSION TIME 1!

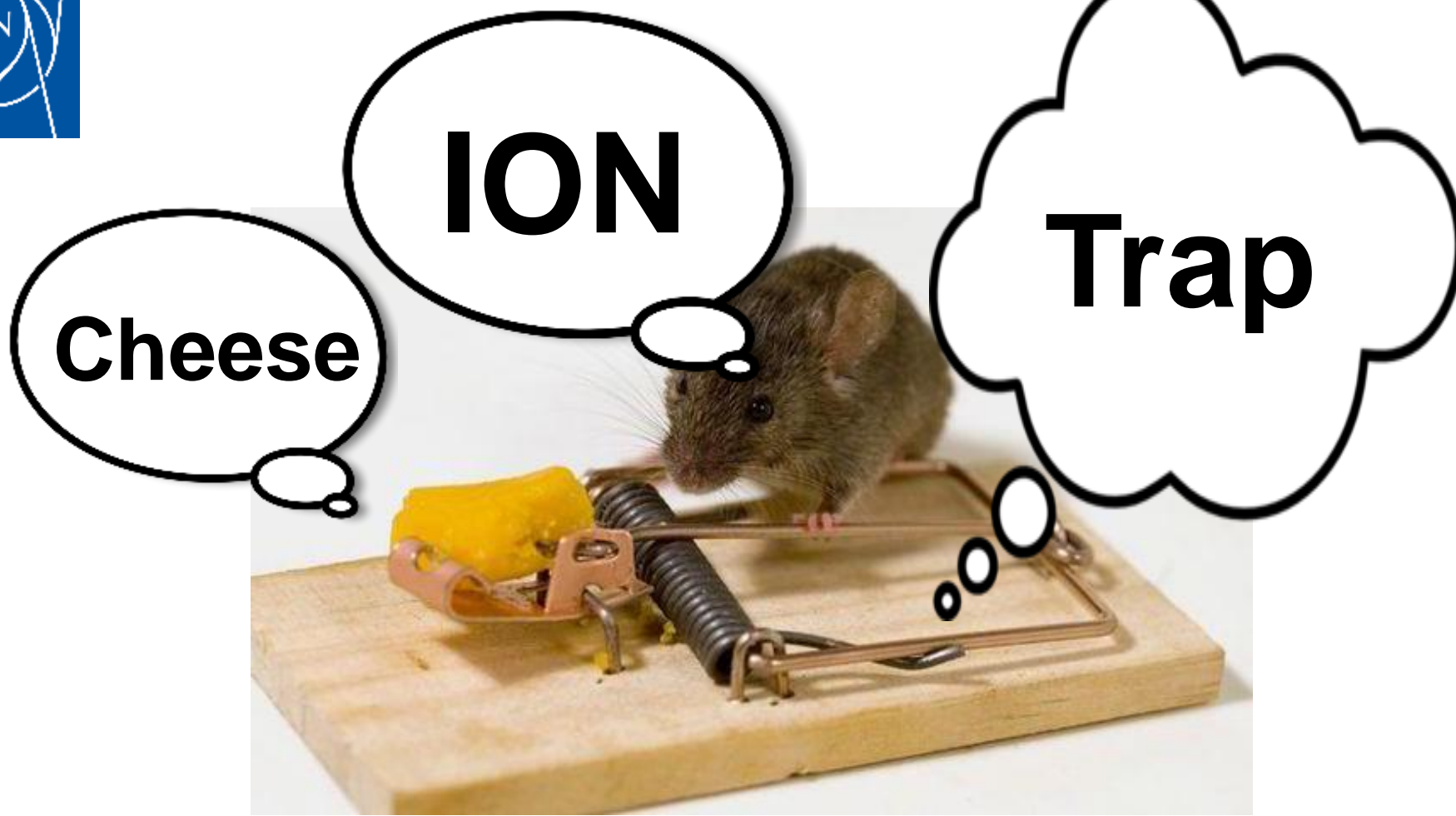

Cheese

ION

Trap

Hamdan.daraghmeh@yahoo.com

Marek Balazovic, Markus Fransson, Hamdan Draghmeh

balazovicm@gmail.com

markusfranssonph@gmail.com



What is an iontrap?

A quadrupole ion trap

Its also called "Paul" traps in honor of Wolfgang Paul.

Shared the Nobel Prize in Physics in 1989 for this work



Applications

Iontrap had been used in Mass spectrometry (MS)

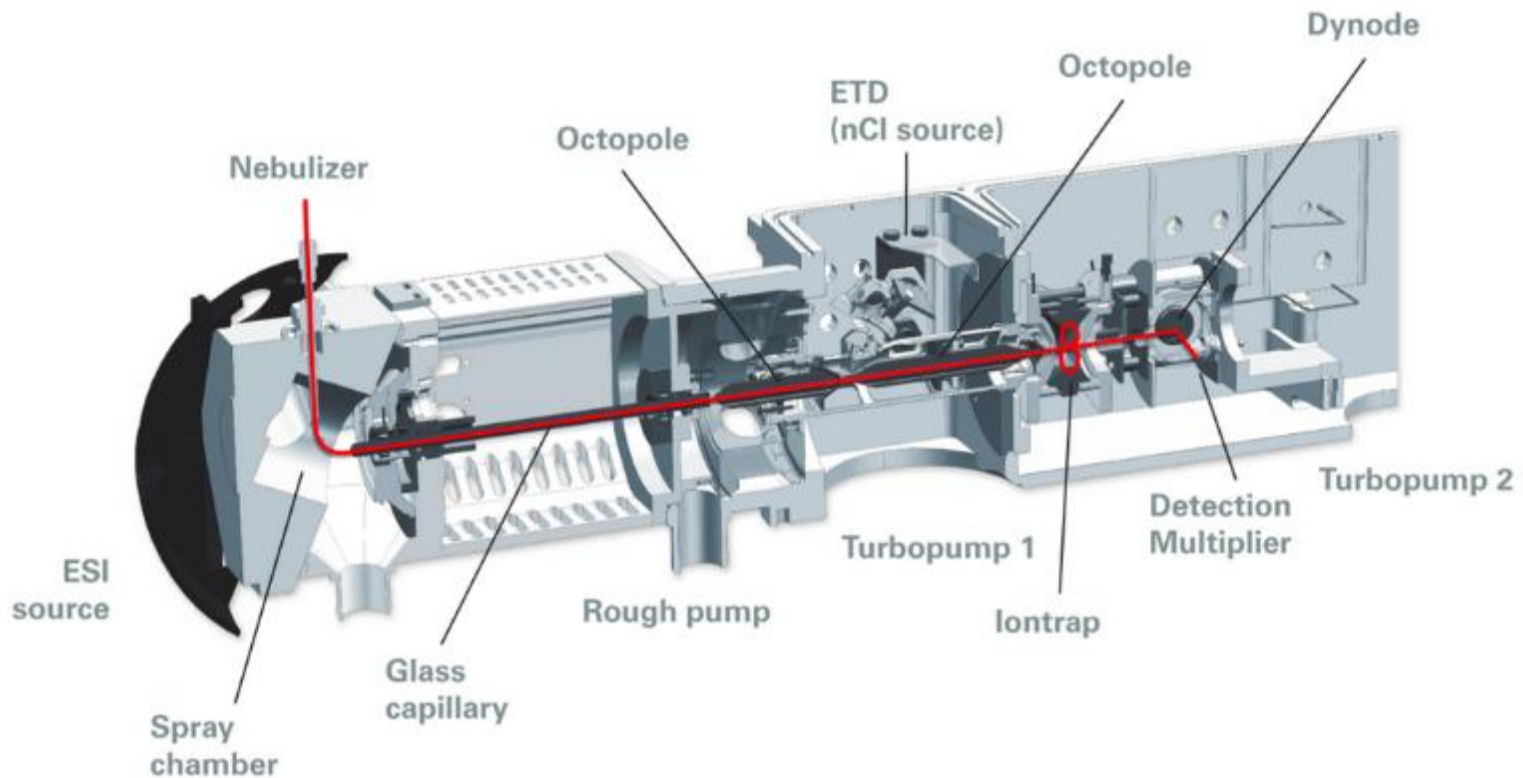



Trapping antimatter

In CERN experiments such as ATHENA and ALPHA. Iontrap was evolved to capture and trap the antimatter.





Demonstration example

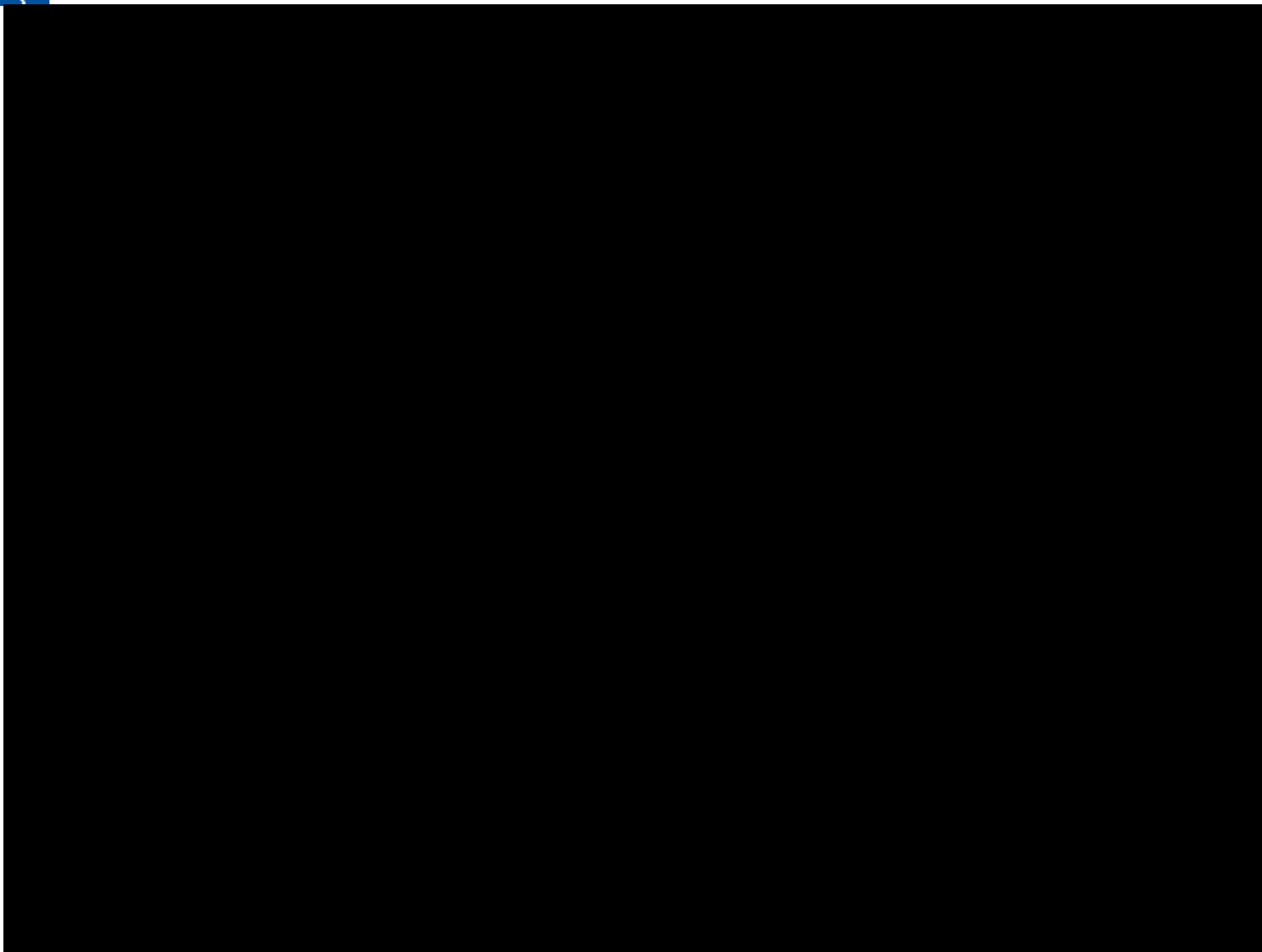



Why our project?

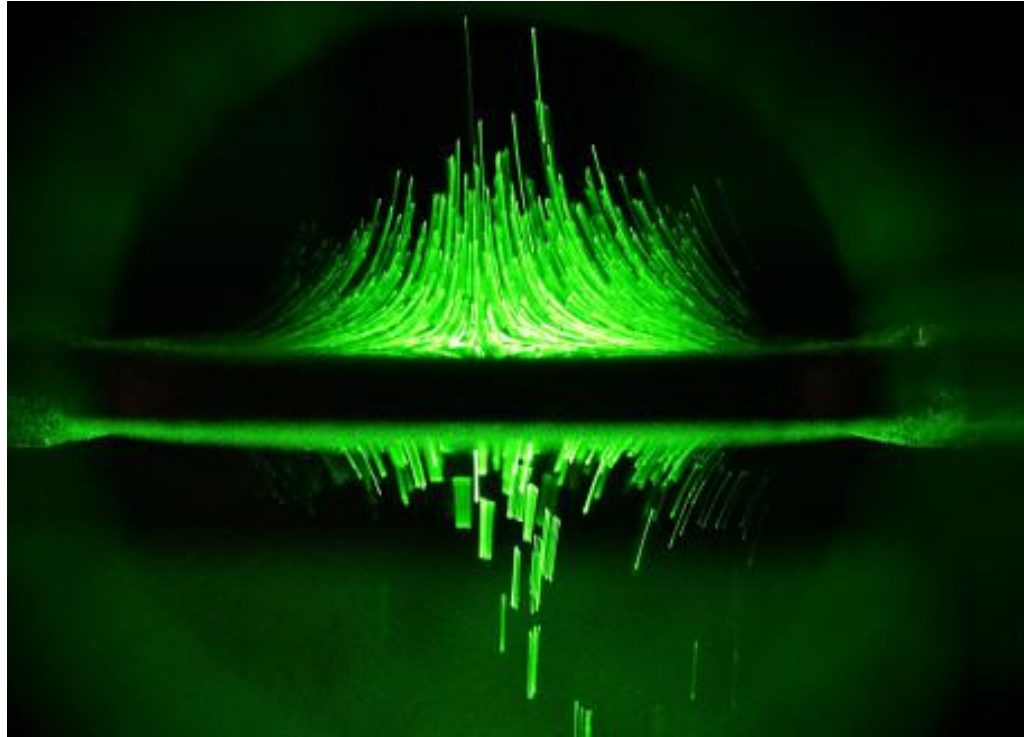

(www.newtonianlabs.com)

\$ 7490...



Why our project?

Make this cheap and visible and easy to build





Types of simple traps

- The RING trap
- The LINEAR trap

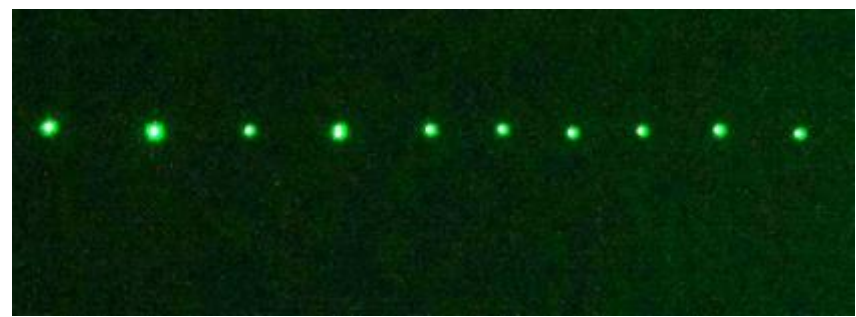
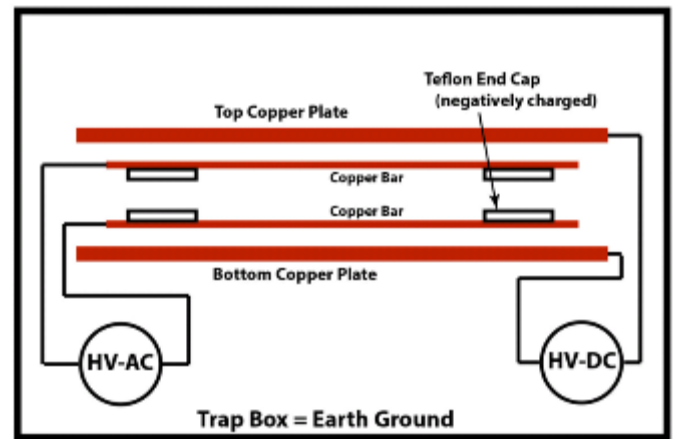
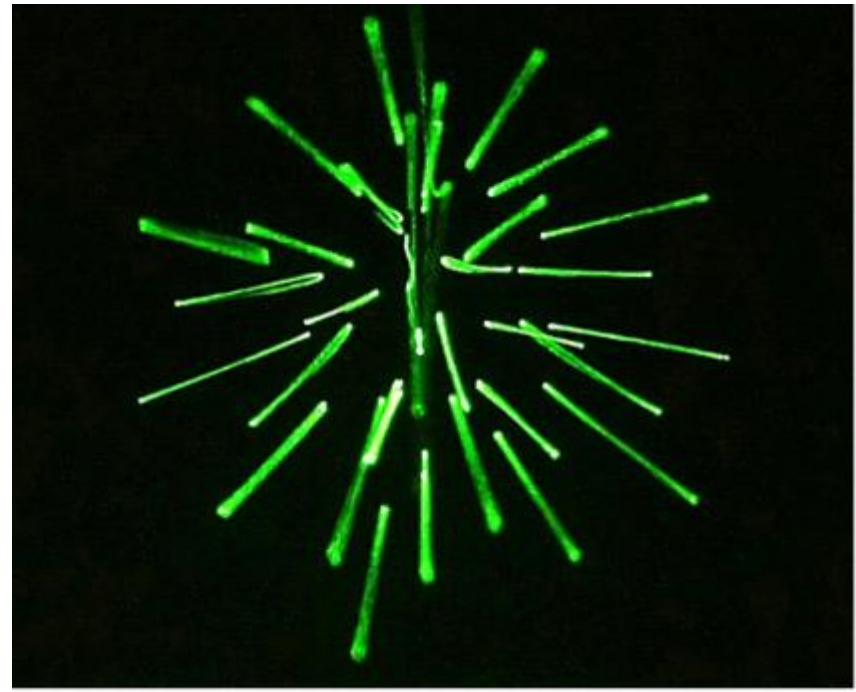
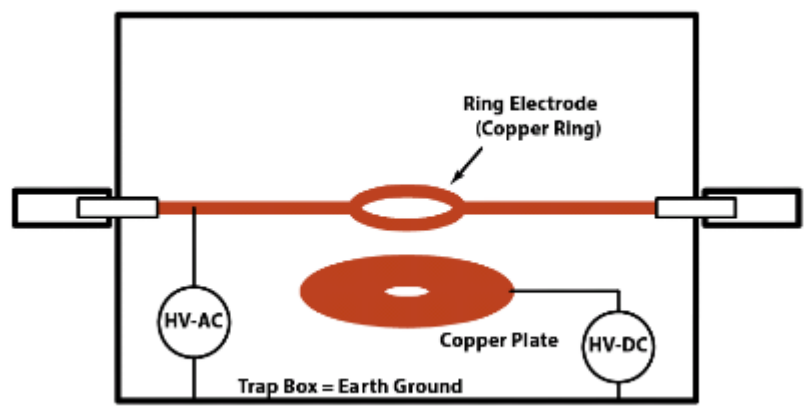

Our setup

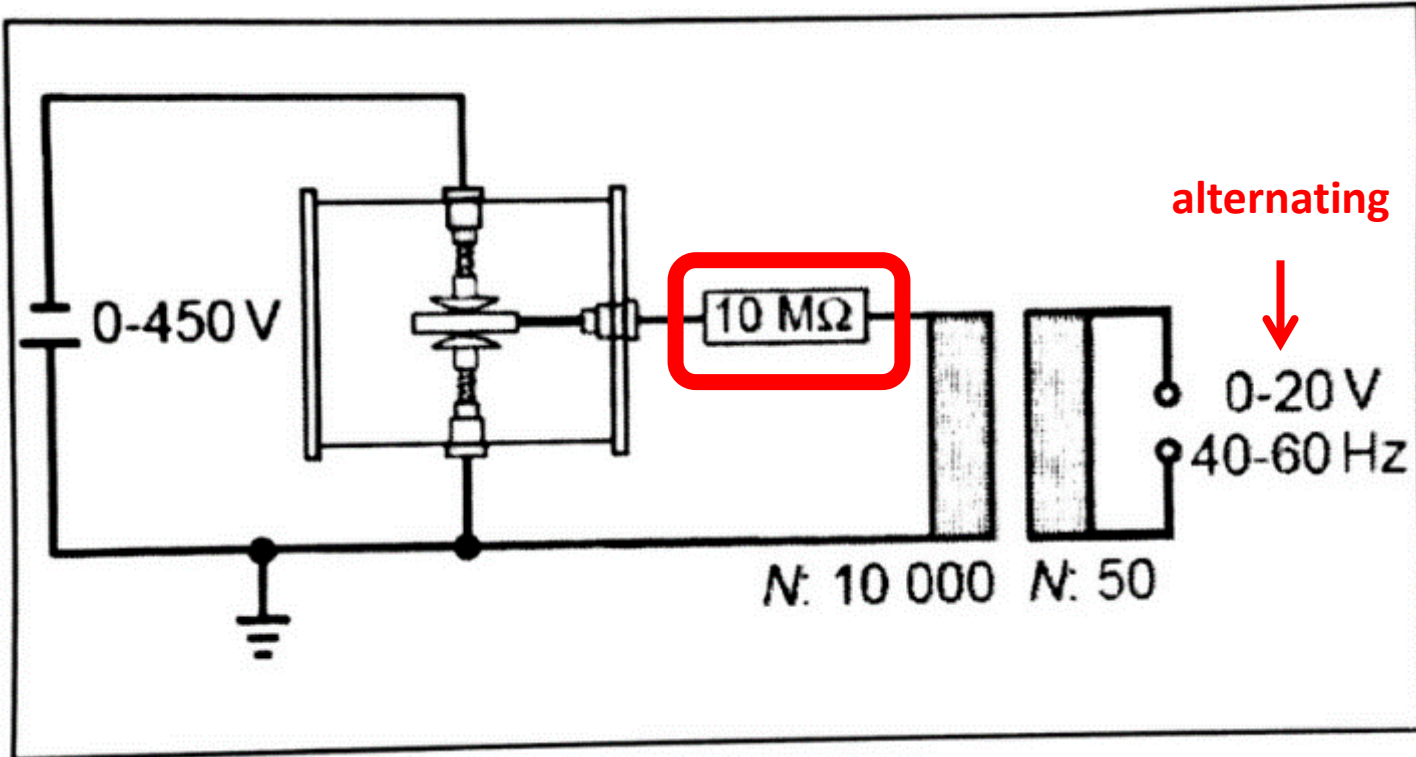

1 mA => slight tingle

10 mA => respectable shock

100 mA => possibly lethal

$$I = \frac{4 \text{ kV}}{10 \text{ M}\Omega} = 0,4 \text{ mA}$$

Our setup





Physical principle $F = E * q$

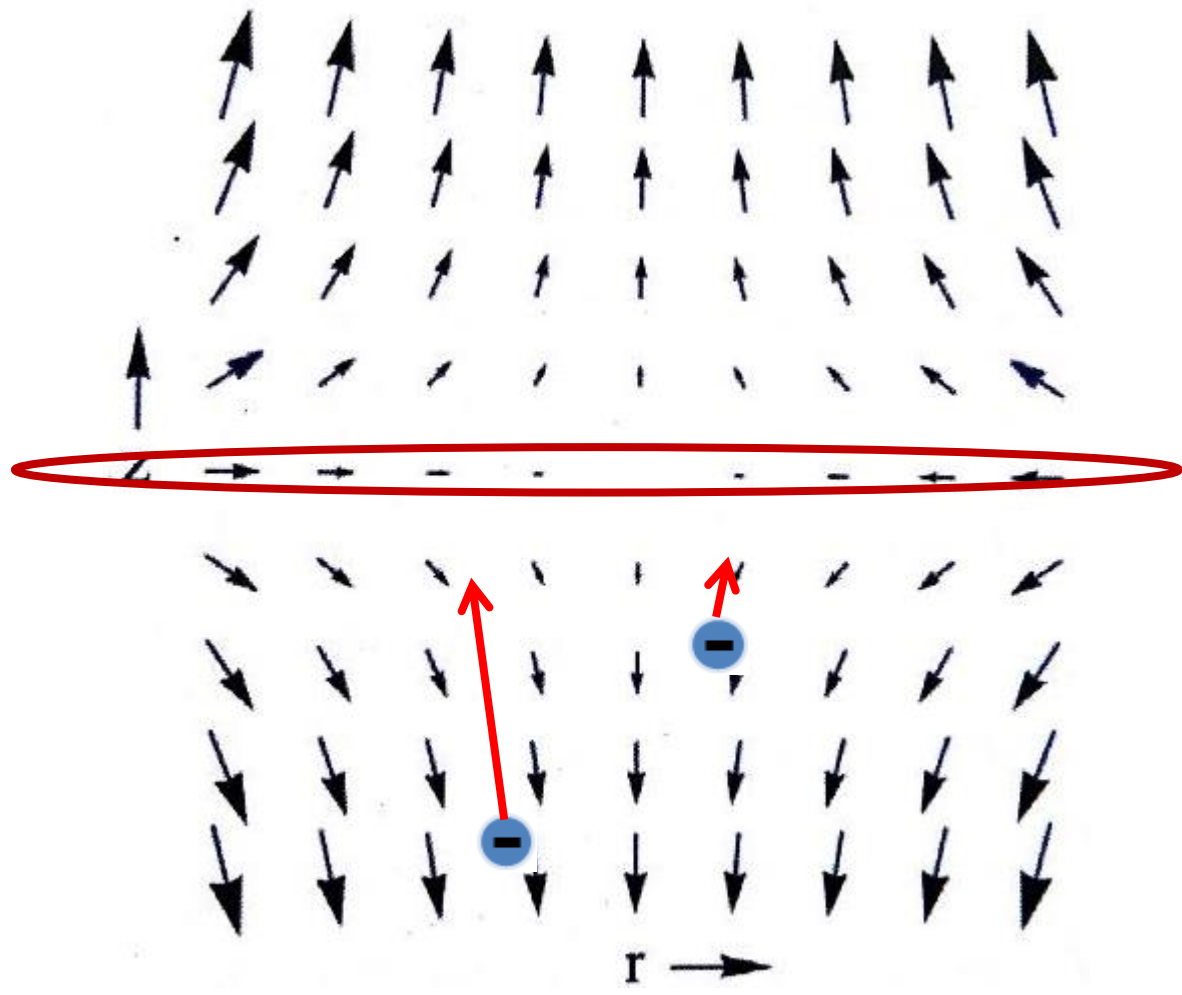



Physical principle $F = E * q$



Almost
homogeneous
electric field to
balance gravity

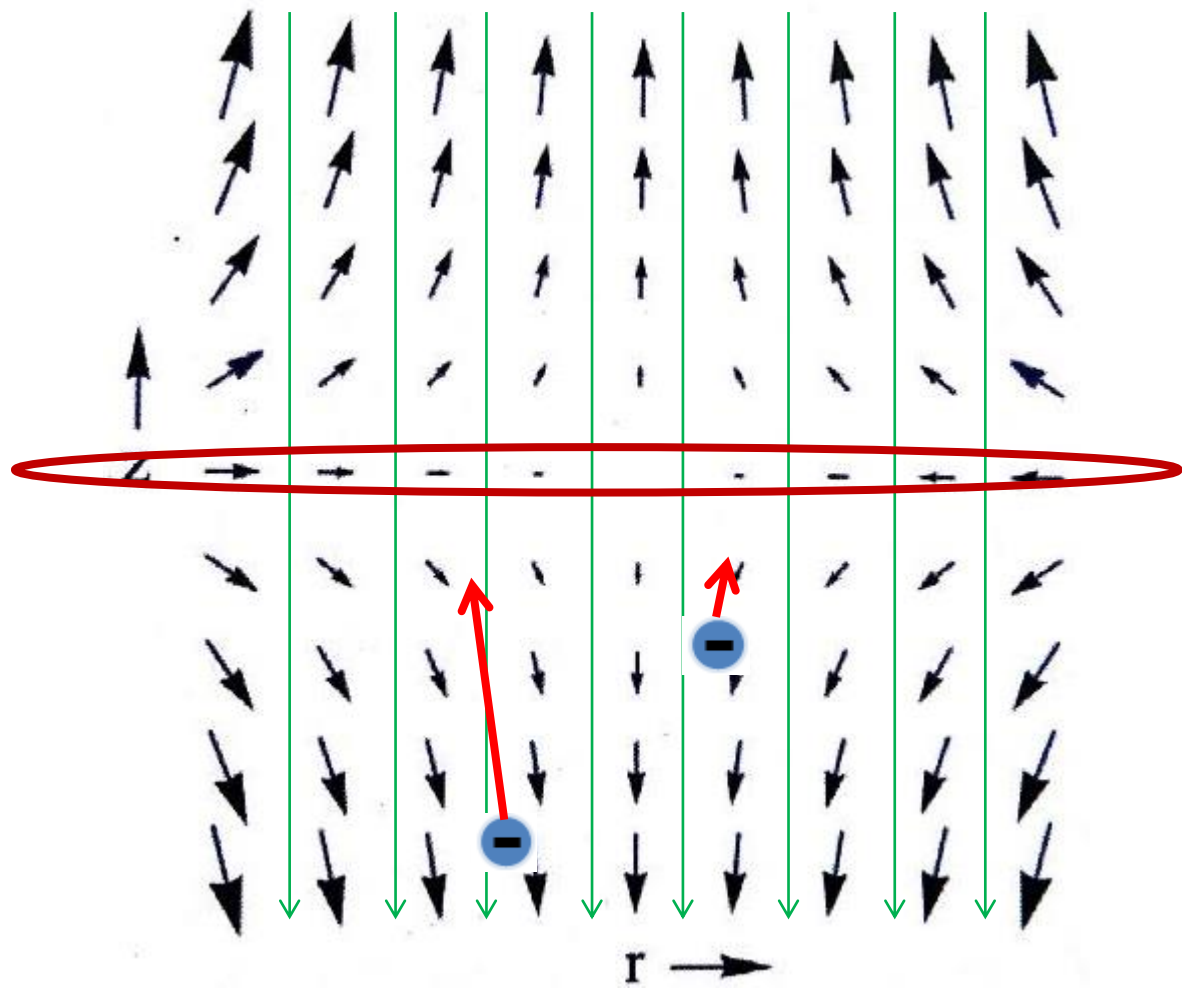

Results



Results

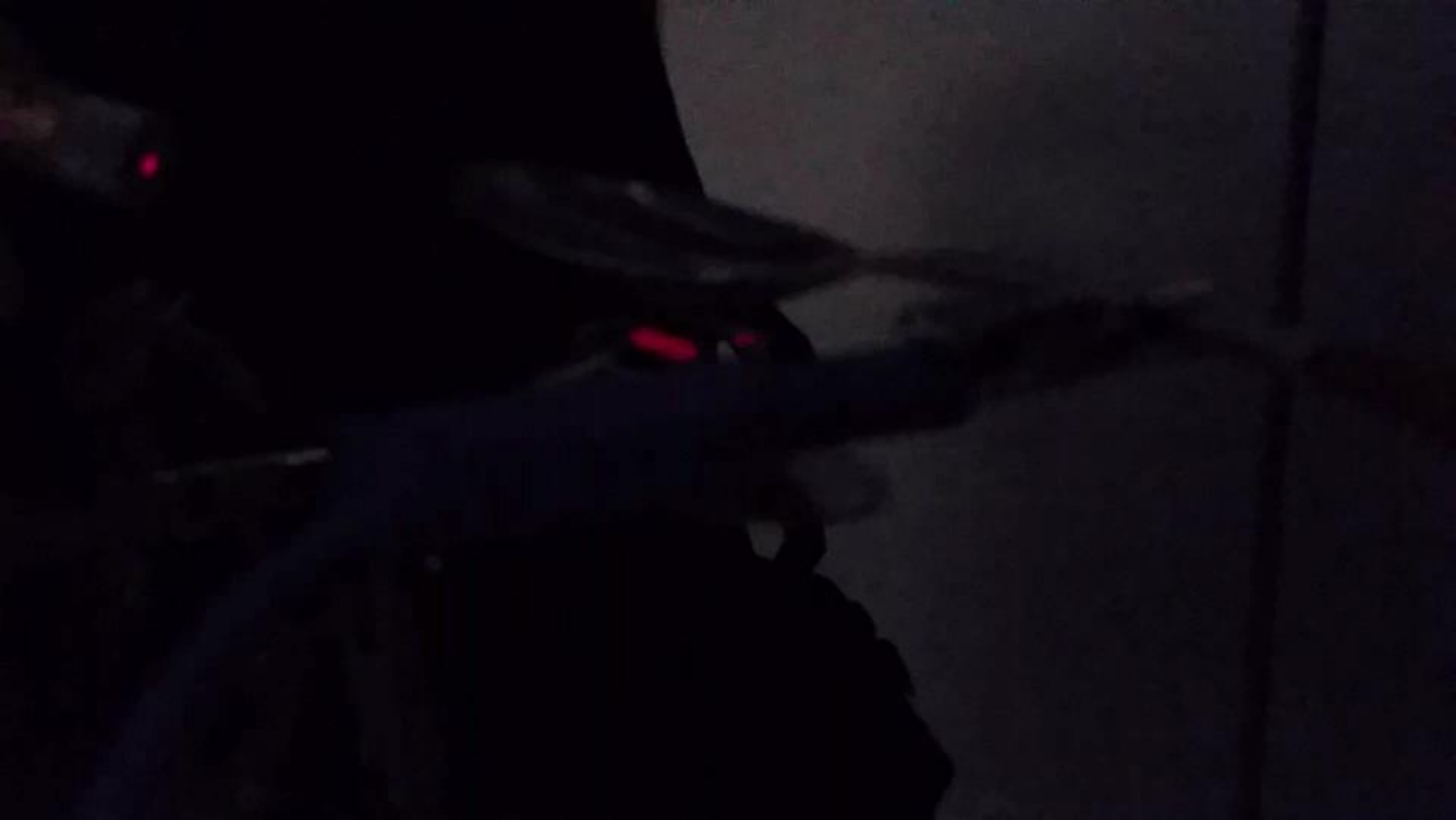

Questions/Tasks for students

Connections with Curriculum

- *Electric field*

Basic characteristics of electric field, electric charge, electric force, electric lines

- *Harmonic oscillation*

- *Modern physics*

Antimatter, Mass-spectroscopy

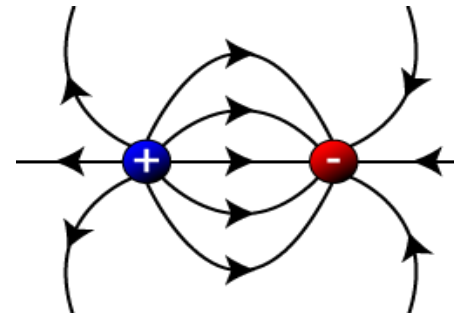
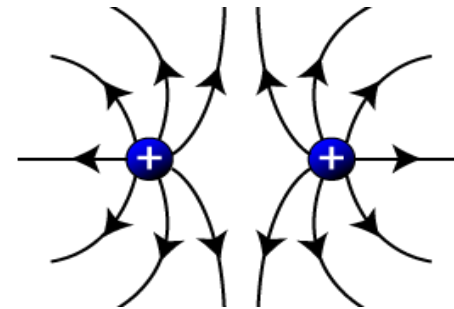





METHODS

- Interactive demonstrations
- Students project

Questions/Tasks for students

- Measure the weights of the spores
- What do you see in the trap? (points or lines) Why?
- How does the HV/AC affects the movement of the particles?
- What would happen if the
 - i) Diameter of the ring is increased?
 - ii) Voltage [DC] is increased?
 - iii) DC supply is switched off?
 - iv) frequency of AC is increased/decreased?
- How can particles sometimes move slow?

And that's all for this HST!



DISCUSSION TIME 2!

Appendix

1. Draw E-field Forces on ions!

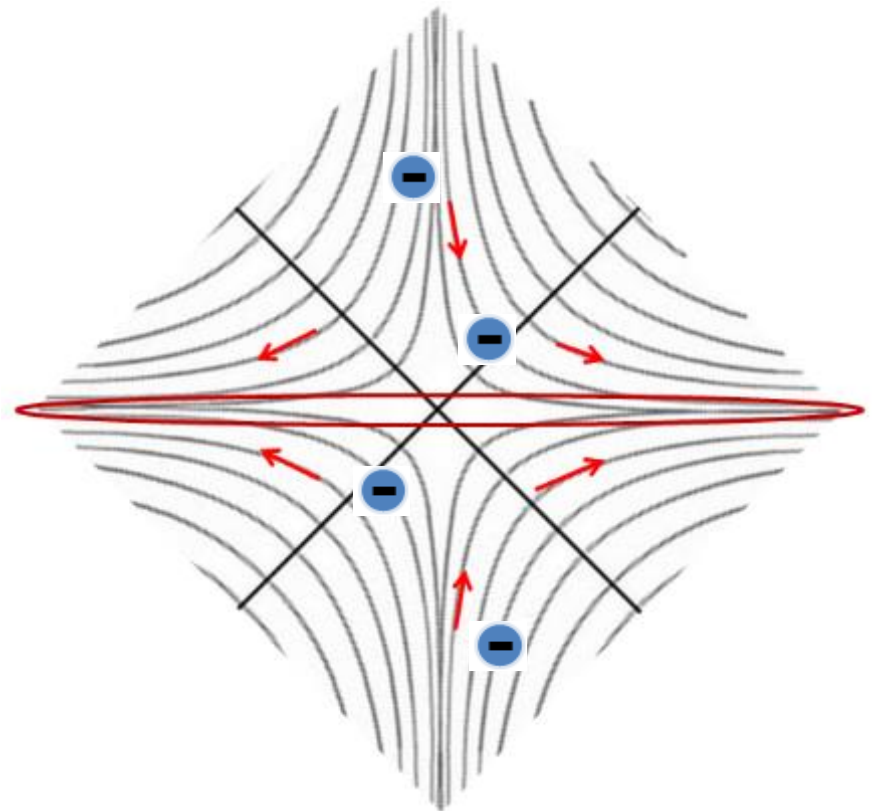
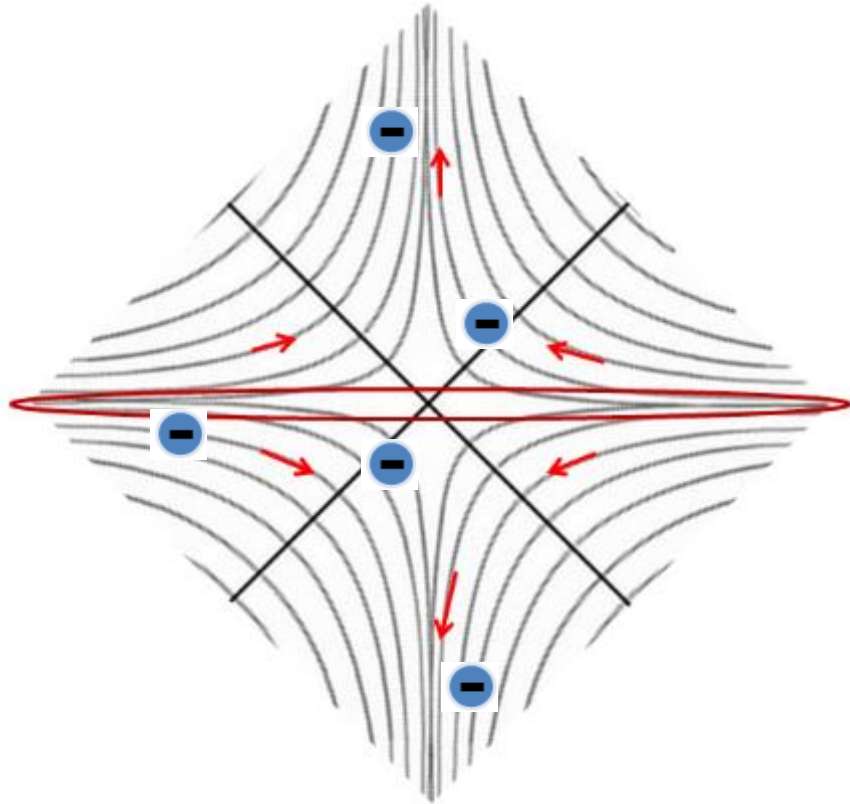

2. What will the motion be like?

The time-dependent electric force on the particle is $F(t) = qE(t) = qE_0 \cos \omega t$, so the motion of the particle in the z direction is described by the equation of motion ($F = ma$)

$$m\ddot{z} = qE_0 \cos \omega t$$

To solve this equation, we try a solution of the form $z = A \cos \omega t$, giving

$$\dot{z} = -\omega A \sin \omega t$$

$$\ddot{z} = -\omega^2 A \cos \omega t$$

$$-m\omega^2 A \cos \omega t = qE_0 \cos \omega t$$

$$\implies A = -\frac{qE_0}{m\omega^2}$$

and this gives the full solution

$$z(t) = z_{init} + v_{init}t - \frac{qE_0}{m\omega^2} \cos \omega t \quad (1)$$

where z_{init} is the initial position of the particle and v_{init} is its initial velocity. Note that this solution works in various



Physical principle

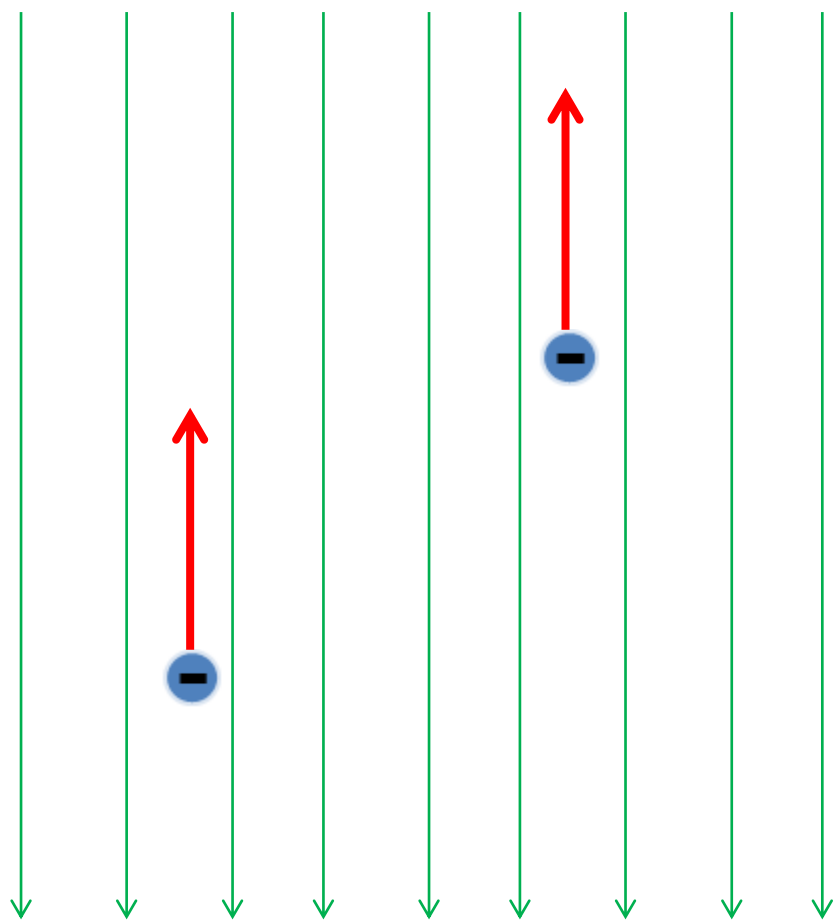

$$F = E * q$$

ATLAS magnetic field model

Lizelle Swanepoel

Miriam Rosenfeld

Julia Aldehoff

Workgroup



Ingredients

- We built a 1:100 model of the Atlas magnet system



- Copper wire
- Plexiglass cutouts
- 16 plexiglass tubes (1x25 cm)
- 1 plexiglass tube (7.5x25 cm)
- 1 plexiglasstube (6x15 cm)
- Compass needles
- Cables
- Transformer
- Connectors

Working



Magnetic components

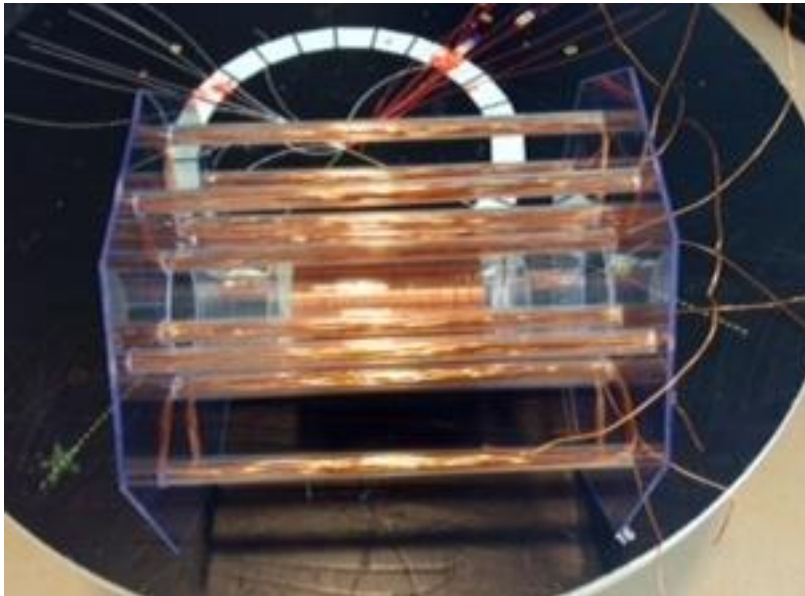
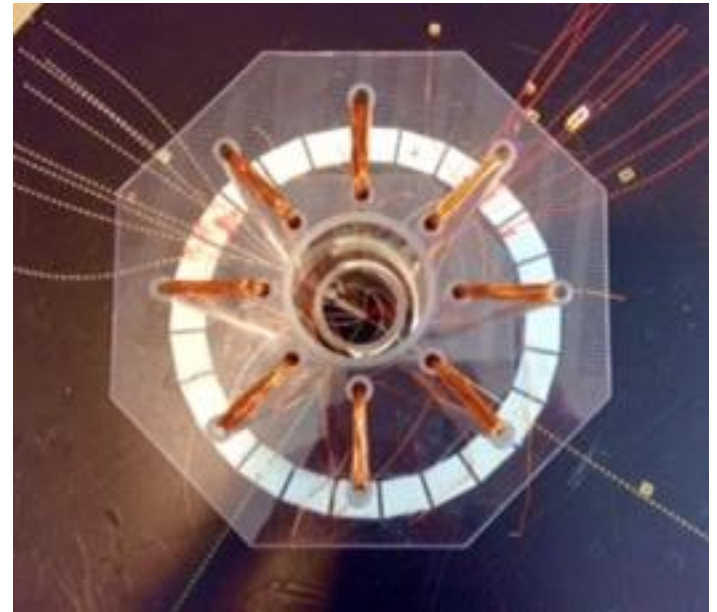

The final model

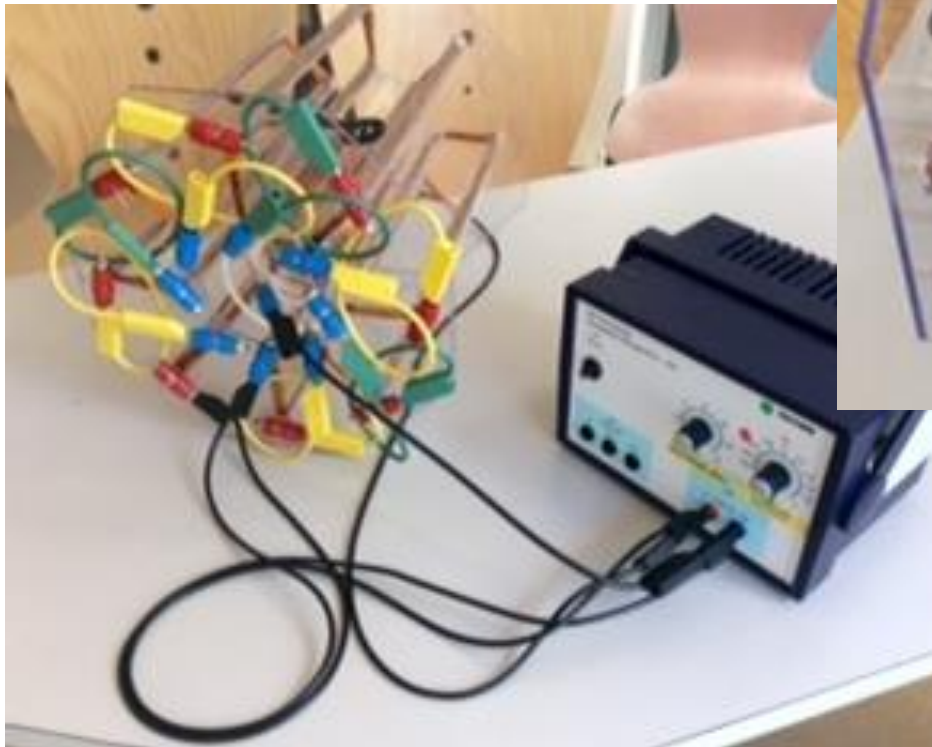

The final model

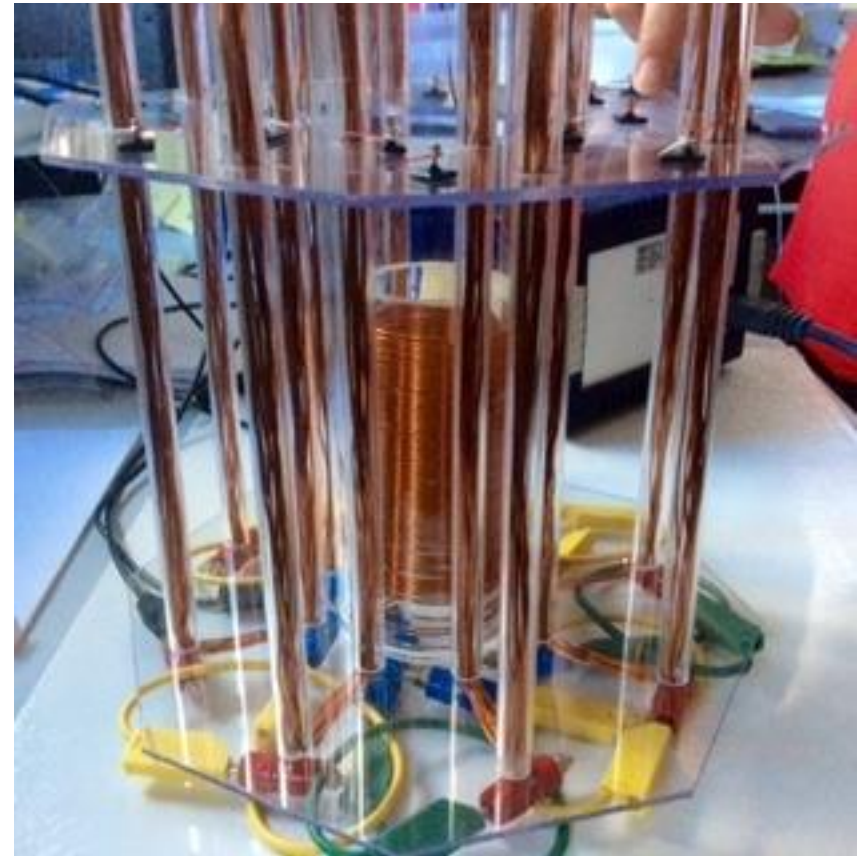
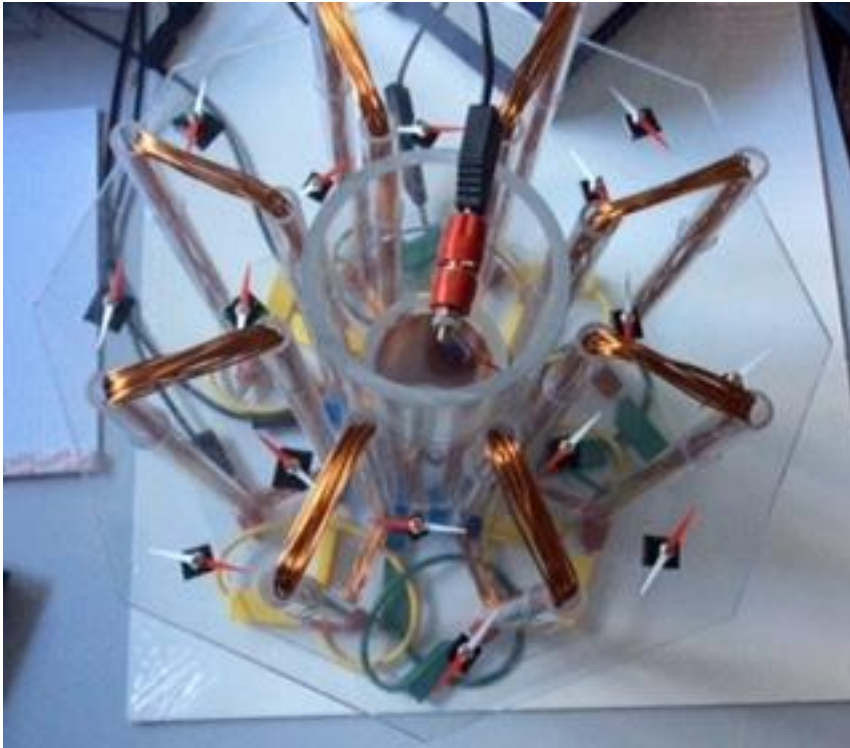

Introducing the activity

The **INDEPENDENT** www.independent.co.uk SINCE 1986 NUMBER 8030. THURSDAY 5 JULY 2012 £1.20 (€1.20)

HOMOPHOBIA, HIP-HOP, AND THE STAR WHO CAME OUT
Trending, pages 26-27

THE L'OREAL FILES: COULD SARKOZY GO DOWN?
News, page 35

MURRAY ONE MATCH FROM THE FINAL
Sport, pages 70-71

EUREKA!

It has taken nearly 50 years and cost £2.6bn. Now, at last, the Higgs boson particle has been found – and a new chapter in our understanding of the universe can begin

A computer-generated image, above, shows proton collisions expected from the decay of a Higgs boson; Peter Higgs, below right

By **STEVE CONNOR**
Science Editor

It was a breakthrough that took almost half a century of deep thought, more than 30 years of painstaking experimentation and a massive £2.6bn machine. Yesterday, scientists said they believed they had found the subatomic



particle that confirms our understanding of how the universe works.

Discovering the so-called "Higgs boson" particle would be one of the greatest achievements in science, rivaling the discovery of the structure of DNA in 1953 and the Apollo Moon landings of the 1960s and 1970s. It can explain why some particles have mass,

but why others, such as photons of light, do not.

Although the discovery is consistent with such a particle – first postulated half a century ago by the retired British physicist Peter Higgs – scientists at the European Organisation

continued on **PAGE 2**

Diamond: I'm sorry (but not sorry enough to give up his pay-off)

By **OLIVER WRIGHT**
and **JAMES MOORE**

Bob Diamond, the former Barclays chief executive, indicated that he would fight to keep his multimillion-pound pay-off after stepping down in the wake of the interest rate-fixing scandal, despite admitting that he was in charge of bankers whose "behaviour... was reprehensible".

Questioned by MPs on the Treasury Select Committee, Mr Diamond said he was "sorry, disappointed and



Diamond may get a £30m pay-off

angry" but reportedly failed to waive his pay-off of up to £30m, claiming it is a matter for the Barclays board.

He said he only found out about the rigging of the London Interbank Offered Rate (Libor) when he saw the Financial Services Authority's report, and that he was "physically ill" when he read emails from Barclays traders discussing the fixing.

Last night, the Chancellor claimed former Labour ministers were "clearly involved" in the scandal.

Further reports: **PAGES 4-6**



<http://www.atlas.ch/photos/lhc.html>

Model vs. reality

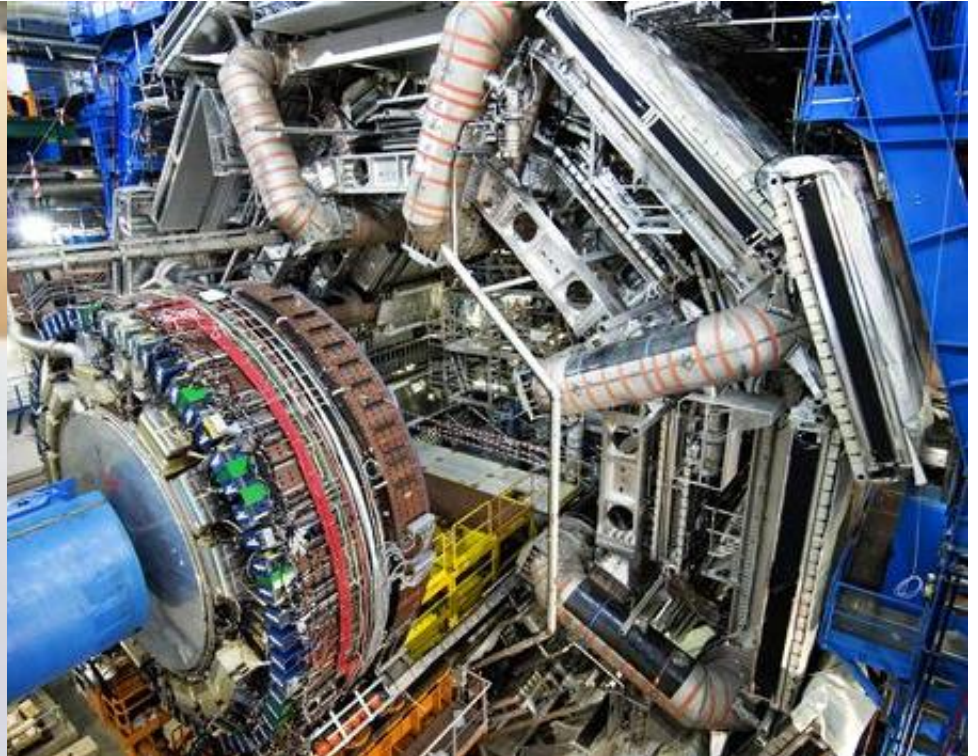
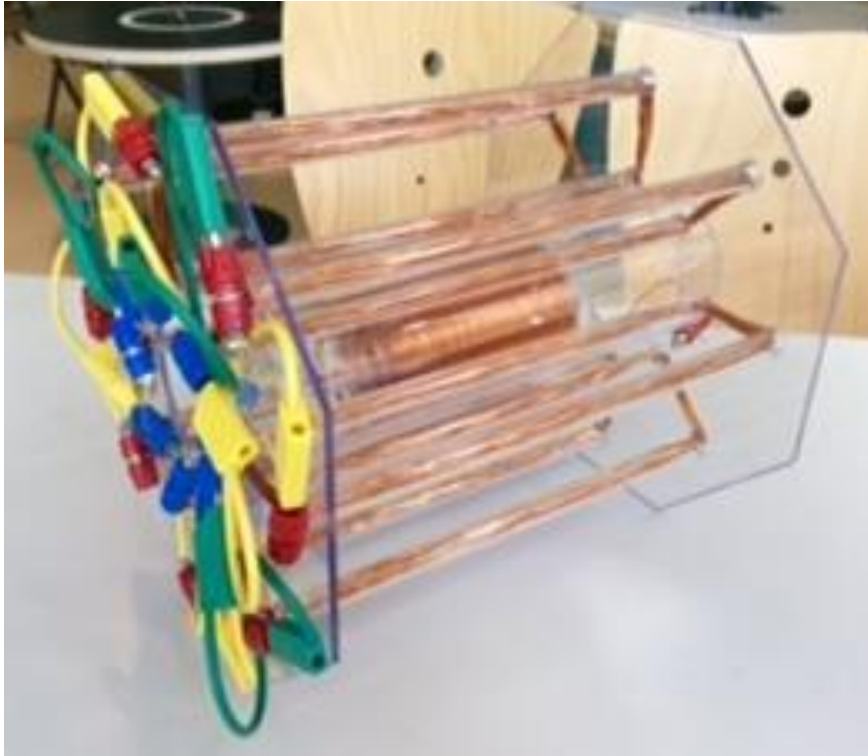

Picture from Bernhard Holzer's presentation

Lab circus to study magnetic fields

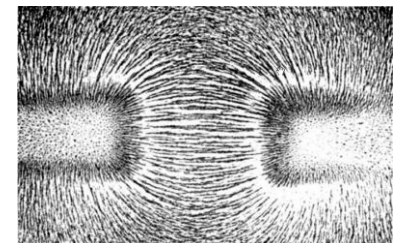
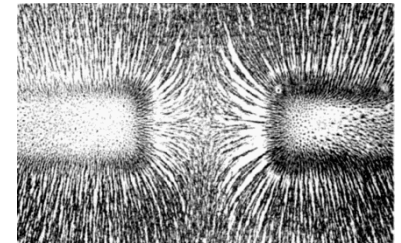
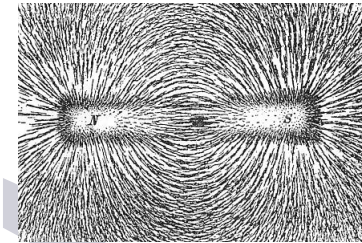
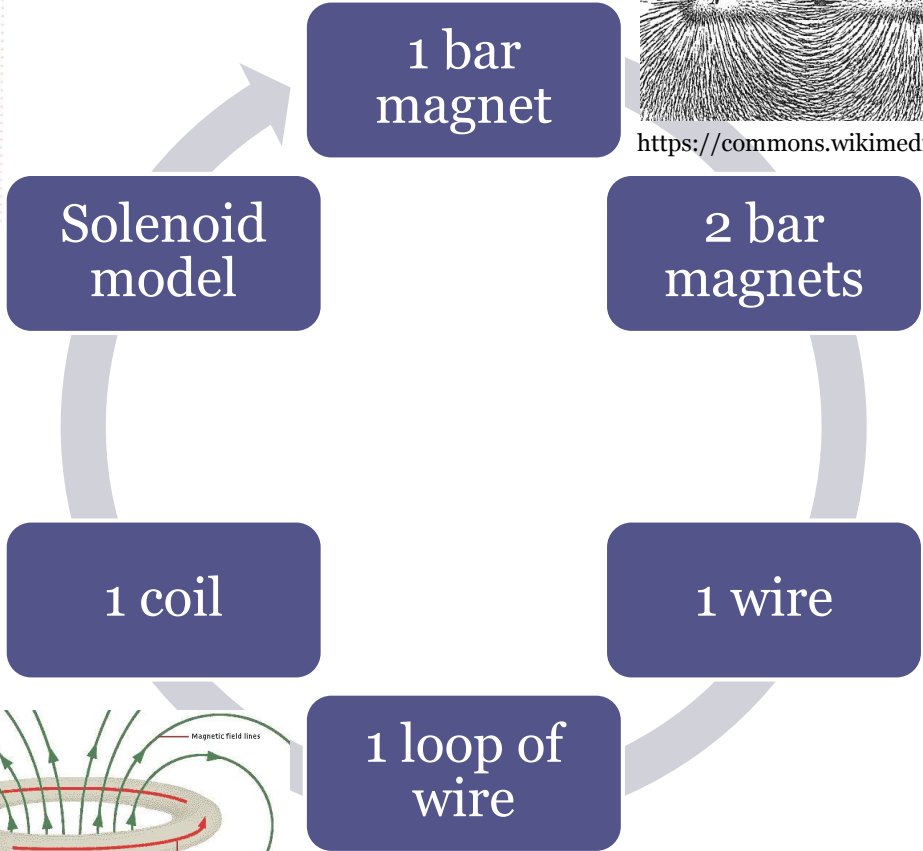
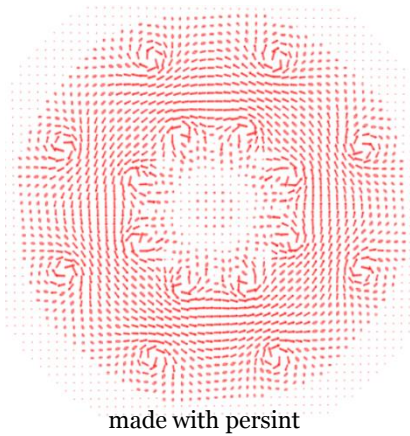

<https://commons.wikimedia.org>

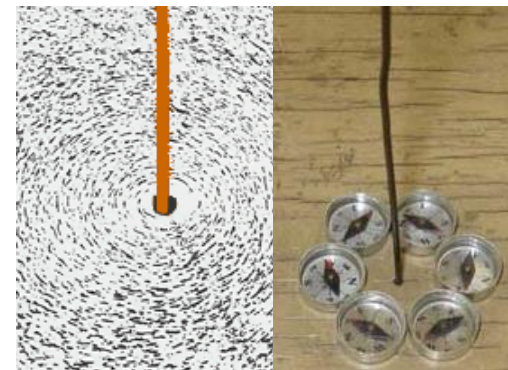

<http://www.physics.ucla.edu>

http://www.trincoll.edu/~cgeiss/stuff/the%20rocky%20road/ch_1/ch1_p1.htm

1 loop of wire

<https://commons.wikimedia.org>

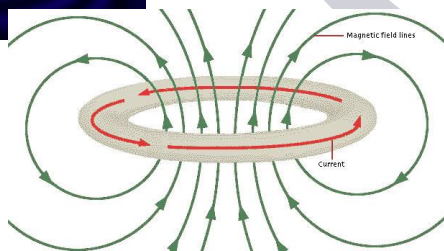

<http://www.askamathematician.com>

1 coil

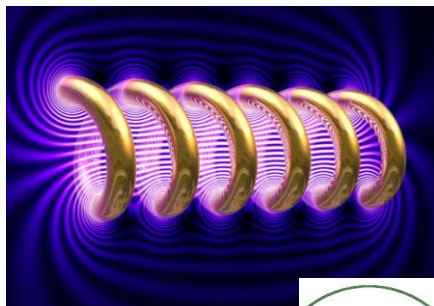

<http://www.cibermitanios.com.ar/2008/05/10-simulaciones-fisicas-asombrosas.html>

Advanced experiments

- 2 experiments to show how charged particles (e^-) react in a magnetic field
- these illustrate the fundamental principle of deflection using appropriate hand rules

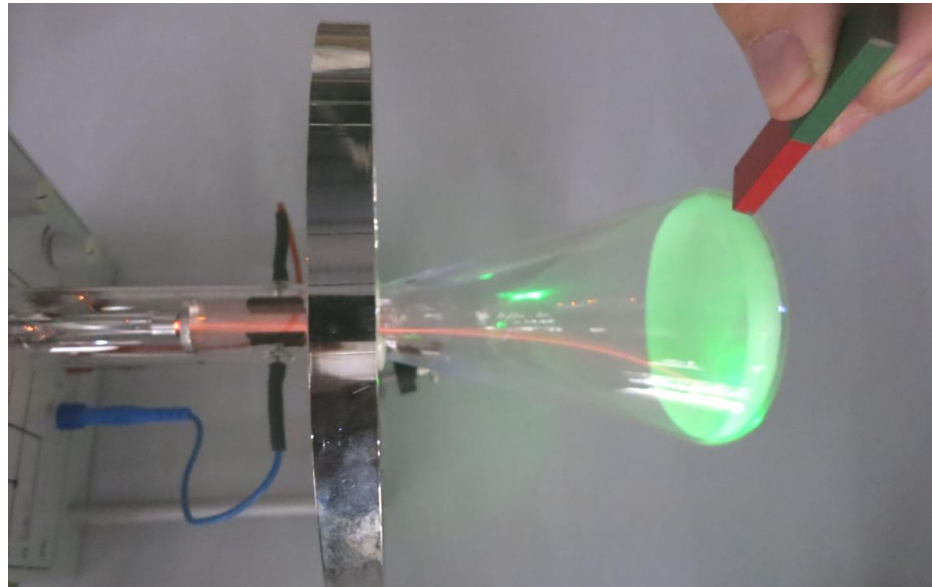
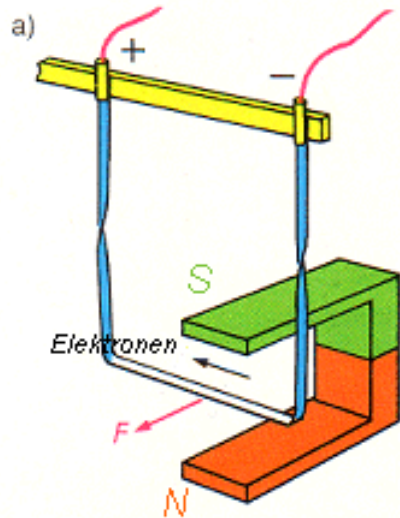

Particle deflection in ATLAS detector

- Simulation of the electron and positron
- Prediction with the Lorentz-force

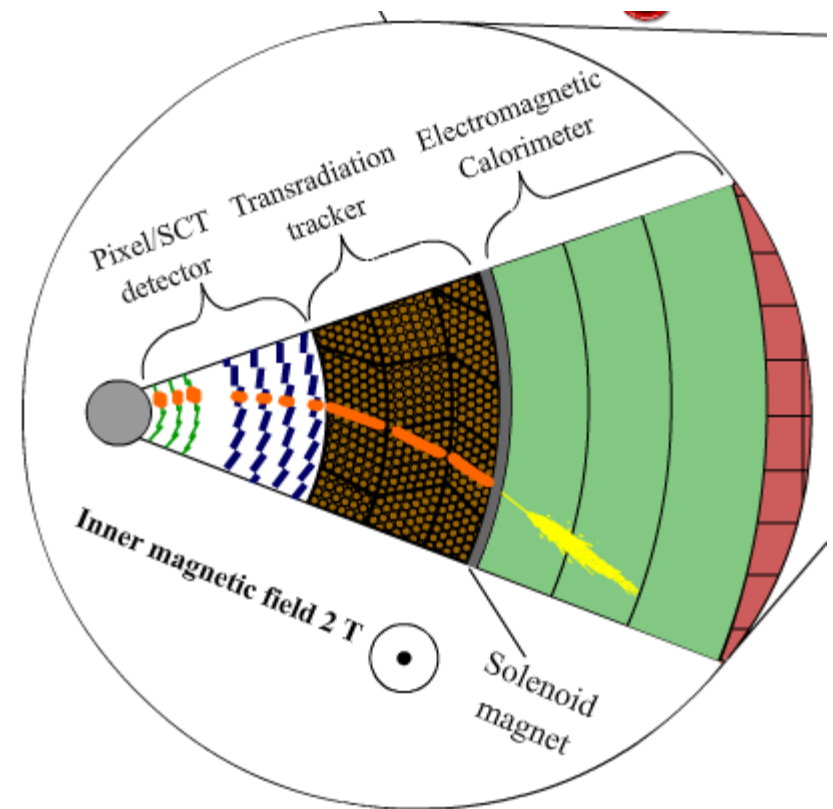
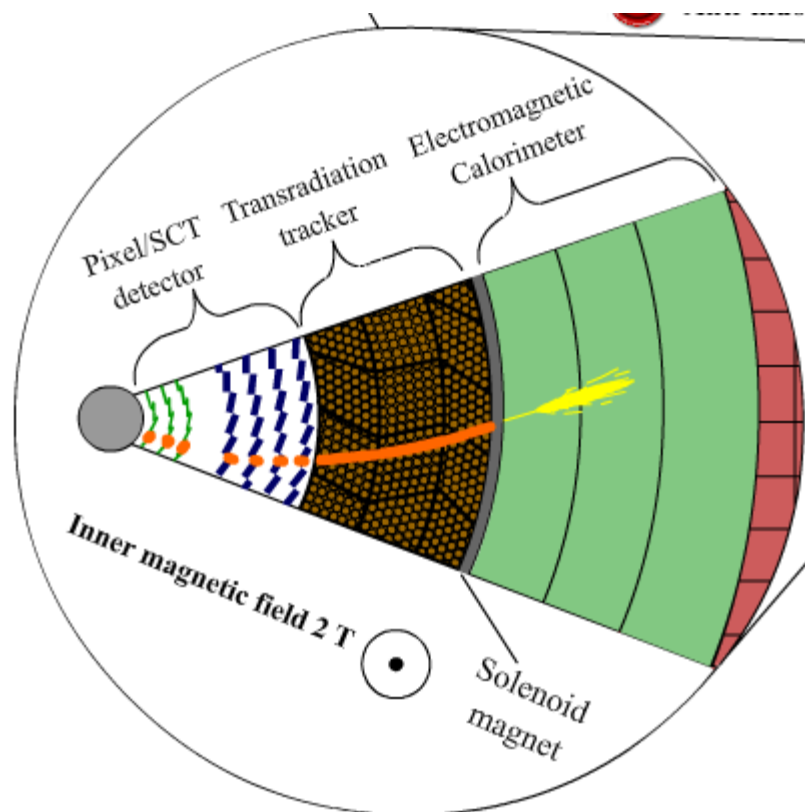

Particle deflection in ATLAS detector

- Deflection of the muon is more complex

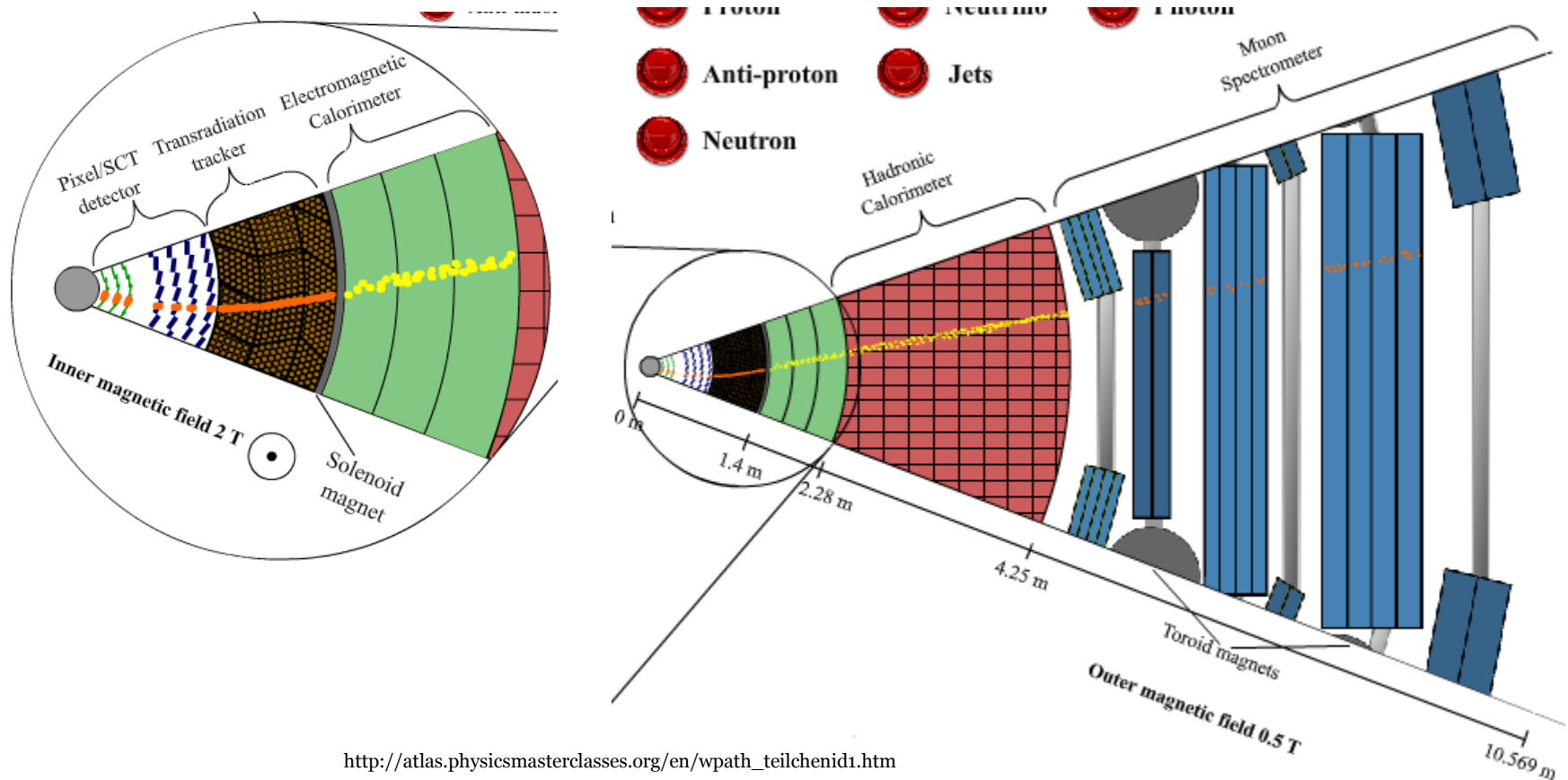

A simulation for the toroid field

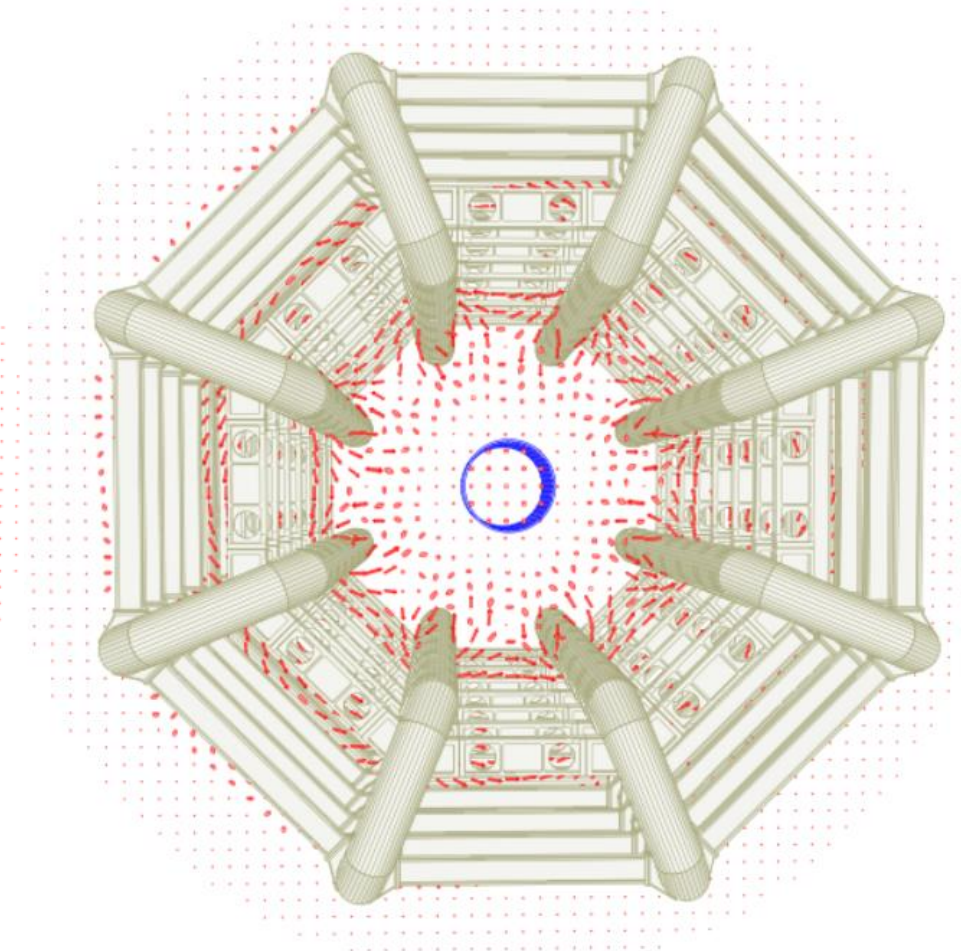
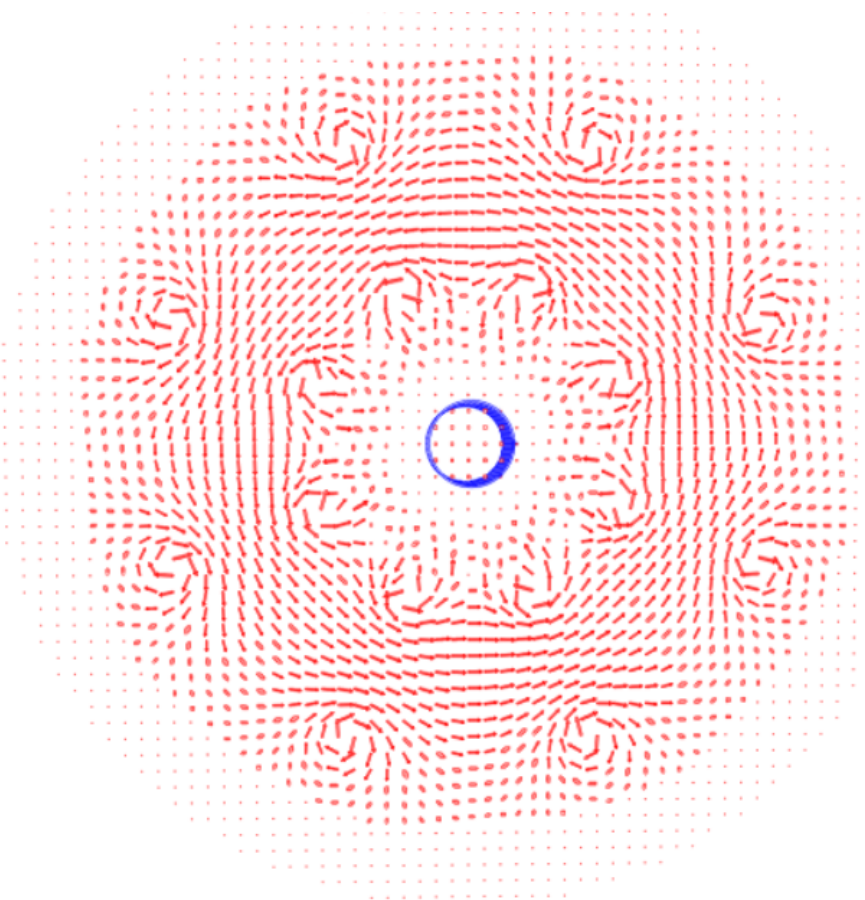

A simulation for the toroid field

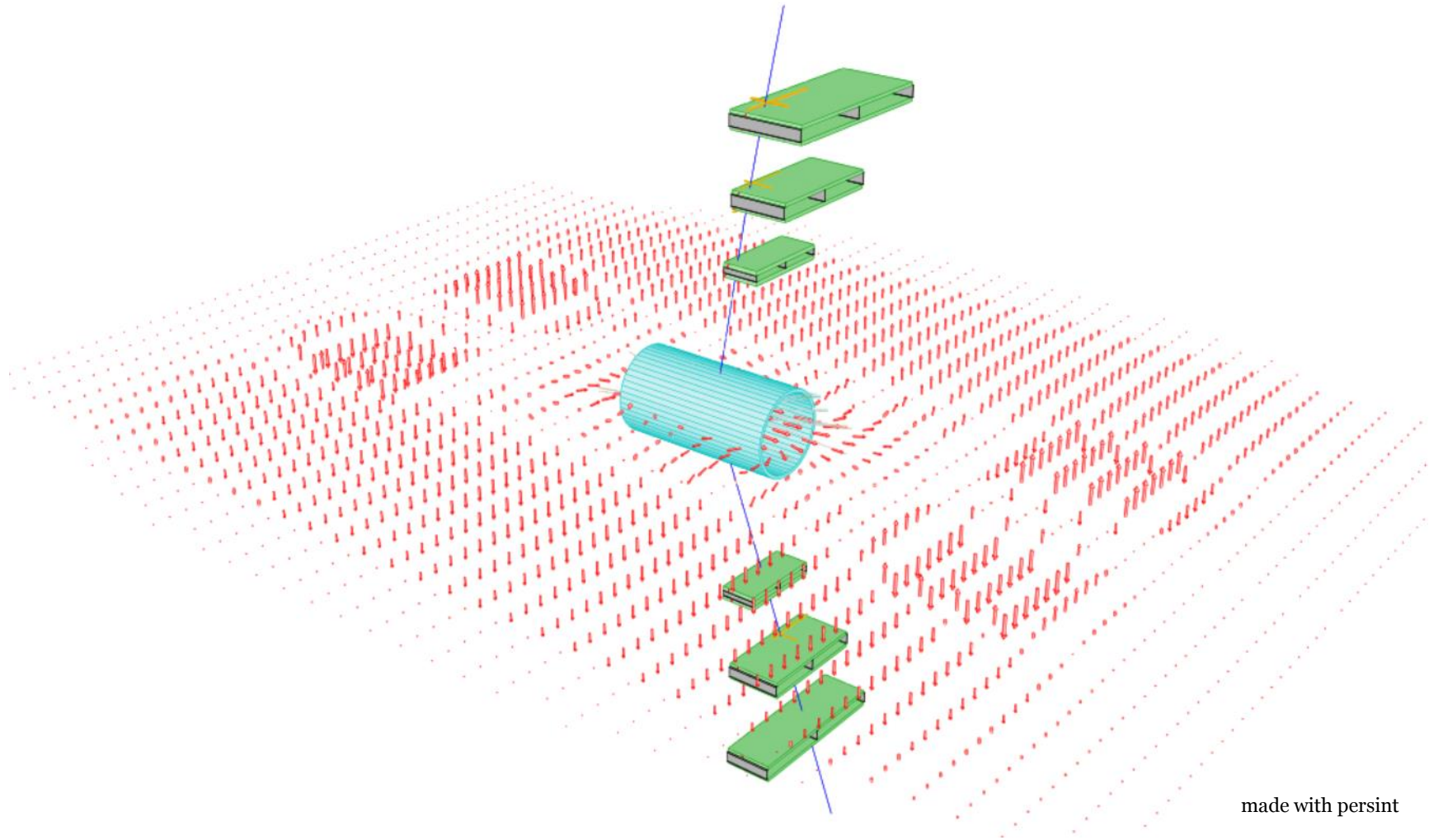

Measurement of the magnetic field

- Different methods to use:
 - Compasses
 - Magna Probe (3D-compass needle)
 - Smartphone app (teslameter)
 - Hall-Probe
(exact magnetic field strength in Tesla)



Curricular context

- Period
 - 11th or 12th grade
- Topic
 - Electrodynamics
 - particle physics
(consolidating previous and extending knowledge)

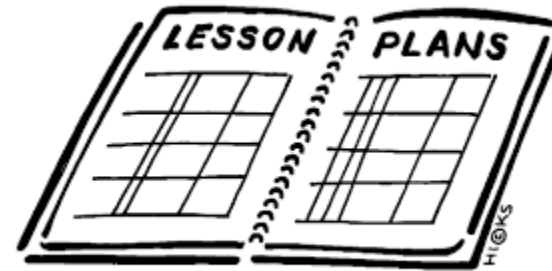

List of references

- ATLAS animation:
http://atlas.physicsm asterclasses.org/en/w path_teilchenid1.htm
- Persint:
http://irfu.cea.fr/Pho cea/Vie_des_labos/As t/ast_sstechnique.php ?id_ast=3113

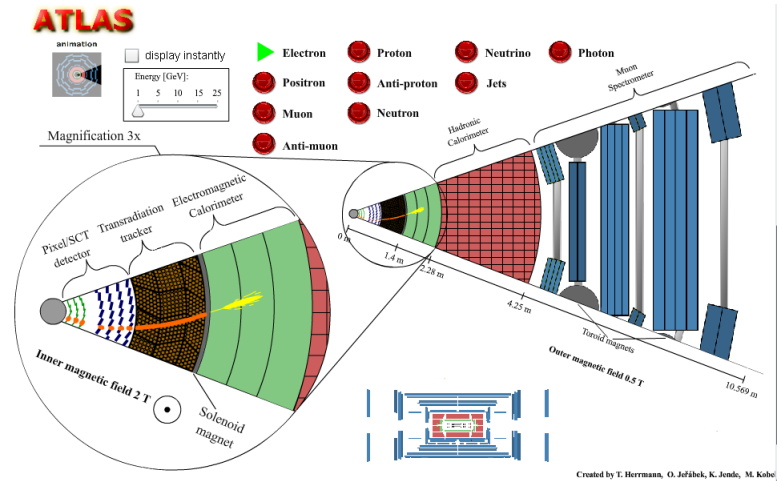

Persint

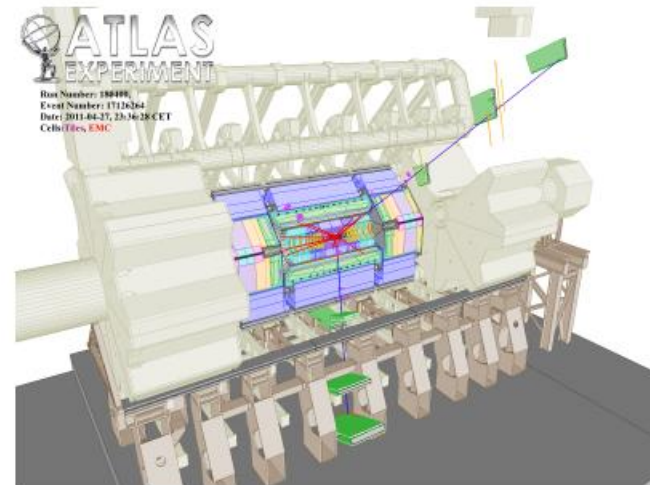



Thank you for your attention!

Any questions?