



S'Cool
LAB

Rules in S'Cool LAB



Bags

To avoid collisions, please place your bags and jackets in the designated shelf!

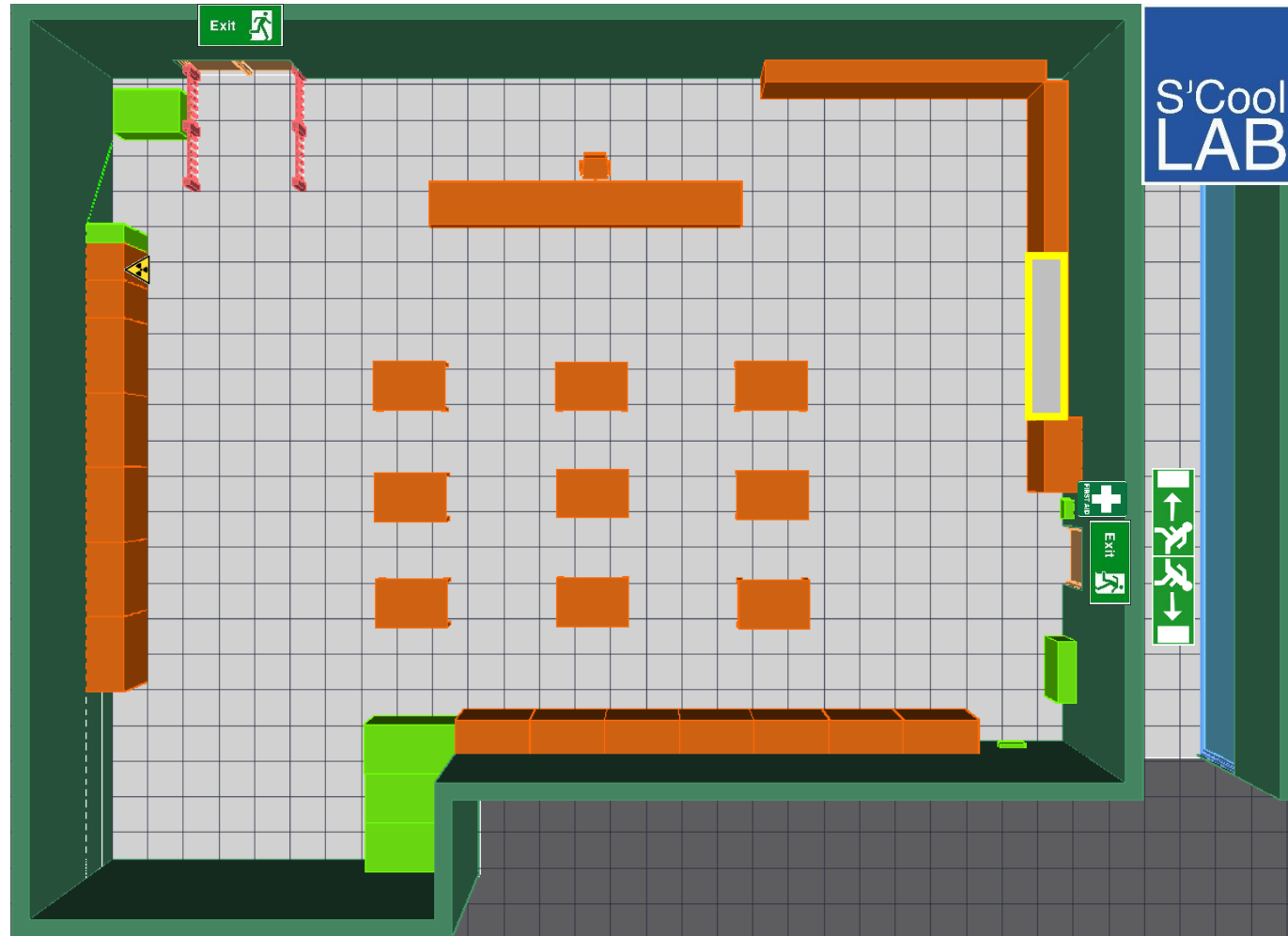

Emergency exits

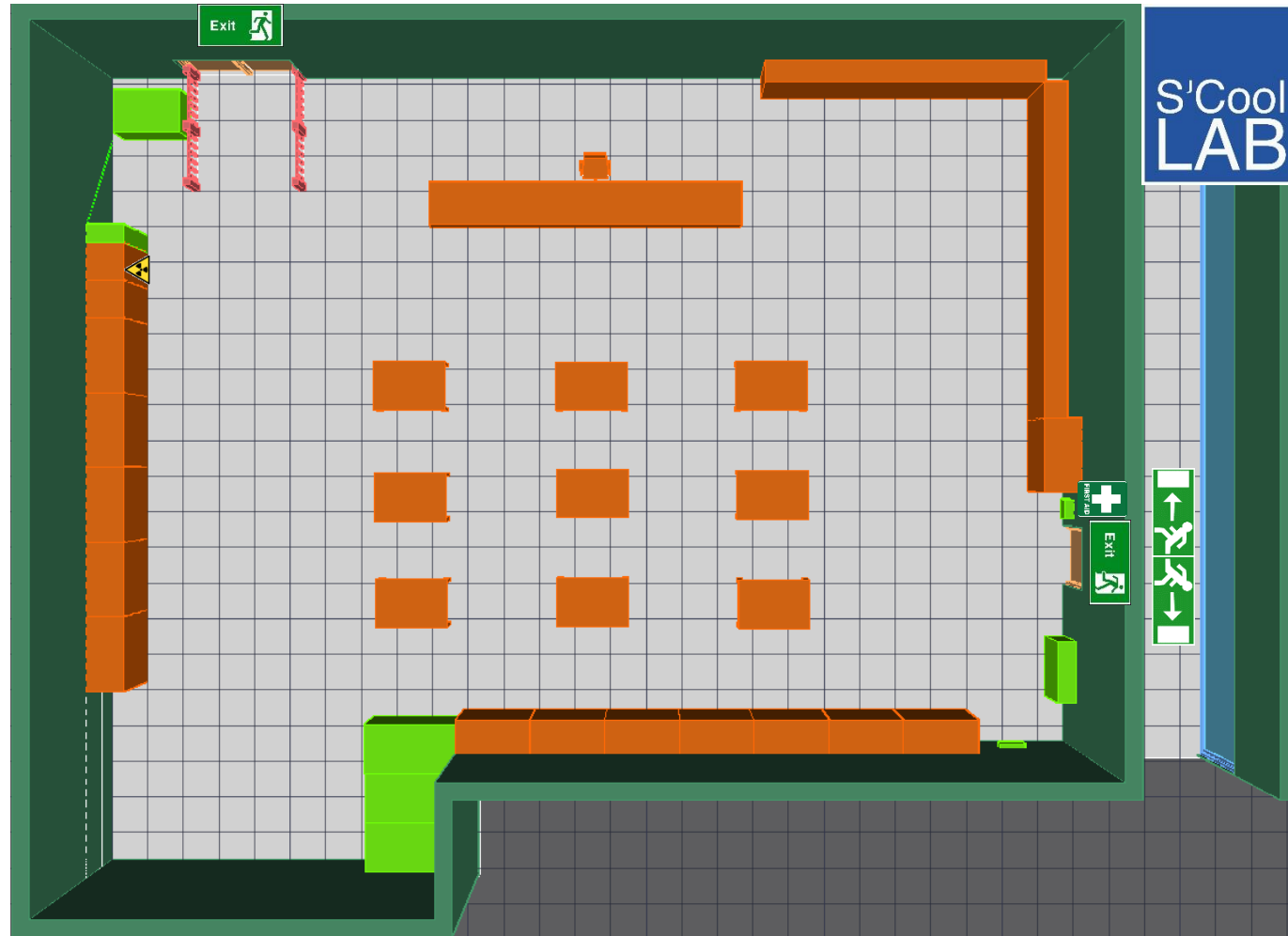

Assembly point

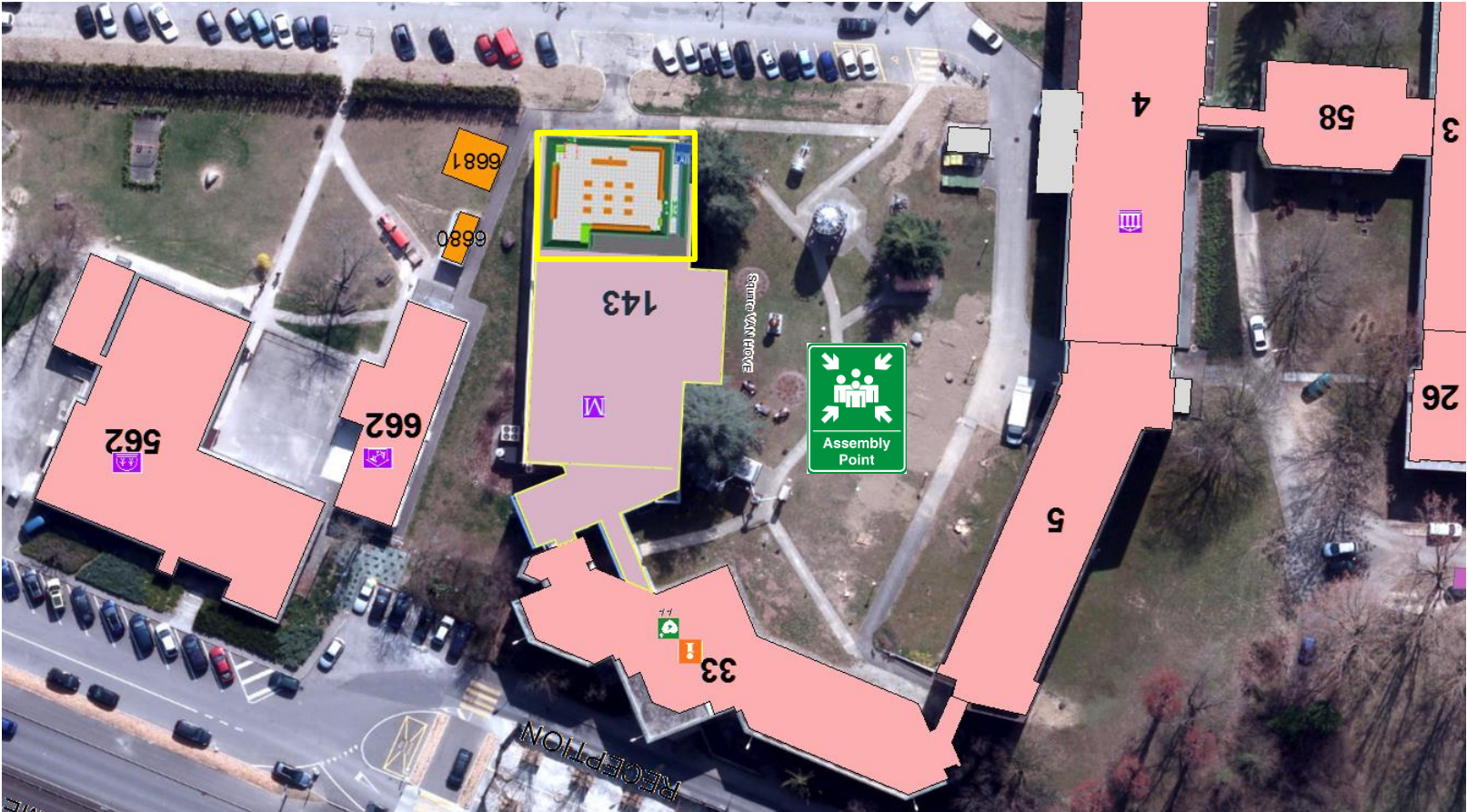

Rest rooms

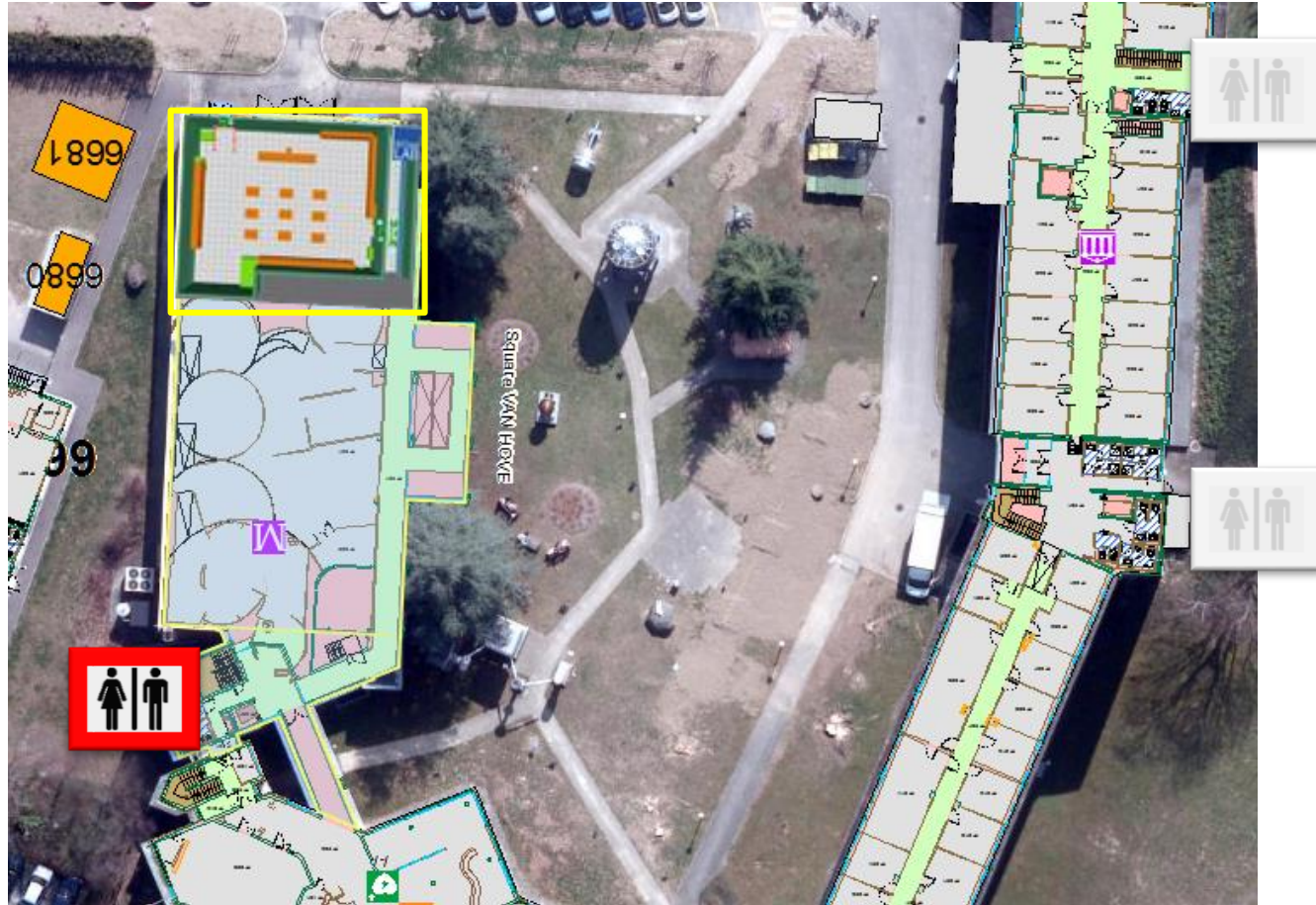

Cloud Chamber Workshop

Outline

- History
- Step by step tutorial
- Build your own particle detector
- Tidying up
- Discussion and explanations

History

History

Charles T. R. Wilson (1869 - 1959)

This Scottish physicist perfected the first (expansion) cloud chamber in 1911 and received the Nobel Prize in 1927.

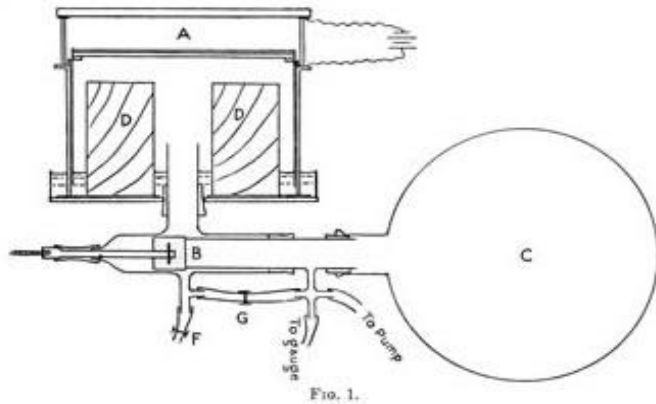

A diagram of Wilson's apparatus. The cylindrical cloud chamber ('A') is 16.5cm across by 3.4cm deep.

C. T. R. WILSON: *On an Expansion Apparatus for Making Visible the Tracks of Ionising Particles in Gases and Some Results Obtained by Its Use.* Proc. R. Soc. Lond. A. 1912 87 277-292 DOI:[10.1098/rspa.1912.0081](https://doi.org/10.1098/rspa.1912.0081)

Carl Anderson (1905 - 1991)

This physicist discovered the positron in 1932 and the muon in 1936 using a cloud chamber. He received the Nobel Prize in 1936.

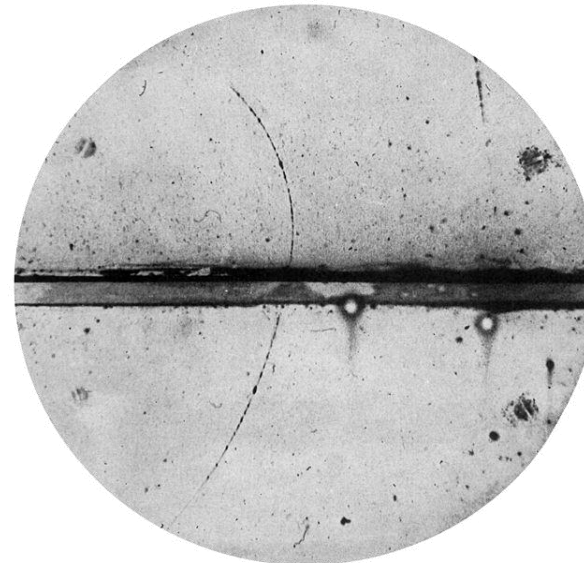

Carl D. Anderson (1905–1991) - Anderson, Carl D. (1933). "The Positive Electron". *Physical Review* 43 (6): 491–494. DOI:[10.1103/PhysRev.43.491](https://doi.org/10.1103/PhysRev.43.491).

Step by step tutorial

Build your cloud chamber - step by step



Build your cloud chamber - step by step

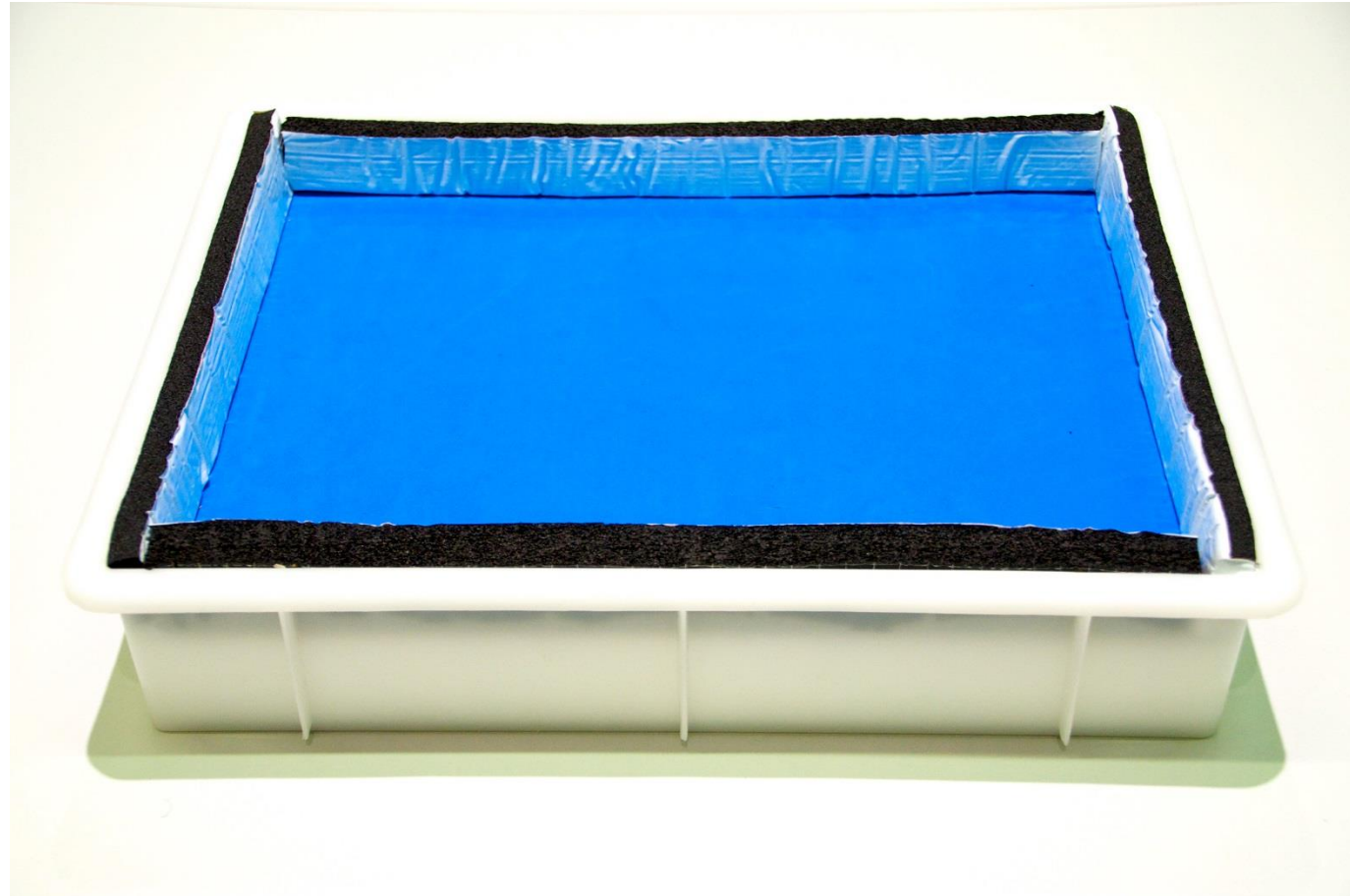

Build your cloud chamber - step by step

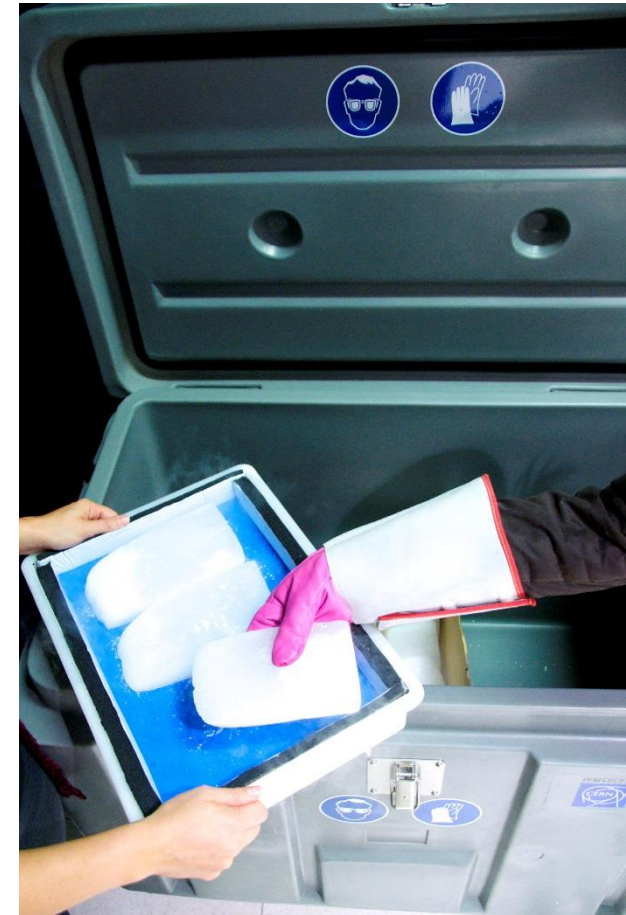

Build your cloud chamber - step by step



Build your cloud chamber - step by step

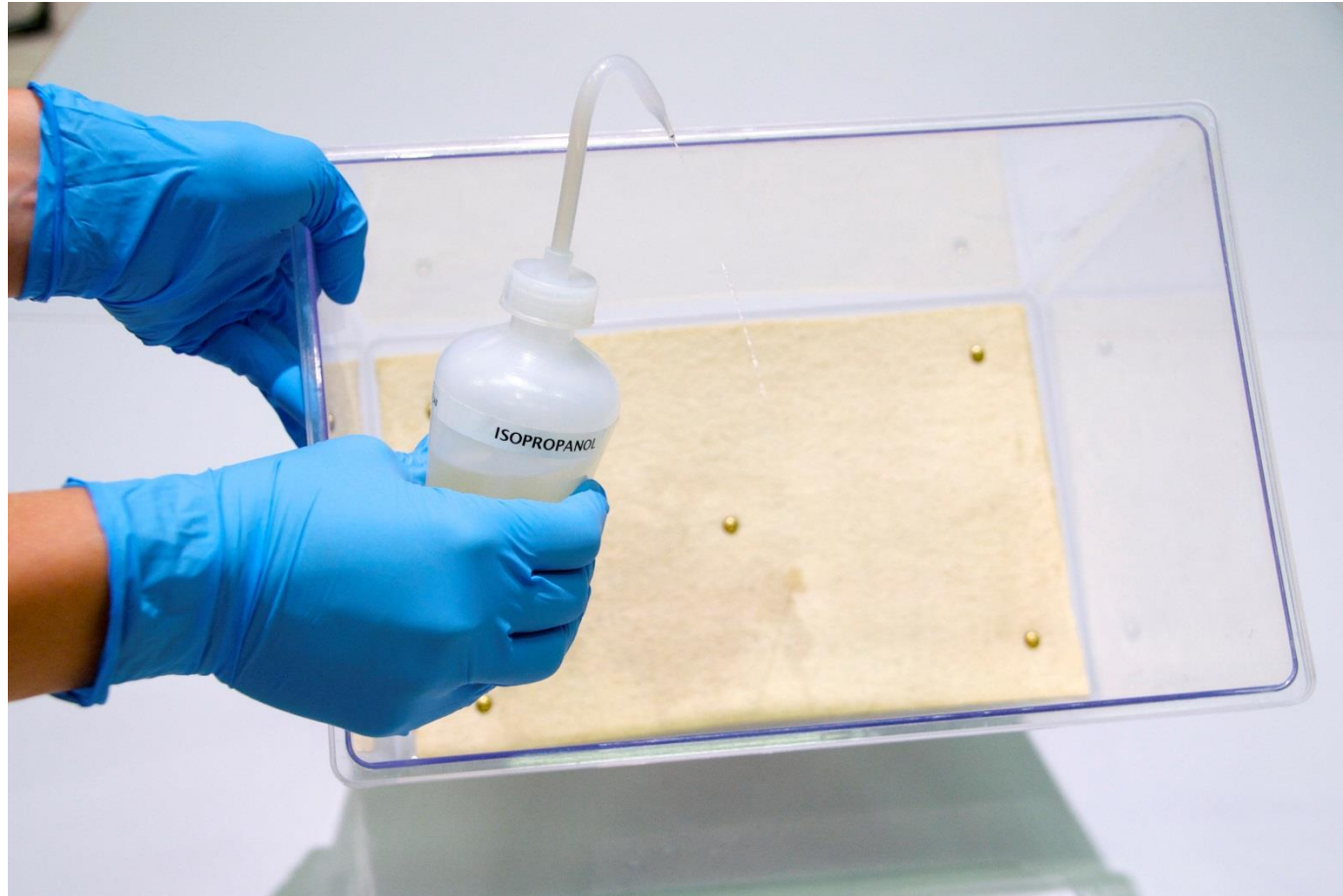

Build your cloud chamber - step by step



Build your cloud chamber - step by step

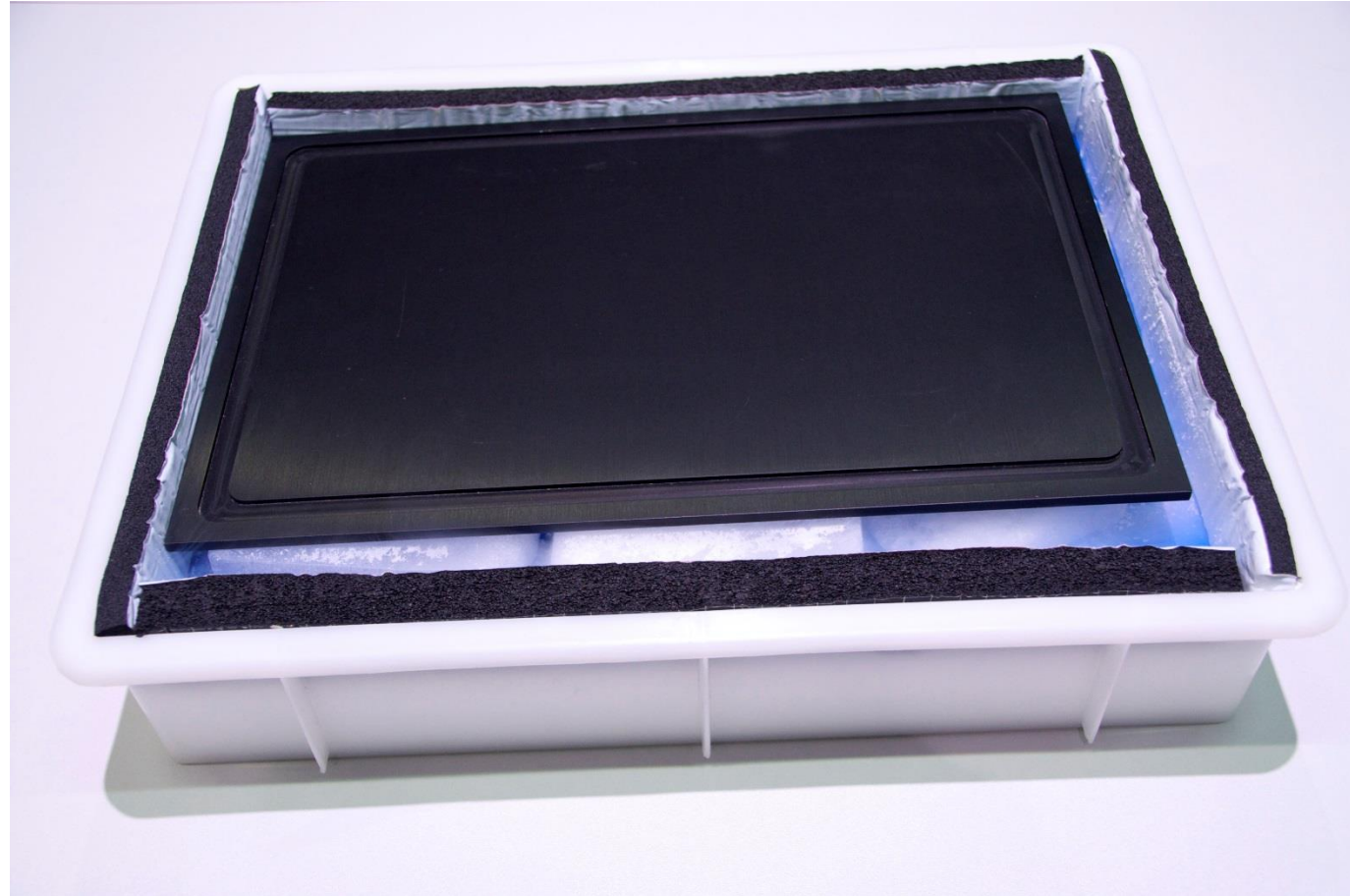

Build your cloud chamber - step by step

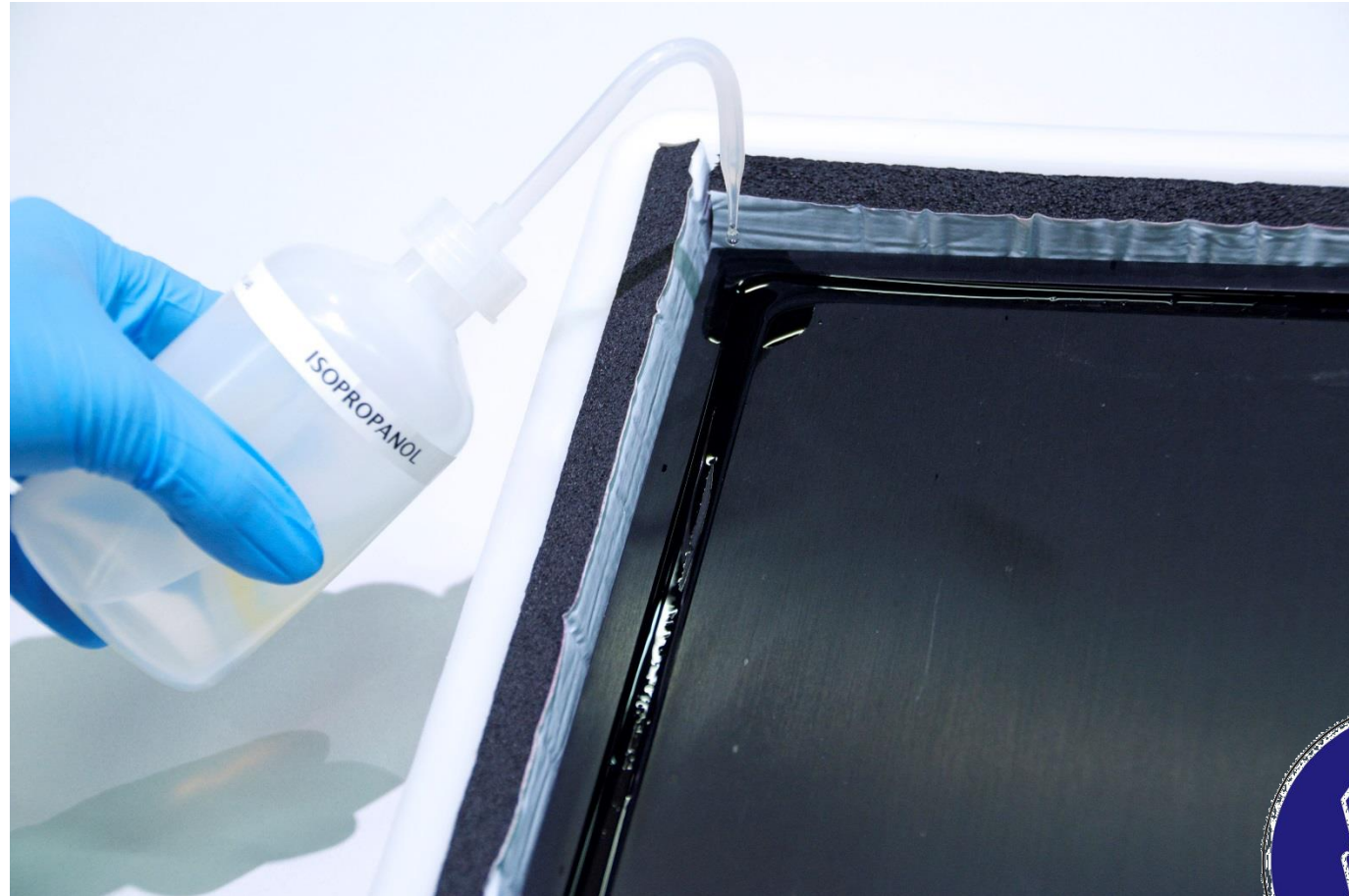

Build your cloud chamber - step by step



Build your cloud chamber - step by step

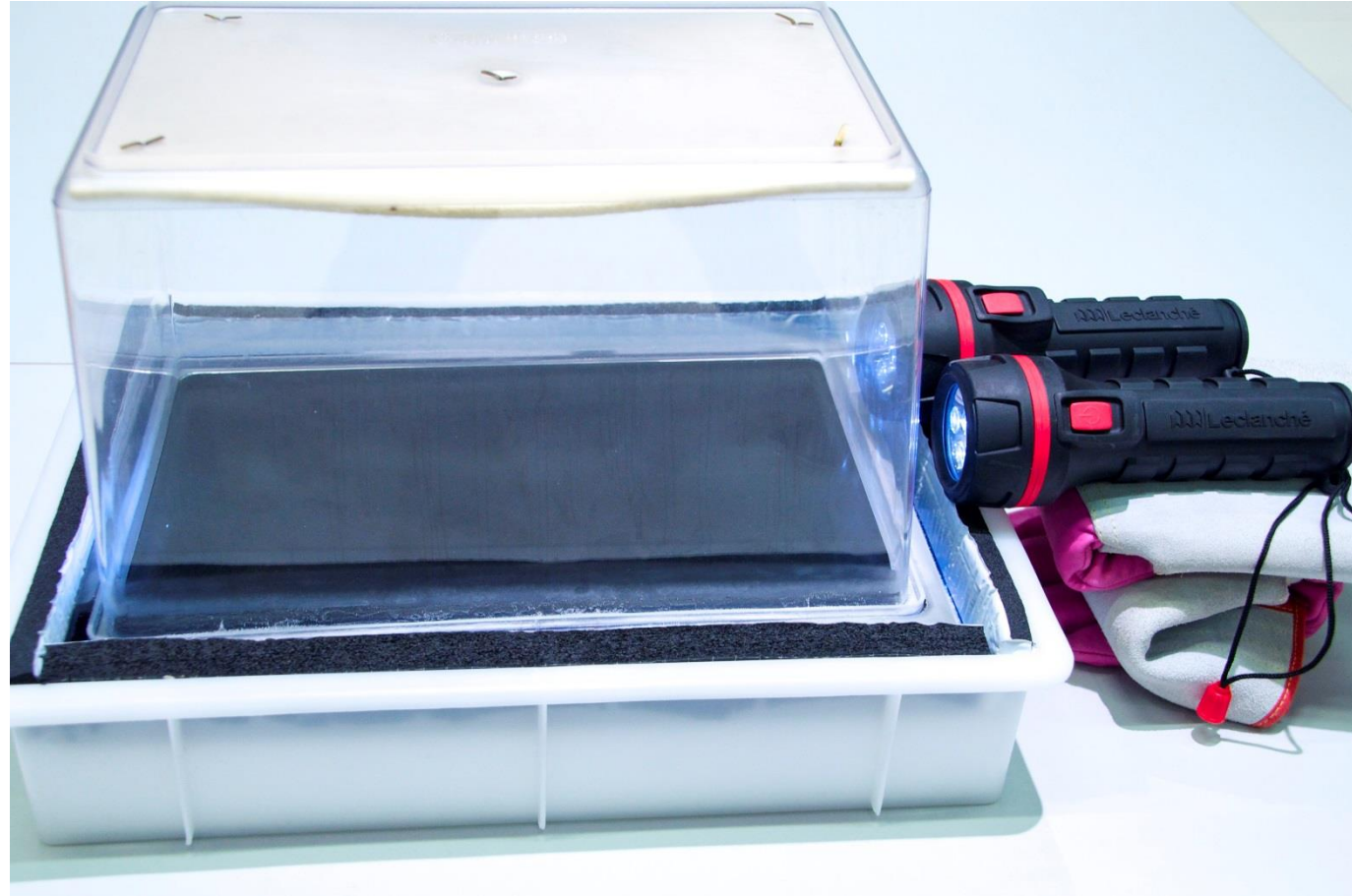

👉 Build your own particle detector!



Build your own particle detector!

Tasks

- Observe your Cloud Chamber
- Find the optimal torch position and the optimal observation position
- Describe visible tracks (shape, length, width, ...)
- Discuss the reason for these tracks
- Count the number of tracks you can see for 1 minute, repeat this measurement 2 times

👉 Tidying up

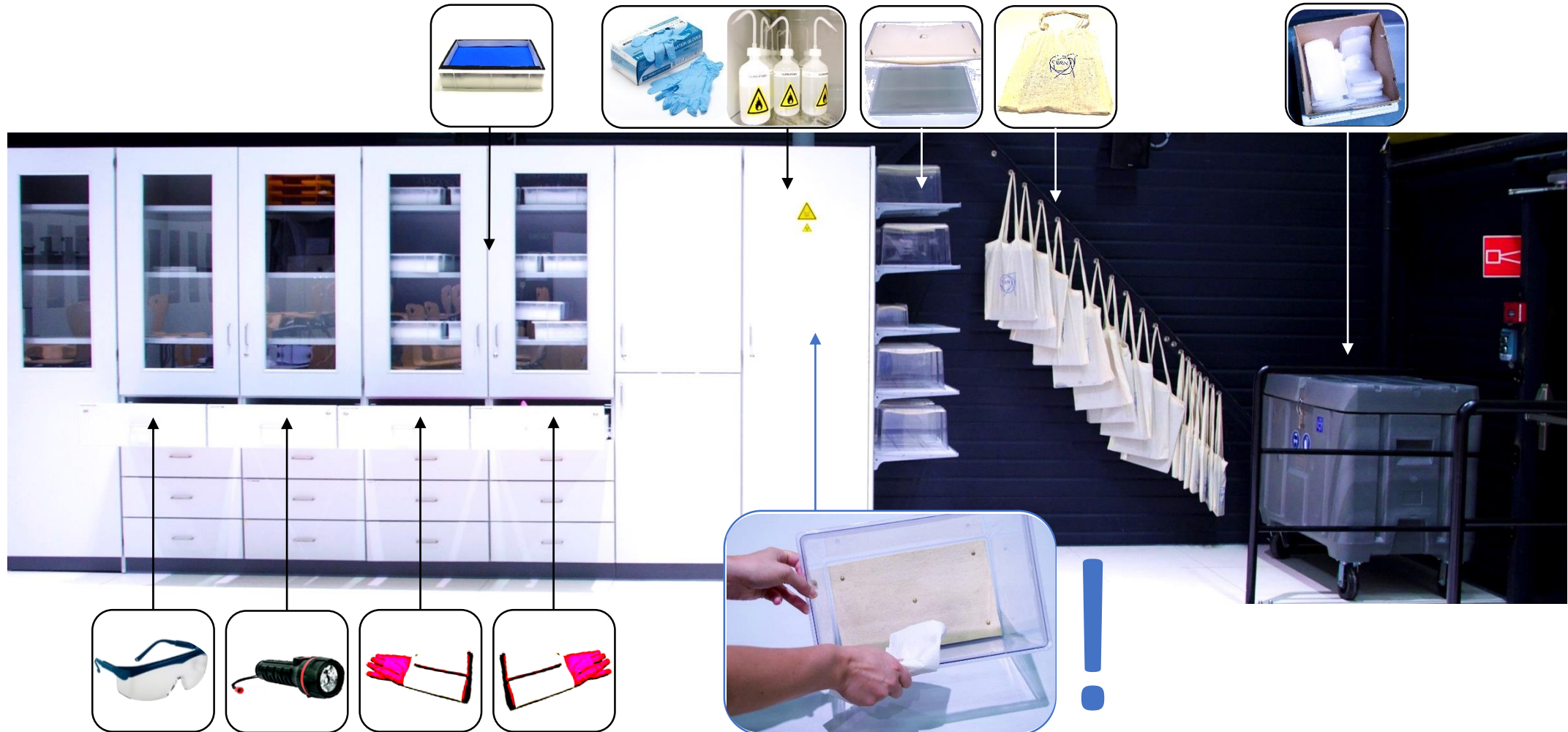

Discussion and explanations

Whiteboard

Additional Material

Air Shower Simulation

Cosmic Ray Air Shower Pictures

by H.-J. Drescher drescher@th.physik.uni-frankfurt.de.

Air showers are cascades of secondary particles induced in the atmosphere by high energy cosmic rays. What you see here is a **visualisation of realistic simulations of these showers**. Of course, not all of the particles in a shower are displayed, there are far too many! The **fraction displayed here is about $1e-6$** , sampled with a **thinning algorithm**.

blue:electrons/positrons

cyan:photons

red:neutrons

orange: protons

gray: mesons

green:muons

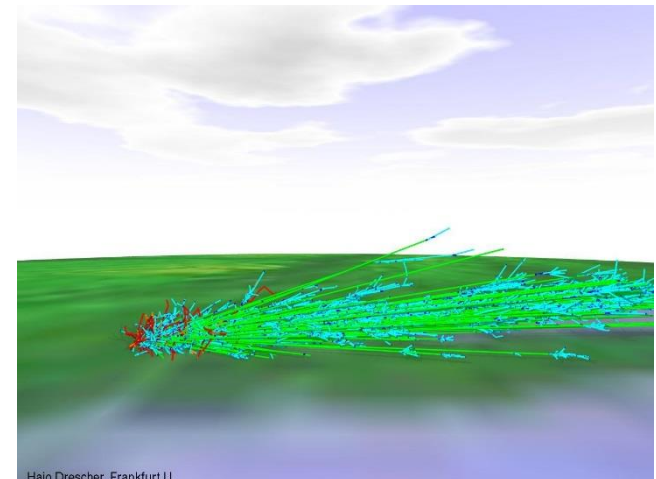

<http://th.physik.uni-frankfurt.de/~drescher/CASSIM/>

blue:electrons/positrons

cyan:photons

red:neutrons

orange: protons

gray: mesons

green:muons

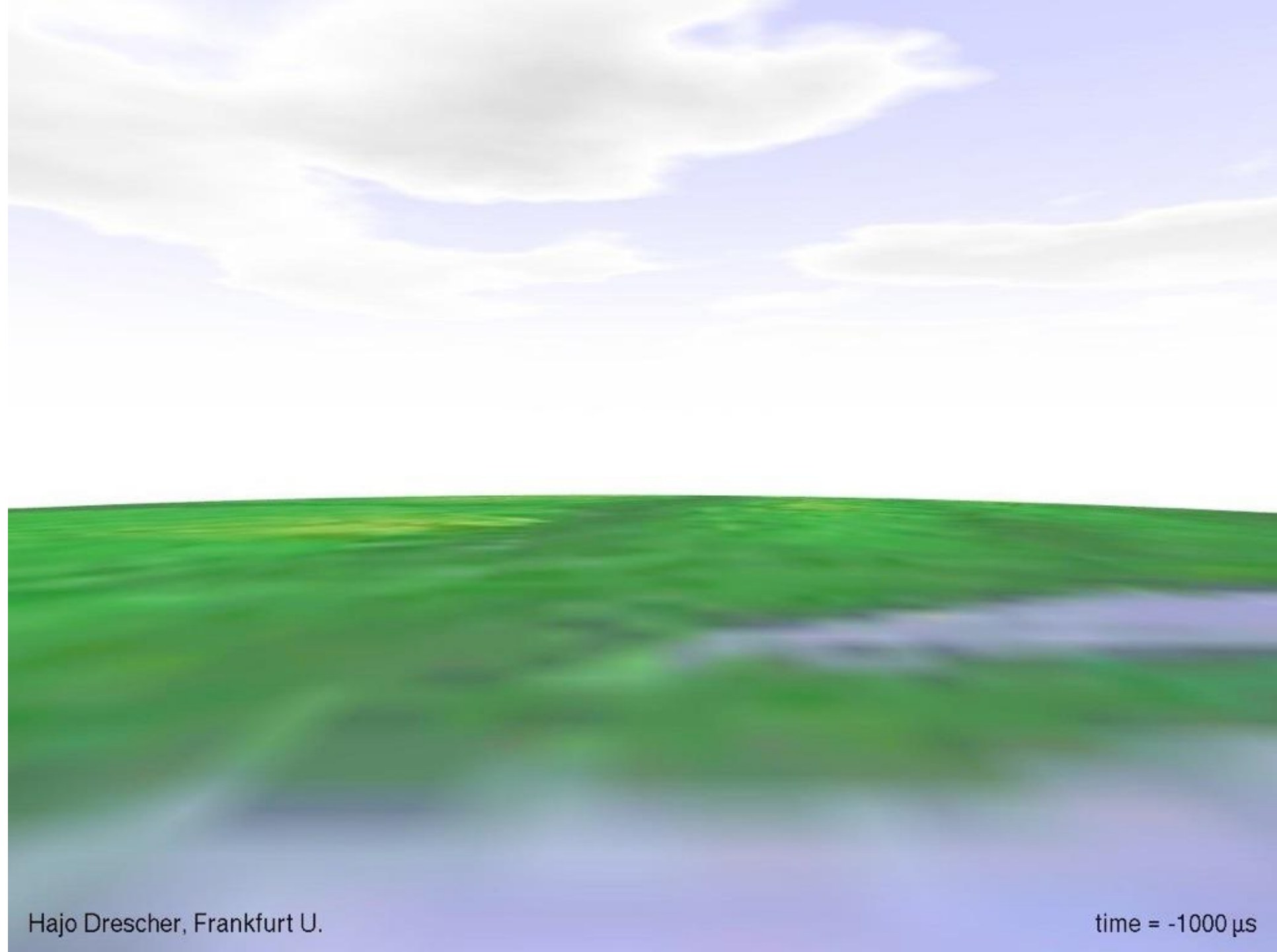

blue:electrons/positrons

cyan:photons

red:neutrons

orange: protons

gray: mesons

green:muons

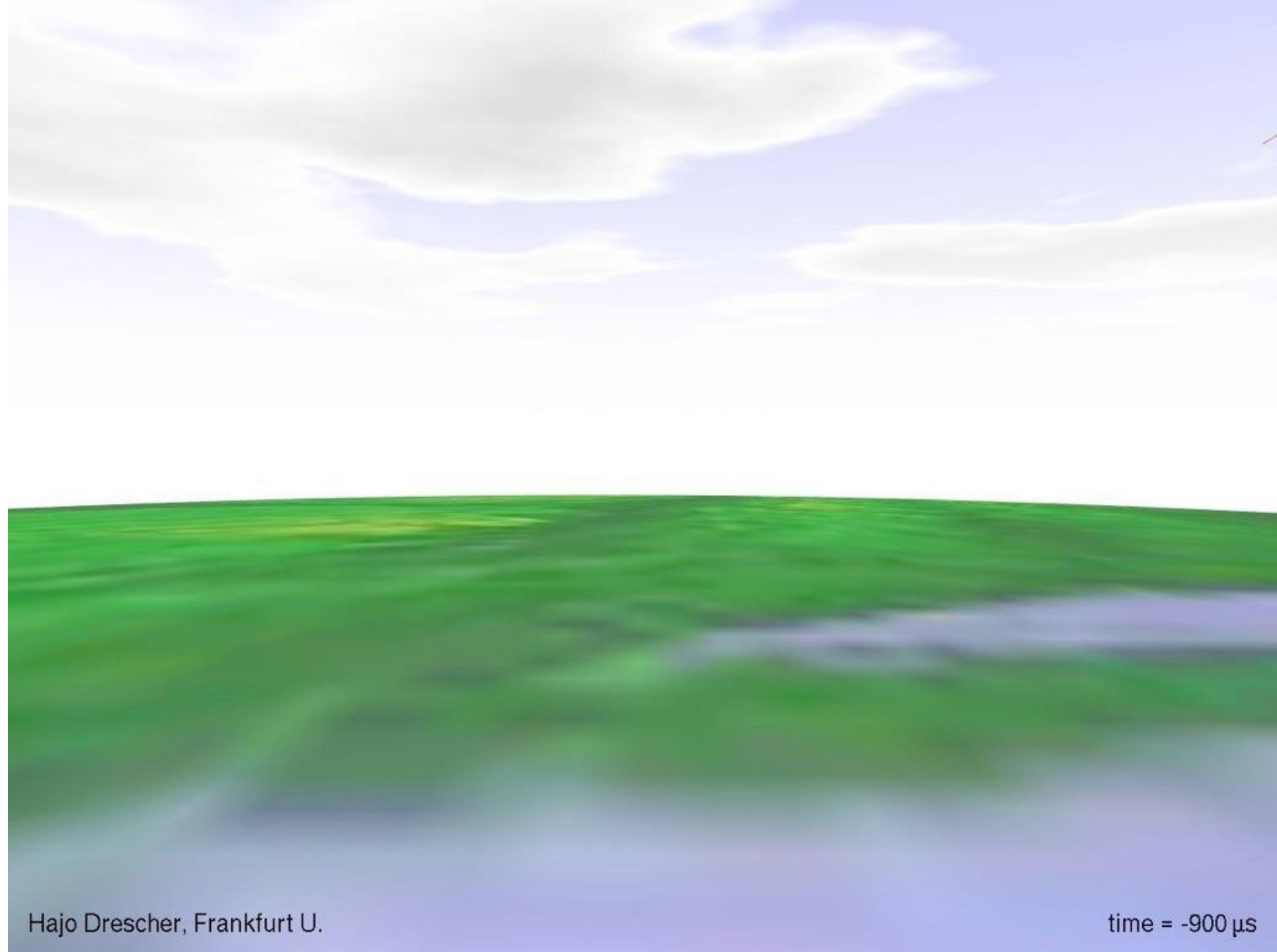

blue:electrons/positrons

cyan:photons

red:neutrons

orange: protons

gray: mesons

green:muons

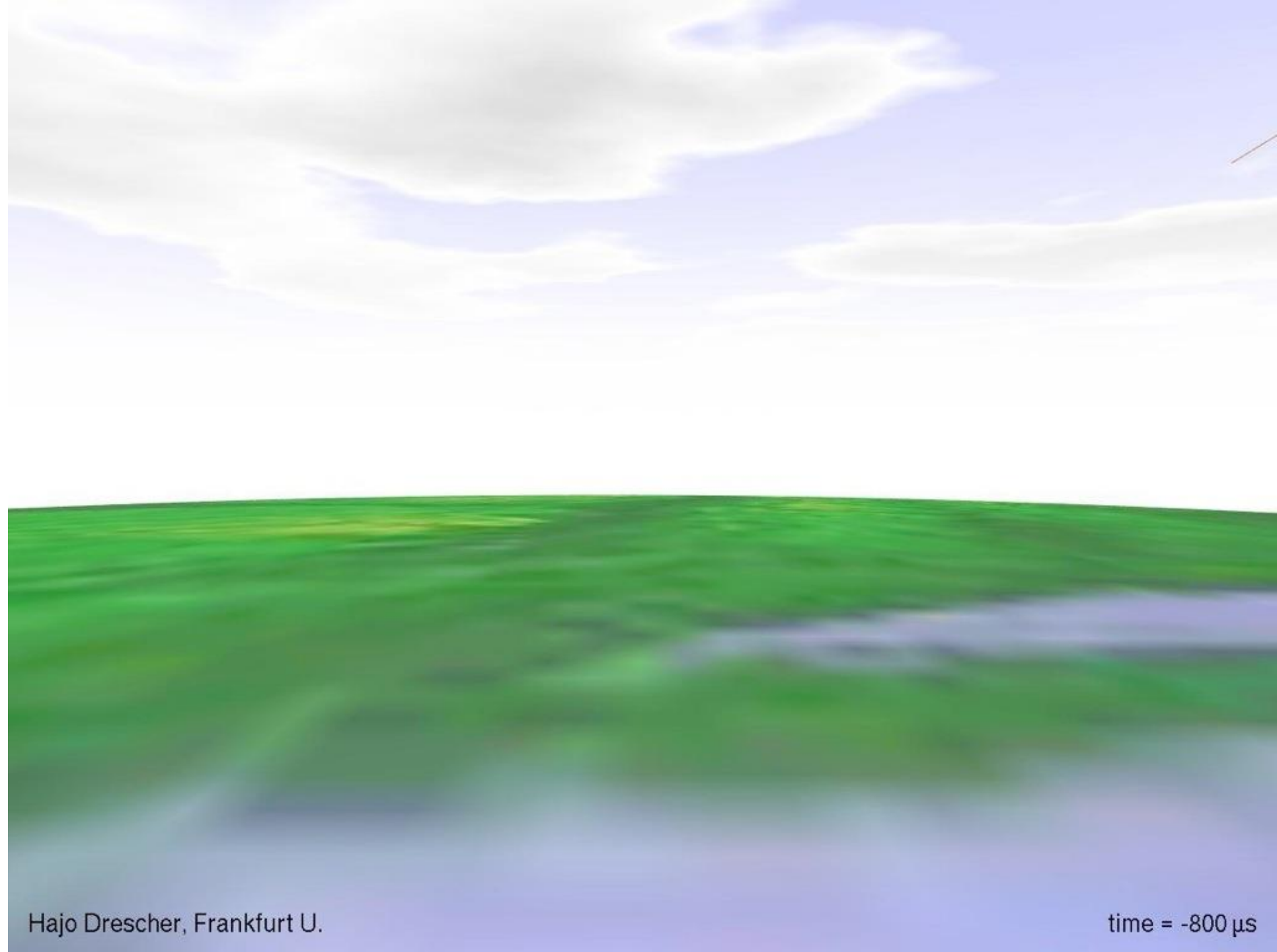

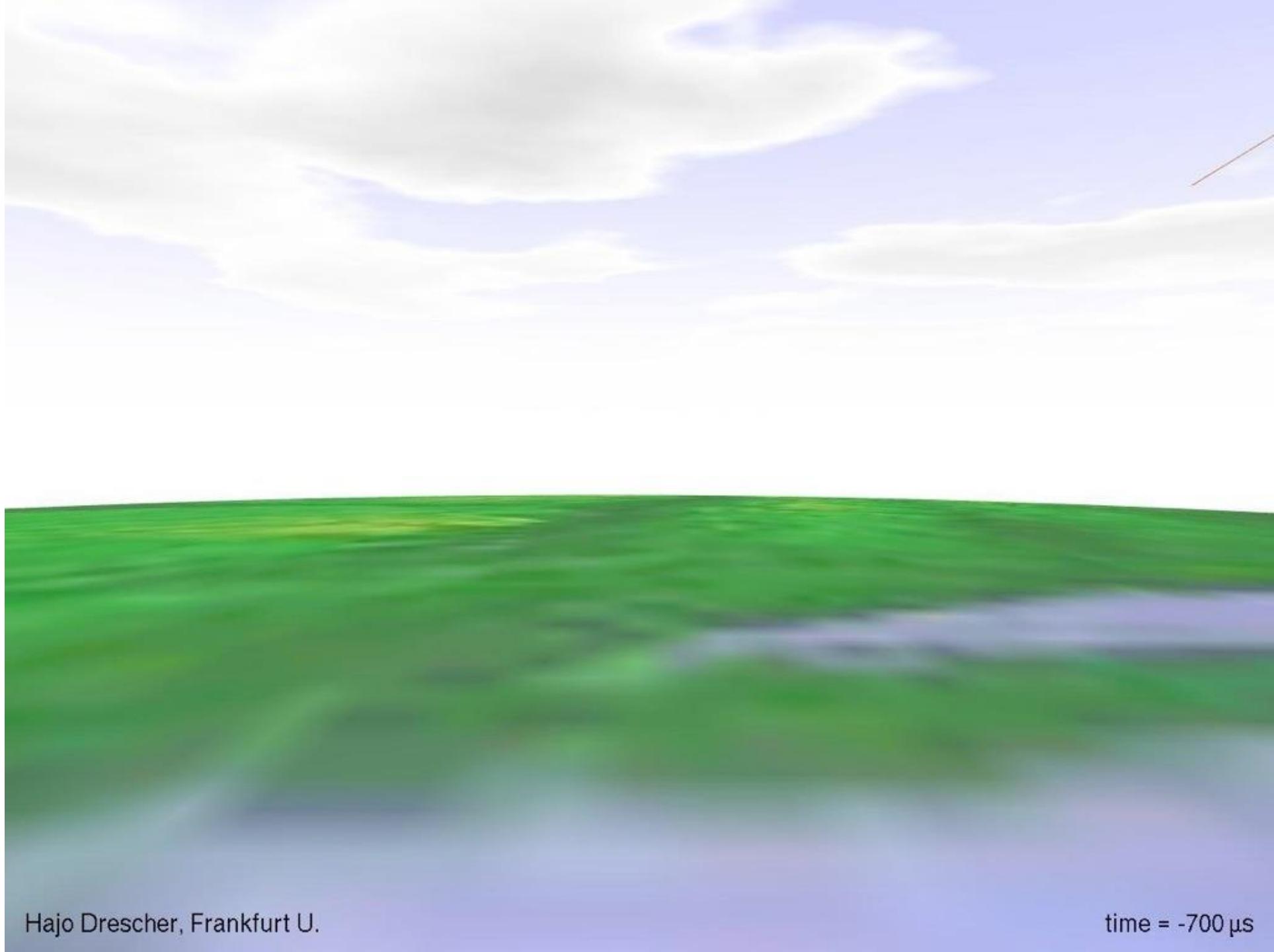

blue:electrons/positrons

cyan:photons

red:neutrons

orange: protons

gray: mesons

green:muons

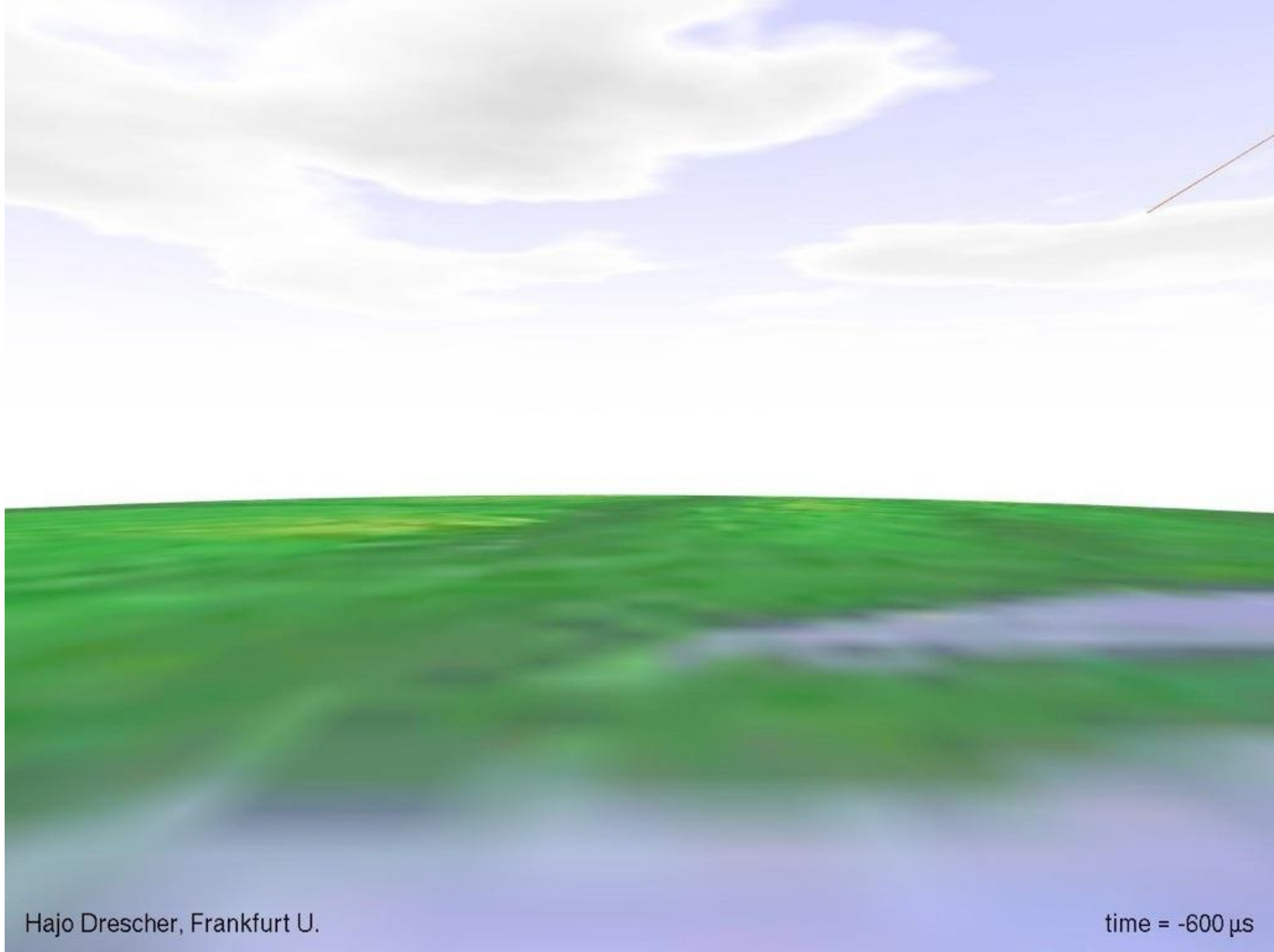

blue:electrons/positrons

cyan:photons

red:neutrons

orange: protons

gray: mesons

green:muons

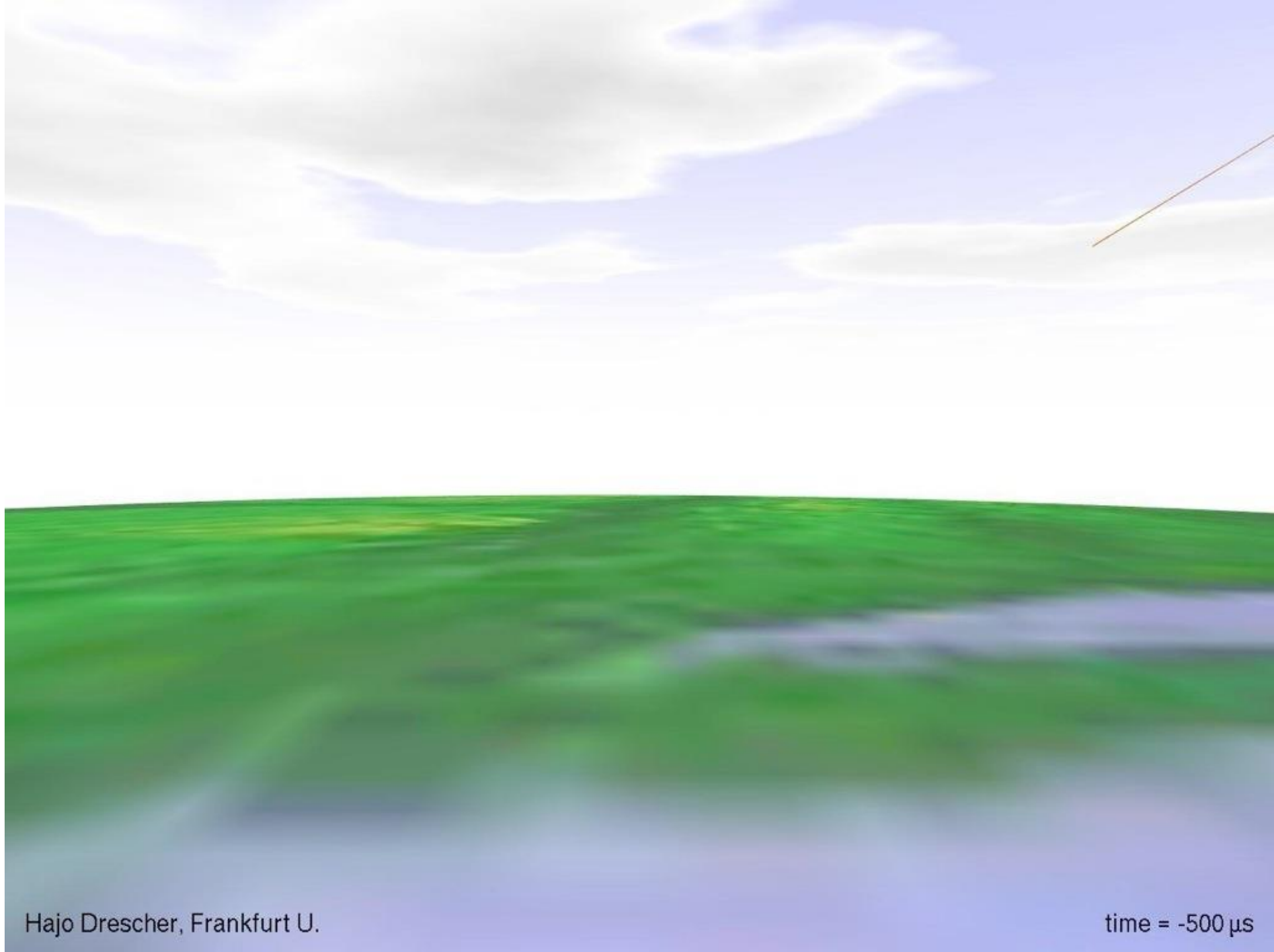

blue:electrons/positrons

cyan:photons

red:neutrons

orange: protons

gray: mesons

green:muons

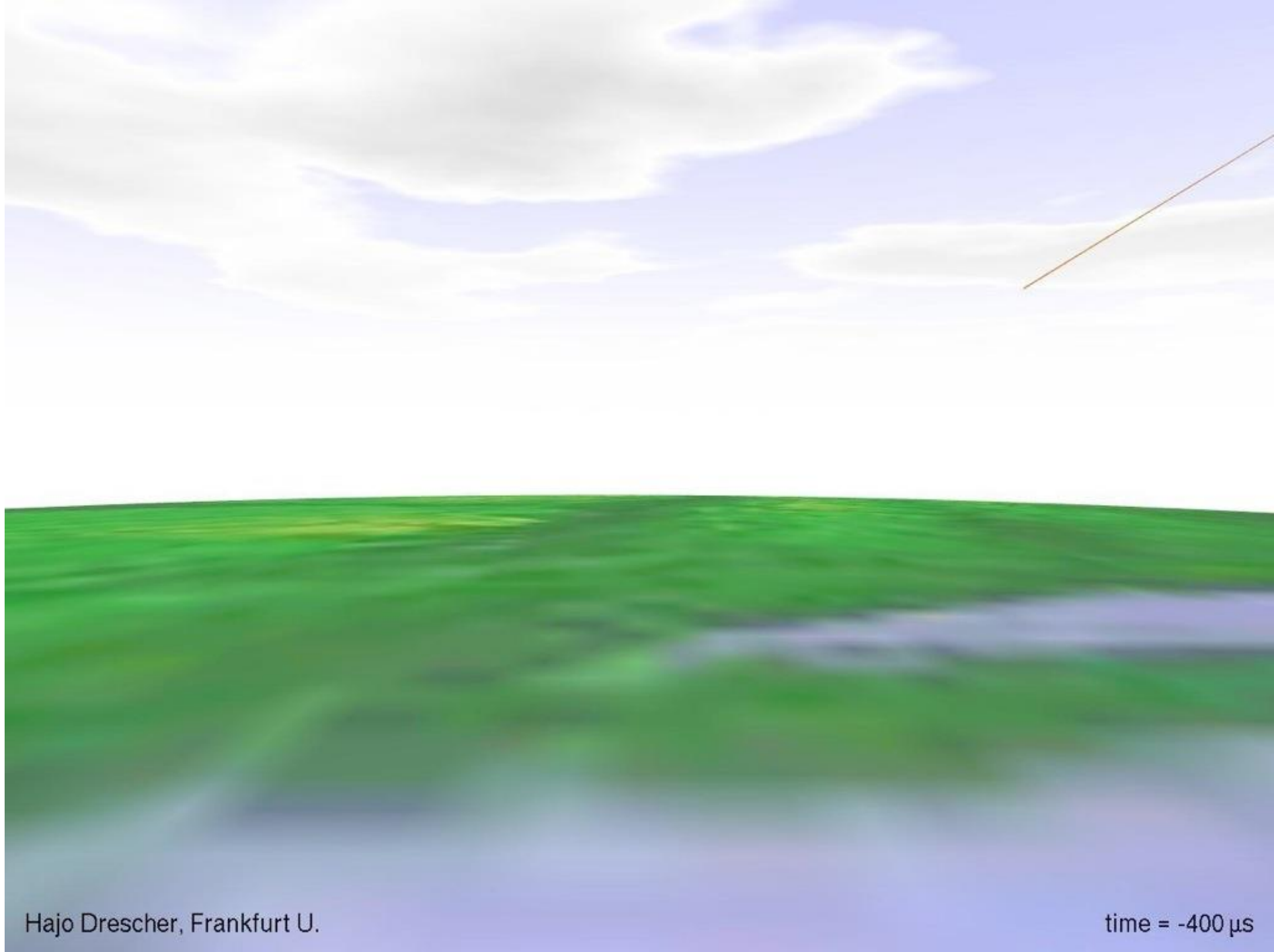

blue:electrons/positrons

cyan:photons

red:neutrons

orange: protons

gray: mesons

green:muons



blue:electrons/positrons

cyan:photons

red:neutrons

orange: protons

gray: mesons

green:muons

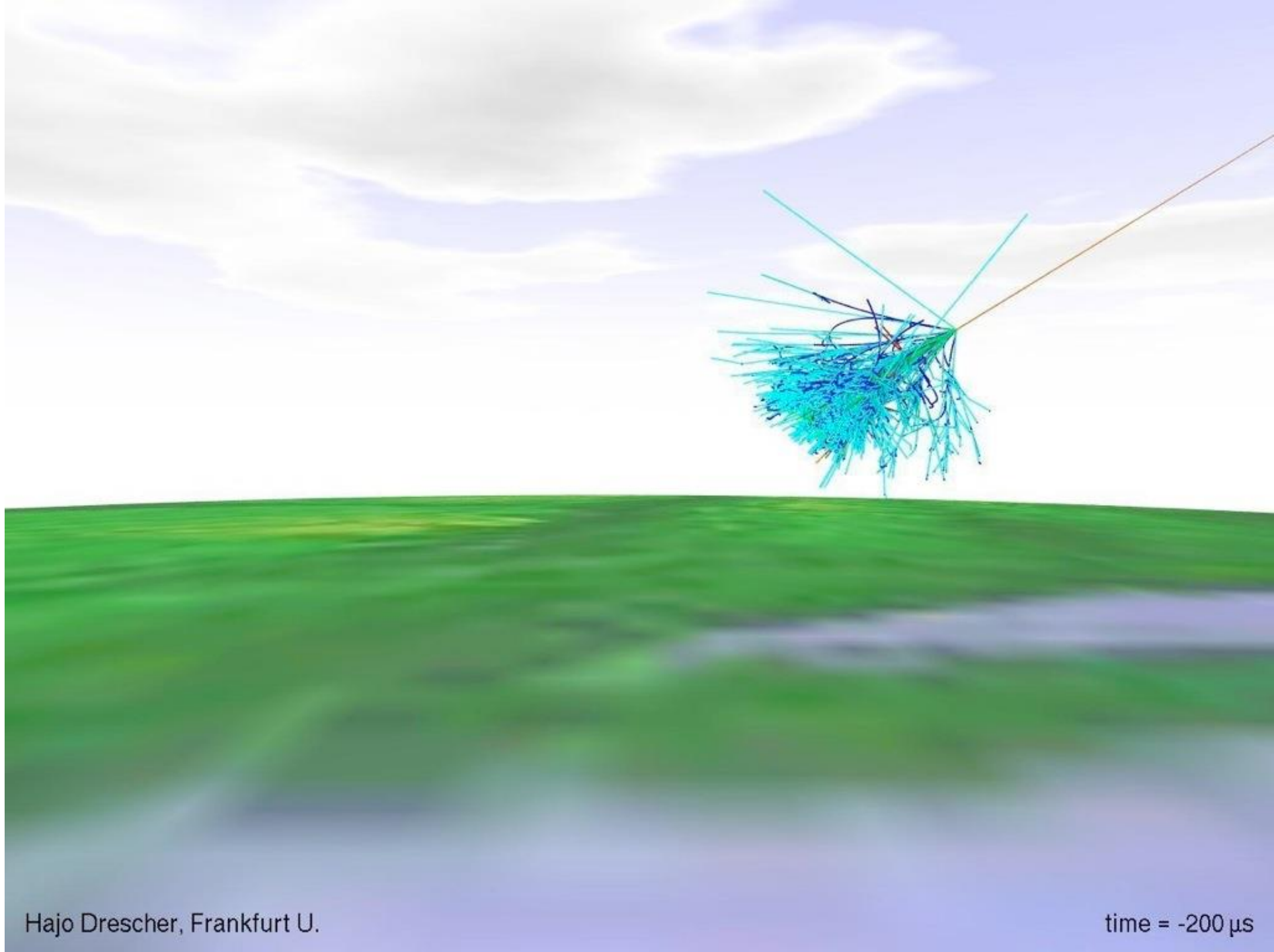

blue:electrons/positrons

cyan:photons

red:neutrons

orange: protons

gray: mesons

green:muons

blue:electrons/positrons
cyan:photons
red:neutrons
orange: protons
gray: mesons
green:muons

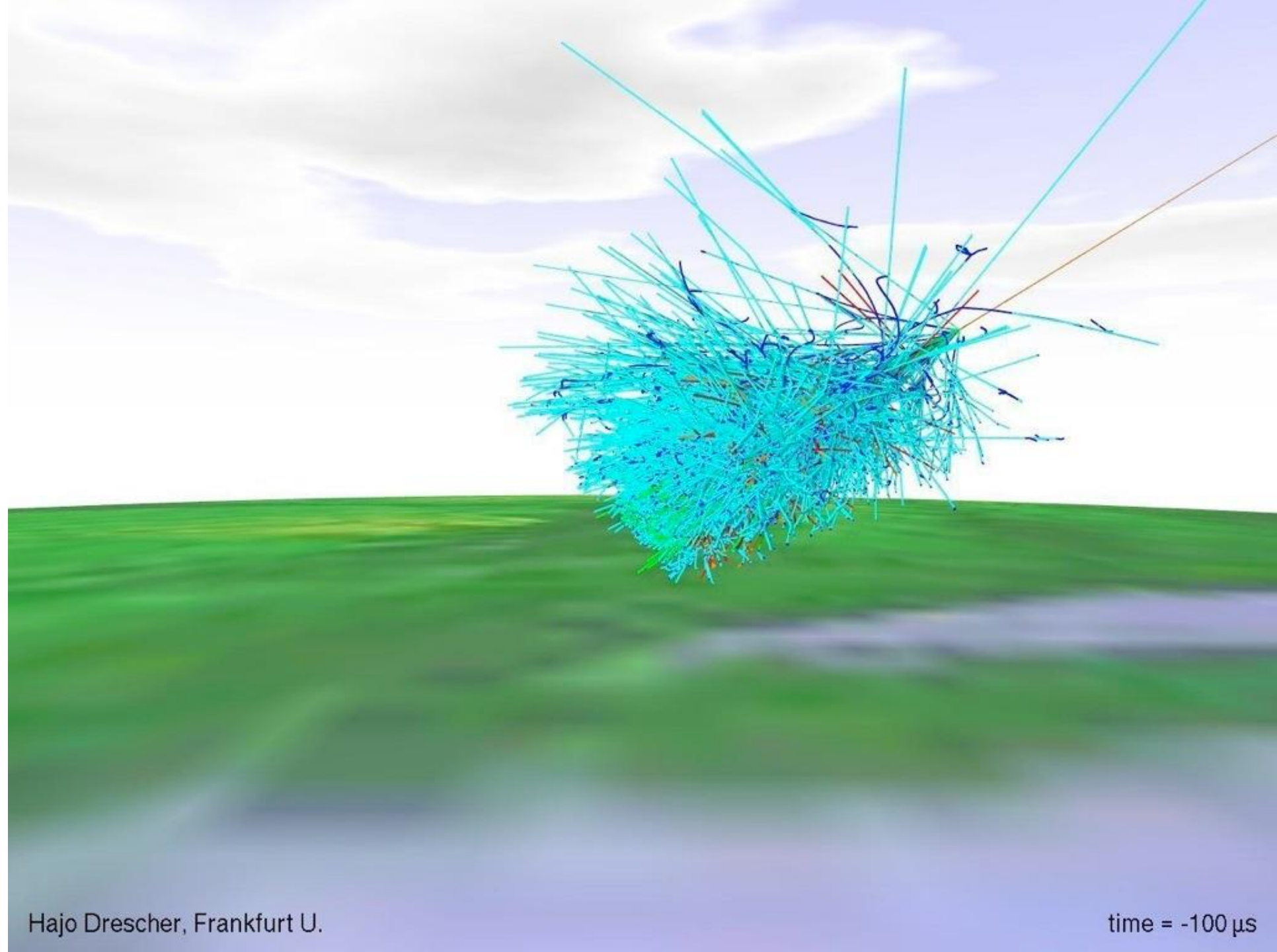

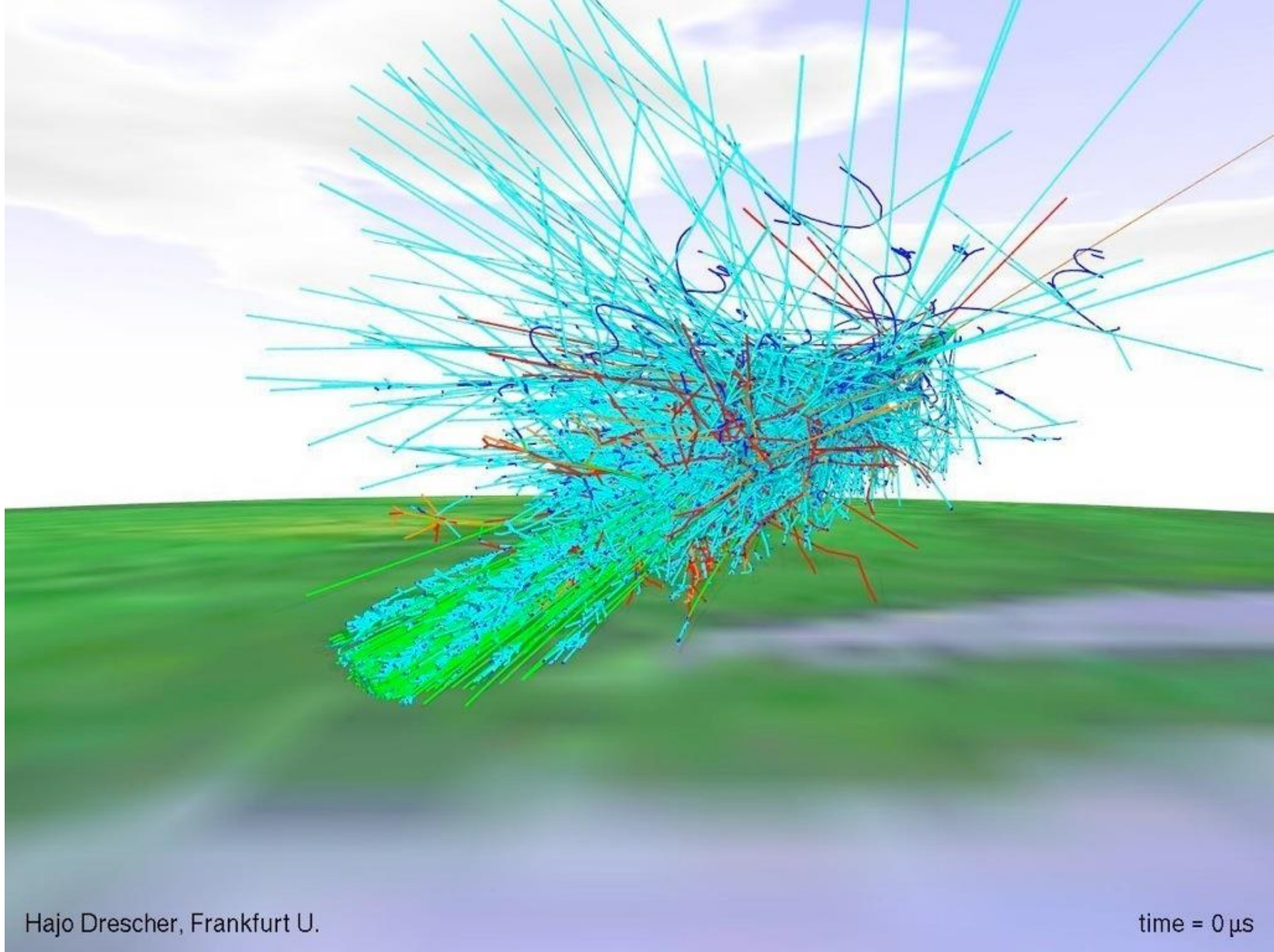

blue:electrons/positrons

cyan:photons

red:neutrons

orange: protons

gray: mesons

green:muons

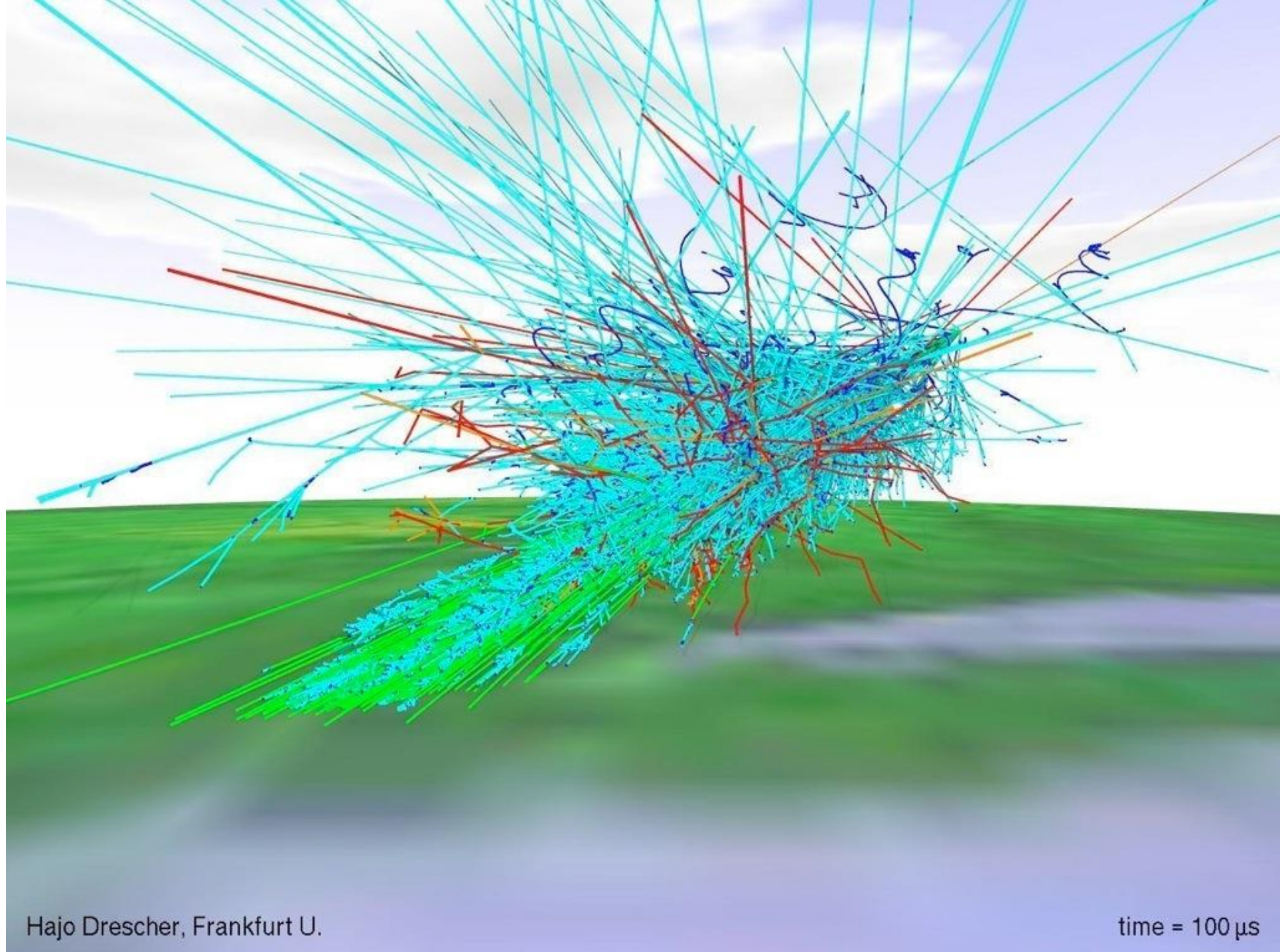

blue:electrons/positrons

cyan:photons

red:neutrons

orange: protons

gray: mesons

green:muons

Hajo Drescher, Frankfurt U.

time = 100 μ s

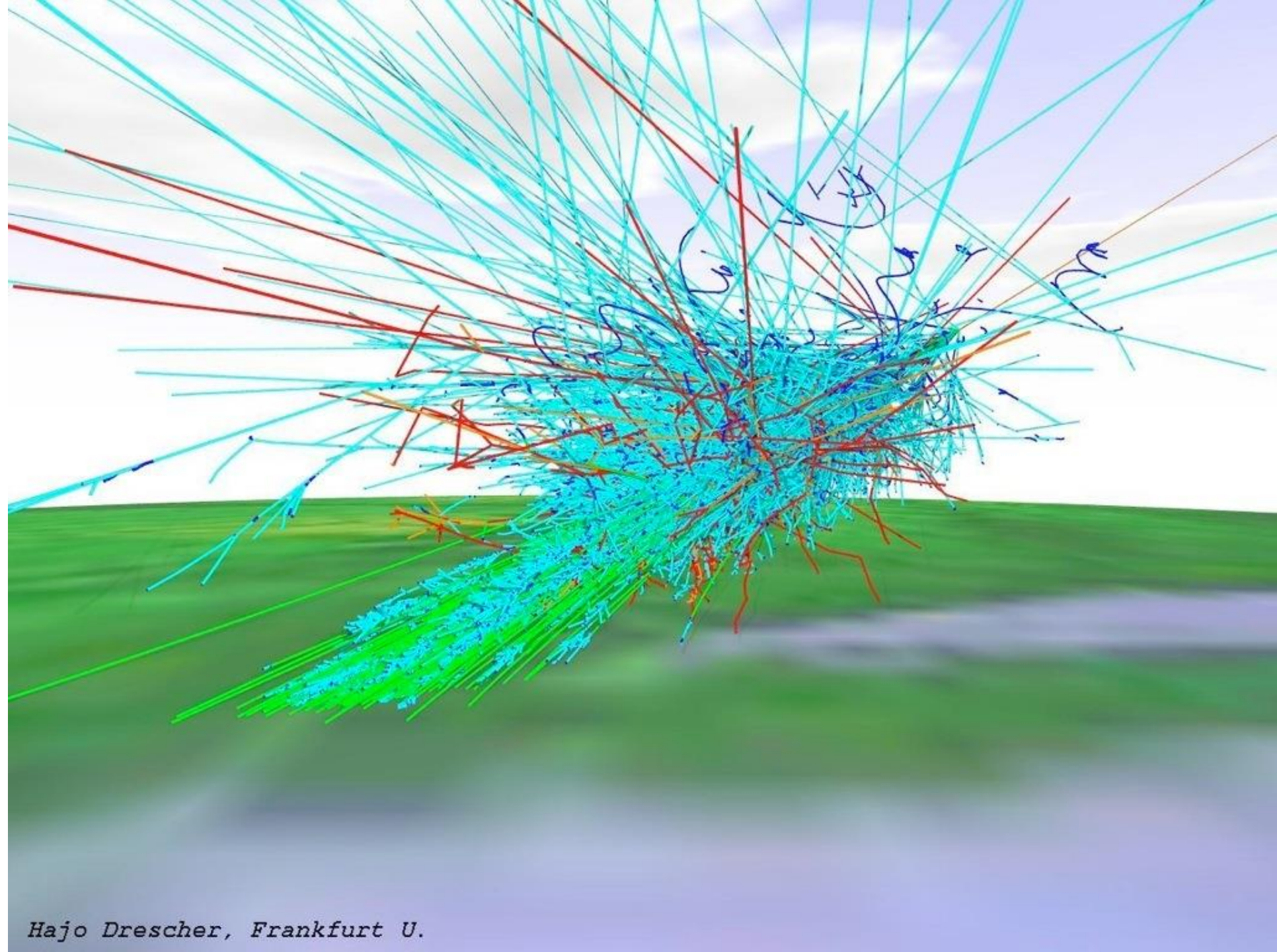

blue:electrons/positrons

cyan:photons

red:neutrons

orange: protons

gray: mesons

green:muons

Hajo Drescher, Frankfurt U.

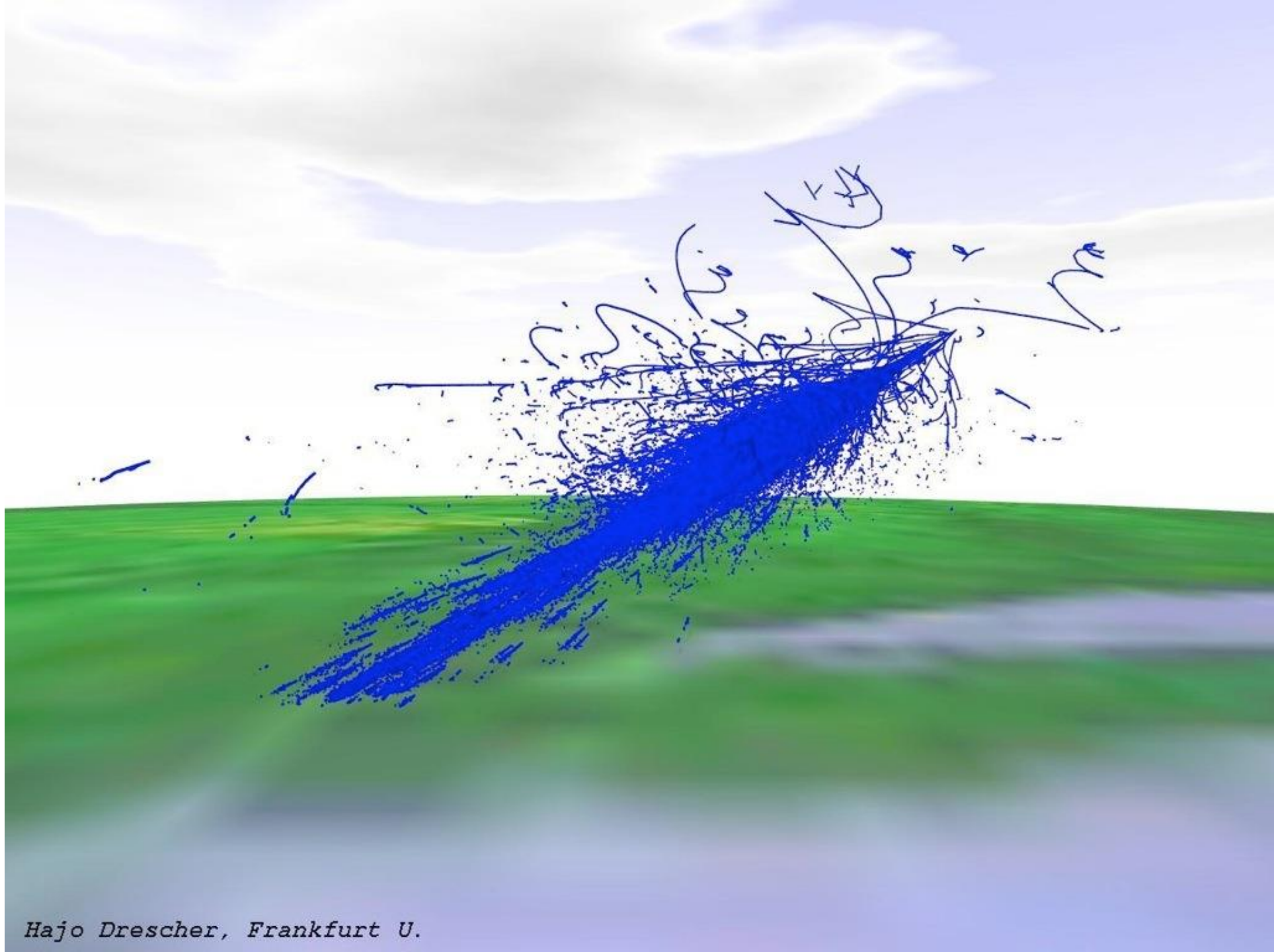

blue:electrons/positrons

cyan:photons

red:neutrons

orange: protons

gray: mesons

green:muons

Hajo Drescher, Frankfurt U.

blue:electrons/positrons
cyan:photons
red:neutrons
orange: protons
gray: mesons
green:muons

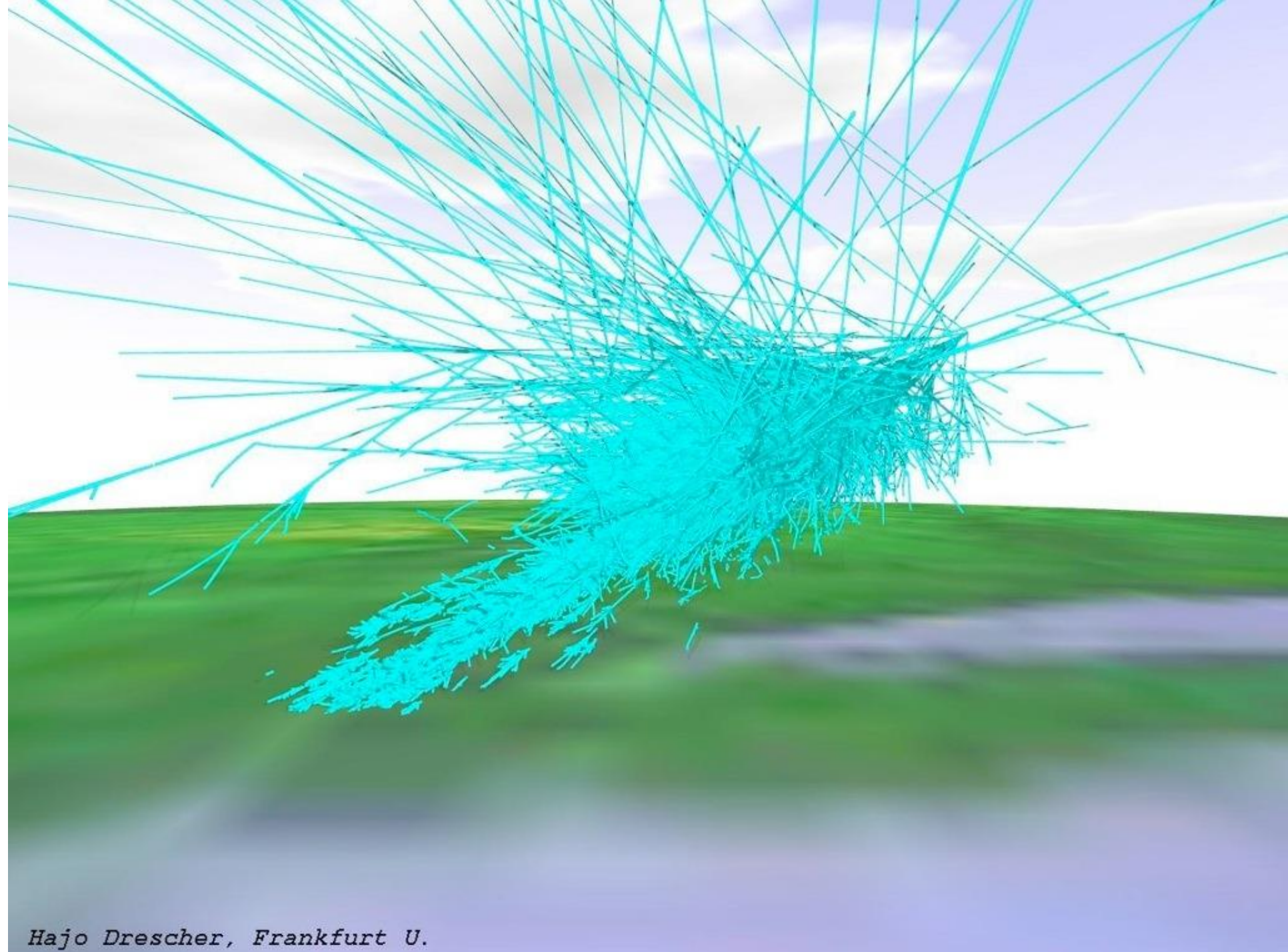

Hajo Drescher, Frankfurt U.

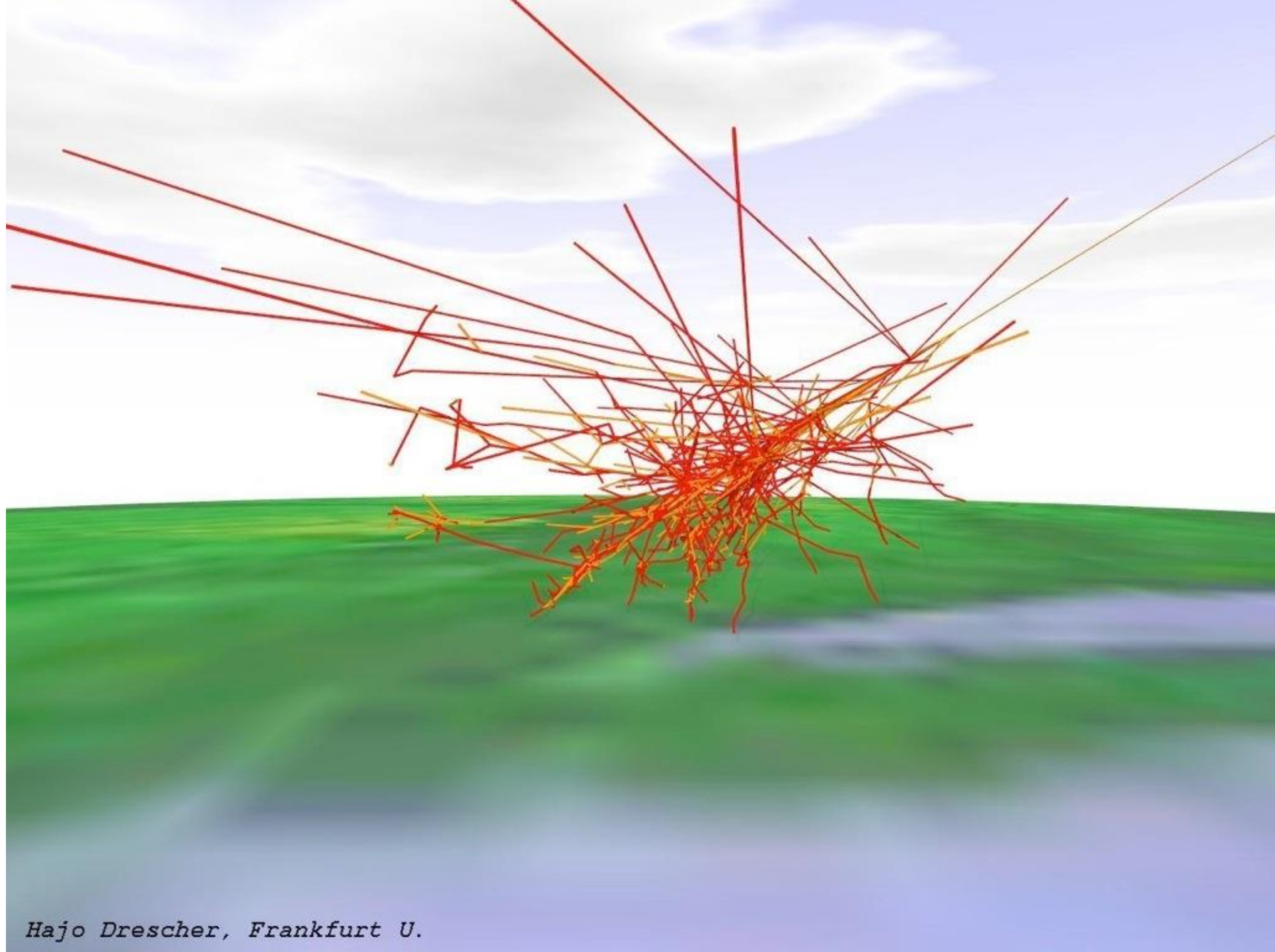

blue:electrons/positrons

cyan:photons

red:neutrons

orange: protons

gray: mesons

green:muons

Hajo Drescher, Frankfurt U.

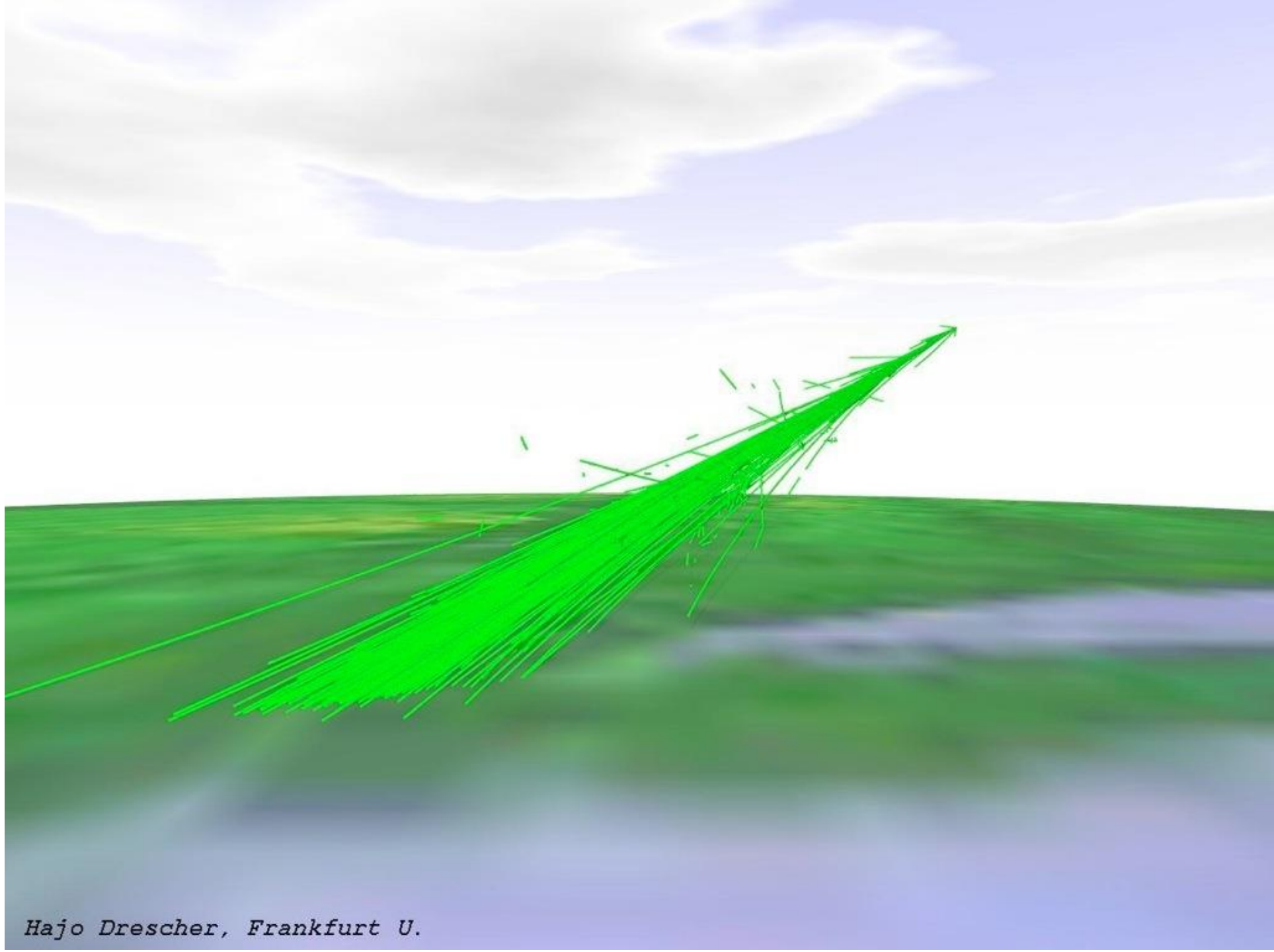

blue:electrons/positrons

cyan:photons

red:neutrons

orange: protons

gray: mesons

green:muons