

MULTI-PARTICLE EFFECTS IN PARTICLE ACCELERATORS (II)

A. Hofmann and G. Rumolo

Thanks to: D. Brandt, W. Herr

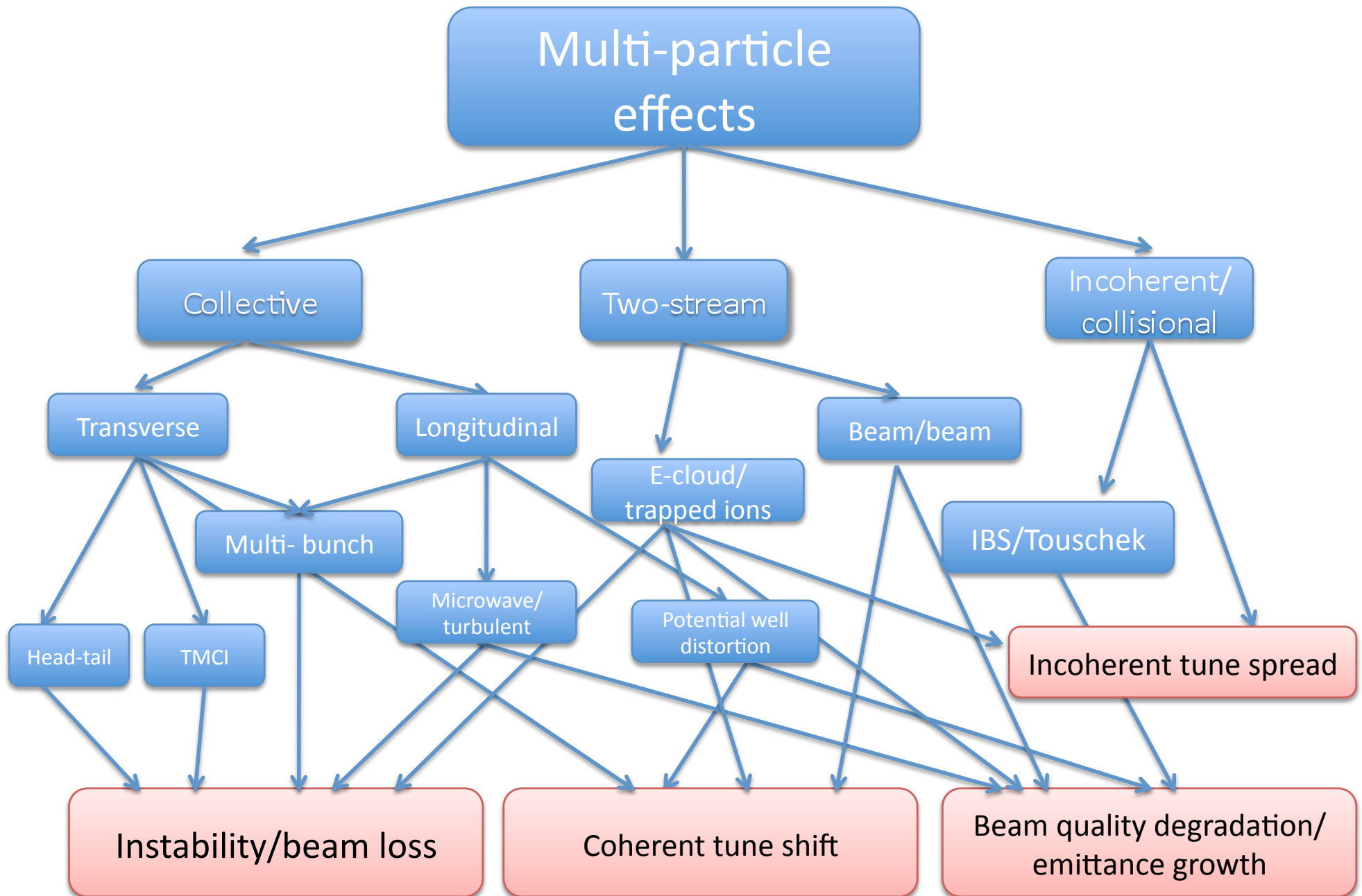

One remark:

⇒ **Cures for coherent effects**

- **Impedance reduction** (i.e. control and budget specification in the design phase, or identify and remove sources for running machines)
- Since these effects are consequence of a resonant response to excitations on the beam natural frequencies, **a spread in these frequencies** in general helps
 - use **nonlinearities** (e.g. sextupoles and octupoles) to increase the transverse detuning with amplitude against transverse instabilities
 - use **higher harmonic number rf-systems** to enhance the spread in the synchrotron frequencies against longitudinal instabilities
- **Increase the longitudinal emittance** (if possible), because the high density (in phase space) beams are more unstable
 - this helps against both longitudinal and transverse instabilities
- Use **active feedback** (also called damper)
 - ✓ system of pick-up + kicker that detects coherent motion and suppresses it
 - ✓ depending on the type of instability, it may be too demanding in terms of power or band-width. Easier against slow, low-frequency instabilities

⇒ **Two-stream phenomena are generally avoided by fighting the prime cause**

- e.g., improve vacuum, use coated beam pipes with low secondary emission

Contents of this lecture:

⇒ **Numerical simulations for modeling of multi-particle effects**

- the electromagnetic problem
 - definition or calculation of the driving terms (field or particle distributions)
- the beam dynamics problem
 - put the driving terms previously calculated into the tracking of the beam particles and study the effects
 - the simulation technique
- some examples of simulations of single-bunch effects
 - ✓ head-tail instabilities
 - ✓ TMCI
 - ✓ longitudinal effects (bunch lengthening, microwave instability)

⇒ **Examples of observations of coherent effects in existing accelerators and comparisons with simulations**

- tune shift measurements
- instabilities

How do we simulate numerically a multi-particle effect on a particle beam ?
(1st step –**the electromagnetic problem**)

- **Space charge:**

- relies on analytical formulae for ellipsoidal/Gaussian bunches
- uses a Poisson solver to get the beam field

- **Impedance.** A reliable model for the ring impedance is needed

- One part is the resistive wall component from the beam pipe (analytical)

- The other part:

- * It can be given as the sum of the individual contributions given by each accelerator component. These contributions, stored in databases, are previously calculated by means of

- ✓ electromagnetic codes for complex geometries, which can output the field maps of the given device when excited with a pulse
- ✓ analytical formulae for simple geometries (e.g. tapers, steps)
- ✓ bench measurements

- * It is the broad-band approximation of the accelerator

- **Two stream:**

- relies on a numerical model of electron cloud formation/ion accumulation

How do we simulate numerically a multi-particle effect on a particle beam ?
(2nd step – **the beam dynamics problem**)

- **Space charge:**

- ✓ the additional space charge force is included in the single particle tracking by localizing it in some selected kick points along the lattice

- **Impedance.** Once the response of the ring to a pulse excitation is known, it can be used for calculating the corresponding kick on each particle of a bunch

- ✓ single bunch effects have to be studied with full 6D bunches subdivided into longitudinal slices and calculating on each particle the effect of the kicks from the wakes of all preceding slices

- ✓ multi bunch effects can be usually modeled with 4D bunches (x-y), which feel the effect of the wakes of all the preceding bunches

- **Two stream:**

- ✓ electron cloud: beam particles are tracked through the accelerator and interact electromagnetically with an electron cloud lumped at some selected locations (single bunch)

- ✓ ions: usually the ions are generated and tracked together with the beam particles (multi bunch)

The electromagnetic problem: **space charge**

- The problem of the electromagnetic fields of some standard beam distributions in open space has been solved analytically for some cases. For example:
 - ✓ **Ellipsoidal**: R.W. Garnett and T.P. Wangler, 1981
 - ✓ **Gaussian**: M. Bassetti and G.A. Erskine. Closed expression for the electrical field of a two-dimensional Gaussian charge. CERN-ISRTH/80-06, 1980.
 - ✓ Formulae including the beam images for some standard chamber shapes, e.g. rectangular, also exist (see previous lecture by Albert)
- **Poisson solvers** for the general case
 - ✓ their input of the charge density is given by distributing the particles on a grid (usually with the Particle-In-Cell method)
 - ✓ their solution includes the contribution of the images through the use of the appropriate boundary conditions
 - ✓ they can be based on solutions with the finite differences or FFT methods
 - ✓ they can have an adaptive grid and are usually very fast

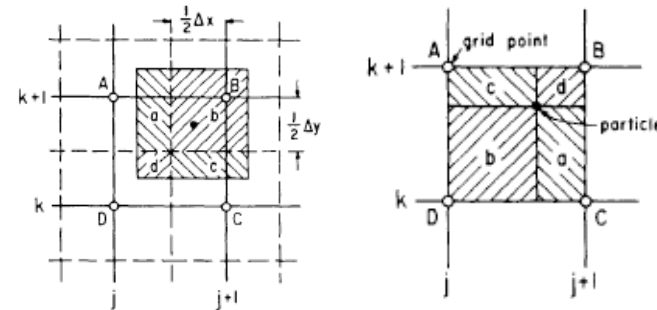

The electromagnetic problem: **impedance (analytical)**

- Wake fields in relatively simple structures may be quite accurately obtained via analytical treatment leading to closed mathematical expressions.
- **Geometric effects** (induced by changes of cross-section, irises, cavities, etc., usually purely inductive impedances)

→ **Tapers** in the inductive and diffractive regime, recently improved model w. r. t. the previous model by Yokoya and Stupakov

- ✓ higher order terms included
- ✓ elliptical cross-section

→ **Surface roughness**

- ✓ correlated and uncorrelated bumps
- ✓ periodically corrugated structures

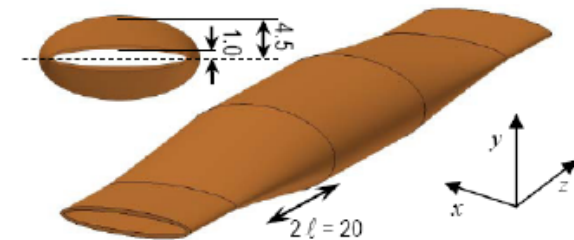

- **Resistive wall effects** (several regimes beyond the classical):

- **long-range** (low frequency, inductive by-pass)
- **short-range** (high frequency, ac conductivity)
- **multi-layer** boundary

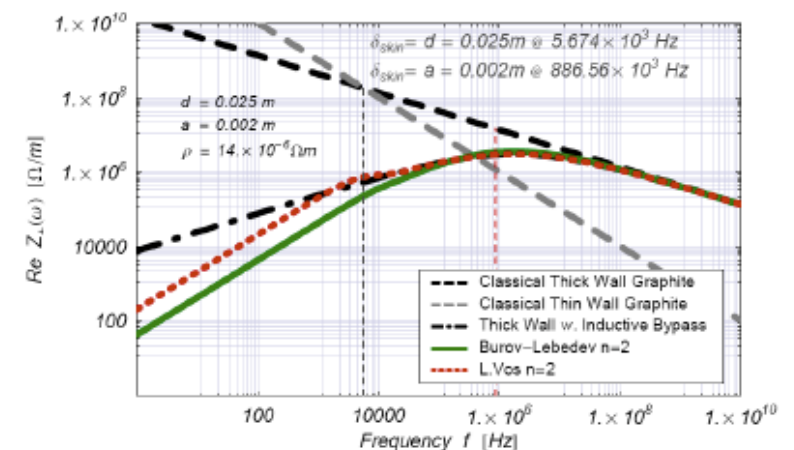

The electromagnetic problem: **impedance (numerical -1)**

- Wake fields in a general structure may be most accurately obtained via **numerical solution of Maxwell's equations**.
- in the '80s the first **2D and 3D codes** were developed to solve numerically the Maxwell equations in given geometries (time or frequency domain)
 - TBCI, MAFIA, ABCI, NOVO, XWAKE,
 - More recently: GdfidL, HFSS, Microwave Studio, Particle Studio
- While newer rings built in the '90s tended to be based on a smooth design of the vacuum chamber such as to minimize geometric wakes from steps and abrupt transitions, they were made with flat/asymmetric chambers and shorter bunches (e.g. Linac based FELs):
 - demand **more powerful computation**
 - smaller mesh (often over a larger volume) & longer integration time
 - larger memory and cpu time
- Many of these codes have been **parallelized** and can run on a cluster of cpu's
 - GdfidL divides the integration space in sub-volumes, to be distributed over different nodes
 - PBCI decomposes the computational volume with a load balancing scheme

The electromagnetic problem: **impedance (numerical -2)**

- Examples:

- Diagnostics equipments. For instance:
 - ✓ Wire scanners
 - ✓ Beam Position Monitors
- Kickers (injection, extraction, Q-measurement, dump)
- Collimators (betatron, energy), spoilers, scrapers
- Interconnectors, bellows

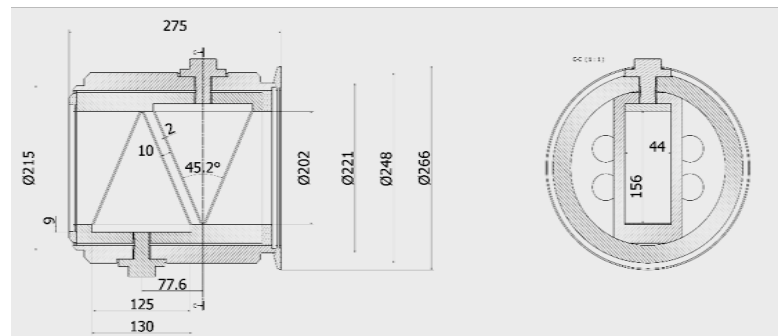
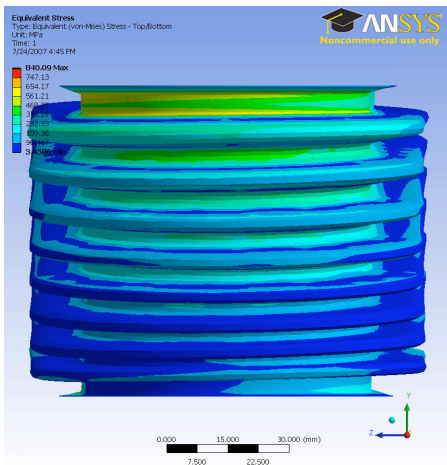

The electromagnetic problem: **impedance (bench)**

- Some devices can be tested in lab and their impedance is estimated from the scattering coefficients obtained with the 1- or 2- wire method. For example:
 - Tubes (shielded, coated, grooved)
 - Collimators (betatron, energy)
 - Kickers



*RF shielded ceramic pipe for RCS
Courtesy YH. Chin, J-PARC*



LHC collimator prototypes in copper and graphite

The electromagnetic problem: **two-stream (electron cloud)**

- To study the effect on the beam, we first need to model the electron cloud formation (EPCLOUD code, F. Zimmermann et al.)

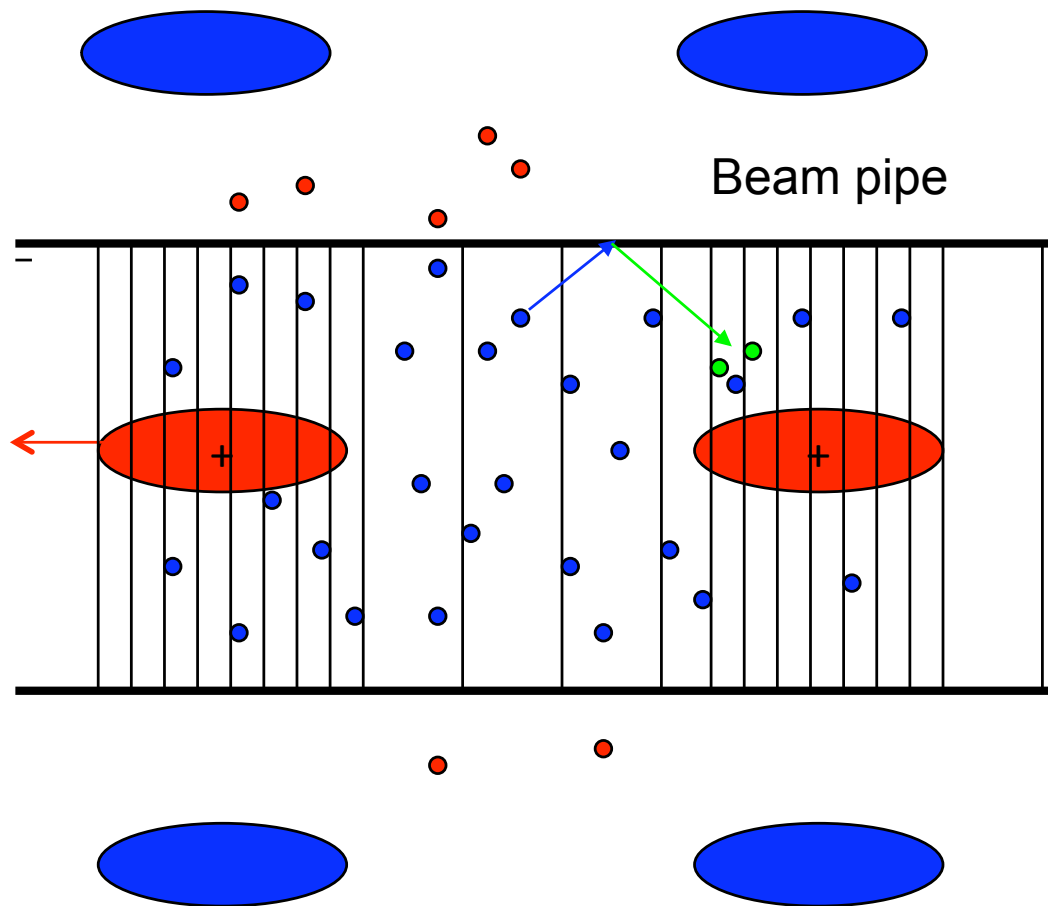

- focus on a **beam** line section (1m for ex.)
- slice bunch and interbunch gaps
- Electrons are **macroparticles**: they are created (photoemission or gas ionization) and accelerated in **beam** and image fields
- if the e- hits the wall create **secondaries** by changing its charge.
- After many bunches, the electrons come to a dynamic „steady“ state

The beam dynamics problem: **The physical model for single bunch**

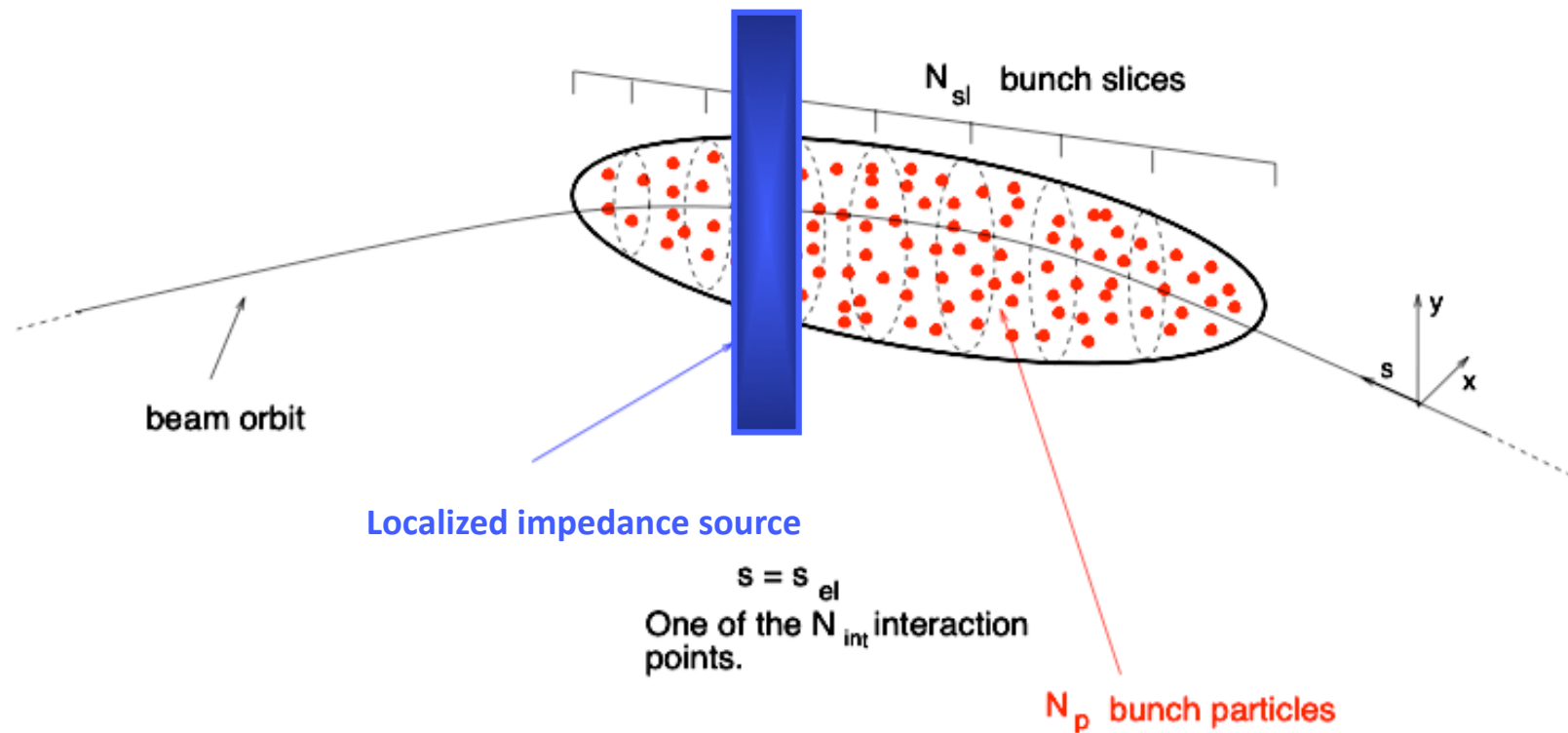

The collective interaction is lumped in one or more points along the ring (**kick points**), where the subsequent slices of a bunch (macroparticles) interact with an impedance (through the wake) or with an electron cloud

The beam dynamics problem: **Numerical implementation (wake fields)**

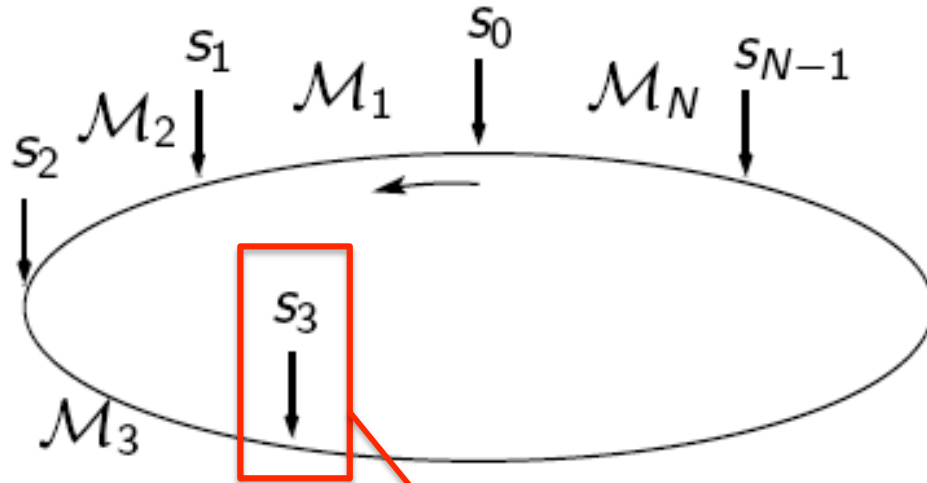

1. Bunch macroparticles are transported across different interaction points through the sector matrices
2. At each interaction point macroparticles in each slice receive the kick from the wakes of the preceding slices
3. Slicing is refreshed at each turn taking into account the longitudinal motion

Longitudinal

$$W_i = W_{||}(i \Delta z)$$

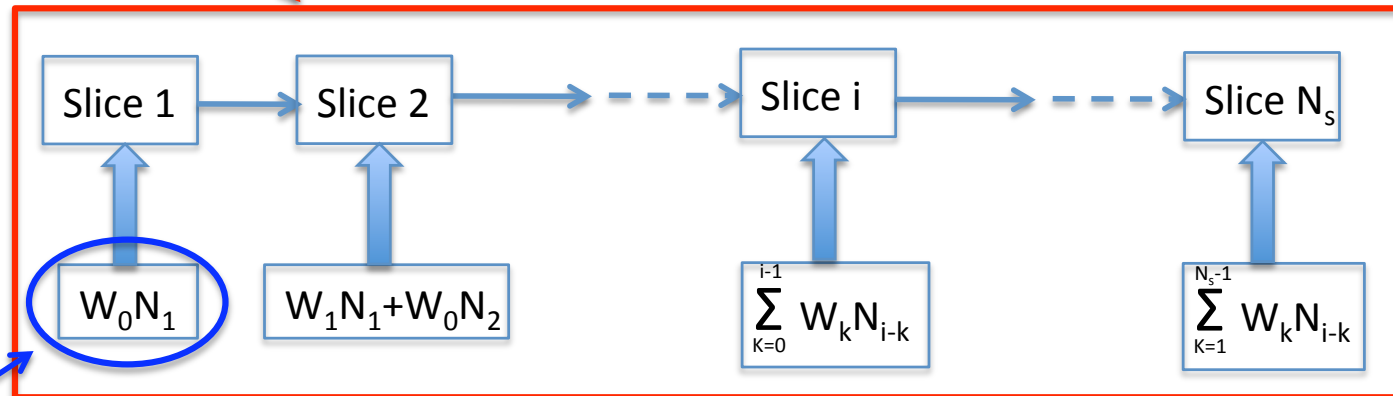

Energy loss

The beam dynamics problem: **Numerical implementation (wake fields)**

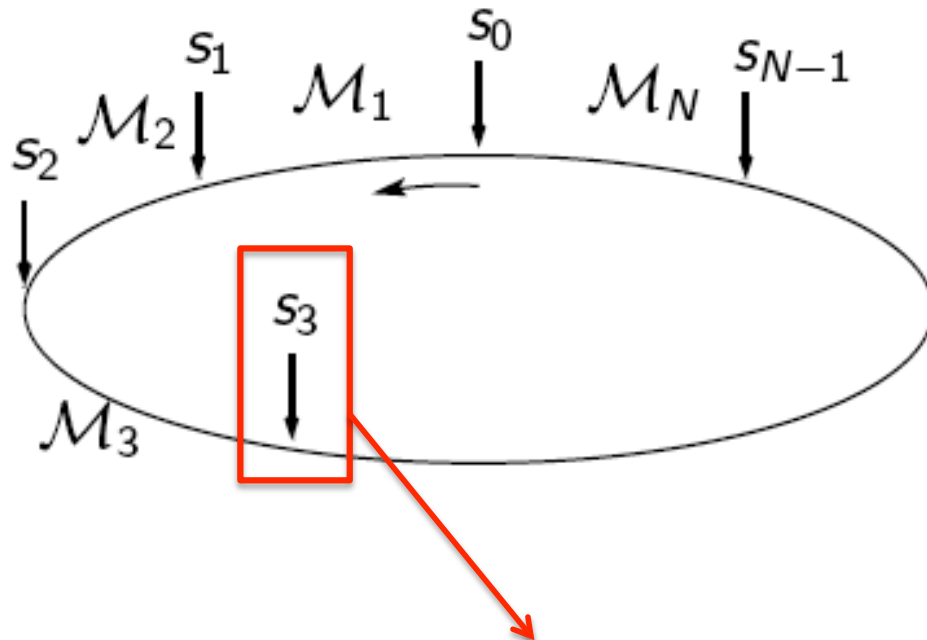

1. Bunch macroparticles are transported across different interaction points through the sector matrices
2. At each interaction point macroparticles in each slice receive the kick from the wakes of the preceding slices
3. Slicing is refreshed at each turn taking into account the longitudinal motion

Transverse (x)
 dipolar:
 $W_{id} = W_{dx}(i \Delta z)$
 quadrupolar:
 $W_{iq} = W_{qx}(i \Delta z)$
 x_i centroid of slice i
 x position of particle

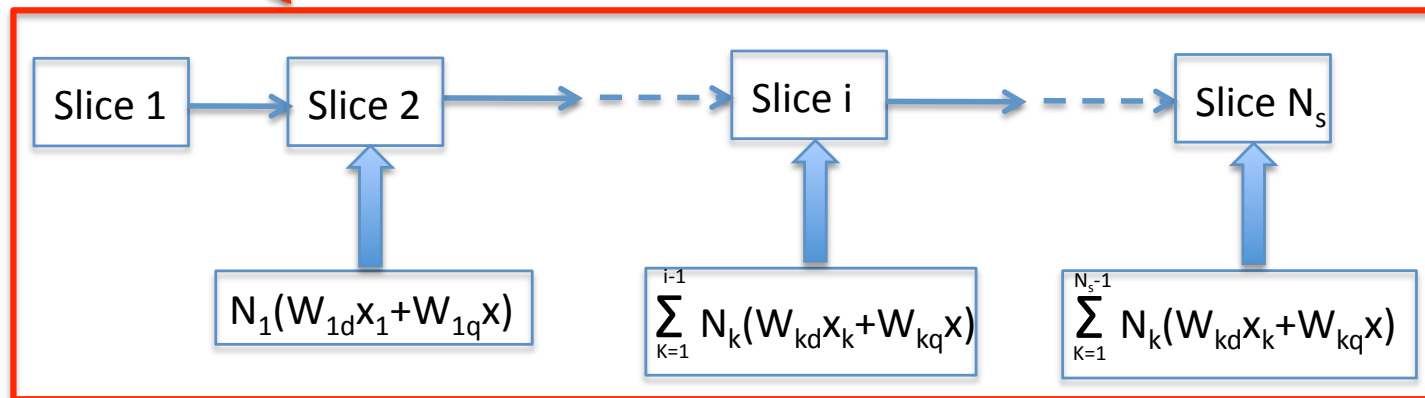

The beam dynamics problem: **Numerical implementation (electron cloud)**

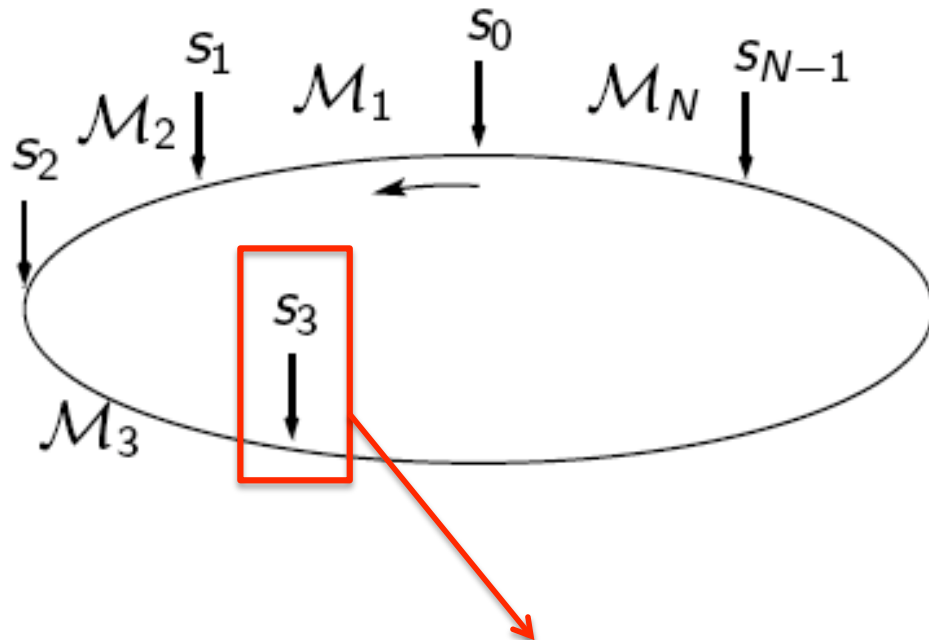

1. Bunch macroparticles are transported across different interaction points through the sector matrices
2. At each interaction point macroparticles in each slice interact with the electron cloud, as it was modified by the interaction with the preceding slices
3. Slicing is updated

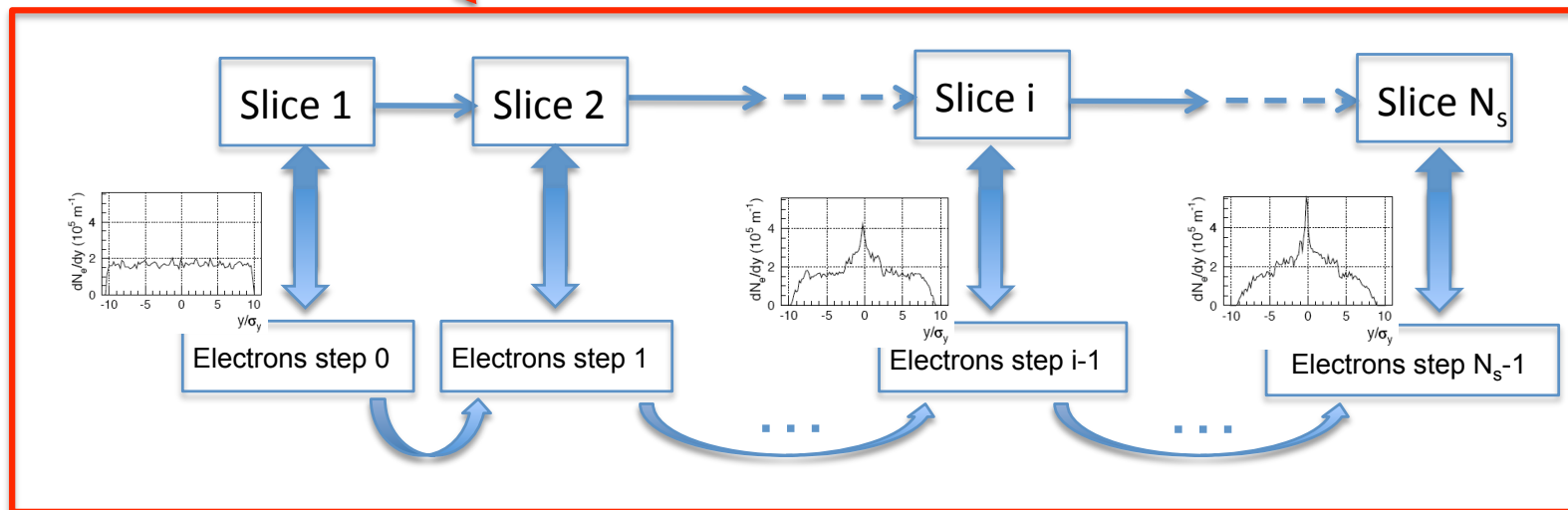

Example of simulation/measurements: **the head-tail instability**

- Due to chromaticity, single bunches develop head-tail modes ($m=1$), which can be strongly unstable at high intensity. The most dangerous mode is the mode $l=0$:
 - It is unstable below transition ($\gamma < \gamma_t$), if the chromaticity is positive ($\xi_{x,y} > 0$)
 - It is unstable above transition ($\gamma > \gamma_t$), if the chromaticity is negative ($\xi_{x,y} < 0$)
- Higher order modes ($l \geq 1$) are unstable for negative chromaticities below transition and for positive chromaticities above transition. However, they are much slower and they can be naturally damped by other sources of tune spread, or can be suppressed with a damper.
- As a consequence, it is critical to control the mode $l=0$ by operating the machine with the correct sign of chromaticity.
 - Machines that **run always below their transition energy** (usually hadron machines) must have **negative chromaticity** (e.g., the CERN-PSB, GSI-SIS) and they can live with their natural chromaticity, which is negative for a classical lattice design. These machines can also avoid to use sextupoles for chromaticity correction
 - Machines that run always **above transition energy** (lepton machines, CERN-LHC, BNL-RHIC with protons) need **chromaticity correction** (and therefore two families of sextupoles) in order to make their chromaticity slightly positive.
 - Machines that **cross transition** (CERN-PS, CERN-SPS, BNL-RHIC with ions) need a scheme of **synchronized swap of the sign of chromaticity** at transition crossing

Example of simulation: **the head-tail instability**

⇒ The fundamental mode of a head-tail instability ($l=0$) can be simulated to have a detailed look at the instability evolution for different chromaticity values (assuming the SPS parameters and a simple broad band model for the impedance)

⇒ Movies show the evolution of the Δ (centroid) signal along the bunch over 1045 turns of unstable evolution for two chromaticity values (-0.4 and -0.9)

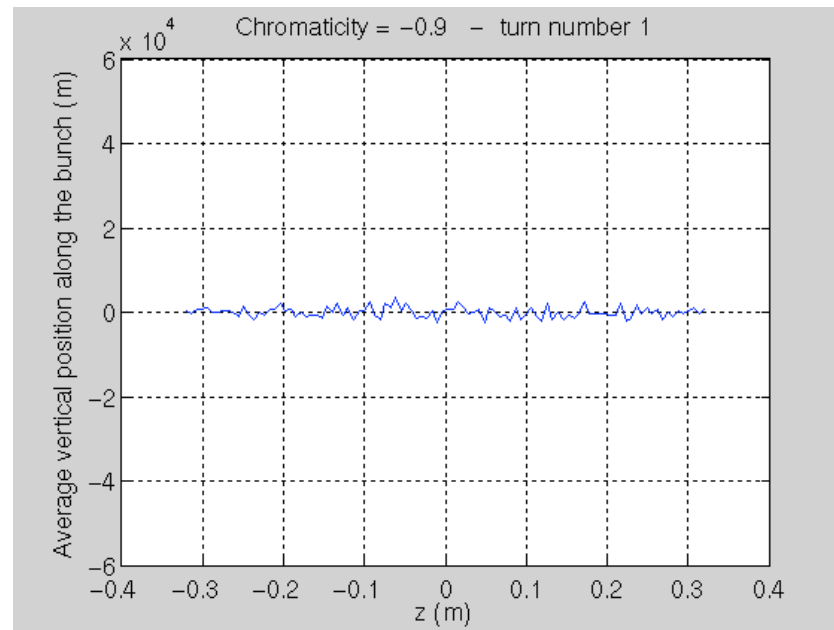
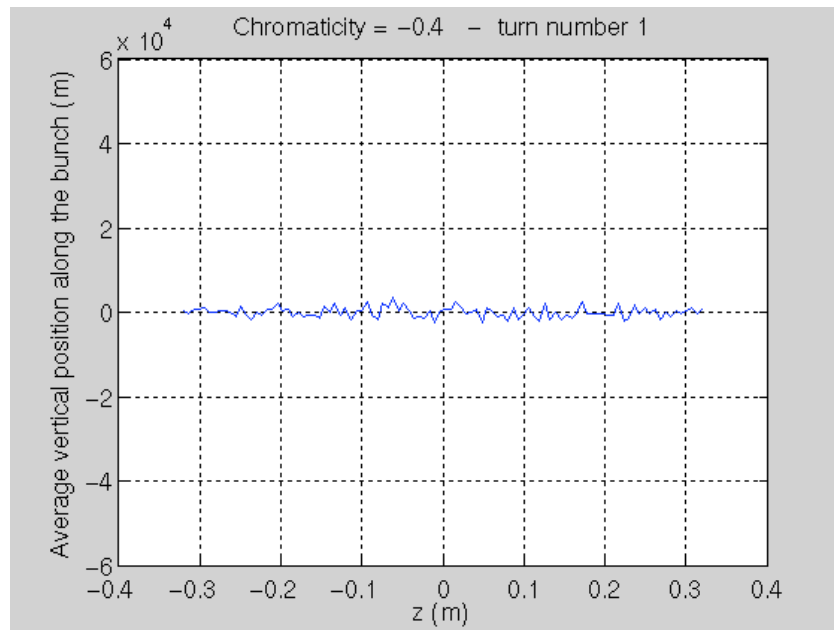

Example of simulation/measurements: **the head-tail instability**

- The fundamental mode of a head-tail instability can be simulated to have a detailed look at the instability evolution for different chromaticity values (assuming the SPS parameters and a simple broad band model for the impedance)
 - ⇒ The comparison between measurement and theory is impressive!
 - ⇒ Plots show three consecutive traces of the centroid signal along the bunch while the instability is growing

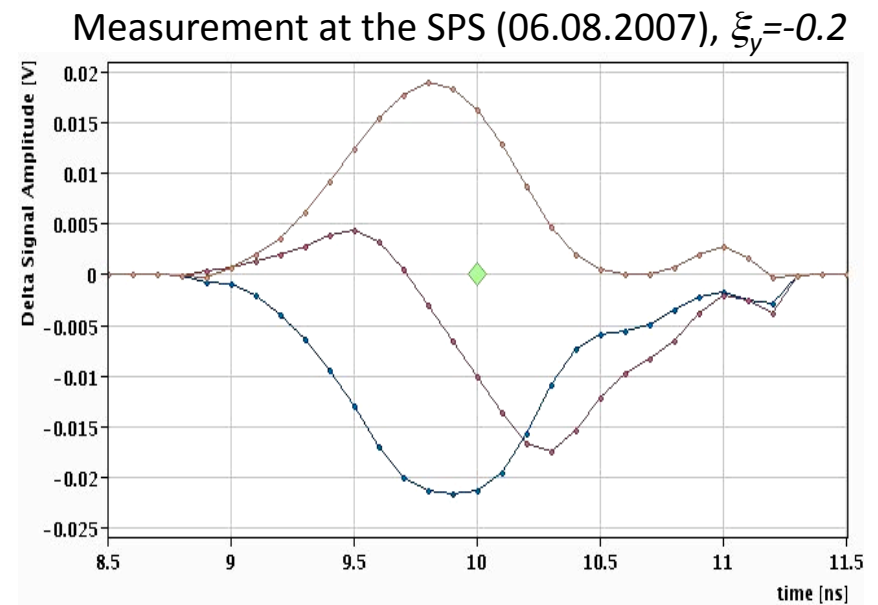
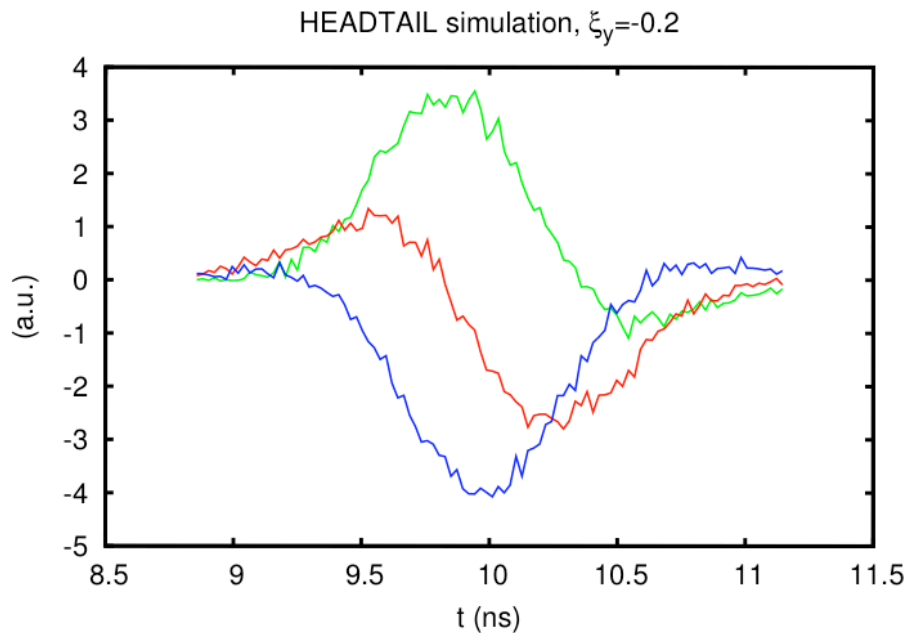

Example of simulation/measurements: **the head-tail instability**

- More benchmark of data and simulations for different values of chromaticity...

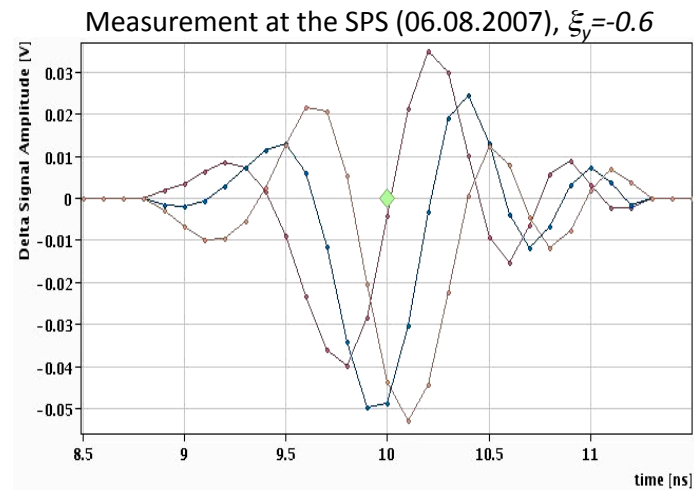
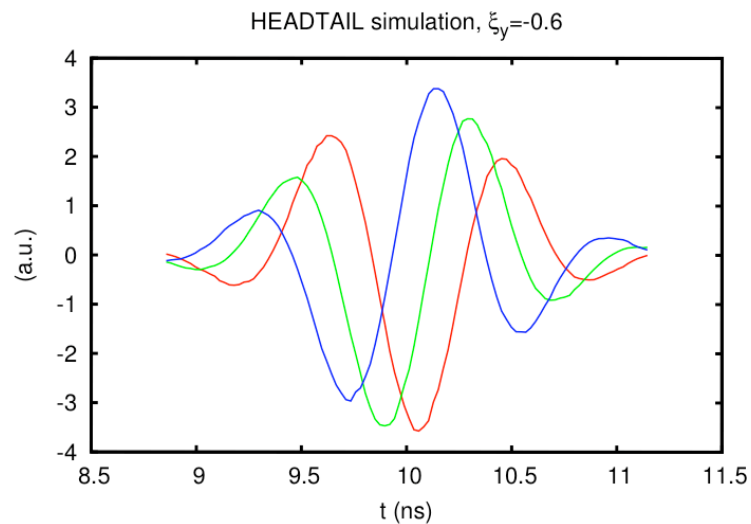
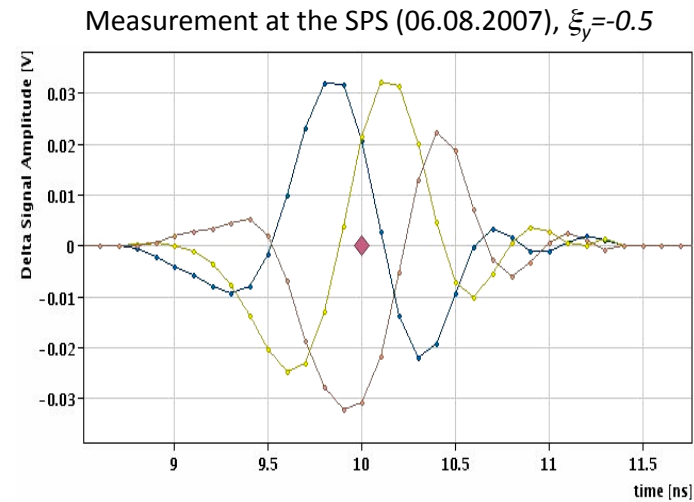
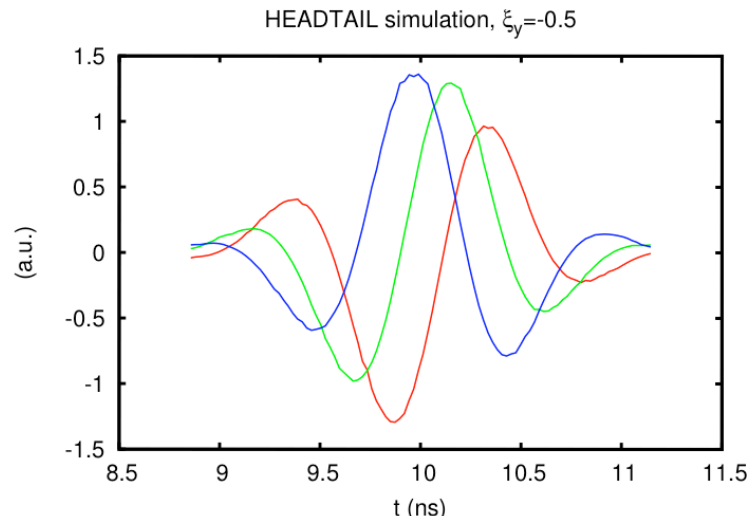

Example of simulation/measurements: **the head-tail instability**

- More benchmark of data and simulations for different values of chromaticity...

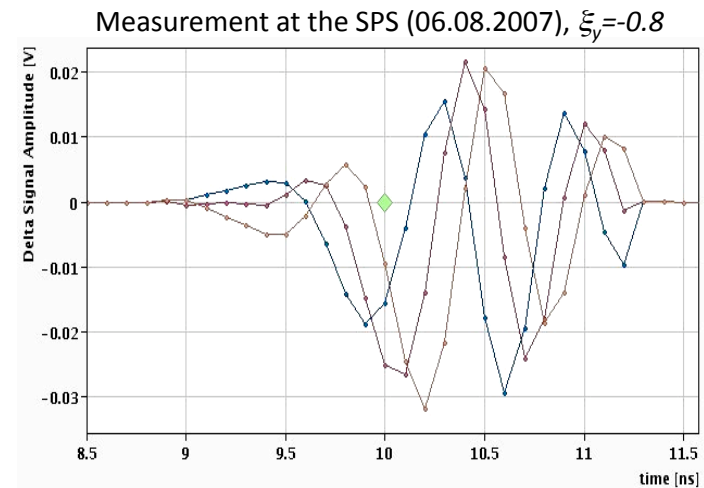
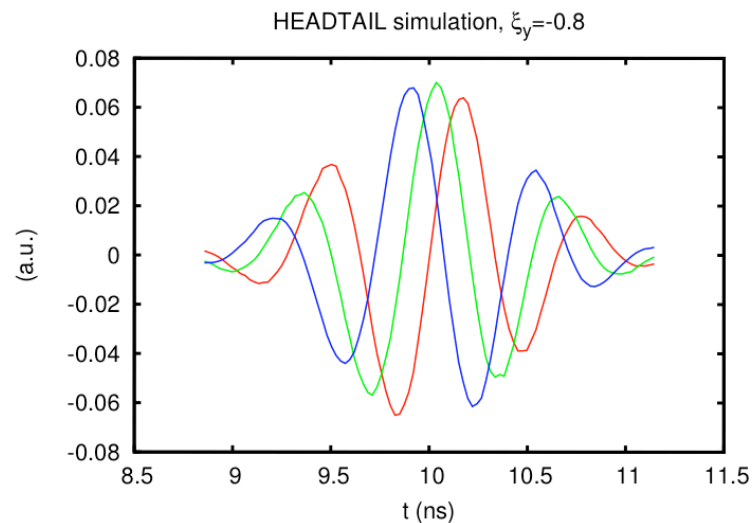
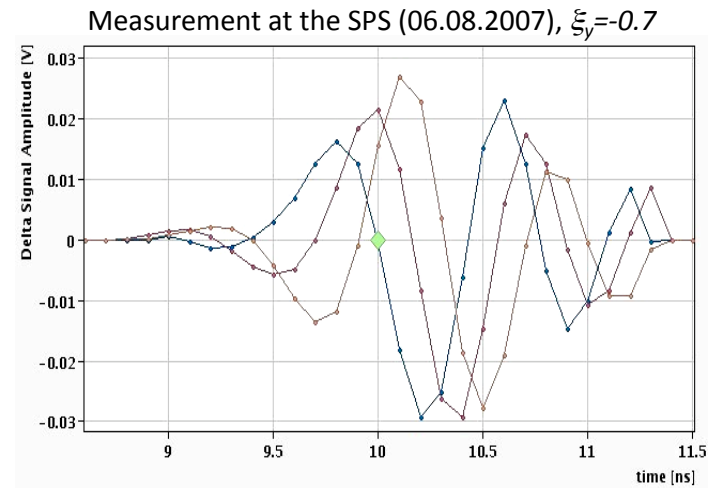
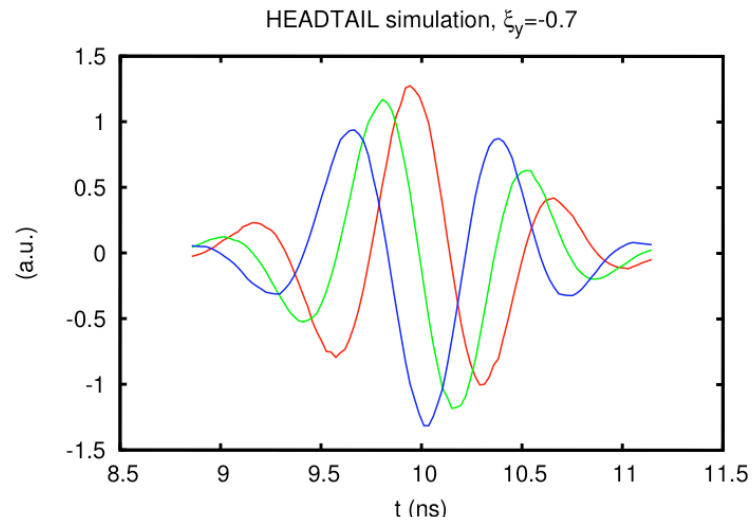

Example of measurements: **the head-tail instability**

- The **growth rates of the head-tail modes** are proportional to the **real part of the machine impedance**

→ The beam can be intentionally rendered unstable to obtain an estimation of the real part of the impedance of a machine by measuring the instability growth rate

→ If the bunch is long enough, the impedance spectrum can be probed by taking measurements at different chromaticity values.

→ Method applied to ORNL-SNS and to CERN-SPS

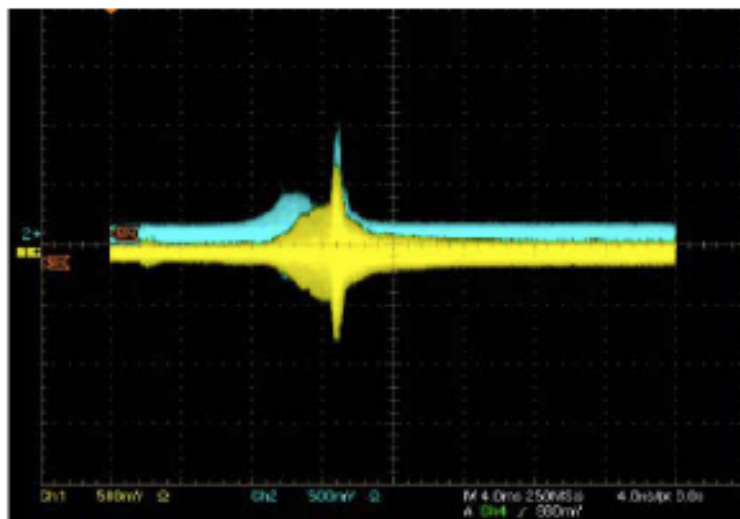

Single bunch instability measured at SNS
V. Danilov, et al., HB2006

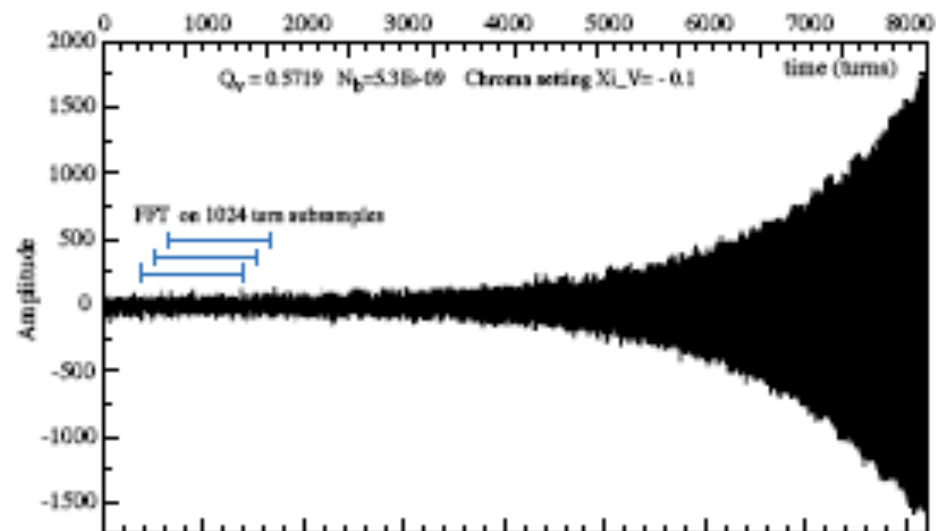

Single bunch instability measured at SPS
H. Burkhardt et al. CERN-SL-2002-030

Example of measurements: **the head-tail instability**

- The **growth rates of the head-tail modes** are proportional to the **real part of the machine impedance**
 - Growth/damping rates of the $l=0$ mode are measured as a function of chromaticity
 - The bunch behavior is reproduced in simulation with a broad-band impedance model whose parameters are adjusted such as to match the observed trend
 - Example: SPS (2001)

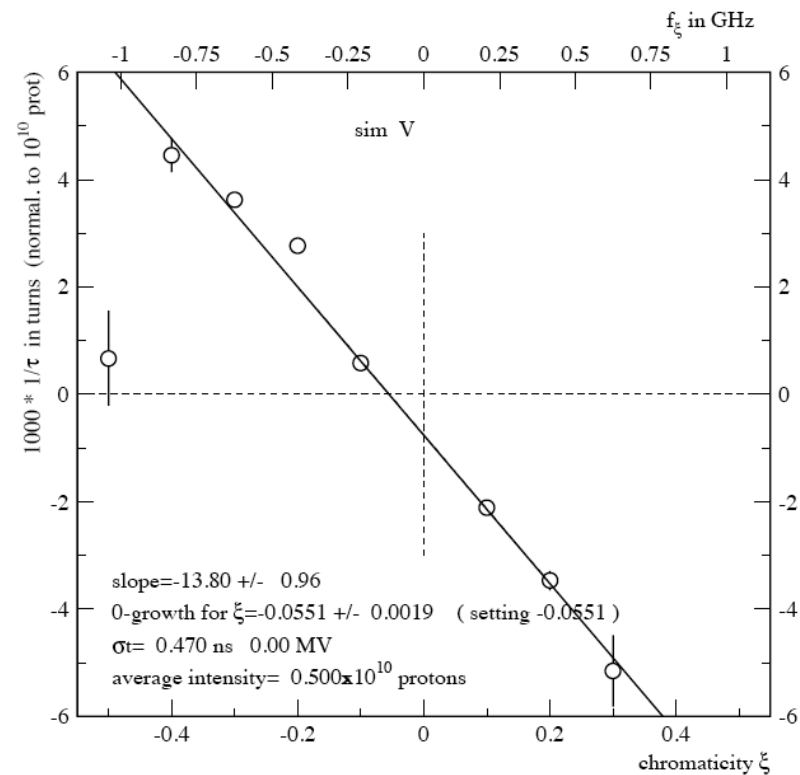
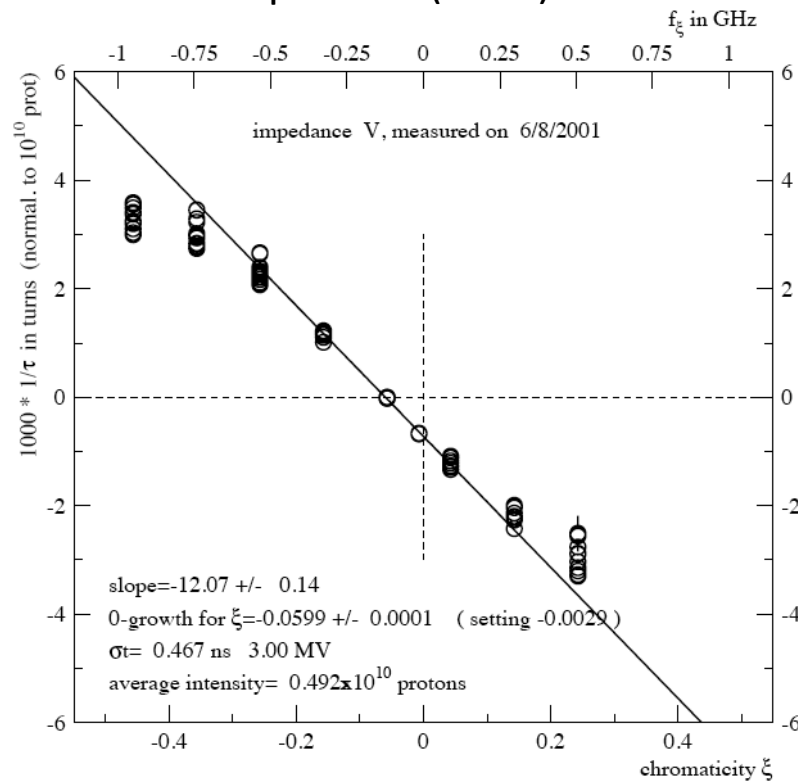

Example of measurements: **the head-tail instability**

- Higher order head-tail modes ($l \geq 1$) are usually stabilized by tune spread and/or active feedback. However, if a high intensity beam stays in a machine long enough without sufficient tune spread and without feedback, these modes can also slowly grow.
- For example, a high intensity bunch becomes unstable in the CERN-PS over 1.2 s due to resistive wall

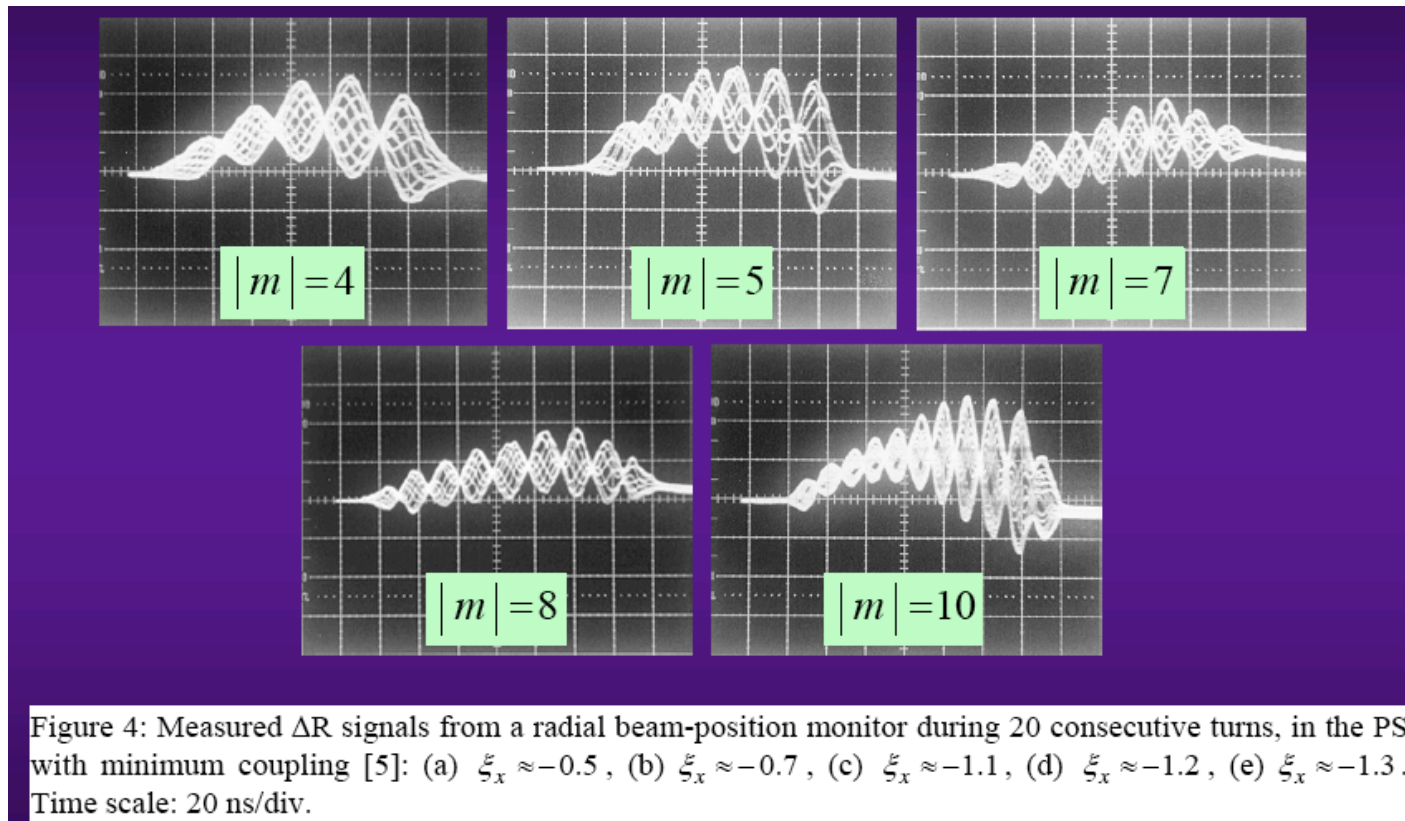

Example of simulation: **the head-tail instability**

- Higher order head-tail modes in the PS have also been simulated using the PS resistive wall impedance. These simulations are very demanding in terms of cpu time, because the bunch has to be tracked over about 500000 turns in order to see the effect arising from initial noise (E. Métral, G. Rumolo, B. Salvant)

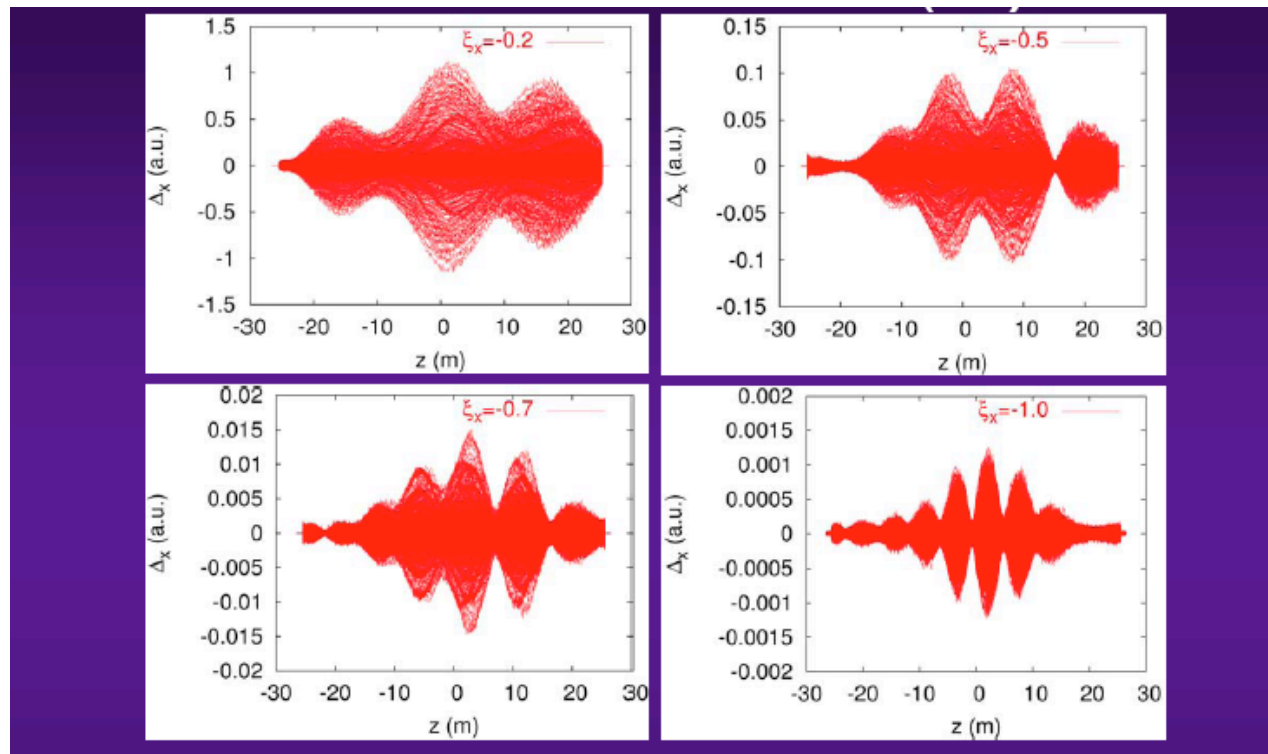

Figure 7: Examples of head-tail modes observed in the HEADTAIL simulations, when superimposing every

Example of measurements/simulation: **the TMCI**

- The **Transverse Mode Coupling Instability** is another type of single bunch instability and has different features from the head-tail instability.

⇒ It does not depend on the chromaticity setting, and it actually occurs also for corrected chromaticity (in theory, for zero chromaticity)

⇒ It has a **threshold intensity** above which it appears.

⇒ The threshold value depends on the **longitudinal emittance** of the bunch, and bunches having lower longitudinal emittances tend to become more unstable

⇒ It is **usually very fast** (rise time shorter than the synchrotron period), that's why it is also called 'strong head-tail instability' or 'beam break-up'.

⇒ The shape of the Δ signal along the bunch is not caused by a head-tail phase shift from chromaticity, but depends on the spectrum of the driving impedance.

⇒ Mathematically, it appears **when two head-tail modes merge at high intensity** and two real solutions of the dispersion relation are replaced by a pair of complex conjugate solutions.

⇒ For many years the TMCI has been observed exclusively in lepton machines. The reason is that in hadron machines its threshold is increased by space charge and is usually higher than the threshold for the longitudinal microwave instability.

However, the TMCI has been recently observed in the CERN-SPS (after the longitudinal impedance reduction campaign), in the CERN-PS and BNL-RHIC close to transition crossing.

Example of measurements/simulation: **the TMCI**

- The case of the PS high intensity bunch close to crossing transition energy (E. Métral et al.)
 - ⇒ Beam loss was observed when crossing transition
 - ⇒ The Δ_y signal along the bunch clearly showed turbulent vertical motion at a specific bunch location (i.e. a little off the peak towards the tail), where also the losses occurred
 - ⇒ Simulations with a broad-band model could well reproduce the instability and the loss

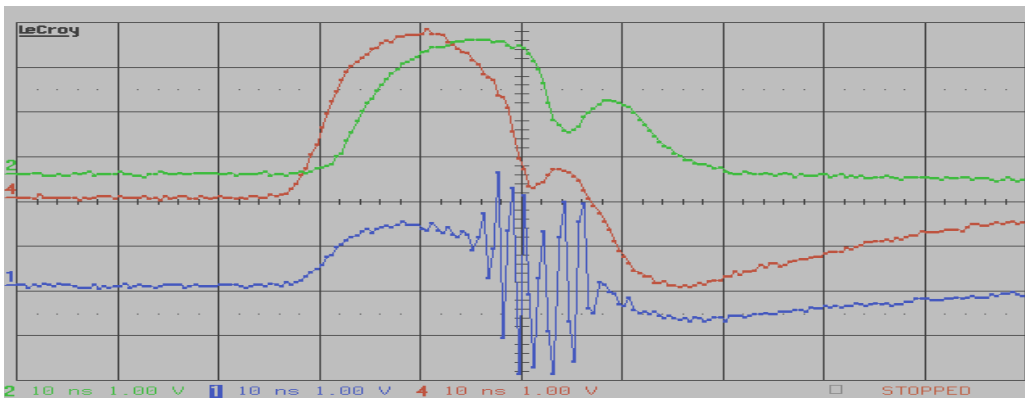

Sum and Delta signals of the PS bunch at transition crossing.

Measurement (left) and simulation with a broad-band model (right)

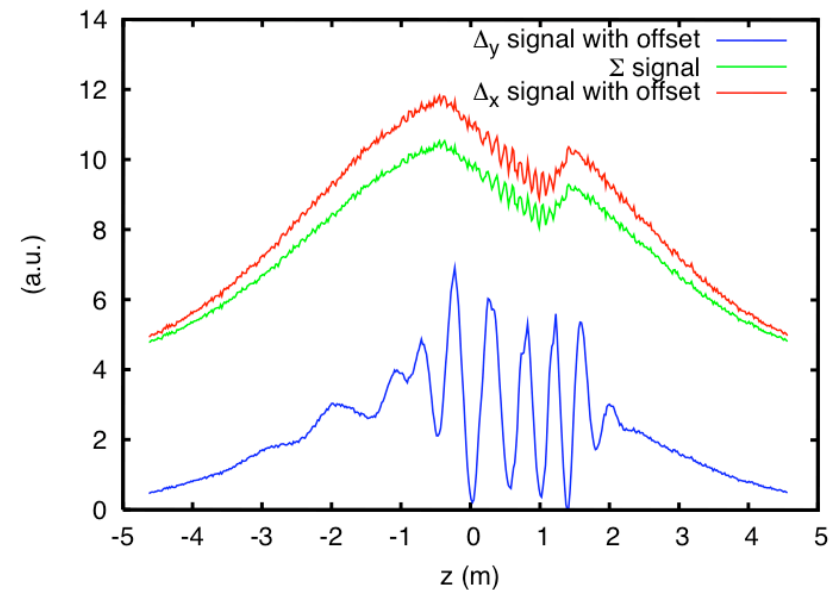

$$Z_{\text{eff}} = 3 \text{ M}\Omega/\text{m} @ 1 \text{ GHz}$$

Example of experiment: **the TMCI**

- A PSB high intensity bunch becomes unstable along the ramp (A. Findlay, D. Quatraro)
 - ⇒ Beam loss is observed at a specific point of the ramp when the damper is off
 - ⇒ The Δ_x signal along the bunch clearly shows turbulent horizontal motion propagating from the tail of the bunch toward the head
 - ⇒ Suspected TMCI

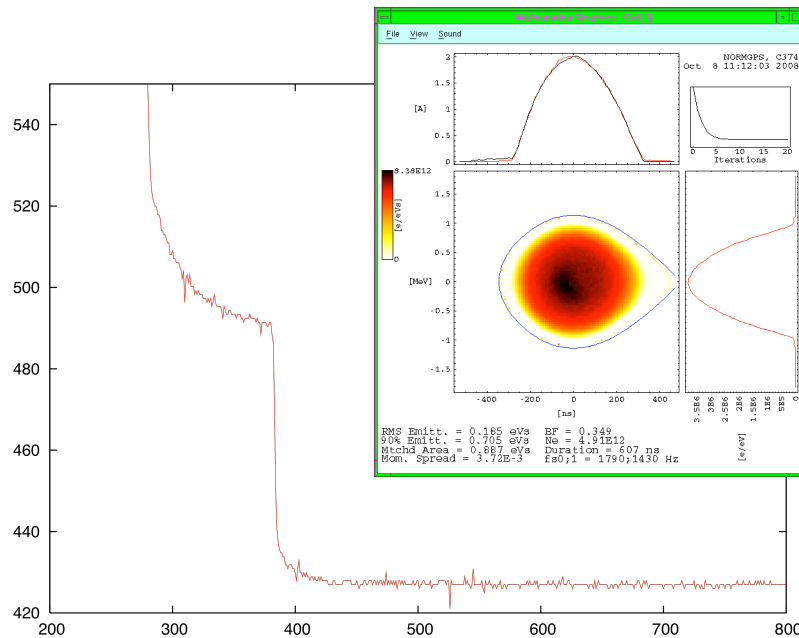

Beam loss as measured by a Beam Current Transformer

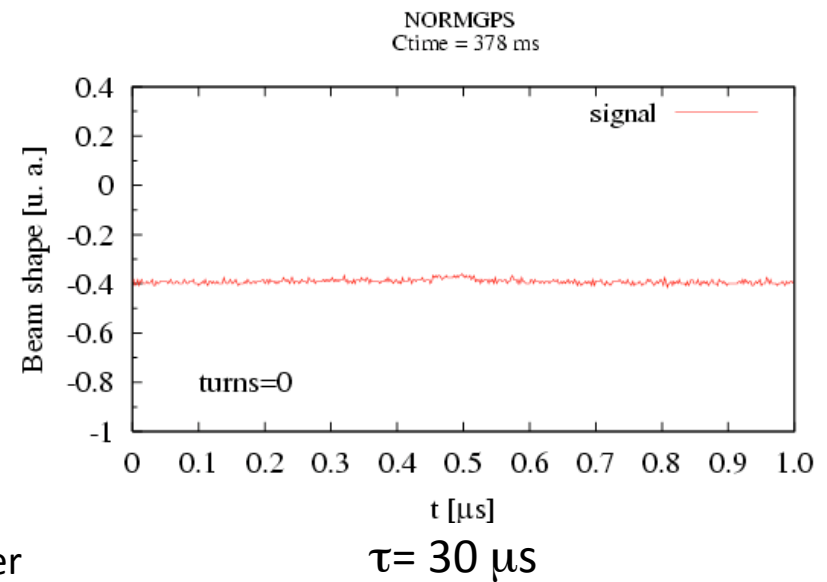

Example of measurements/calculation: **Tune shift and TMCI**

- Measurements of coherent tune shift as function of intensity in the CERN-LEP revealed other spectrum lines and in particular, the first synchrotron side bands (head-tail mode $m=\pm 1$)
 - ⇒ The two lines $m=0$ and $m=-1$ tend to merge as intensity increases
 - ⇒ Measured values are in impressive agreement with the theoretical lines

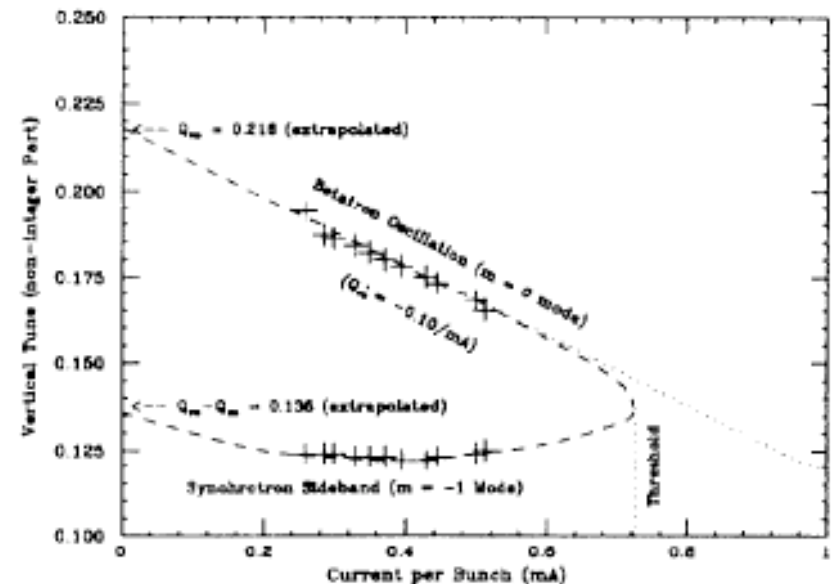
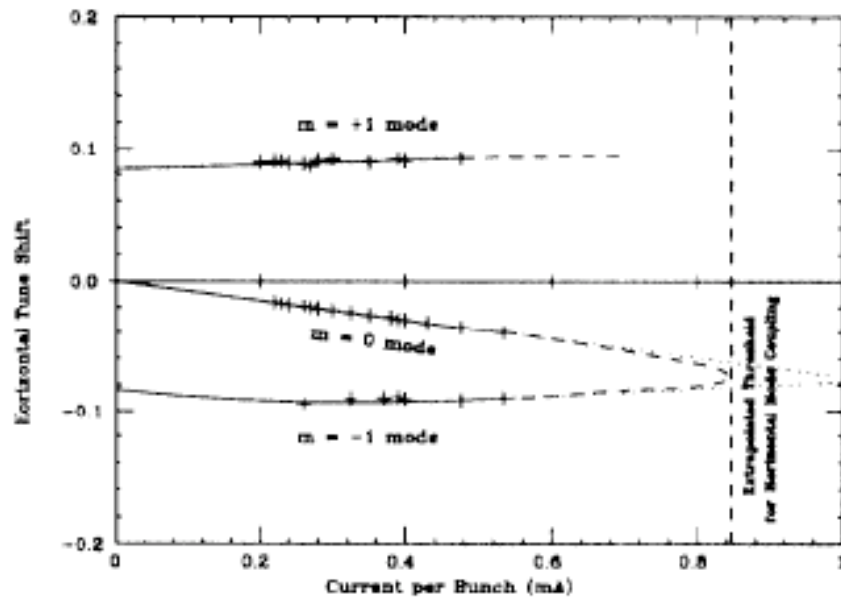

B. Zotter, Comparison of Theory and Experiment on Beam Impedances: The Case of LEP, EPAC92

Example of measurements/simulation: **Tune shift and TMCI**

- Measurements of coherent tune shift as function of intensity in the SPS have revealed that, using a low longitudinal emittance bunch, a vertical TMCI can be observed at injection above a certain intensity threshold (G. Arduini, E. Métral, G. Rumolo, B. Salvant)

⇒ Beam loss is observed at injection in some intensity ranges

⇒ The Δ_y signal along the bunch clearly shows turbulent vertical motion propagating from the tail of the bunch toward the head

⇒ A moderately unstable intensity range seems to be followed by a stable one before getting into a strong instability region

(a) SPS measurements (BCT) :

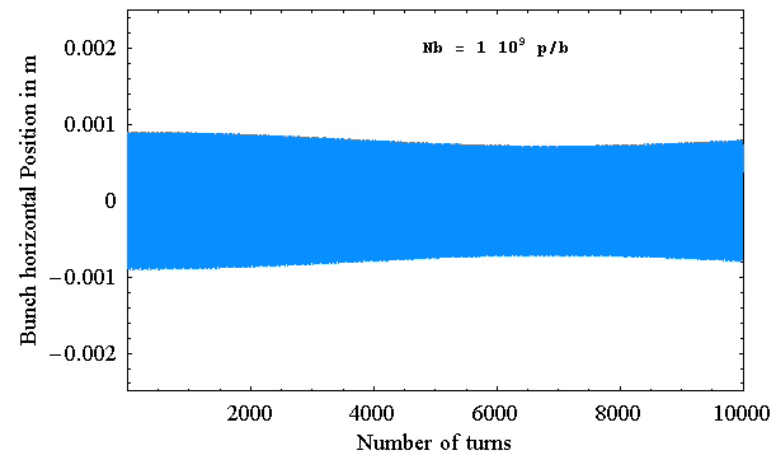
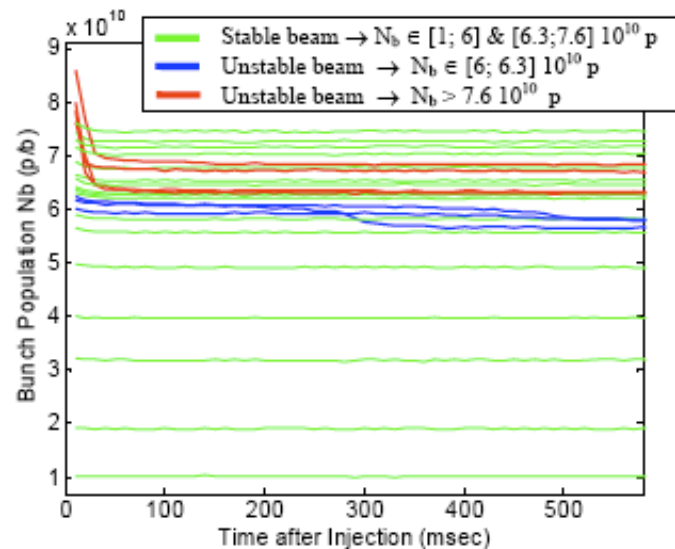

The simulated evolution of the bunch predicted the existence of slightly unstable regions for intensities lower than 8×10^{10}

Example of measurements: **Tune shift**

- What we can measure below the TMCI threshold (B. Salvant et al.)...

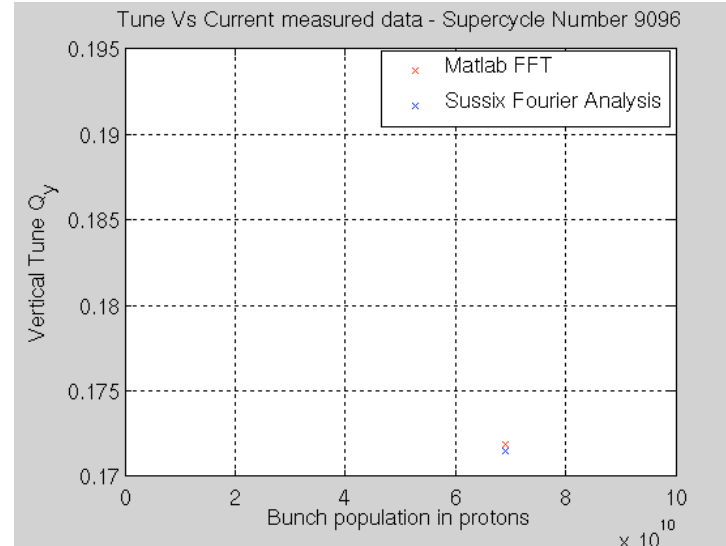
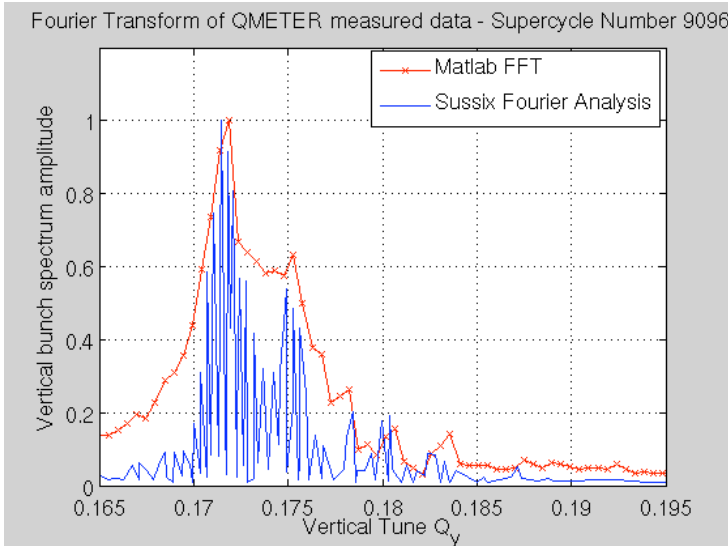
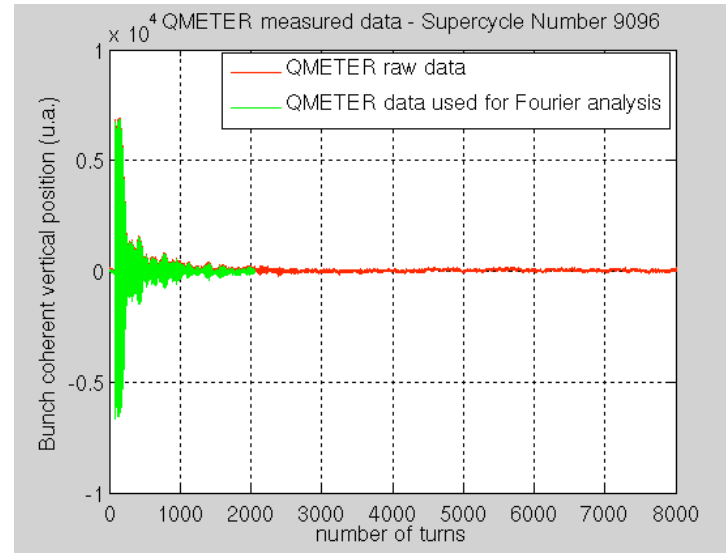
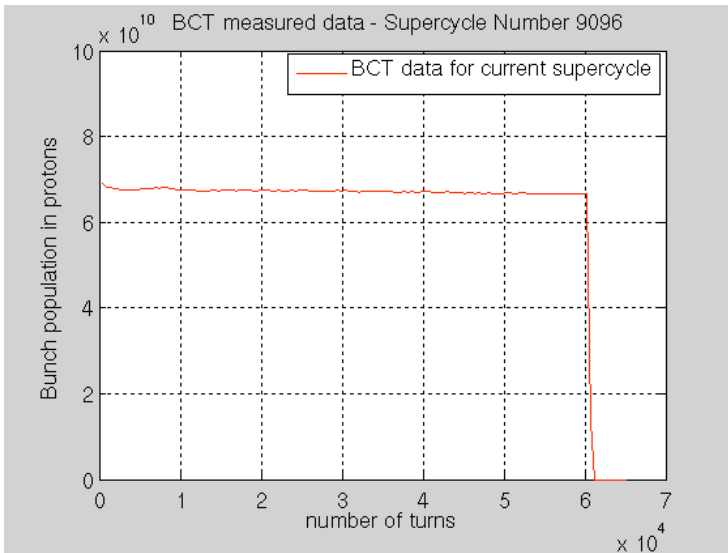

Example of measurements: **Tune shift**

- Measurements of coherent tune shift as function of intensity in the CERN-SPS (H. Burkhardt, G. Rumolo, F. Zimmermann)

⇒ From the slope of the tune shift one can infer the low frequency imaginary part of the machine impedance (iZ_{eff}). Machines with flat beam pipes show usually no tune shift in the horizontal plane and significant tune shift in the vertical plane

⇒ Tune shift measurements done with high longitudinal emittance bunches can extend to high intensities because the TMCI threshold is higher

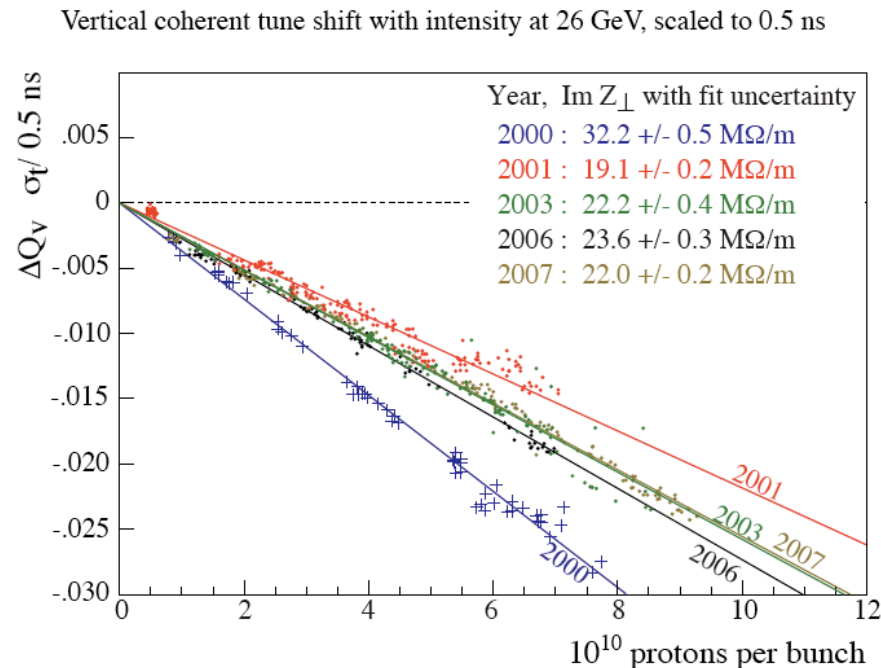

Example of measurements: **Tune shift**

- Measurements of coherent tune shift as function of intensity at the SSRF (Shanghai Synchrotron Radiation Facility)

⇒ J. Bocheng, C. Guanglin, C. Jianhui, “Collective effects of SRRF storage ring 3 GeV Phase I commissioning”, SSRF internal note, April 2008; J. Bocheng, “Impedance budget of SSRF storage ring”, SSRF internal note, April 2008.

- Vertical: $(Z_{\perp})_{eff} = 98 \sim 136 \text{ k}\Omega/\text{m}$ measured from the coherent tune shift, which is nearly a **factor of 2** above expectation.

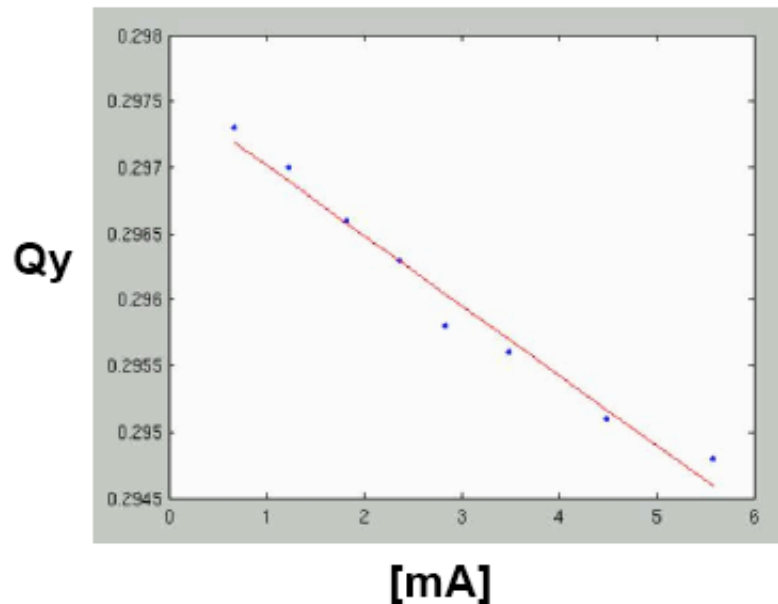

- $(I_{th})_{RW} \sim 64 \text{ mA}$ ($\xi_y = 0.1$) and $> 100 \text{ mA}$ ($\xi_y > 0.5$).

- Ion instabilities disappeared 1 month after the start of commissioning when the vacuum improved to 5×10^{-10} Torr.

Example of measurements: **Tune shift**

- Measurements of coherent tune shift as function of intensity at the Soleil
 - ⇒ R. Nagaoka, MP. Level, L. Cassinari, ME. Couprie, M. Labat, C. Mariette, A. Rodriguez, R. Sreedharan, PAC07
 - ⇒ Measured Z_{eff} is measured to be larger than expected by a factor of ~ 2 both in H and V planes.

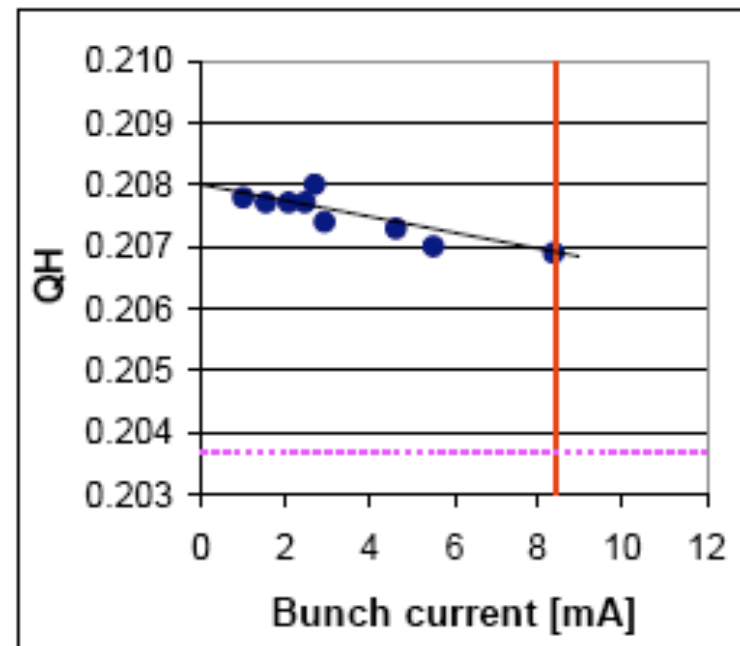
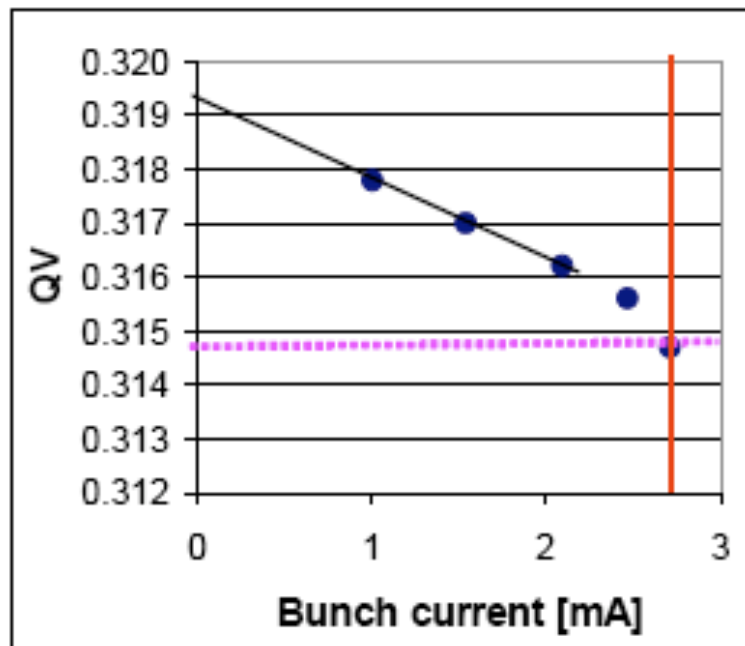

Example of measurements: **Tune shift**

- Measurements of coherent tune shift as function of intensity in low energy machines is more tricky because the contribution of the beam images (indirect **S**pace **C**harge) has to be disentangled from the contribution of the **M**achine **I**mpedance (in principle independent of energy)

⇒ Measurements at different energies can be used for this purpose

⇒ The method has been applied recently to the CERN-PSB (D. Quatraro, M. Chanel, B. Mikulec, G. Rumolo)

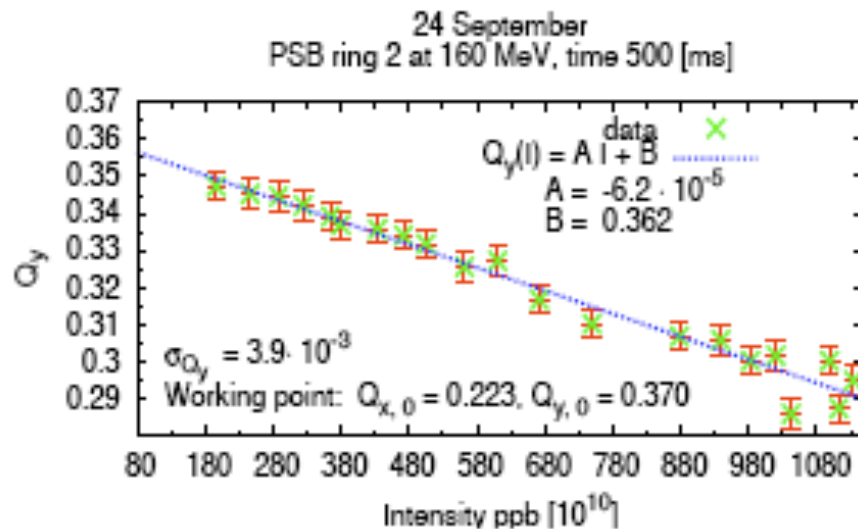

$$Z_{\text{eff}} = 14 \text{ M}\Omega/\text{m} = Z_{\text{MI}} + Z_{\text{SC}} (160 \text{ MeV})$$

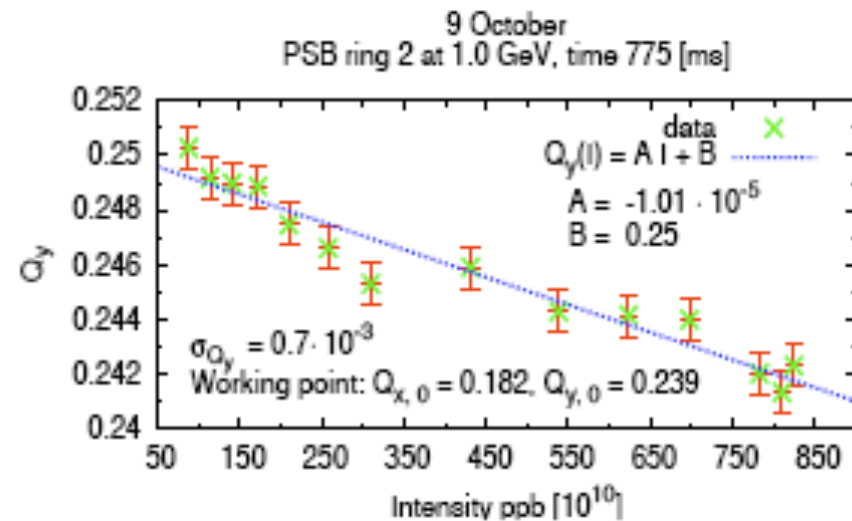

$$Z_{\text{eff}} = 5 \text{ M}\Omega/\text{m} = Z_{\text{MI}} + Z_{\text{SC}} (1 \text{ GeV})$$

Example of measurements: **Tune shift**

- Some times the tune shift can be measured changing in a controlled way a known impedance source inside the machine

⇒ Typical “tunable” impedance sources are **movable collimators, scrapers or other intercepting devices**, as the transverse impedance scales like g^{-3} (g being the device gap)

⇒ Tune measurement in the CERN-SPS while a prototype of LHC collimator (installed in the machine for test purposes) was being moved inward and outward in the horizontal plane. The vertical tune variation is due to the beam loss caused by the collimator when moved in

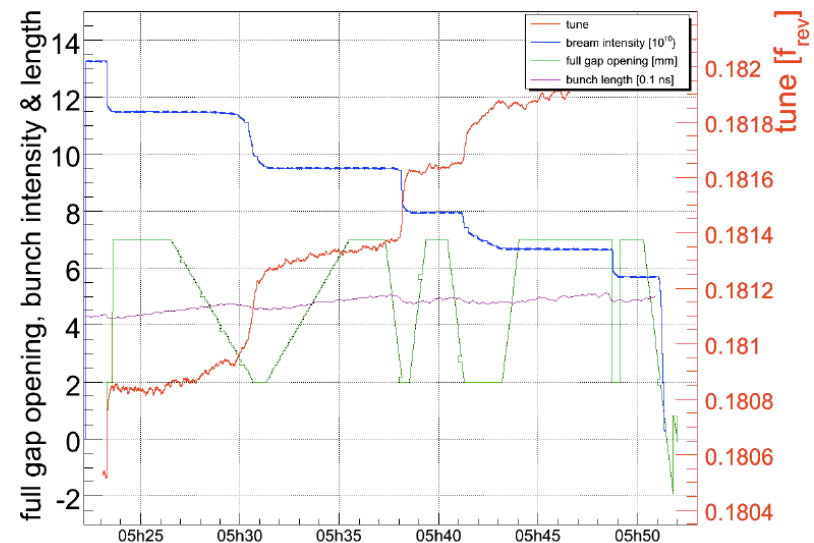
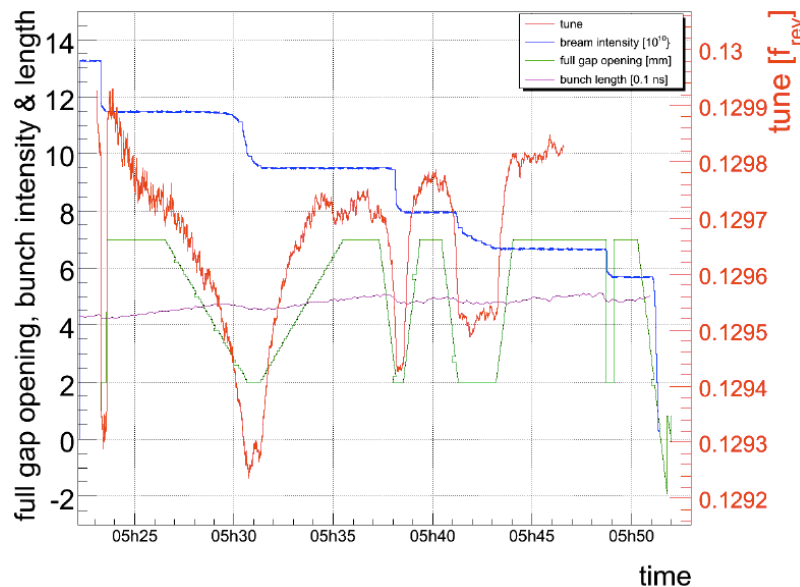

Collimator MD@SPS on the 1 November 2006 (E. Métral, S. Redaelli, B. Salvant, R. Steinhagen, etc.)

Example of measurements: **Tune shift (longitudinal)**

- Measurements of synchrotron tune shift as function of intensity can be also done in the longitudinal plane in order to estimate the longitudinal impedance
 - ⇒ The shift appears in the quadrupole mode, therefore the technique uses e.g. the synchrotron oscillations of a bunch injected with a mismatch
 - ⇒ Q_s can be extrapolated from bunch length or peak amplitude measurements
 - ⇒ Example: SPS measurements by E. Shaposhnikova, T. Bohl, J. Tuckmantel

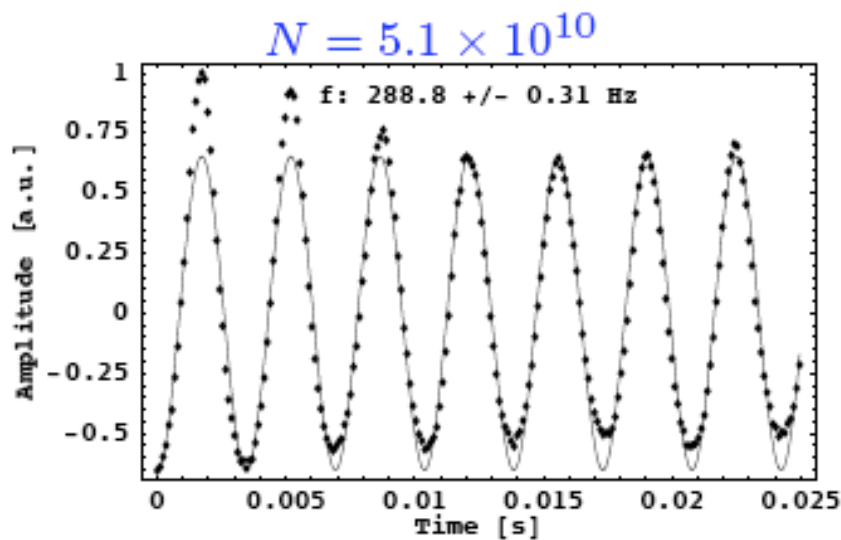

$$Z_{\text{leff}}/n \approx 5 \Omega$$

1999-2006

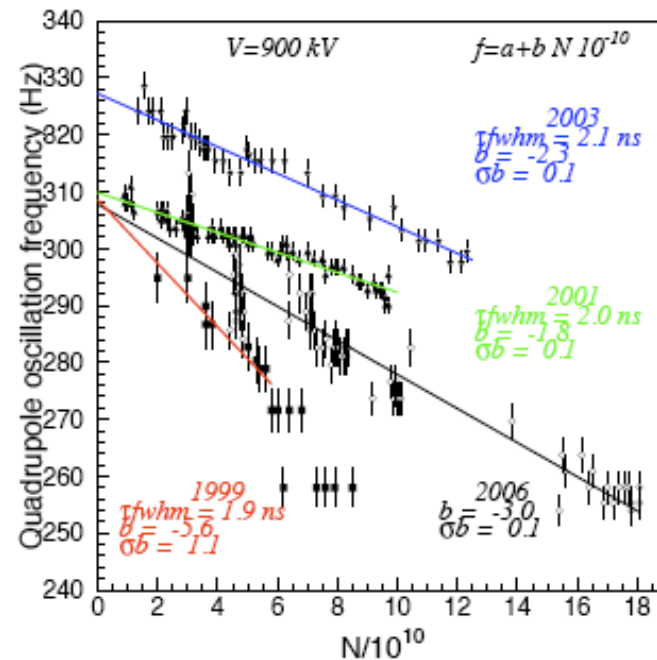

Example of simulations: **Longitudinal impedance on an SPS bunch**

- Simulating the effect of a longitudinal impedance on an SPS bunch we can clearly distinguish the effects in lower and higher intensity regimes

⇒ Bunch lengthening regime shows with a linear increase of the bunch length as a function of the bunch intensity

⇒ Unstable regime is characterized by a change of slope in bunch lengthening

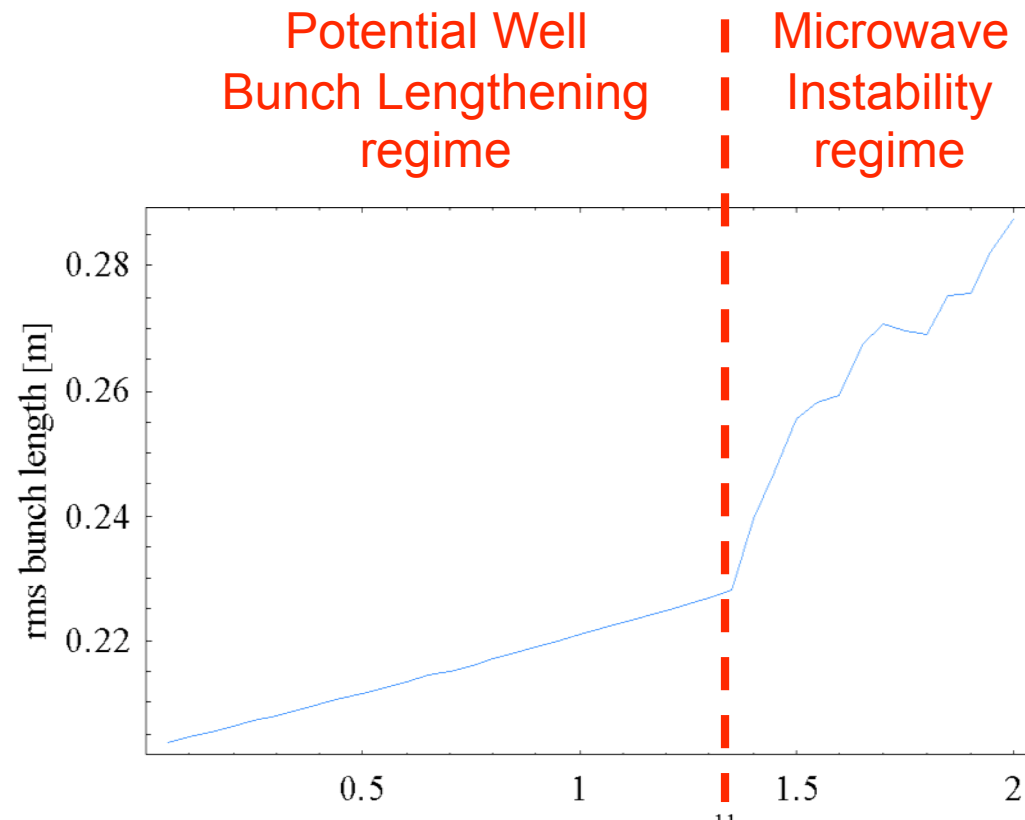

Example of simulations: **Longitudinal impedance on an SPS bunch**

- Simulating the effect of a longitudinal impedance on an SPS bunch we can clearly distinguish the effects in lower and higher intensity

⇒ Bunch lengthening regime: slow evolution towards a new equilibrium with a slightly shifted synchronous phase due to energy loss.

⇒ Unstable regime: micro-bunching appear.

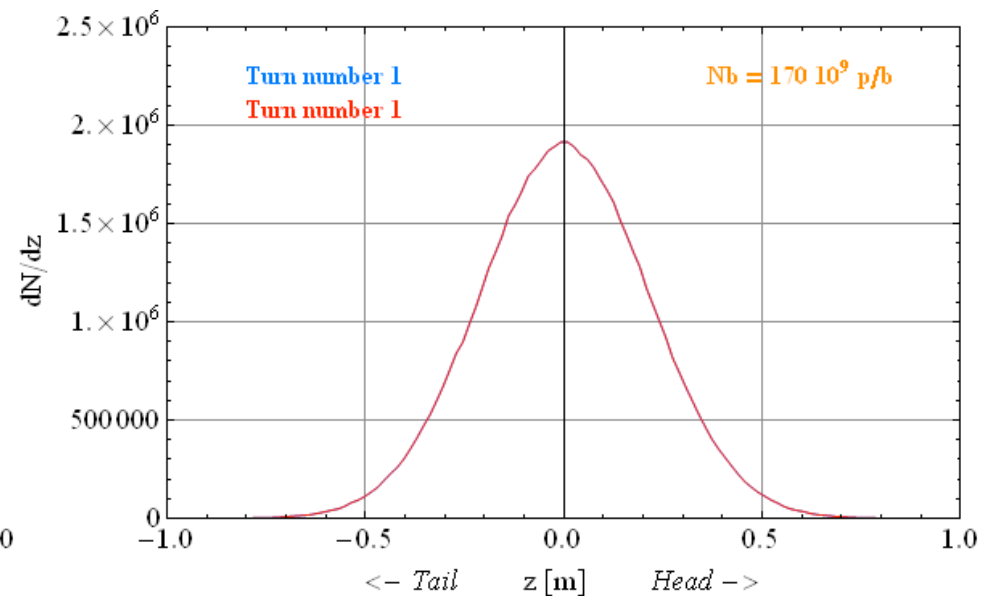
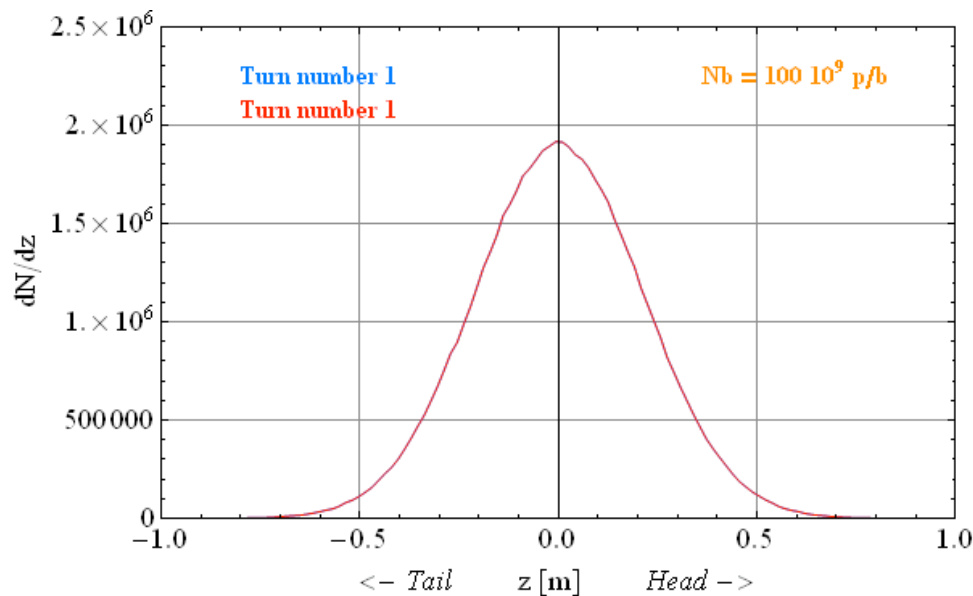

Bunch shape evolution in the regime of **bunch lengthening** (10^{11} ppb, left movie) and just above the threshold for **microwave instability** (1.7×10^{11} ppb, right movie)

Example of measurements: **Other methods to estimate $Z_{||\text{eff}}$**

- In order to estimate the longitudinal impedance, it is also possible to look at
 - ⇒ Bunch lengthening (ex. DIAMOND, R. Bartolini)
 - ⇒ The energy loss measured through the synchronous phase shift (ex. Australian light source, R. Dowd, M. Boland, G. LeBlanc, M. Spencer, Y. Tan, PAC07)

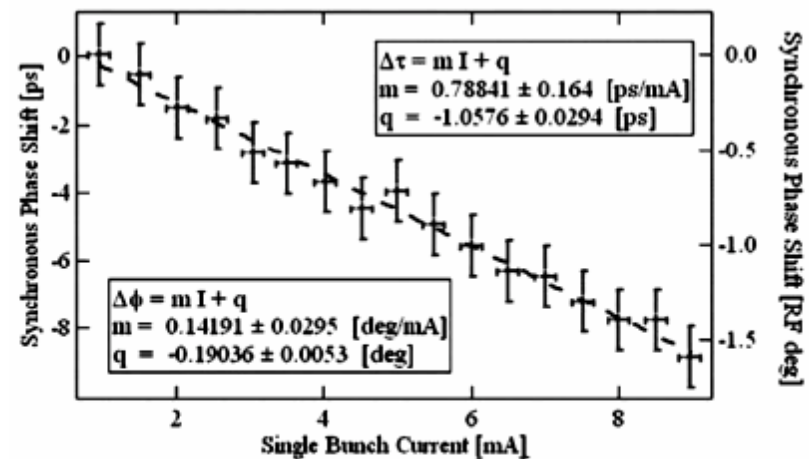
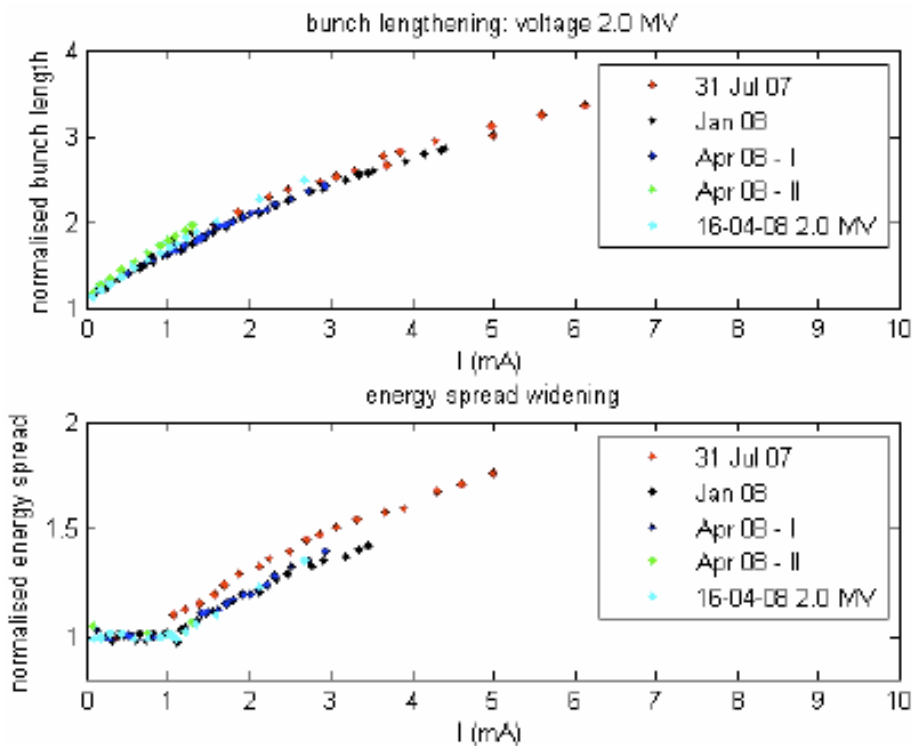

Synchronous phase shift measured with a streak camera in the Australian Synchrotron.

Example of measurements: **Microwave instability in the SPS**

- Microwave instability of a debunching bunch has been used in the SPS to investigate on the spectrum of the longitudinal impedance and try to spot the main frequencies (E. Shaposhnikova, T. Bohl and T. Linnecar)

⇒ This allows identifying the main candidates as impedance sources

⇒ Long bunch samples better in frequency.

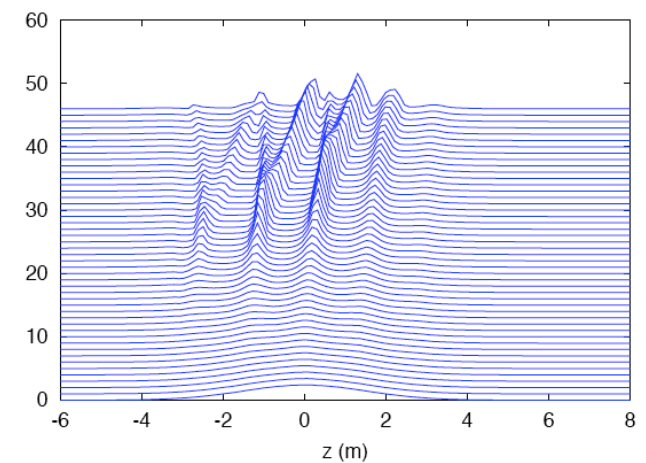
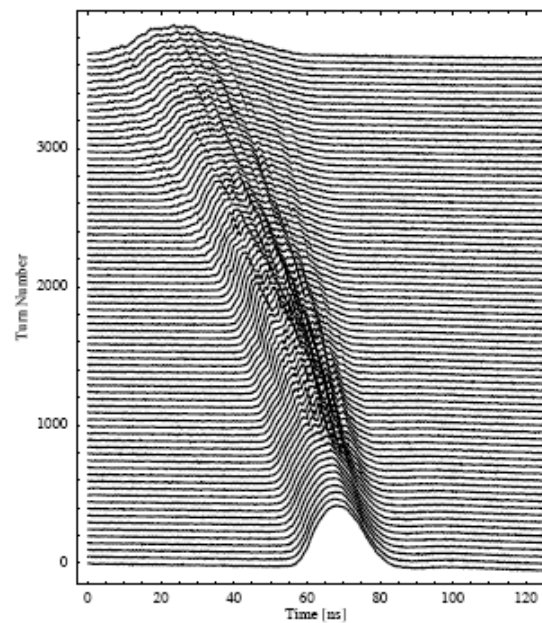
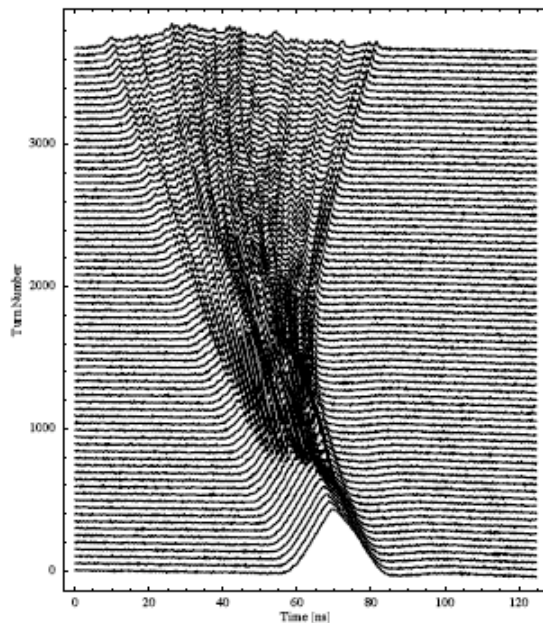

Simulation with the SPS longitudinal impedance model

SPS data: below transition energy (left) and above (right)

Measurements or estimations of the impedance of a machine: **Summary**

• **Transverse:**

- ⇒ Use **growth rates of the mode $m=0$ of the head-tail instability** to estimate the **real part of the impedance**
 - scan in chromaticity allows for **a frequency scan of the impedance spectrum**
- ⇒ Use **onset of TMCI** and bunch evolution under the effect of a TMCI
- ⇒ Use **coherent tune shift** to measure **the low frequency imaginary part of the impedance**

• **Longitudinal:**

- ⇒ Several ways to determine the **low frequency imaginary part**
 - measure **the incoherent quadrupole frequency shift** for synchrotron oscillations
 - measure **bunch lengthening or momentum spread widening**
- ⇒ **Real part** related to
 - **energy loss**, which can be estimated by measuring the **synchronous phase shift**
 - **onset of microwave instability.**
 - ✓ **The rise time** relates to the magnitude of the impedance
 - ✓ The frequencies involved in the **measured evolution** also help find possible candidates for main sources of impedance