



Energy Efficiency

Erk Jensen
CERN

CAS FEL & ERL, Hamburg, 2016



Outline



- Introduction
 - Orders of magnitude – energy use – setting the scene – definition “efficiency” – *EnEfficient* network
- Power flow in an accelerator
 - Example PSI (special thanks to M. Seidel/PSI!)
- Is everything lost?
 - Can we recover (make good use of) the heat?
- Optimizing magnets
 - Why do they need power at all?
- RF power generation
 - The power to accelerate
- Conversion RF power → beam
 - A trade-off between accelerating gradient and efficiency
- Cryogenic system
 - How much power do you need to save power?
- Recovering the beam energy
 - The “master class” of better energy efficiency



Introduction

Orders of magnitude – energy use – setting the scene – definition “efficiency”

Why does energy efficiency matter?

- Scarcity of fossil energy – problematic nuclear power
- Volatile & unpredictable energy costs
- Increasing environmental concerns (global warming, El Niño, CO₂ emission)
- Awareness for 50 years (Club of Rome 1968, Oil crisis 1973)
- Political – societal imperative: must go towards **sustainable energy** !
- Also particle accelerator facilities must be conceived/built/operated with this in mind! ... in fact – they should give a good example and incite R&D!

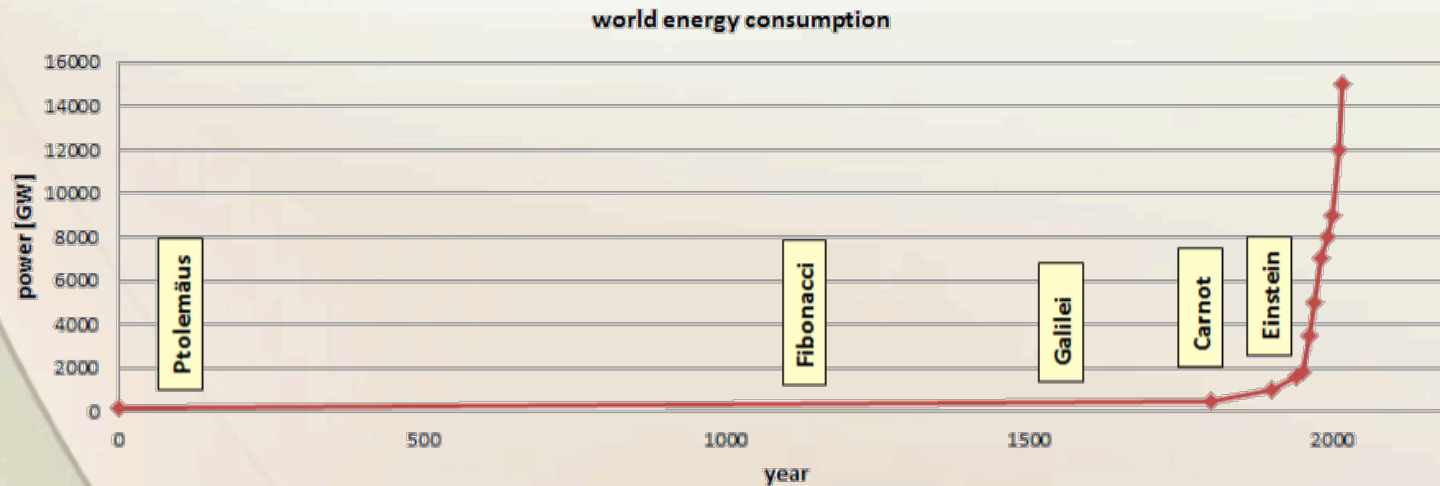
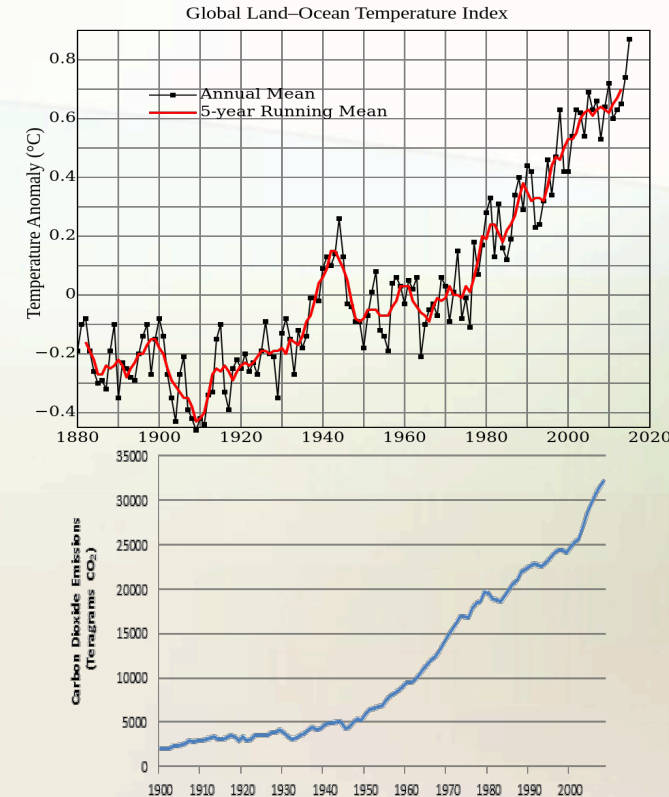



Orders of magnitude – e.g. USA

Estimated U.S. Energy Consumption in 2015: 97.5 Quads
= 28.574 PWh

Lawrence Livermore
National Laboratory

1 Quad = 293.07 TWh

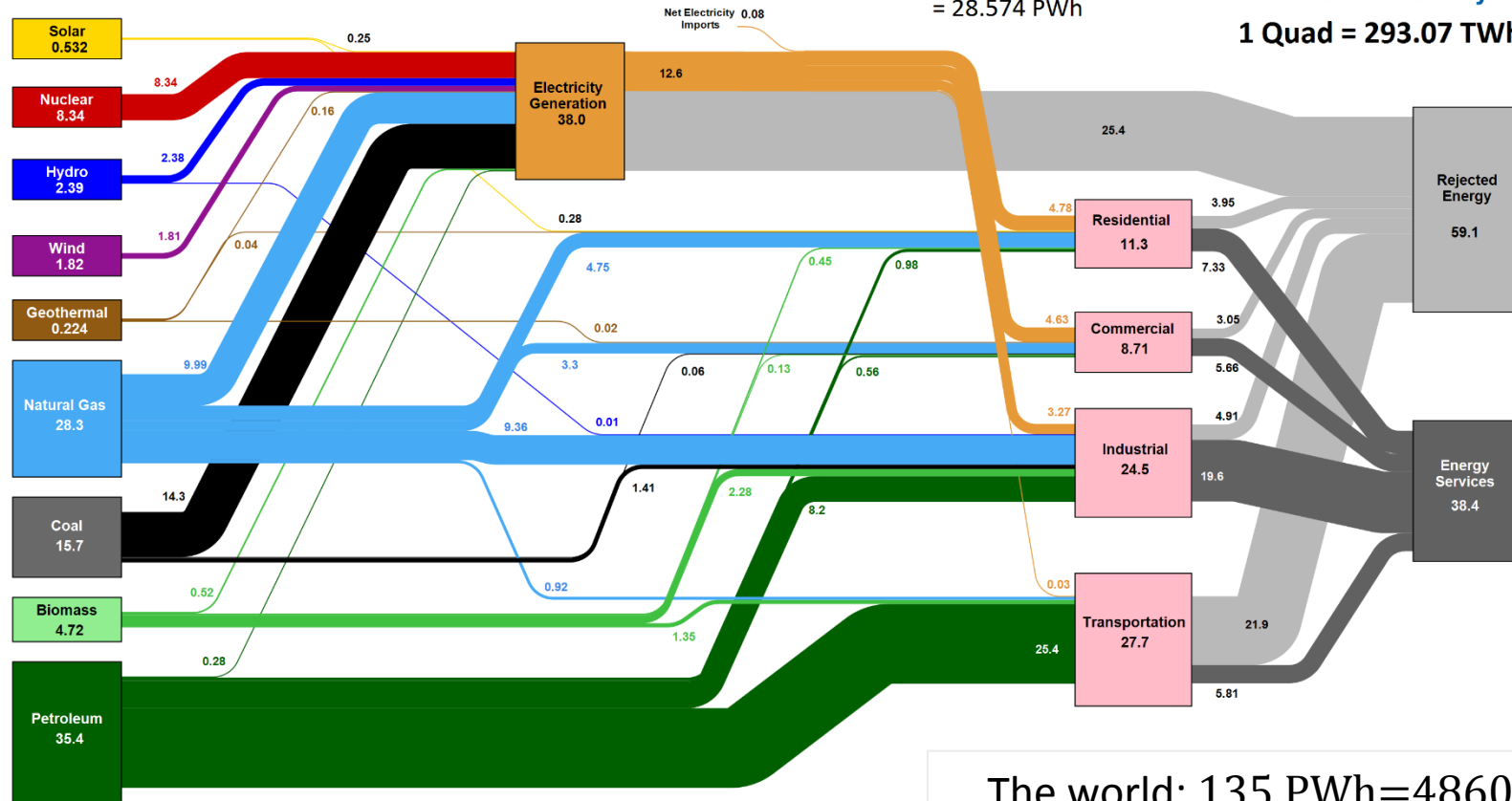

A large fraction is wasted!

The world: 135 PWh=486000 PJ=15.4 TW·a

Source: LLNL March, 2016. Data is based on DOE/EIA MER (2015). If this information or a reproduction of it is used, credit must be given to the Lawrence Livermore National Laboratory and the Department of Energy, under whose auspices the work was performed. Distributed electricity represents only retail electricity sales and does not include self-generation. EIA reports consumption of renewable resources (i.e., hydro, wind, geothermal and solar) for electricity in BTU-equivalent values by assuming a typical fossil fuel plant heat rate. The efficiency of electricity production is calculated as the total retail electricity delivered divided by the primary energy input into electricity generation. End use efficiency is estimated as 65% for the residential sector, 65% for the commercial sector, 80% for the industrial sector, and 21% for the transportation sector. Totals may not equal sum of components due to independent rounding. LLNL-11-410527

<https://flowcharts.llnl.gov/commodities/energy>

More orders of magnitude

generation	consumption	storage
1d cyclist „Tour de France“ (4h x 300W): 1.2 kWh	1 run of cloth washing machine: 0.8...1 kWh	Car battery (60 Ah): 0.72 kWh
1d Wind Power Station (avg): 12 MWh	1d SwissLightSource 2.4 GeV, 0.4 A: 82 MWh	ITER superconducting coil: 12.5 MWh
1d nucl. Pow. Plant (e.g. Leibstadt, CH): 30 GWh	1d CLIC Linear Collider @ 3 TeV c.m. 14 GWh	all German storage hydropower: 40 GWh



cyclist, 300 W



wind-power,
3 MW peak



SLS, 3.5 MW

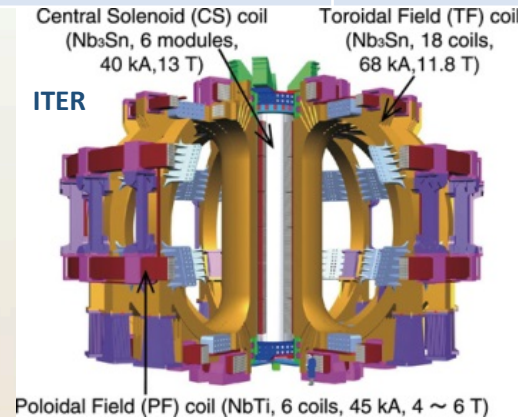

car battery



nucl. plant 1.3 GW

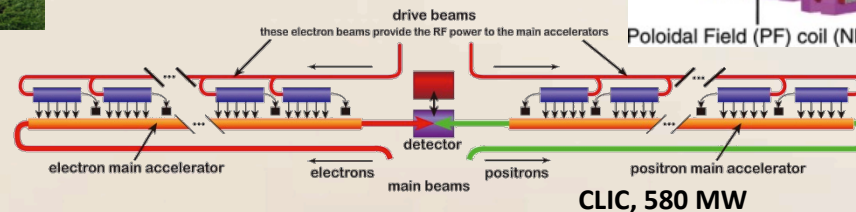

CLIC, 580 MW



hydro storage

More orders of magnitude

generation	consumption	storage
1d cyclist „Tour de France“ (4h x 300W): 1.2 kWh	1 run of cloth washing machine: 0.8...1 kWh	Car battery (60 Ah): 0.72 kWh
1d Wind Power Station (avg): 12 MWh	1d SwissLightSource 2.4 GeV, 0.4 A: 82 MWh	ITER superconducting coil: 12.5 MWh
1d nucl. Pow. Plant (e.g. Leibstadt, CH): 30 GWh	1d CLIC Linear Collider @ 3 TeV c.m. 14 GWh	all German storage hydropower: 40 GWh
1d Earth/Moon System E-loss: 77 TWh	1d electrical consumption mankind: 53 TWh	World storage hydropower: O(1 TWh)
1d sunshine absorbed on Earth: 3,000,000 TWh = 3 EWh (Exa = 10¹⁸)	1d total consumption humankind: 360 TWh	<i>Energy storage seems not to scale up!</i>

cyclist, 300 W

- Accelerators are in the range where they become relevant for society and public discussion.
- Desired turn to renewables is an enormous task; storage is the problem, not production!
- Fluctuations of energy availability, depending on time and weather, will be large!

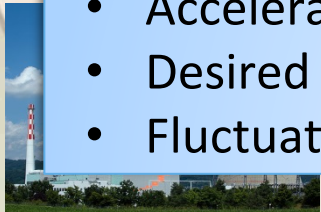

nucl. plant 1.3 GW

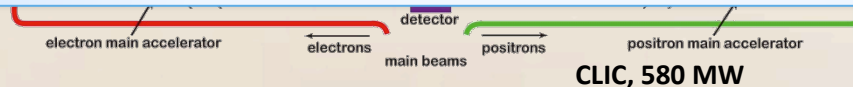

hydro storage

M. Seidel/PSI

Efficiency η , definition

- Larger efficiency

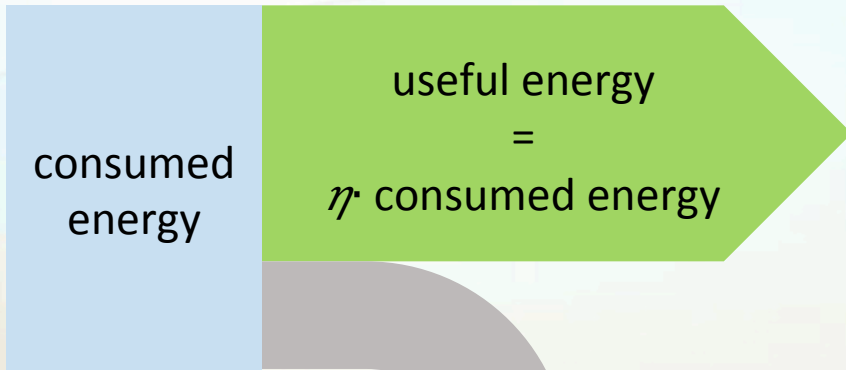

rejected energy
(normally heat)

- Smaller efficiency

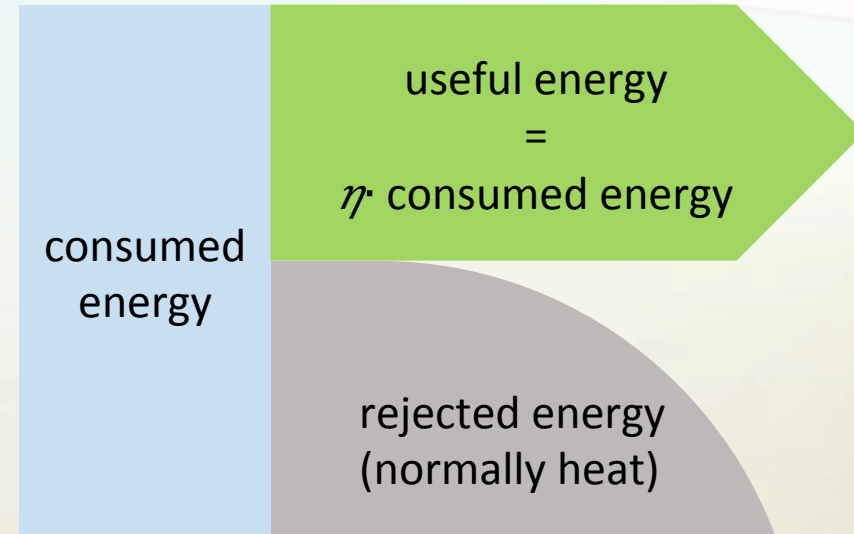

Note:

larger η means less energy consumed, less energy wasted and smaller installation!

- Definition makes sense only for an energy-converting sub-system.
- For an accelerator facility, we need other figures of merit!

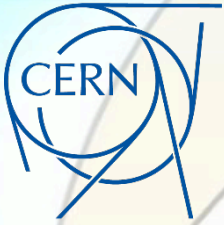

Acknowledging

EuCARD² Network *EnEfficient*



- **EuCARD²** (“*European Coordination for Accelerator R&D*”) is co-funded by its partners and the European Commission under Capacities 7th Framework Programme, Grant Agreement 312453, and runs from 2013 to 2017.
- Work Package 3 of EuCARD² is the networking activity “*EnEfficient*”, which stimulates developments, supports accelerator projects, thesis studies and similar in the areas of
 - Energy recovery from cooling circuits,
 - Higher electronic efficiency RF power generation,
 - Short term energy storage systems,
 - Virtual power plant,
 - Beam transfer channels with low power consumption.
- More details under www.psi.ch/enefficient
- Partners: PSI, CERN, KIT, ESS, GSI

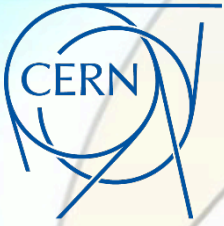

Power flow in an accelerator

Example PSI (special thanks to M. Seidel/PSI!)

Power flow in Accelerators

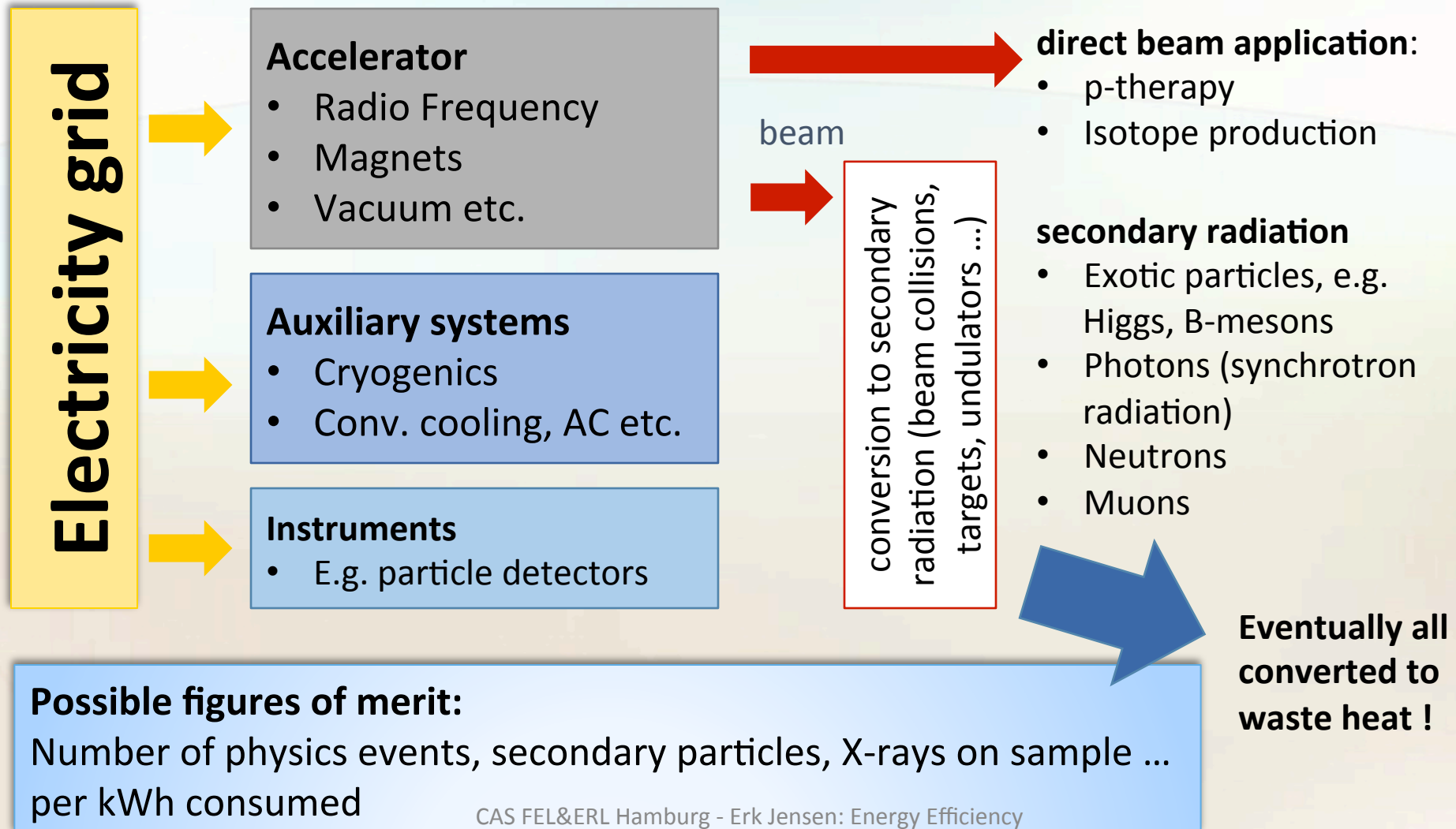

Example: PSI – 10 MW

Ring Cyclotron 590 MeV
loss $\approx 10^{-4}$
Power transfer through
4 amplifier chains
4 cavities 50 MHz

2.2 mA / 1.3 MW



50 MHz cavity

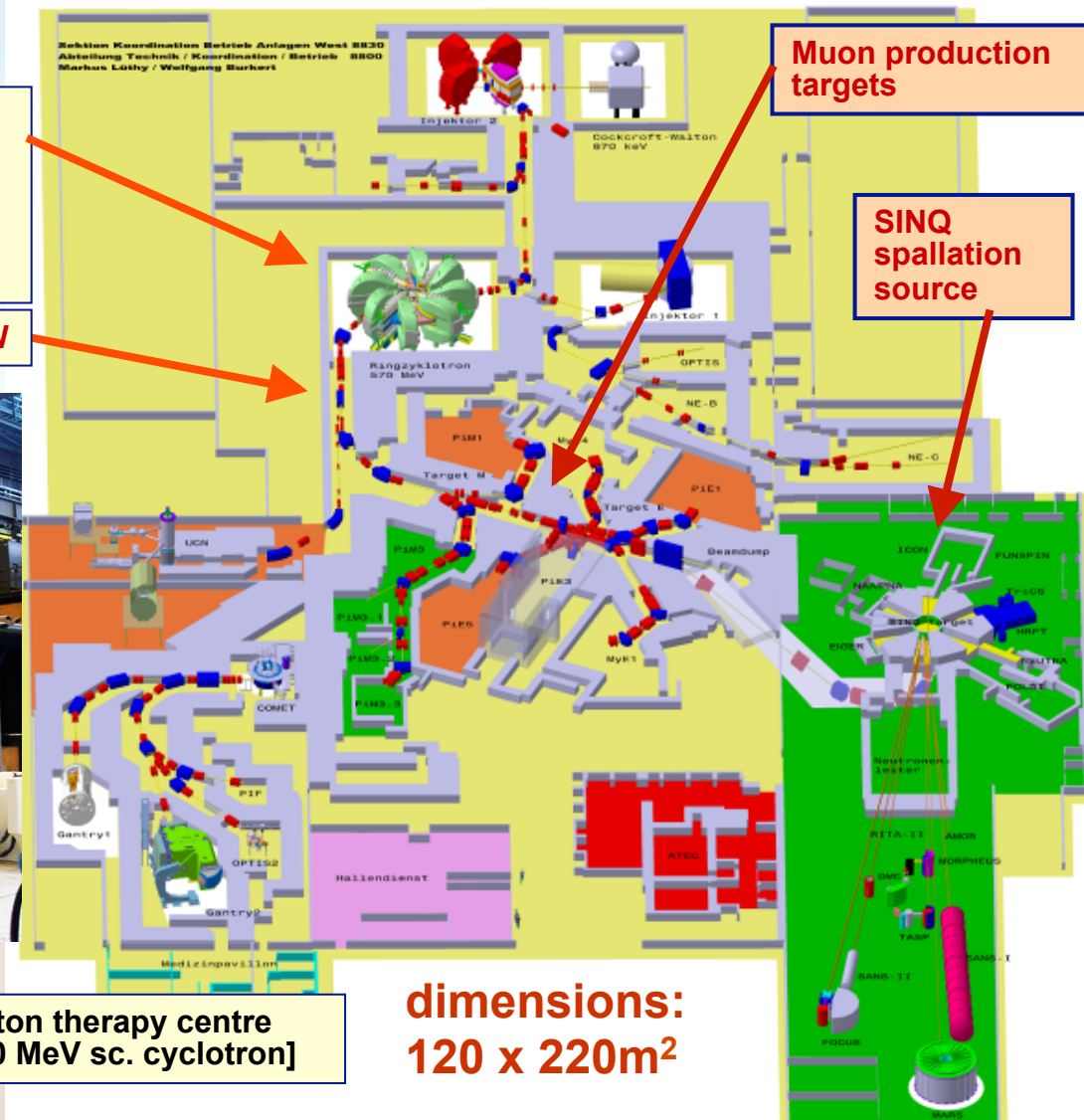

Muon production targets

SINQ spallation source

proton therapy centre
[250 MeV sc. cyclotron]

dimensions:
120 x 220m²



Example: PSI – 10 MW

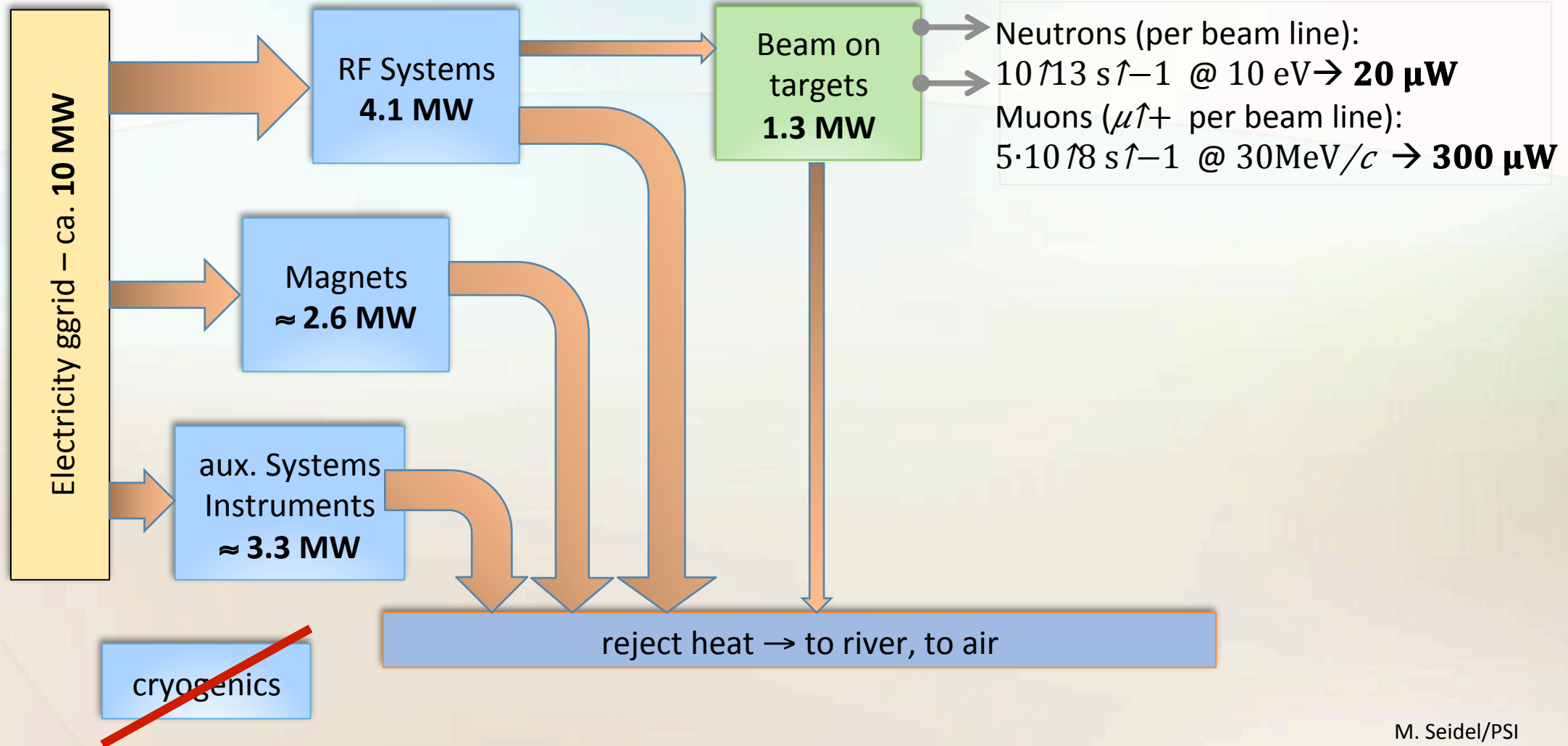

Example: Conversion efficiency from power grid → secondary radiation

Often great potential for possible η improvement:

- Light sources/synchrotrons: emittance control! – optimized undulators!
- Light sources/FEL: coherent radiation – beam energy recovery (ERL)!
- HEP colliders: low-beta insertion; crab cavities etc.
- Neutron Sources: target optimization; moderators, neutron guides etc.
- Muon Sources: target optimization; capture optics; μ -cooling

Linear collider: $L \propto \sqrt{\delta E / \gamma \epsilon \downarrow y} \cdot P \downarrow \text{beam} / 1 E \downarrow \text{c.m.}$

PSI-HIPA: Muons

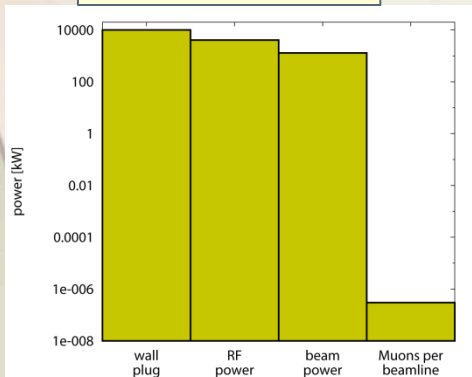

PSI-HIPA: Neutrons

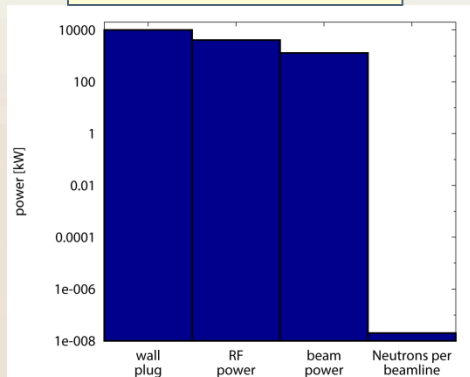

SLS: SR

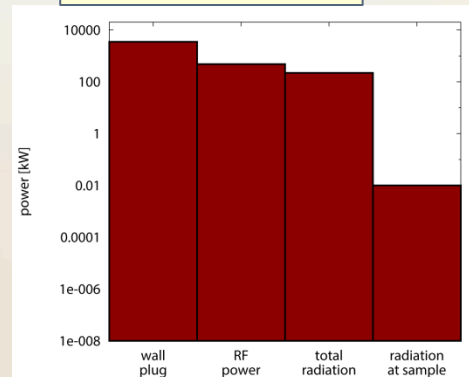

SwissFEL: SR

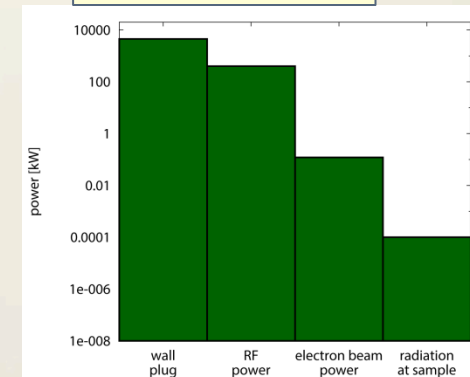

Example: measures to improve conversion η of a spallation target

- Old target design

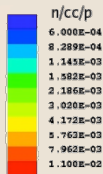
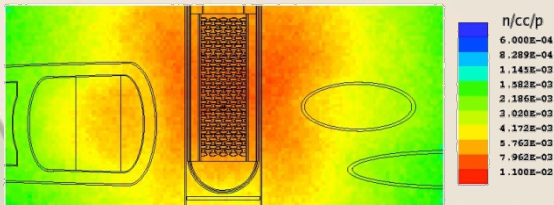
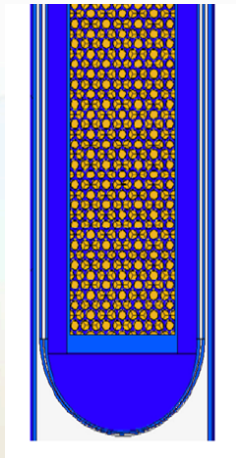

Colour code:
neutron density,
same scale

- New target design

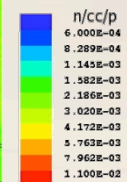
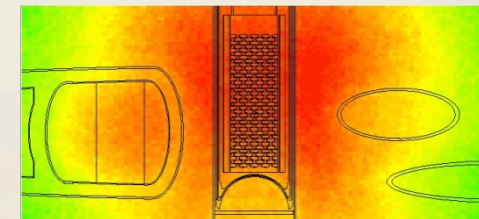
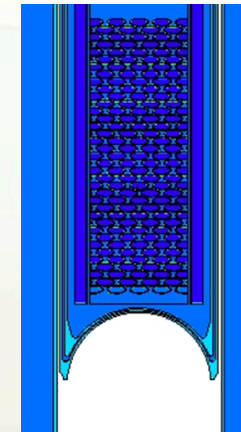

Implemented measure	Gain
Zr cladding (instead of steel)	12%
More compact rod bundle	5%
Pb reflector	10%
inverted entrance window	10%
total gain in conversion	42.3%



Is everything lost?

Since all the consumed energy seems to be converted to heat:

Can we recover (make good use of) the heat?

It the heat wasted? The Carnot cycle

- Heat engine (“steam engine”)

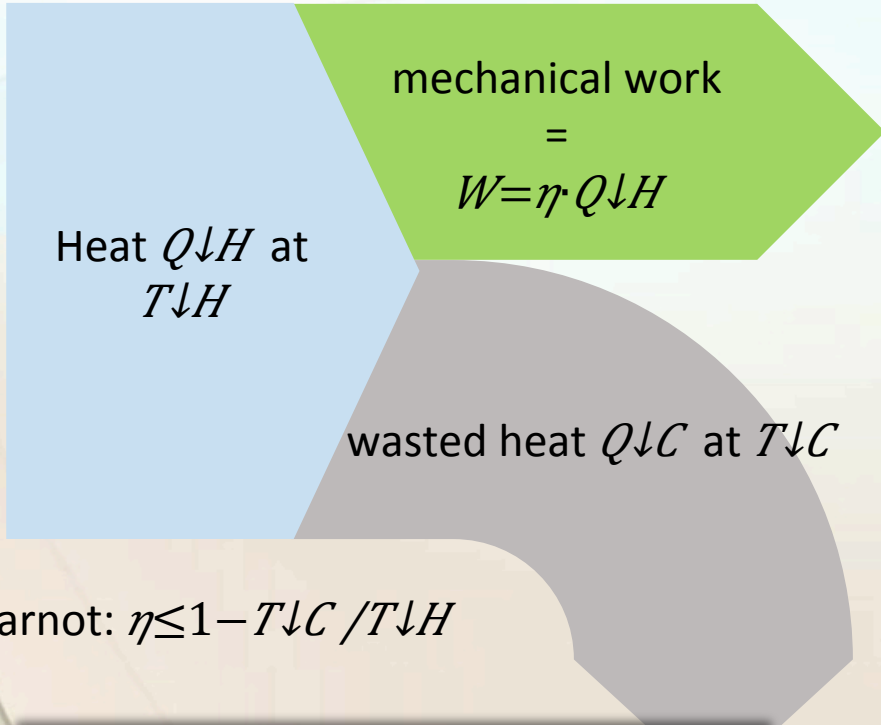

Limit when converting heat to work;
large η requires large $T\downarrow H$!

- Reversed: refrigeration system (or heat pump)
cooling, $Q\downarrow C$ at $T\downarrow C = T\downarrow_{ref}$ $Q\downarrow H = T\downarrow C / T\downarrow H \cdot P / \eta = W / COP$

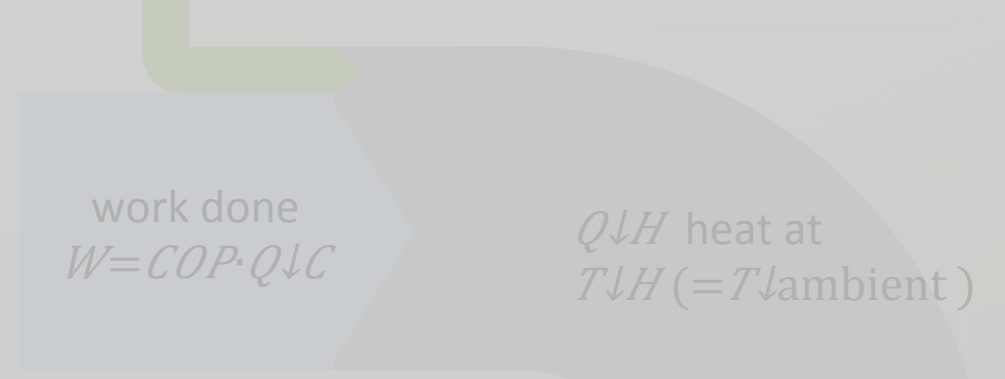

COP : Coefficient of performance
 $COP \geq T\downarrow H / T\downarrow C - 1$ (Carnot limit)

Can we recover the heat?

the quality of power

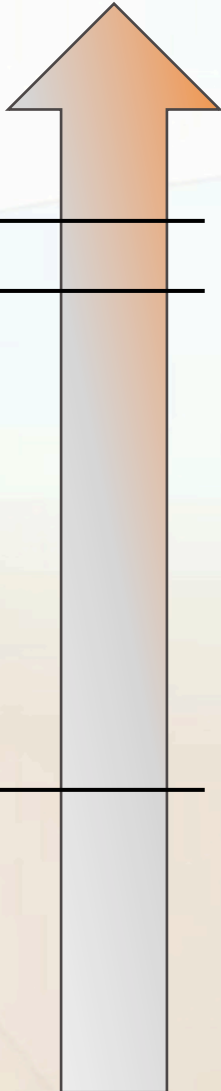

- In principle, heat engine could be used to produce work.

- Limit: Carnot efficiency! With $T_{\downarrow C} = T_{\downarrow ambient} = 20^{\circ}\text{C}$: $\eta_{Carnot} = 1 - T_{\downarrow C} / T_{\downarrow H}$
- $T_{\downarrow H} = 40^{\circ}\text{C}$: Carnot efficiency 6.8%
- $T_{\downarrow H} = 200^{\circ}\text{C}$: Carnot efficiency 38%
- It is more interesting to recover heat at high T !

- Heat could be converted to higher T heat with a heat pump:

- E.g.: 10 kW heat pump could pump 40 kW of heat from 40°C to 50 kW at 80°C (for heating at 80°C).
 $COP = 5 \leq 7.8 = T_{\downarrow C} / \Delta T$

- Heat could be used directly for heating:

- recovered at 50°C to 80°C : district heating

- recovered at 25°C to 50°C : green houses, food production

Example: low T heat recovery for fish farming



An increase in water temperature from 8.6°C to 13.7°C doubled the growth rate in salmon smolt

BY B.Fyhn Terjesen, Nofima

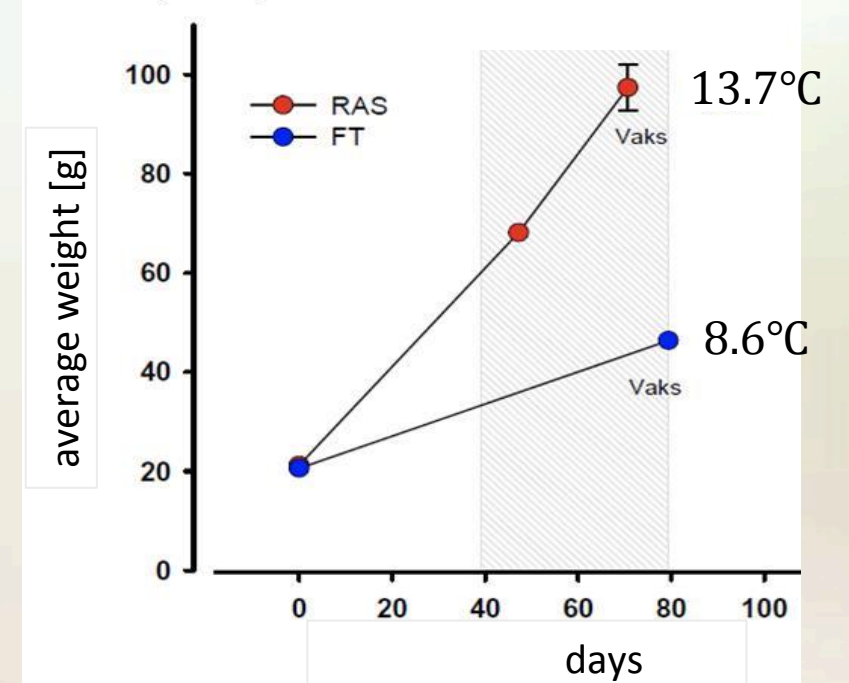

A Kiessling, Institute of Marine Research, Matredal, NO



Optimizing magnets

Why do they need power at all?

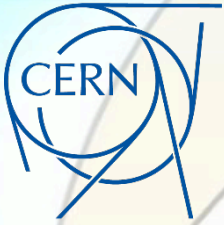

Low-power accelerator magnets



Magnet type	Advantage	Disadvantage
permanent magnet	No power required, reliable, compact	Tuneability difficult, aperture size limited, radiation damage
Optimized electromagnet	Low power, less cooling (and less vibration)	Larger size, cost
Pulsed magnet	Low average power, less cooling, high fields	Complexity of magnet and circuit, field errors
Superconducting magnet	No ohmic losses, higher field	Cost, complexity, cryo installation
High saturation materials	Lower power, compactness and weight	Cost, limited gain

2014 workshop on Special Compact and Low Consumption Magnet Design:
indico.cern.ch/event/321880/

Example: Permanent Magnet Quadrupole Design for CLIC

- **NdFeB** magnets with $B_r = 1.37 \text{ T}$
- 4 permanent magnet blocks
- gradient = $(15.0 \dots 60.4) \text{ T/m}$, stroke = $(0 \dots 64)$
- Pole gap = 27.2 mm
- Field quality = $\pm 0.1\%$ over 23 mm

Stroke = $(0 \dots 64) \text{ mm}$

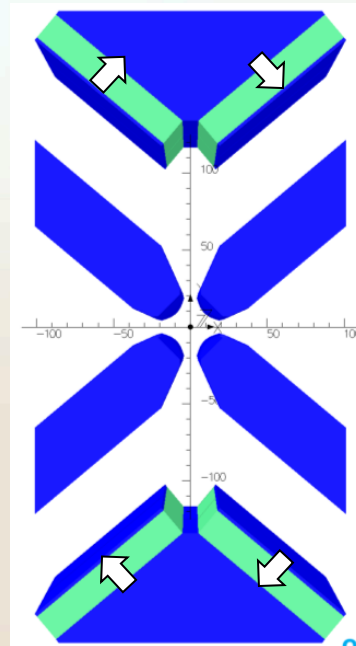
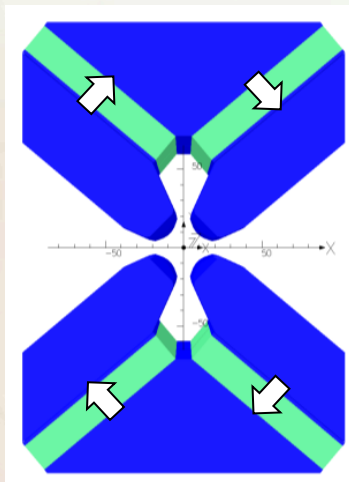

Tuneable high-gradient permanent magnet quadrupoles, B.J.A. Shepherd *et al* 2014 *JINST* 9 T11006

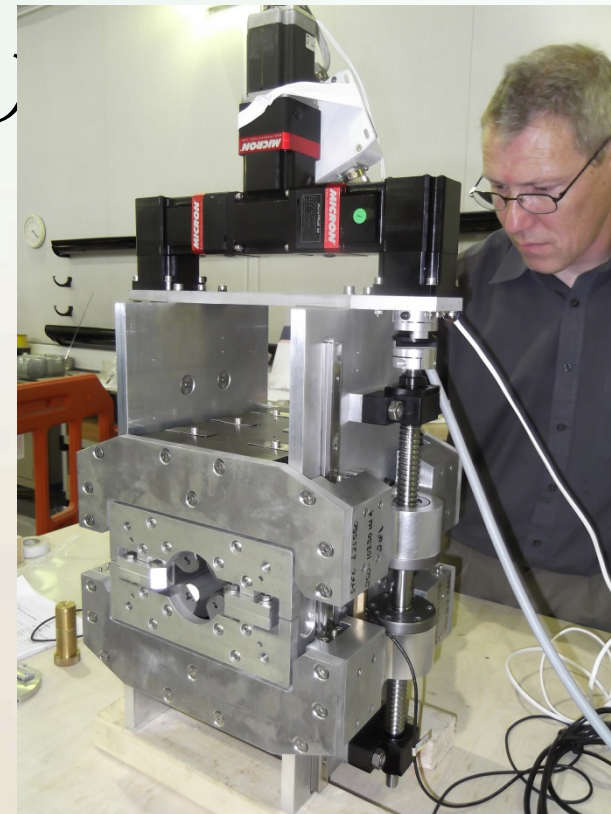

B. Shepard/STFC

Pulsed Quadrupole Magnet

	Prototype Quadrupole
Gradient	80 T/m
Length	0.65 m
Pulse length	90 μ s (beam 1 μ s)
Peak current	400 kA (35 kA)
Peak voltage	17 kV (5 kV)
Energy @17 kV	65 kJ (5.6 kJ)
Inductivity	535 nH
Capacitor	450 μ F
Forces	200 kN

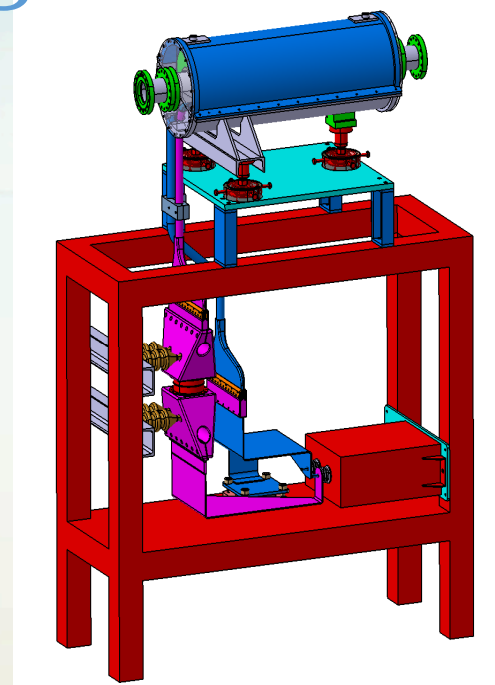

Engineering model of the prototype quadrupole magnet incl. support

- low average power; energy recovery in capacitive storage possible for periodic operation; high field
- complexity added by pulsing circuit; field precision potentially challenging

P. Spiller/GSI



RF power generation

The power to accelerate

Average RF power needs

Future large scale accelerators

circular

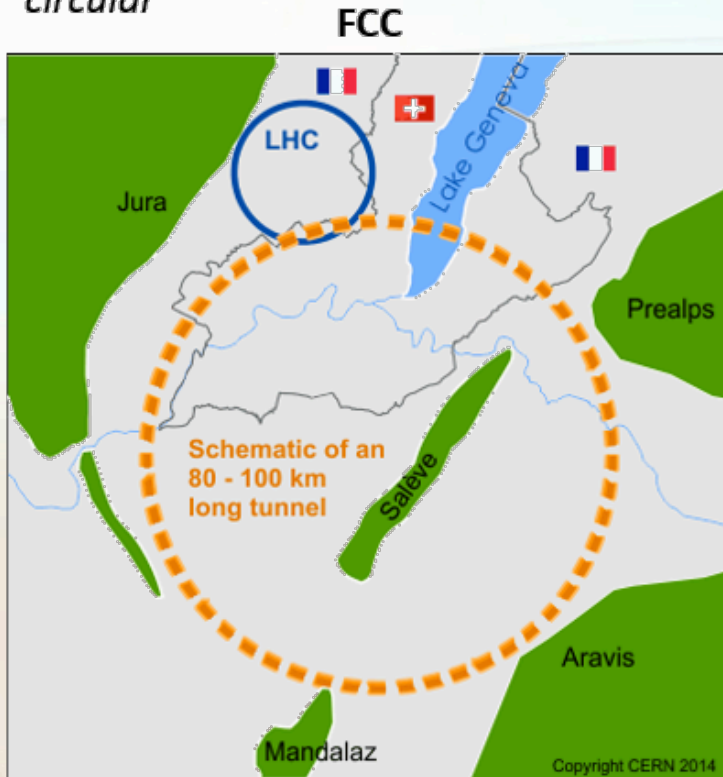

linear

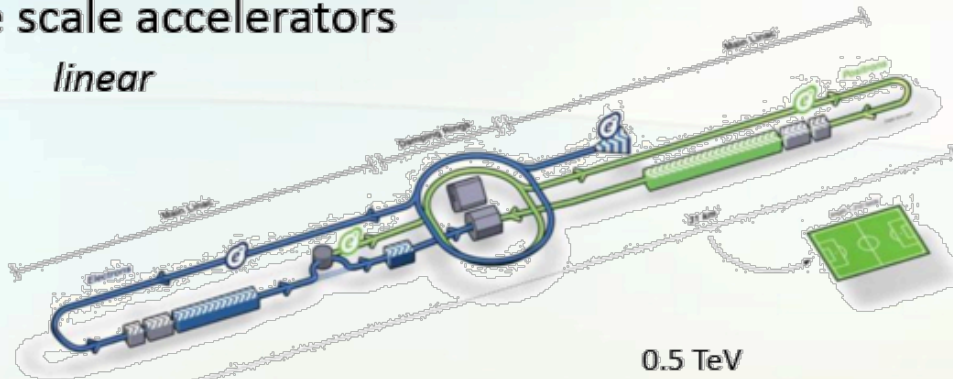

ILC e^+e^- : Pulsed, 1.3 GHz, P_{RF} total = **88 MW**

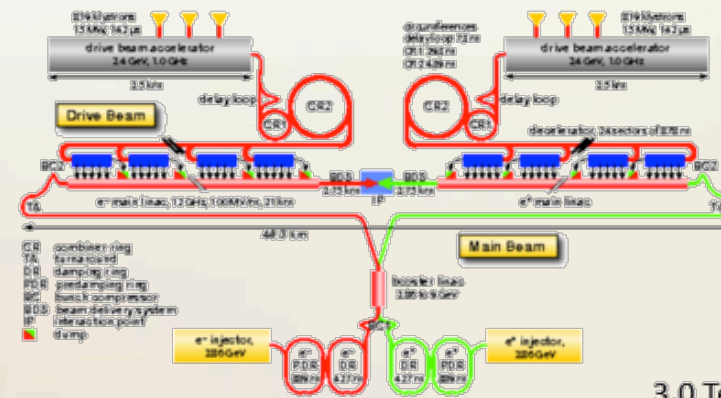

FCC-ee: CW, 400 MHz/0.8 GHz, P_{RF} total = **110 MW**

CLIC: Pulsed, 1 GHz, P_{RF} total = **180 MW**

Pulsed, 0.7 GHz, **92 MW**



Example FCC-*tt*: orders of magnitude

Note: largest impact by RF power generation

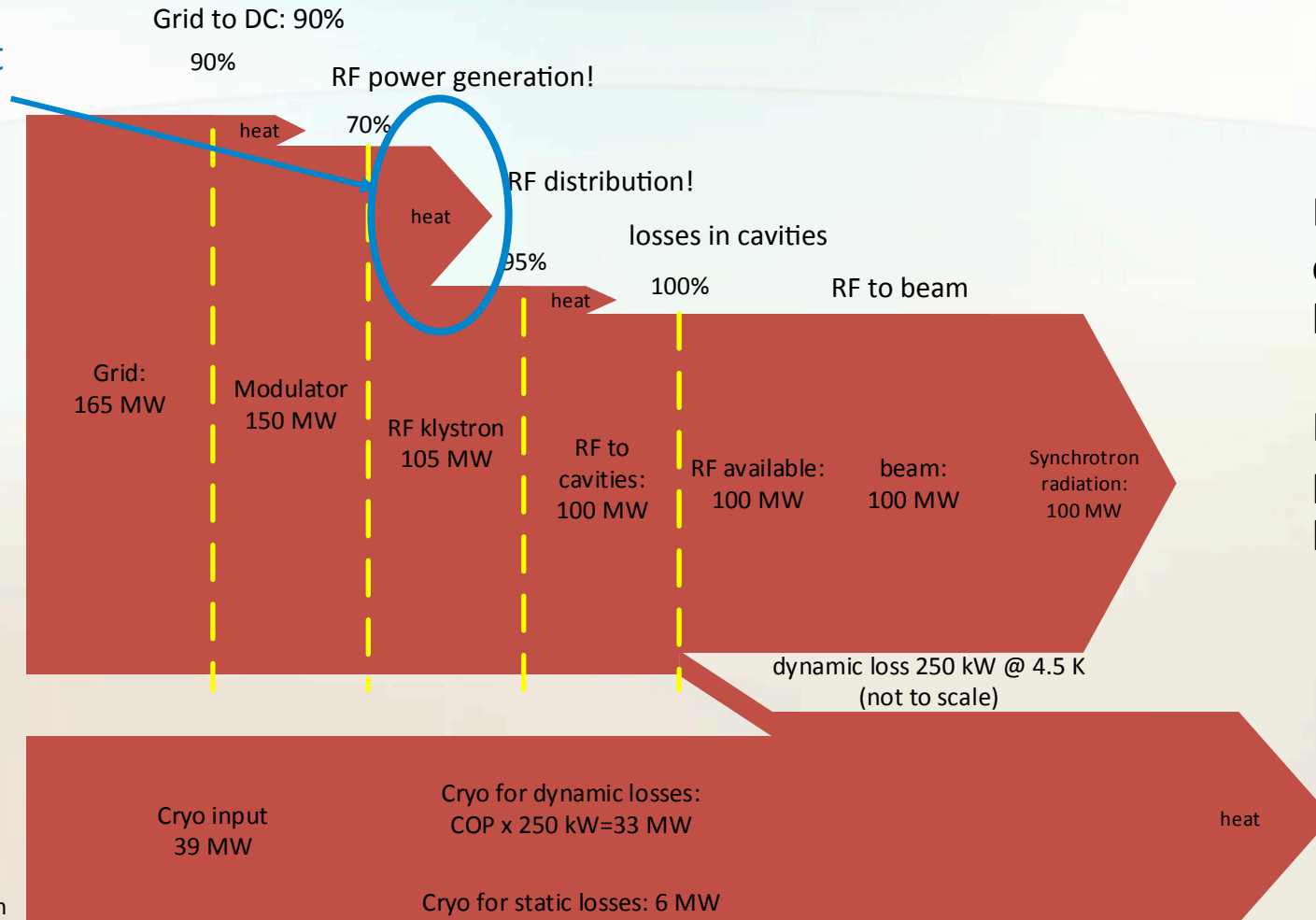

Eventually, all is converted to waste heat!

Figure of merit: physics results per kWh!



69% instead of 70% - what does this mean?



- I had assumed above: 70% efficiency for RF power generation.
- With 105 MW RF output and at 70% efficiency, this means that **1 percentage point less** means
 - Input power up from 150 MW to 152.2 MW, waste heat up from 45 MW to 47.2 MW.
 - 2.2 MW more electricity consumed (assuming 5000 h and 40 €/MWh: 10 GWh/year or 400 k€/year)
 - 2.2 MW more heat produced and wasted in the environment.
 - The electrical installation has to be larger by 1.45%!
 - The cooling and ventilation has to be larger by 4.8%!
- All the above are significant!
- Work on increasing the useable efficiency is worth every penny/cent invested!

How does a klystron work?

- A continuous electron beam is accelerated by a DC voltage and guided by magnets,
- A small power RF input causes an RF voltage in the input gap, where the velocity of the electrons will be modulated with the RF.
- Passing through a subsequent drift tube, this velocity modulation will lead to density modulation (bunching).
- The density modulation causes an RF component of the current which will excite large power in the output gap.
- With just input cavity and output cavity, the maximum possible efficiency of a klystron is 58%.
- Additional cavities (near the operation f and possibly at harmonics) will help the bunching process.
- The best efficiency reached this way is around 70%.
- Space charge effects limit the efficiency – they can be reduced using many small beams rather than one big (Multi-beam klystron – MBK)

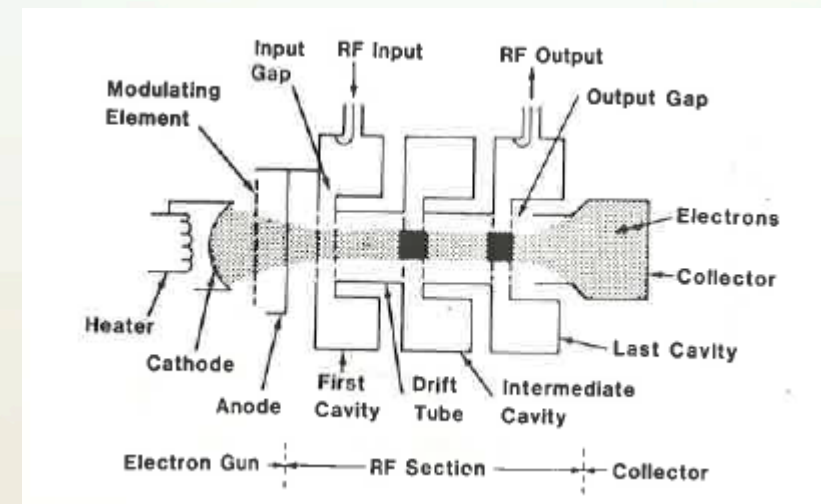

From A.S. Gilmour, Jr. "Microwave Tubes", Artech House 1986, who took this from Microwave Tube Manual by Varian Associates, Air Force Publication Number T. 0.00-25-251, 1979

MBK developments for CLIC

Frequency: 1 GHz
 Peak power: 20 MW
 Pulse length: 150 μ sec
 Rep. rate: 50 Hz
 Efficiency: >67%

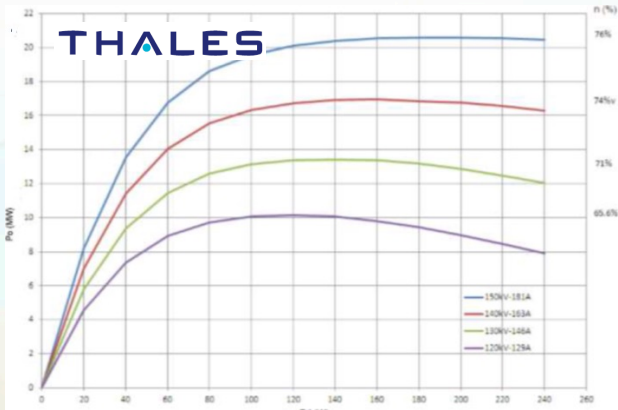

Simulated klystron efficiency vs. perveance

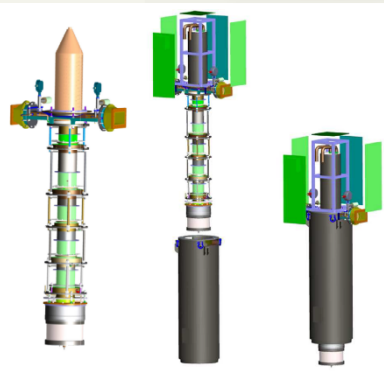
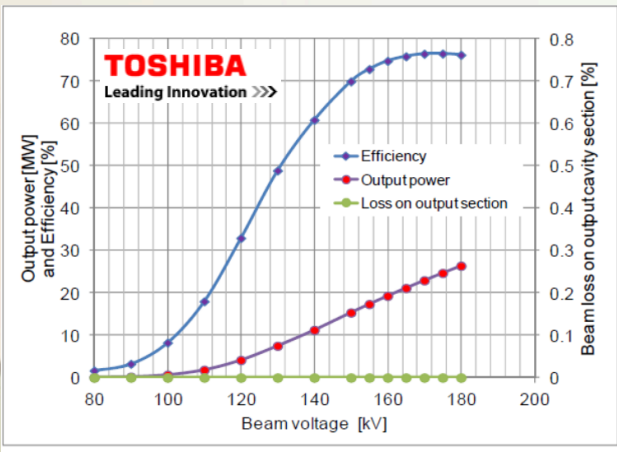
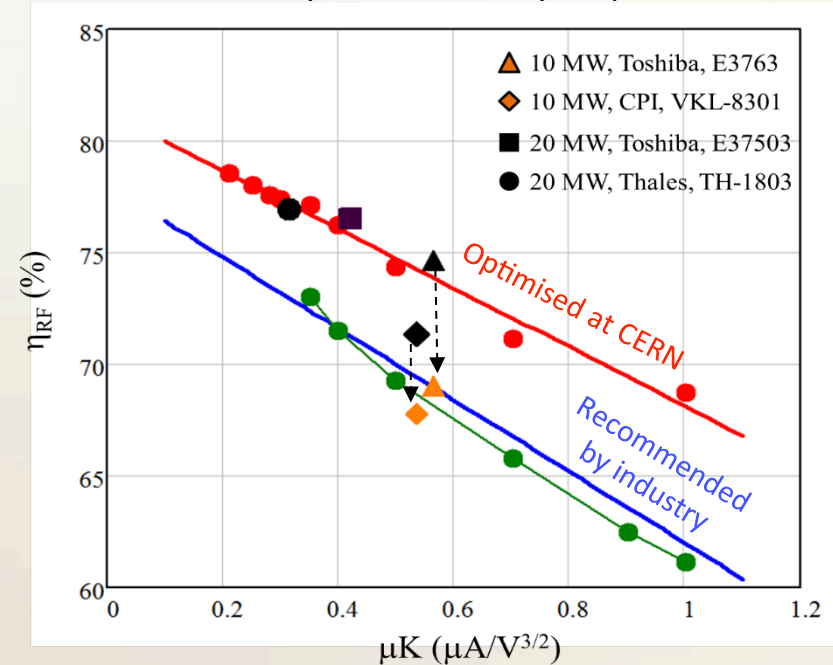

I Syratchev/CERN

A promising new concept (2013)

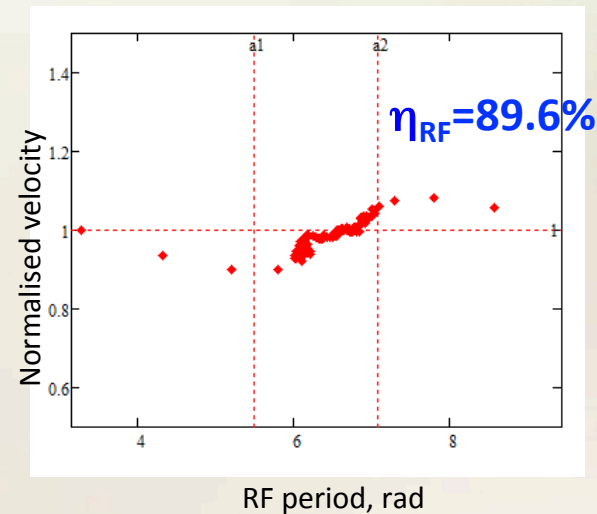
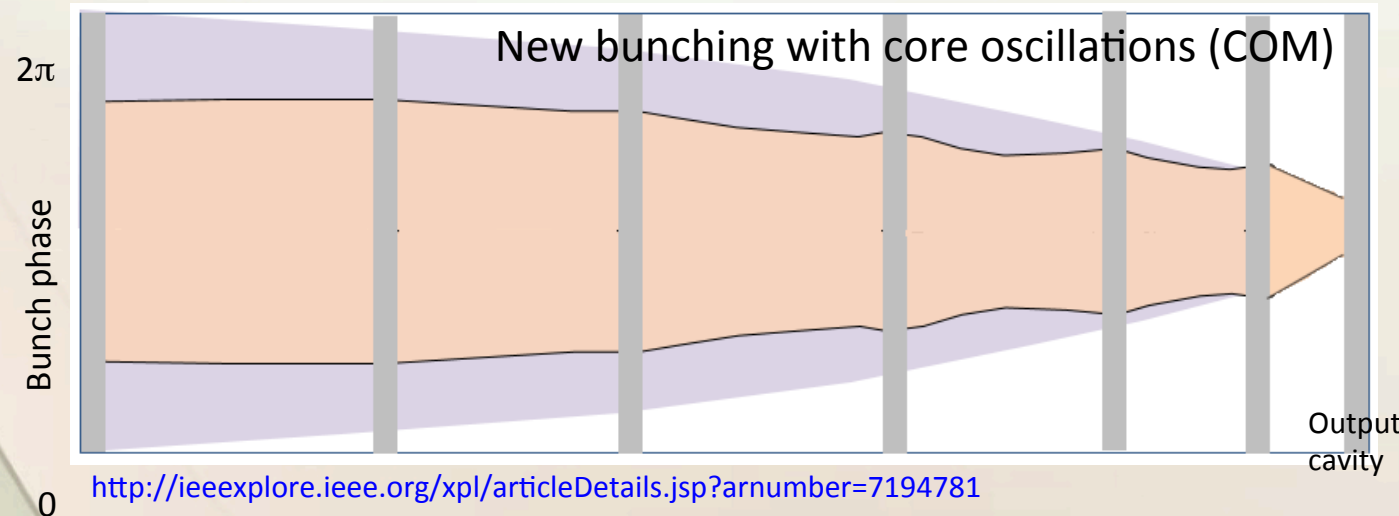
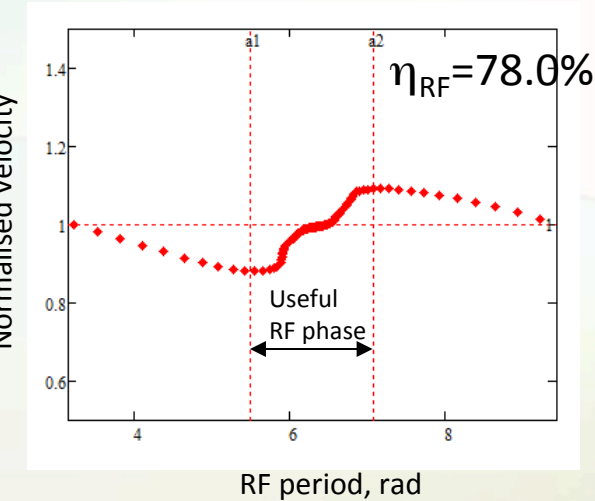
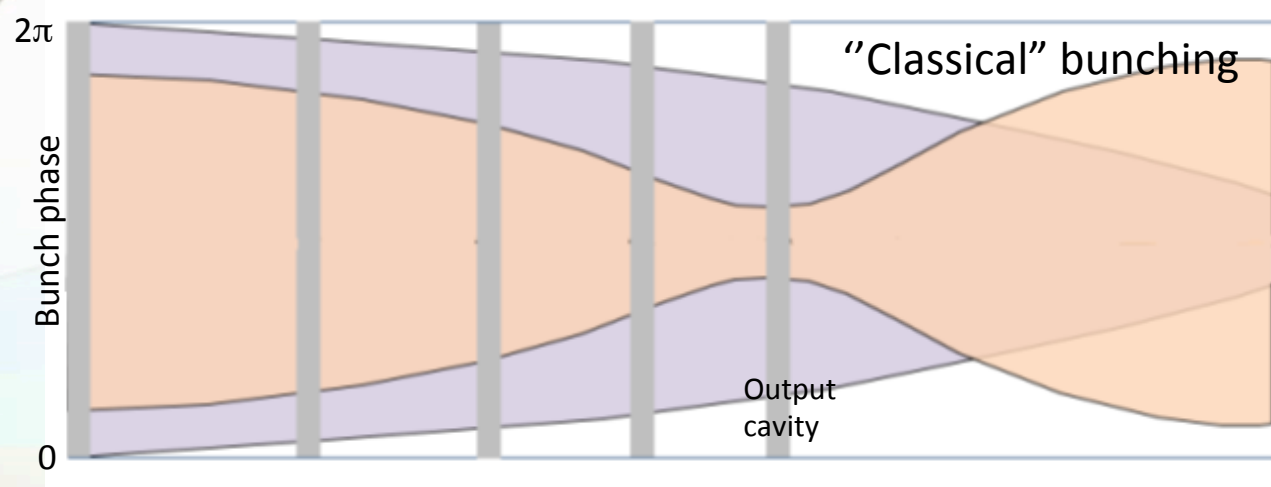

<http://ieeexplore.ieee.org/xpl/articleDetails.jsp?arnumber=7194781>

I Syratchev/CERN

Comparison of the two bunching methods

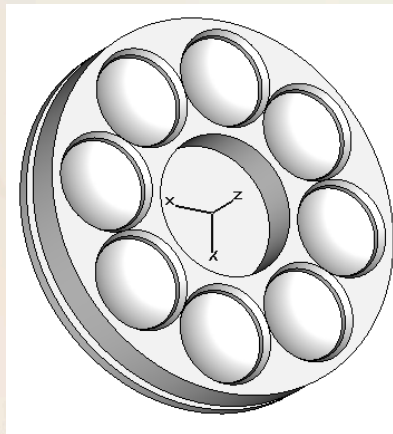
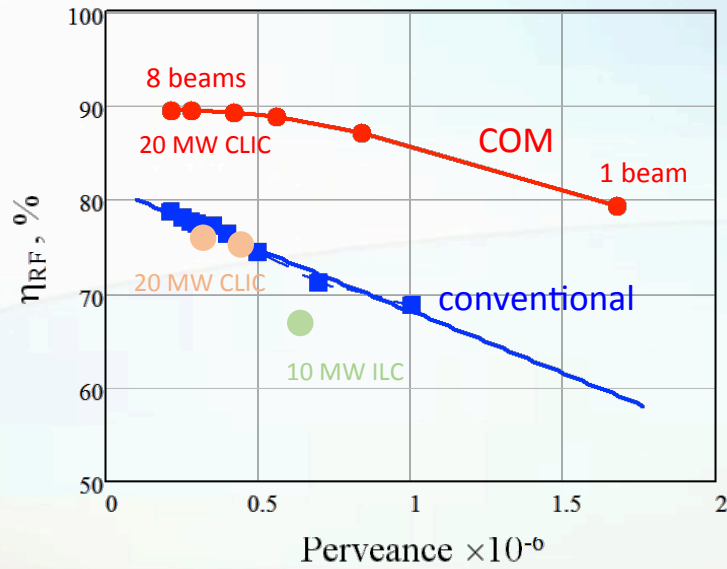

N beams = 8
 V = 180 kV
 I total = 128 A

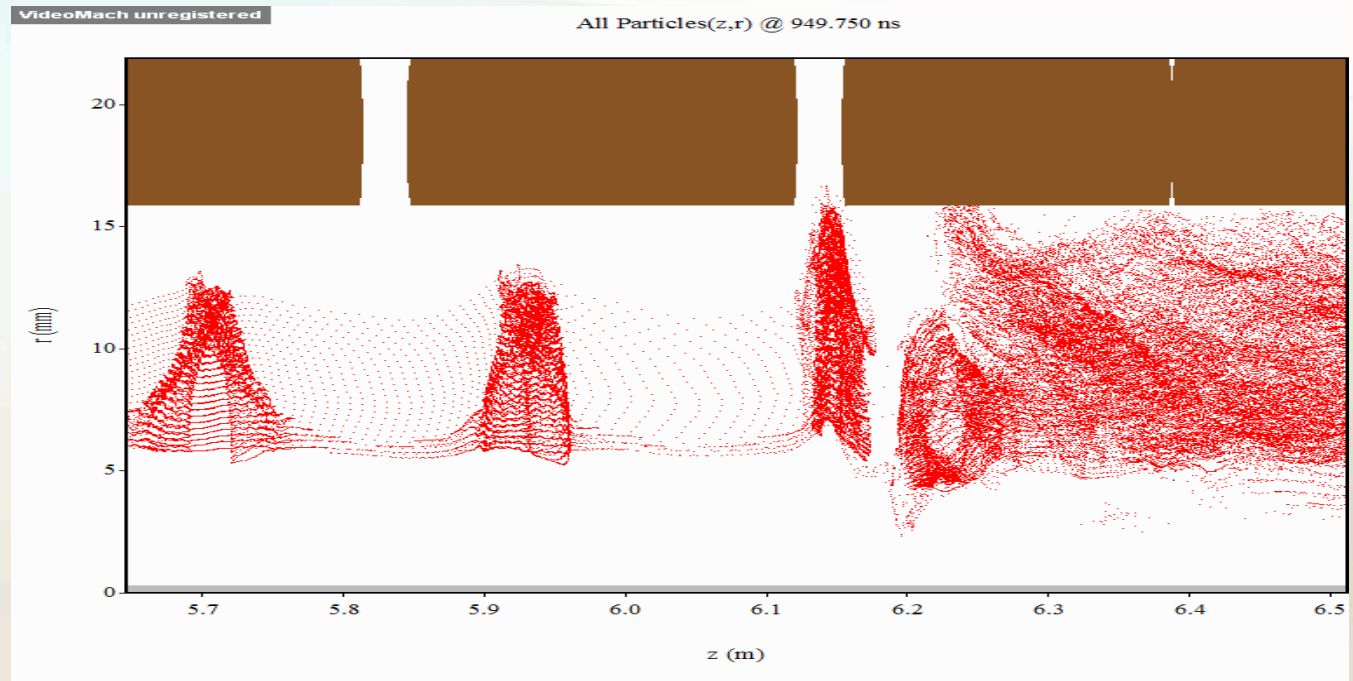

RF extraction efficiency: **86.6%**;

I Syratcev/CERN, D. Constable, C. Lingwood/U Lancaster, 2015

RF power generators - efficiencies

	Tetrodes	IOTs (Inductive Output Tubes)	Conventional klystrons	Solid State PA	Magnetrons
f range:	DC – 400 MHz	(200 – 1500) MHz	300 MHz – 1 GHz	DC – 20 GHz	GHz range
P class (CW):	1 MW	1.2 MW	1.5 MW	1 kW @ low f	< 1MW
typical η :	85% - 90% (class C)	70%	50%	60%	90%
Remark	Broadcast technology, widely discontinued		new idea promises significant increase	Requires P combination of thousands!	Oscillator, not amplifier!



Thales RS 1084 CJ
< 30 MHz, 75 kW
 $\eta < 78\%$ (class B)

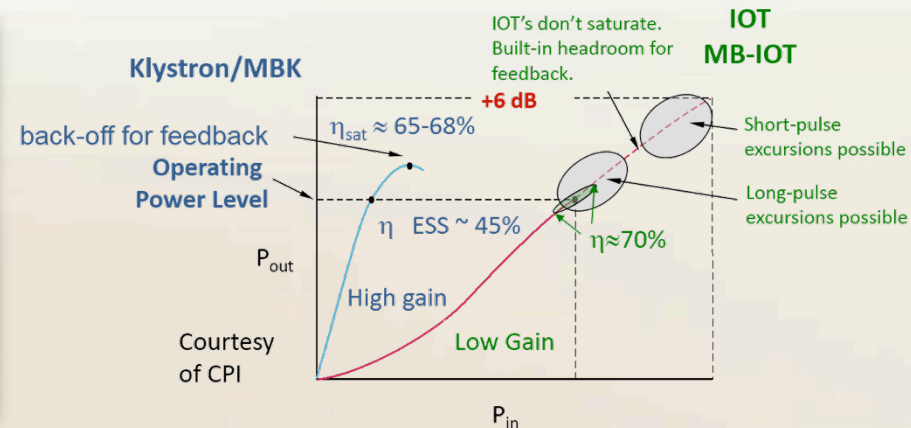

M. Jensen: EnEfficient RF Sources, 2014, Daresbury

CAS FEL&ERL Hamburg - Erk Jensen: Energy Efficiency

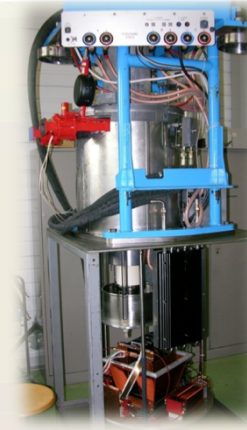

CTF3 klystron
3 GHz, 45 MW, 4.5 μ s, 50 Hz, $\eta \approx 45\%$

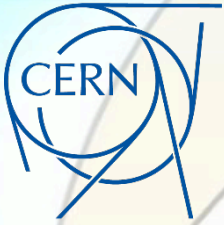

Conversion RF power \rightarrow beam

A trade-off between accelerating gradient and efficiency

Cavity parameters: Wall losses &

$Q \downarrow 10$

- The losses P_{loss} are proportional to the stored energy W .
- The tangential H on the surface is linked to a surface current $J_{\downarrow A} = n \times H$ (flowing in the skin depth δ).
- This surface current $J_{\downarrow A}$ sees a surface resistance $R_{\downarrow s}$, resulting in a local power density $R_{\downarrow s} |H_{\downarrow t}|^2$ flowing into the wall.
- $R_{\downarrow s}$ is related to skin depth δ as $\delta \sigma R_{\downarrow s} = 1$.
 - Cu at 300 K has $\sigma \approx 5.8 \cdot 10^{17} \text{ S/m}$, leading to $R_{\downarrow s} \approx 8 \text{ m}\Omega$ at 1 GHz, scaling with $\sqrt{\omega}$.
 - Nb at 2 K has a typical $R_{\downarrow s} \approx 10 \text{ n}\Omega$ at 1 GHz, scaling with $\omega^{1/2}$.
- The total wall losses result from $P_{loss} = \iint_{\text{wall}} R_{\downarrow s} |H_{\downarrow t}|^2$





Shunt impedance



- The square of the acceleration voltage is proportional to the power loss P_{loss} .
- The proportionality constant defines the “shunt impedance”

$$R = |V_{acc}|^2 / 2 P_{loss} .$$

- **Attention, also here different definitions are used!**
(Rama Calaga used a different definition yesterday!)
- Traditionally, the shunt impedance is the quantity to optimize in order to minimize the power required for a given gap voltage.

Cavity Resonator – equivalent circuit

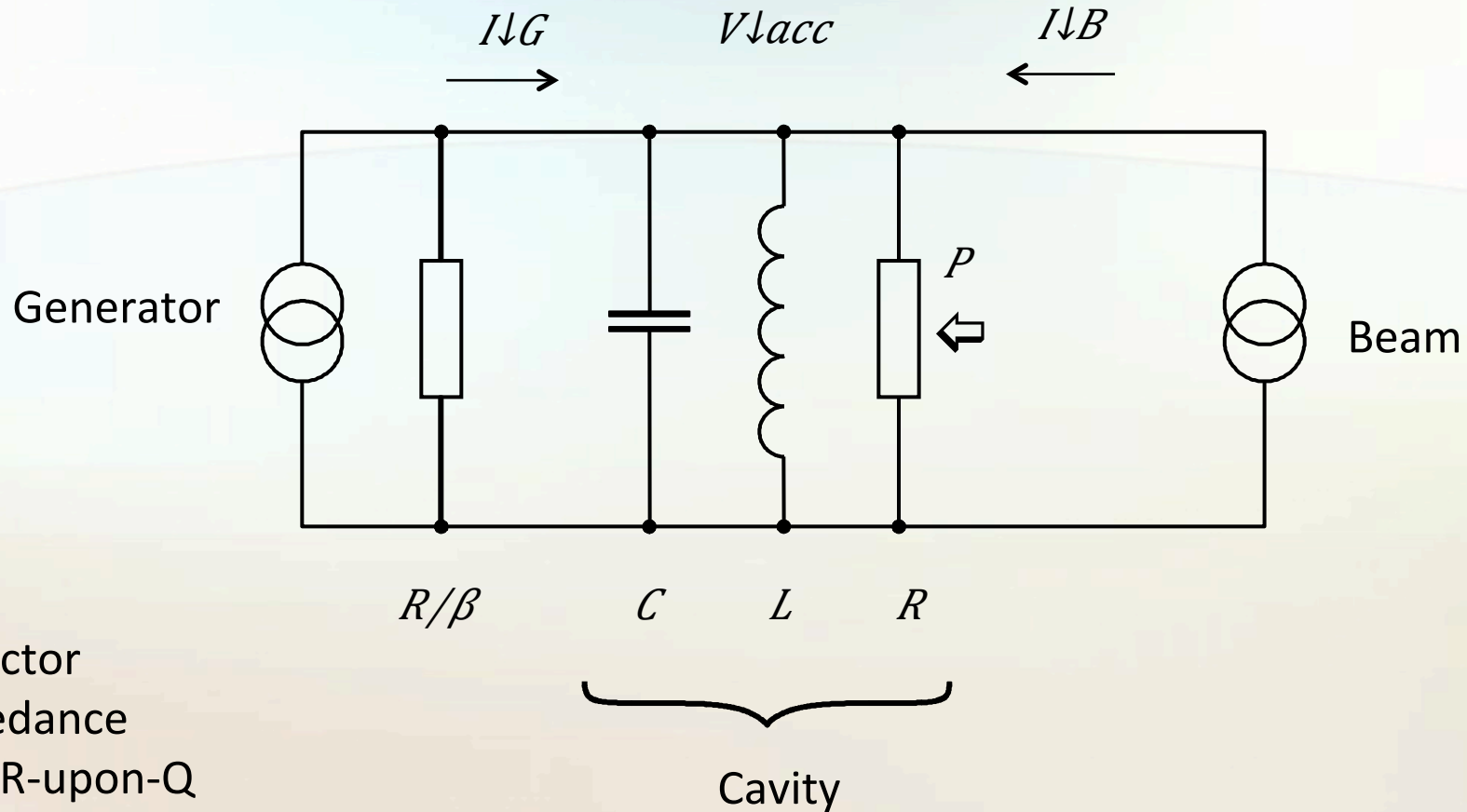

β : coupling factor
 R : shunt impedance
 $\sqrt{L/C} = R/Q$: R-upon-Q

Matching a source to a load

- An ideal voltage source with $V \ll 0$ in series with an inner resistance $R \ll i$ is equivalent to an ideal current source with $I \ll 0 = V \ll 0 / R \ll i$ in parallel to an inner resistance $R \ll i$.
- The available power from this equivalent source is $P \ll avail = V \ll 0 \uparrow 2 / 4 R \ll i = I \ll 0 \uparrow 2 R \ll i / 4$.
- When connecting this equivalent source to a real load $R = r \cdot R \ll i$, the power transferred to the load varies as function of r as $P = 4 r / (1 + r) \uparrow 2 P \ll avail$.
- All available power is transferred for $R = R \ll i$; this is called “matching”. Less power will be transferred for a mismatch.
- In RF, this is equivalent to a reflected wave; the mismatch is described with a reflection coefficient.

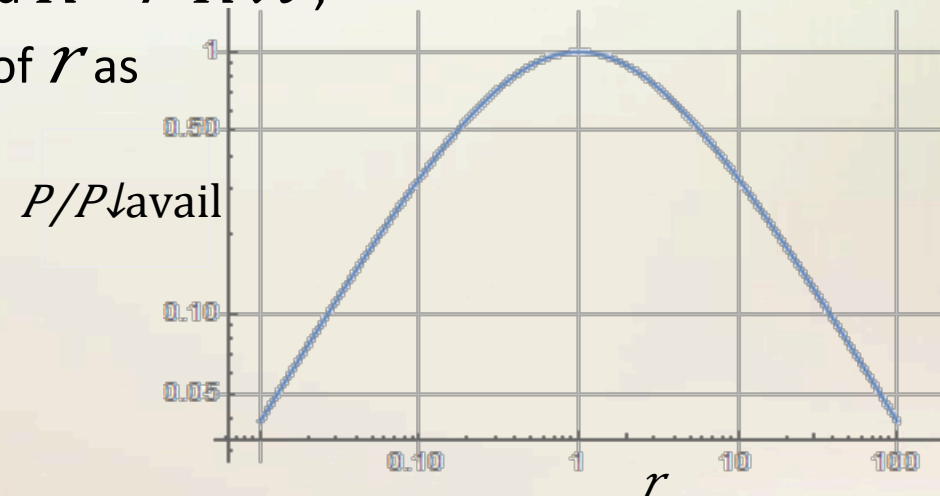
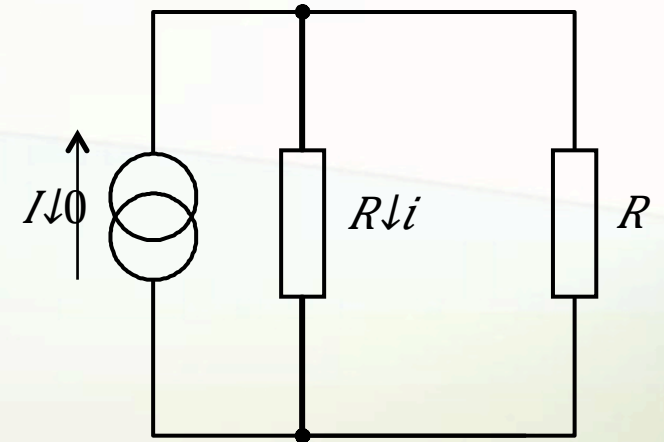

Power coupling - Loaded Q

- Note that the generator inner impedance also loads the cavity – for very large $Q \downarrow 0$ more than the cavity wall losses.

- To calculate the loaded Q ($Q \downarrow L$), losses have to be added:

$$1/Q \downarrow L = P \downarrow loss + P \downarrow ext + \dots / \omega \downarrow 0 \quad W = 1/Q \downarrow 0 + 1/Q \downarrow ext + 1/\dots$$

- The coupling factor β is the ratio $P \downarrow ext / P \downarrow loss$.

- With β , the loaded Q can be written

$$Q \downarrow L = Q \downarrow 0 / 1 + \beta .$$

- For NC cavities, often $\beta = 1$ is chosen (power amplifier matched to empty cavity); for SC cavities, $\beta = 0$ ($10 \uparrow 4 \dots 10 \uparrow 6$).

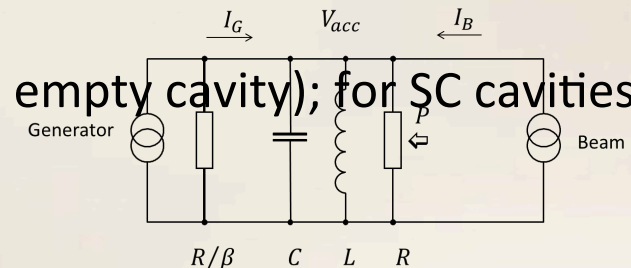

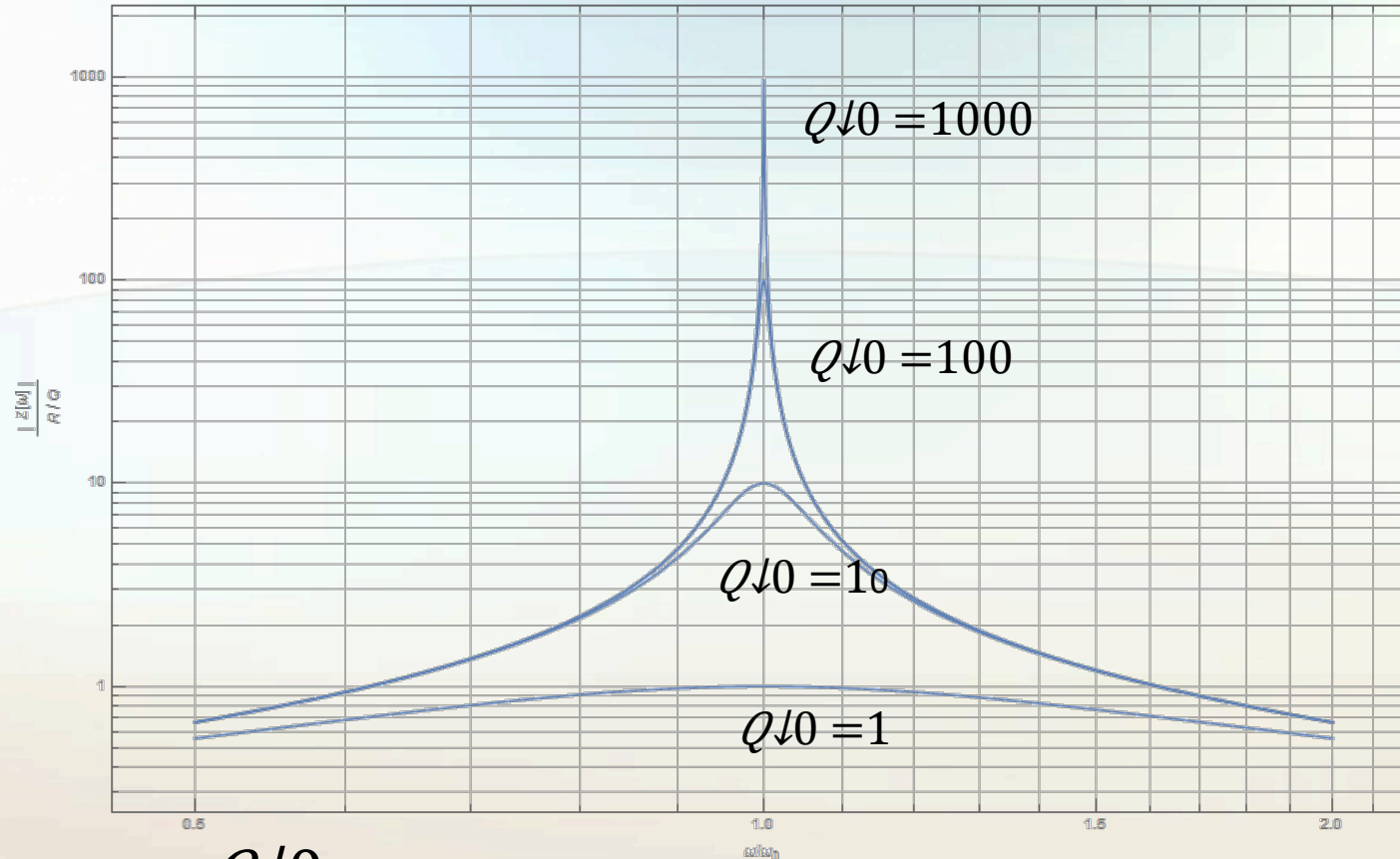

- While a high Q results in small wall losses, so less power is needed for the same voltage.
- On the other hand the bandwidth becomes very narrow.
- Note: a 1 GHz cavity with a Q of 10 has a natural bandwidth of 0.1 Hz!
- ... to make this manageable, Q_{ext} is chosen much smaller!



Beam loading



- The beam current “loads” the cavity, in the equivalent circuit this appears as an impedance in parallel to the shunt impedance.
- If the generator is matched to the unloaded cavity ($\beta=1$), beam loading will (normally) cause the accelerating voltage to decrease.
- The power absorbed by the beam is $-1/2 \Re\{V_{acc} I_B^*\}$.
- For high power transfer efficiency RF \rightarrow beam, beam loading must be high!
- For SC cavities (very large β), the generator is typically matched to the beam impedance!
- Variation in the beam current leads to **transient beam loading**, which requires special care!
- Often the “impedance” the beam presents is strongly reactive – this leads to a detuning of the cavity.

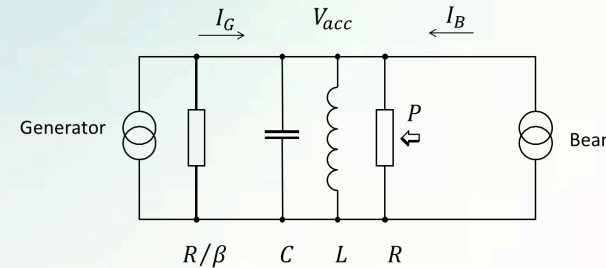

3 GHz Accelerating structure (CTF3)

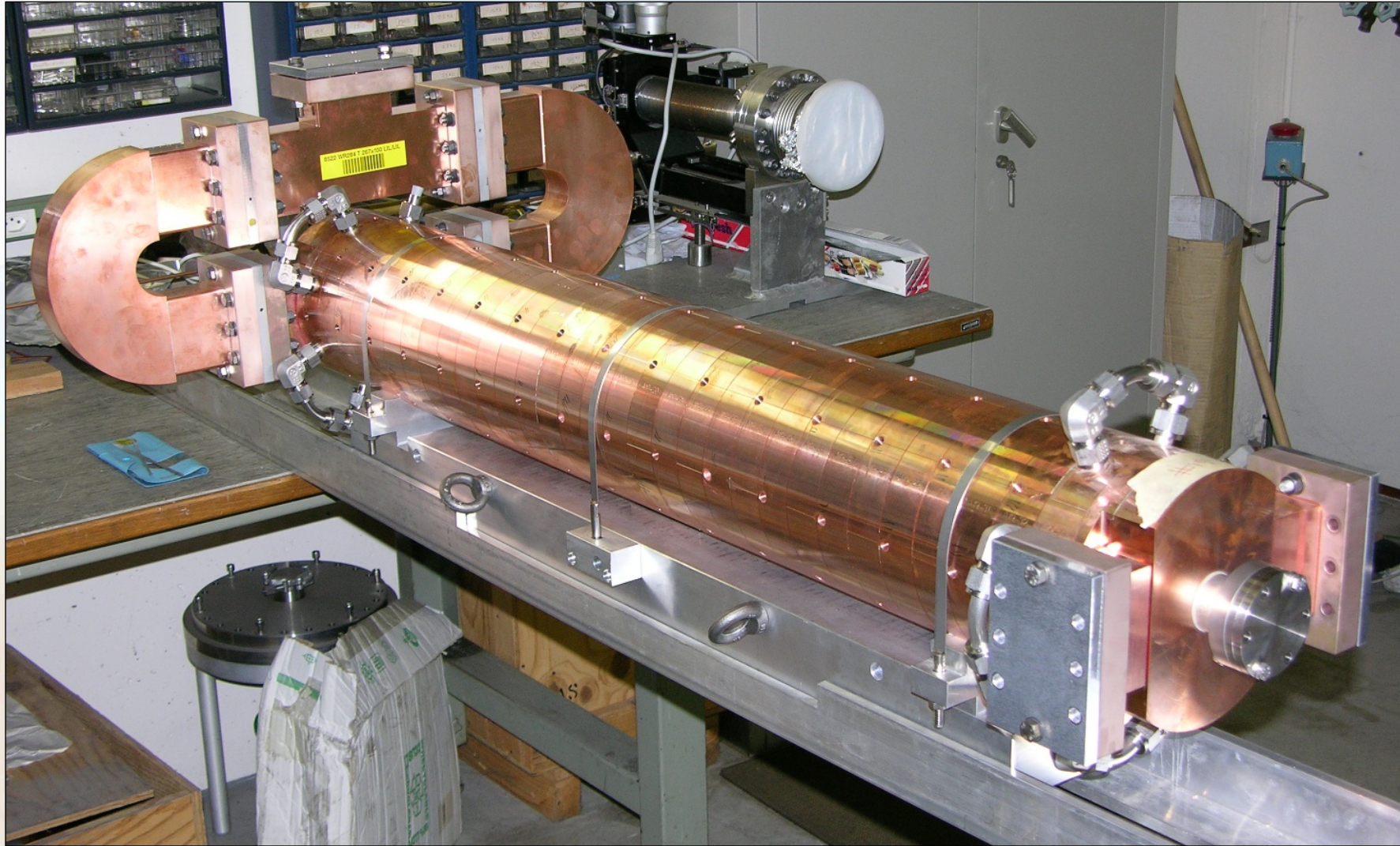

Travelling wave structure

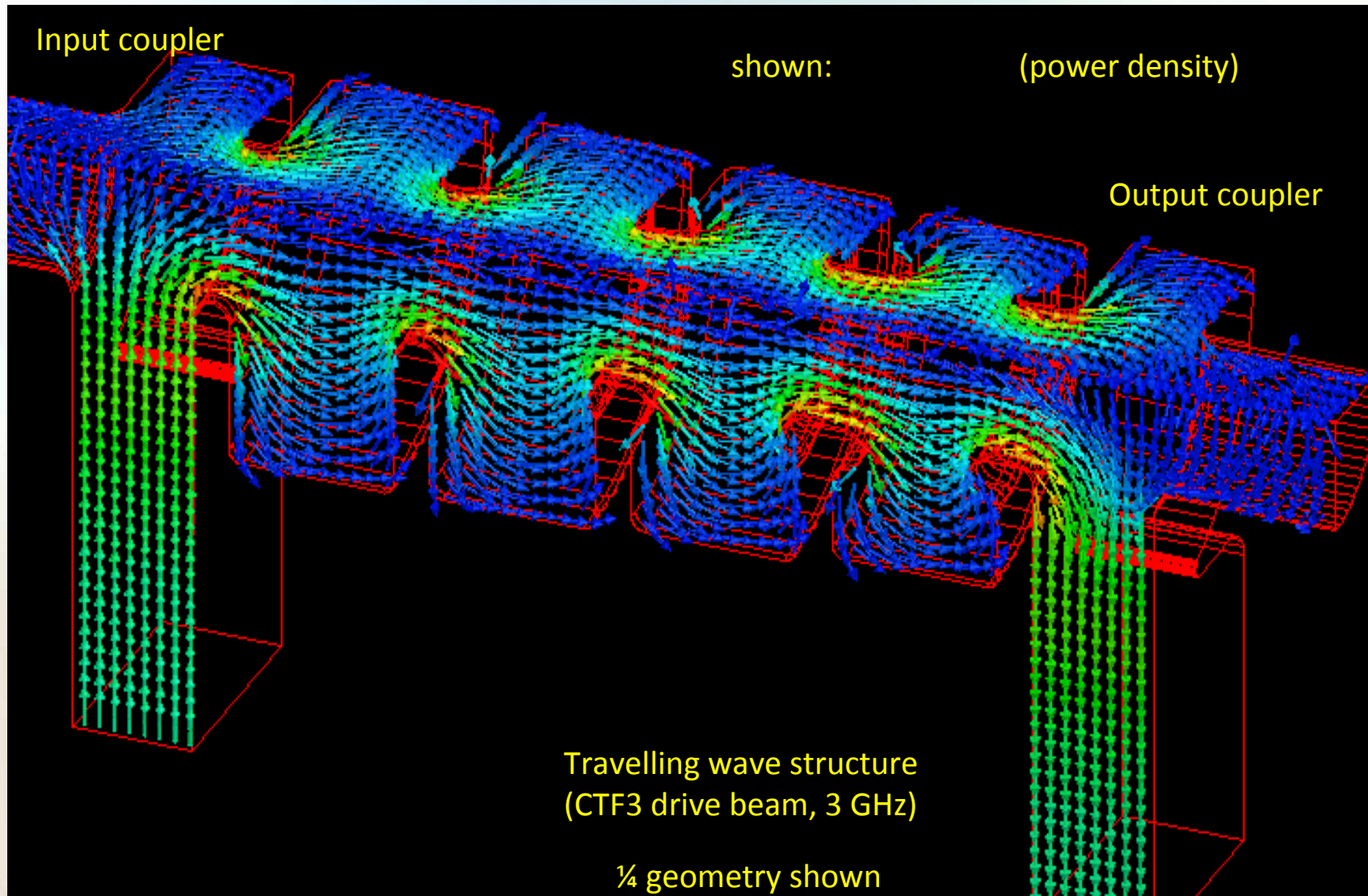



Full beam loading in CTF3 drive beam

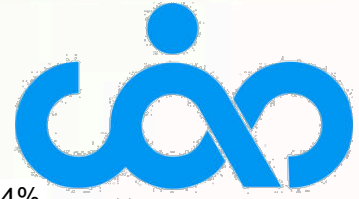

Beam current 4.50 A
Acceleration 6.3 MV

Input power 30 MW
Beam power gain 28.5 MW

Output power 0 MW
Ohmic loss 1.17 MW

η 94.94% @ CERN Accelerator School

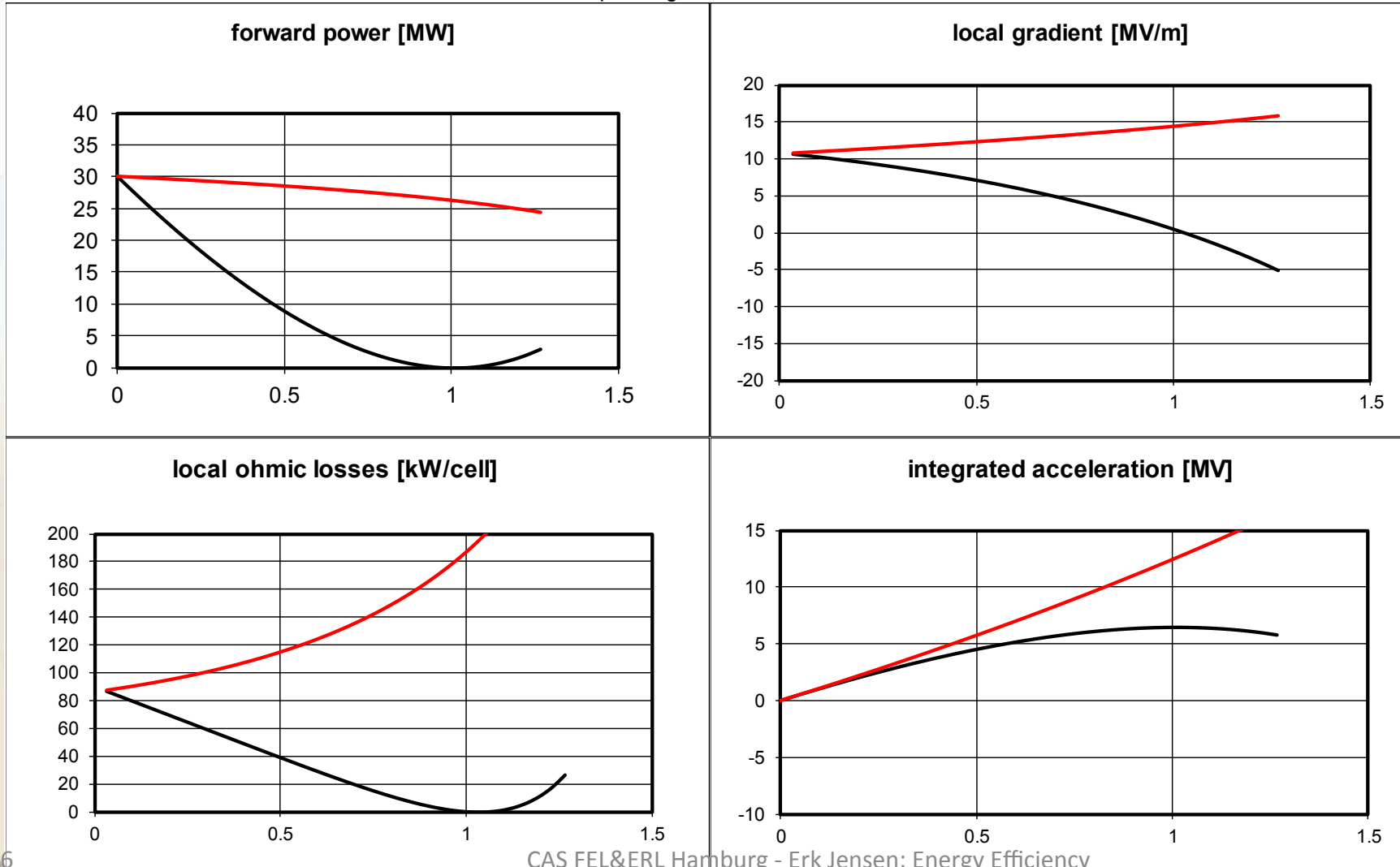

Remember:
power to the
beam is
$$-1/2 \Re\{V \downarrow_{acc} I \downarrow B \uparrow^* \}$$



Compromise: high η vs. high gradient

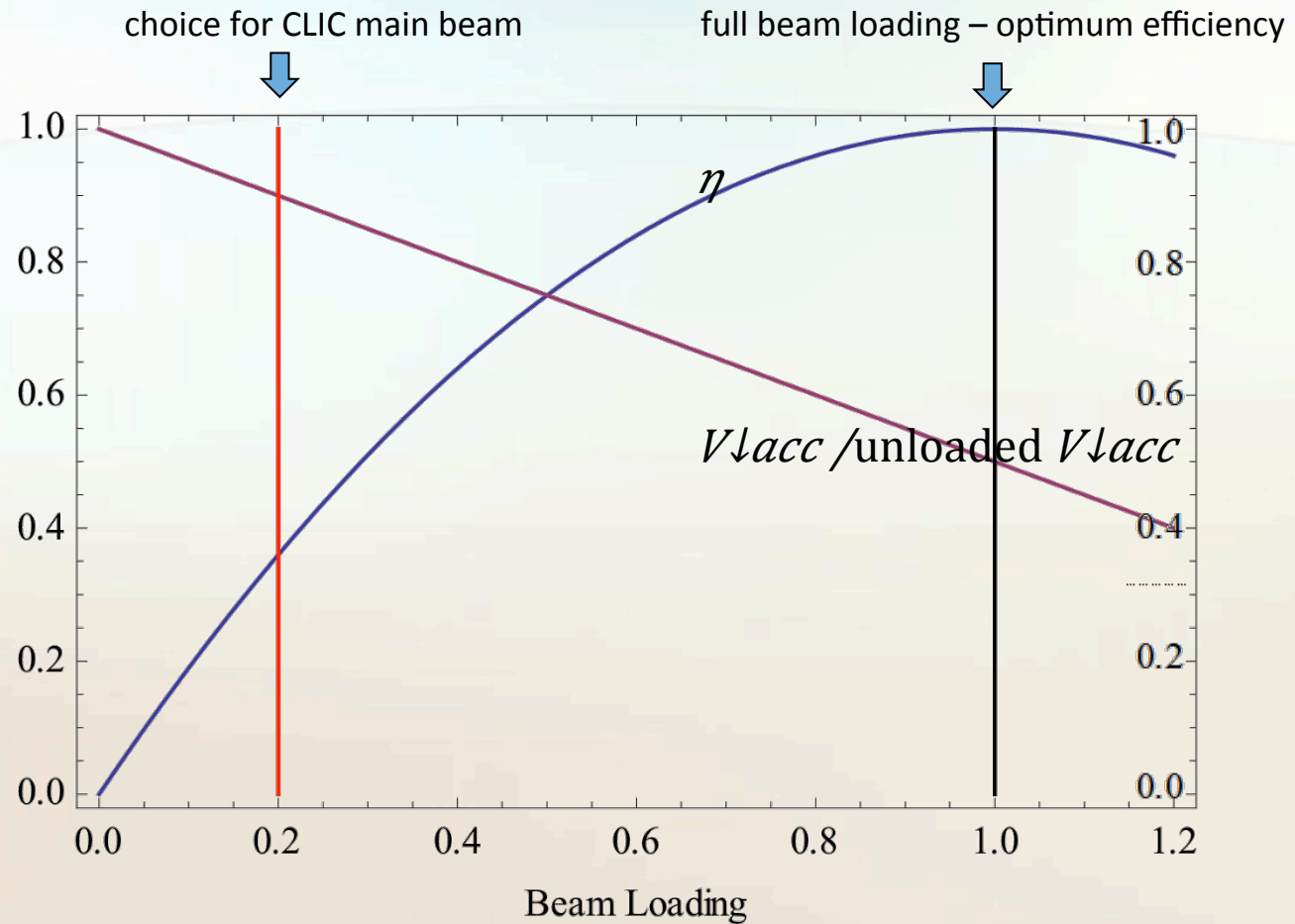

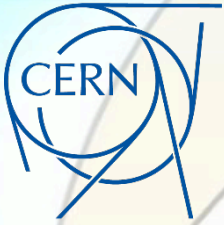

Cryogenic system

How much power do you need to save power?

What about a cryogenic system?

- Heat engine (“steam engine”)

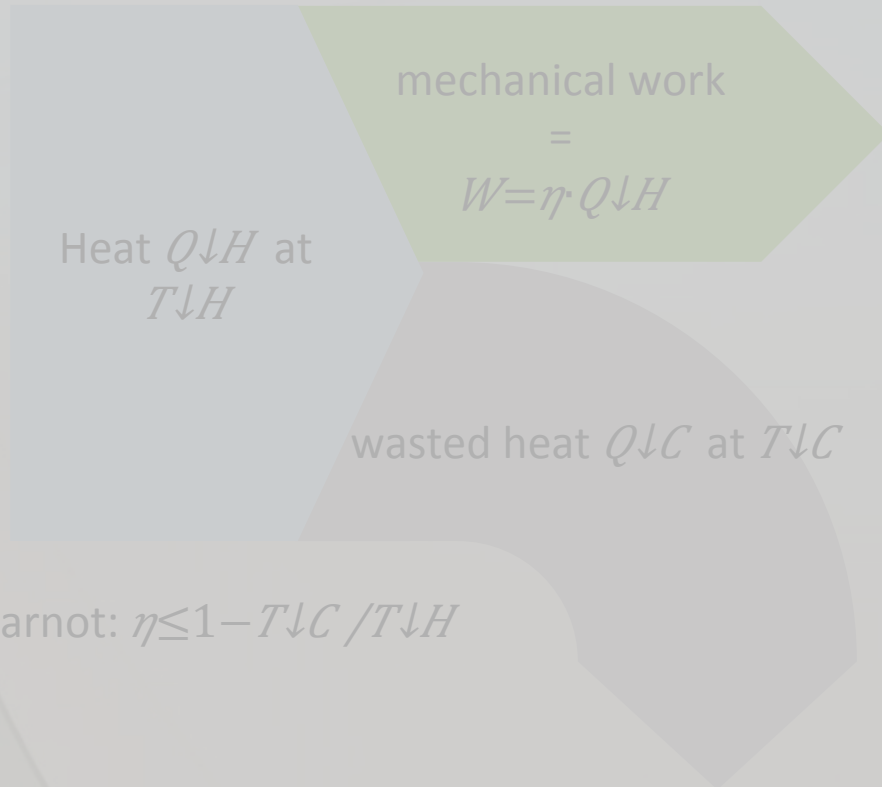

- Reversed: refrigeration system (or heat pump)

cooling, $Q_{\downarrow C}$ at $T_{\downarrow C} = T_{\downarrow \text{ref}}$ $Q_{\downarrow H} = T_{\downarrow C} / T_{\downarrow H} P / \eta = W / COP$

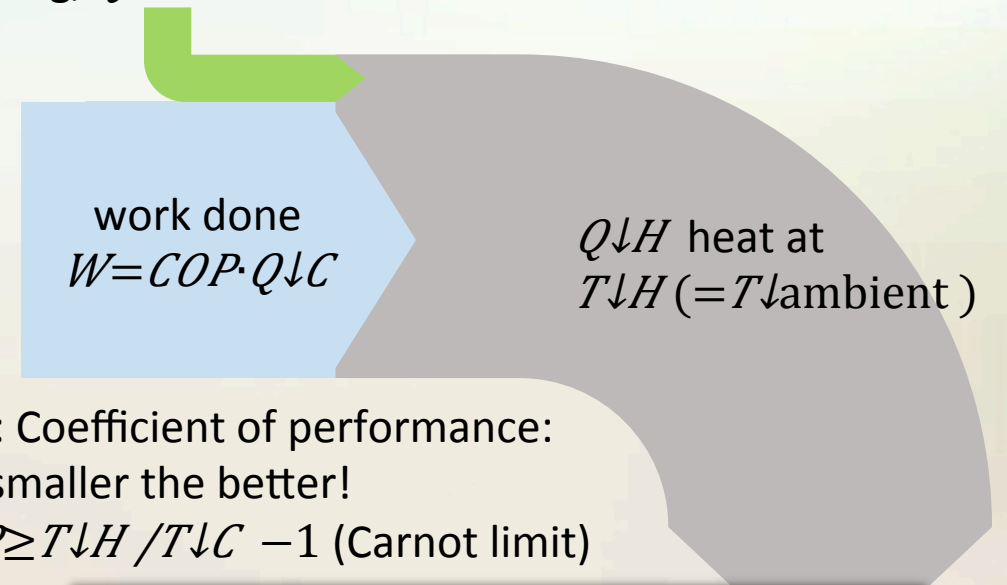

COP: Coefficient of performance:
the smaller the better!
 $COP \geq T_{\downarrow H} / T_{\downarrow C} - 1$ (Carnot limit)

This is the limit when cooling.
small $T_{\downarrow C}$ requires large COP , i.e. large W !

Real COP of cryogenic He refrigeration

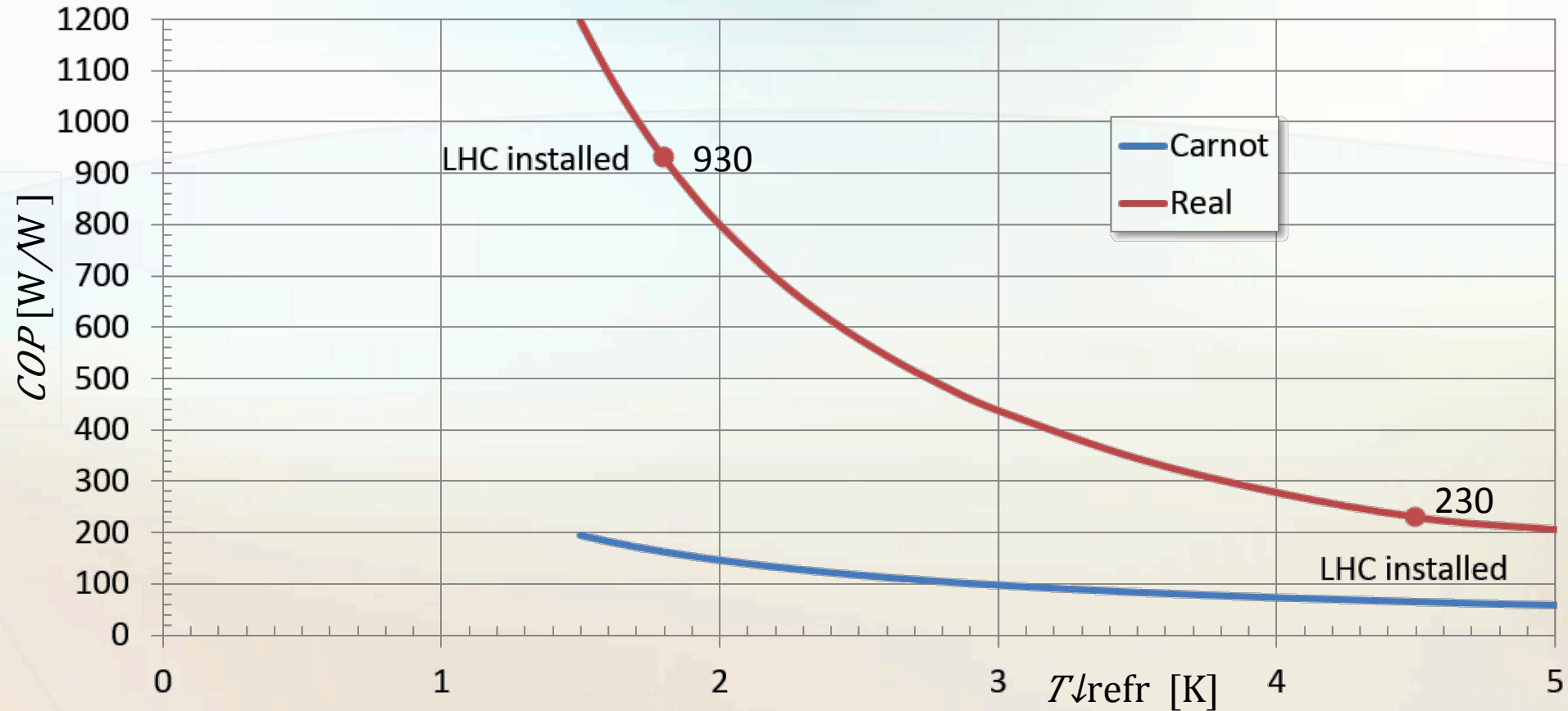

Operating at 1.8 K, the cryoplant requires 4× the energy as at 4.5 K.

At what T to operate a SCRF cavity?

- According to BCS theory (Bardeen-Cooper-Schrieffer, 1957), $Q \downarrow 0$ increases with decreasing T (left plot, Nb $T \downarrow C = 9.3$ K: BCS: blue, with “residual resistance”: red).
- On the other hand, even though the RF losses in SC cavities are very small, they are difficult to extract at low temperature – this is described by the COP (right plot).

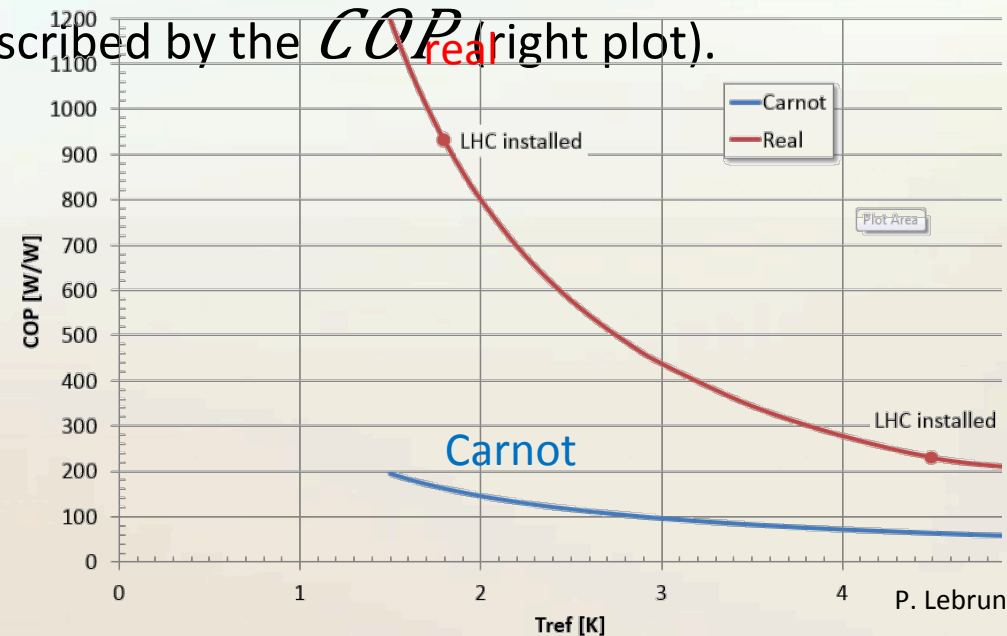
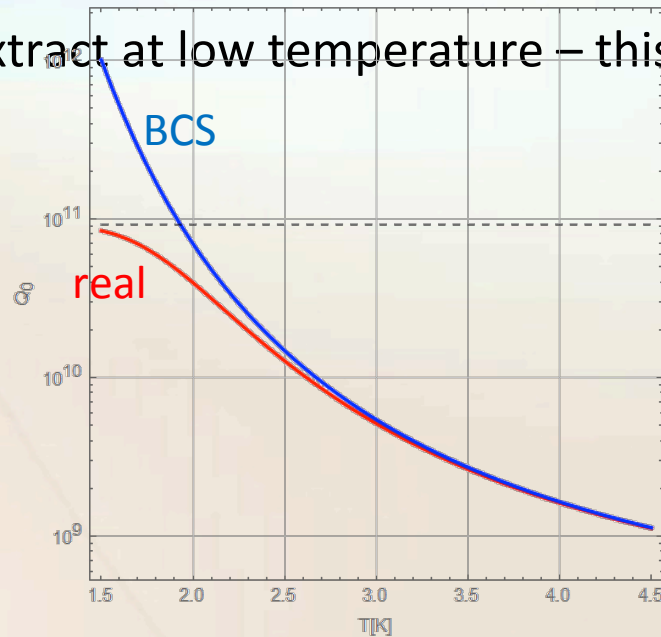

The optimum operating T

- Combining these two curves results in an optimum operating T . This is why it is very interesting to investigate **materials with higher $T \downarrow C$** ! ... and to optimize the technology in order to shift the optimum towards higher T .

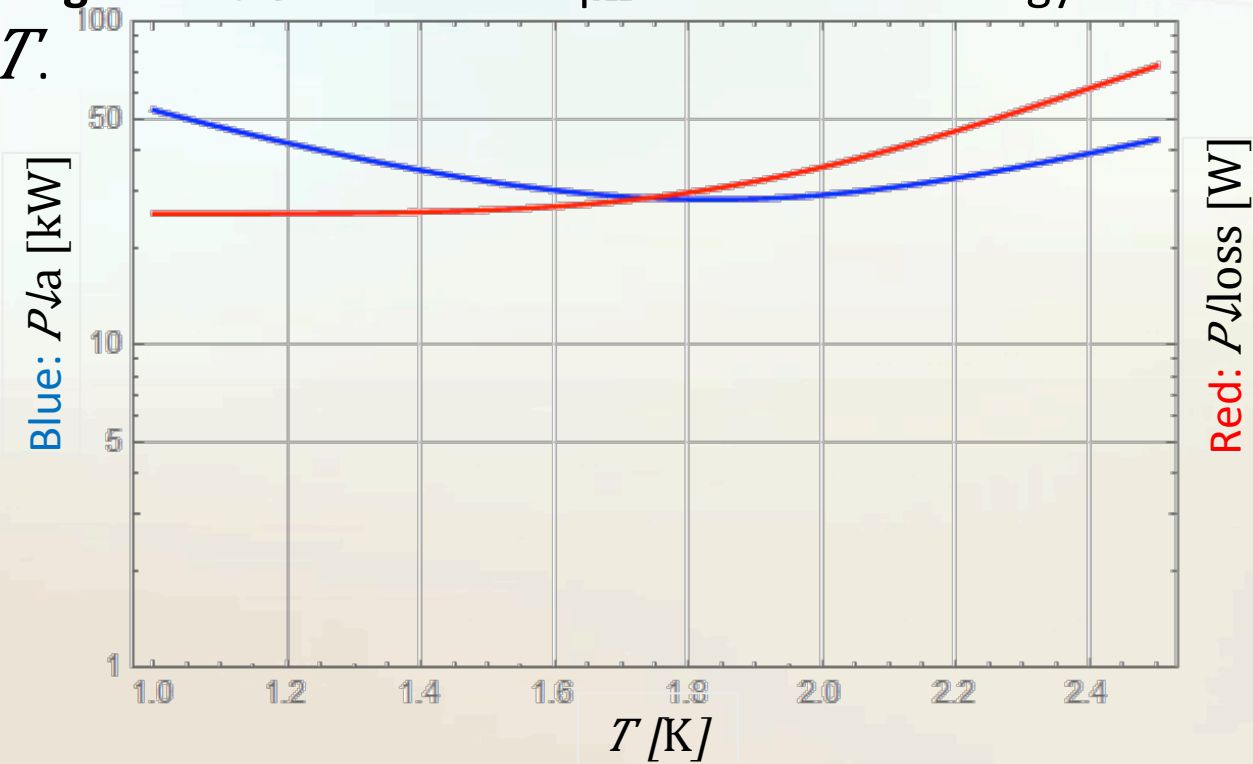

Example: 800 MHz 5-cell cavity for 18 MV, $P_{\downarrow a}$ is the cryogenic power at ambient temperature. Thanks: R. Calaga, S. Claudet, P. Lebrun!



Example FCC-*tt*: orders of magnitude

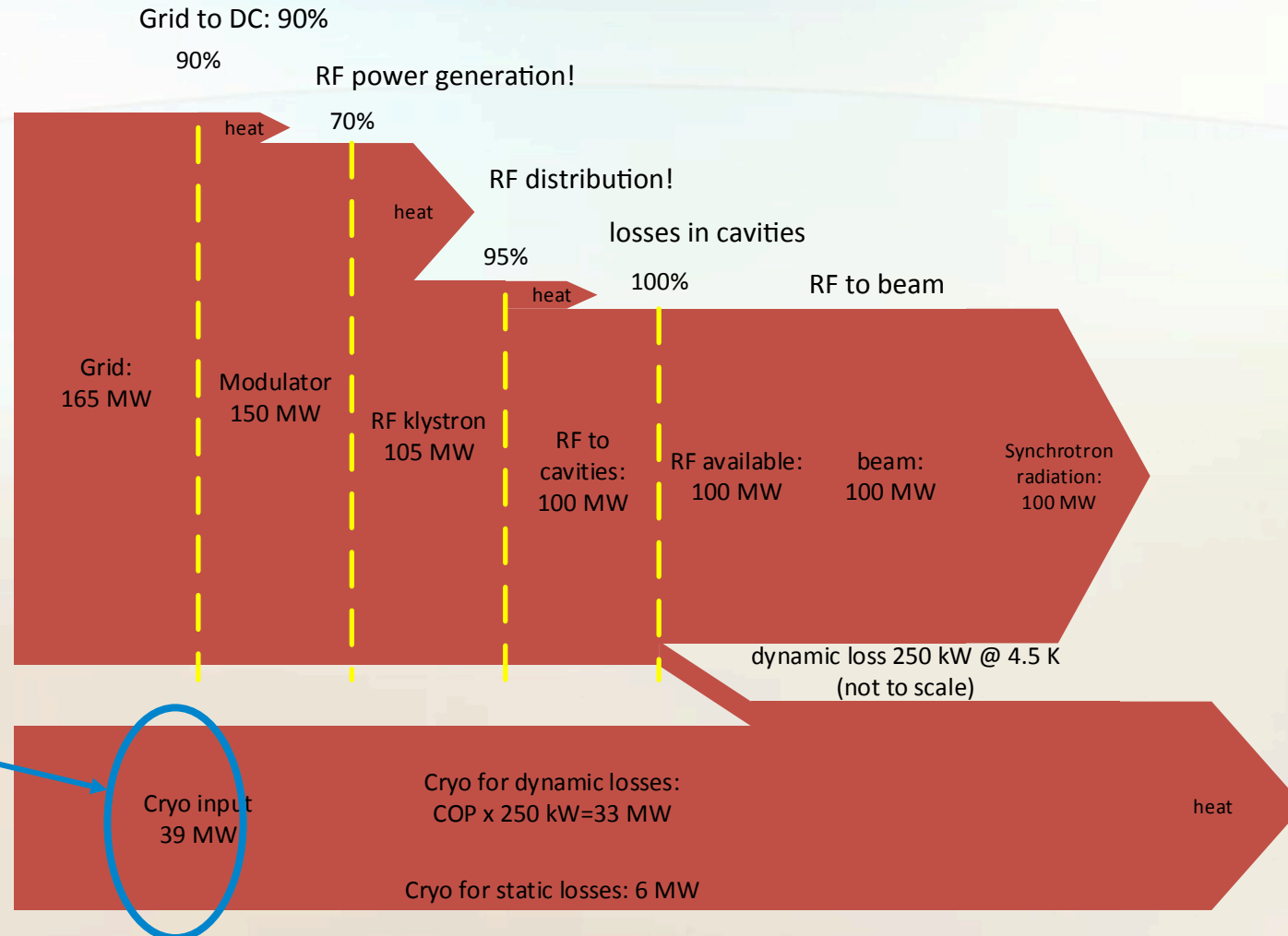

Now we're looking at cryogenic power

- In the example above (FCC-*tt*), 20% of the total power for the RF system is used to cool the cavities – this was already a result of an initial optimization

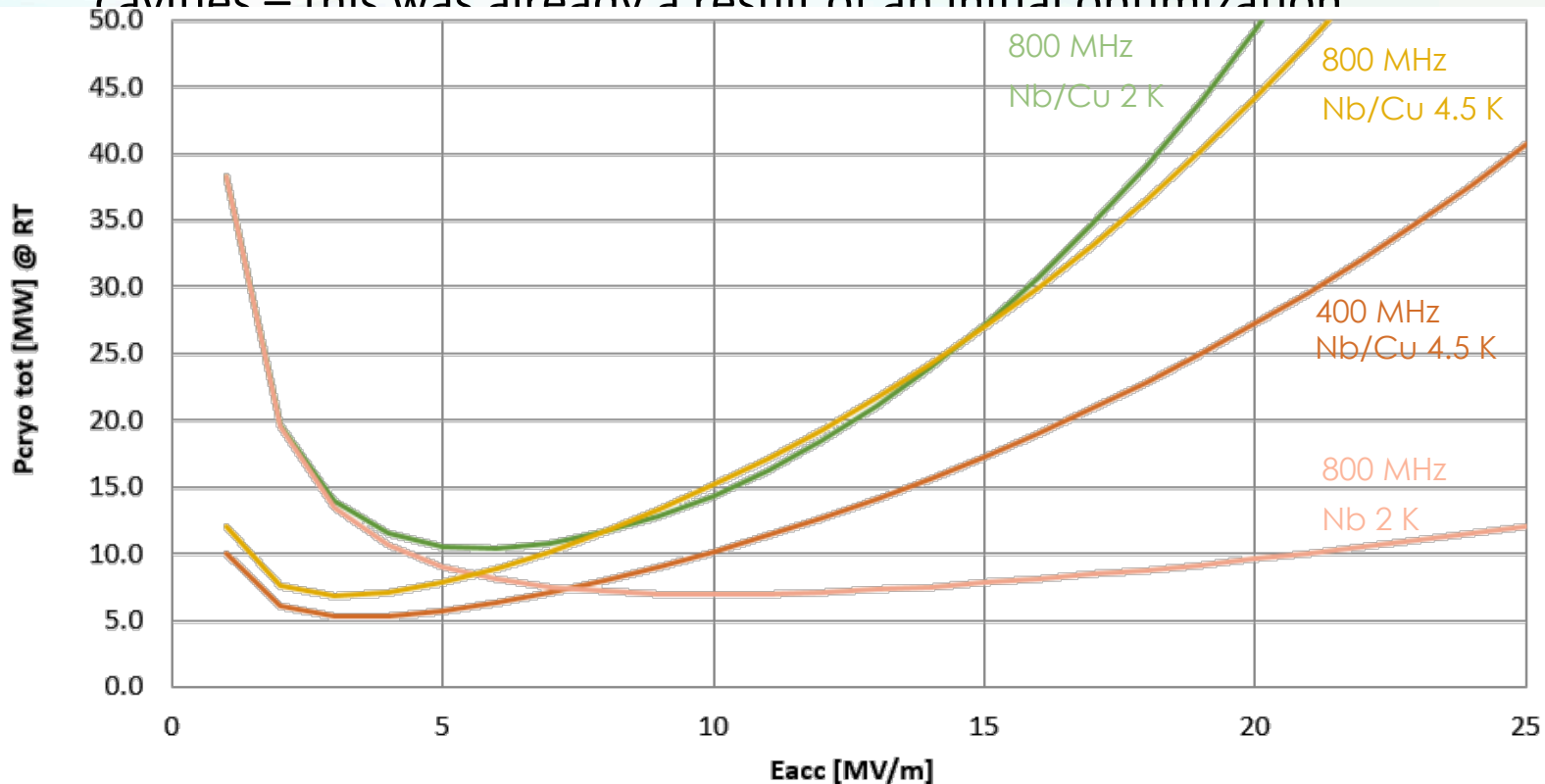

These results allowed to converge to baseline parameters! They also indicate:

- With present day technology, to contain cryogenic losses, fields should remain moderate.
- 4.5 K or 2 K operation – no significant difference at 800 MHz, 10 MV/m.

S. Aull, O. Brunner, A. Butterworth, R. Calaga, N. Schwerg, M. Therasse et al.

- ... But this also indicates what significant improvement could be obtained when Nb₃Sn-like (A15) materials can be successfully used!!!

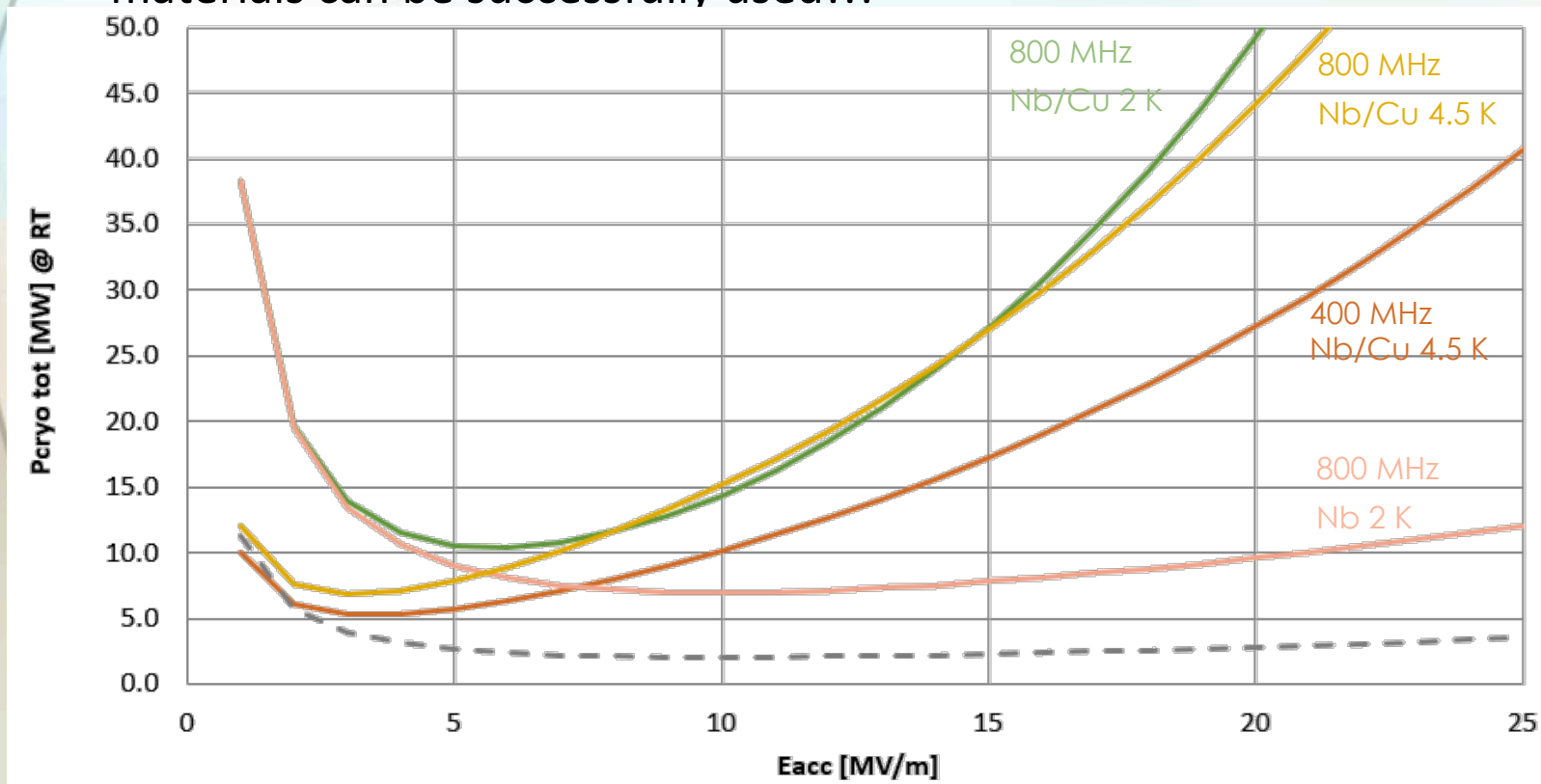

S. Aull, O. Brunner, A. Butterworth, R. Calaga, N. Schwerg, M. Therasse et al.

State of the art: High $Q_{\downarrow 0}$, N_2 doping

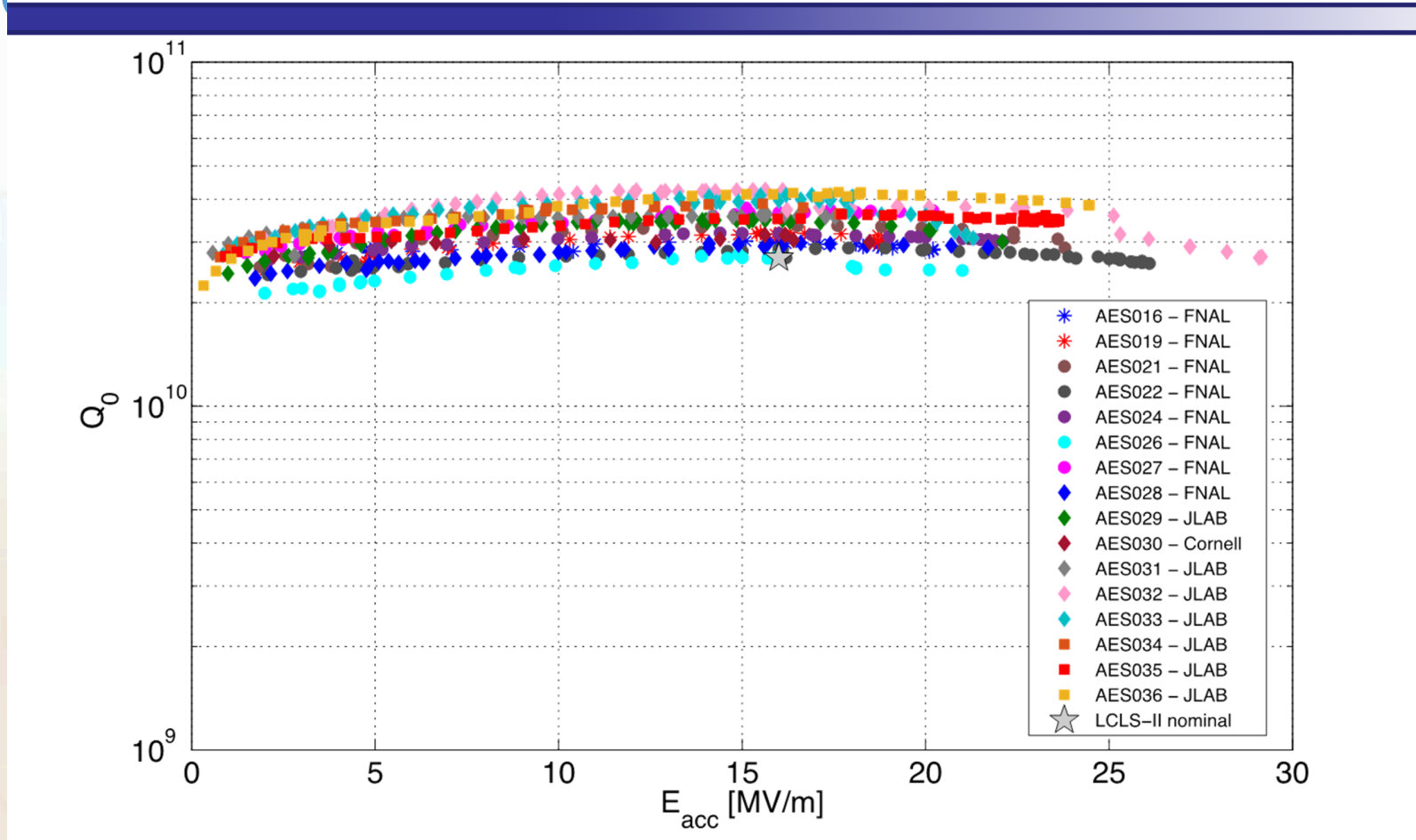

A. Grasselino, SRF2013 & M. Liepe SRF2015

Recent results with Nb₃Sn coated cavities

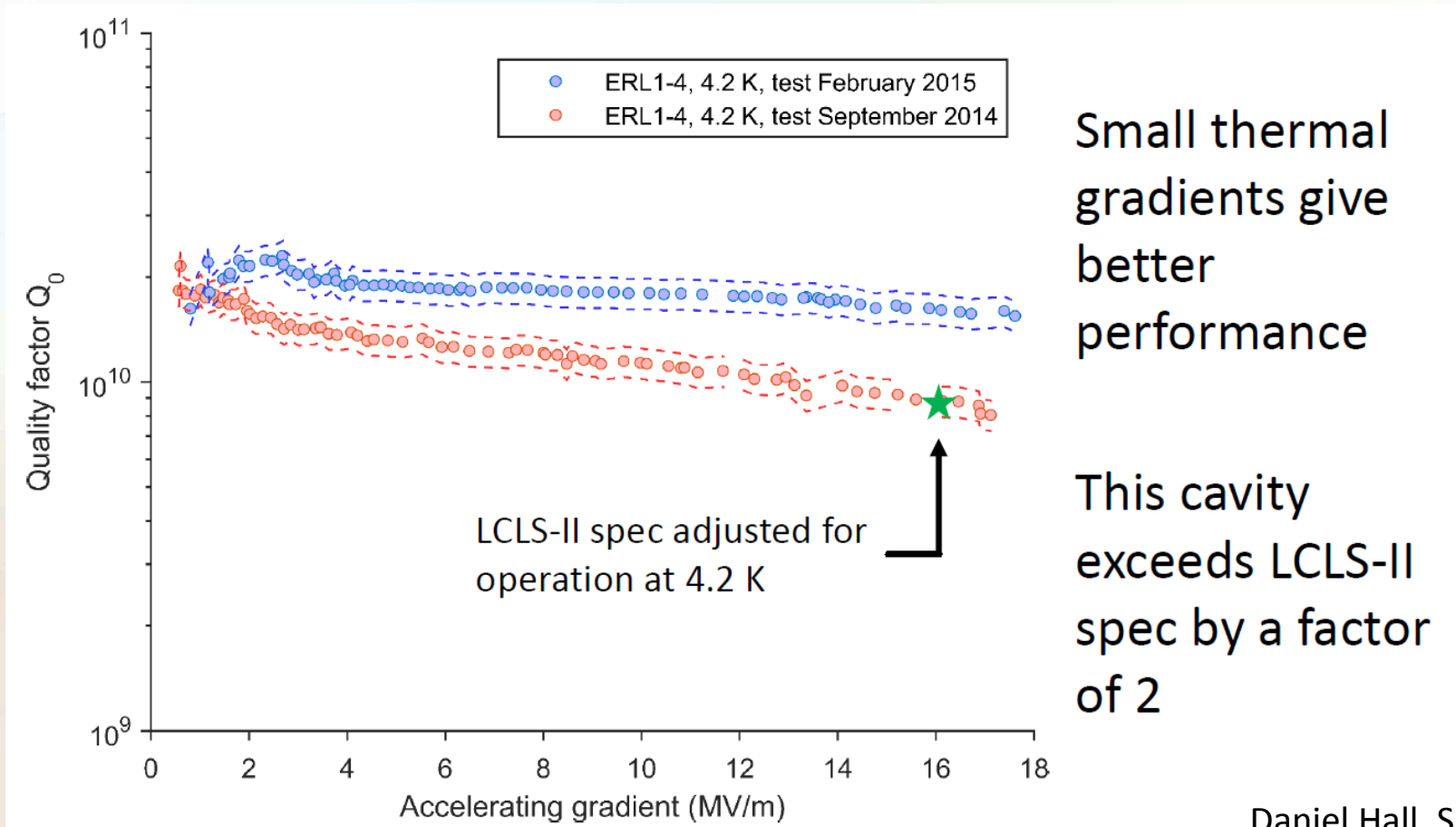

Daniel Hall, SRF 2015, Whistler, CDN



Recovering the beam energy

The “master class” of better energy efficiency

Recovering the energy from the beam: The concept

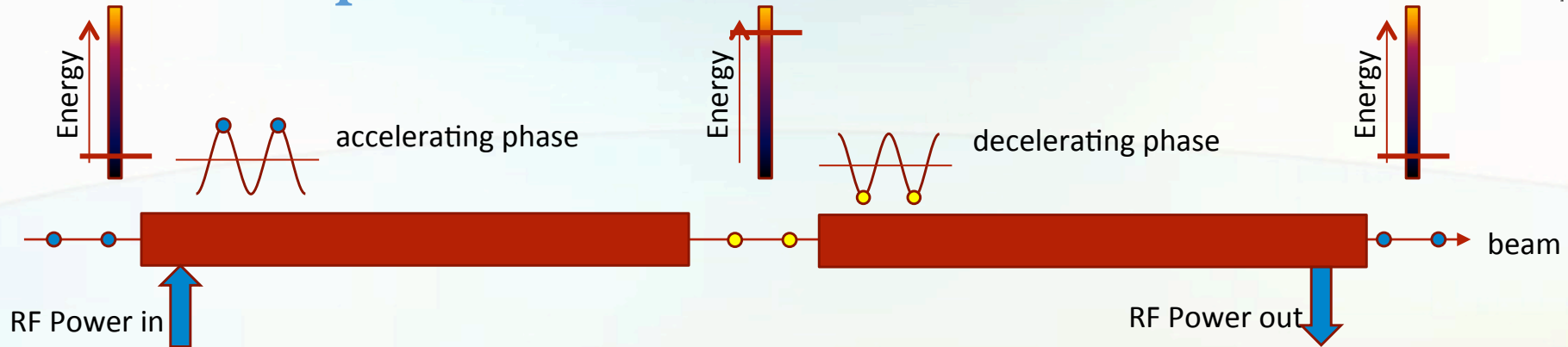

One could use a waveguide and reuse the RF power!

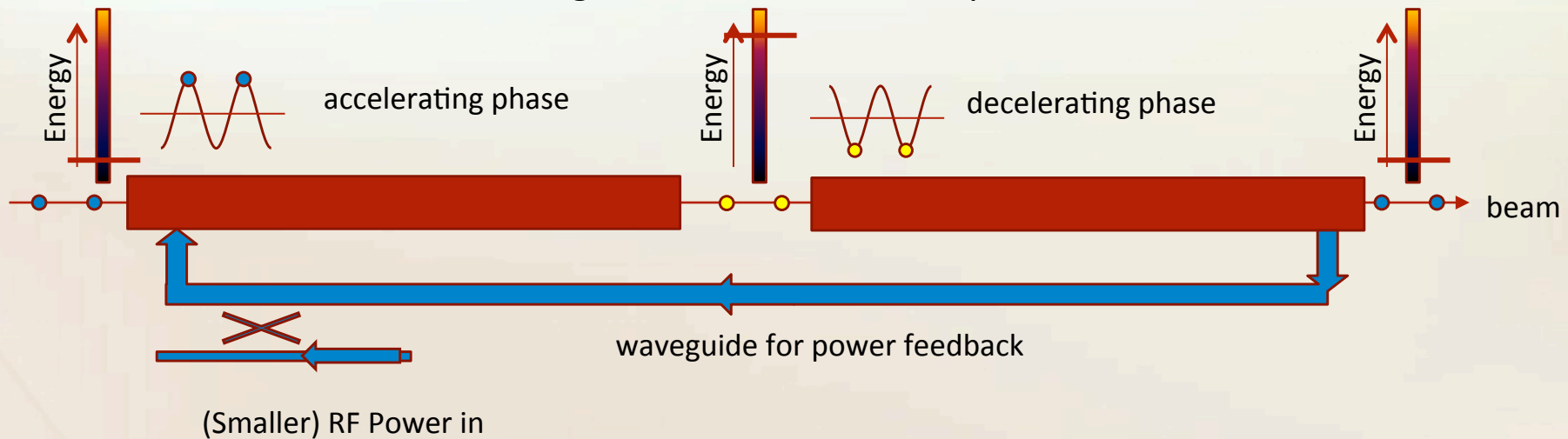



A word about CLIC

In the CLIC scheme, 90% of the drive beam power is recovered (to produce the RF power for the main beam)



CLIC general layout

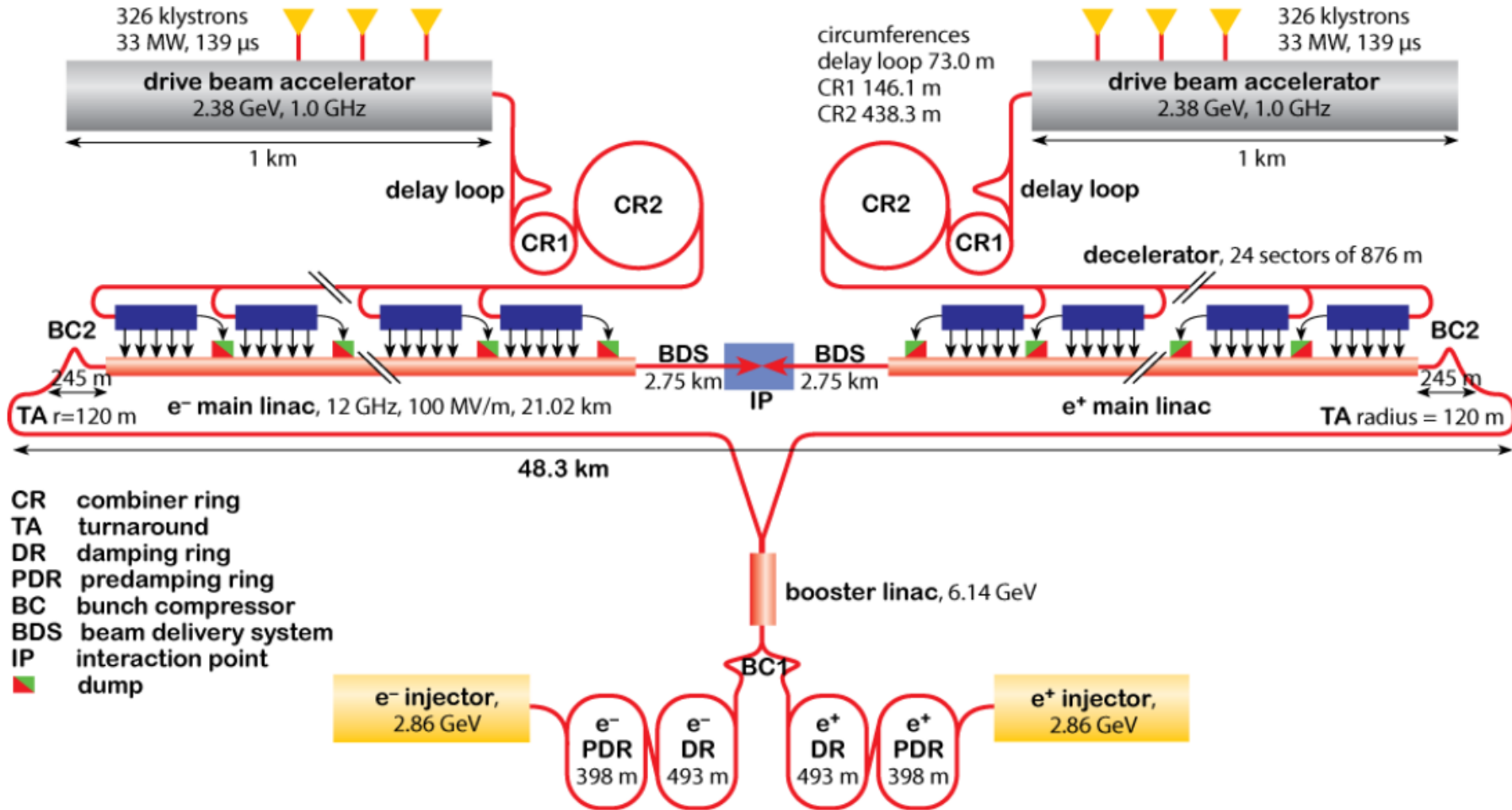

The CLIC power source idea

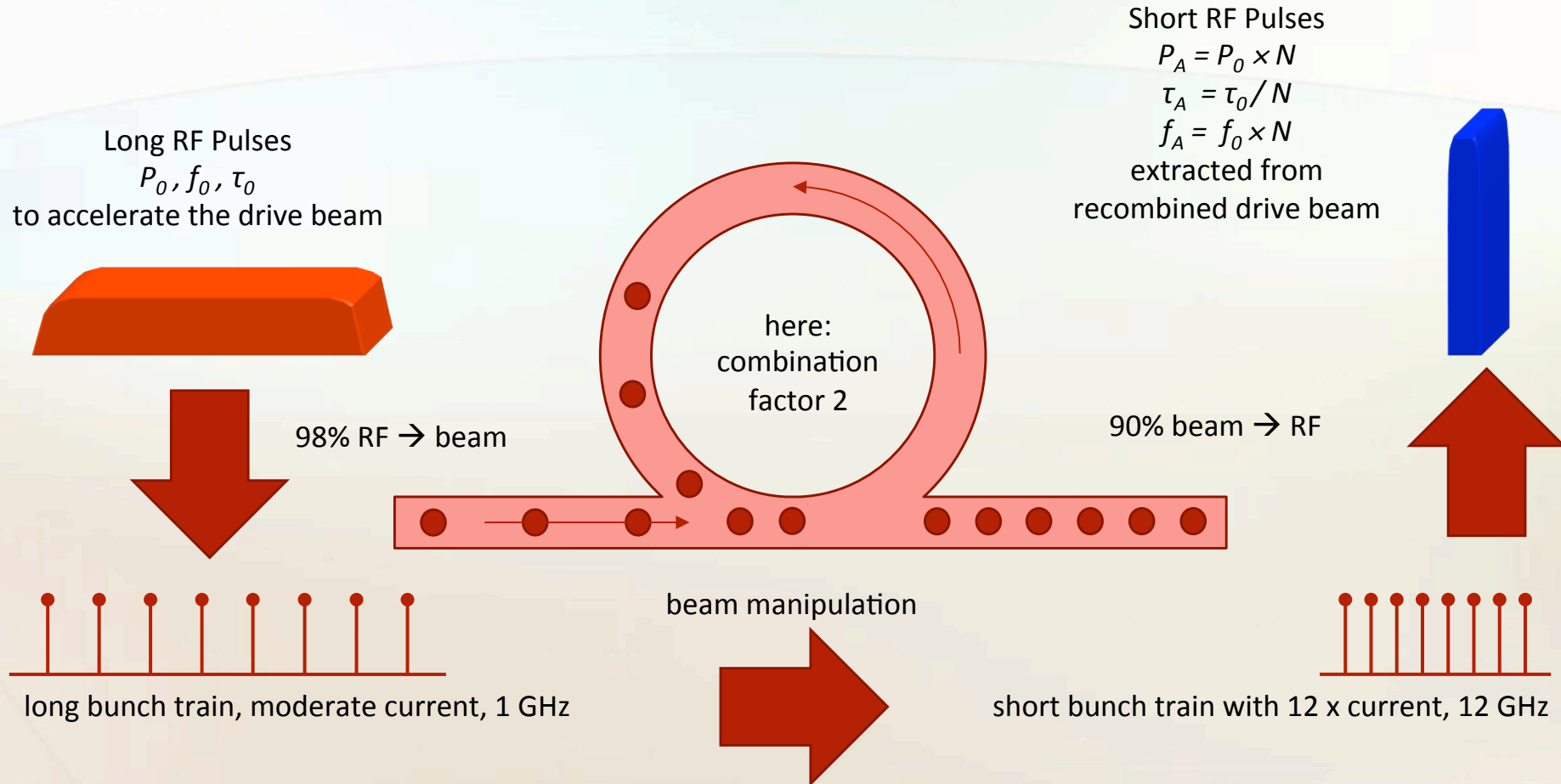

next step from here: the ERL



Natural next step: The Energy Recovery Linac

... stay tuned for A. Jankowiak's lecture tomorrow morning



Thank you for your interest!