

Introduction to Accelerators for Georgian teachers

slides from M. Sapinski
CERN, beams department

presenter: Sophio Pataraiia
12.10.2015



Definition (Brittanica)

Particle accelerator:

A device producing a **beam** of particles
(ions or subatomic particles)

- production of particles (sources)
- acceleration (cavities)
- focusing and storage of beam (magnets)
- collisions of beams (collider)

There exist beams without accelerators

For instance beams of alpha radiation are often obtained by collimation of radiation produced by radioactive isotopes.

What kind of beams are needed at CERN?

Particle physics needs beams:

- clean - one particle type (protons)
- monoenergetic (7 TeV)
- high intensity (10^{14} particles)
- small transverse beam size (0.1 - 0.02 mm)
- well controlled
(stability, reduce risk of machine damage)

We can produce a beam of any ion/isotope and beams of muons, neutrinos, neutrons, high-energy photons... (secondary beams)

Outlook

- Particle sources
- Electrostatic acceleration
- Resonant cavities.
- Standing and traveling wave acceleration.
- Synchronism
- Curio: Fermi mechanism, wakefield acceleration
- Circular accelerators: cyclotron
- Synchrotron
- Colliders: luminosity. LHC beam.
- Future of accelerators

Particle sources

Electrons: thermionic emission (emission of electrons from hot surface, as in old TV sets) or laser-driven emission.

Ions/protons: separation of ions from electrons in plasma

- duoplasmatron

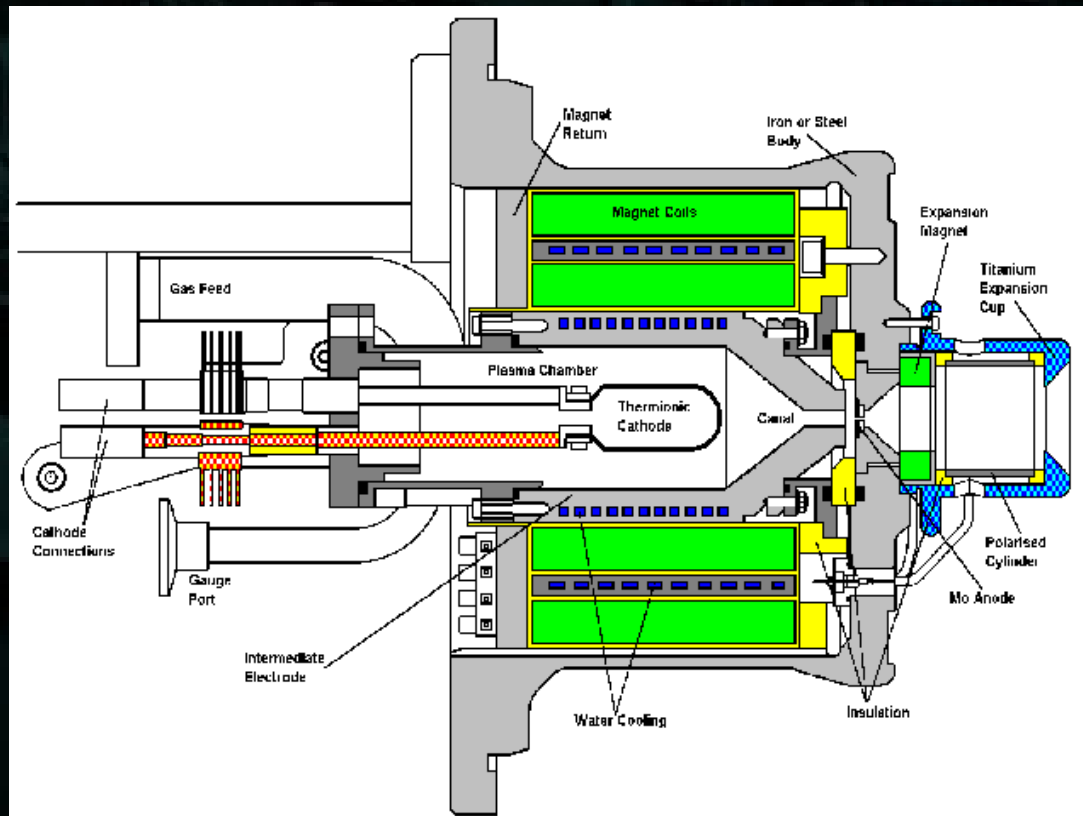

Early stages:

1. collimation

2. bunching

3. initial acceleration
(RF quadrupole)

How to accelerate?

Transform some kind of energy into kinetic one

- Vehicle: chemical – thermal – kinetic
Complicated mechanism – not suited to elementary particles
– need to use elementary fields
- Gravity: $\alpha_G = Gm_e^2/\hbar c = 1.8 \cdot 10^{-14}$
- Magnetic field: $F = q (\mathbf{v} \times \mathbf{B})$

Static magnetic field acts perpendicularly to direction of movement – cannot be used to accelerate particles.

- Electric field:

$$\alpha_{EM} = e^2/4\pi\hbar c\epsilon_0 = 7.3 \cdot 10^{-3}$$

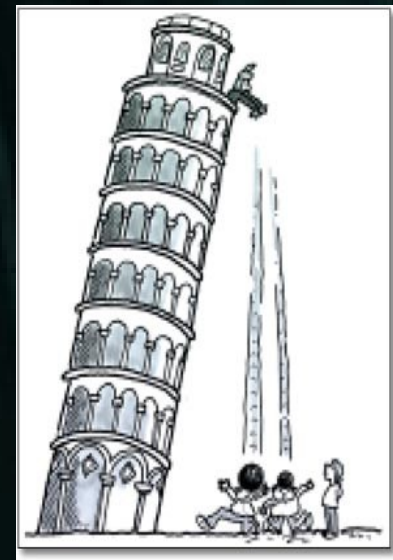
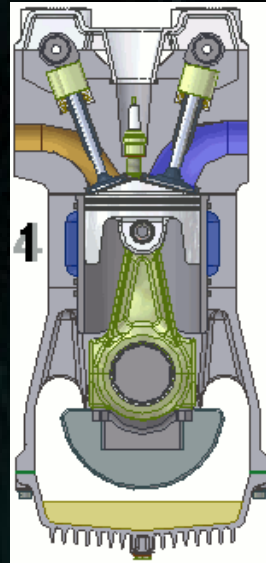

The simplest electrostatic accelerator (XIX century)

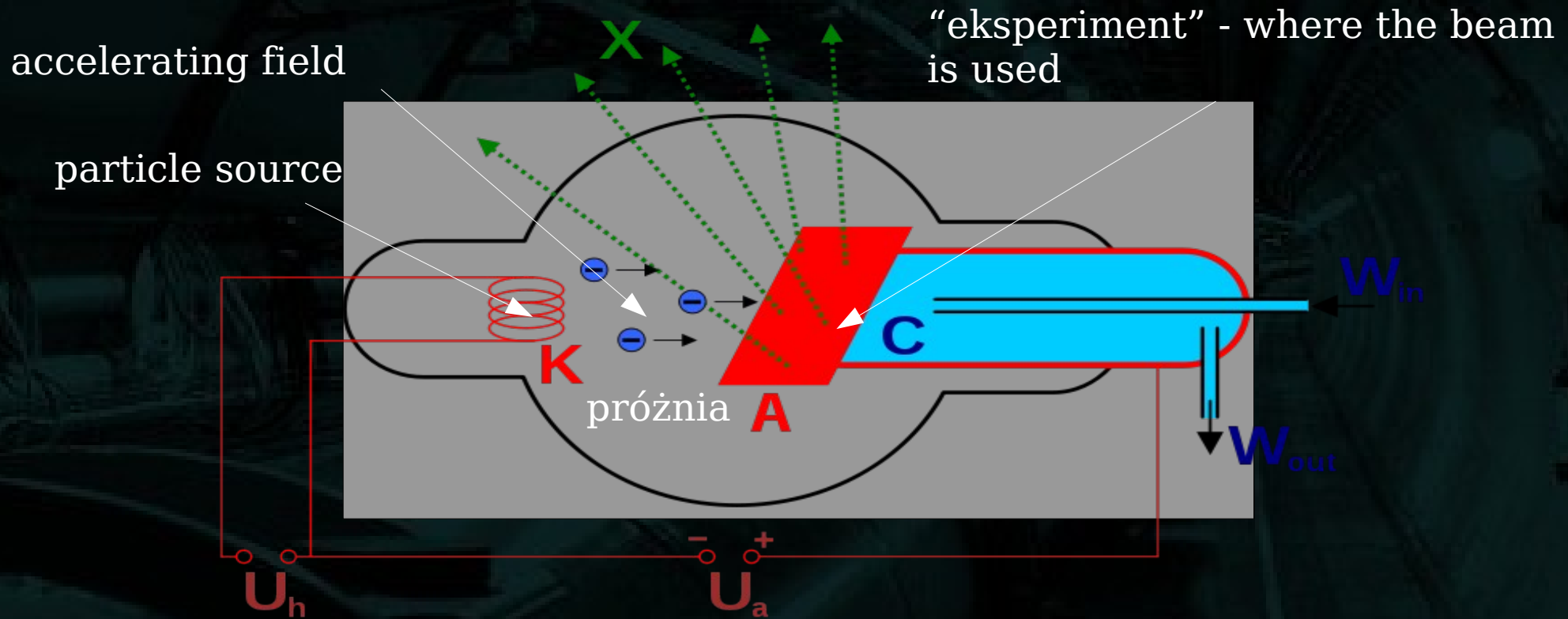

- X-ray tube: $E \sim 10^5$ eV (100 kV)
- main limit: ability to generate high electrostatic voltage (electric discharge)
- vacuum - crucial element of every accelerator

How to go beyond the limit of electrostatic voltage?

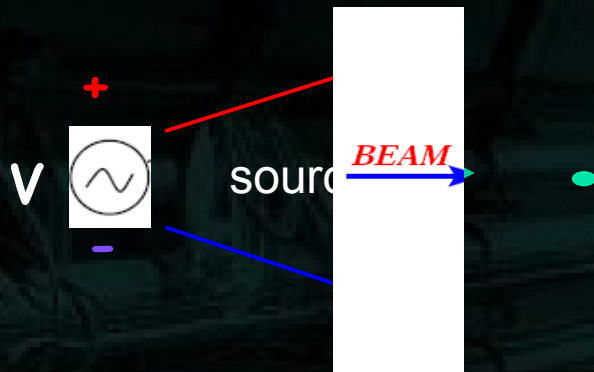

Wideroe

First system:
1928

- Particles are accelerated in between the drift tubes
- New element, not present in x-ray tube: **bunches**
- Limit: radiation losses
 - the system is a big antenna (>10 MHz)

Improvement: Alvarez system

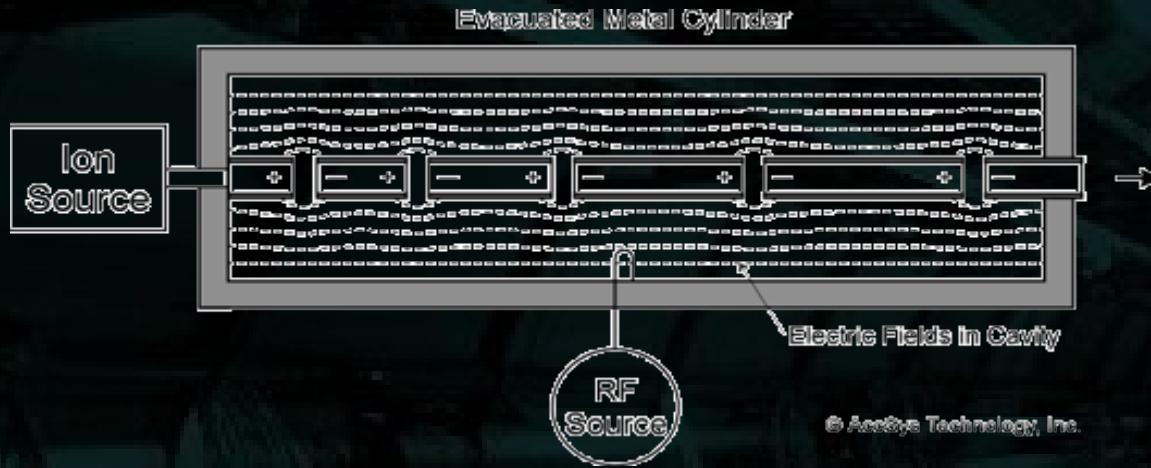

1947, following the evolution of radar technology (klystron)

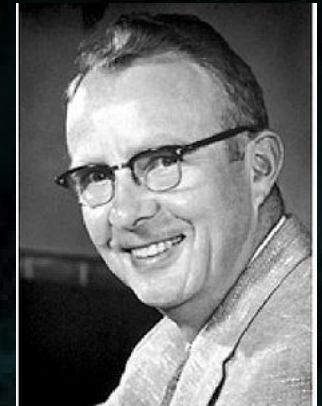

- Enclose everything in a RESONANT CAVITY, such that resonant frequency equal to the one needed for acceleration
- In such cavity a standing wave is created with electric field in the direction of particle movement
- Wave is generated by klystron
- Wave frequency up to: **200 MHz**
- This system is used also today

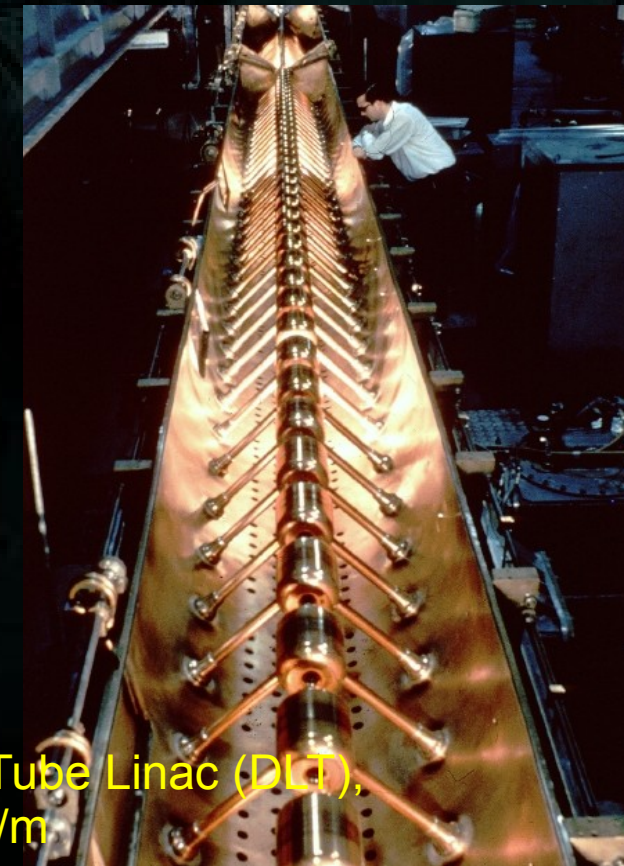

Drift Tube Linac (DLT),
3 MV/m

Electromagnetic wave

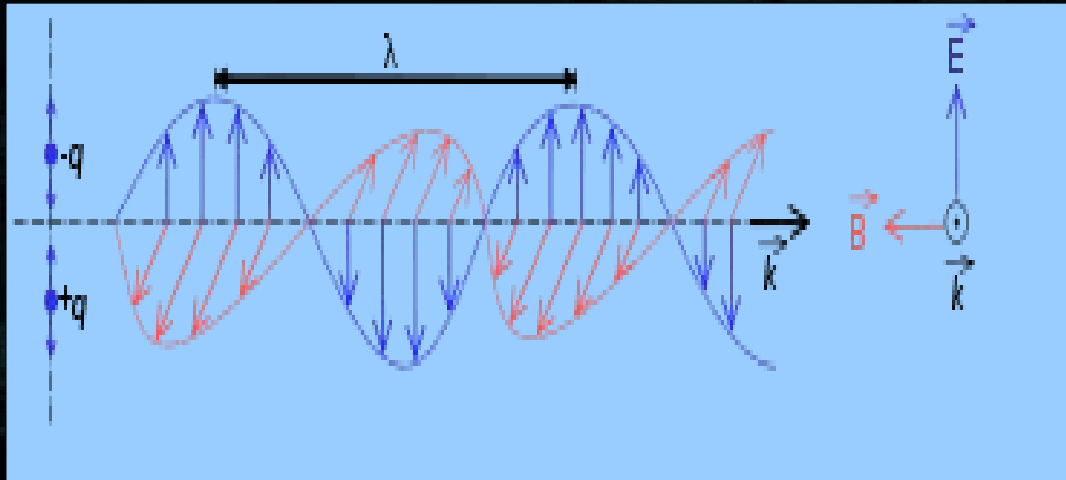

Empty space

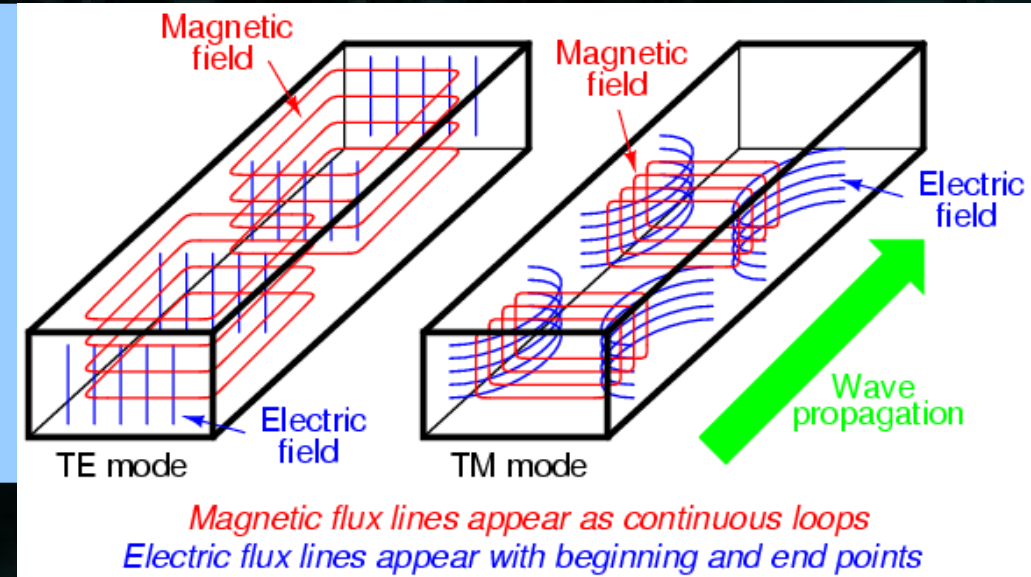

Wave-guide (metal box)

Standing and traveling waves (two ways to drive the particles)

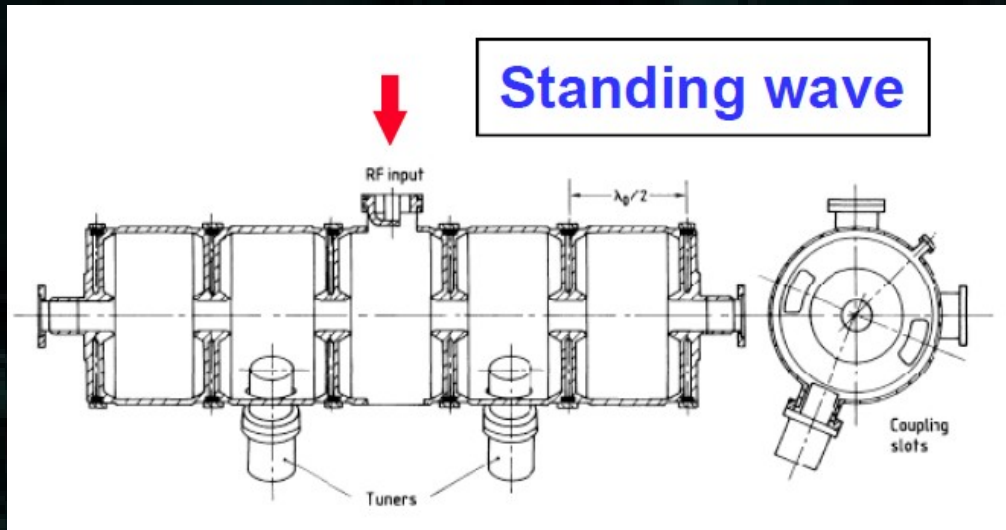

Accelerating gradient:
up to. 5 MV/m

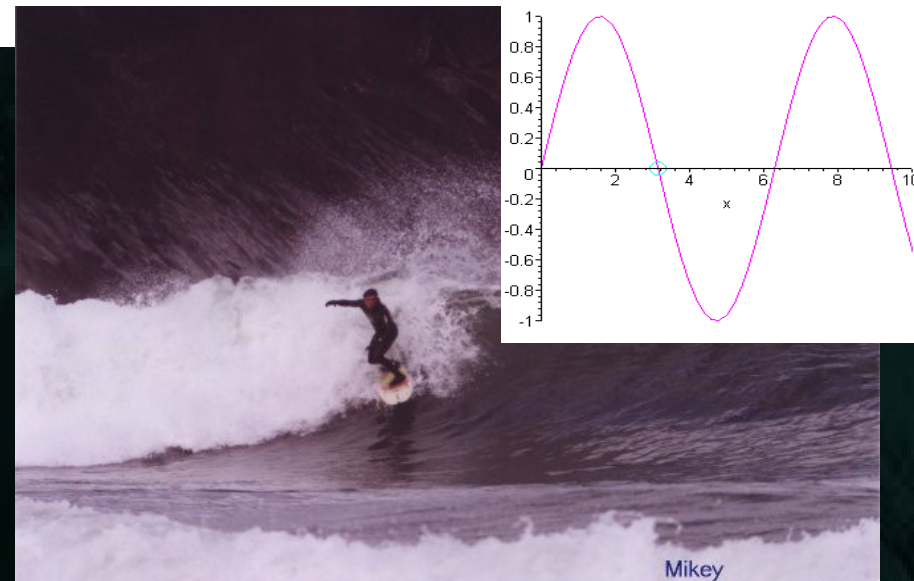
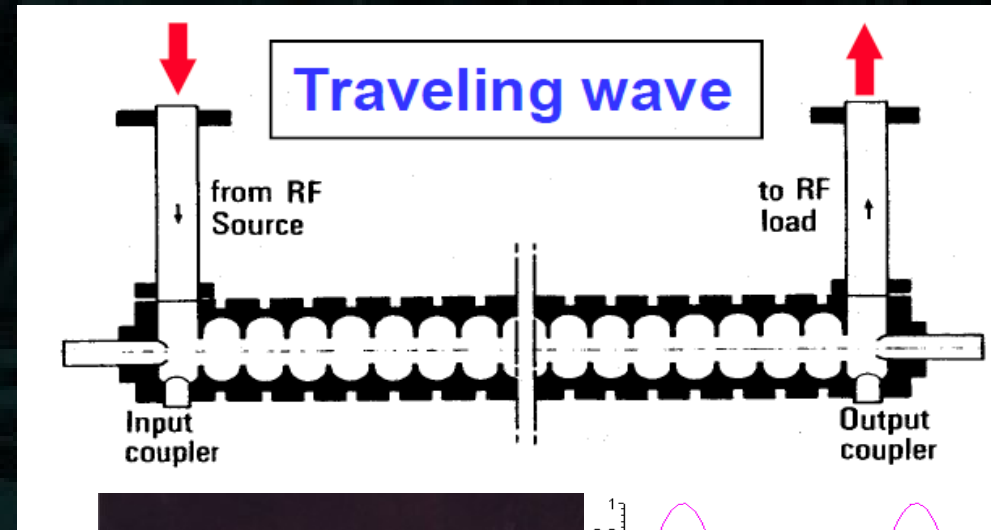

Accelerating gradient
up to 20 -30 MV/m
(superconducting cavities)

Stability: synchronism

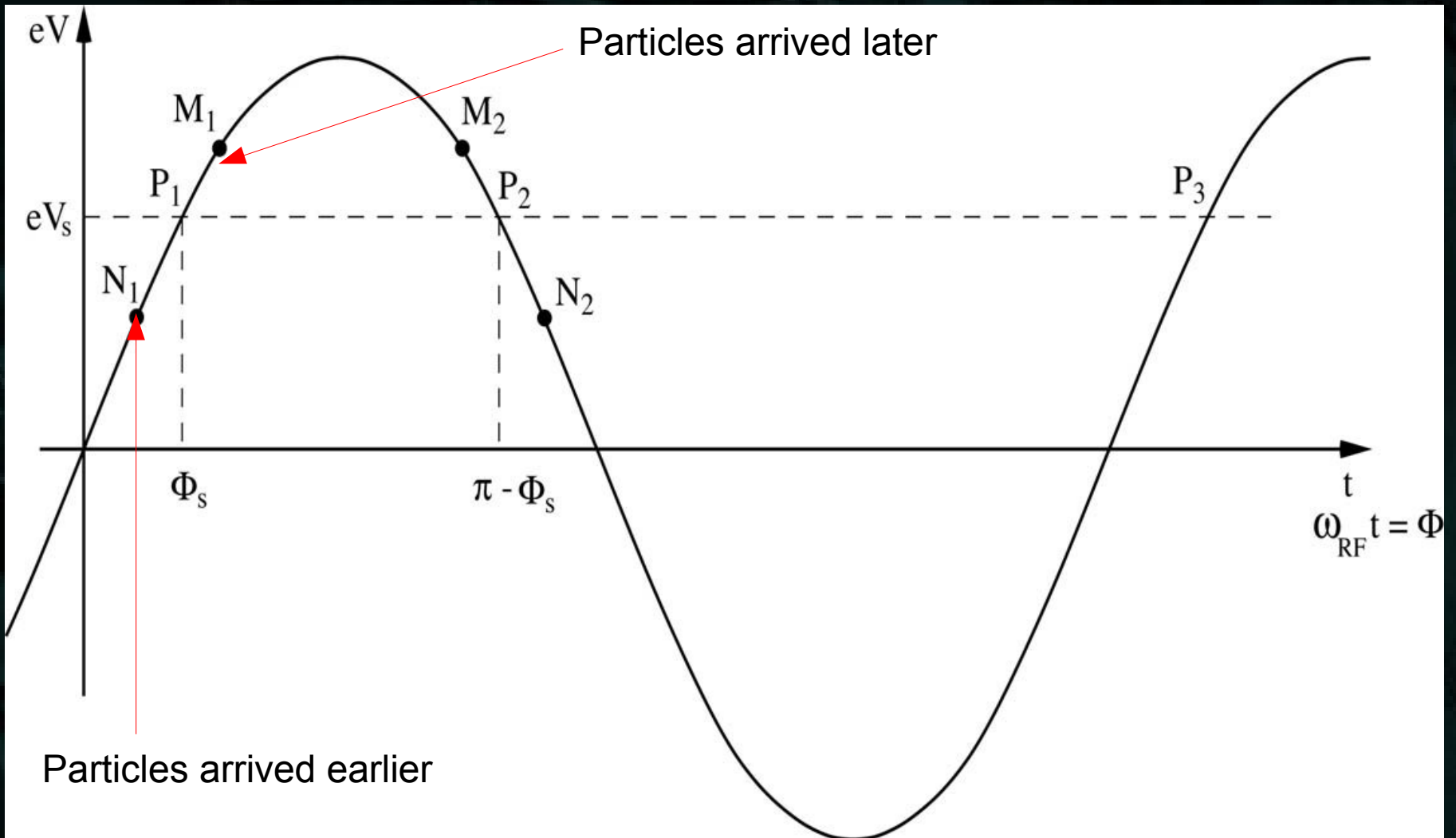

How high energy cosmic rays are generated?

- Ultra-high energies: 10^{20} eV, LHC: $7 \cdot 10^{12}$ eV

(Oh-my-God particle: 50 joules!)

- Ultra-high energy cosmic rays are produced via **Fermi acceleration**: magnetic shock wave after supernova explosion

Not useful for us:

- large space required,
- acceleration is isotropic

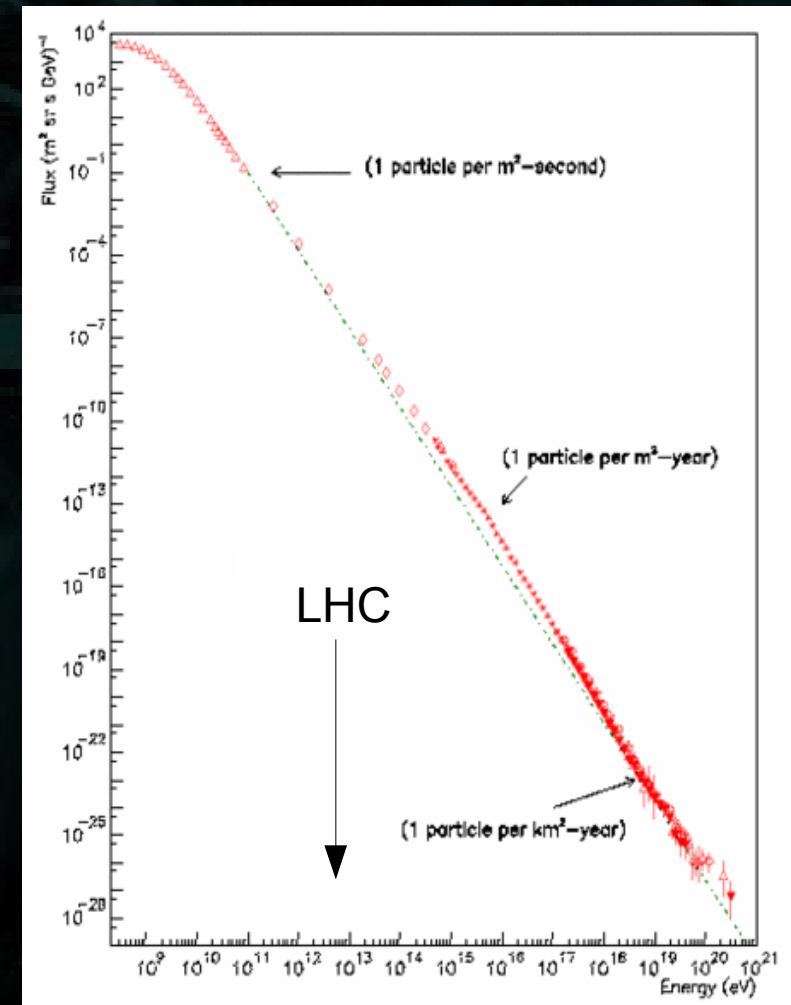

New ideas: plasma acceleration

- Idea: electric field of a laser pulse creates a wave of separation of electrons from ions. It looks like a bubble of positive charge (cleared from electrons) moving through plasma at close to the speed of light. Just after this positively charged bubble electrons fall back creating negatively charged zone. In between a very high field gradient is formed. Comparison of gradients:

- Resonant cavity: 30 MV/m
 - Gas plasma: 100 GV/m
 - Gradient in dielectric: 100 GV/cm
- femtosecond synchronization**

record: 42 GeV on 85 cm !
for comparison: SLAC: 50 GeV – 3 km!

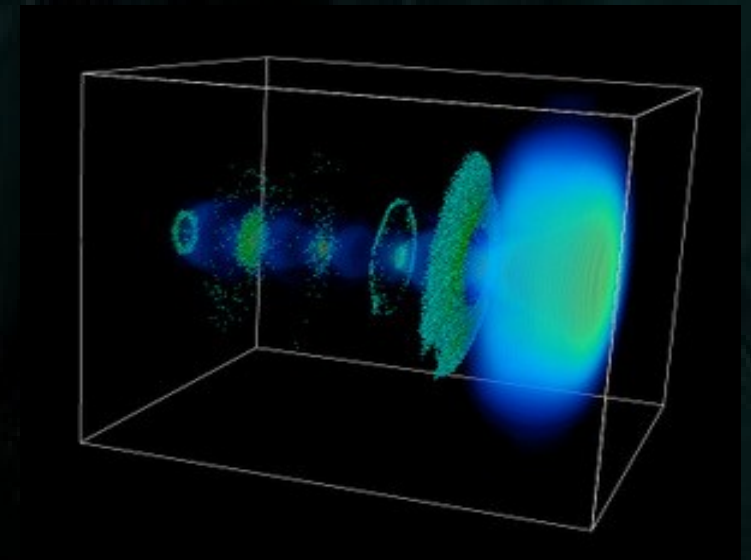
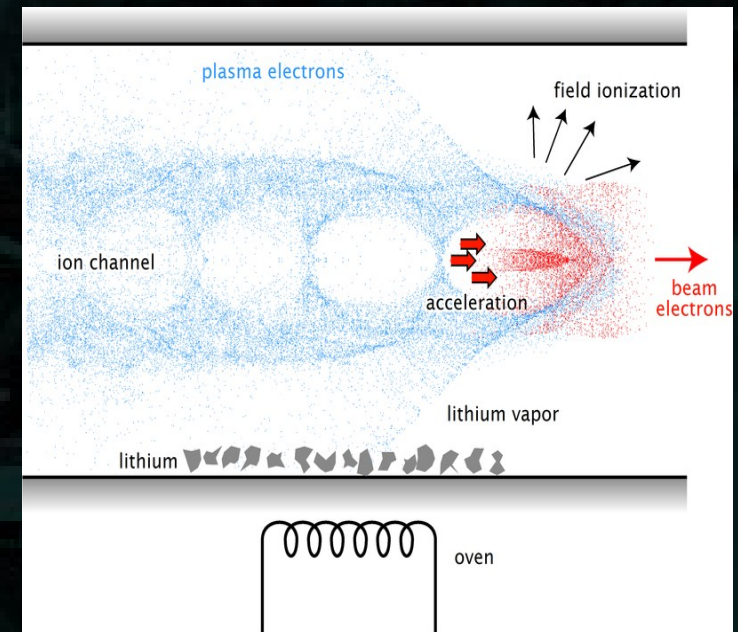

Nature, 2004/30

Linear and circular accelerators

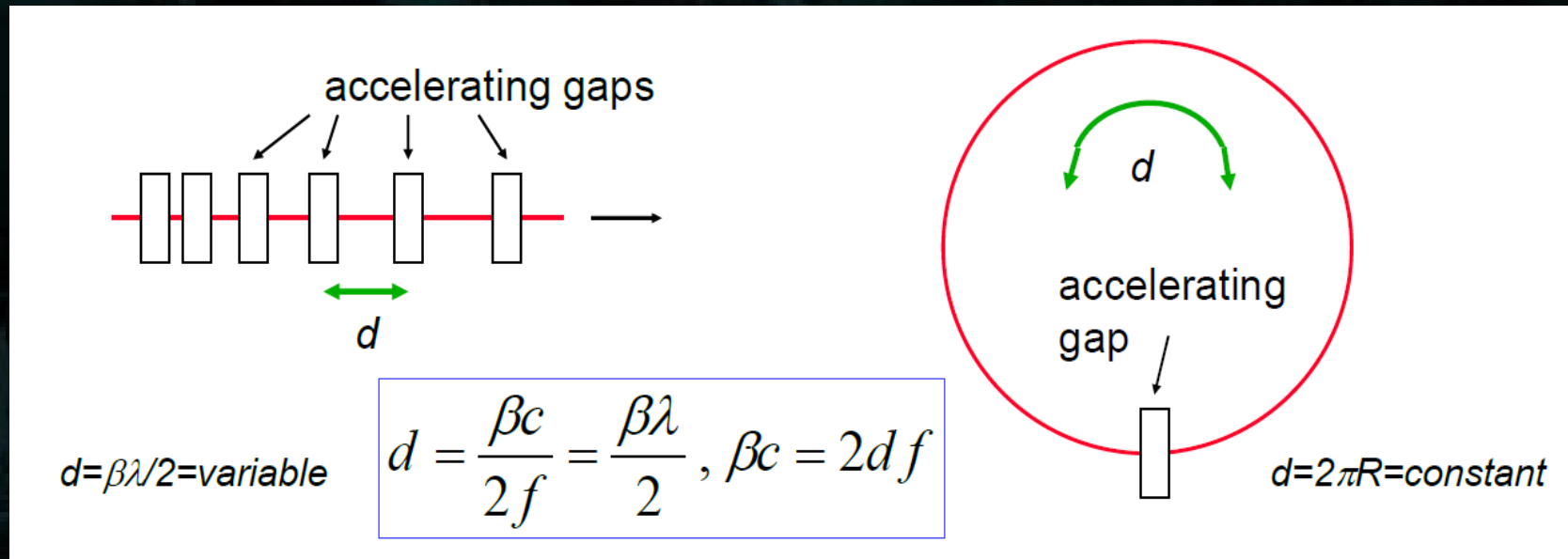

Linear:

- Every accelerating element is used only once,
- Distance between accelerating elements can change according to particles speed (acceleration before reaching relativistic speed)

Circular:

- Accelerating element is reused every turn,
- In collider mode the same particle bunches are reused every turn
- **$B\rho = p/e$** - during acceleration **B** or **ρ** changes

Cyclotron

- **Constant magnetic field** bends particles, between the two “D” electrodes (dees) alternating voltage is applied
- Largest in TRIUMF (Canada): 18 meter diameter

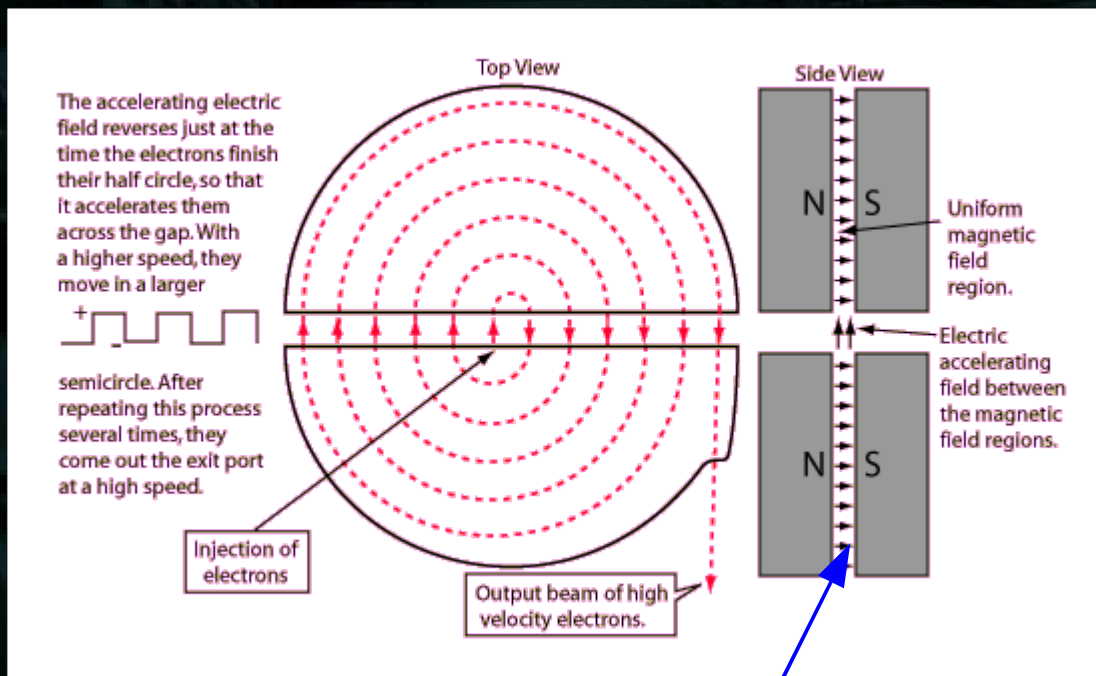

Lawrence, Nobel 1939
(but also Widroe!)

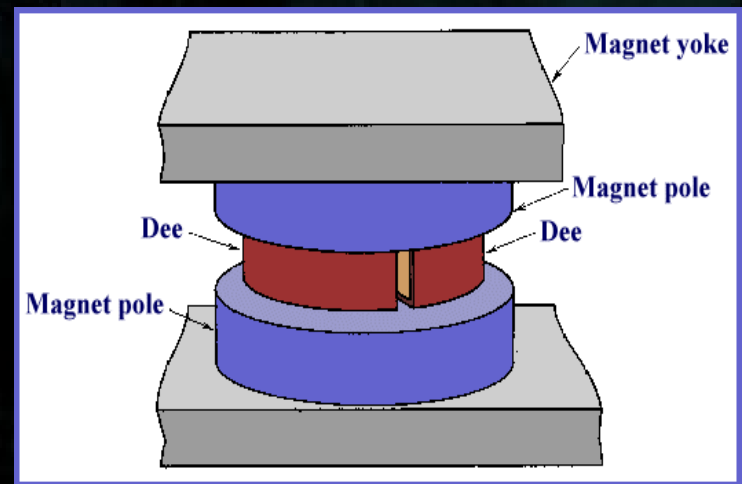

vacuum chamber: large narrow gap between 2 poles

Synchrotrons

M. Oliphant - idea

E. McMillan - realizacja

- Instead of changing the orbit of the particles, the magnetic field increases (**synchronously with particle energy**)
- Electric field gradient in cavities also changes
- Main elements:
 - Bending magnets
 - Focusing magnets
 - Resonant cavities
- First synchrotron: 1950s, 3 GeV, Berkeley Lab (production of transuranium elements)

Synchrotron elements

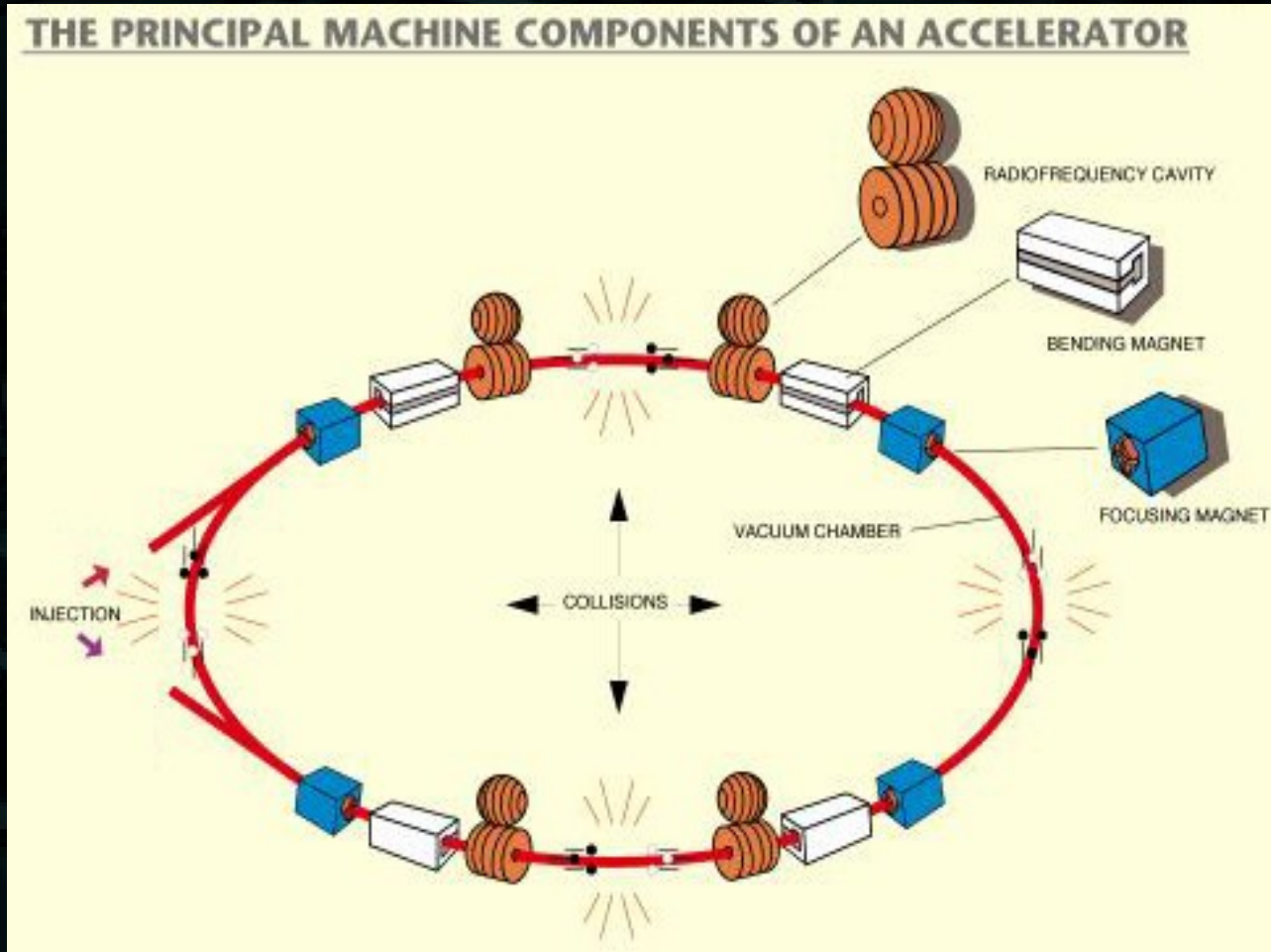

Bending magnets

$$\frac{d\vec{p}}{dt} = Q * \left(\vec{E} + \vec{v} \times \vec{B} \right)$$

Lorenz force

- Dipoles (vertical field) bend beam in horizontal direction

LHC DIPOLE : STANDARD CROSS-SECTION

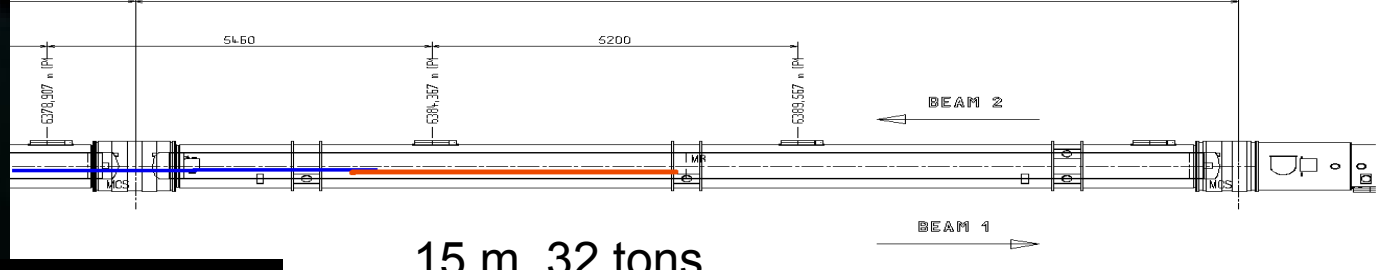
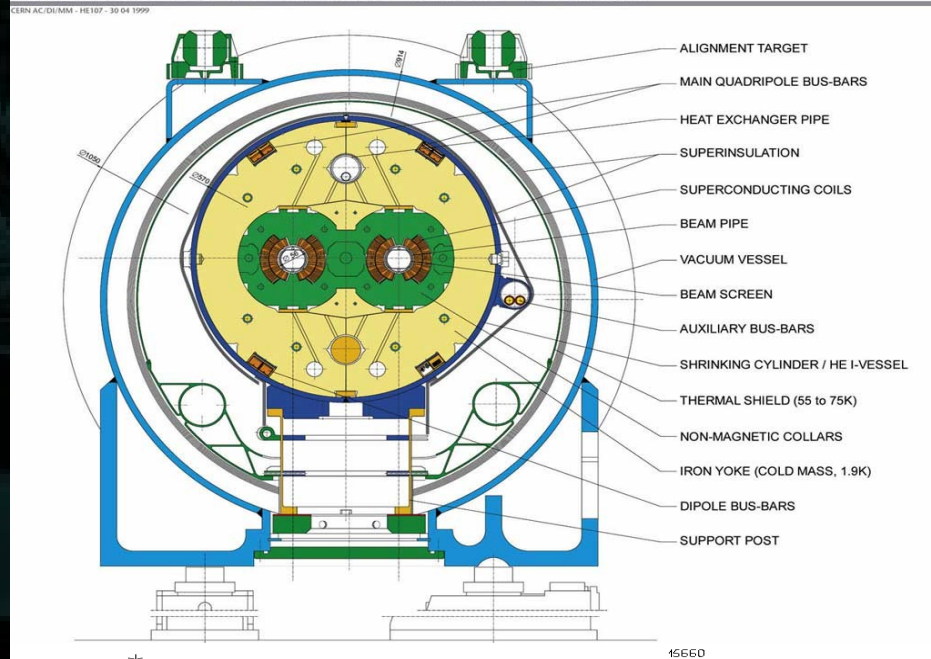

15 m. 32 tons



Beam stability

- Perfect synchrotron needs only dipoles
- But the world is not perfect – beam particles suffer from:
 - gravity
 - radiative energy losses
 - interactions between particles
 - interactions with accelerator (mirror fields etc)
- As a result beam is defocused
- To keep it focused: quadrupoles
- Analogy to optical lens, but in one plane only

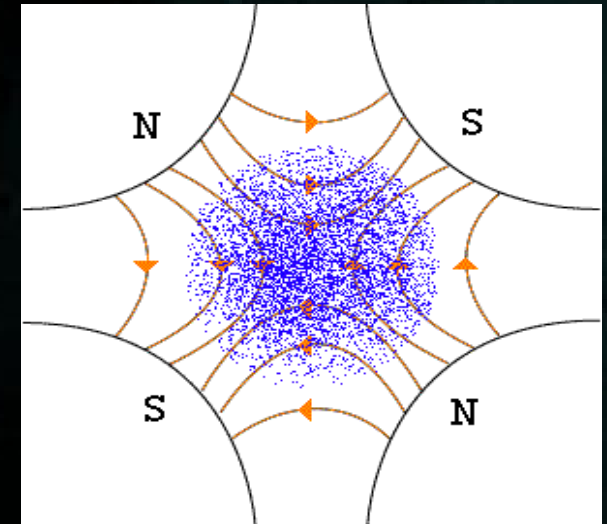

FODO structure

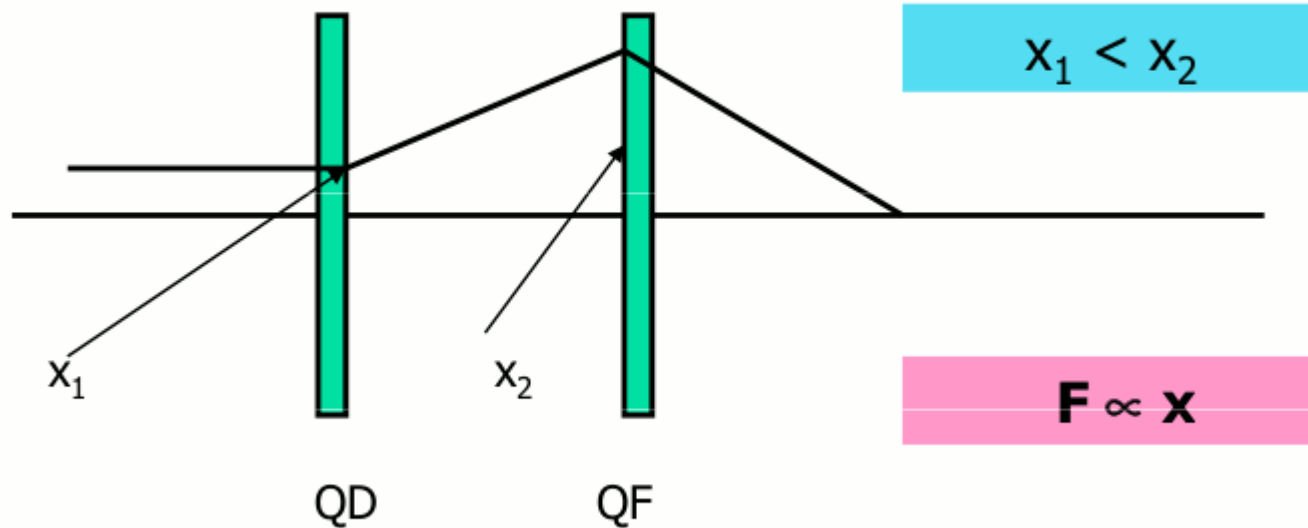

FODO cell

Beta function

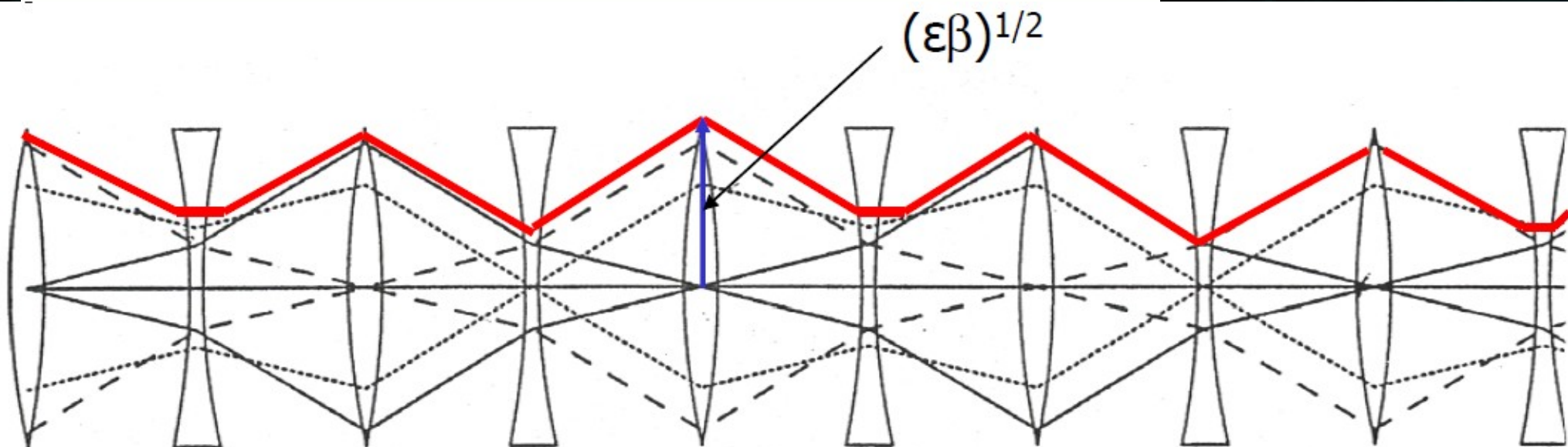

LHC quadrupole

- Superconducting
- Length about 3.5 m
- Many types
- Special type in the interaction points
- Other correctors: sextupoles, octupoles, decaipoles

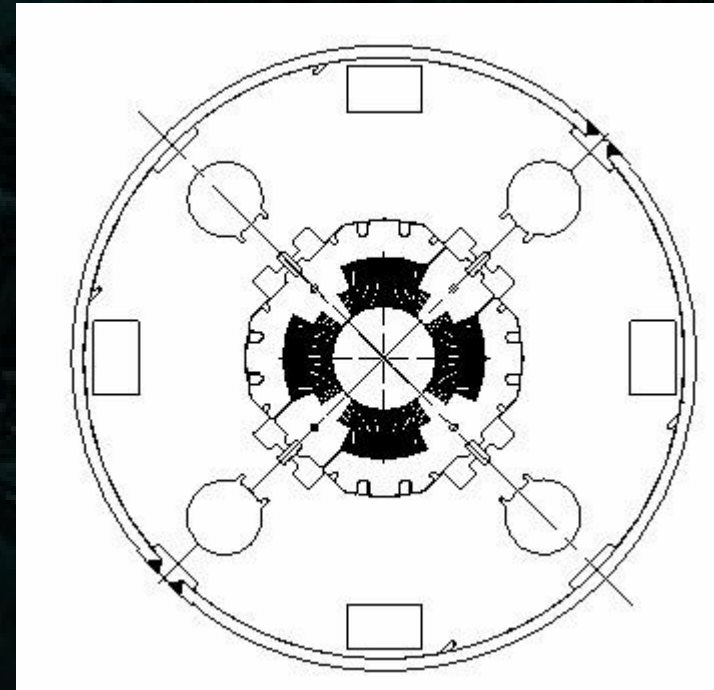

Interaction point

- Beams focused from 0.1 mm to 0.02 mm, (human hair - 0.05 mm)
- Millions of collisions per second (f)
- Luminosity: $L=f/\sigma$
- Integrated luminosity: What is inverse femtobarn?

collision rate \rightarrow No of collisions

1 barn = 10^{-24} cm²

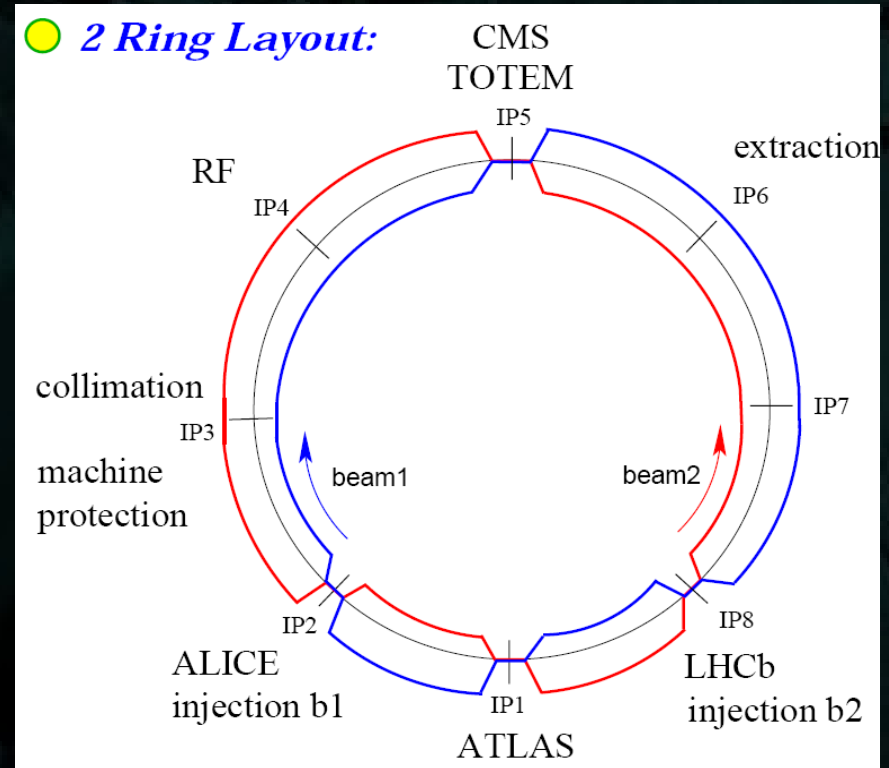
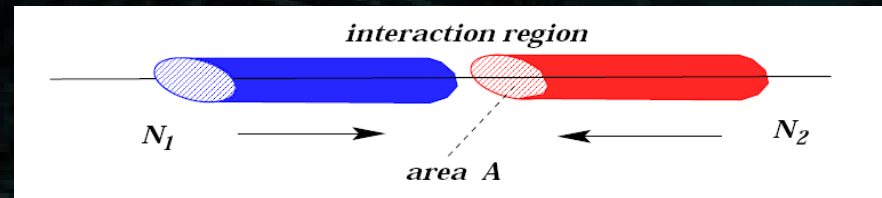
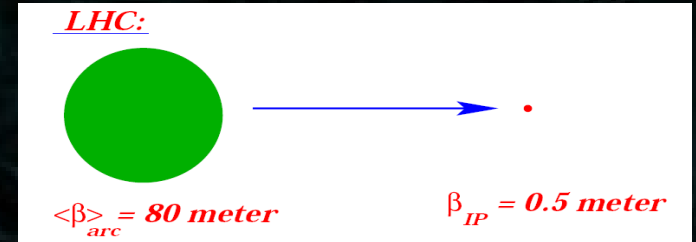

LHC beam

- 10^{14} protons with kinetic energy 7 TeV on common orbit (within 0.1 mm)
- Total kinetic energy in both beams: 362 MJ
- Compare with: 10^{13} protons, 450 GeV extraction from SPS, october 2004, magnet damaged

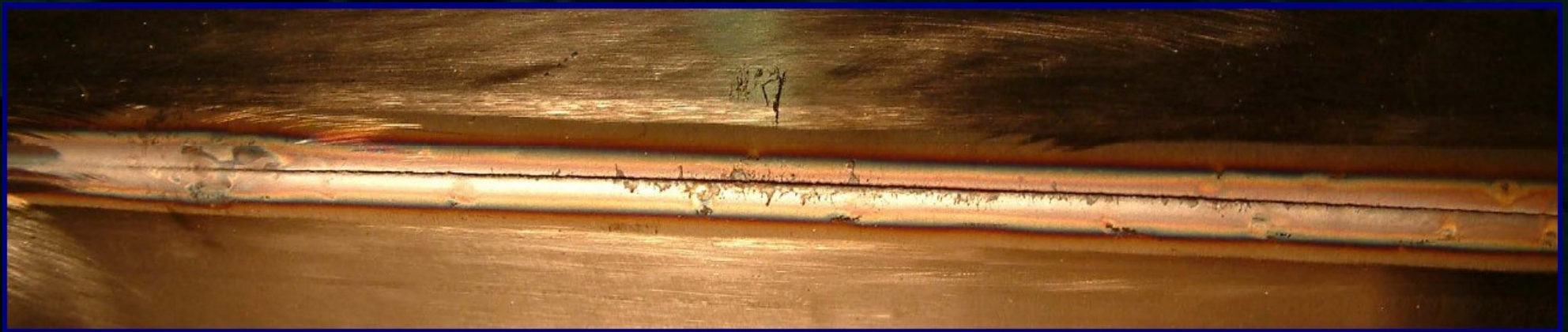

Future of accelerators

- Light sources for structural and material research
- Hadron therapy
- Next fundamental physics tool:
CLIC or NLC – linear, colliding electrons
- Maybe accelerator-drives fusion

Basic and Applied Research		Medicine	
High-energy phys.	120	Radiotherapy	7500
S.R. sources	50	Isotope Product.	200
Non-nuclear Res.	1000	Hadron Therapy	20
Industry			
Ion Implanters	7000		
Industrial e- Accel.	1500	Total:	17390

CLIC/NLC – why electrons?

- Linear collider (no radiation losses) 50 km long
- Protons are composed particles: during collision we have interaction of elementary: quarks or gluons, but we don't know their energies!

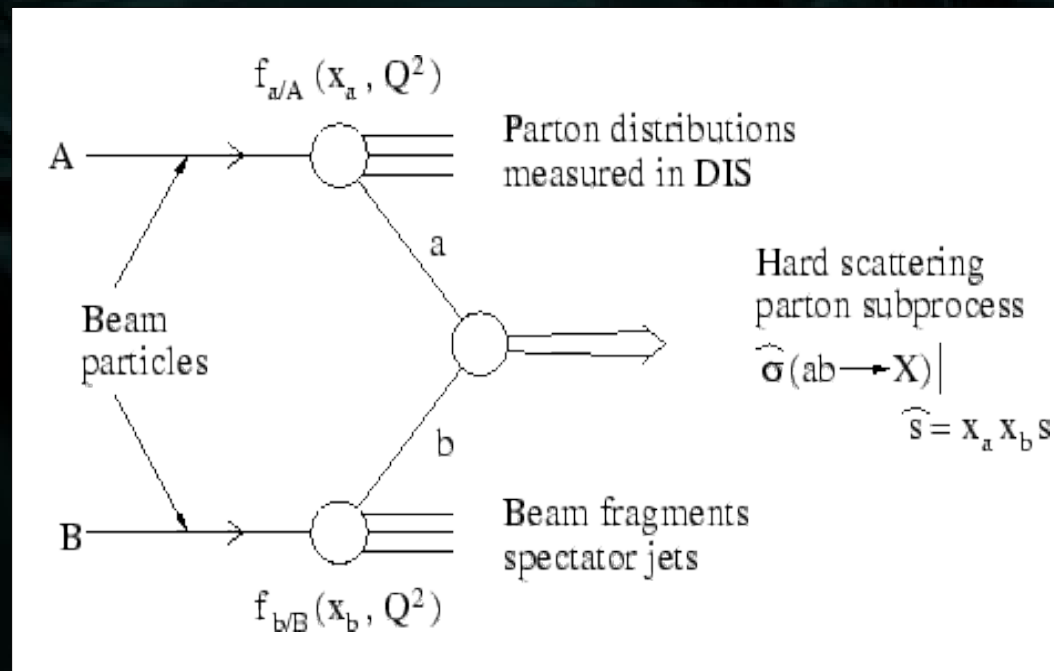

Summary

- Accelerators produce beams of high energy charged particles
- Particle sources – thermionic emission or plasma
- Acceleration methods: electrostatic, on electromagnetic wave (standing or traveling – resonant cavities), plasma acceleration, Fermi mechanism
- Linear and circular accelerators
- Cyclotron: increase orbit radius with energy
- Synchrotron: increase magnetic field with energy
- Bending magnets (dipoles) and focusing magnets (quads) **beam optics**
- Collision point – **luminosity**
- After LHC: linear electron collider

bunches