

RAYOS CÓSMICOS

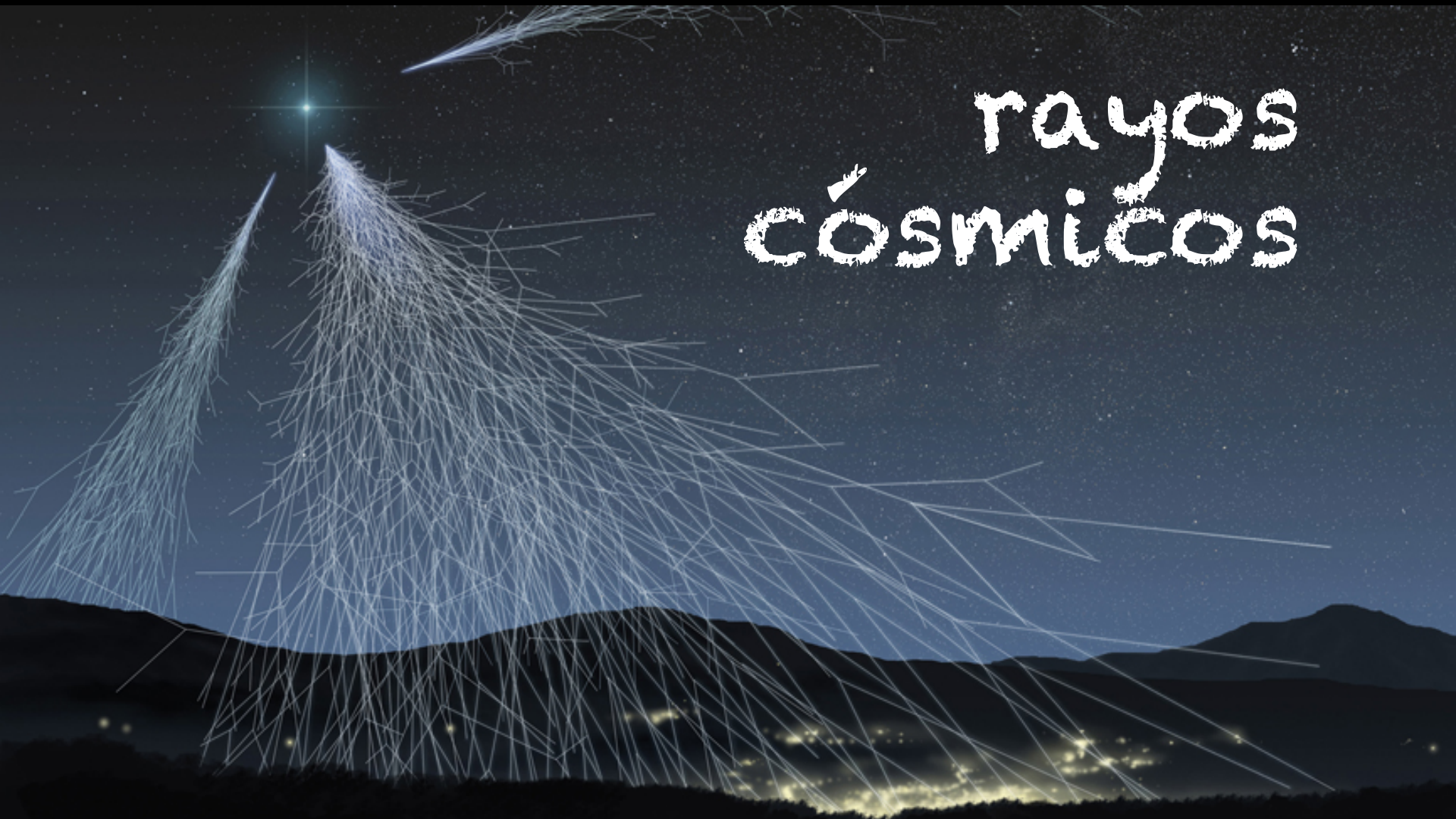

EXCELENCIA
MARÍA
DE MAEZTU

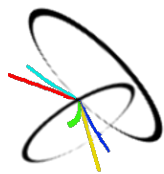

cfp
CIEMAT
física de partículas

Pablo García

CIEMAT, 16 Noviembre 2016

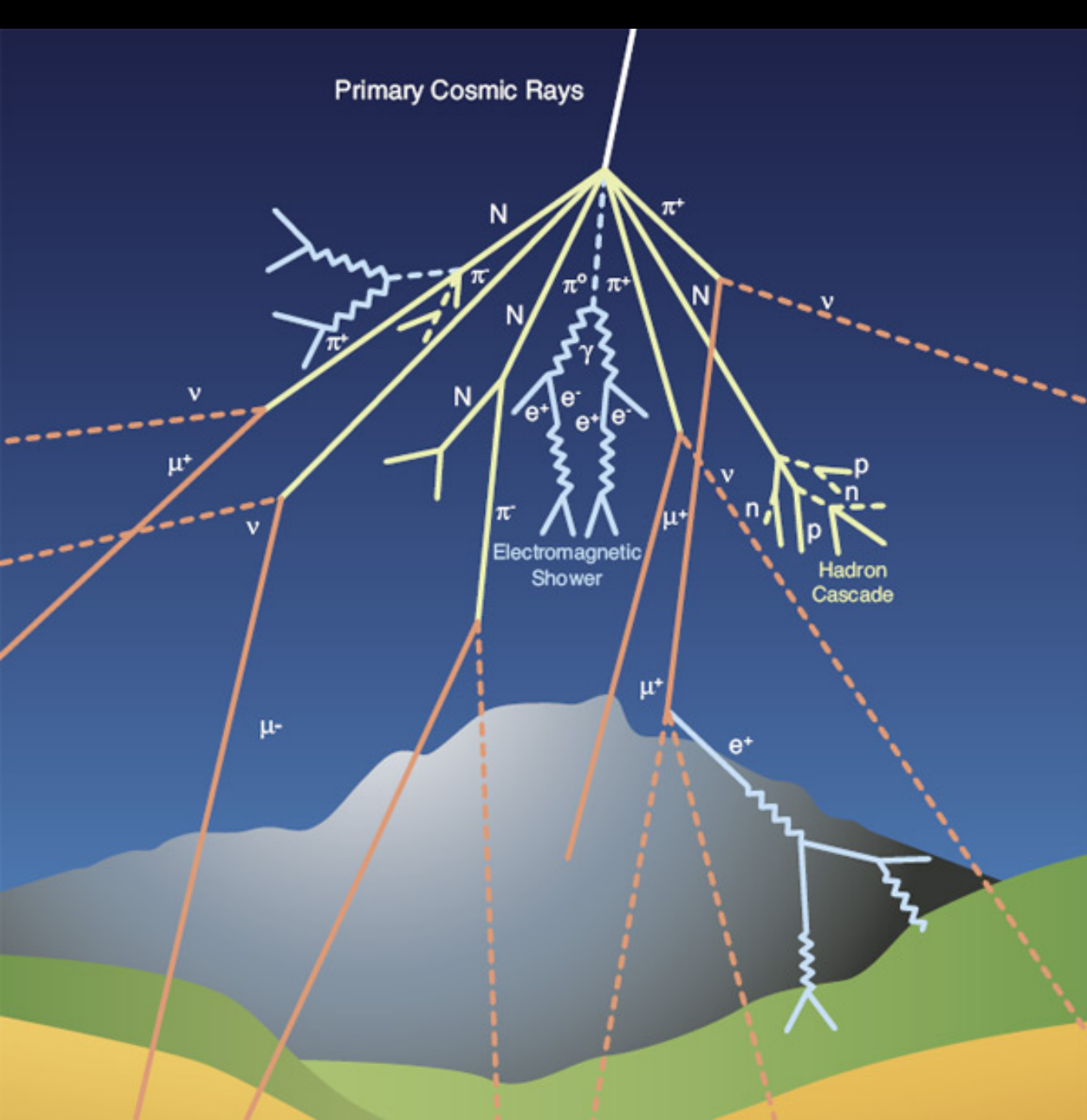

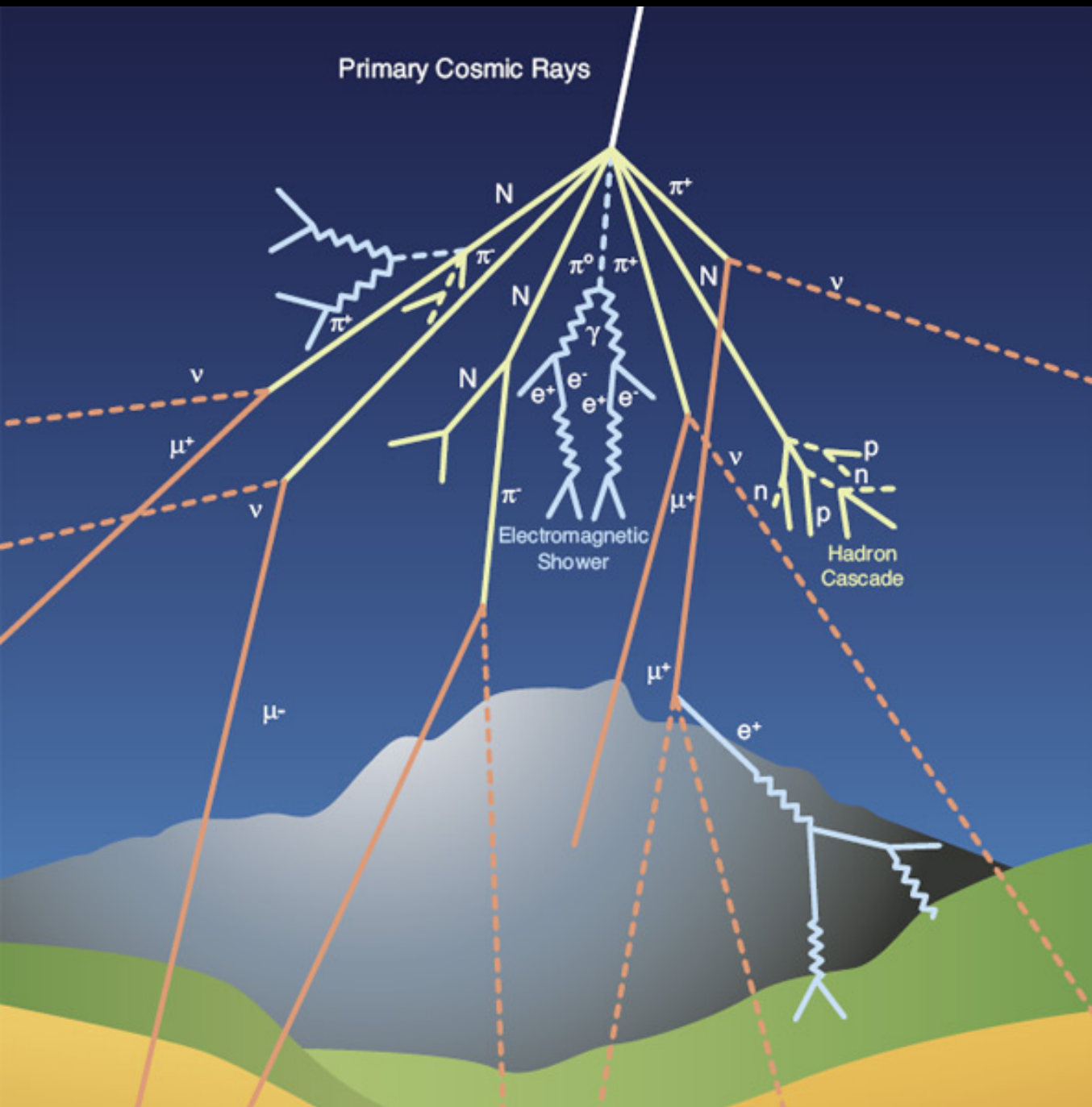

$$v = 0.98 c$$

$$vt = 600 \text{ m}$$

$$d = 10 \text{ km}$$

?

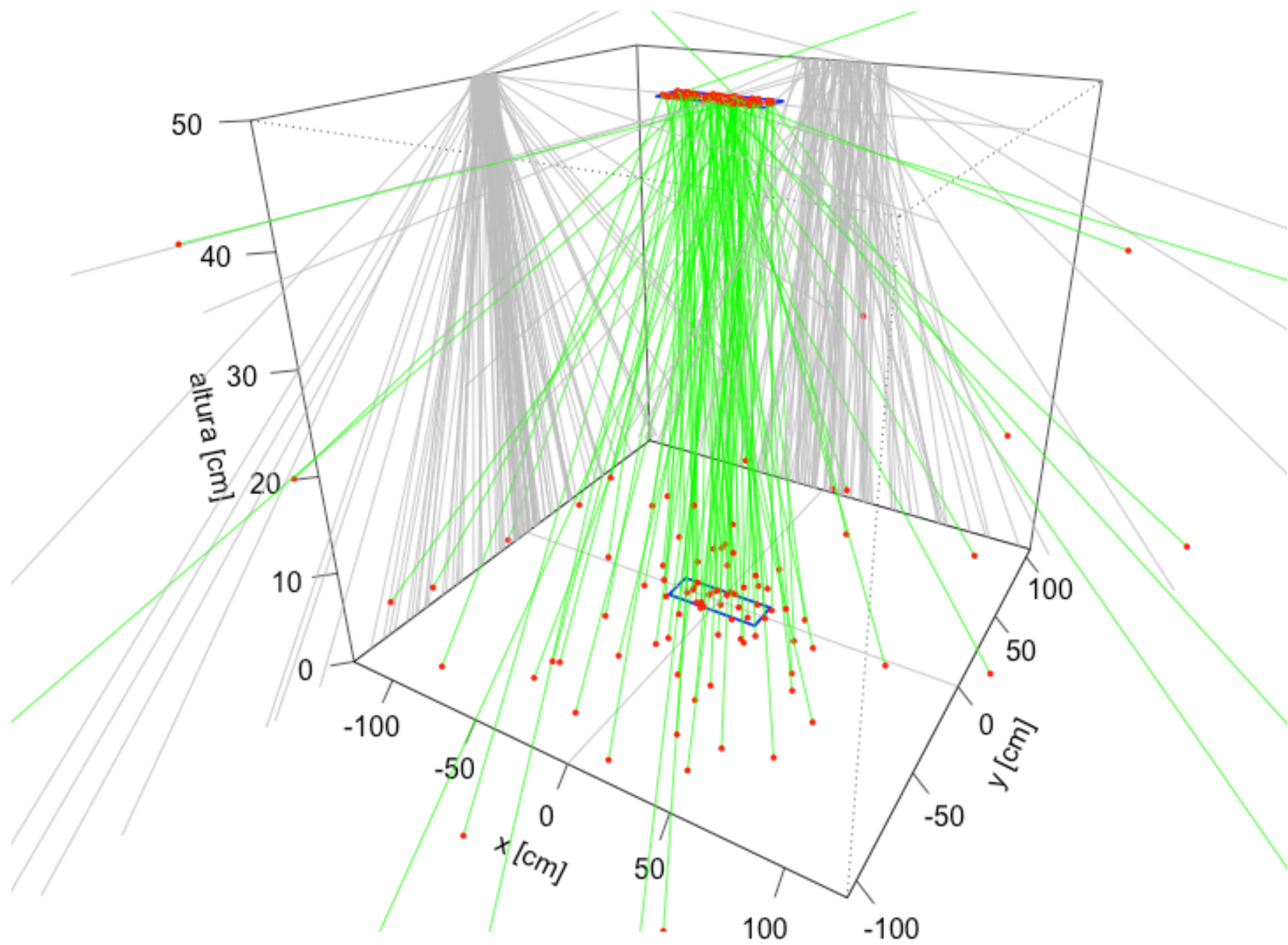

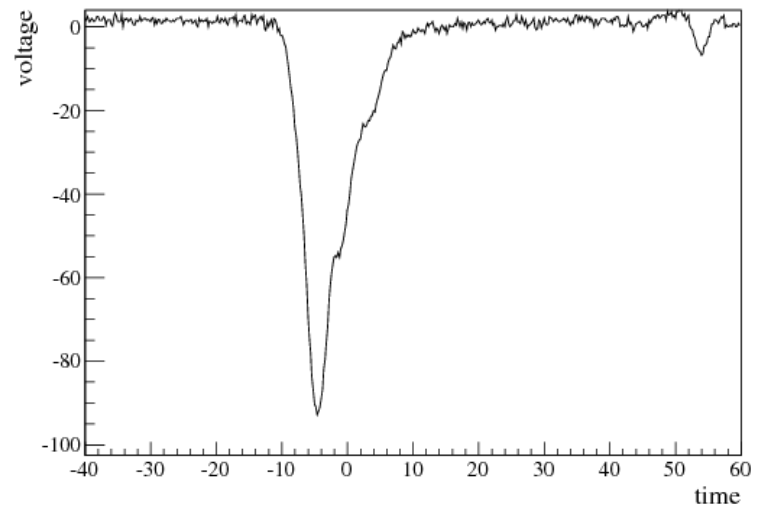
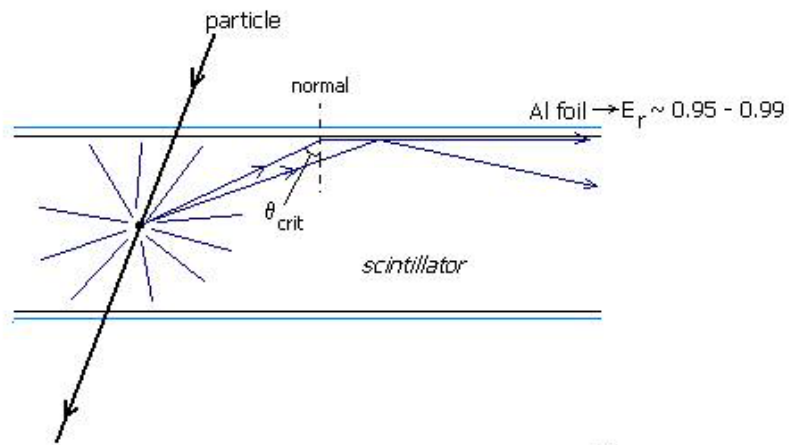

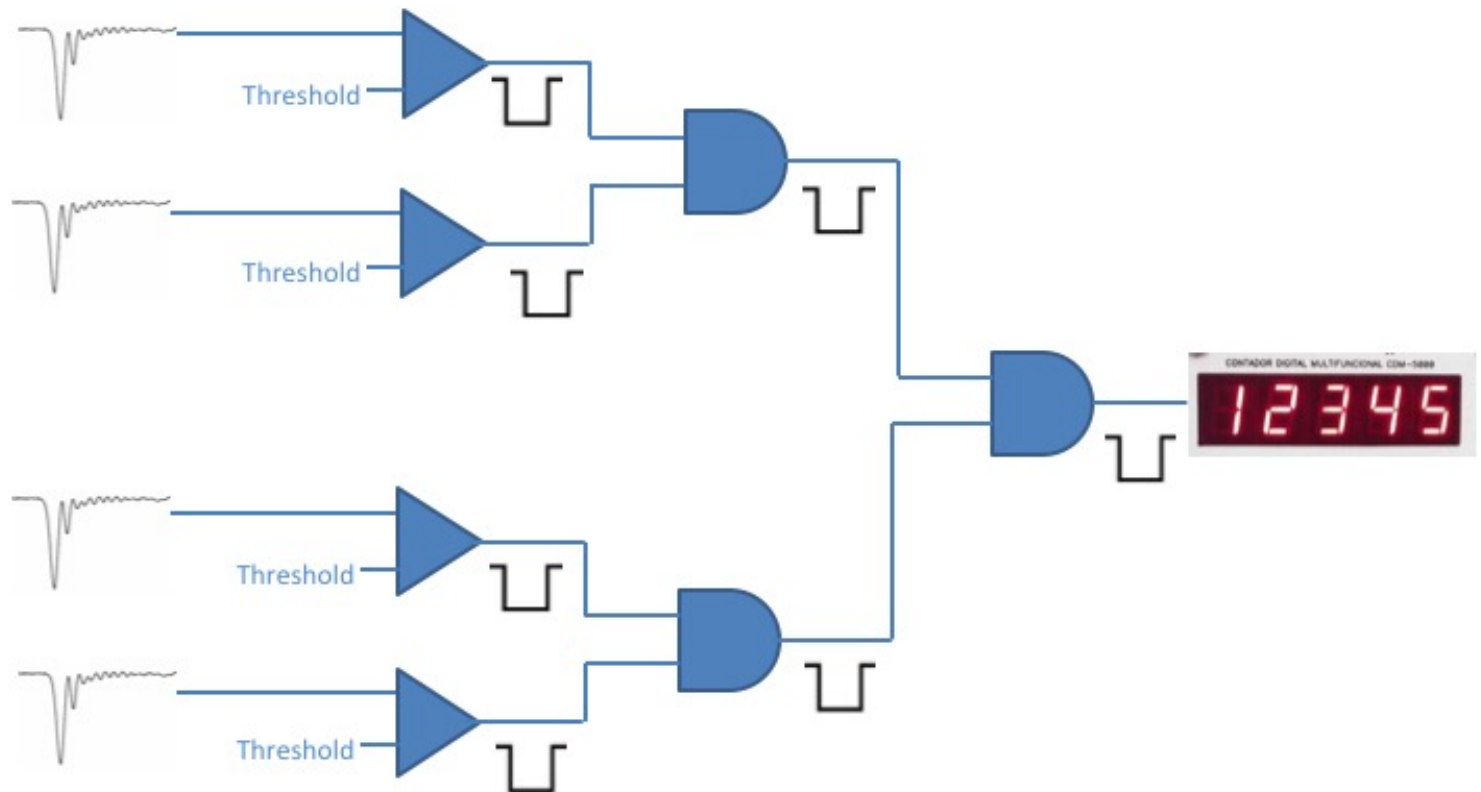
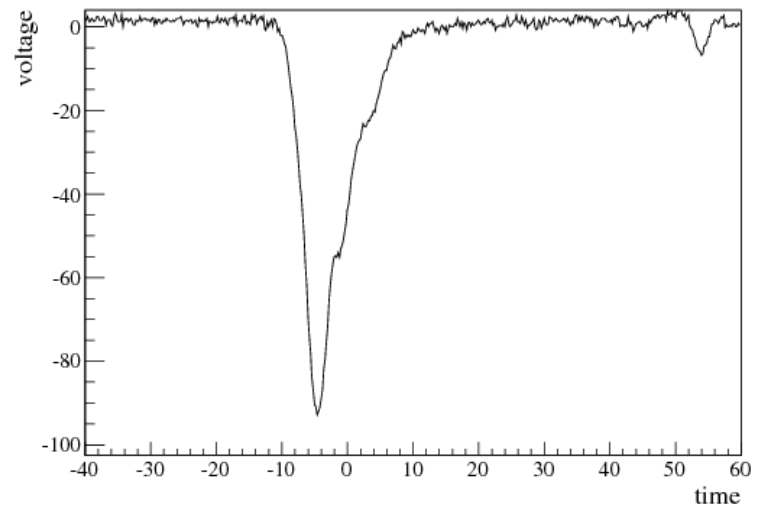
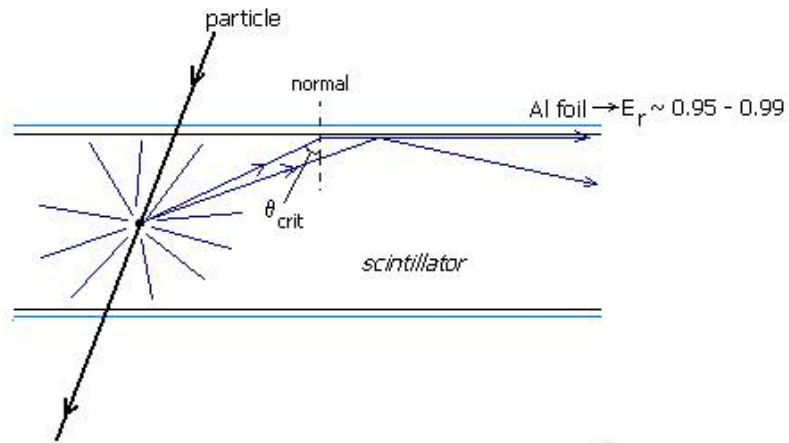

flujo en Madrid \approx
110 muones / m^2 s sr

