

# LHC Injectors Upgrade





## LHC Injectors Upgrade

# Possible issues during stripping foil exchange

R. Froeschl, L.O. Jorat, R. Noulibos, Y. Sillanoli, W. Weterings



# Introduction

In case of an accident during a foil exchange intervention the estimates for the committed effective dose are:

- **25 mSv** due to inhalation
  - **17 mSv** due to ingestion
- ( $1 \times 10^{14}$  H<sup>-</sup>/pulse at 1.11 Hz for 300 days)

These values are well above the limits for radiation workers and annual individual dose objective.



It is recommended that a dedicated procedure for the foil exchange intervention is established defining the protection measures required to prevent the intake of a foil by the intervening personnel.

EDMS Document Number: 1513752



ORGANISATION EUROPEENNE POUR LA RECHERCHE NUCLEAIRE  
EUROPEAN ORGANIZATION FOR NUCLEAR RESEARCH  
Laboratoire Européen pour la Physique des Particules  
European Laboratory for Particle Physics

Occupational Health & Safety and Environmental Protection Unit

*Technical Note*  
CERN-RP-2015-048-REPORTS-TN  
July 20, 2015

## Activation of the stripping foils of the future H<sup>-</sup> charge exchange injection into the PS Booster

R. Froeschl

### Summary

The Linac2 currently injects protons with a kinetic energy of 50 MeV into the PS Booster (PSB). After its connection, the future Linac4 will inject H<sup>-</sup> ions with a kinetic energy of 160 MeV into the PSB. Therefore a new injection system for the PSB will be installed during the connection of Linac4.

The proposed injection system uses a carbon foil (one per PSB ring) to remove the electrons from the H<sup>-</sup> ions and the remaining protons are merged with the already circulating proton beam, activating the stripping foils. The currently foreseen thickness of the carbon stripping foil is 250  $\mu\text{g}/\text{cm}^2$  and each injected proton is assumed to pass, on average, 62.5 times through the stripping foil during the injection phase.

For the most pessimistic case of continuous operation at the maximum Linac4 intensity, i.e.  $1 \times 10^{14}$  H<sup>-</sup> per pulse at 1.11 Hz together for the 4 PSB rings, for 300 days, the estimates for the committed effective dose are 25 mSv due to inhalation and 17 mSv due to ingestion in case of an accident during a foil exchange intervention. These values are well above the limits for radiation workers as well as above the annual individual dose objective.

It is recommended that a dedicated procedure for the foil exchange intervention is established defining the protection measures required to prevent the intake of a foil by the intervening personnel.





# Gluing PSB Foils

Foils are  $200\mu\text{g}/\text{cm}^2$  ( $\sim 1\mu\text{m}$  thick).

- Very fragile to handle, but relatively stable once glued on the fork.
- Gluing to be done in an area without any air circulation.

DRAFT procedure EDMS 1273383





# PSB Foils on the Fork

Undamaged attached foils are quite stable and can be carefully manipulated.

Damaged foils are very unstable and difficult to manipulate, small debris will 'float' in air.

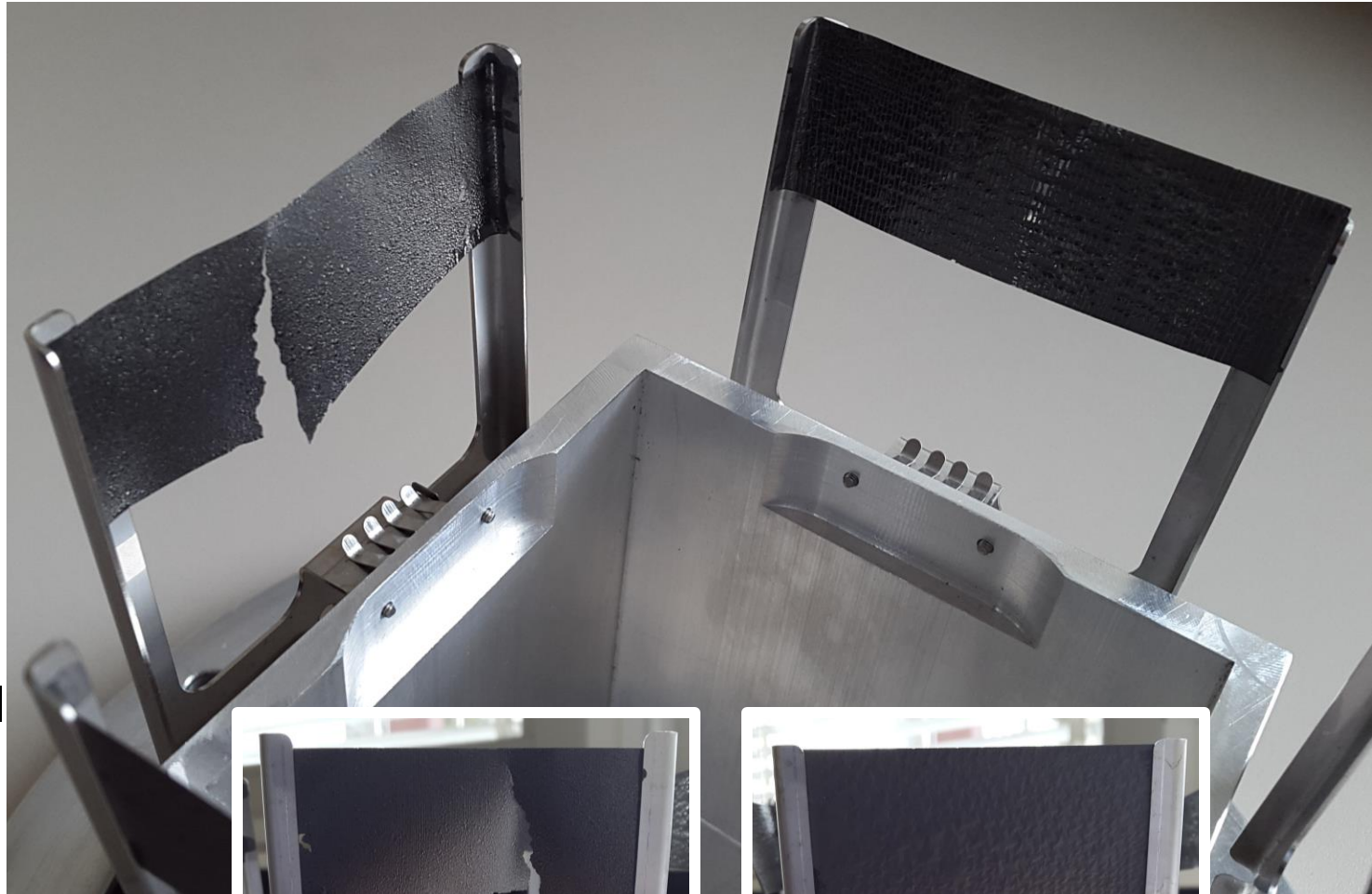



# Foil lab space near the PSB

Ghislain Roy has found lab space in building 37 that BE can loan to TE/ABT for a few years (up to LS2).

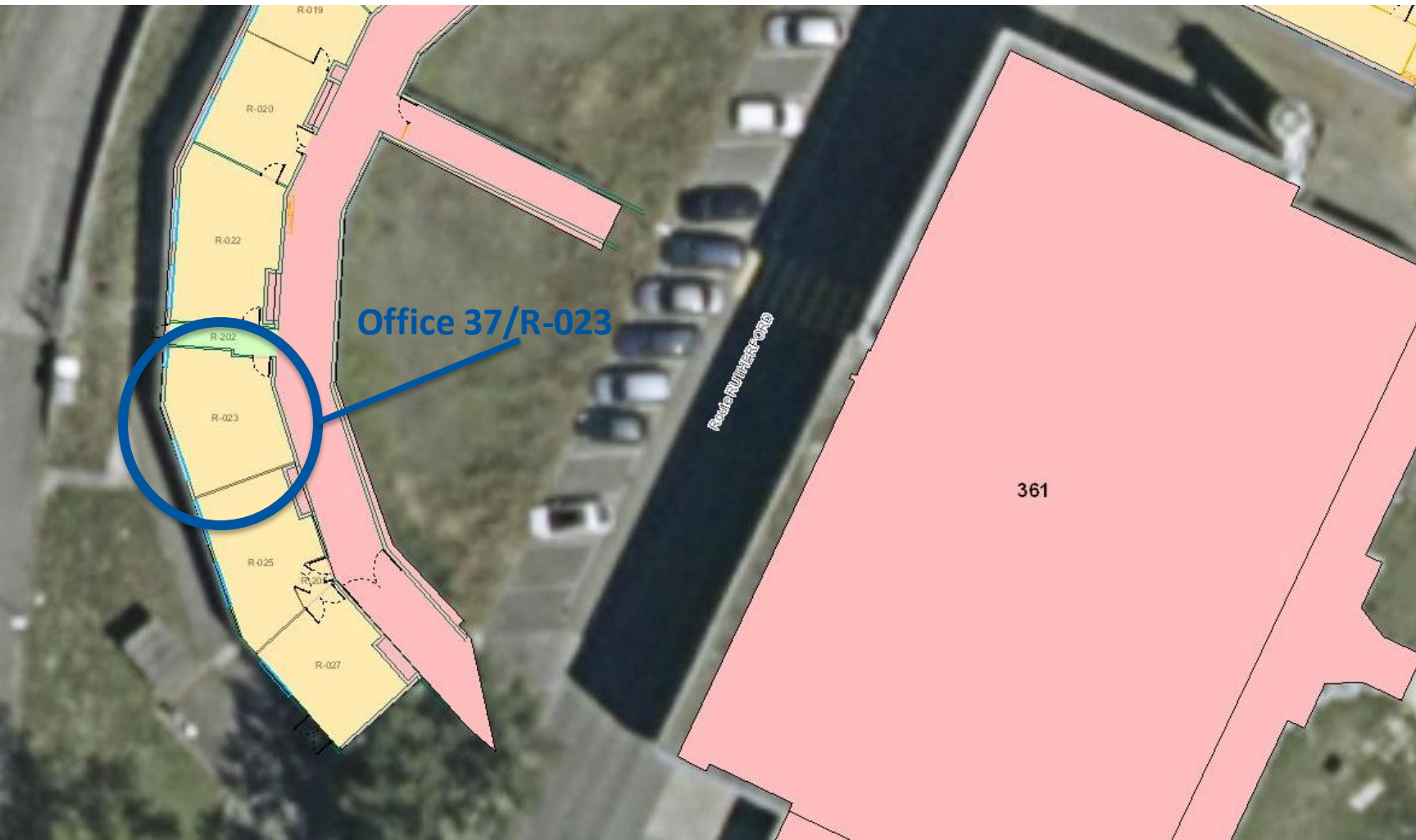



# Injection Region at ISIS



Injection Region with Dedicated Bunker for Foil Changing Mechanism (&hopper)



# Foil Change process at ISIS

ISIS/OPI/107

## ISIS OPERATING INSTRUCTION No. 107

### PROCEDURE TO BE FOLLOWED BEFORE INSPECTING OR CHANGING AN INJECTION STRIPPING FOIL

Changing a Stripping Foil presents potential hazards through radiation exposure and contamination due to possible airborne foil particles. The removal and insertion operation is delicate in nature and requires a high degree of control. New foils can be readily damaged by not following the instructions below or by careless handling.

- f. Close both sets of Roller Shutter doors in R6 (East and West side of EPB2) and post signs at the controls to forbid the opening during a foil change.
- g. Switch off ventilation fans for EPB1 and EPB2 at controllers located in R55 and R6 respectively. Photographs are shown in Appendix B.
- h. Switch off the synchrotron room air conditioning in order to reduce the risk of damage to delicate foils. Photographs are shown in Appendix B.

### FOIL REMOVAL (Health Physics support necessary)

- 7 Ensure that all foil changing personnel are wearing coveralls, 2 pairs of disposable gloves, 2 pairs of overshoes and a respirator. Health Physics will set up and run an air sampler in the area as required. This activity must cease before the new foil is removed from its box.

11 Switch the extract fan 'ON' (switch in the down position) to allow loose remnants of foil to be sucked into the hopper. Audibly check that the fan is on before proceeding.

12 Allow sufficient time for the foil extract fan to perform its function then proceed to

### FOIL INSTALLATION

(All operations should be carried out very slowly and carefully to prevent air movements from breaking up the foil)

Foil Exchange mechanism with "Hopper" to evacuate used foils.







# Foil Change process at J-PARC

Journal of Radioanalytical and Nuclear Chemistry, Volume 305, Issue 3, pp 865-873

## Maintenance of radio-activated stripper foils in the 3GeV RCS of J-PARC

M. Yoshimoto, Y. Yamazaki, P.K. Saha and M. Kinsho

Japan Atomic Energy Agency / J-PARC

2-4 Shirane, Shirakata, Tokai, Naka-gun, Ibaraki, 319-1195, Japan

I. Sugai and Y. Irie

High Energy Accelerator Research Organization / KEK

Oho 1-1, Tshukuba, Ibaraki, 305-0801, Japan

In order to understand the reason for such high residual dose around the stripper foil, a numerical simulation was done by using PHITS Monte Carlo code. It shows that secondary neutrons and protons generated by nuclear reactions in the stripper foil at high energy and high power beam irradiation are the major sources for high residual dose at the injection area. Furthermore, the nuclear reactions at the stripper foil induce the radio-activation of the stripper foil itself and the foil frame. The residual dose rate after retrieving the irradiated foil measured by a GM survey meter was several mSv/h on contact and nuclear species of Be-7 and Na-22 were observed by a handy type of Germanium (Ge) semiconductor detector. The radio-activation of the stripper foil itself is an intrinsic problem and thus maintenance scenario of the stripper foil at the highly-dosed environment is one of the most important issues for the high intensity accelerators.

In the J-PARC RCS, the foil exchange devices were improved according to the new maintenance scenario which aims to keep radiation exposure to staffs as low as possible and to reduce the risk of the radioactive foils break up or disperse. In addition, various analyses of the irradiated stripper foils can be carried out if the foils can be retrieved from the tunnel without breaking.



Figure9 : Retrieval of the radioactive foils from the holder storage rack.

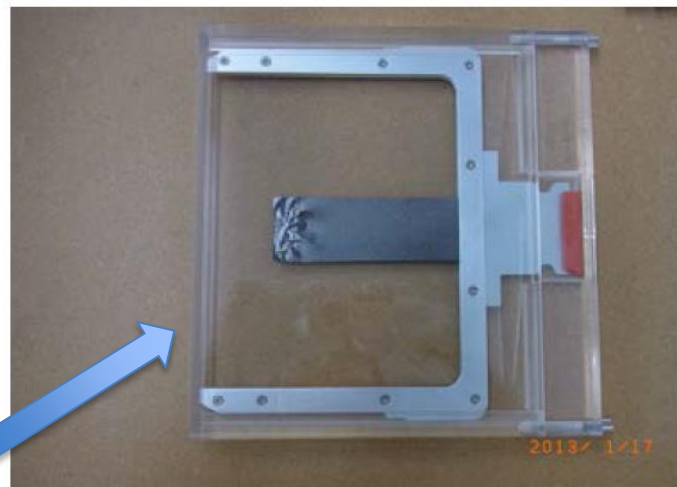

Figure10 : A photograph of the foil preserving case.





# Foil Change process at J-PARC

Proceedings 10th Annual Meeting of Particle Accelerator Society of Japan, p.915 - 919, 2014/06

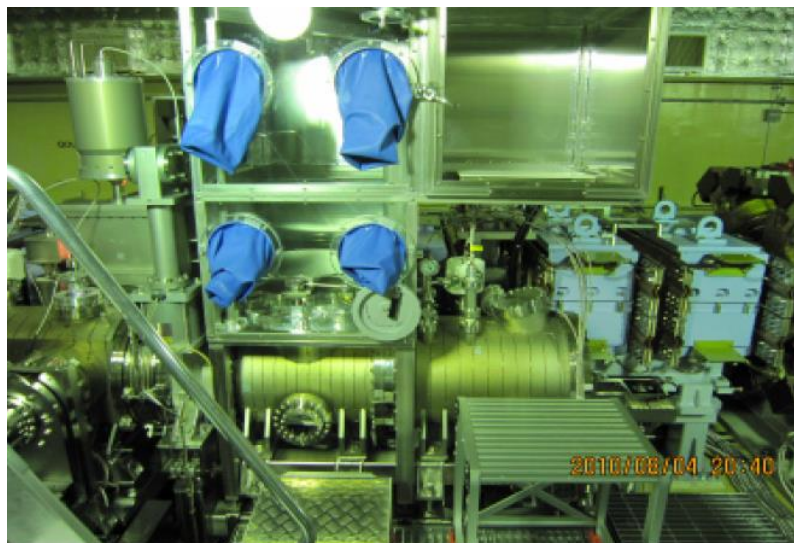

Figure 2 : A Photograph of the foil retrieving booth assembled on the vacuum chamber.



Figure9 : Retrieval of the radioactive foils from the holder storage rack.



Figure 5 : Sealing box installation into the foil retrieving booth.



Figure10 : A photograph of the foil preserving case.





# Foil Change process at SNS

M. Plum, High power Strippers and Targets Workshop, NSCL- Michigan State University, December 2009

## All six foils used for production beam from March to the May 19, 2009 change out

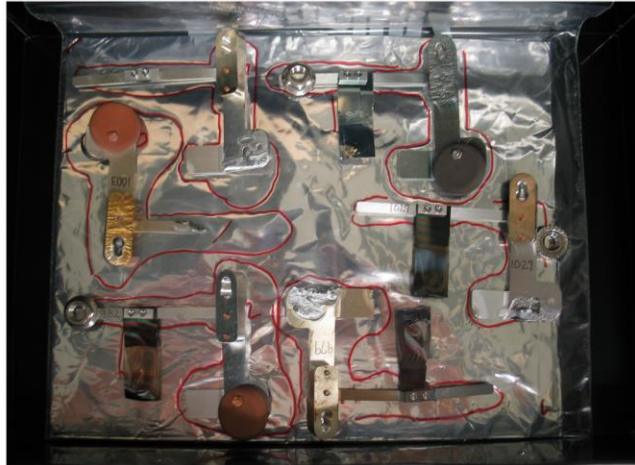

44/35 Managed by UT-Battelle for the Department of Energy

MSU Workshop Dec 6-8, 2009



Autoradiography October 5, 2009, of foils loaded May 19 and removed ???



45/35 Managed by UT-Battelle for the Department of Energy

MSU Workshop Dec 6-8, 2009



## Foil failures



6/35 Managed by UT-Battelle for the Department of Energy

MSU Workshop

(Used for high intensity run July 11-13)



Photos by Chris Luck

Slides show that foils at SNS are recuperated after beam operation and stored for future reference and to study the foil failures....





# Possible Foil Change process at CERN

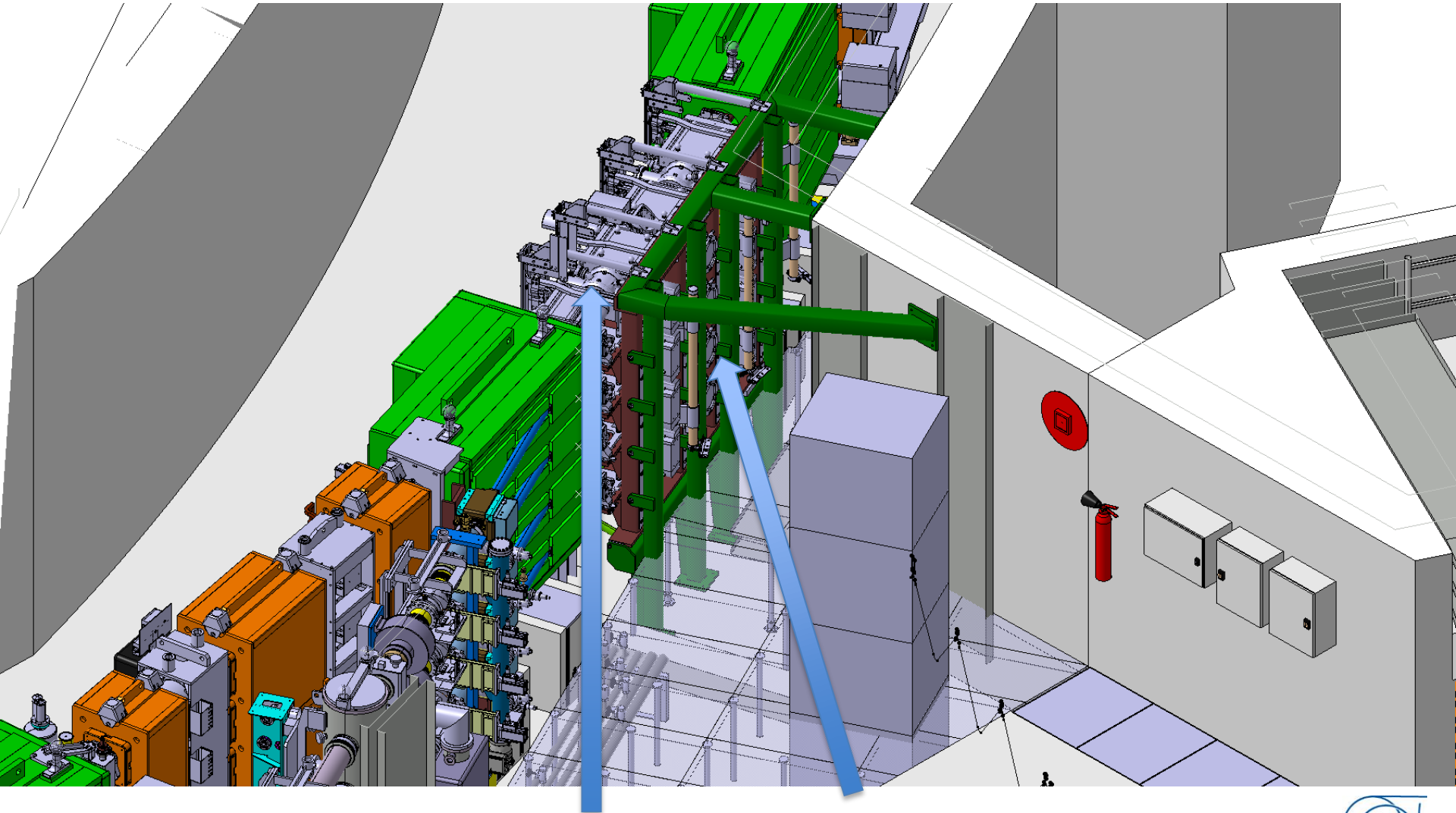

Injection Region with Foil Changing Mechanism



# Possible Foil Change process at CERN

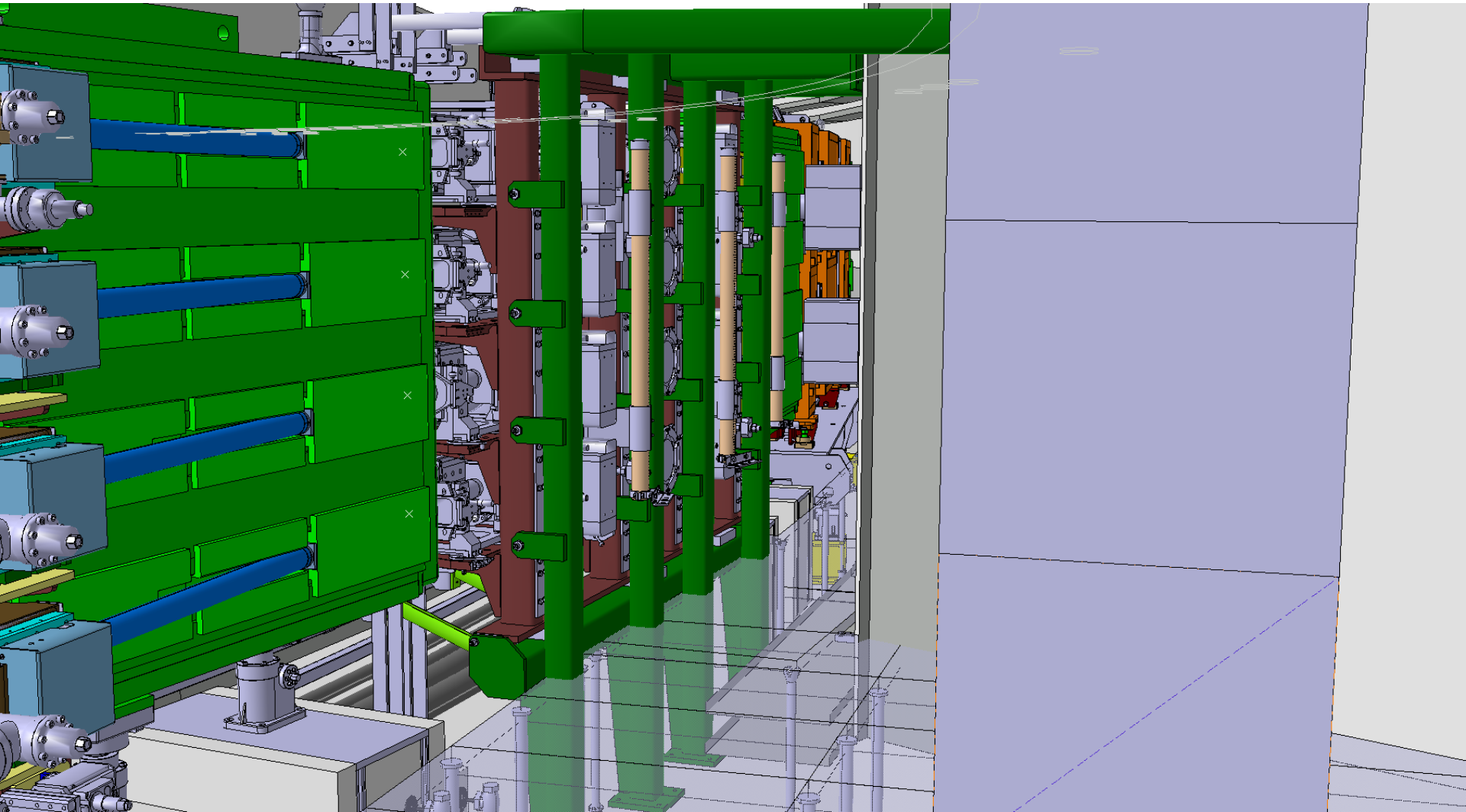

Injection Region with Foil Changing Mechanism



# Possible Foil Change process at CERN

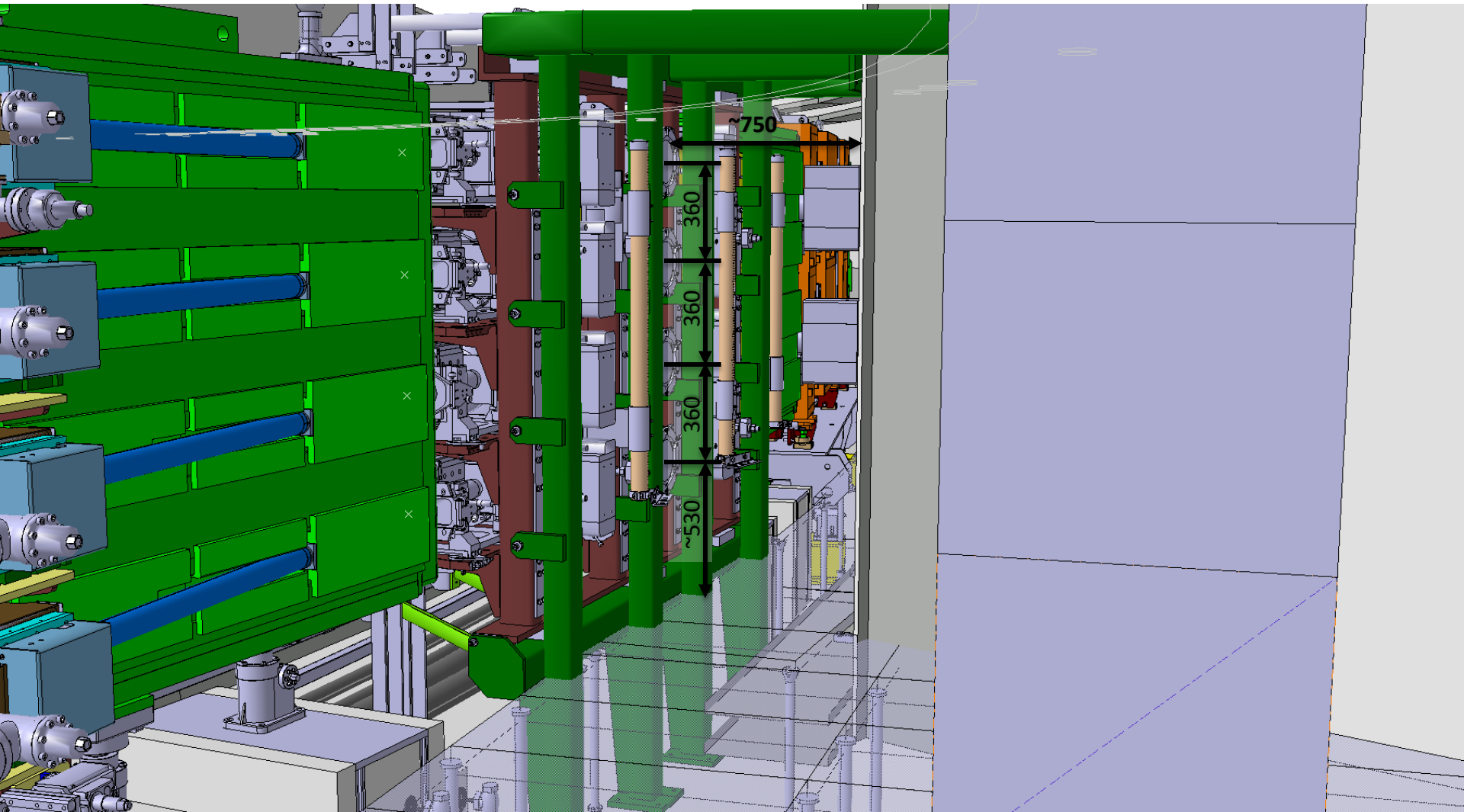

Available Space



# Possible Foil Change process at CERN

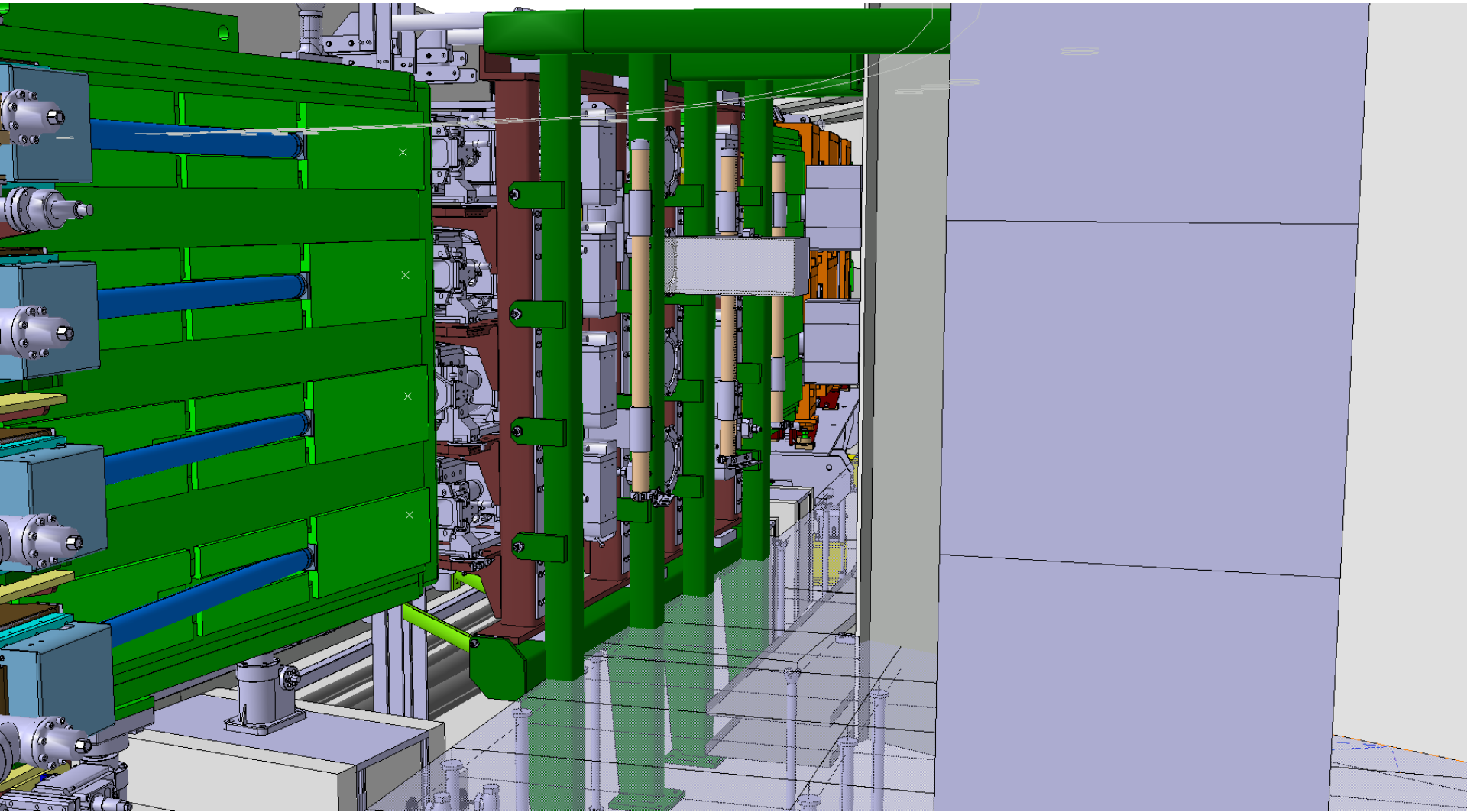

Remove vacuum flange and Installation of Foil Exchange Box



# Possible Foil Change process at CERN

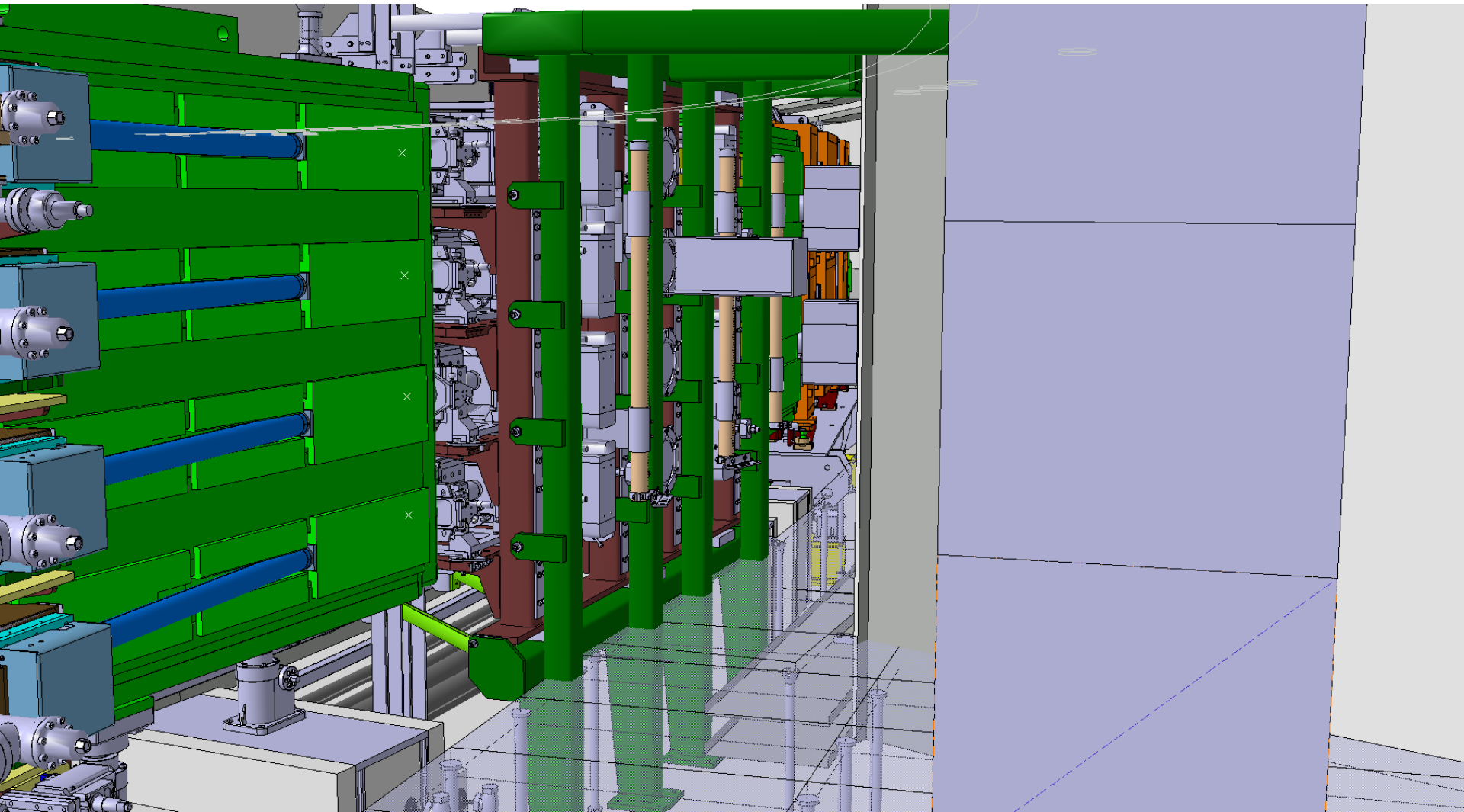

Open side panel of Foil Exchange Box





# Possible Foil Change process at CERN

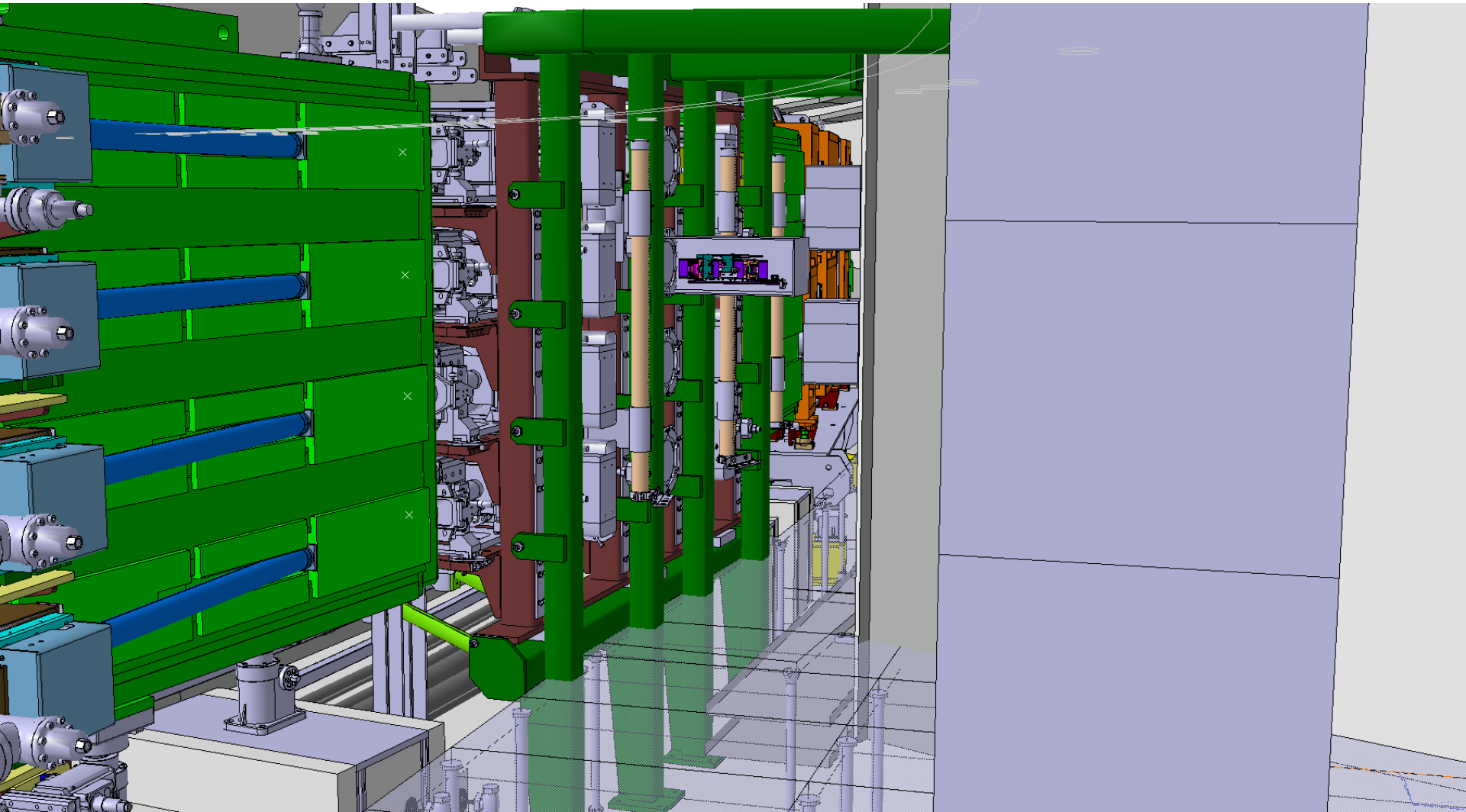

Open side panel and retract mechanism



# Possible Foil Change process at CERN

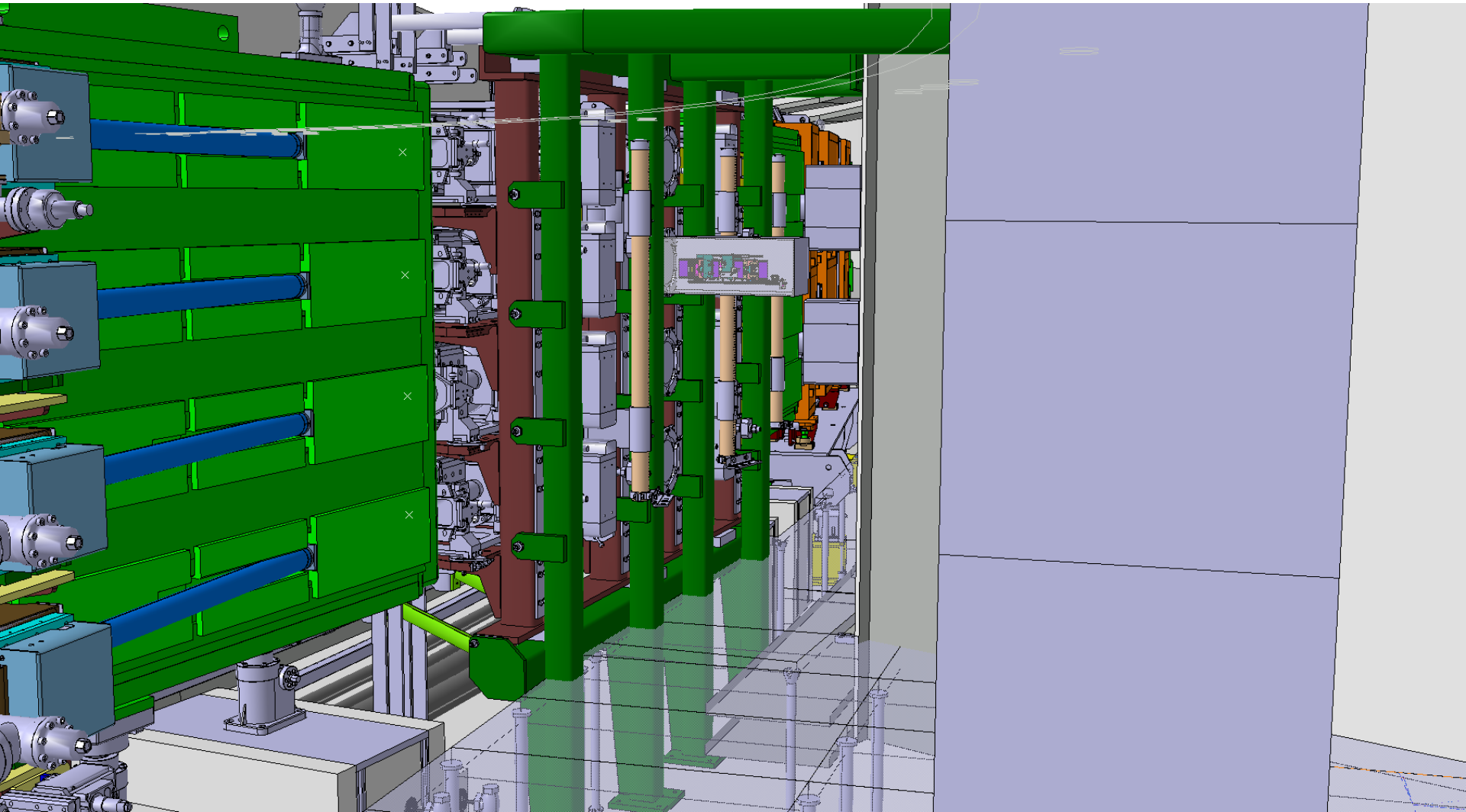

Close side panel of Foil Exchange Box



# Possible Foil Change process at CERN

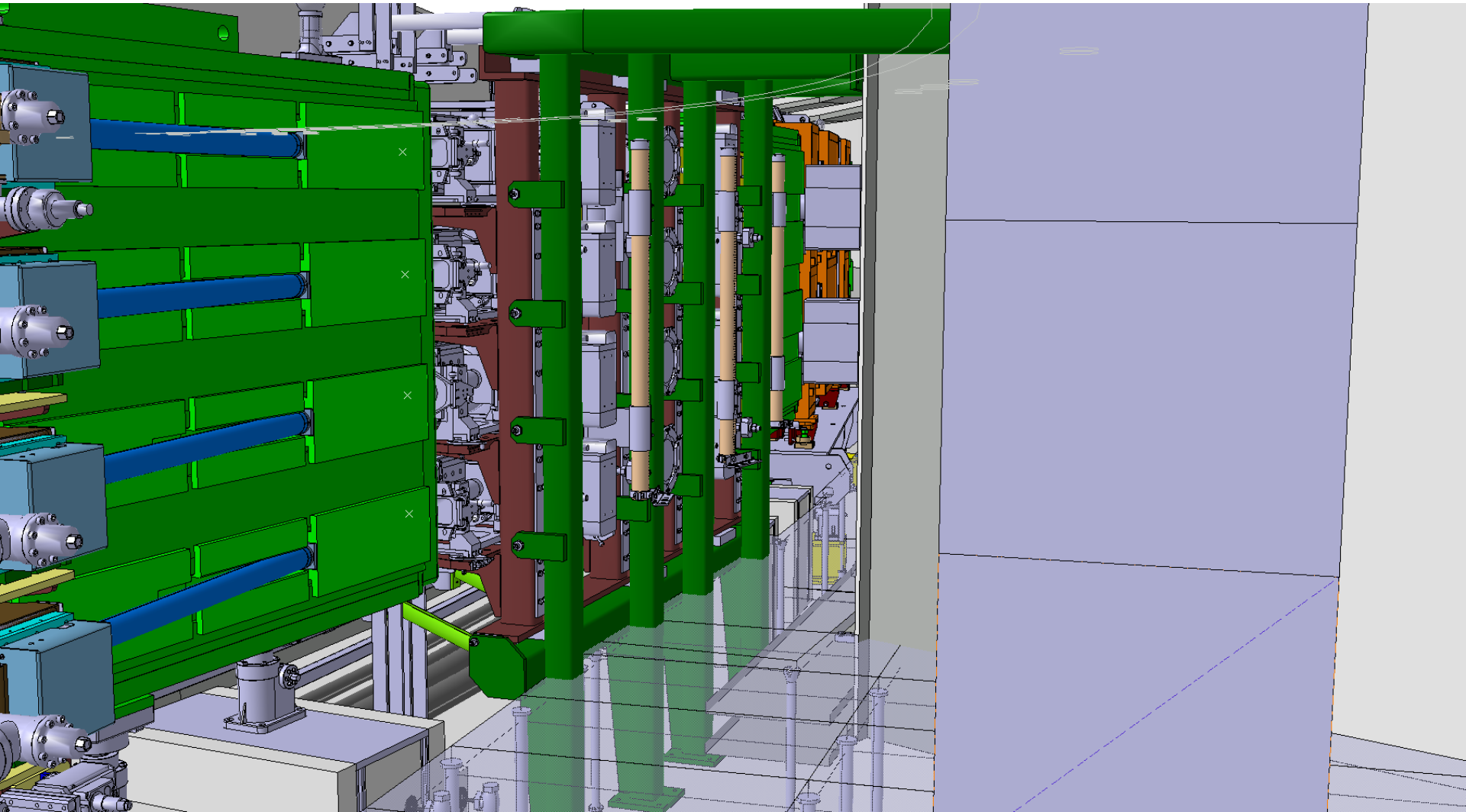

Removal of Foil Exchange Box



# Possible Foil Change process at CERN

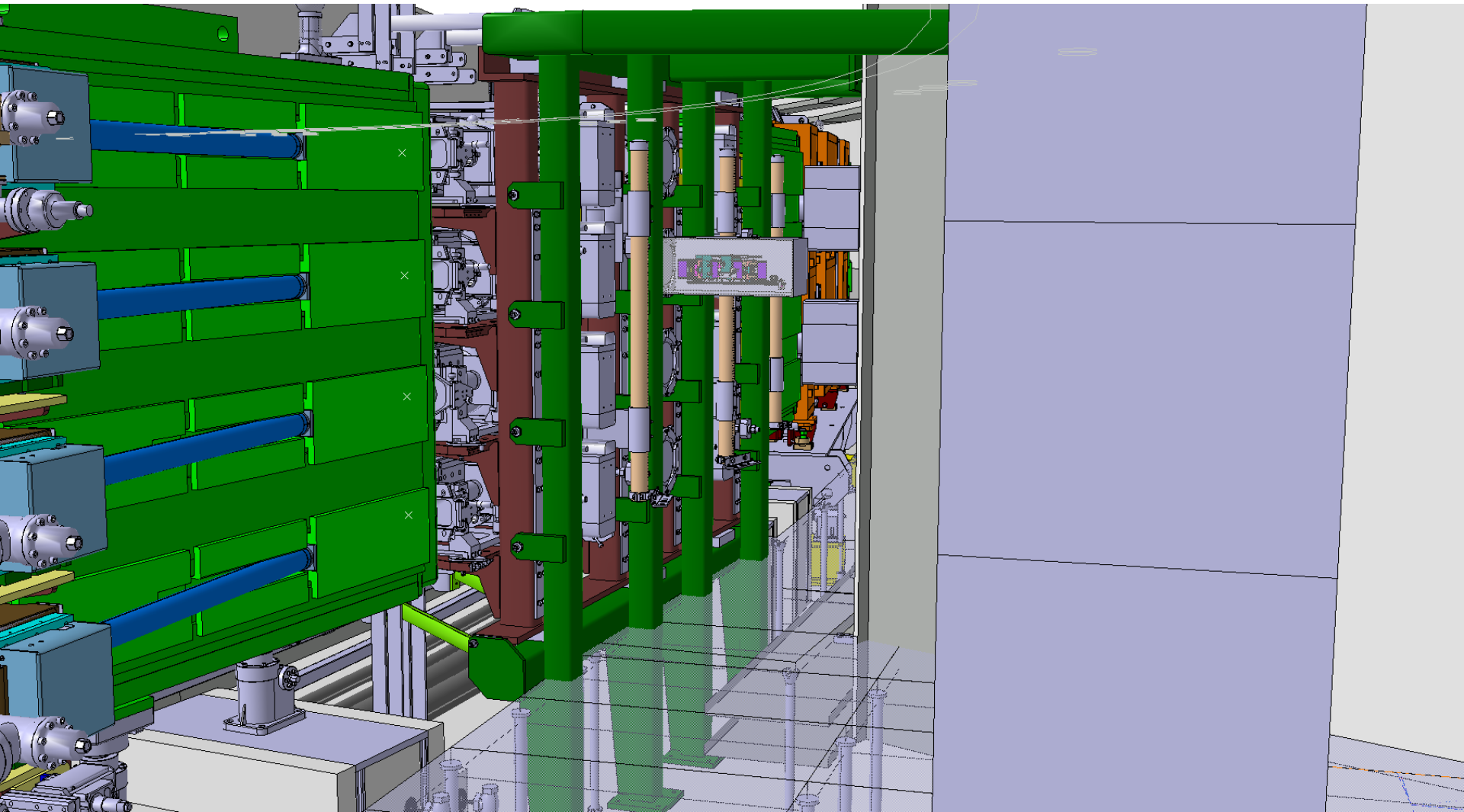

Installation of Foil Exchange Box with new mechanism for installation procedure



# Possible Foil Change process at CERN

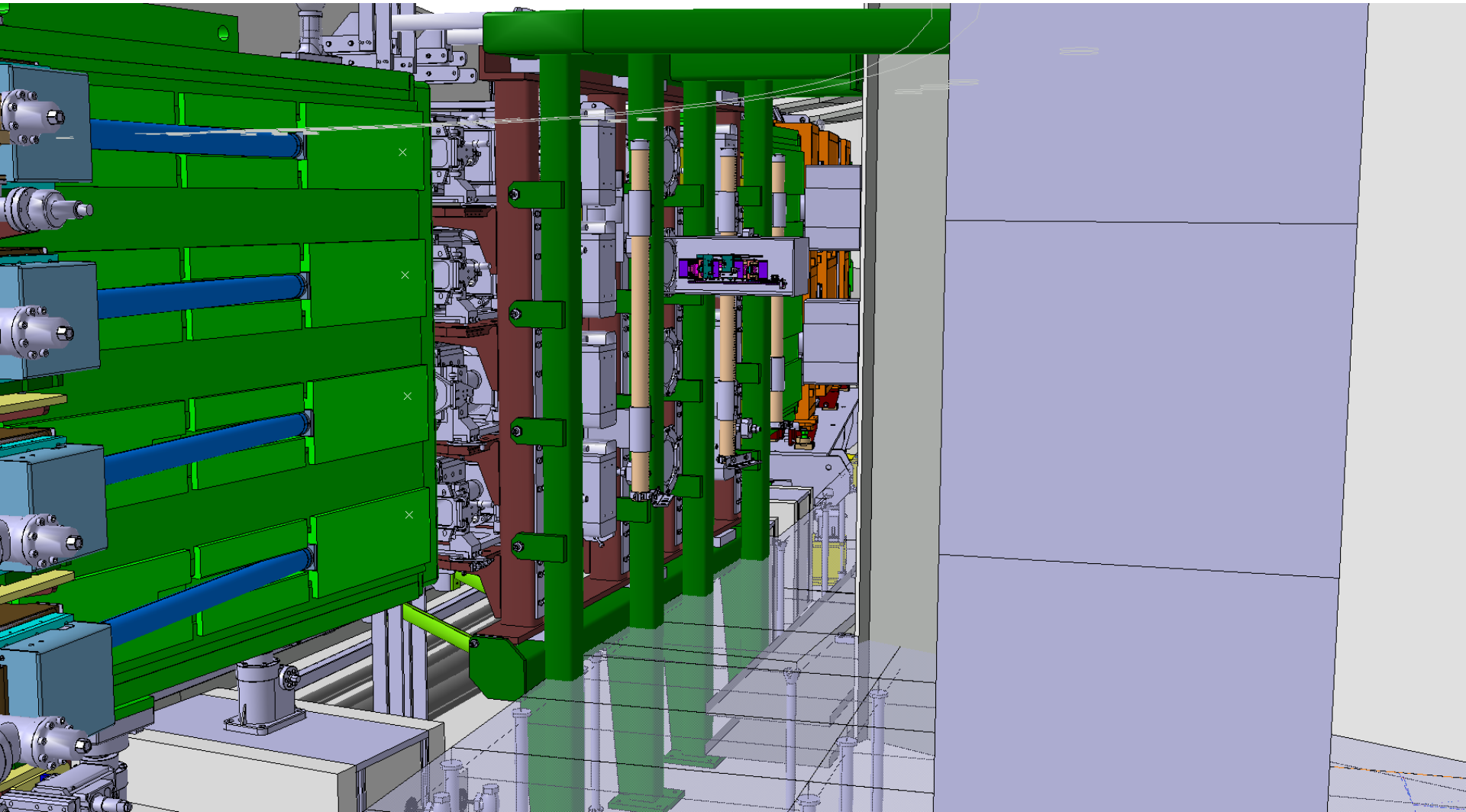

Open side panel of Foil Exchange Box



# Possible Foil Change process at CERN

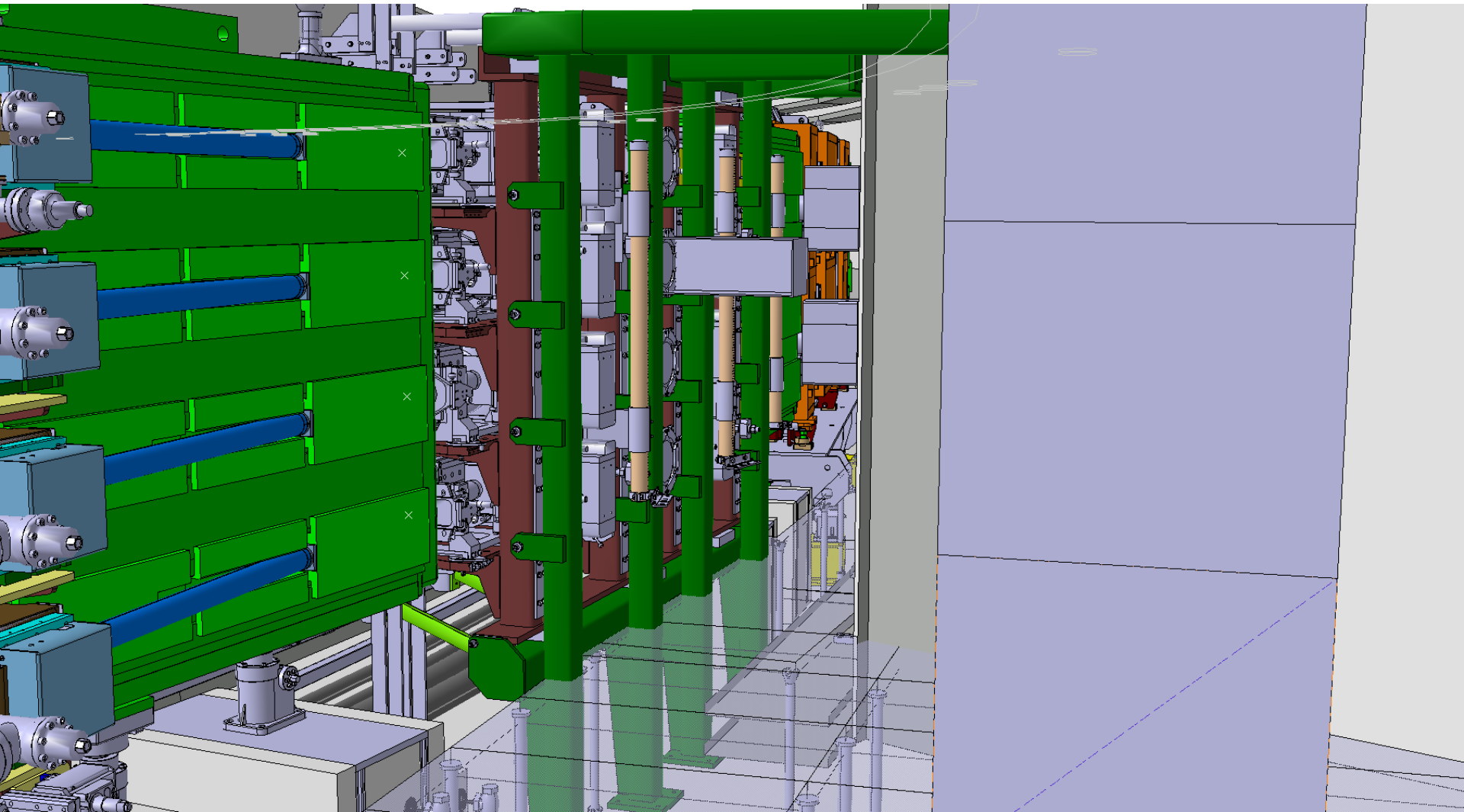

Install mechanism



# Possible Foil Change process at CERN

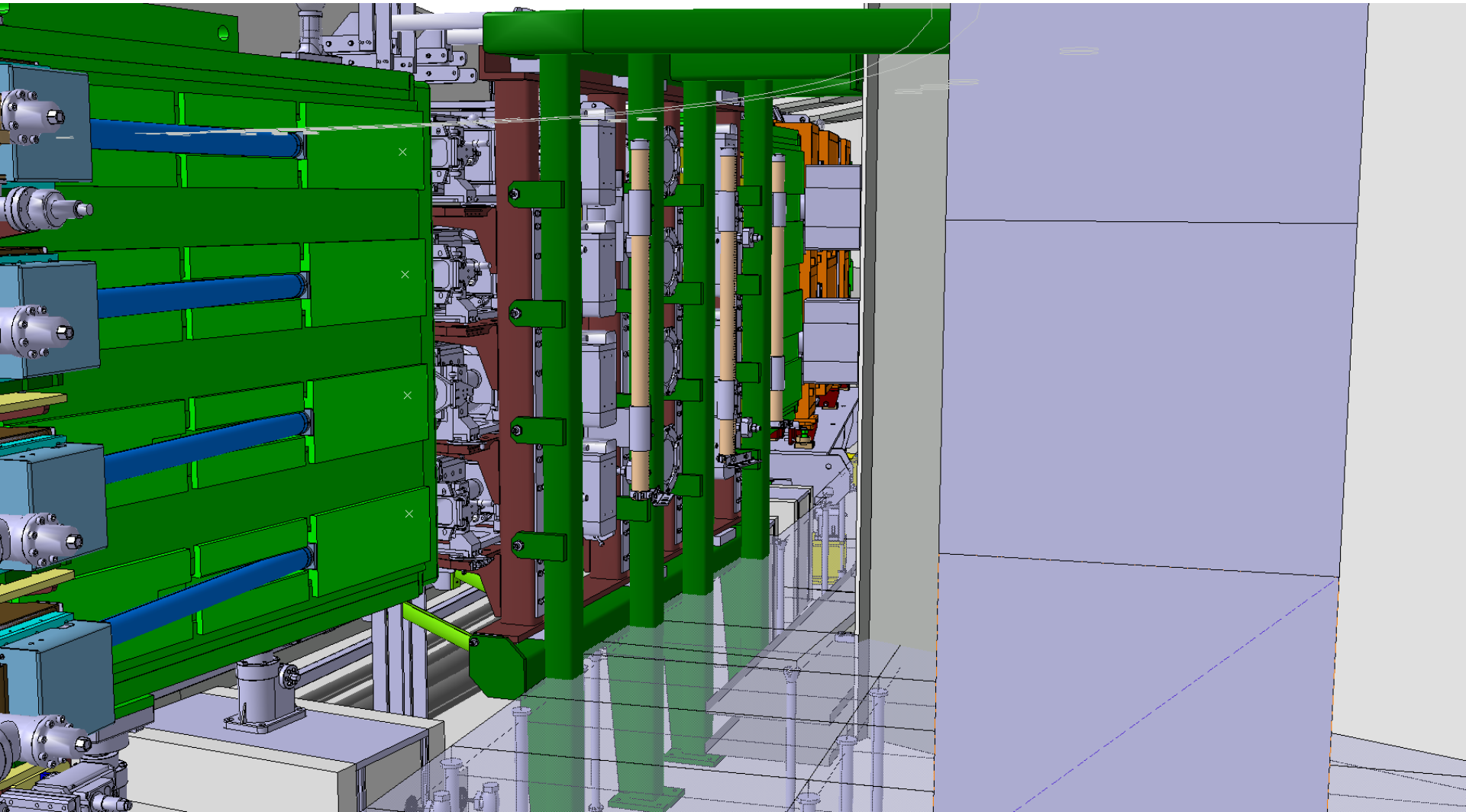

Removal of Foil Exchange Box



# Available space

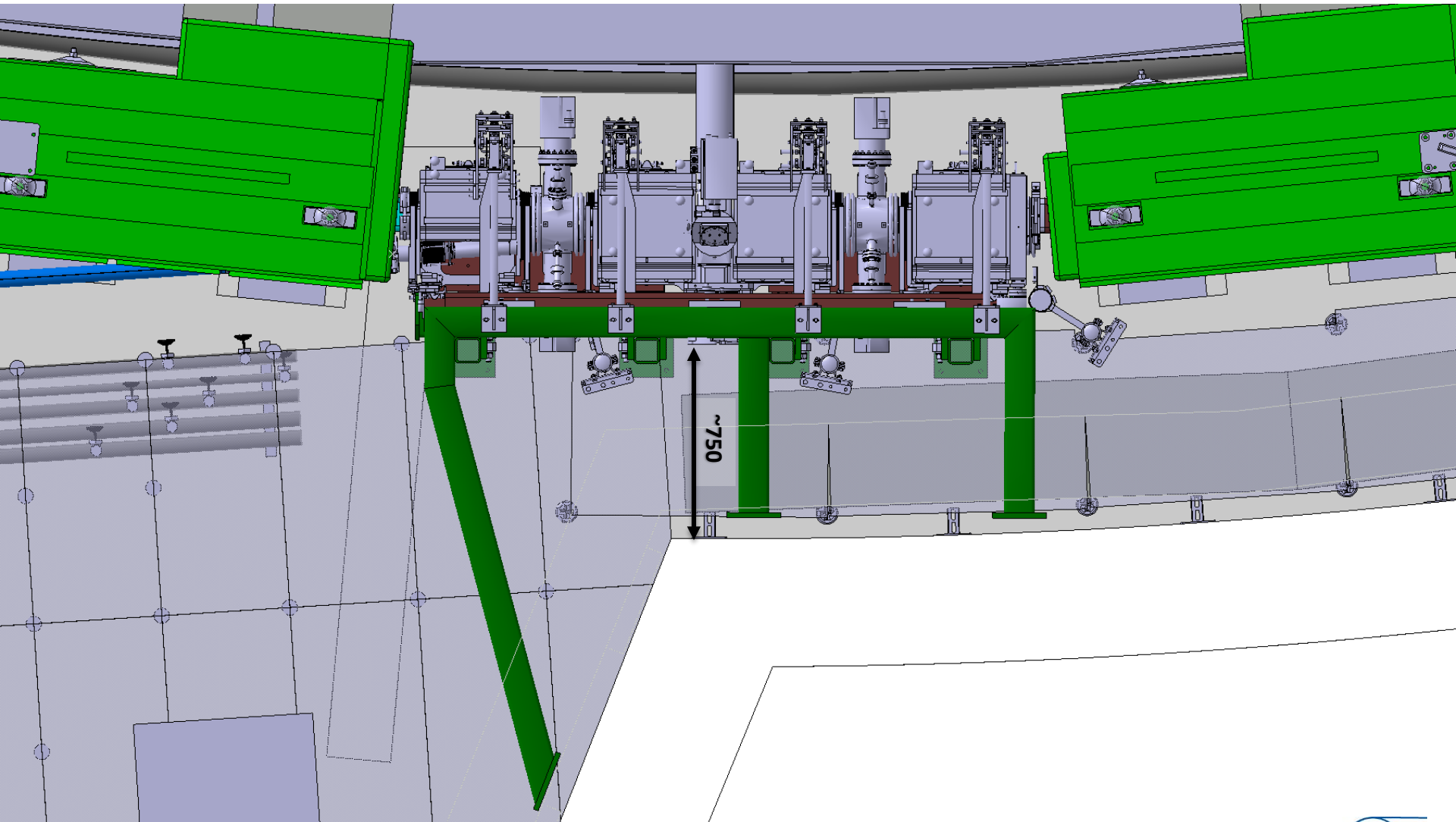

Open side panel and retract mechanism





# Available space

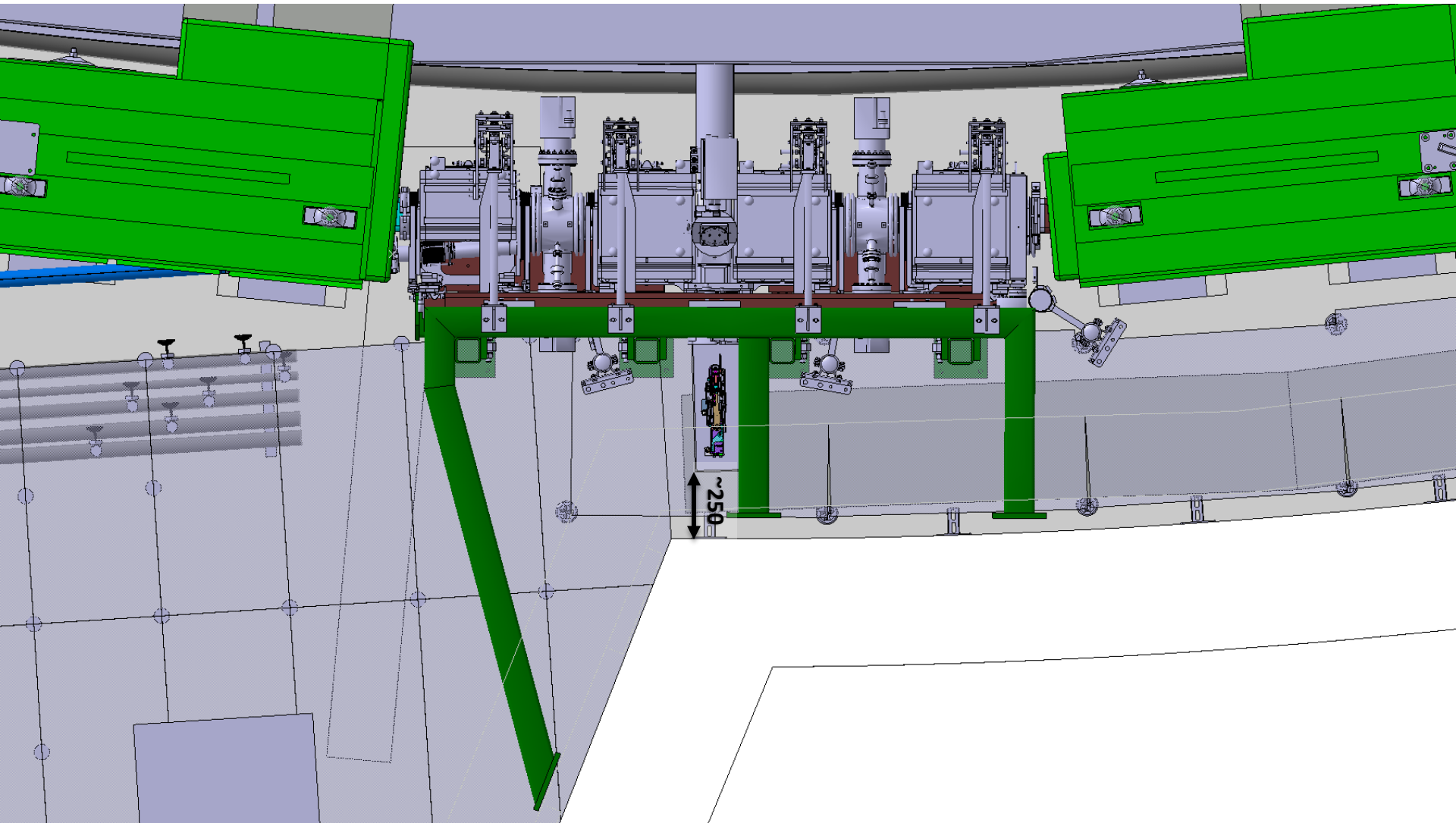

Top View with Foil Exchange Box



# Foil Change process at level 1

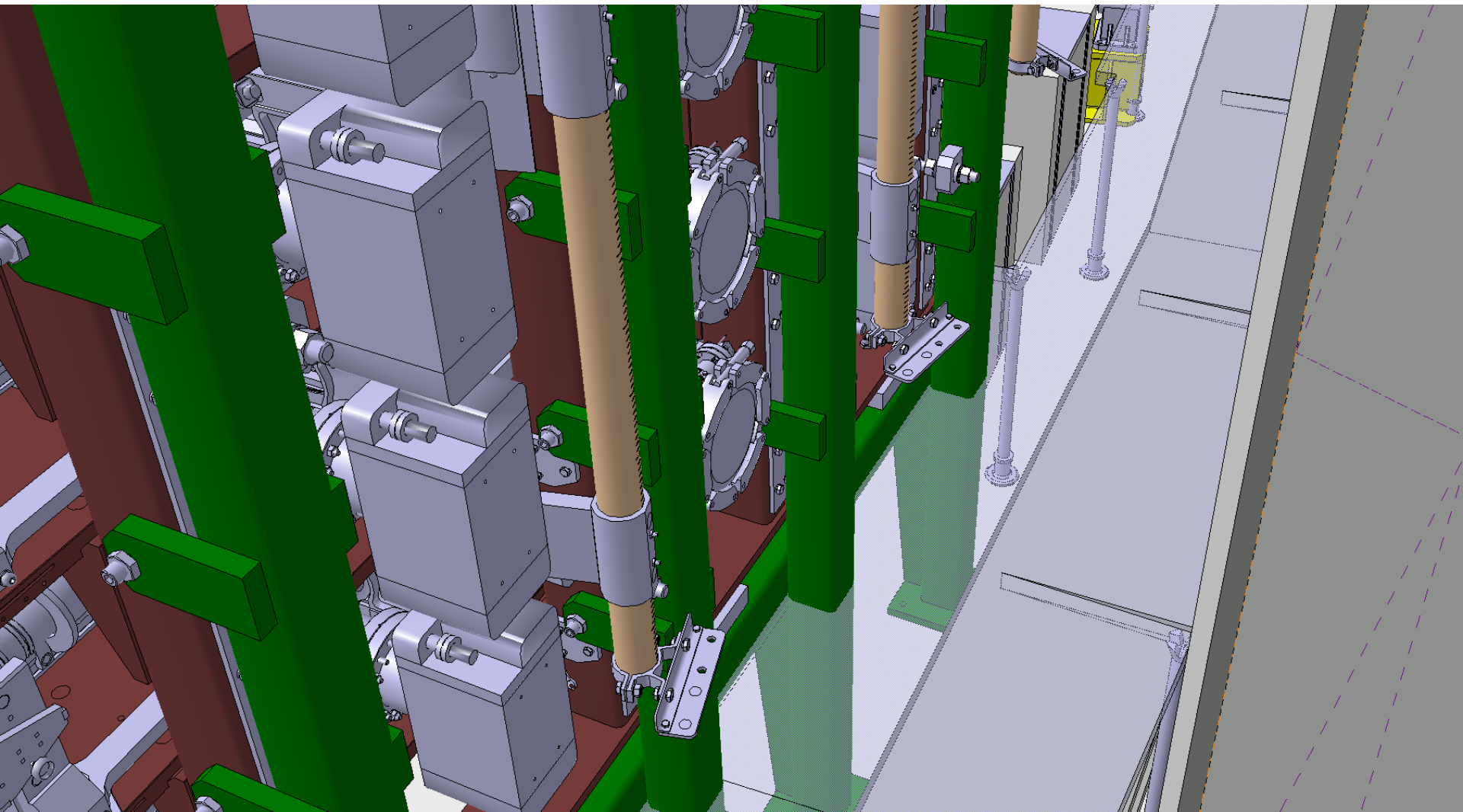

Available Space



# Foil Change process at level 1

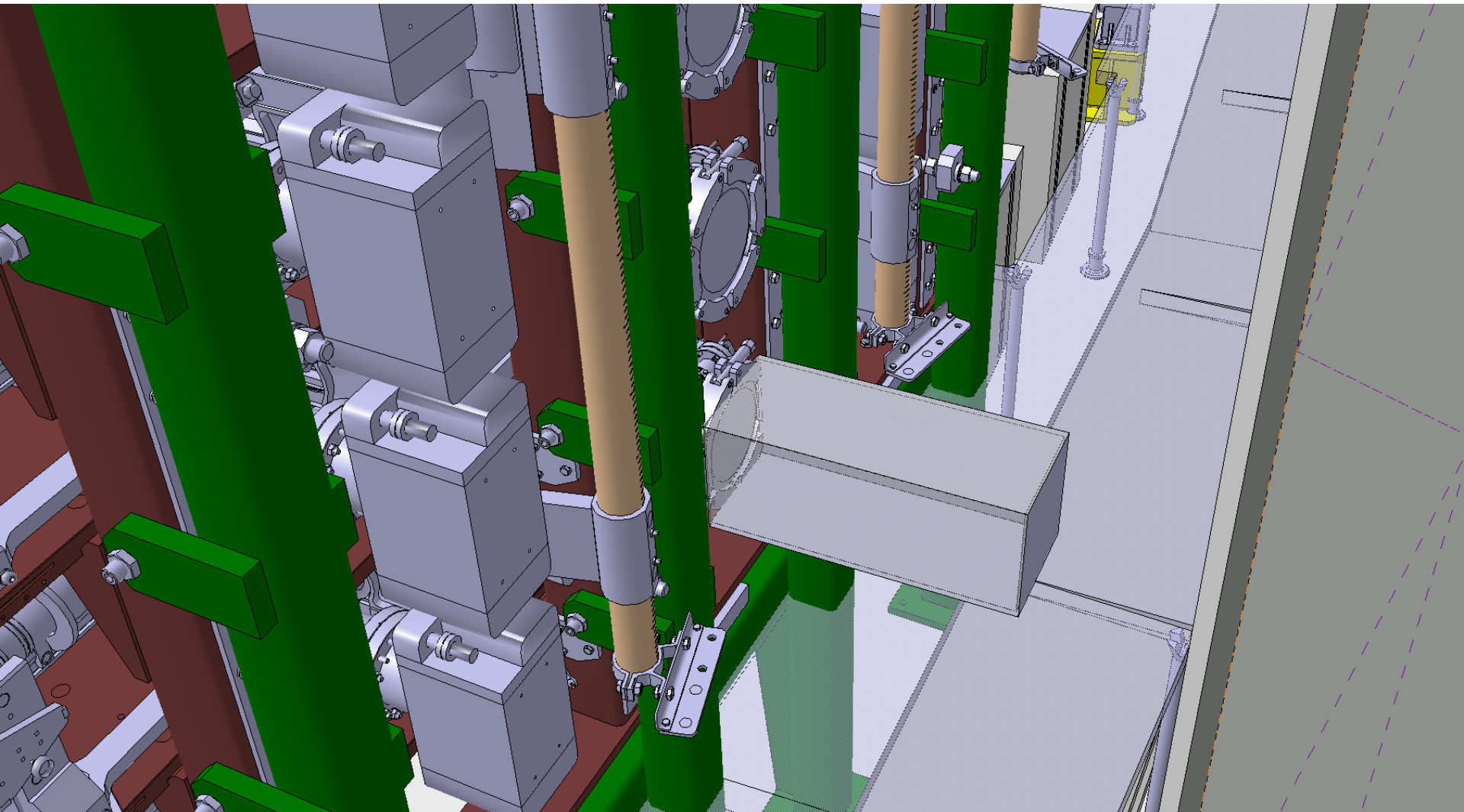

Remove vacuum flange and Installation of Foil Exchange Box



# Foil Change process at level 1

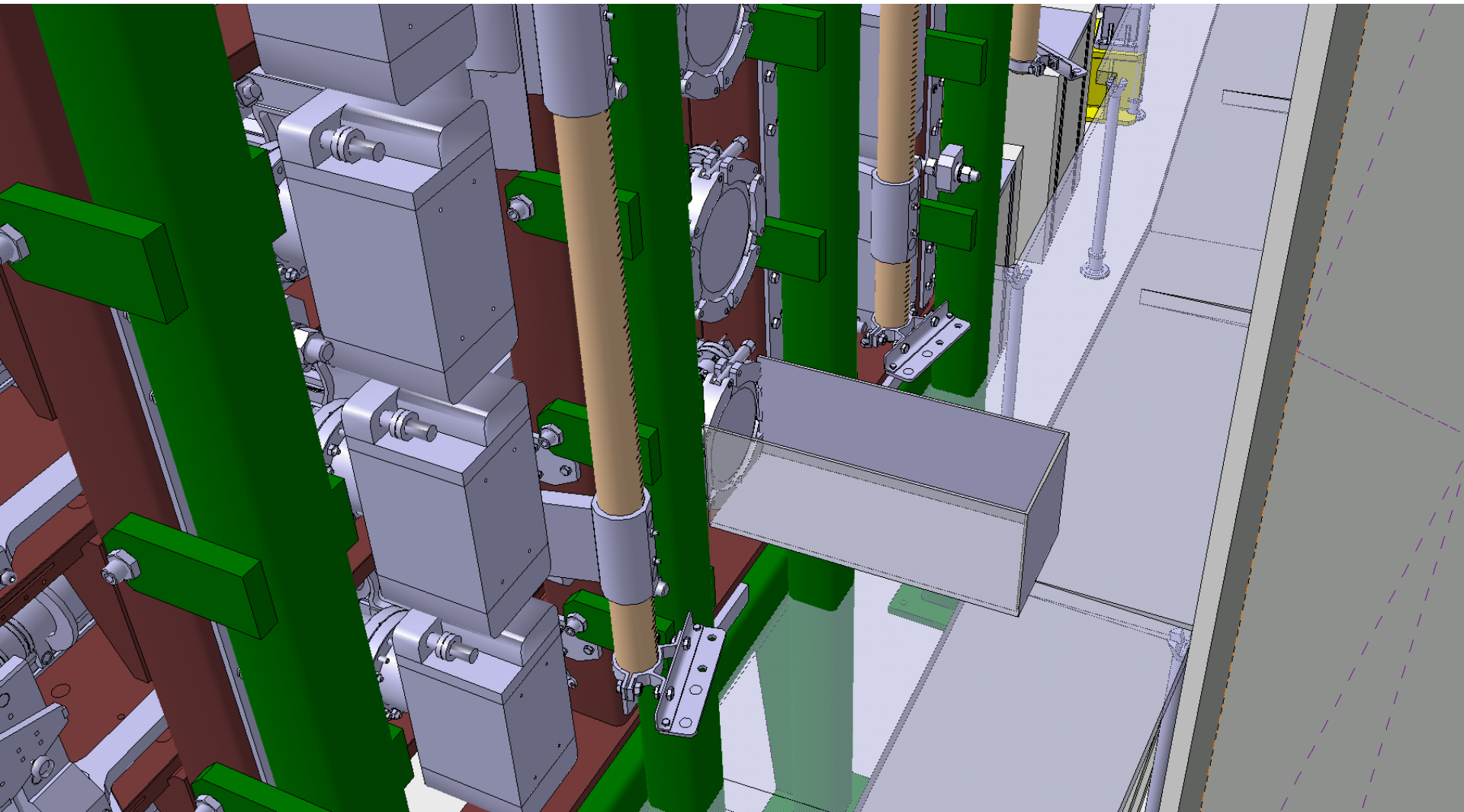

Open top panel of Foil Exchange Box



# Foil Change process at level 1

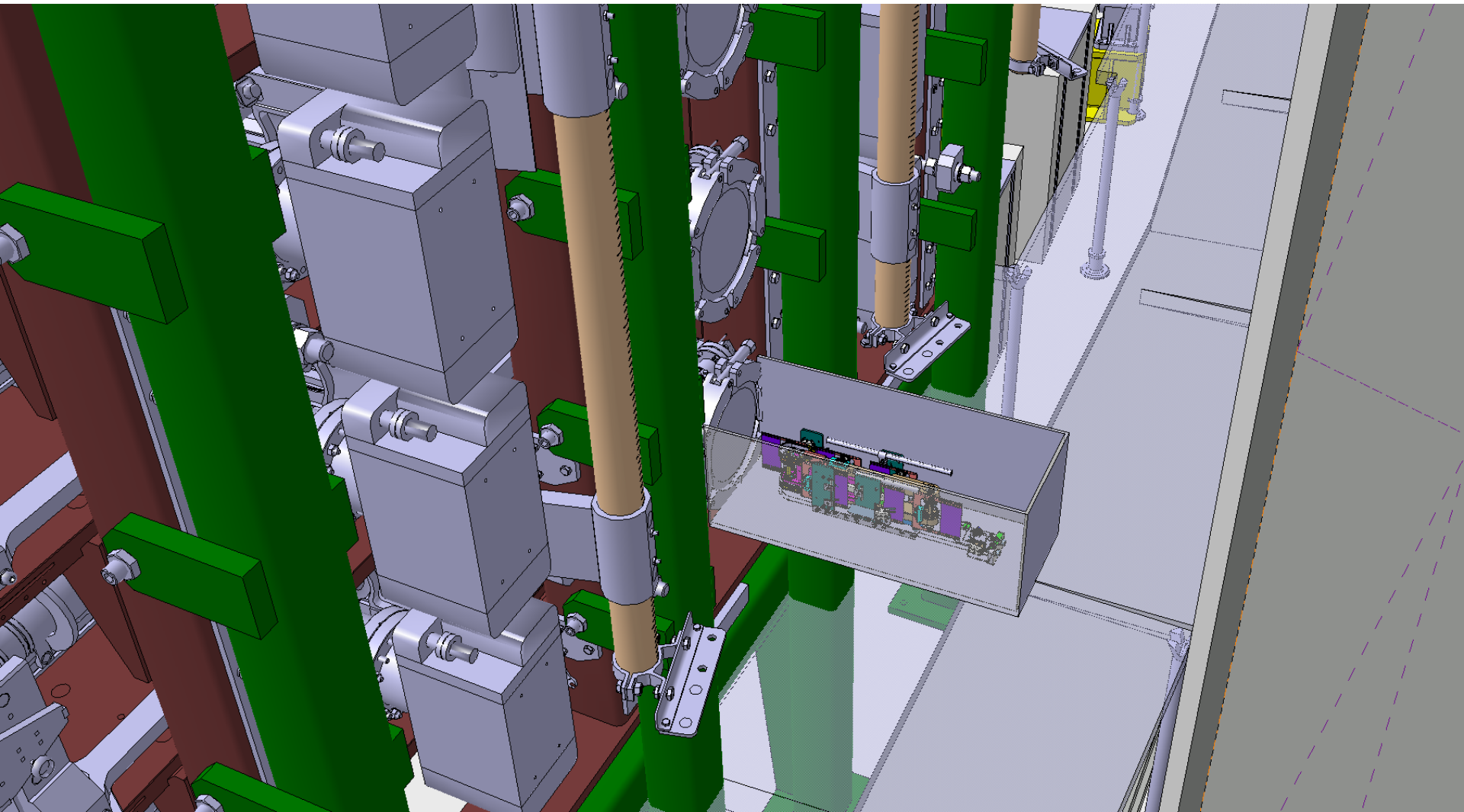

Open top panel and retract mechanism



# Foil Change process at level 1

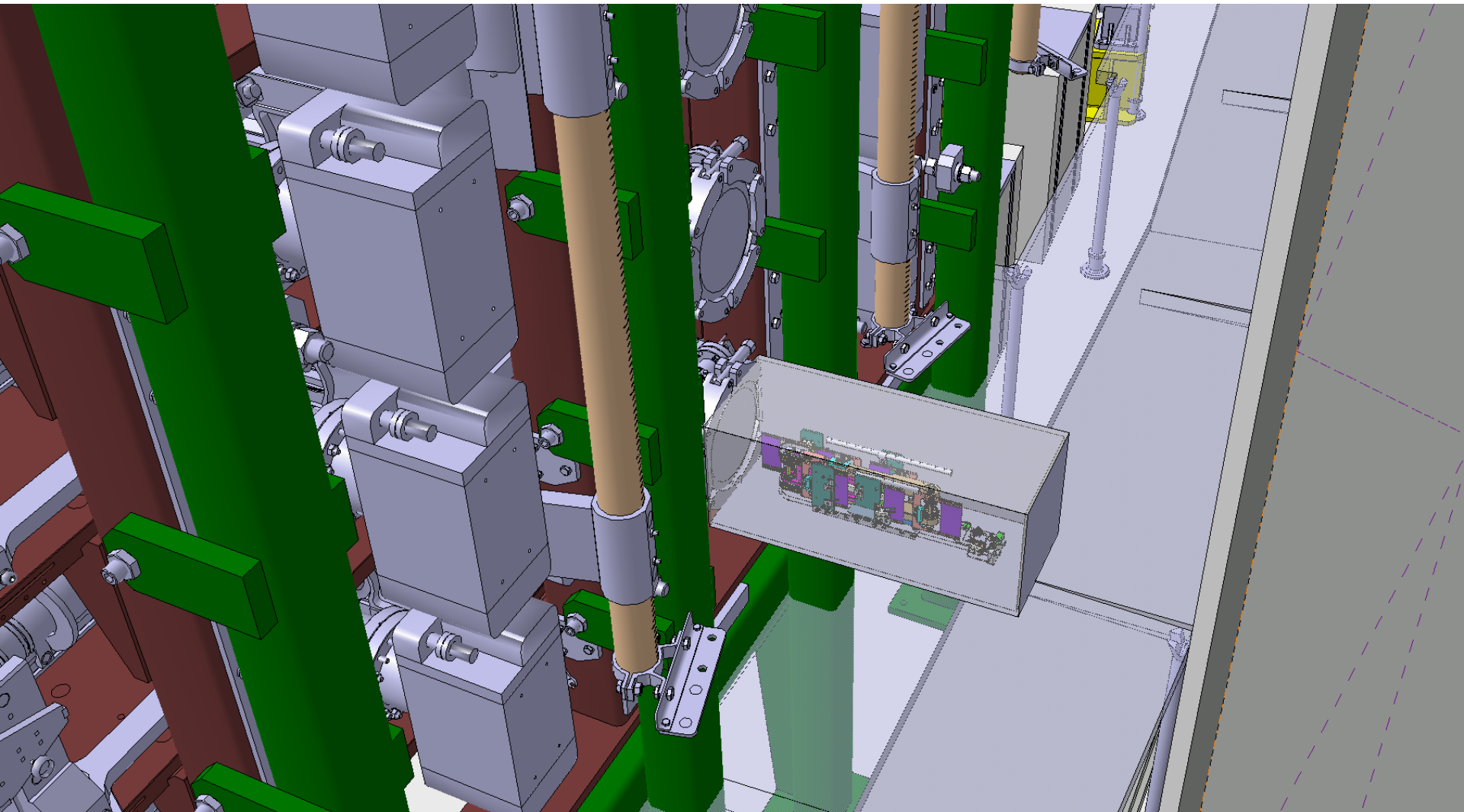

Close top panel of Foil Exchange Box



# Foil Change process at level 1

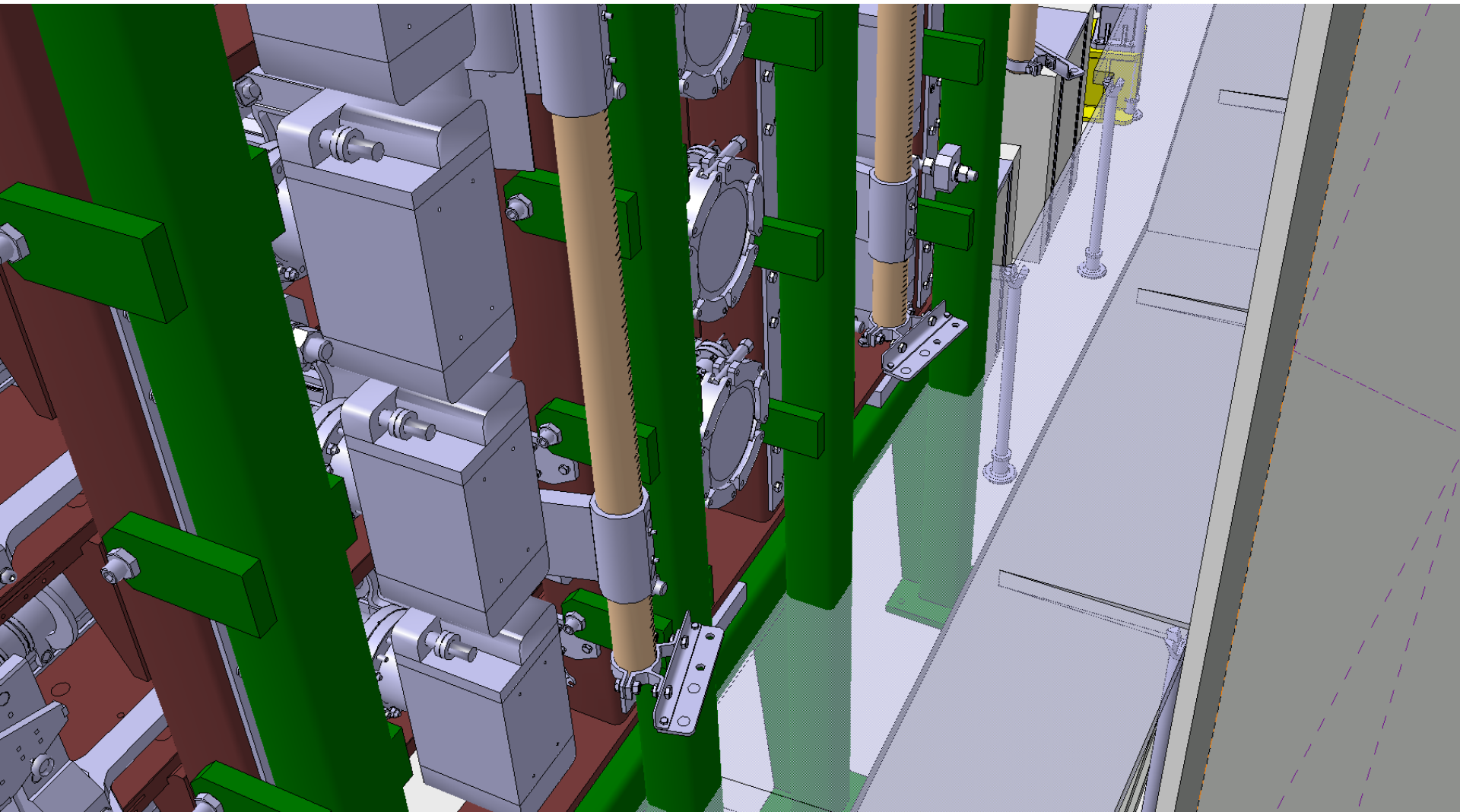

Removal of Foil Exchange Box



## Some Considerations from RP

- The foil exchange box seems to be a good idea.
- A guidelines for protective equipment and required monitoring measures for the intervening personnel, according to the IEAE standards, will be prepared in the next 2-3 months.
- Keeping the area clean with respect to foil debris should a priority. This could mean vacuum cleaning;
  - during all interventions in this sector
  - all components that are removed from the sector at time of removal.
- The propagation of foil debris via the vacuum pumps to the tunnel air should not be a problem (ref. discussion with Jan Hansen).
- How to remove/store the activated foils in the lab still needs to be studied (possible dedicated glovebox ?)





## Preliminary conclusion

- **Worse Case Scenario**, committed effective dose during foil change are well above the limits for radiation workers (**25 mSv** due to inhalation or **17 mSv** due to ingestion).
- Undamaged foils on support are quite stable and can be manipulated.
- Damaged foils on support are very unstable and difficult to manipulate, small debris will 'float' in air.
- NO air circulation allowed during gluing of the foils
- Dedicated lab space near the PSB injection region for storing and preparing the foils has been requested. (Option in building 37)
- The need of reduced air circulation during installation and removal of the foils is required. How, by ventilation or shielding, needs to be studied.
- Personnel shall be protected against inhalation or digestion of irradiated foils. This can be achieved by masks and "glove box" intervention.
- If possible we would like to recuperate foils for future reference.