

# Intellectual Property 101

Ideas and Dollars

# Ophir Marko

- Patent Attorney
- Physicist
- Investor
- Joined 1<sup>st</sup> start-up at age of 14
- 2<sup>nd</sup> one at 15, Nasdaq IPO at \$700M

# 4 Forms of IP

- Patents
- Trademarks
- Copyrights
- Trade Secrets

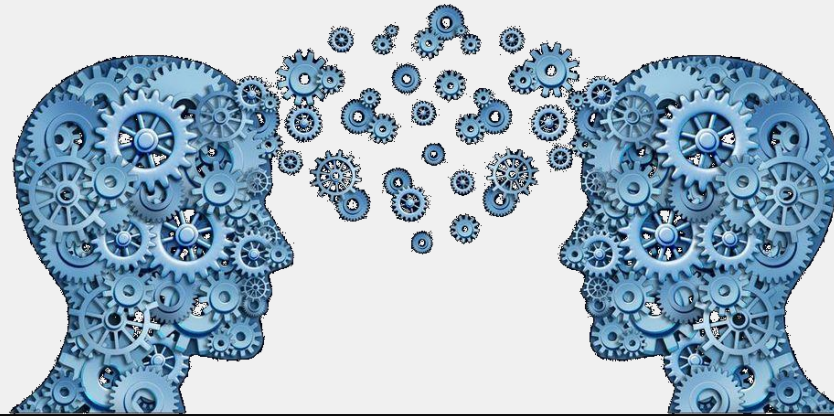

# Patents

- A grant to exclude others from using an invention
- Time is limited to generally 20 years from filing
- Types: Utility (process, machine, manufacture, composition of matter), Design, Plant

# Utility Patents

- Process
- Machine
- Manufacture
- Composition of Matter

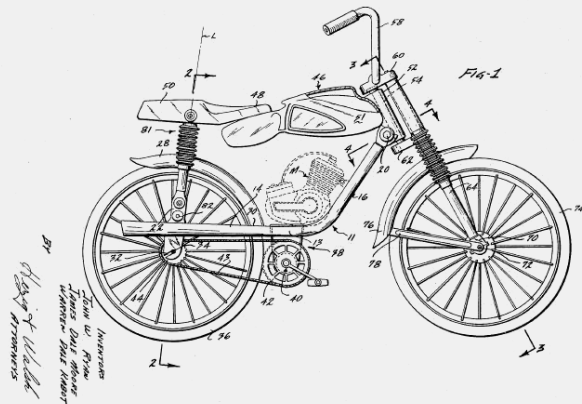

Jan. 28, 1947. R. T. JAMES 2,415,012  
TOY AND PROCESS OF USE  
Filed Aug. 21, 1946 3 Sheets-Sheet 3

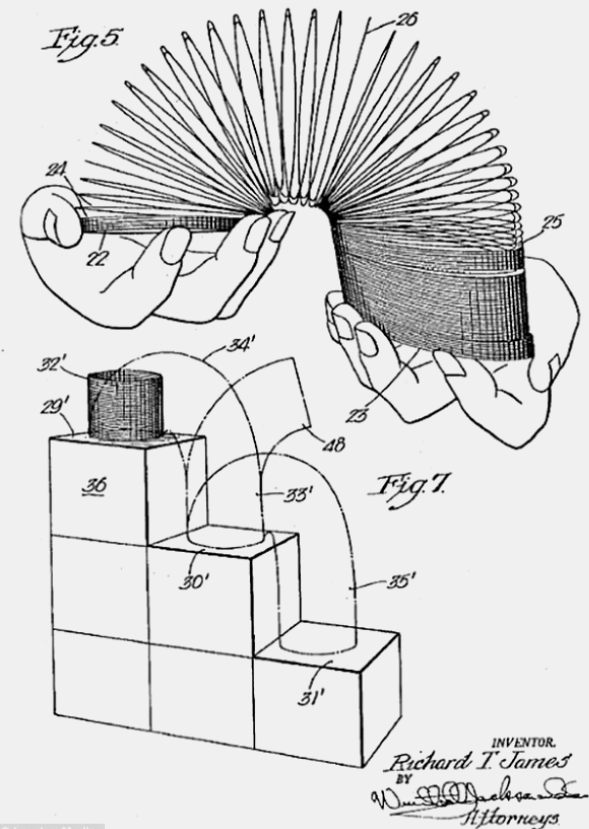

© London Media

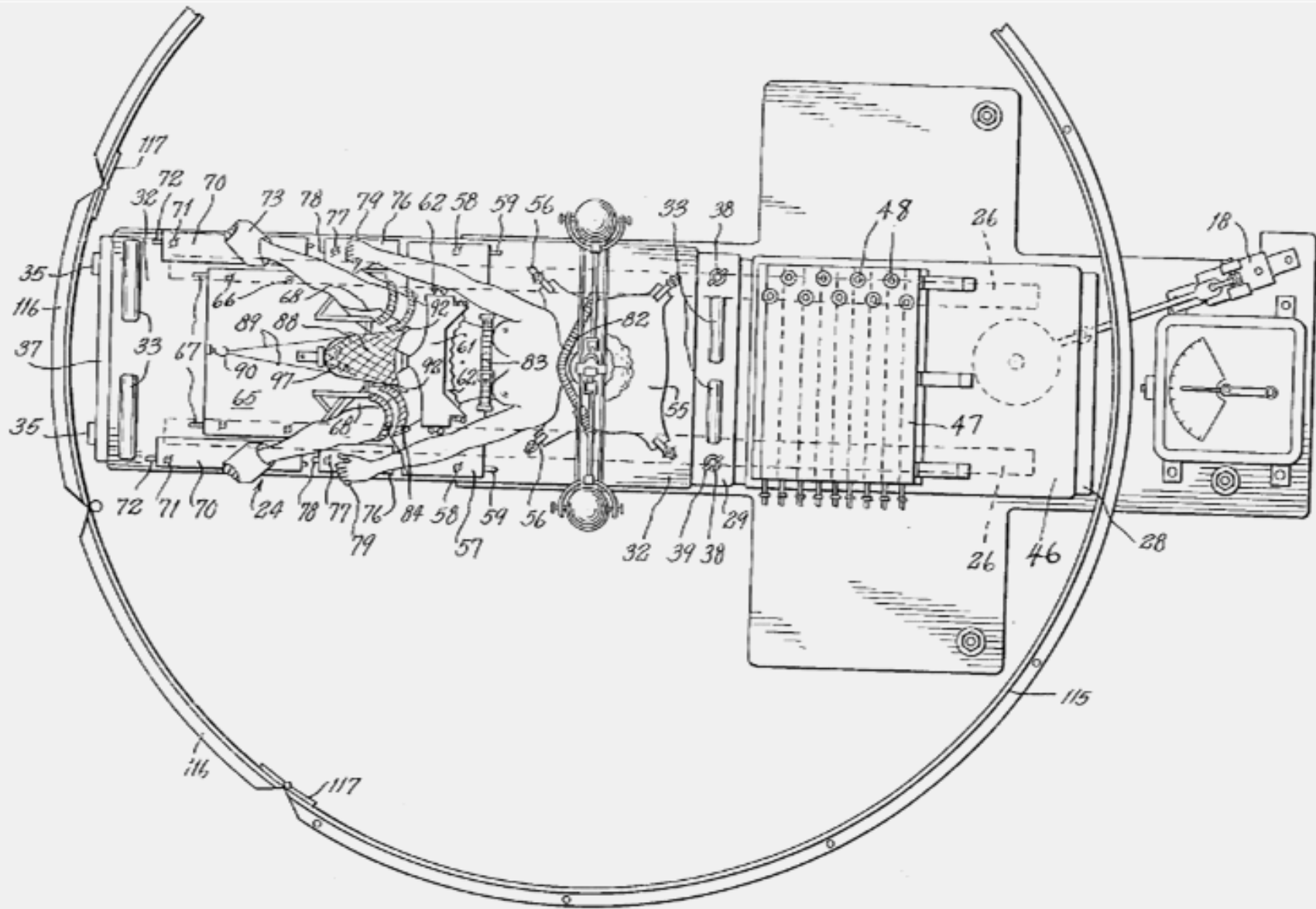

# Design Patents

- Ornamental features

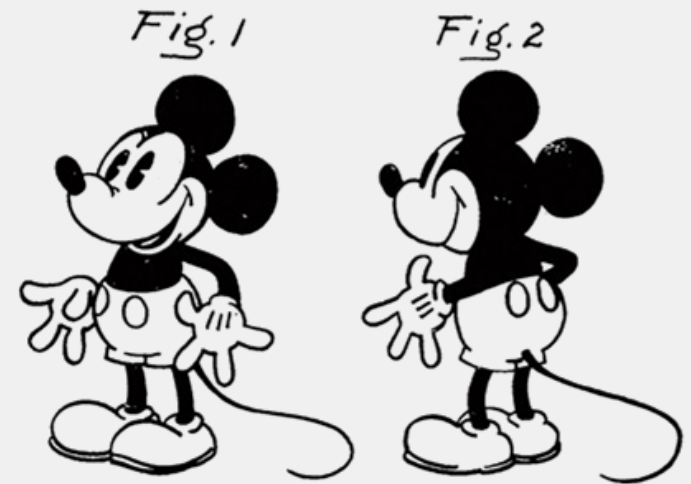
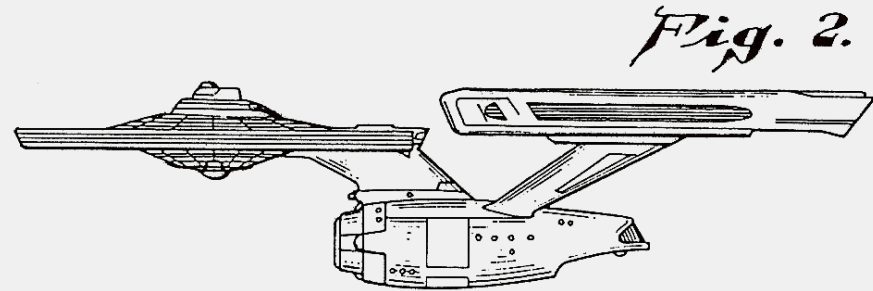
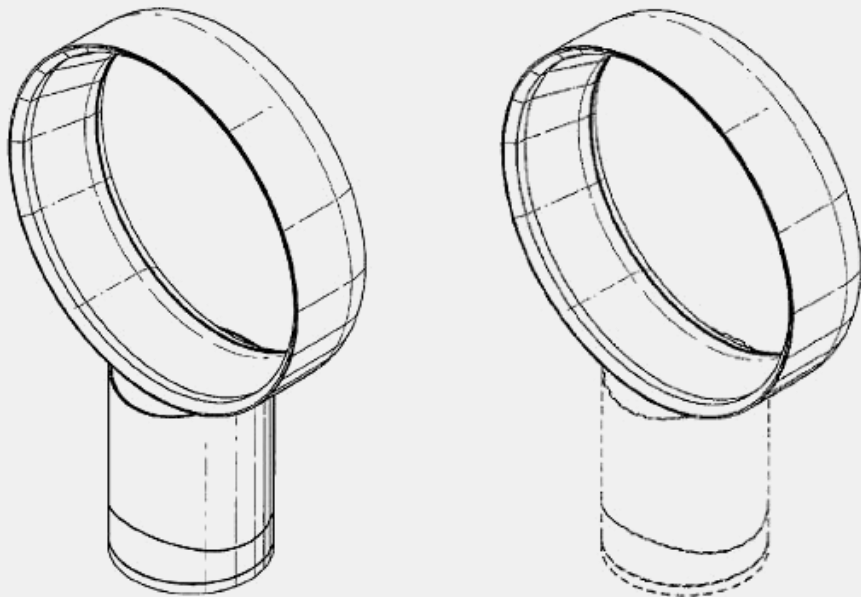

# Trademarks

- Names, symbols, marks and the likes uniquely identifying a product, a firm, a service etc.
- Unlimited time as long as in active use



Apple  
Corps



IBM®



NOKIA





# Copyrights

- Human creations in writing, printing, drawings and the likes
- Term of protection varies by country and based on either author's death or publication and creation dates



# Trade Secrets

- IP kept in confidence within a firm
- Limited internal exposure and no external exposure
- No time limitations for as long as it is a secret

# What You Should Know

And Why No One Will Tell



# Make or License?







me@OphirMarko.com

