

Latest results with the timing diamond detectors from TOTEM

Mirko Berretti
CERN and PISA INFN



with R. Linhart, N. Minafra, V. Georgiev, D. Lucsanyi, J. Kopal, M. Bozzo, T. Naaranoja, E. Bossini

Forward Physics Workshop
CERN, 27/10/2015

- Diamond detectors development for the proton TOF measurement
- Results with the final TOF plane ready to be installed in the LHC
- Plans and conclusions

Physics motivations

The TOTEM upgrade programme focuses on improving the experiment's capability to explore and measure new physics in Central Diffractive (CD) processes: $p+p \rightarrow p + X + p$. The installation of proton Time-Of-Flight (TOF) detectors in the TOTEM Roman Pots allows to reconstruct the longitudinal vertex position and thus to assign the proton vertex to the proper vertex reconstructed by the CMS tracker, in presence of event pileup.

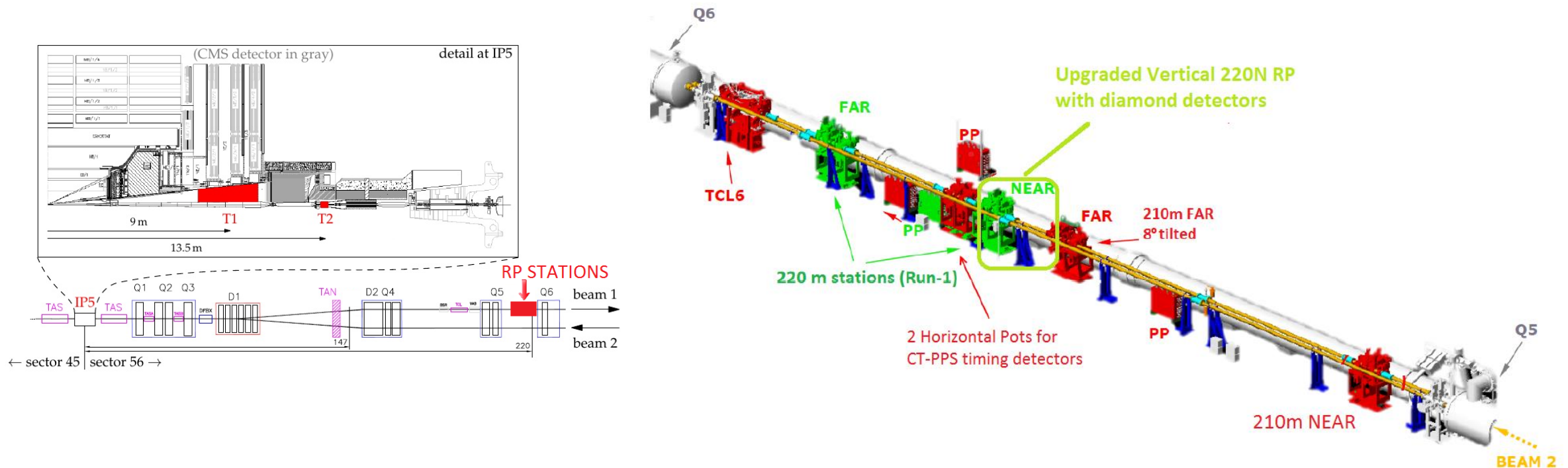

Common CMS-TOTEM data taking are foreseen during the LHC Run 2, with a special LHC-optics configuration (pile-up $\mu \sim 1$) for which the proton acceptance is optimal (all $\xi = \Delta p/p$ for $|t| > 0.04 \text{ GeV}^2$).

A diamond TOF detector

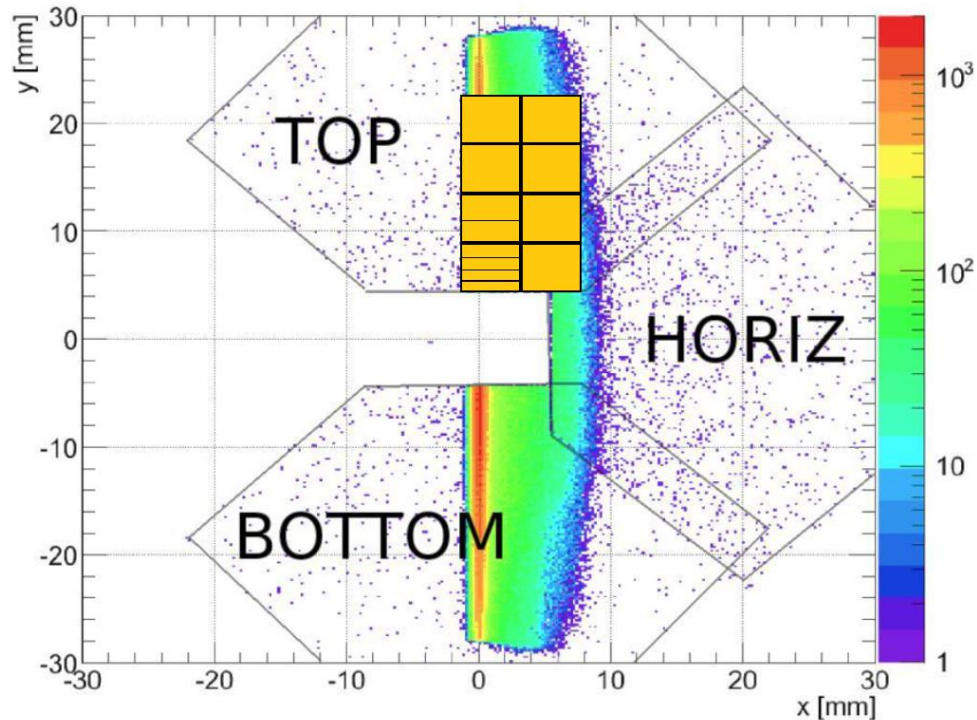

Track distribution in the 220F RP, for events with 2 protons in the final state. The golden picture on the TOP shows the diamond detector surface. The diamond detector in the BOTTOM RP is not reported for clarity.

Diamond detectors have been chosen due to their:

- Proven radiation hardness and faster response with respect to Si (but lower signal).
- Small and safe enough to be placed inside a RP.

After an extensive R&D on the FE electronics a time resolution < 100 ps has been proved.

- 4 diamond plane per arm \rightarrow 50 ps per arm will be achieved ($\sigma_z \sim 1$ cm)

To minimize the pile-up probability in the same diamond pixel the design has been optimized in order to guarantee an uniform occupancy

Development of the first prototype

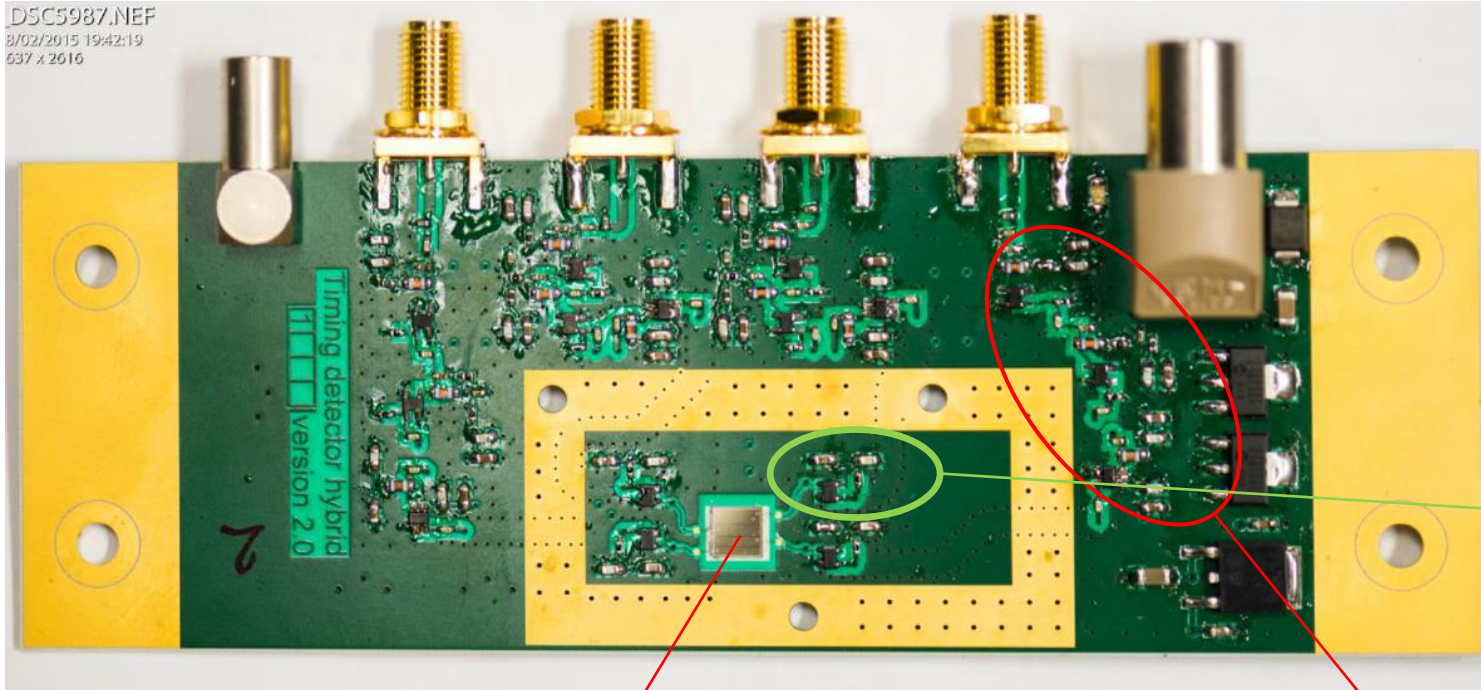

Transconductance preamplifier, $G_i=31\text{dB}$

Based on GSI-HADES design:

J. Pietraszko, L. Fabbietti, W. Koenig

Diamonds as timing detectors for MIP:

The HADES proton-beam monitor and start detectors

Nucl.Instrum.Meth. A618 (2010) 121-123

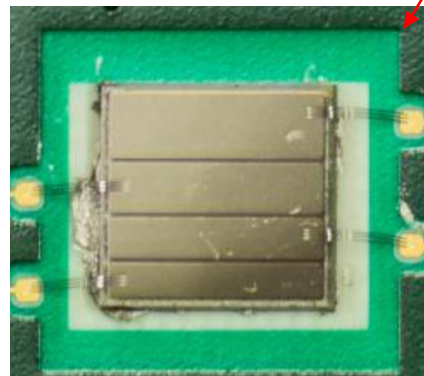
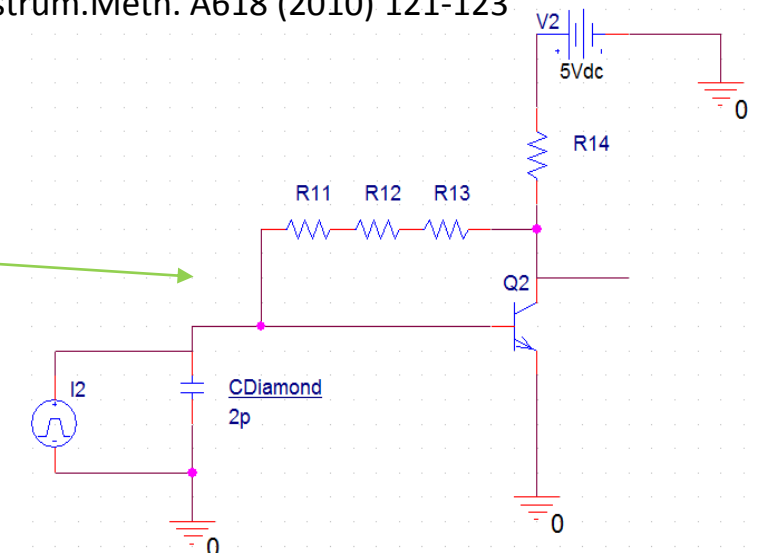

*Short paths
between
diamond and
preamp*

Other two amplification stages:

- MMIC ABA-53563: near linear phase, unconditionally stable with any Z_{in}/Z_{out} values. $G = 22\text{ dB}$
- Shaping amplifier (2x BFG425 Si BJT)

➤ *TOTAL $G \sim 180\text{mV/fC}$, Noise: $700e^- \text{ ENC}$. BW: $\sim 200\text{ MHz}$*

Time resolution with the first prototype

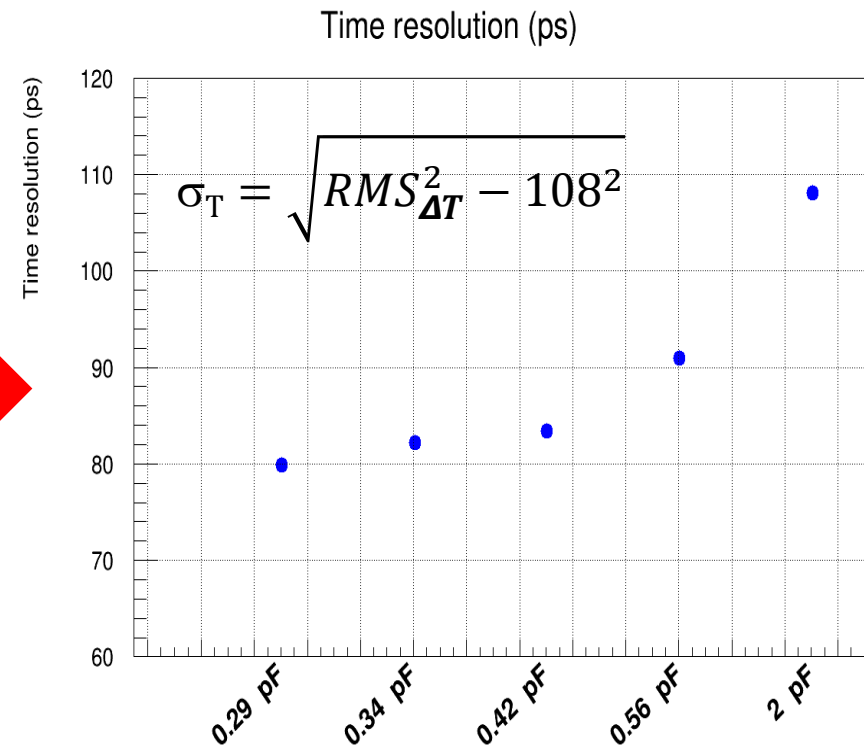
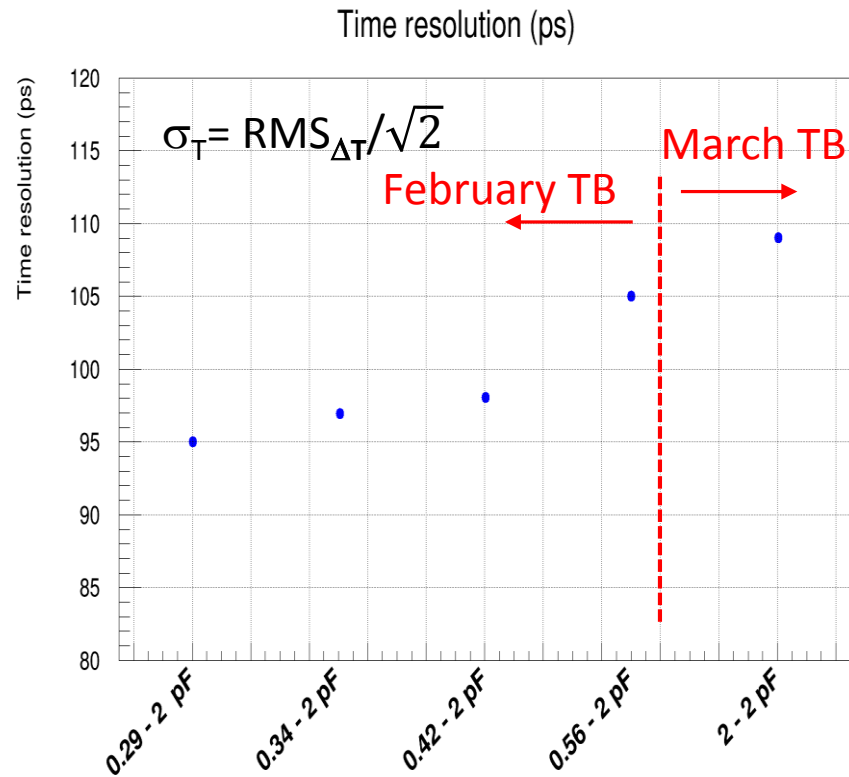

Warning, not a direct measurement
(large error in the estimation at small C)

Efficiency measurements with the first prototype

- Measurement of the inefficiency induced by the 100 μm unmetallized region between the strips.

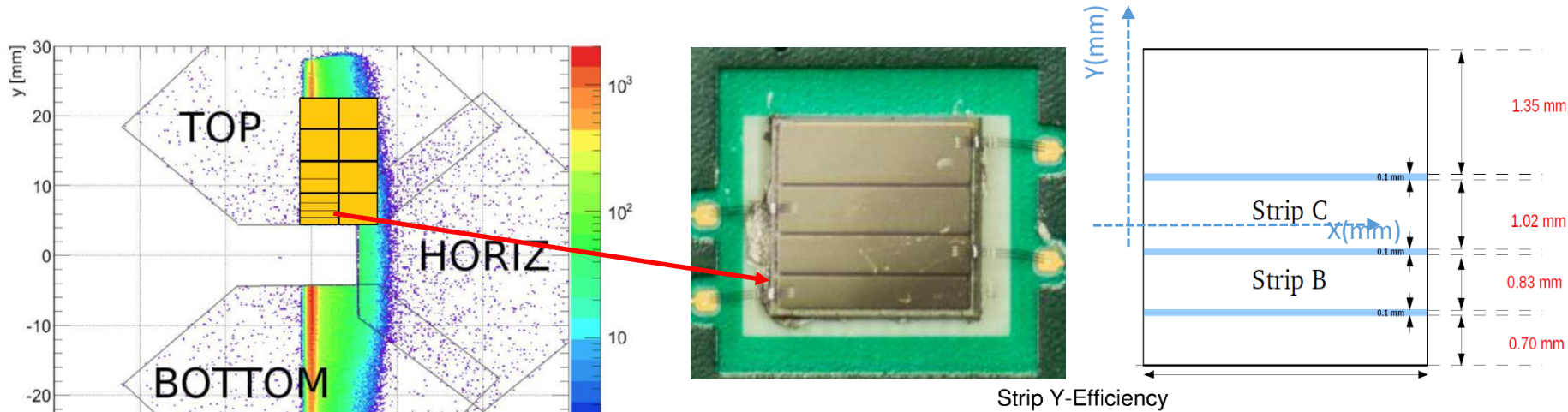

- In the geometrical area of the metallization an efficiency larger than 98% is obtained (residual inefficiency can be explained in terms of PU and Multiple scattering). The S/N is: $20 < S/N < 25$.
- An efficiency larger than 80% was found even in the unmetallized area (but here S/N and σ_T degradation has been observed)

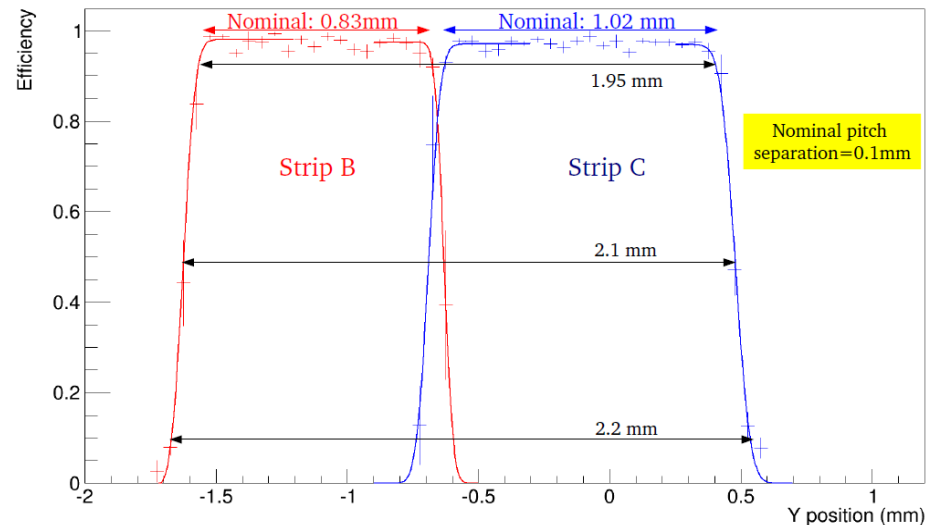

Prototype time resolution including digitization (SAMPIC)

- The time resolution is found to **slightly increase** with the capacitance.
- The rise time of the diamonds is < 1.8 ns.

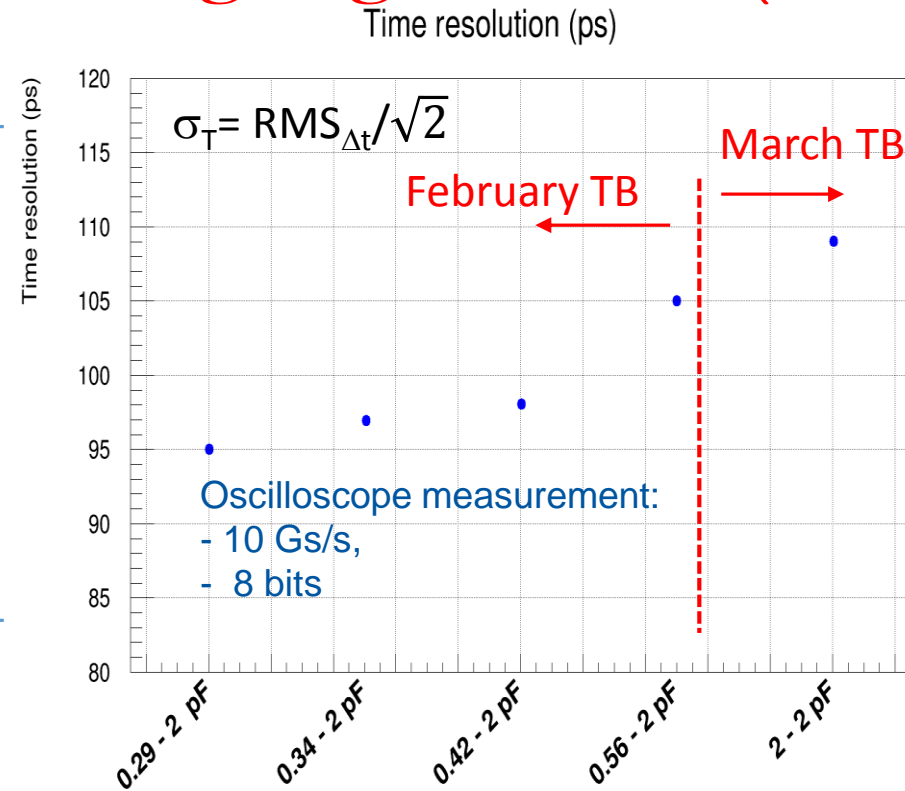
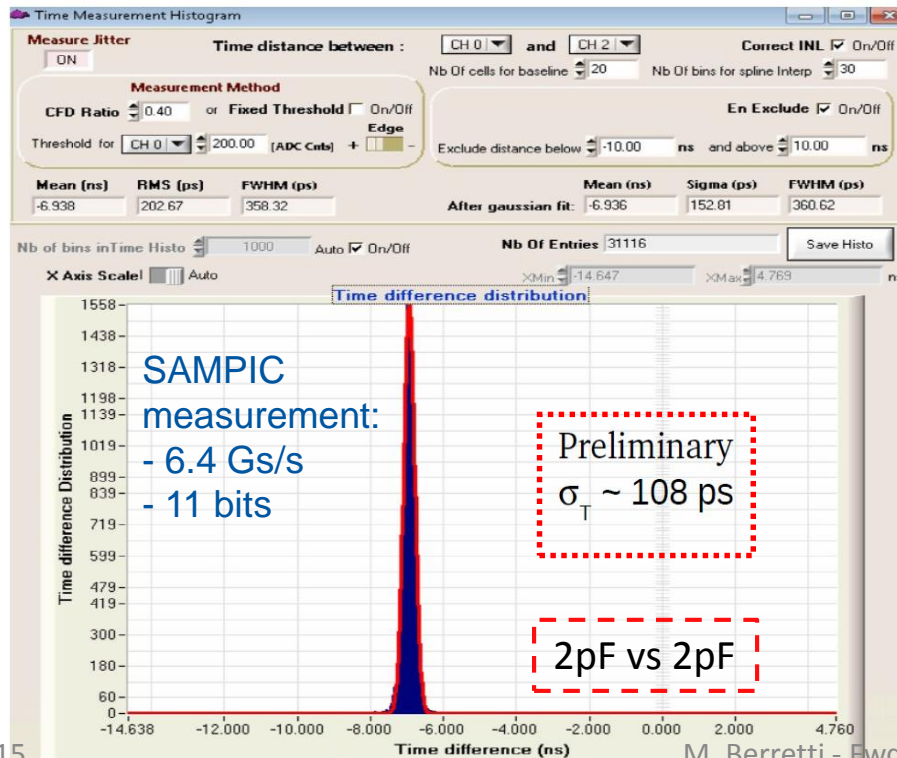

2pF vs 2 pF measurement obtained with the SAMPIC (waveform digitizer)

Important: time resolution has not been degraded by the waveform digitizer.

Production of the final hybrid

The amplification chain tested during the winter has been produced on the diamond board, hosting 4 (8) diamonds with 8 (12) channels

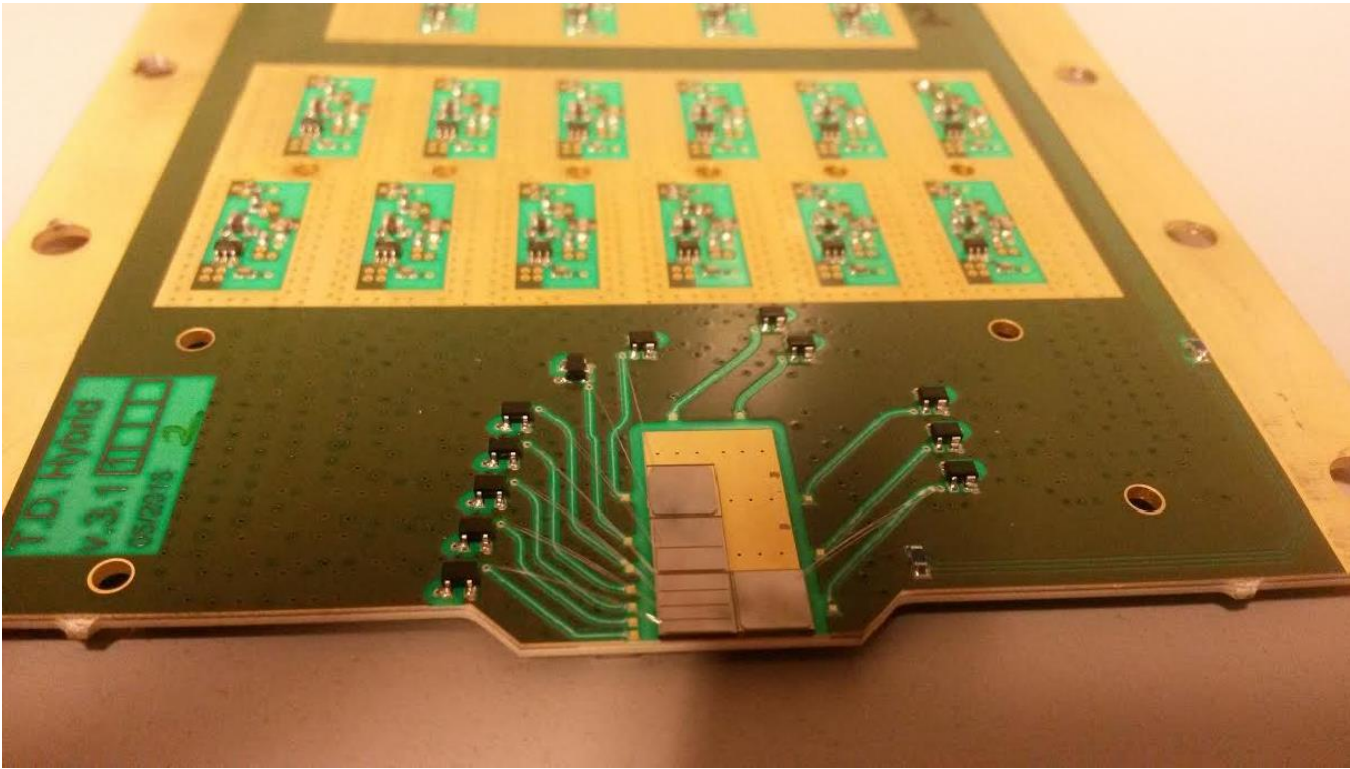

One plane with all the 4 diamonds bonded

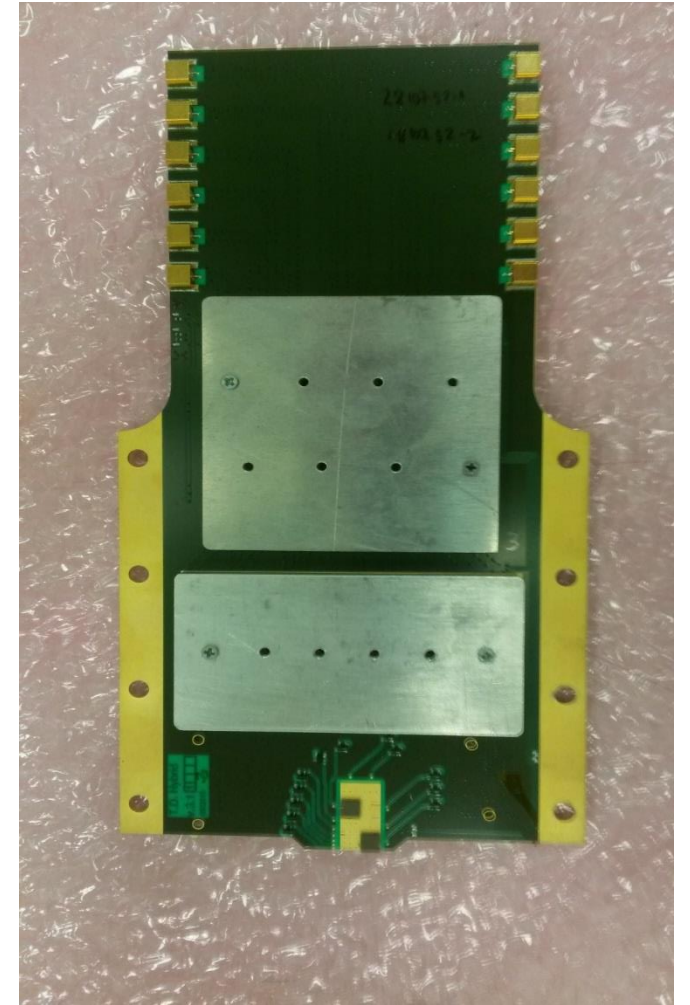

One plane with 2 diamonds bonded

Detector package with 3 planes

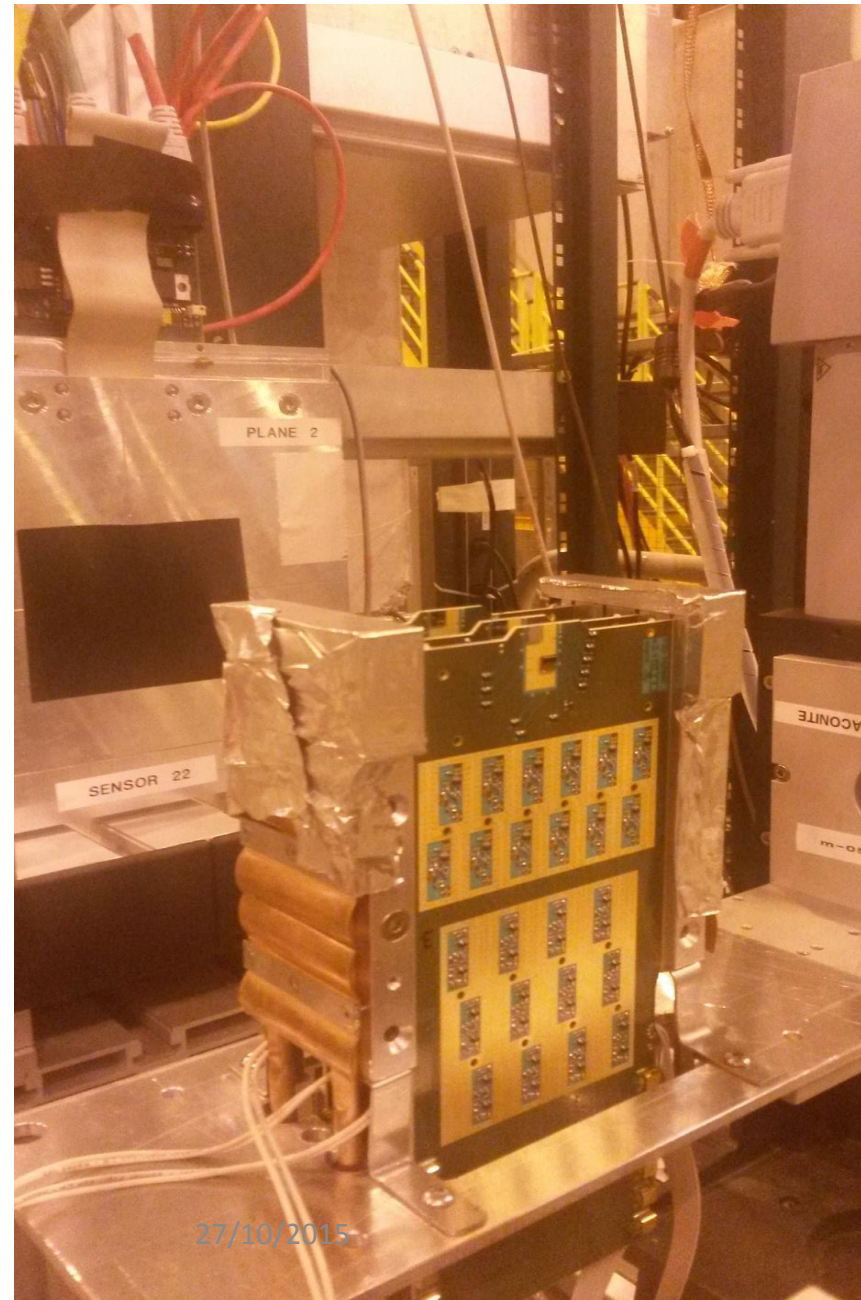

First tests of the board beginning of August

- Working point of the amplifier have to be retuned on the beam.
- Decision to remove the connection traces between the diamonds and the amplifier and to replace them with wire bonding O(5-10) ps improvement in the time resolution measured on the big pads).
- After the modifications all Signal/Noise > 25, risetime about 1.7 ns.

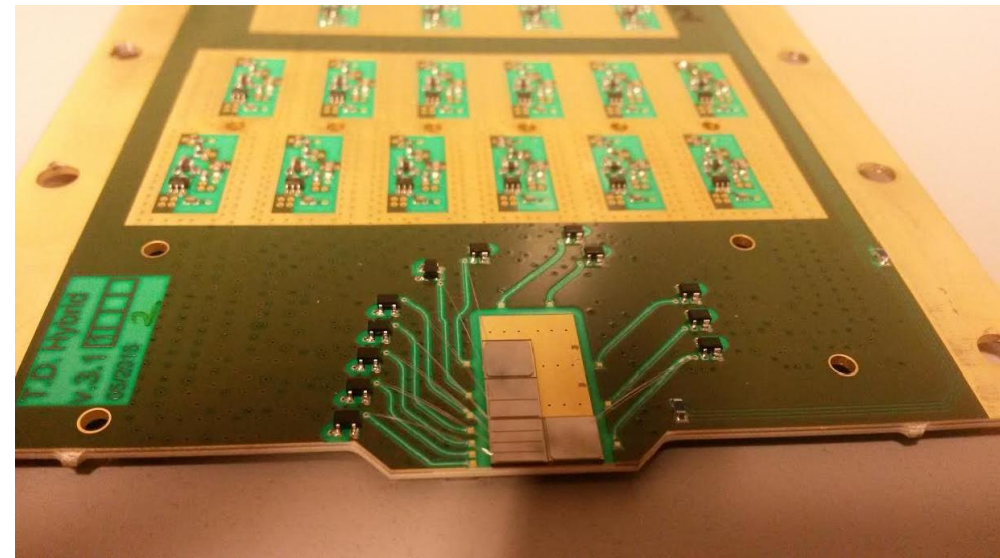

Time resolution measurements: B1,B2,B3, at Higher env. noise

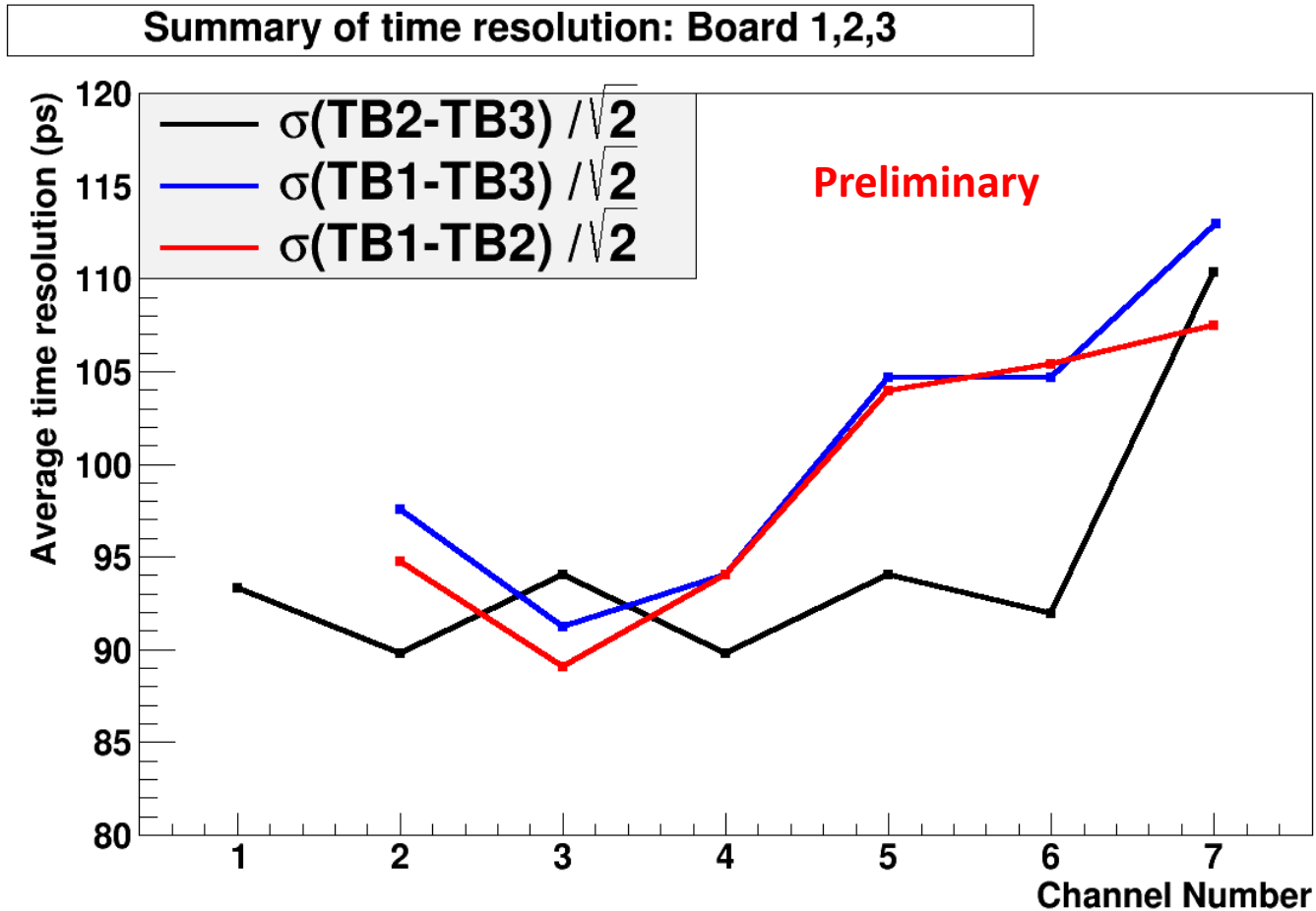

Oscilloscope measurements, SAMPIC analysis ongoing

Channel Numbering:

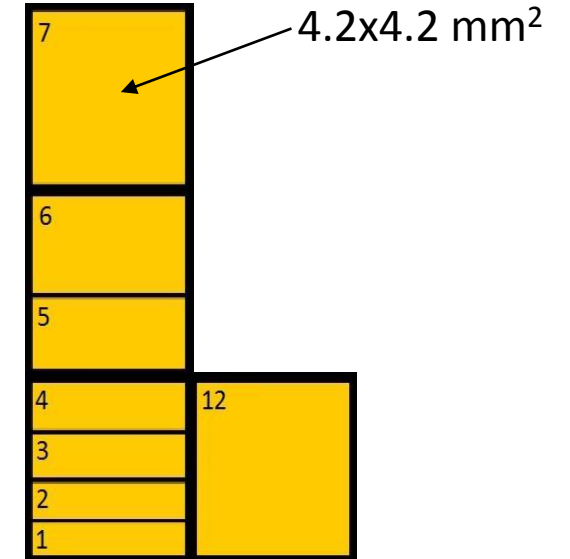

- ***~100 ps goal reached for all the sizes.***

Time resolution measurements: B1,B2 at Lower env. noise

Summary of time resolution: Board 1,2

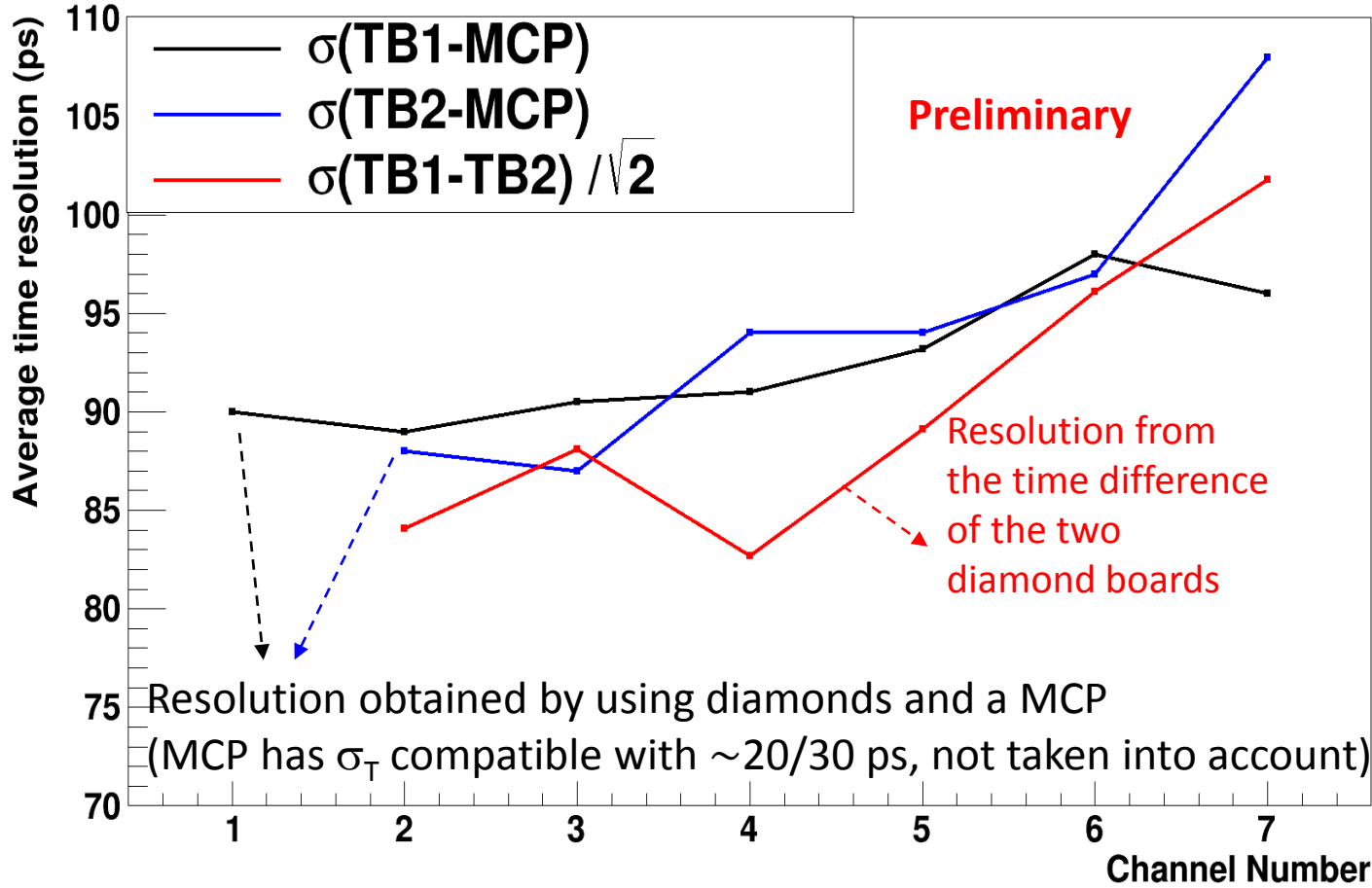

Channel Numbering:

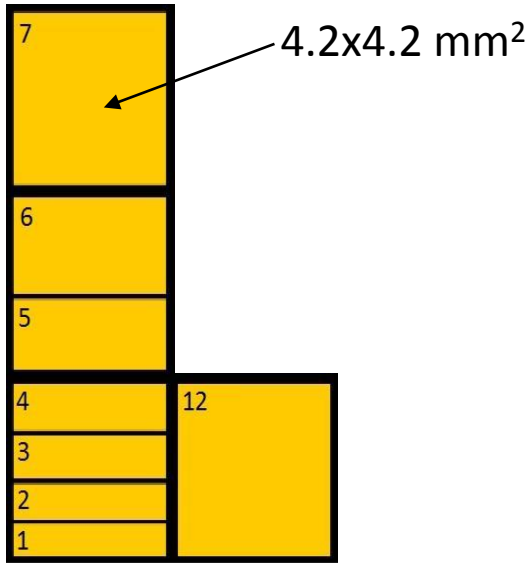

• **~100 ps goal reached for all the sizes.**

Efficiency measurements (final Hybrid)

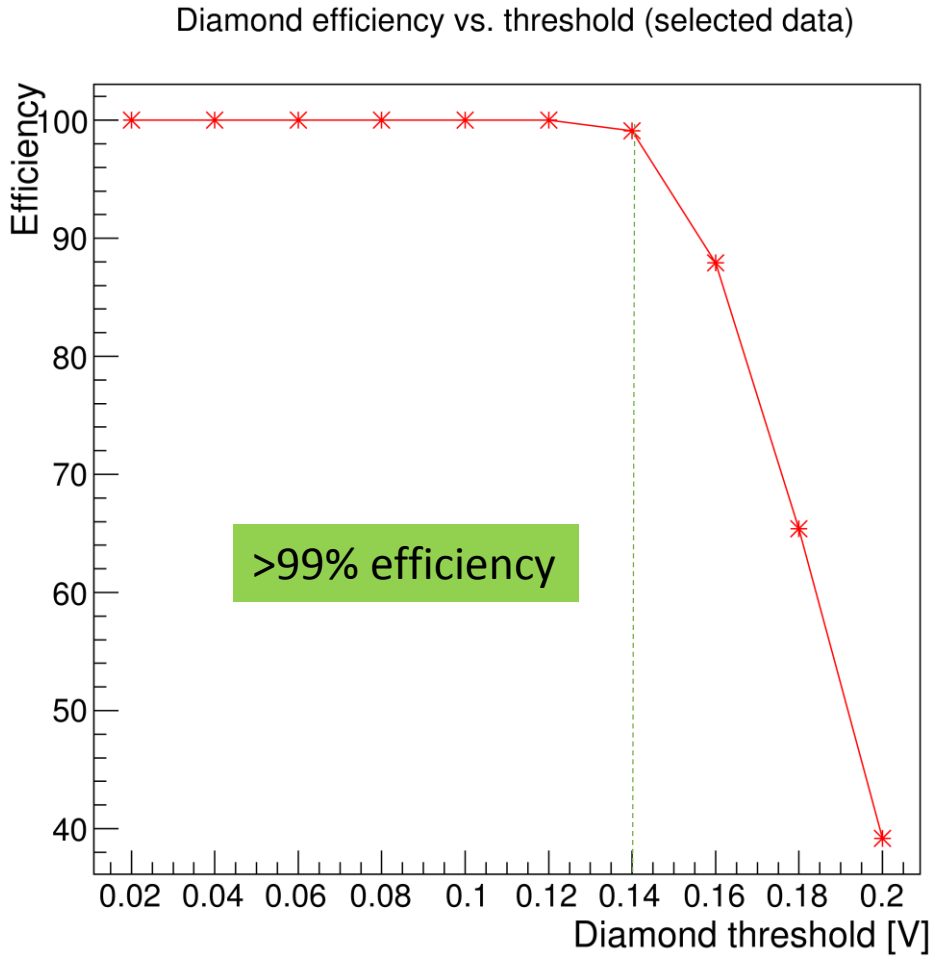

Only 9% of the signals, passing in the non metallized region of the diamond, will have a low S/N (reduced time resolution)

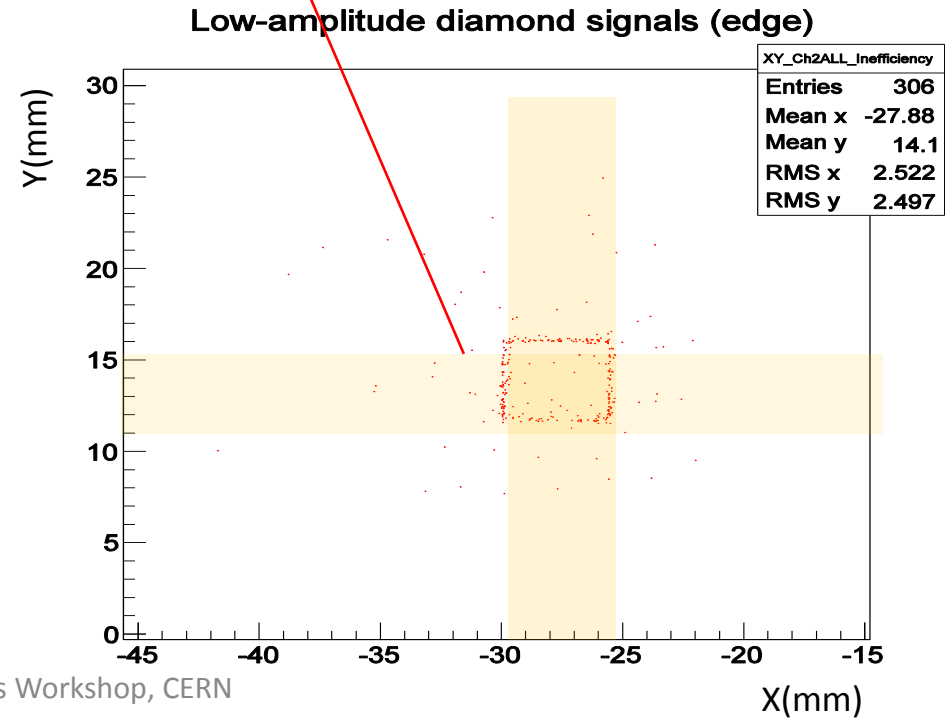
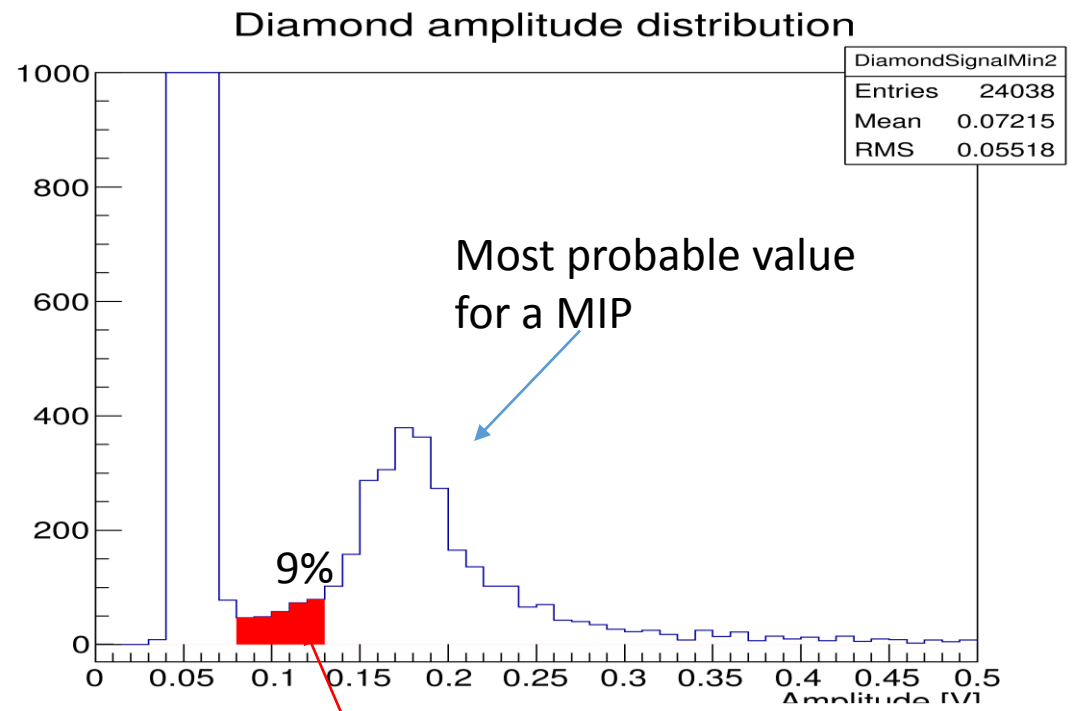

NOISE STUDIES (see backup for more)

We clearly identified two source of noise (not found in the prototype):

- 1) **RF noise picked up from the environment:** usually we were able to shield at least the large modulations. This source of noise is expected to improve inside the tunnel, planned tests before the installations.
- 2) **Pulses of noise,** the frequency and amplitudes of these depends from the value of the HV and vary from diamond to diamond.

We also noticed that the frequency of these pulses decreases after the board stayed ON for >10h inside the RP but they never disappear completely.

These can reduce the performance of some diamonds (we will quantify this statement better by exchanging the diamonds once we will have the new ones).

Dependence of the time resolution from the HV

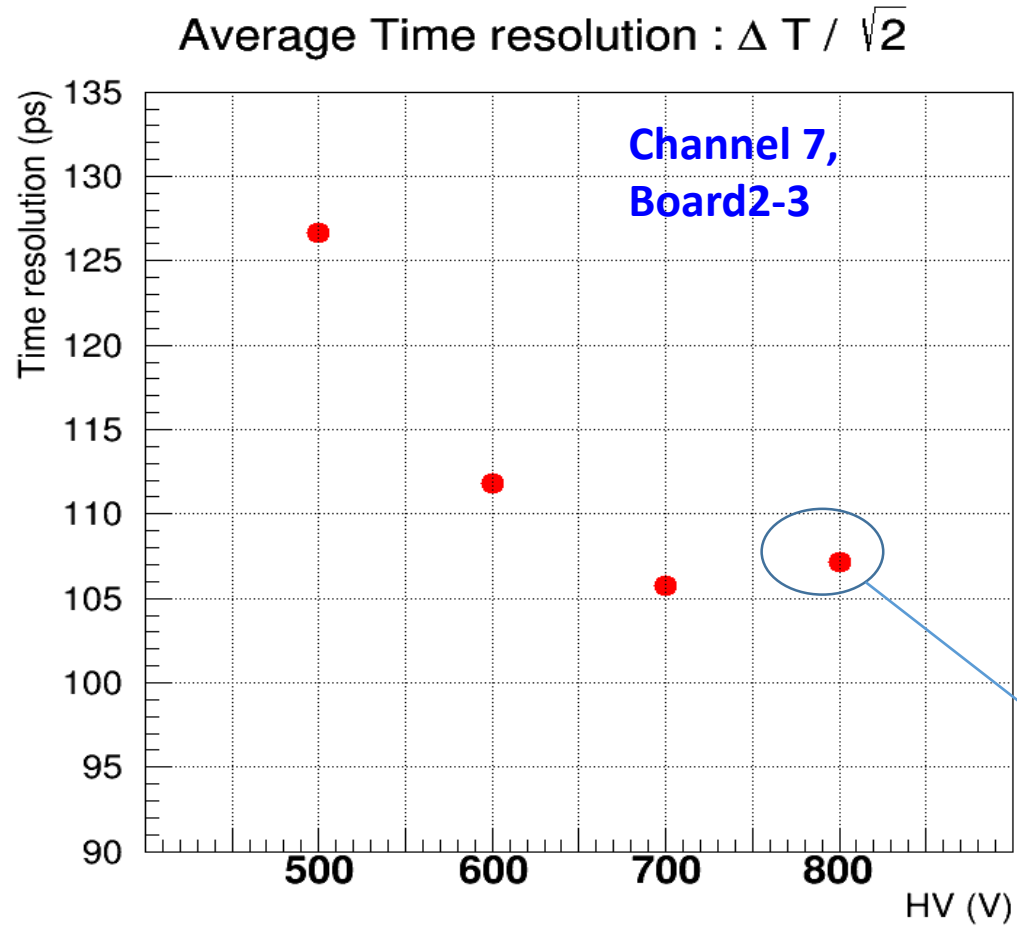
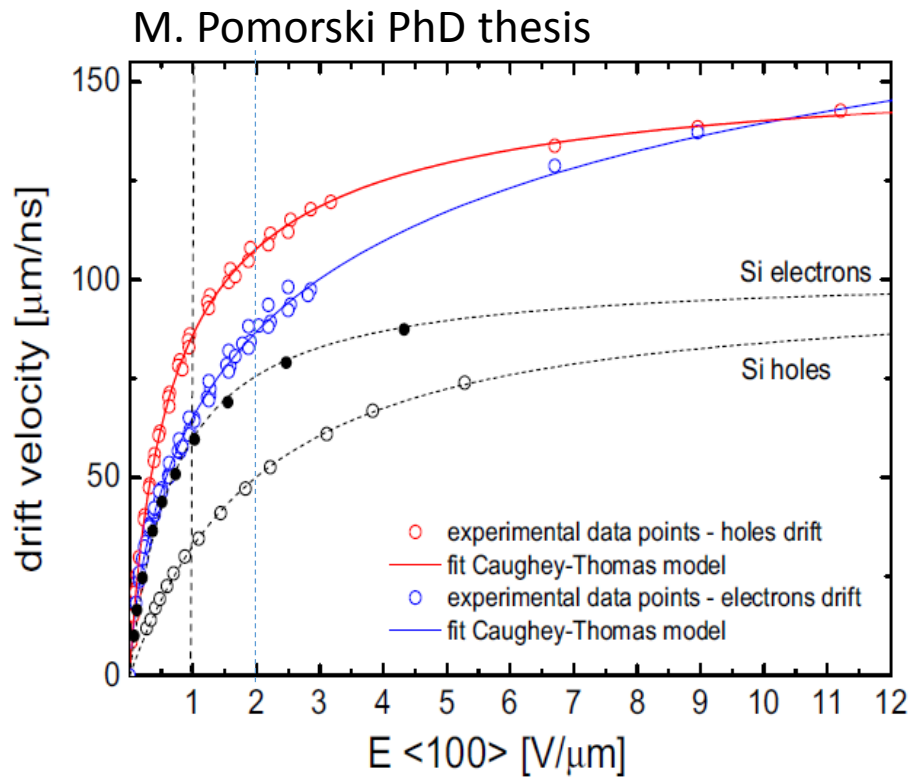

HV-dependent noise starts to be important (measurements repeated for 2 independent board in two different test beam: same behaviour was found)

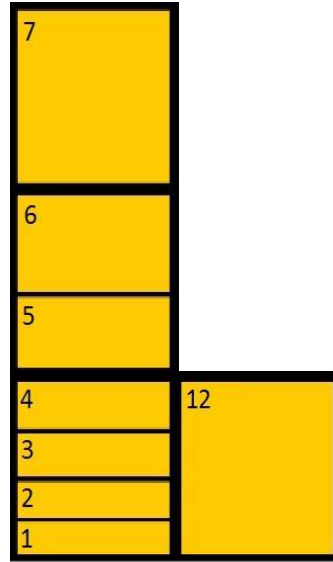

Next steps: improvements

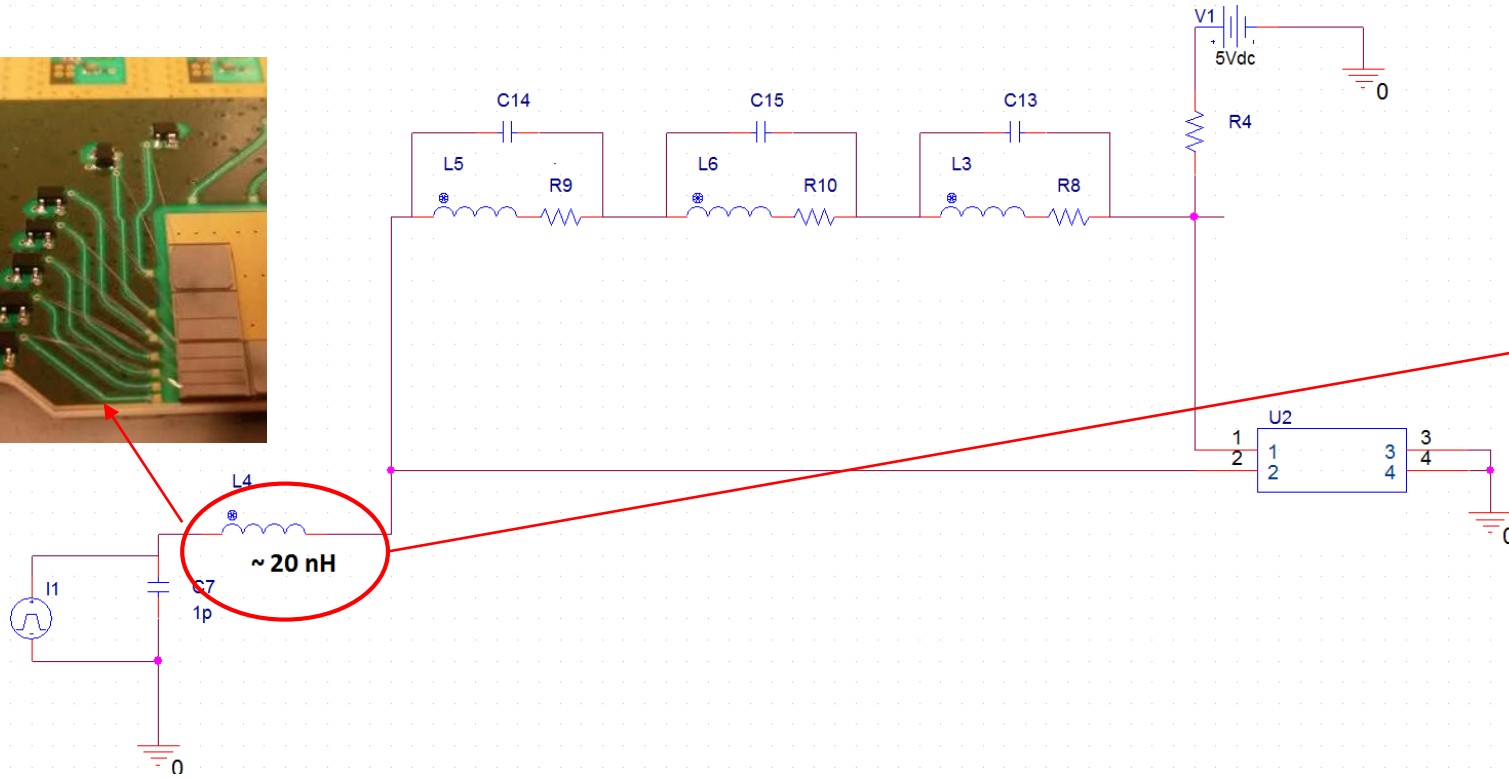
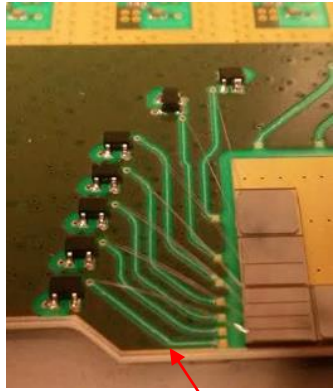

- Wire connection slow down the preamp signal of about 7% (long connections needed because of the small available area around the diamond: preamps cannot fit close to it)

- New cleaning procedure can be used to reach voltages above 700V, better selection of the diamonds can help in the reduction of the leakage current through the base of the preamplifier.
- Continue to study the feedback optimization and different 2nd stage amplification schemas.

Installation of one TOF package during Technical Stop 3

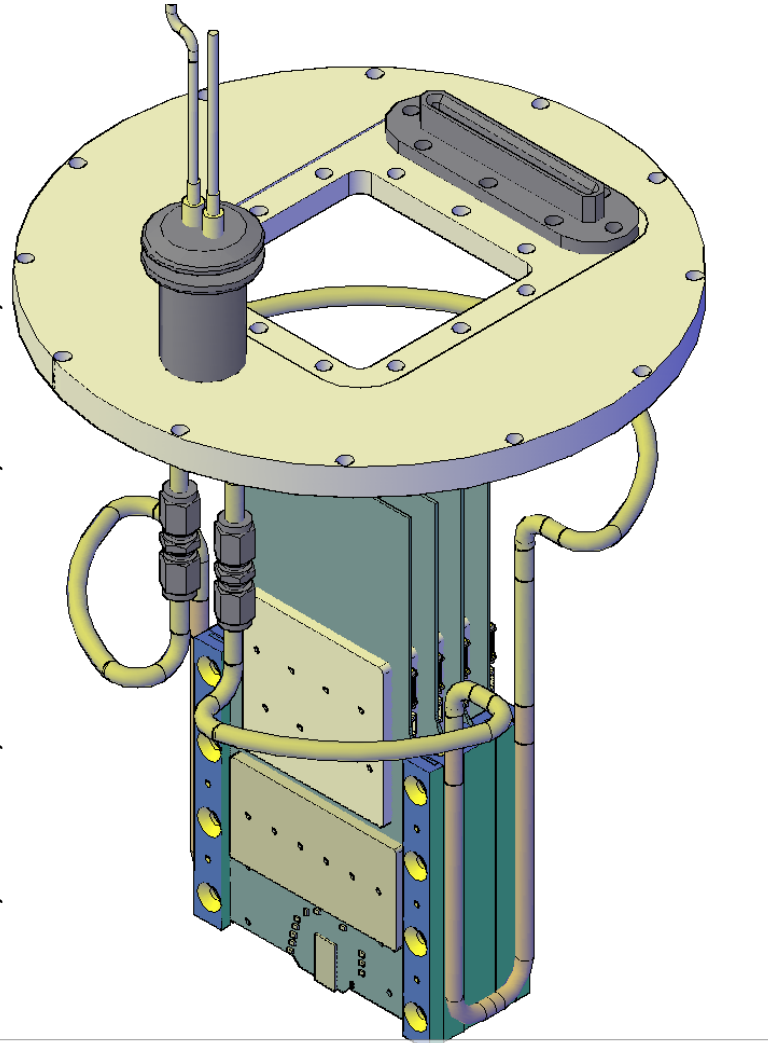

Final package of 4 diamond planes with its cooling system

- Big effort done by MANY TOTEM collaborators in order to produce a final version of the RP timing detector for the next Technical Stop (9 November).
- Necessary mechanics and feedthrough card / connectors already produced and partially tested.
- Final cooling test under vacuum will be done next week.
- Goal of the TS3 installation: monitor the stability and the correct operation of the RP timing detector (cooling, leakage current, diamond signal noise).

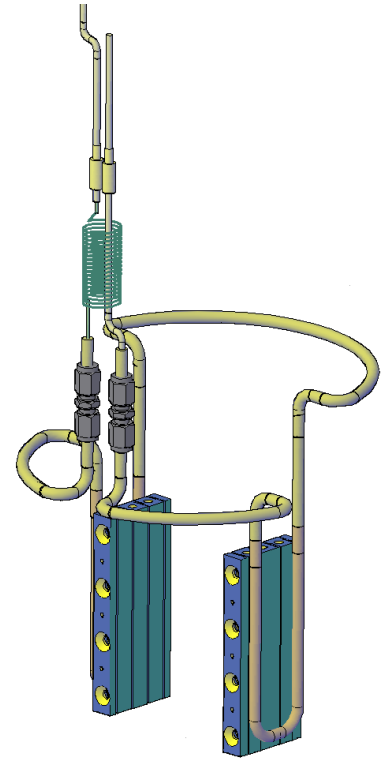

Capillary system adapted for the cooling of the diamond FE electronics inside the RP

Summary

- During 2014/2015 TOTEM performed a long campaign of test beam. The aim was to build in a short time a TOF diamond detector with at least 100 ps time resolution / plane to be installed inside the RP.
- The first single-diamond board (prototype) has been optimized with TB measurements and the first timing detector board was assembled during this summer.
- The 100 ps goal has been reached and the same design has been introduced in a 12-channels board.
- Huge effort done in order to complete the first timing RP (hybrid assembly, mechanics, cooling, feedthrough).
- Now we have 4 boards ready to be installed during the TS3. The ion run will be used to test the detector performance (noise, HV stability etc) and the cooling system in the LHC.

... acknowledgments

The success of our development is also due to the help of some persons *external to the collaboration* that I would like to thank :

Bert Harrop, Daniel Marlow and PRISM

Eraldo Oliveri (RD51 tracker) and M. Van Stenis (lab for cleaning and optical inspection)

F. Manolescu and I. McGill and their colleagues of the CERN bonding lab.

SPS coordination team for the extra and parasitic beam time in the SPS.

W. Lohmann and M. Hemple for the valuable suggestions on the diamonds characterisation.

GSI and Hades group for the first metallizations and help in the design of the first prototype

BACKUP

TOTEM CT-PPS test beam, diamond detectors inside the RP

- 1: Coincidence of scintillators with variable area (tracker trigger).
- 2: Movable 4.5x4.5 mm² diamond for precise centering of the beam (sent also to tracker).
- 3,4: Fixed 4.5x4.5 mm² diamonds (X=-1.5 cm wrt the centre of the flange).
They allow the alignment of the RPs with respect to 2

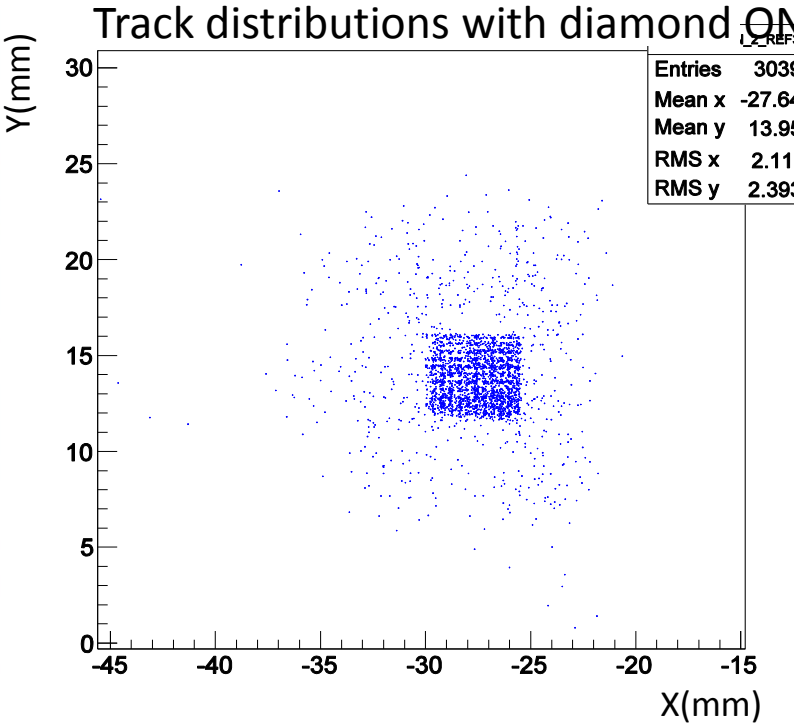
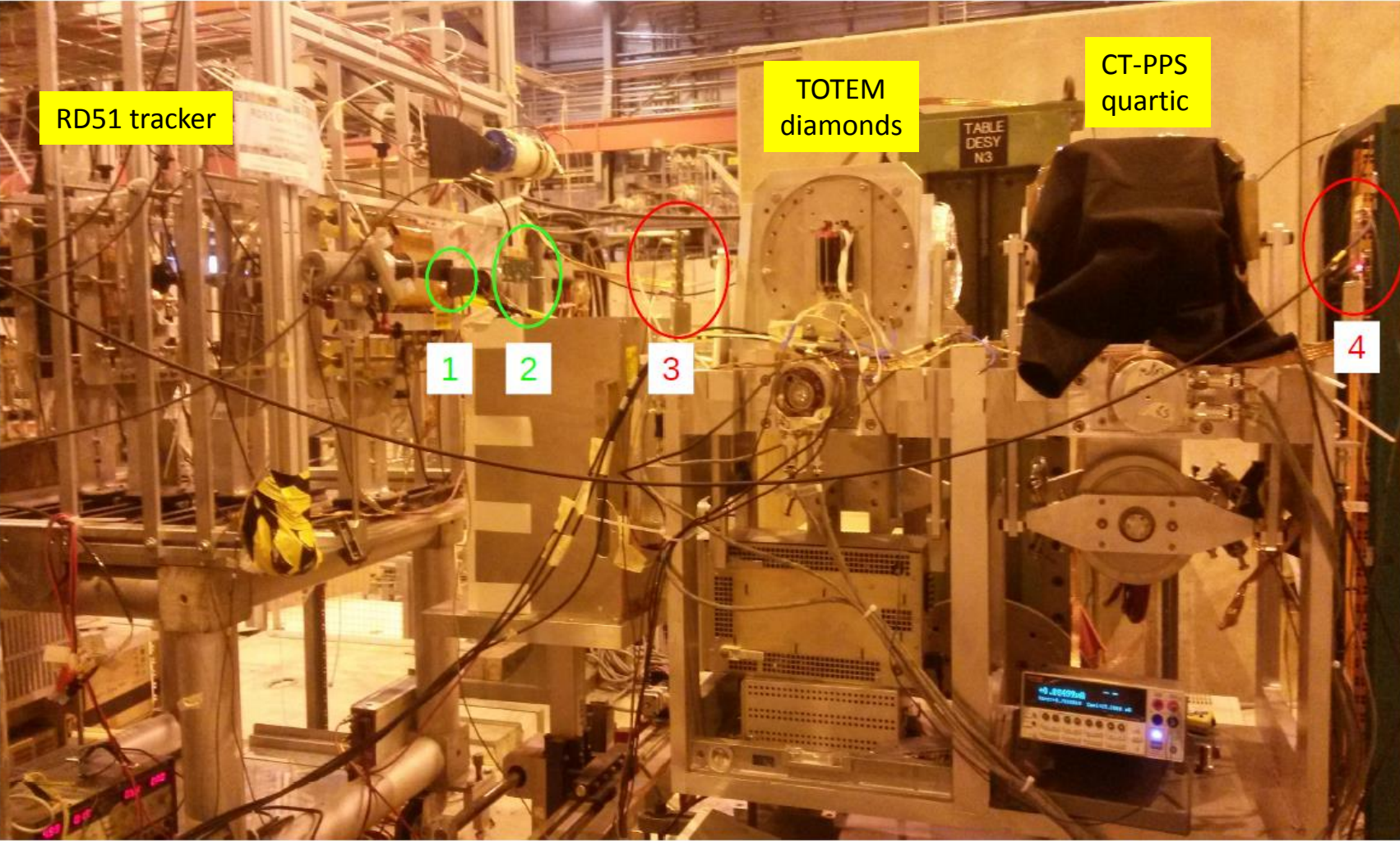

Diamond optical inspection/acceptance

Cleaning and visual inspection of 60 diamonds done:

- All diamonds inspected, cleaned, and pictures taken.

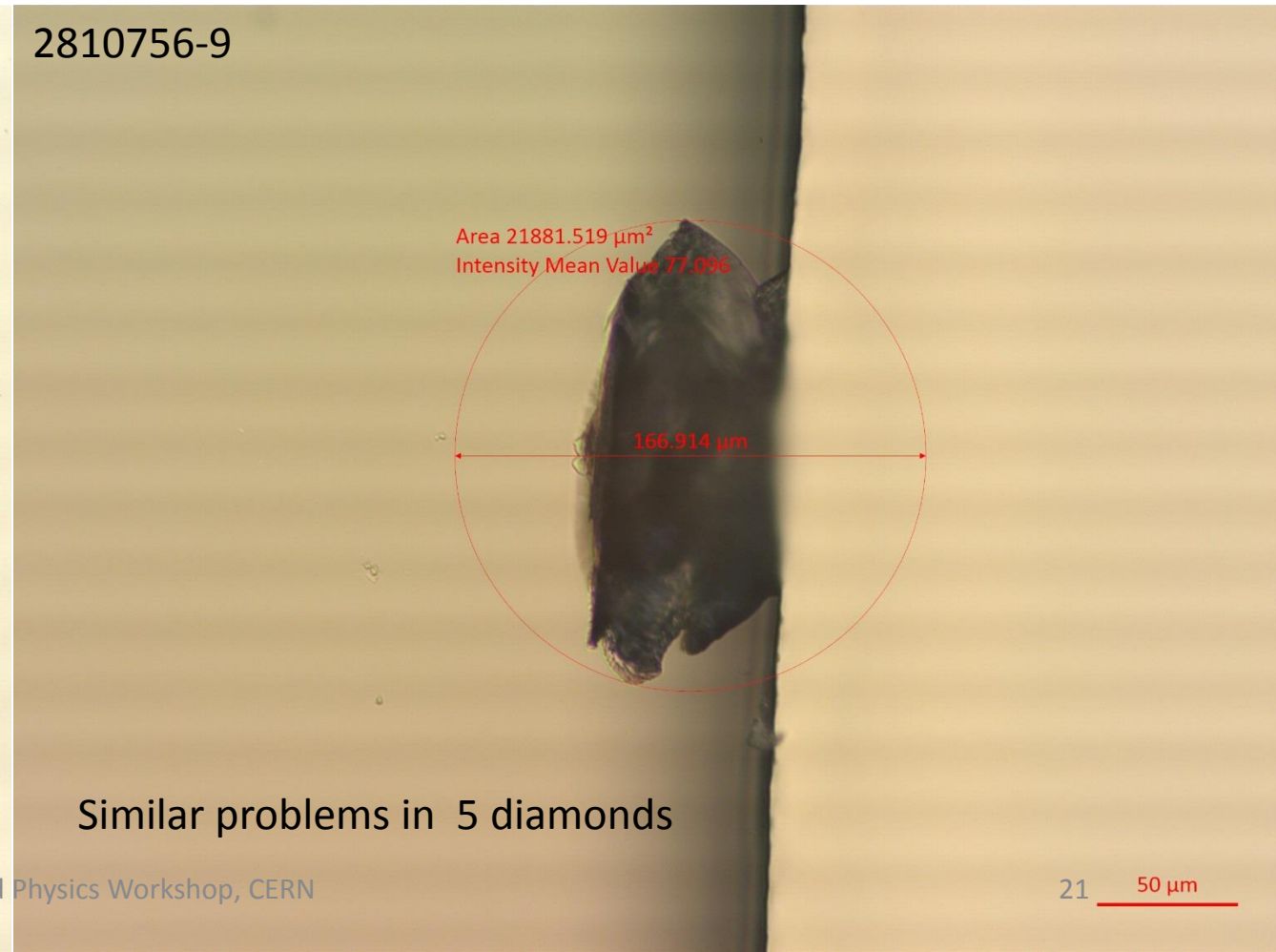
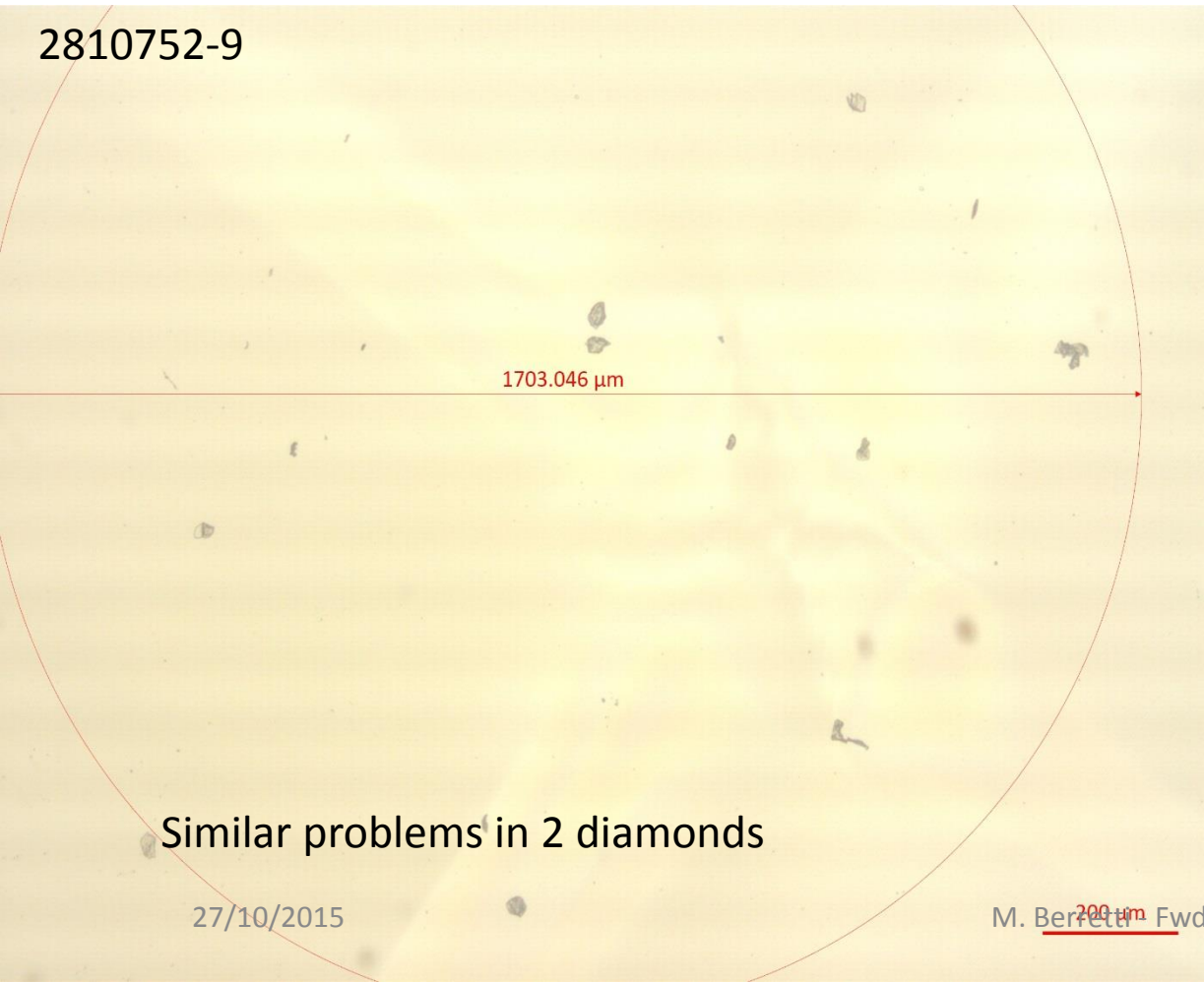

Diamond electrical tests:

Diamond I-V characteristics (segmented)

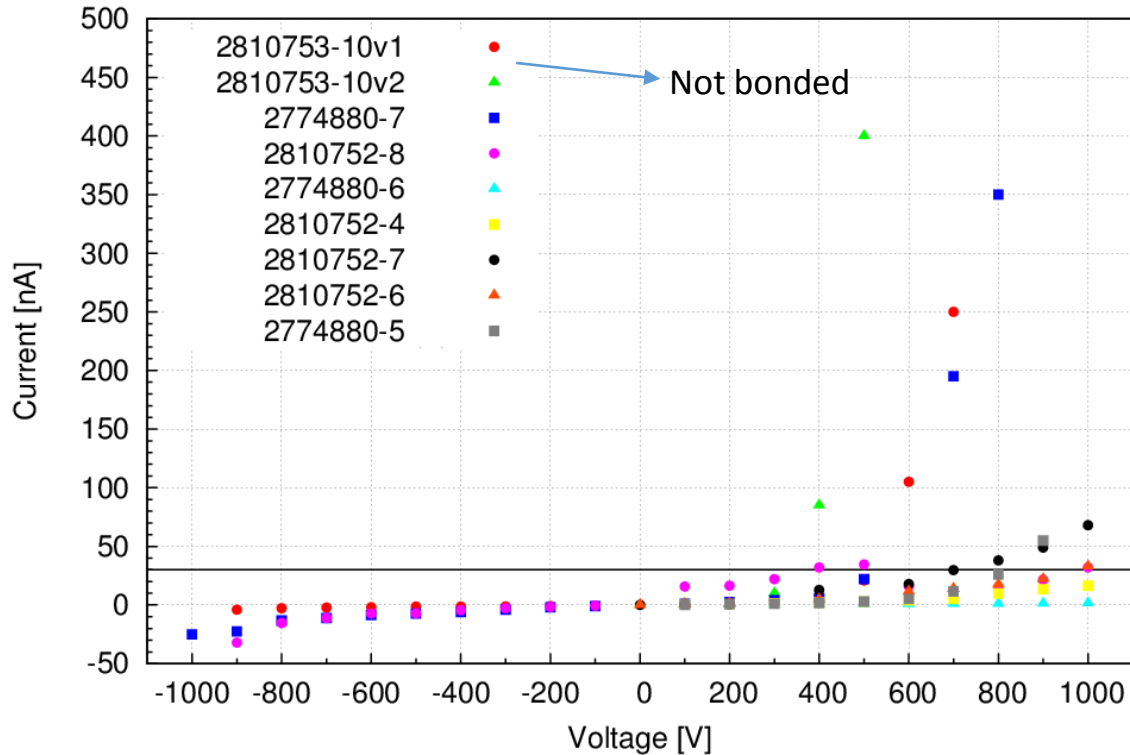

Diamond I-V characteristics (non-segmented)

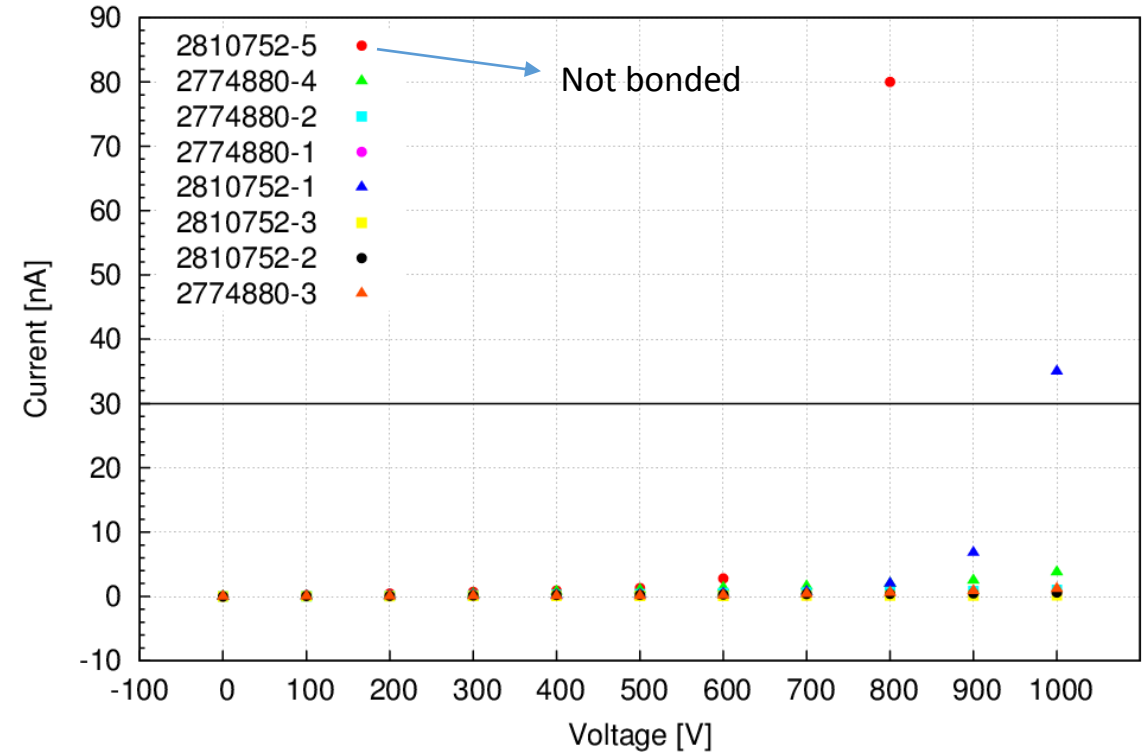

- **15 new diamonds tested and bonded to 4 hybrids:** only diamonds with $I < 100$ nA at 1KV was accepted, the real leakage current is expected to be much smaller, next measurement to be done in nitrogen chambers.
- **3 hybrids are complete** and ready for the installation (4 diamonds each), another has 3 diamonds bonded.
- **Possibility to have 6 full hybrids by September, but only one RP will be fully equipped.**
- Finally 48 diamonds have to be tested and bonded before the end of the winter shutdown.
- A Pre-metallization test to understand eventual preferred HV orientation has been agreed with Princeton for the rest of the diamonds

Diamond electrical tests: ^{90}Sr -source tests, 36.5 MBq

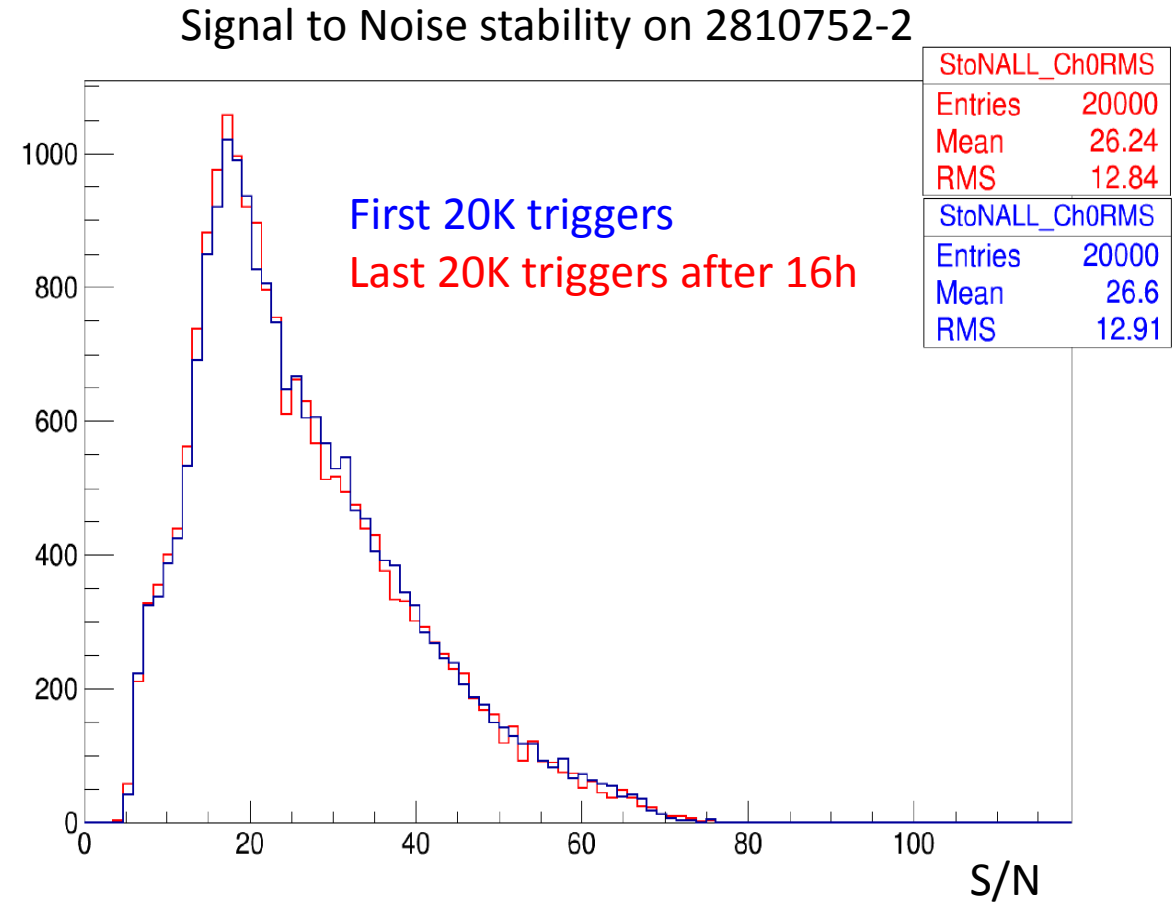
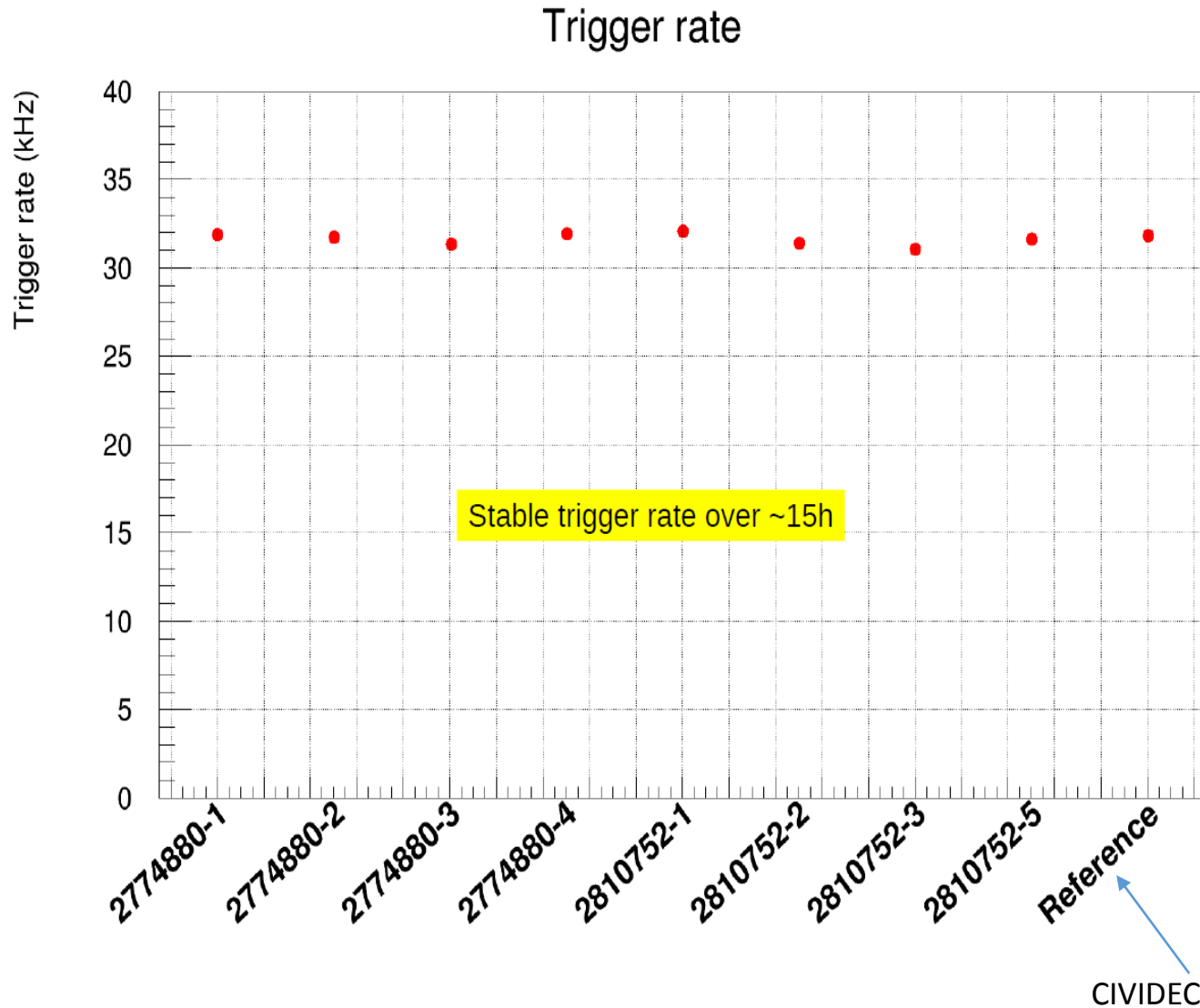

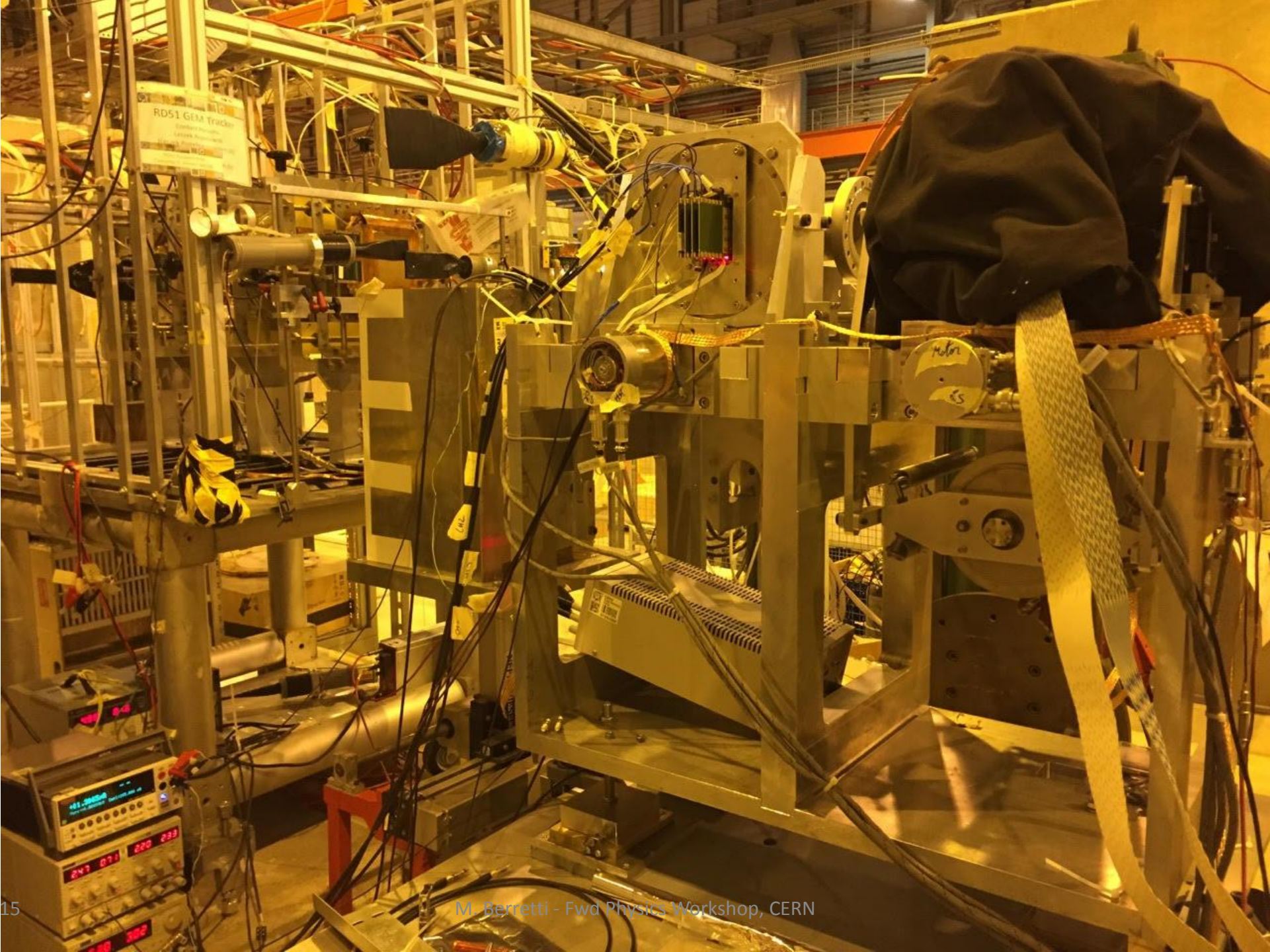

Trigger rate due to the noise for board 1,2,4 (700V)

Before Shielding

Noise Rate with 150 mV Trigger Threshold

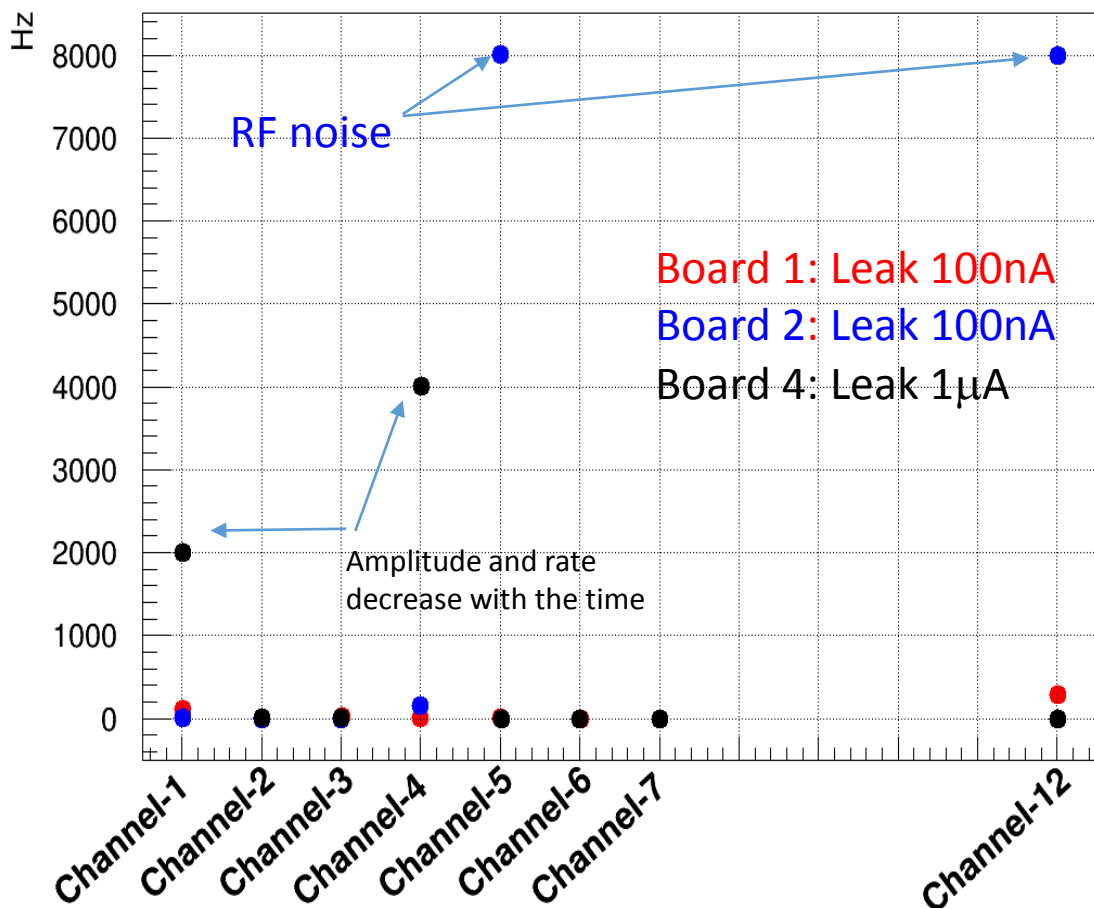

After Shielding

Noise Rate with 150 mV Trigger Threshold

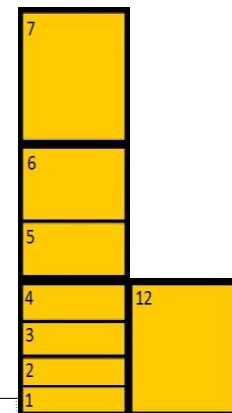
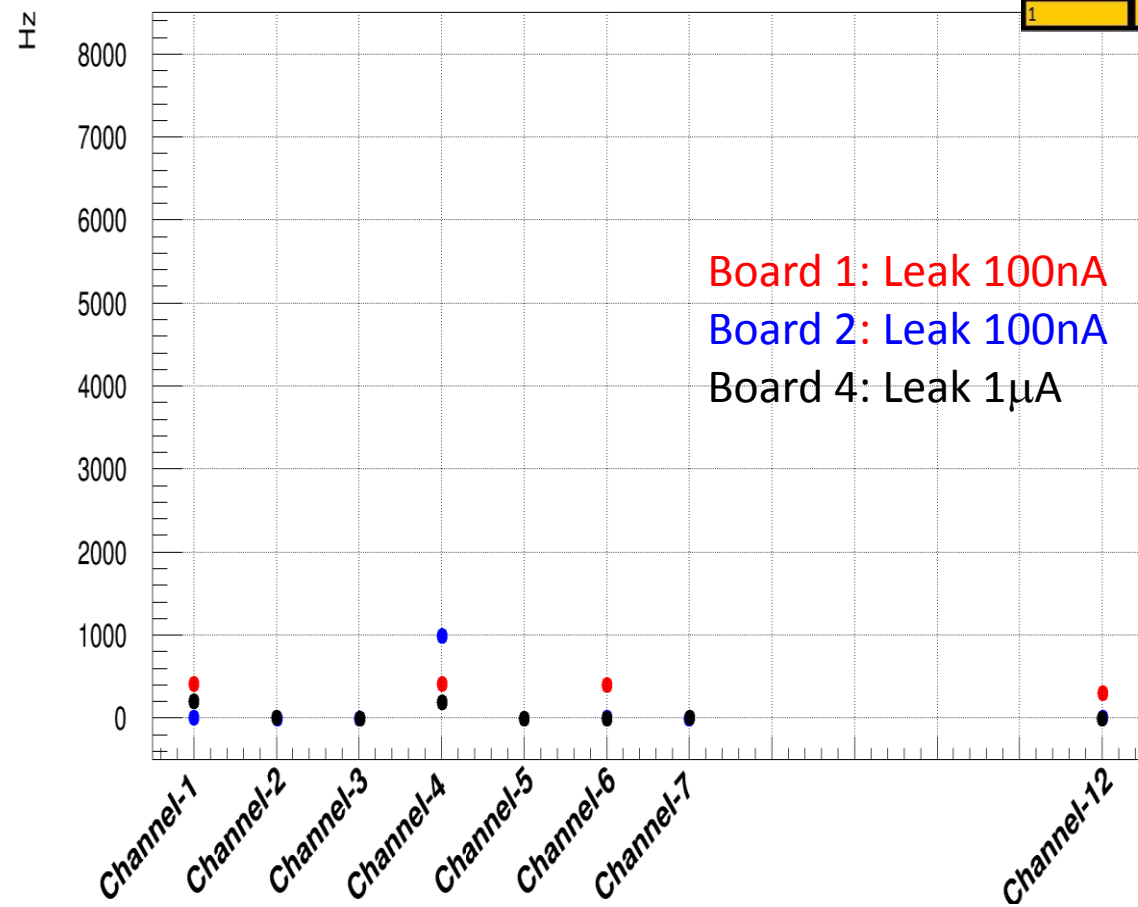

Trigger rate due to the noise for board 4, warm up effect

Noise Rate with 150 mV Trigger Threshold

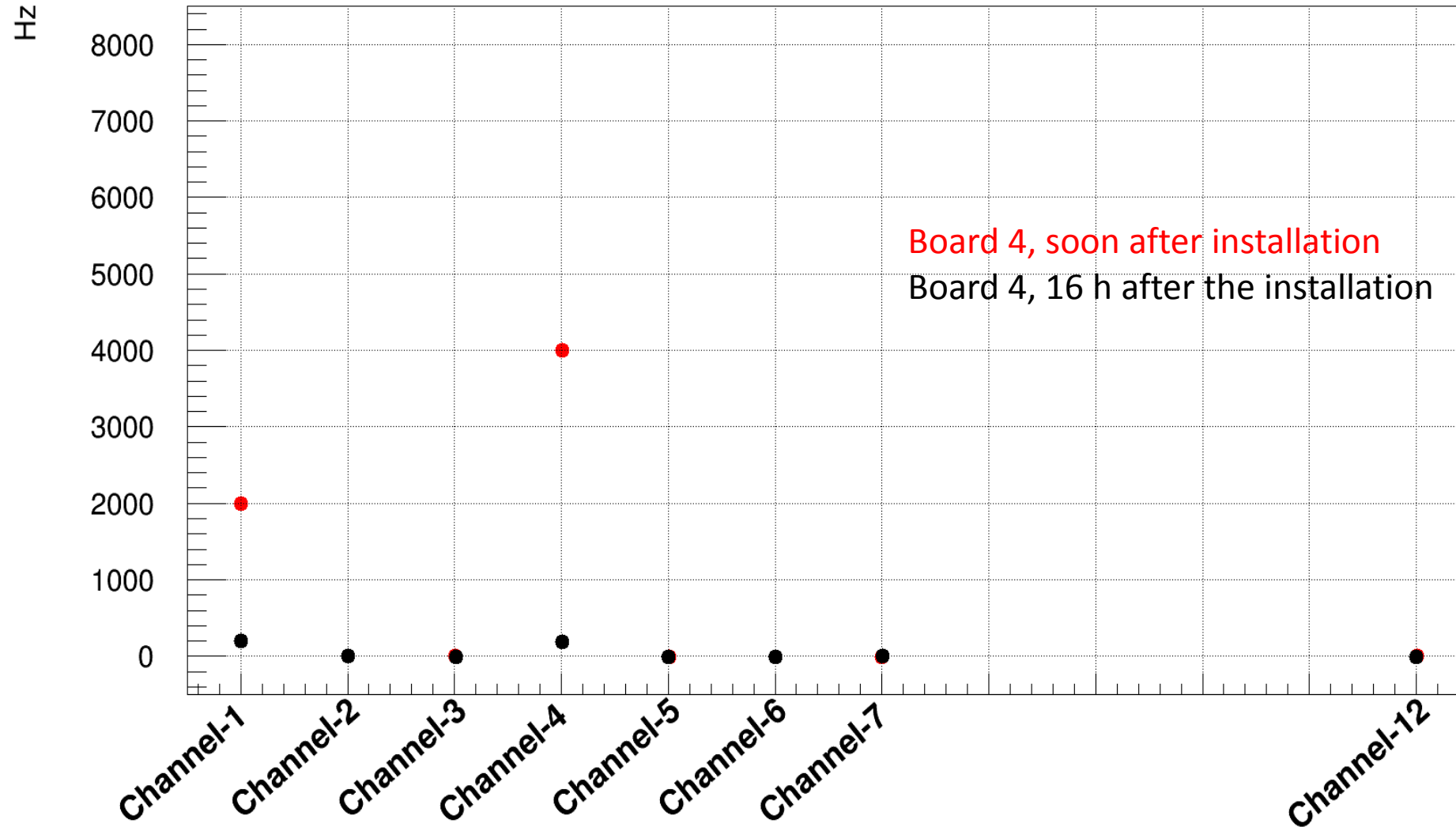

Noise VRMS for board 1,2,4

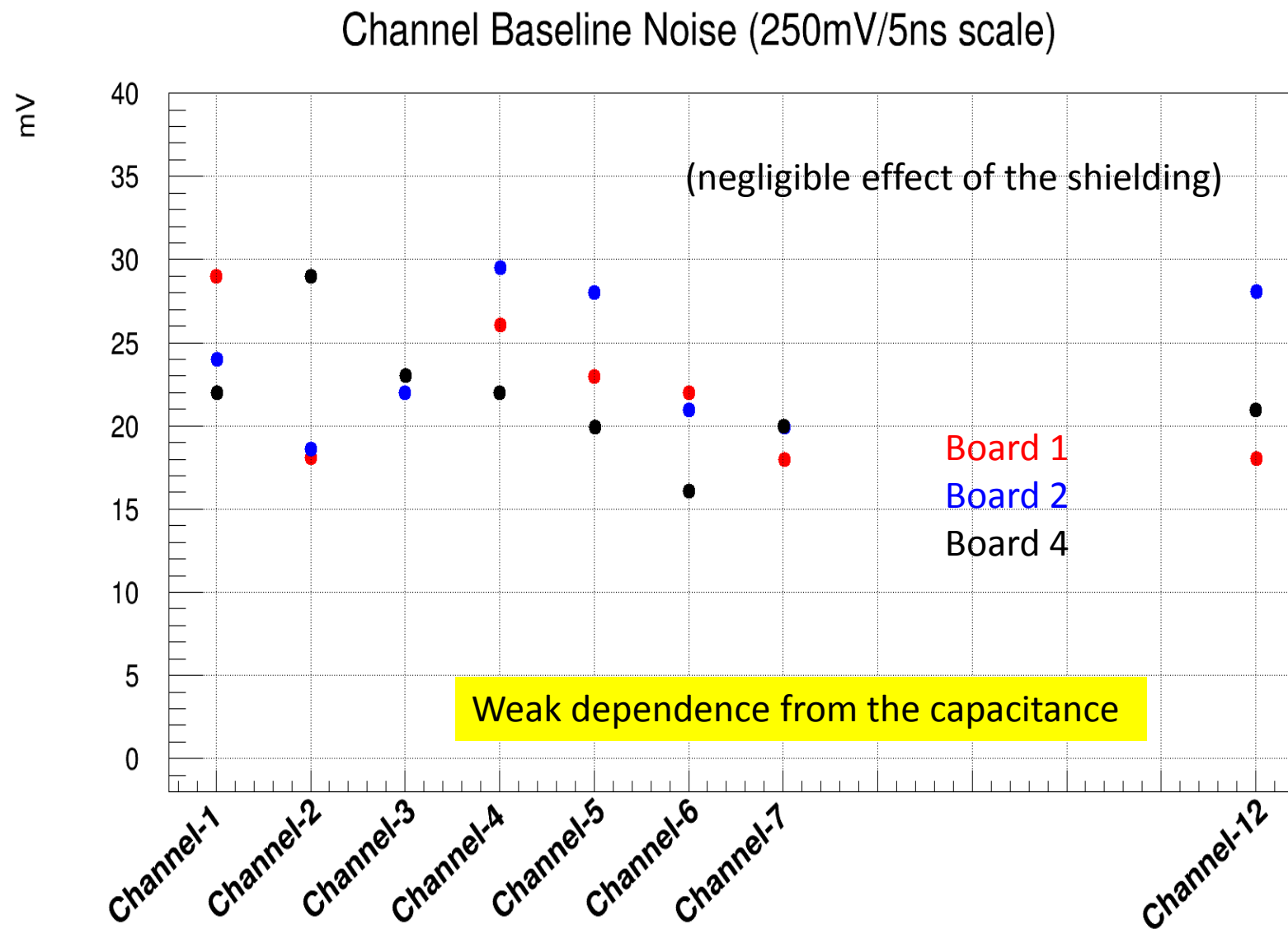

A diamond TOF detector

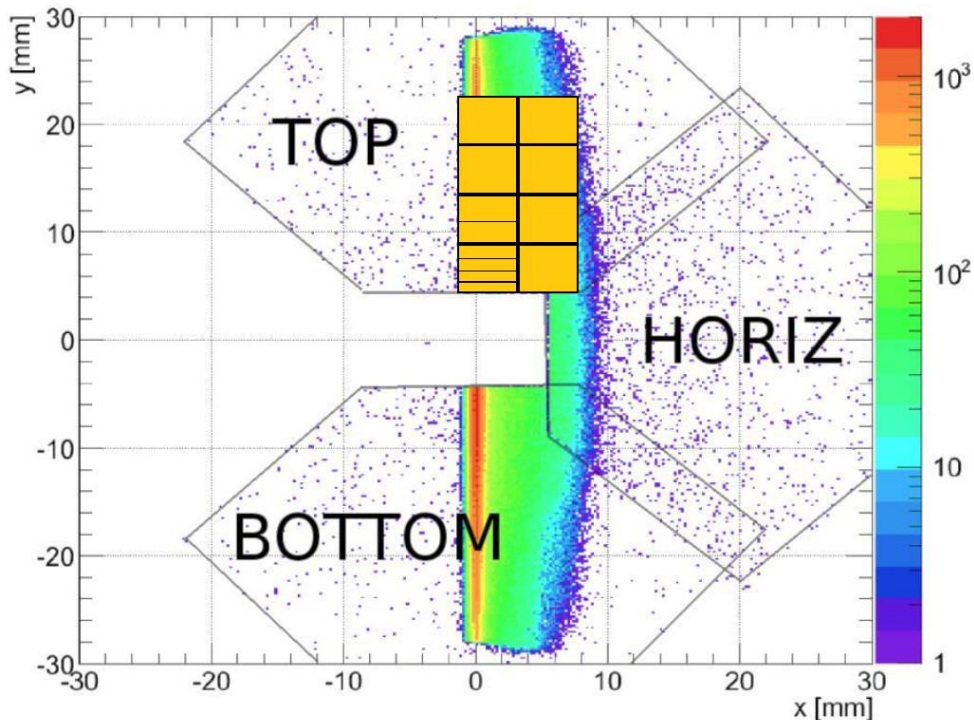

Track distribution in the 220F RP, for events with 2 protons in the final state. The golden picture on the TOP shows the diamond detector surface. The diamond detector in the BOTTOM RP is not reported for clarity.

Background Reduction:

- The measurement of the protons TOF adds an independent variable ($Z_{VTX} = c\Delta t/2$) that can be used in addition to the track-based variable to reduce the background (SD and beam background).
- For exclusive events, where the matching of the RP-reconstructed and the CMS-reconstructed variables are needed the TOF information is used to better understand the residual background and enhance the S/B.
- For inclusive events, or events with missing momentum the association of the proton to the CMS vertex by using only the tracking variables is more critical. Here timing information is crucial.
- **IN GENERAL, an additional factor 5 on the CD sample purity can be obtained from the installation of timing detector in the RP with 50 ps time resolution per arm.**

Effect of the shielding

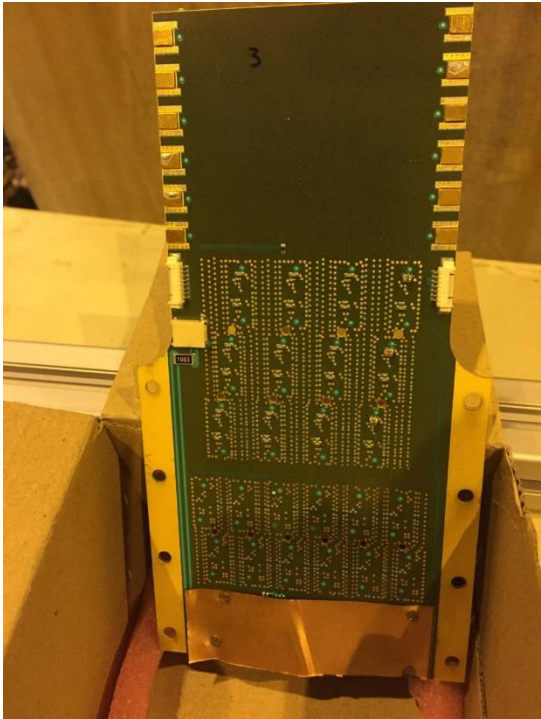

Eventual implementation in all the planes: to be decided after additional noise tests in different environments (or after TS3?)

