

*Instrumentation
for
High Energy Physics*

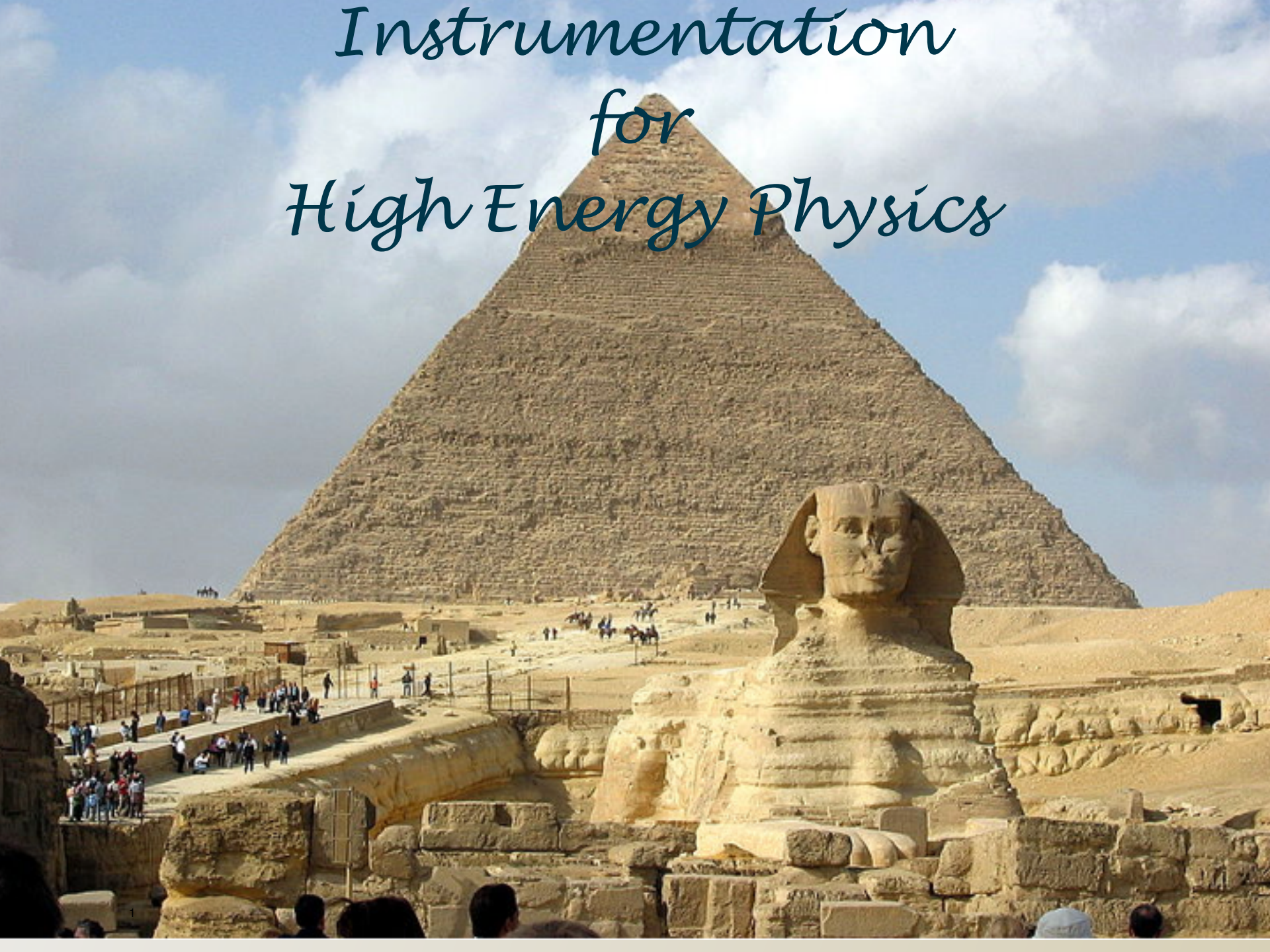



Instrumentation for High Energy Physics

Ludwik Dobrzynski

Laboratoire Leprince Ringuet - Ecole polytechnique - CNRS - IN2P3

Zewail City 15 November 2015

Instrumentation for High Energy Physics

Ludwik Dobrzynski

Laboratoire Leprince Ringuet - Ecole polytechnique - CNRS - IN2P3

Zewail City 15 November 2015



Instrumentation for High Energy Physics

- *Introduction*
- *Particle ID*
- *Particle Energy measurement*
- *Particle momenta measurement*

Ludwik Dobrzynski

Laboratoire Leprince Ringuet - Ecole polytechnique - CNRS - IN2P3

Zewail City 15 November 2015





Instrumentation in HEP

LM



Instrumentation in HEP

LM

Over three lectures, I propose to review the techniques used in High Energy Physics experiments for Particle Identification and their kinematic parameter measurement.

Over three lectures, I propose to review the techniques used in High Energy Physics experiments for Particle Identification and their kinematic parameter measurement.

- *Introduction*
- *Particle ID*
- *Particle energy measurement*

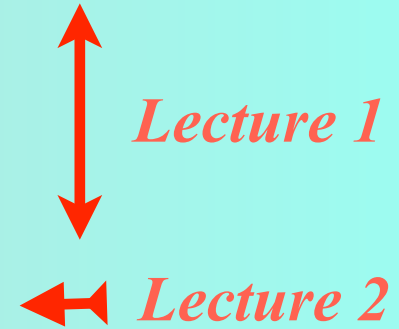



Instrumentation in HEP

LMR

Over three lectures, I propose to review the techniques used in High Energy Physics experiments for Particle Identification and their kinematic parameter measurement.

- *Introduction*
 - *Particle ID*
 - *Particle energy measurement*
 - *Particle momentum measurement*
- ↕ *Lecture 1*
- ← *Lecture 2*
- ← *Only notes*

Over three lectures, I propose to review the techniques used in High Energy Physics experiments for Particle Identification and their kinematic parameter measurement.

- *Introduction*
 - *Particle ID*
 - *Particle energy measurement*
 - *Particle momentum measurement*
- ↕ *Lecture 1*
- ← *Lecture 2*
- ← *Only notes*

Caution : *These topics are very wide so it would be a non sense to believe that they can be fully covered in 3 lectures. So a choice has been made.*

OF COURSE, I (might) have some personal bias, so I apologize in advance if your expectations are not full field.

Over three lectures, I propose to review the techniques used in High Energy Physics experiments for Particle Identification and their kinematic parameter measurement.

- *Introduction*
 - *Particle ID*
 - *Particle energy measurement*
 - *Particle momentum measurement*
- ↕ *Lecture 1*
- ← *Lecture 2*
- ← *Only notes*

Caution : *These topics are very wide so it would be a non sense to believe that they can be fully covered in 3 lectures. So a choice has been made.*

OF COURSE, I (might) have some personal bias, so I apologize in advance if your expectations are not full field.

For a more complete set of lectures go for instance to:

<http://www.kip.uni-heidelberg.de/~coulon/Lectures/Detectors/>

<http://www.kip.uni-heidelberg.de/~coulon/Lectures/JCDet/>

<http://cds.cern.ch/collection/Summer%20Student%20Lectures> (D. Bortoletto Oxford Univ.)

- “New directions in science are launched by new tools much more often than by new concepts.

The effect of a concept-driven revolution is to explain old things in new ways. The effect of a tool-driven revolution is to discover new things that have to be explained”

Freeman Dyson



- “Instrumentation for the 21st century. No one does it better than physicists when it come to innovation for instrumentation, and thus the future of all scientific fields rests on our hands.”

Michael S. Turner



Basic particle interactions in detector processes



Every effect of particles or radiation like

Basic particle interactions in detector processes

Every effect of particles or radiation like

Ionization:

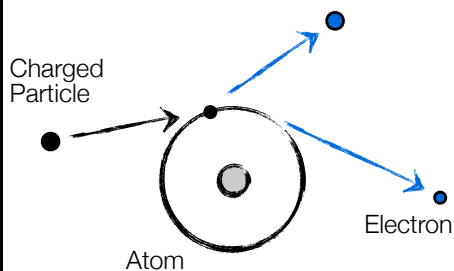
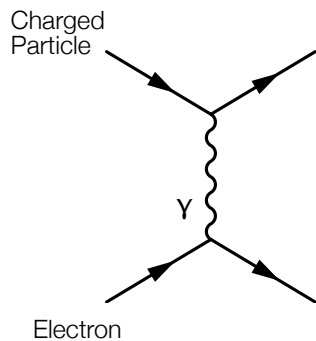

Pair production:

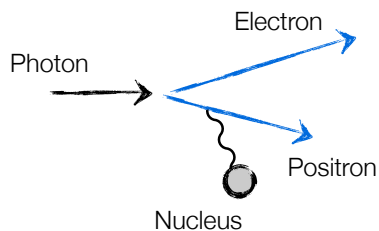
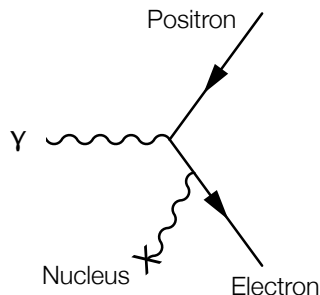

Compton scattering:

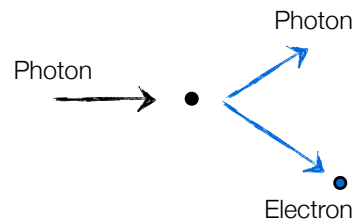
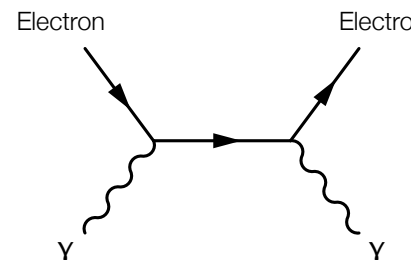

Basic particle interactions in detector processes

Every effect of particles or radiation like

Ionization:

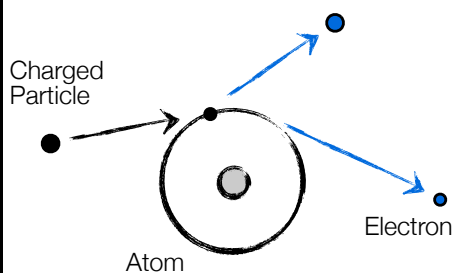
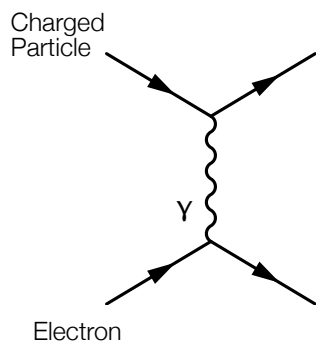

Pair production:

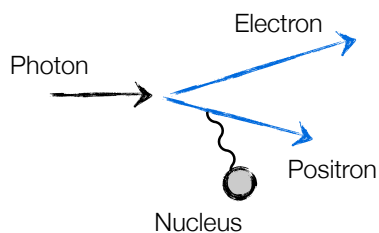
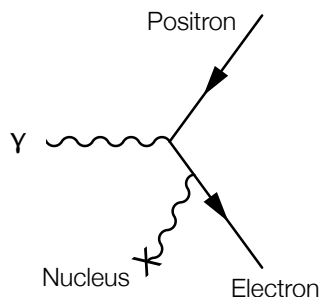

Compton scattering:

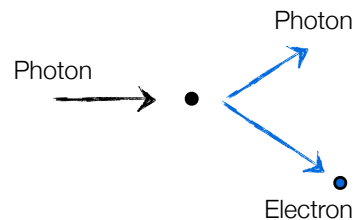
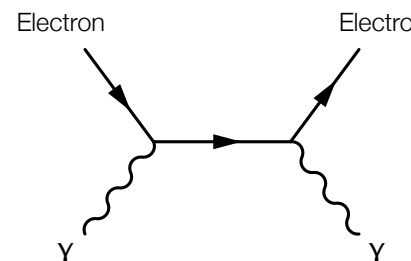

can be used as a working principle for a particle detector.

Basic particle interactions in detector processes

Every effect of particles or radiation like

Ionization:

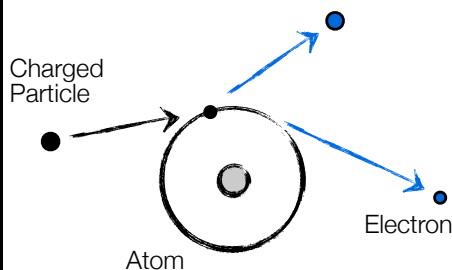
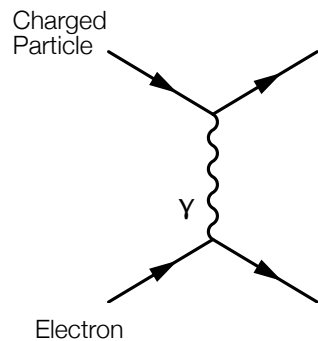

Pair production:

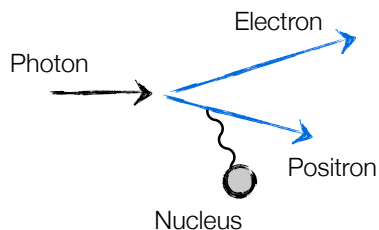
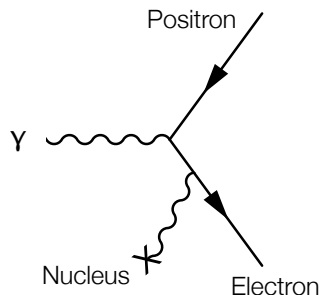

Compton scattering:

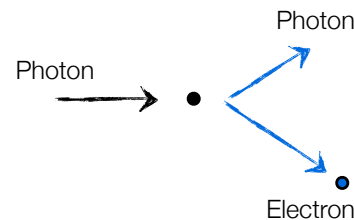
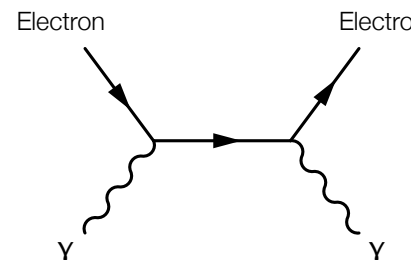

can be used as a working principle for a particle detector.

Claus Grupen



By 1959: 20 particles

e^- : fluorescent screen

n: ionization chamber

7 Cloud Chamber:

e^+

μ^+, μ^-

K^0

Λ^0

Ξ^-

Σ^-

6 Nuclear Emulsion:

π^+, π^-

anti- Λ^0

Σ^+

K^+, K^-

2 Bubble Chamber:

Ξ^0

Σ^0

3 with Electronic techniques:

anti-n

anti-p

π^0

NOBEL PRIZES FOR INSTRUMENTATION

[http://www.lhc-closer.es/
php/index.php?
i=1&s=9&p=2&e=0](http://www.lhc-closer.es/php/index.php?i=1&s=9&p=2&e=0)

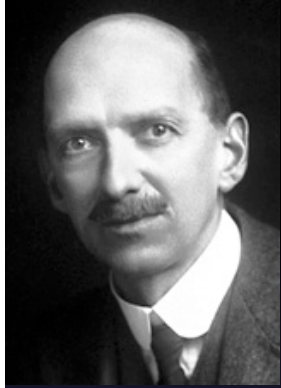

1927: C.T.R. Wilson, Cloud Chamber



1939: E. O. Lawrence, Cyclotron



1948: P.M.S. Blacket, Cloud Chamber



1950: C. Powell Photographic Method

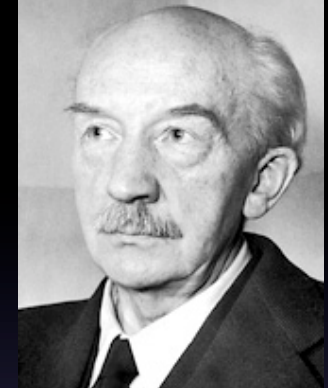

1954: W. Bothe Coincidence method

NOBEL PRIZES FOR INSTRUMENTATION

[http://www.lhc-closer.es/
php/index.php?
i=1&s=9&p=2&e=0](http://www.lhc-closer.es/php/index.php?i=1&s=9&p=2&e=0)

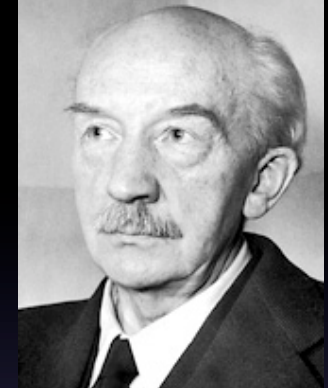

1927: C.T.R. Wilson, Cloud Chamber

1939: E. O. Lawrence, Cyclotron

1948: P.M.S. Blacket, Cloud Chamber

1950: C. Powell Photographic Method

1954: W. Bothe Coincidence method



1960: Donald Glaser, Bubble Chamber

1968: L. Alvarez Hydrogen Bubble Chamber

1992: G. Charpak Multi Wire Prop. Chamber

2009: W. S. Boyle & G. E. Smith CCD sensors



Start of a HEP experiment, one needs

LM

A theory:



A theory:

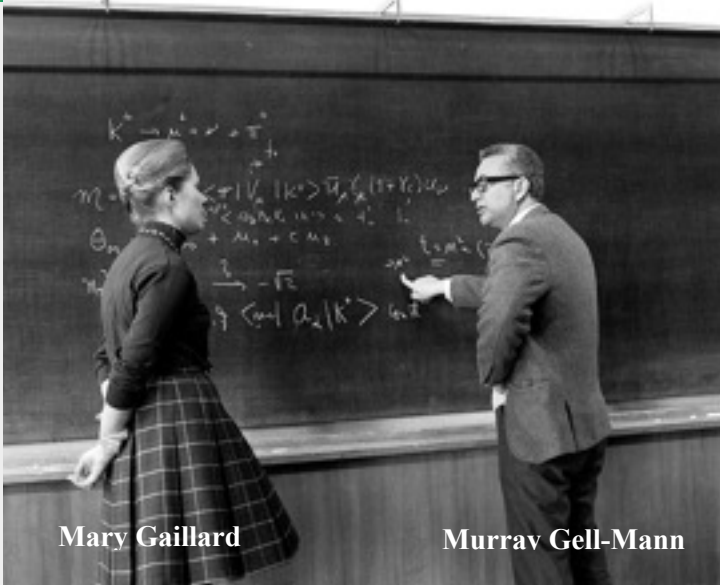

Mary Gaillard

Murray Gell-Mann

Start of a HEP experiment, one needs

LM

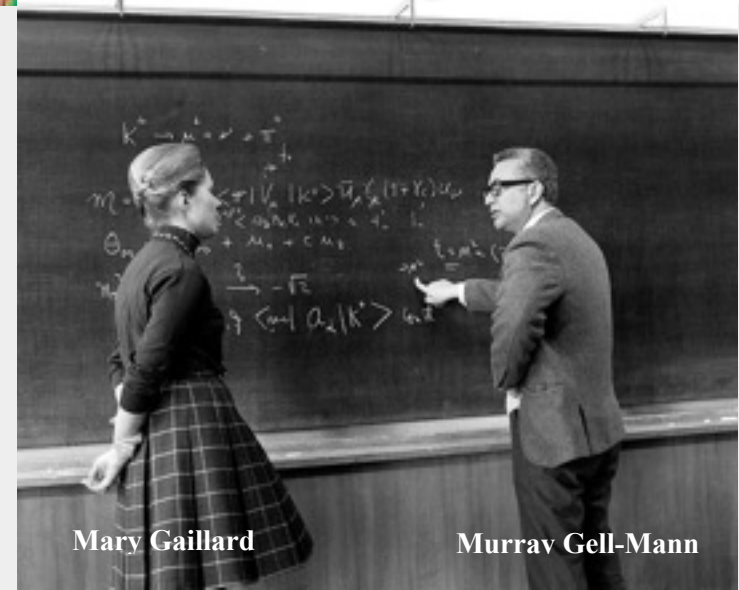

Mary Gaillard

Murray Gell-Mann

A theory:



and a cafeteria

Start of a HEP experiment, one needs

LM

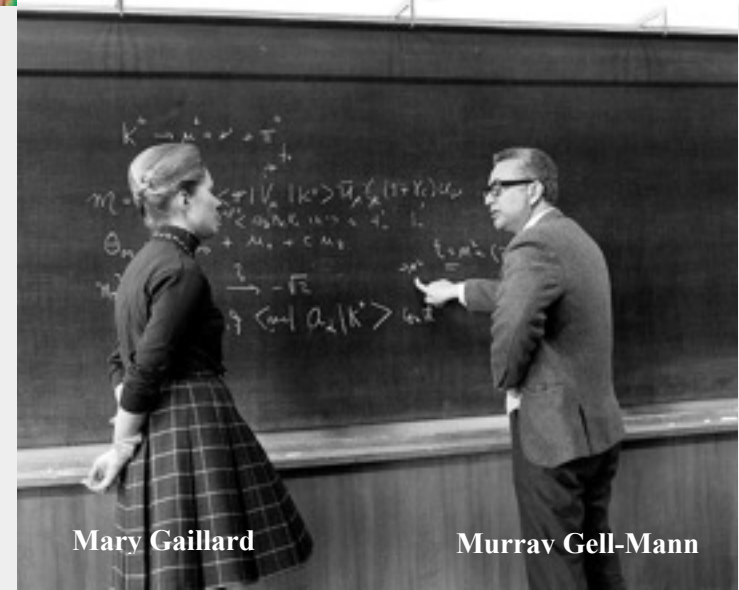

Mary Gaillard

Murray Gell-Mann

A theory:



and a cafeteria

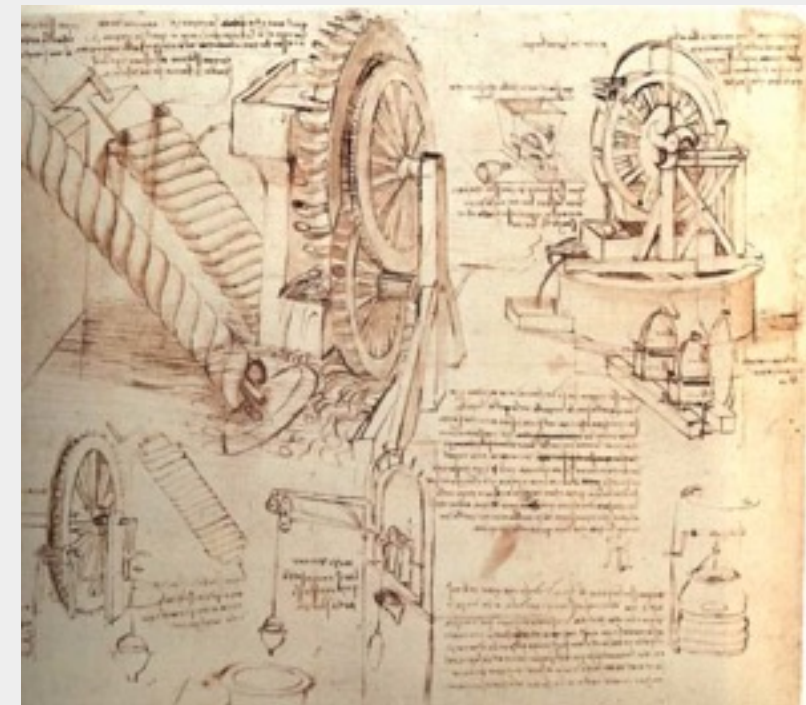

Clear and easy understandable drawings

Start of a HEP experiment, one needs

LM

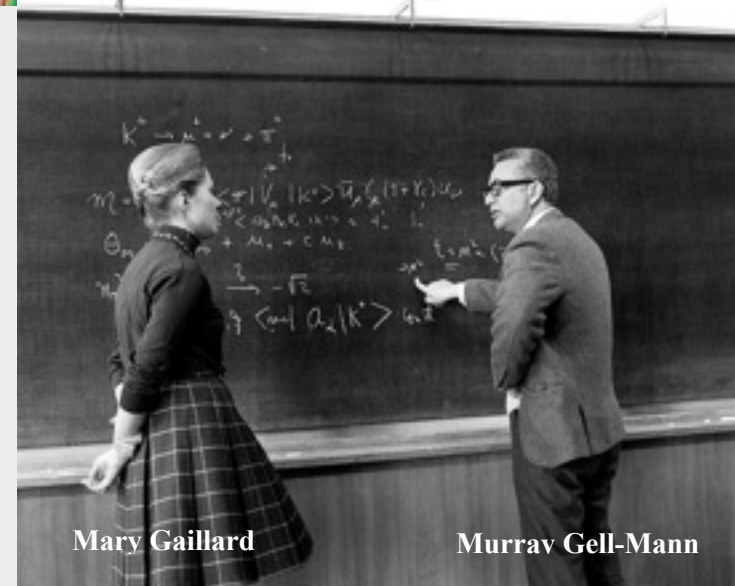

Mary Gaillard

Murray Gell-Mann

A theory:



and a cafeteria



Clear and easy understandable drawings

©. Ullaland/2006



and a tunnel for the accelerator and magnets and stuff



Easy access to
the experiment



Easy access to
the experiment



Physicists to operate detector/analyze data



Easy access to
the experiment



Physicists to operate detector/analyze data

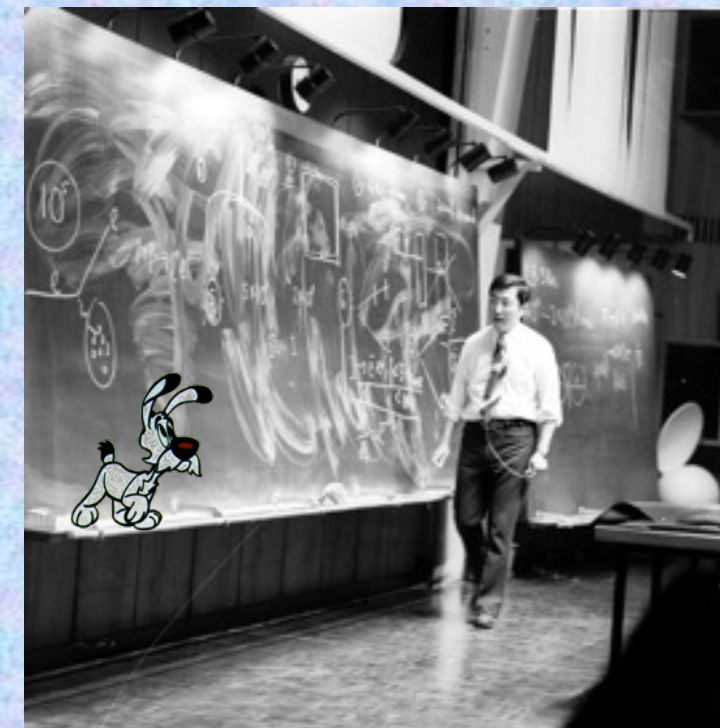

and a
Nobel
prize



**My lectures will just concentrate on
the detectors**

HEP Experiment: Simplified View

Proton
(quarks & gluons)



Proton
(quarks & gluons)

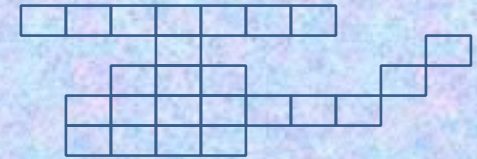

HEP Experiment: Simplified View



Proton
(quarks & gluons)

Proton
(quarks & gluons)



HEP Experiment: Simplified View



Proton
(quarks & gluons)

$$E=mc^2$$

Proton
(quarks & gluons)



HEP Experiment: Simplified View



Proton
(quarks & gluons)

Proton
(quarks & gluons)

$$E=mc^2$$

The collision energy of protons was used
to create new particles ("the dinosaurs"), that
did exist in the early days of Universe
but does not exist any more!





HEP Experiment: Simplified View

Proton
(quarks & gluons)

Proton
(quarks & gluons)

$$E=mc^2$$

The collision energy of protons was used to create new particles ("the dinosaurs"), that **did** exist in the early days of Universe but does not exist any more!



The interesting things ("the dinosaurs" – HIGGS and New Particles) disappear almost instantly.

We "see" the resulting particles – so we have to be like detectives – **precisely reconstruct particle tracks in the detector** to understand what happened !

HEP Experiment: Simplified View



Proton
(quarks & gluons)

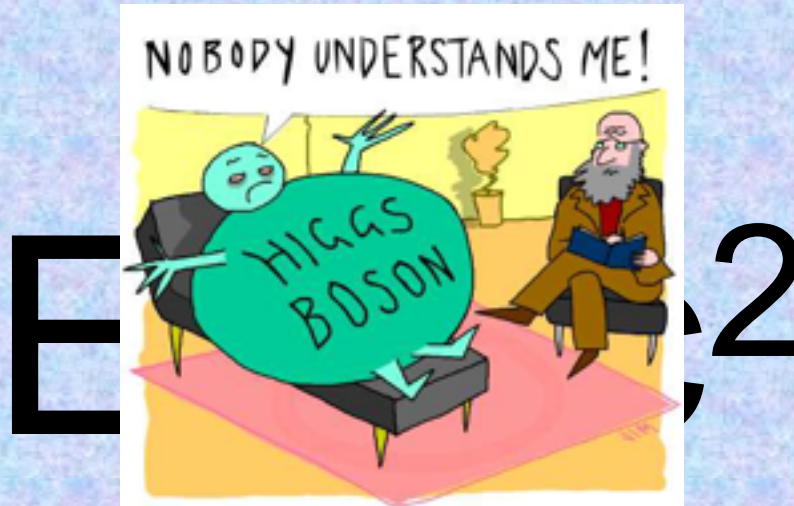

Proton
(quarks & gluons)

The collision energy of protons was used to create new particles ("the dinosaurs"), that *did* exist in the early days of Universe but does not exist any more!



The interesting things ("the dinosaurs" – HIGGS and New Particles) disappear almost instantly.

We "see" the resulting particles – so we have to be like detectives – precisely reconstruct particle tracks in the detector to understand what happened !



Concepts for the detector

LM

- *For which Physics?*
 - *Higgs : photon and lepton reconstruction*
 - *Top : lepton and jets reconstruction*
 - *SUSY : soft leptons, jets and Missing transverse energy*
 - *B mesons*

- *For which Physics?*
 - *Higgs : photon and lepton reconstruction*
 - *Top : lepton and jets reconstruction*
 - *SUSY : soft leptons, jets and Missing transverse energy*
 - *B mesons*
- *In which environment?*
 - *Radiation level*
 - *Accessibility limited sitting on the Collider*

- ***For which Physics?***
 - *Higgs : photon and lepton reconstruction*
 - *Top : lepton and jets reconstruction*
 - *SUSY : soft leptons, jets and Missing transverse energy*
 - *B mesons*
- ***In which environment?***
 - *Radiation level*
 - *Accessibility limited sitting on the Collider*
- ***A difficult compromise : look for the best performance within a given budget and feasibility***

- ***For which Physics?***
 - *Higgs : photon and lepton reconstruction*
 - *Top : lepton and jets reconstruction*
 - *SUSY : soft leptons, jets and Missing transverse energy*
 - *B mesons*
- ***In which environment?***
 - *Radiation level*
 - *Accessibility limited sitting on the Collider*
- ***A difficult compromise : look for the best performance within a given budget and feasibility***

- ***For which Physics?*** • ***=> detector structure and organisation***
 - *Higgs : photon and lepton reconstruction*
 - *Top : lepton and jets reconstruction*
 - *SUSY : soft leptons, jets and Missing transverse energy*
 - *B mesons*
- ***In which environment?*** • ***=> electronics, granularity, size ...***
 - *Radiation level*
 - *Accessibility limited sitting on the Collider*
- ***A difficult compromise : look for the best performance within a given budget and feasibility***

- ***For which Physics?***
 - *Higgs : photon and lepton reconstruction*
 - *Top : lepton and jets reconstruction*
 - *SUSY : soft leptons, jets and Missing transverse energy*
 - *B mesons*
 - ***In which environment?***
 - *Radiation level*
 - *Accessibility limited sitting on the Collider*
 - ***A difficult compromise : look for the best performance within a given budget and feasibility***
- ***=> detector structure and organisation***
 - ***=> electronics, granularity, size ...***
 - ***=> Real detector***



Physics case 1: Higgs => 2 photons + 4 leptons



- Reconstruct and identify isolated photons and leptons in a huge hadronic background (large pileup).

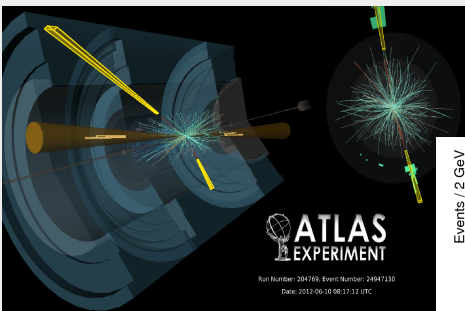

ATLAS EXPERIMENT

Run Number: 204769, Event Number: 34947310, Date: 2012-06-10 08:17:12 UTC

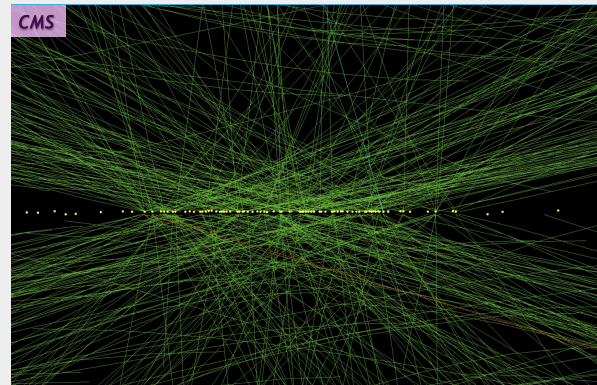
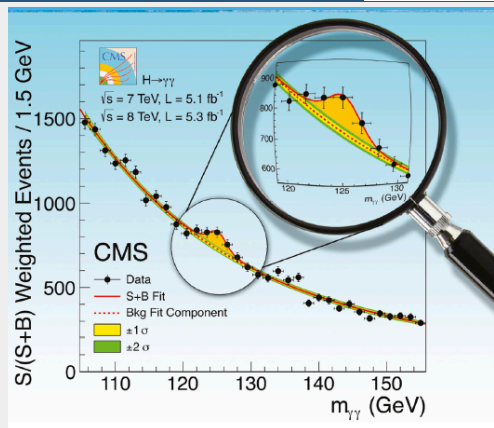
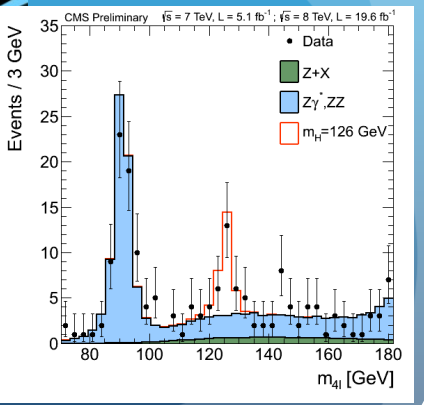
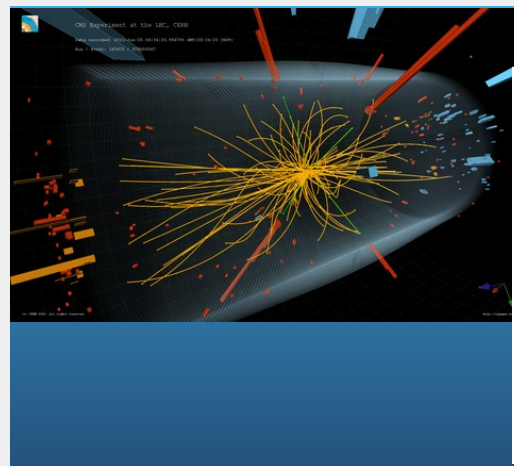
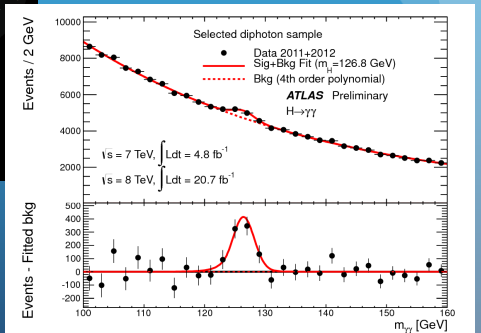

Physics case 1: Higgs => 2 photons + 4 leptons

- Reconstruct and identify isolated photons and leptons in a huge hadronic background (large pileup).

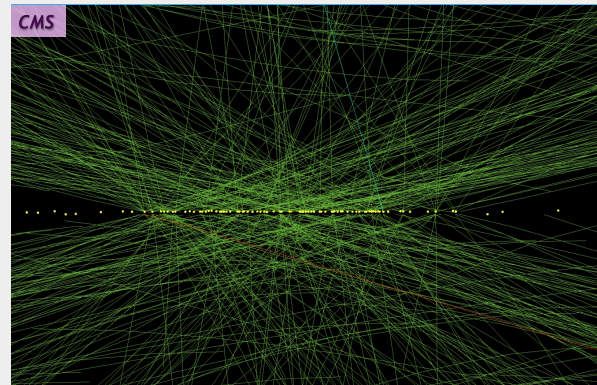
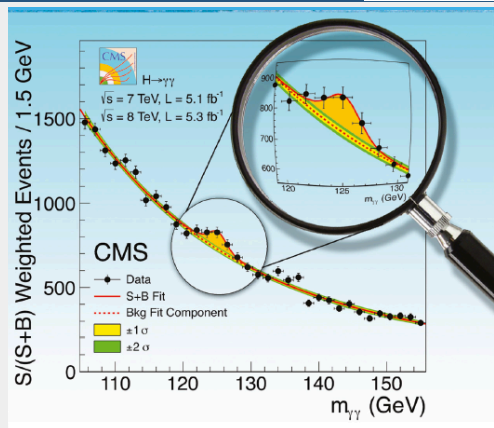
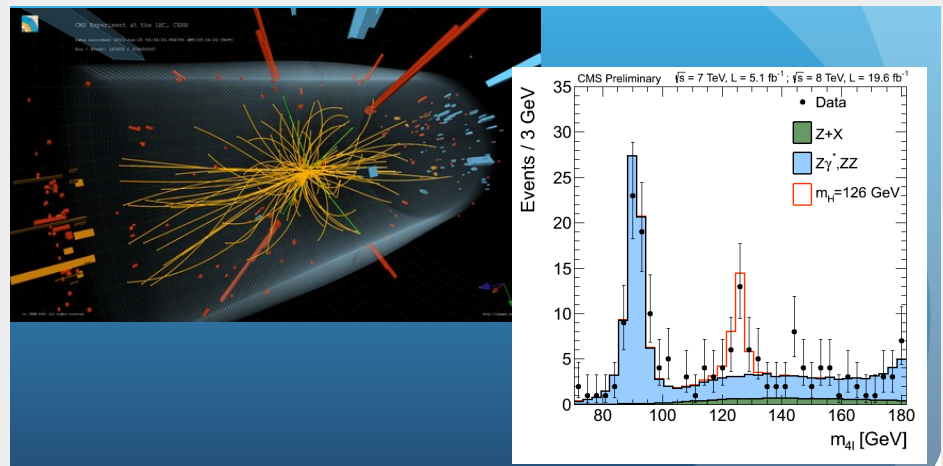
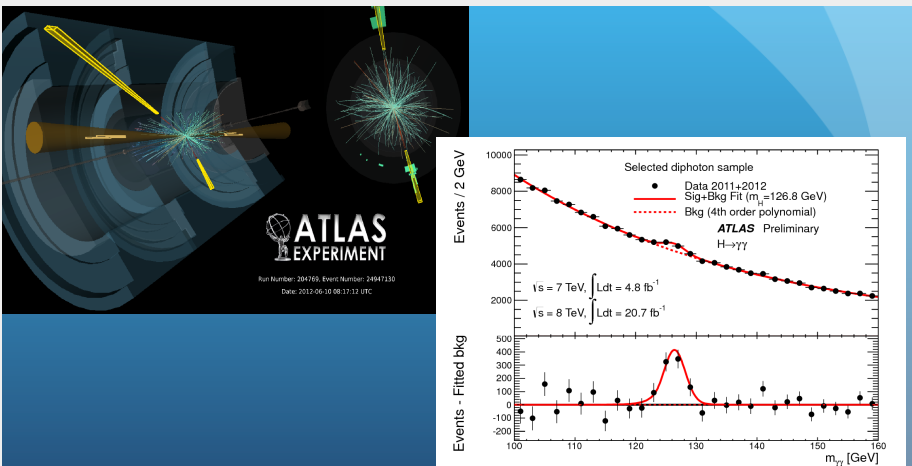

Questions :

- How to measure the photon energy with precision. Is a tracker necessary?
- Which is the dominant background and how do I get rid of it?
- What kind of calorimeter do I need



Physics case 1: Higgs => 2 photons + 4 leptons



- Reconstruct and identify isolated photons and leptons in a huge hadronic background (large pileup).

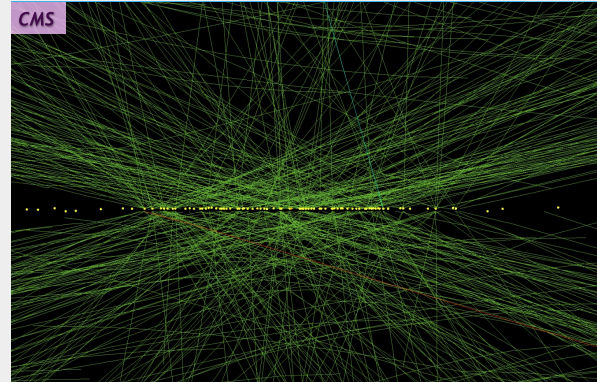
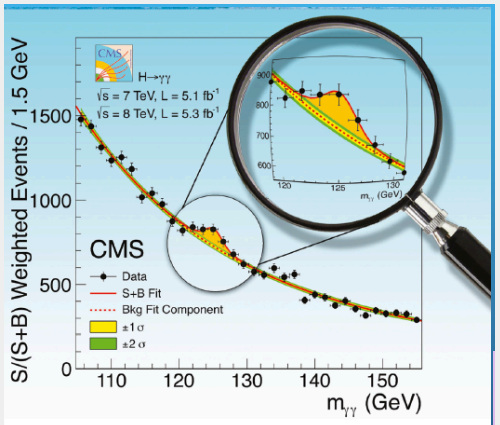
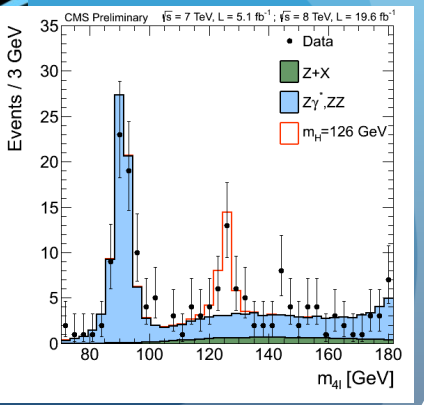
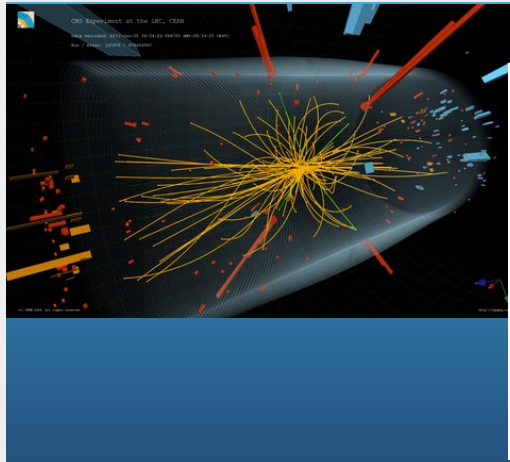
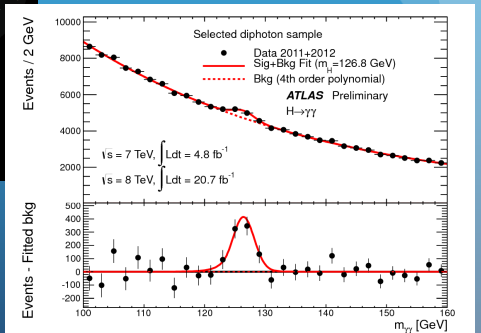
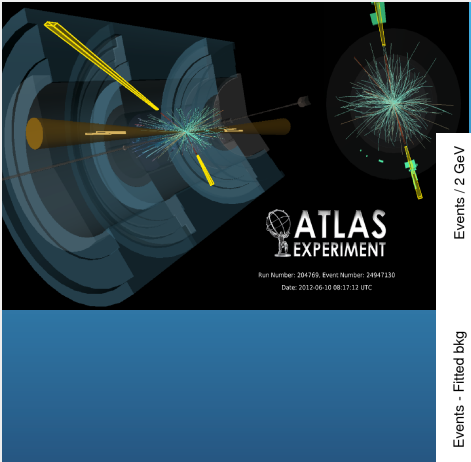

Questions :

- How to measure the photon energy with precision. Is a tracker necessary?
- Which is the dominant background and how do I get rid of it?
- What kind of calorimeter do I need

The response is straight forward : Best tracking system and Best Electromagnetic calorimeter

... or to discover

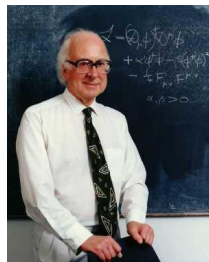

boson
with ATLAS and CMS ...

- Inelastic: 10^9 Hz
- Higgs ($100 \text{ GeV}/c^2$): 0.1 Hz
- Higgs ($600 \text{ GeV}/c^2$): 10^{-2} Hz
- Selection : $1:10^{10-11}$
- Operate in high radiation environment
- Resolve 20-25 superimposed events per BX
- High granularity detectors
- Fast electronics/detectors (25 ns)

Energy scale crucial !

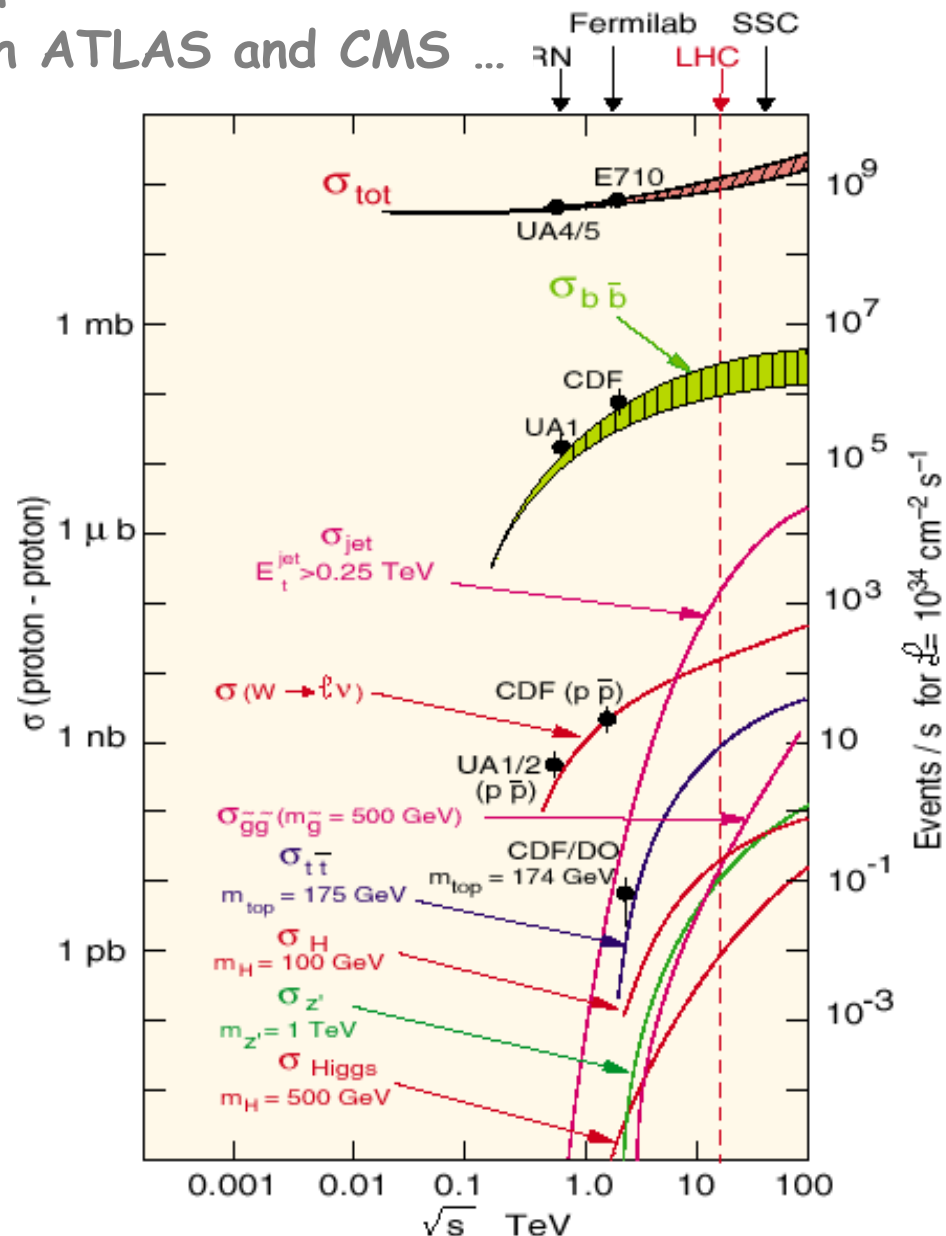



Particle detector concept (1)

LM

- **All detector concept are based on basic knowledge of particle interactions with matter. Most involved processes are implying :** electromagnetic interaction, ionisation, excitation, photo-electric effects, pair creation, bremsstrahlung, Cerenkov effect, transition radiation....

- **All detector concept are based on basic knowledge of particle interactions with matter. Most involved processes are implying :** electromagnetic interaction, ionisation, excitation, photo-electric effects, pair creation, bremsstrahlung, Cerenkov effect, transition radiation....
- **The detector construction**
 - result from a detailed study of all types of particles propagation through the detector
 - and the confirmation of the prediction by the results obtained in a test beam

- **All detector concept are based on basic knowledge of particle interactions with matter. Most involved processes are implying :** electromagnetic interaction, ionisation, excitation, photo-electric effects, pair creation, bremsstrahlung, Cerenkov effect, transition radiation....
- **The detector construction**
 - result from a detailed study of all types of particles propagation through the detector
 - and the confirmation of the prediction by the results obtained in a test beam
- **The detector should be as radiation hard as possible :**
 - it's a strong constraint on the detector material and on the electronics

- **All detector concept are based on basic knowledge of particle interactions with matter. Most involved processes are implying :** electromagnetic interaction, ionisation, excitation, photo-electric effects, pair creation, bremsstrahlung, Cerenkov effect, transition radiation....
- **The detector construction**
 - result from a detailed study of all types of particles propagation through the detector
 - and the confirmation of the prediction by the results obtained in a test beam
- **The detector should be as radiation hard as possible :**
 - it's a strong constraint on the detector material and on the electronics

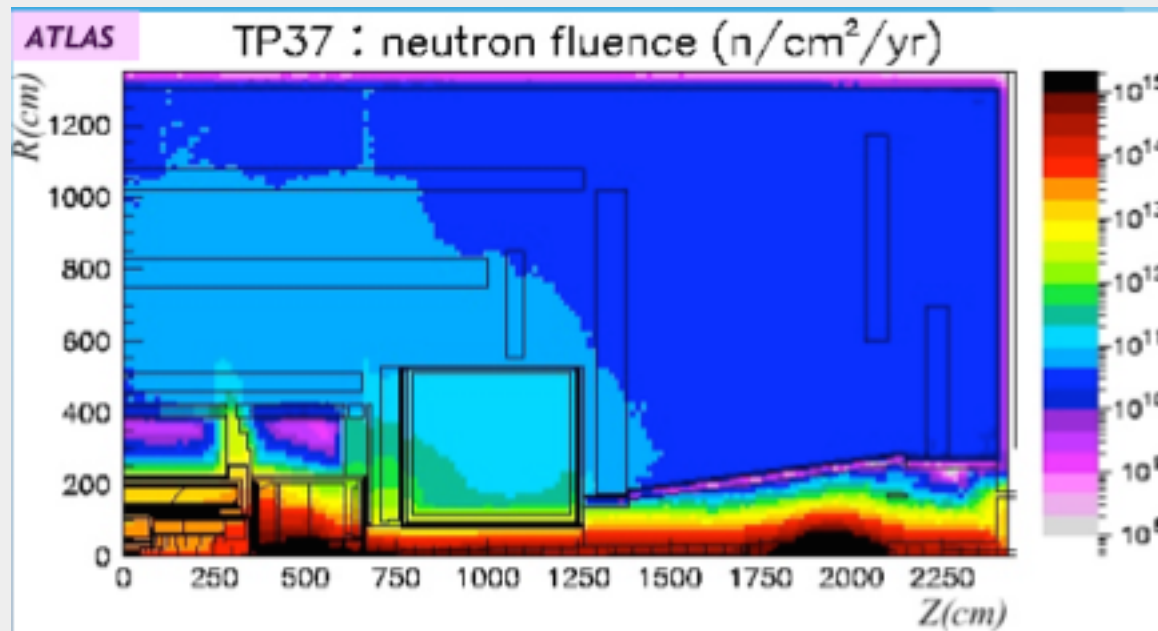



Particle Detector concept (2)

LM

- What determines the Size, Material and Geometry of the Detector?
 - Impact Parameter Measurement
 - Momentum Measurement
 - Energy Measurement
 - Muon Measurement

- What determines the Size, Material and Geometry of the Detector?
 - Impact Parameter Measurement
 - Momentum Measurement
 - Energy Measurement
 - Muon Measurement

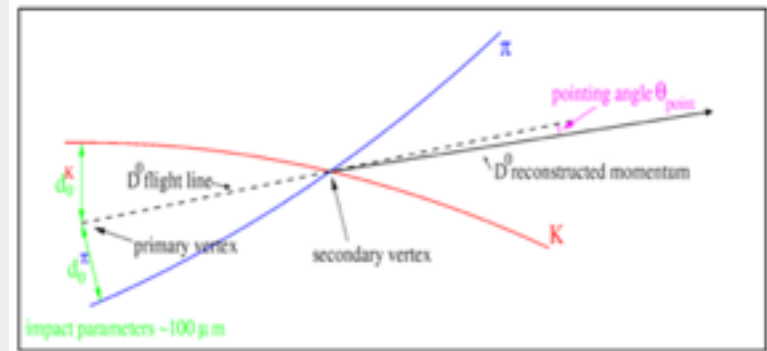

- What determines the Size, Material and Geometry of the Detector?

- Impact Parameter Measurement
- Momentum Measurement
- Energy Measurement
- Muon Measurement

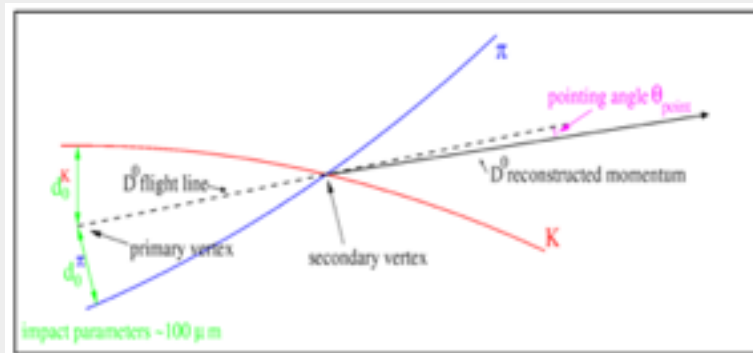

- Constraints

- Multiple scattering which has to be reduced as much as possible
- Impact Parameter resolution
(Secondary Vertex)
- Lever arm and Magnetic Field for
Momentum Measurement
- Material budget

- What determines the Size, Material and Geometry of the Detector?

- Impact Parameter Measurement
- Momentum Measurement
- Energy Measurement
- Muon Measurement

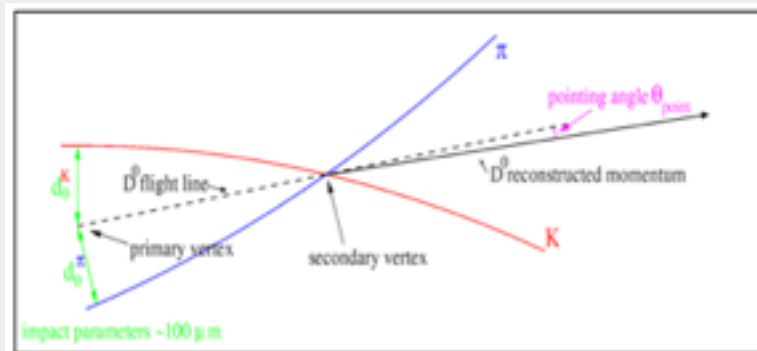

- Constraints

- Multiple scattering which has to be reduced as much as possible
- Impact Parameter resolution
(Secondary Vertex)
- Lever arm and Magnetic Field for
Momentum Measurement
- Material budget

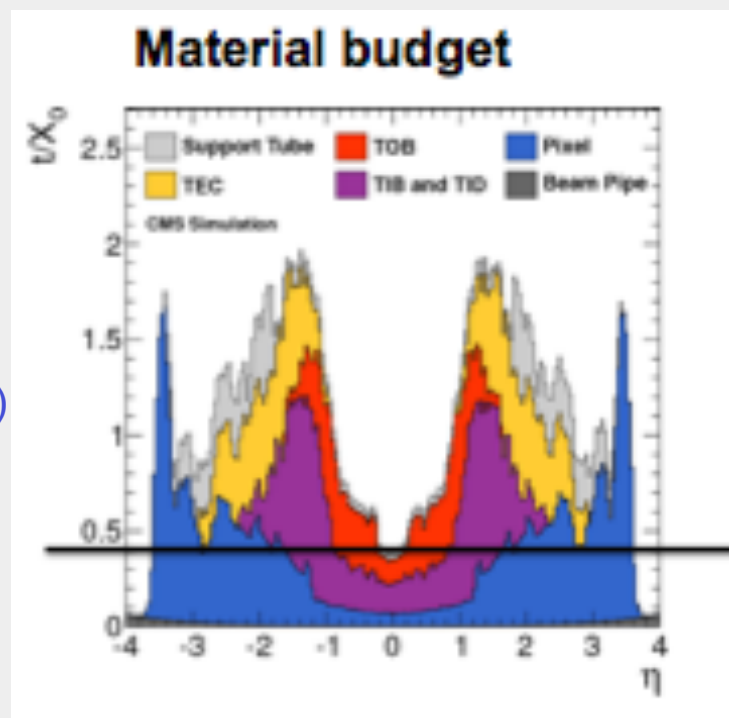



LHC experimental challenge

LM

- **LHC detectors must have fast response**
 - ◆ Otherwise will integrate over many bunch crossings → large “pile-up”
 - ◆ Typical response time : 20-50 ns
 - integrate over 1-2 bunch crossings → pile-up of 25-50 min-bias
 - very challenging readout electronics
- **LHC detectors must be highly granular**
 - ◆ Minimize probability that pile-up particles be in the same detector element as interesting object (e.g. γ from $H \rightarrow \gamma\gamma$ decays)
 - large number of electronic channels
 - high cost
- **LHC detectors must be radiation resistant:**
 - ◆ high flux of particles from pp collisions → high radiation environment e.g. in forward calorimeters:
 - up to 10^{17} n/cm² in 10 years of LHC operation
 - up to 10^7 Gy (1 Gy = unit of absorbed energy = 1 Joule/Kg)



Exemple : Atlas and CMS Detector



CMS DETECTOR

Total weight : 14,000 tonnes
 Overall diameter : 15.0 m
 Overall length : 28.7 m
 Magnetic field : 3.8 T

STEEL RETURN YOKE
 12,500 tonnes

SILICON TRACKERS
 Pixel (100x150 μm) - 16m² - 66M channels
 Microstrips (80x180 μm) - 200m² - 9.6M channels

SUPERCONDUCTING SOLENOID
 Niobium titanium coil carrying - 18,000A

MUON CHAMBERS
 Barrel: 250 Drift Tube, 480 Resistive Plate Chambers
 Endcaps: 468 Cathode Strip, 432 Resistive Plate Chambers

PRE-SHOWER
 Silicon strips - 16m² - 137,000 channels

FORWARD CALORIMETER
 Steel + Quartz fibres - 2,000 Channels

CRYSTAL ELECTROMAGNETIC CALORIMETER (ECAL)
 76,000 scintillating PbWO₄ crystals

HADRON CALORIMETER (HCAL)
 Brass + Plastic scintillator - 7,000 channels

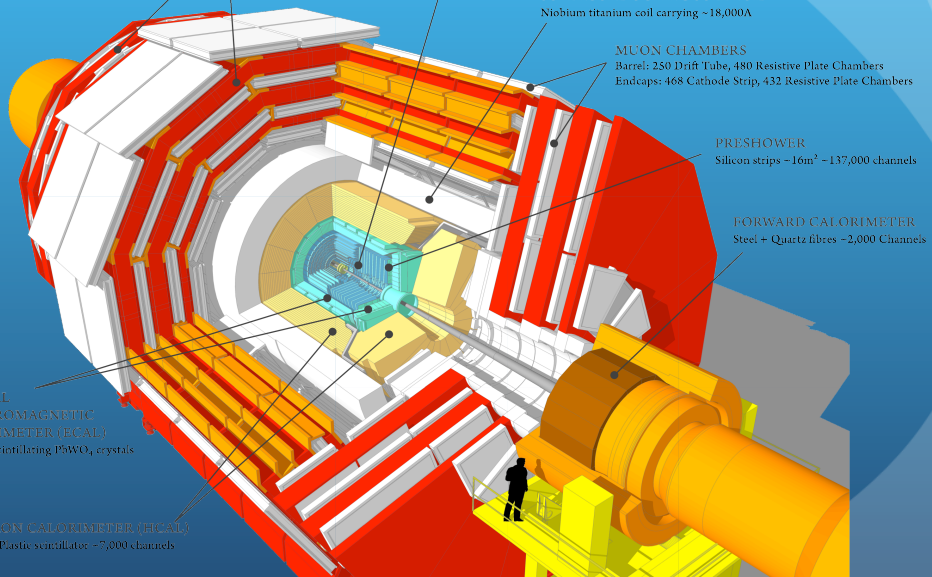

Detector characteristics	
Width:	44m
Diameter:	22m
Weight:	7000t

CERN AC - ATLAS V1997

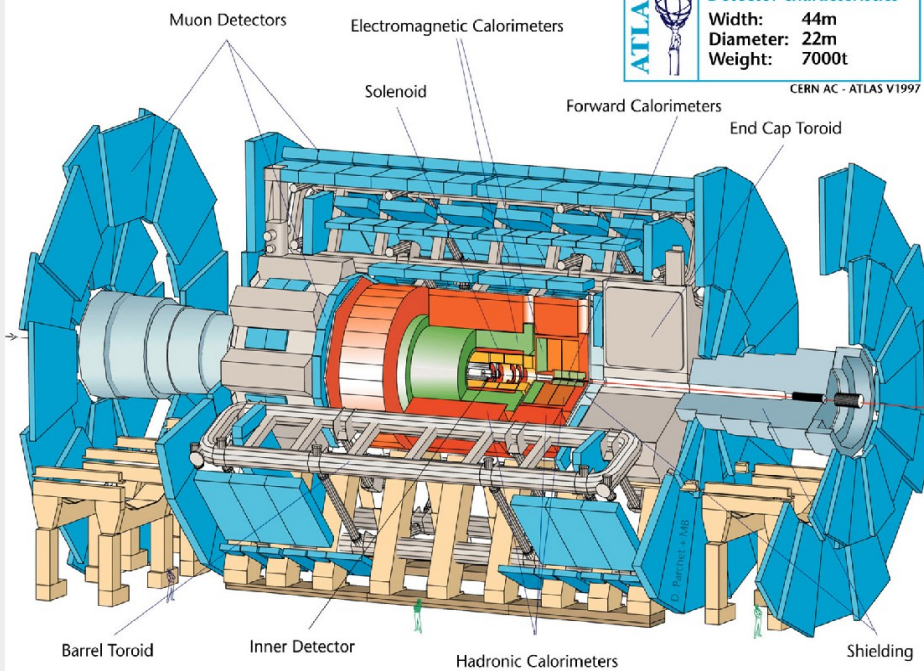

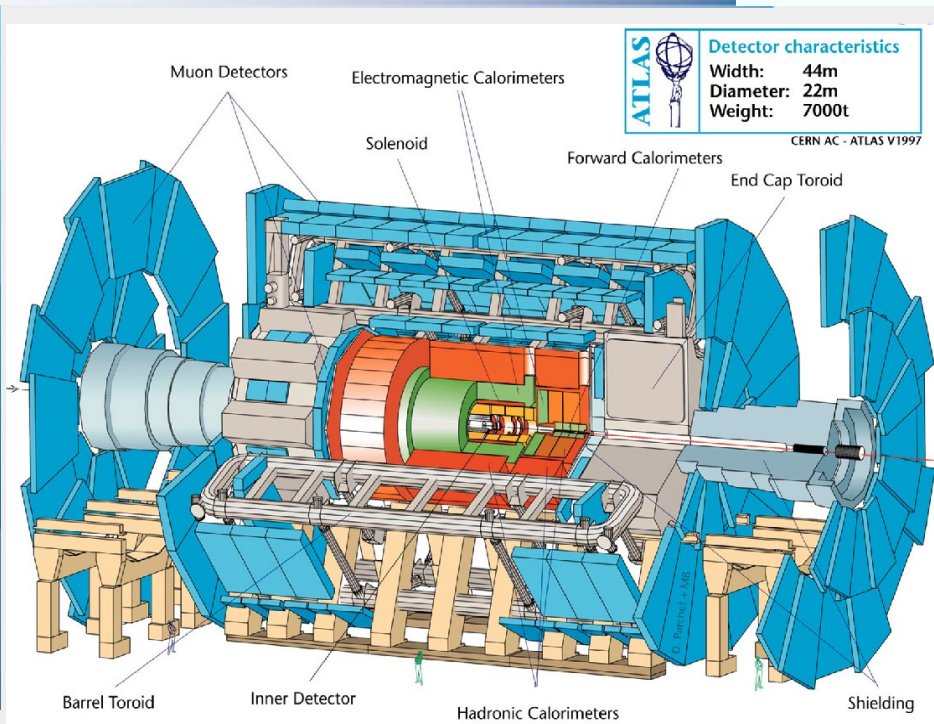
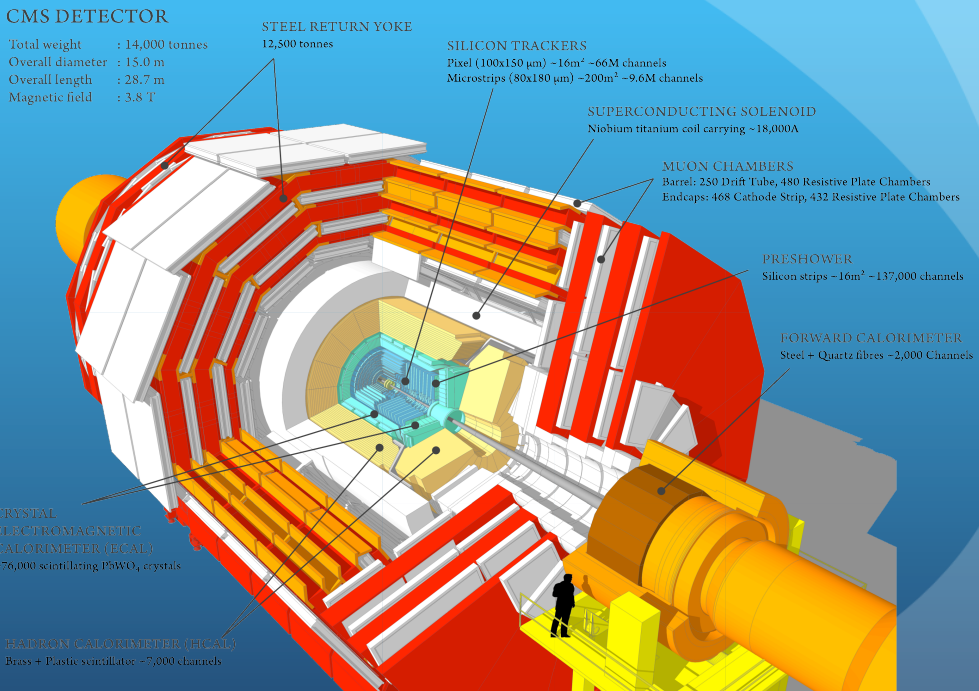

- *Large volume for precise charged tracks measurement*
- *Strong magnetic field*
- *Hermetic*
- *Best stand alone muon chambers system*
- *Highly segmented*
- *Radiation hard*

The LHC Spectrometers: Triumph of Instrumentation

**the largest and most complex “microscopes” we’ve
ever built**

The LHC Spectrometers: Triumph of Instrumentation

the largest and most complex “microscopes” we’ve ever built



The detectors together have 140 million data channels observing at 40 million times a second.

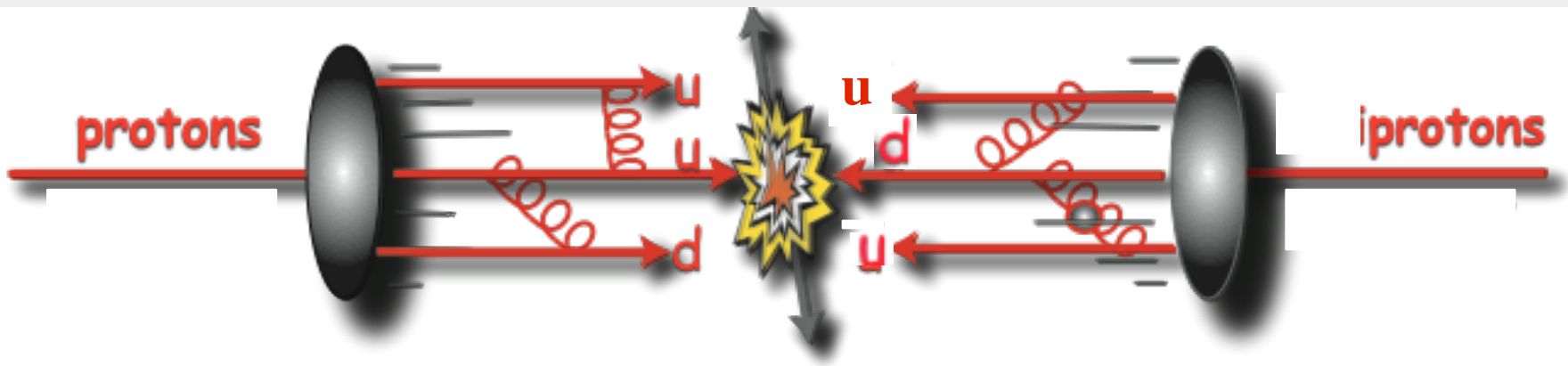

- **Protons are composite**
Partons (valence+sea quarks, gluons) carry **longitudinal momentum fraction of the proton** (x)
Longitudinal parton momenta are unknown
- **Parton distribution functions** (PDFs): estimate the momentum fraction carried by a parton inside the proton

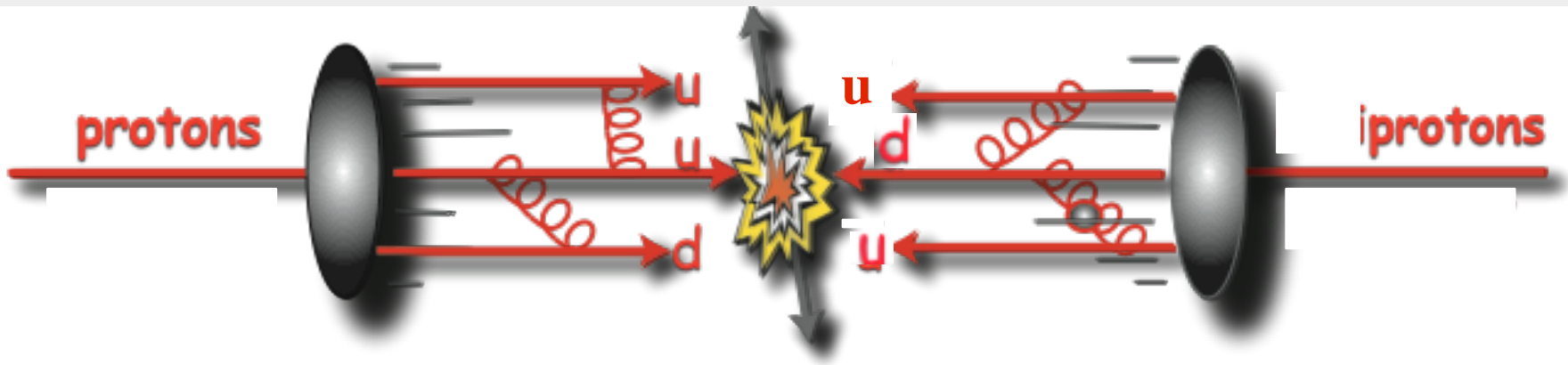

- *Protons are composite*
Partons (valence+sea quarks, gluons) carry **longitudinal momentum fraction of the proton** (x)
Longitudinal parton momenta are unknown
- **Parton distribution functions** (PDFs): estimate the momentum fraction carried by a parton inside the proton

What do we want to measure

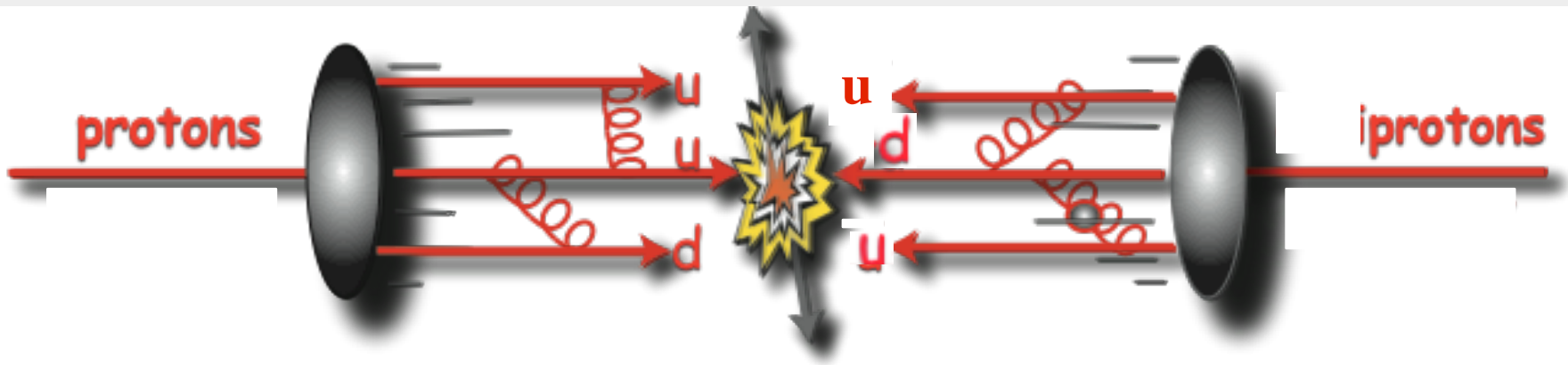

- *Protons are composite*
Partons (valence+sea quarks, gluons) carry **longitudinal momentum fraction of the proton** (x)
Longitudinal parton momenta are unknown
- **Parton distribution functions** (PDFs): estimate the momentum fraction carried by a parton inside the proton

What do we want to measure

- *Number of particles*
- *Event topology*
- *momentum / Energie*
- *Particle identity*
- *Transverse Missing energy/momentun*

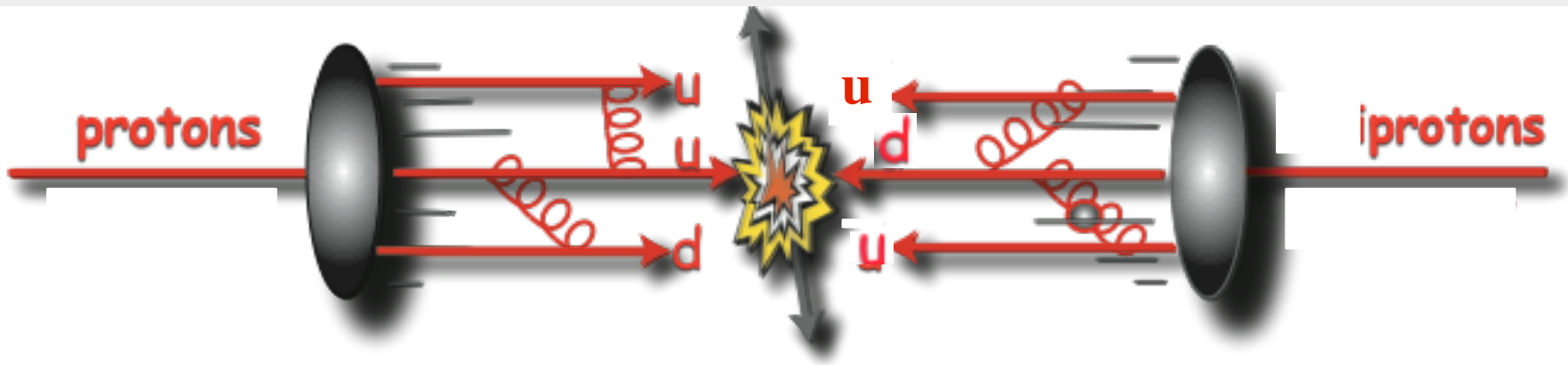

- *Protons are composite*
Partons (valence+sea quarks, gluons) carry **longitudinal momentum fraction of the proton** (x)
Longitudinal parton momenta are unknown
- **Parton distribution functions** (PDFs): estimate the momentum fraction carried by a parton inside the proton

What do we want to measure

- *Number of particles*
 - *Event topologie*
 - *momentum / Energie*
 - *Particle identity*
 - *Transverse Missing energy/momentun*
- ➔ Can't be achieved with a single detector

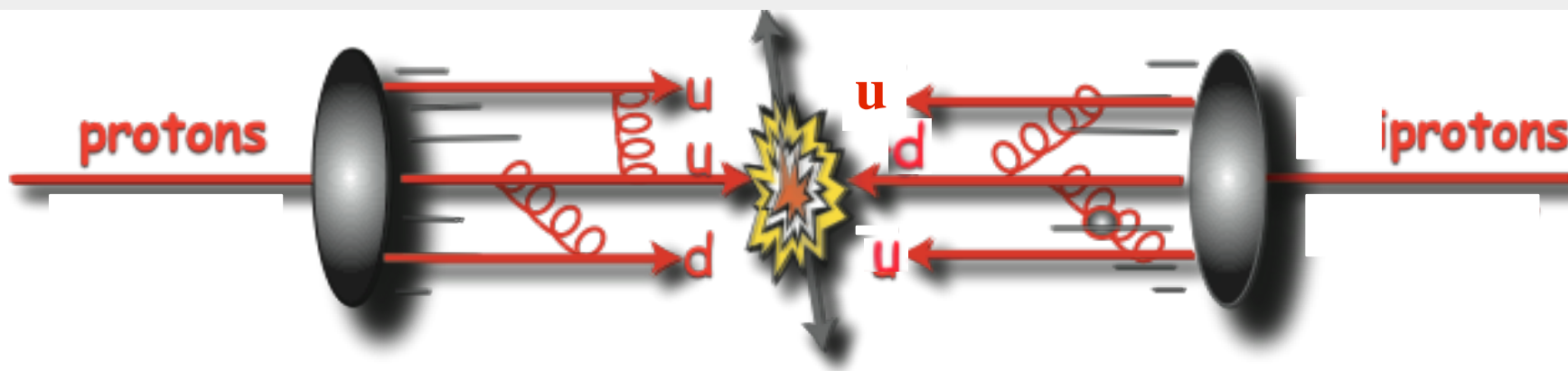

- *Protons are composite*
Partons (valence+sea quarks, gluons) carry **longitudinal momentum fraction of the proton** (x)
Longitudinal parton momenta are unknown
- **Parton distribution functions** (PDFs): estimate the momentum fraction carried by a parton inside the proton

What do we want to measure

- *Number of particles*
- *Event topologie*
- *momentum / Energie*
- *Particle identity*
- *Transverse Missing energy/momentun*



Can't be achieved
with a single detector



Integrate detectors
to a detector system



Particle detection

LM

Particles characteristics are measured through different type of detectors and identified thanks to specific behaviours due to their interaction with matter

Particles characteristics are measured through different type of detectors and identified thanks to specific behaviours due to their interaction with matter

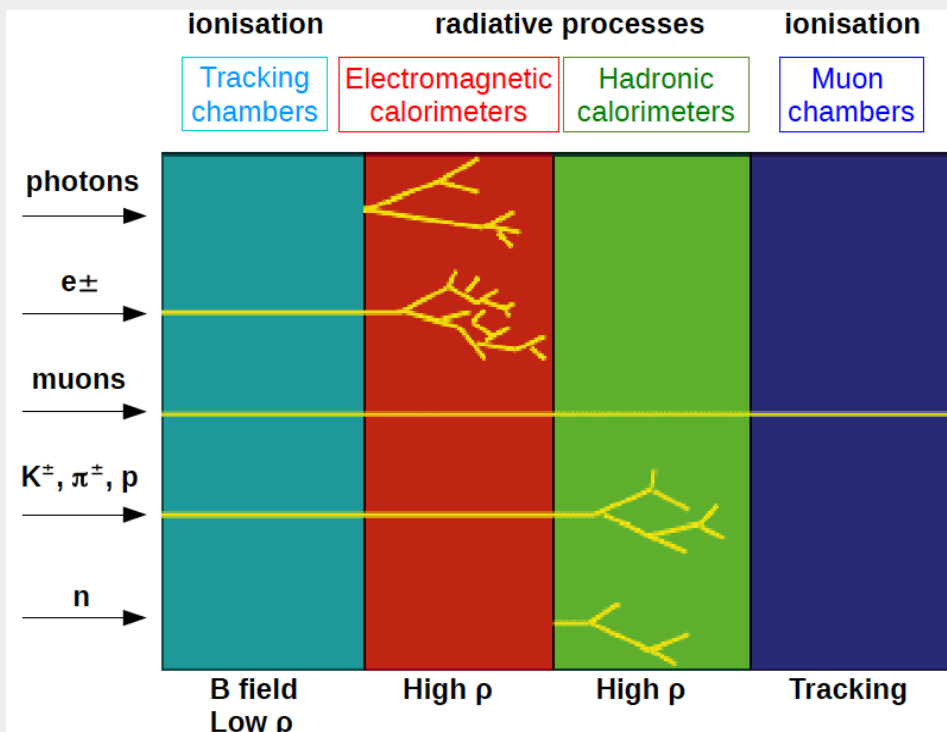

Particles characteristics are measured through different type of detectors and identified thanks to specific behaviours due to their interaction with matter

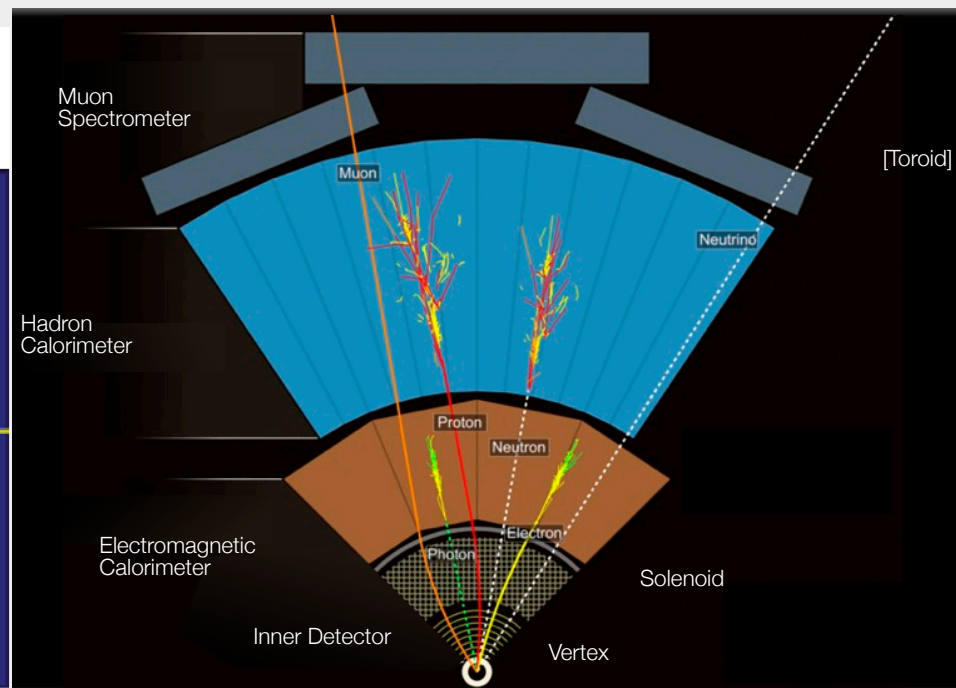
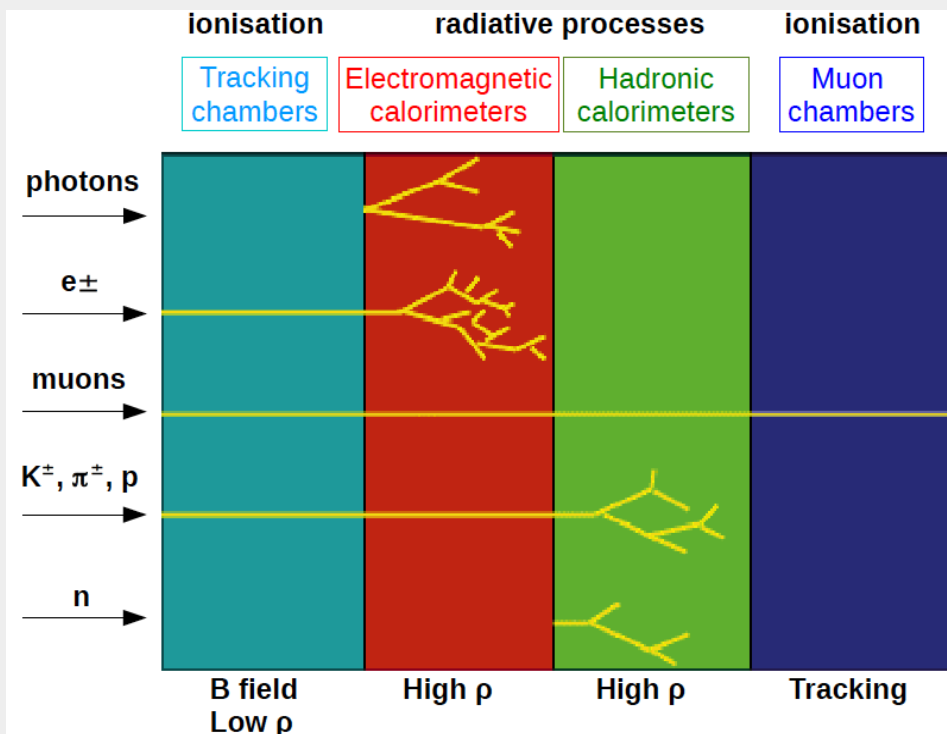

Particles characteristics are measured through different type of detectors and identified thanks to specific behaviours due to their interaction with matter

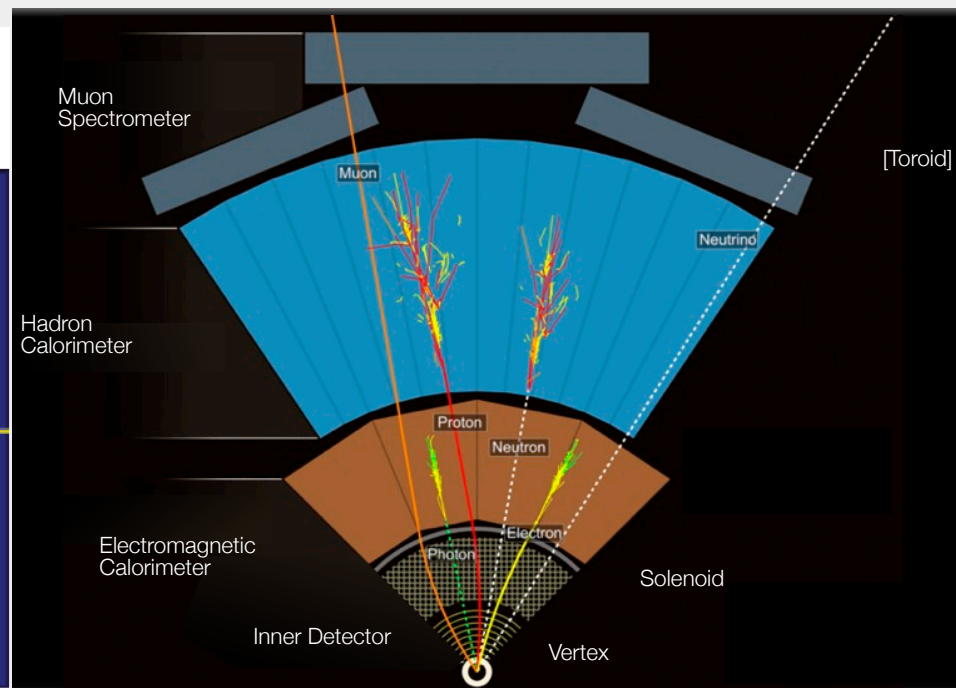
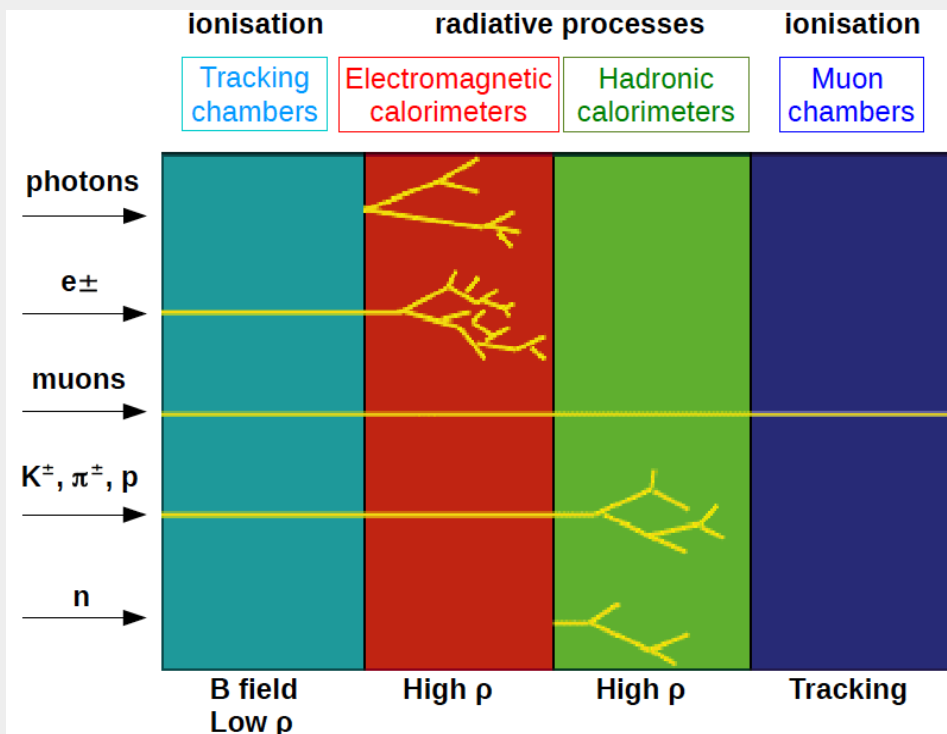

γ , e , jets (q, g), missing energy (e.g. ν), are detected with calorimeters



What can we access?

LMR

Measure stable and quasi-stable particles ($e, \gamma, \mu, \pi, K, p, n, \nu$):
Kinematics (momentum and/or energy)
The way particle interacts with / passes through detectors

All other particles reconstructed via their decays to (quasi-) stable particles :
Invariant mass of the system of daughter particles
+ Decay vertex separated from production vertex for some particles decaying
via weak interaction

Main goal of instrumentation for HEP :
Precisely/fast **measure kinematics** of (quasi-) stable particles
Unambiguously/fast **identify** them

For that :
We study **how particles interact with the matter**
and
We choose the **detector technologies** that match the physics tasks



What can we access?

LIR

Measure stable and quasi-stable particles ($e, \gamma, \mu, \pi, K, p, n, \nu$):
Kinematics (momentum and/or energy)
The way particle interacts with / passes through detectors

All other particles reconstructed via their decays to (quasi-) stable particles :
Invariant mass of the system of daughter particles
+ Decay vertex separated from production vertex for some particles decaying
via weak interaction

Main goal of instrumentation for HEP :
Precisely/fast **measure kinematics** of (quasi-) stable particles
Unambiguously/fast **identify** them

For that :
We study **how particles interact with the matter**
and
We choose the **detector technologies** that match the physics tasks



What can we access?

LIR

Measure stable and quasi-stable particles ($e, \gamma, \mu, \pi, K, p, n, \nu$):
Kinematics (momentum and/or energy)
The way particle interacts with / passes through detectors

All other particles reconstructed via their decays to (quasi-) stable particles :
Invariant mass of the system of daughter particles
+ Decay vertex separated from production vertex for some particles decaying via weak interaction

Main goal of instrumentation for HEP :
Precisely/fast **measure kinematics** of (quasi-) stable particles
Unambiguously/fast **identify** them

For that :
We study **how particles interact with the matter**
and
We choose the **detector technologies** that match the physics tasks



What can we access?

LUR

Measure stable and quasi-stable particles ($e, \gamma, \mu, \pi, K, p, n, \nu$):
Kinematics (momentum and/or energy)
The way particle interacts with / passes through detectors

All other particles reconstructed via their decays to (quasi-) stable particles :
Invariant mass of the system of daughter particles
+ Decay vertex separated from production vertex for some particles decaying
via weak interaction

Main goal of instrumentation for HEP :
Precisely/fast **measure kinematics** of (quasi-) stable particles
Unambiguously/fast **identify** them

For that :
We study **how particles interact with the matter**
and
We choose the **detector technologies** that match the physics tasks



What can we access?

LUR

Measure stable and quasi-stable particles ($e, \gamma, \mu, \pi, K, p, n, \nu$):
Kinematics (momentum and/or energy)
The way particle interacts with / passes through detectors

All other particles reconstructed via their decays to (quasi-) stable particles :
Invariant mass of the system of daughter particles
+ Decay vertex separated from production vertex for some particles decaying
via weak interaction

Main goal of instrumentation for HEP :
Precisely/fast **measure kinematics** of (quasi-) stable particles
Unambiguously/fast **identify** them

For that :
We study **how particles interact with the matter**
and
We choose the **detector technologies** that match the physics tasks



How perform the measurements (p, E)



- *Use of a magnetic field*

Obvious now but UA2 (SPS) and D0 (run I) had no magnetic field !!!

- ***Use of a magnetic field***
Obvious now but UA2 (SPS) and D0 (run I) had no magnetic field !!!
- ***Use of position detectors :***
 - ***gaseous*** : multi wires chambers, Time Projection chambers, drift tube
 - ***Solid*** : Silicium detectors
 - ***Try to do if possible a non destructive measurement***
==> minimize the amount of material in the detector itself
- ***Use calorimetry for the Energy measurement***



Detector requirements

LM

- A coverage of full solid angle (no cracks, fine segmentation...)

- A coverage of full solid angle (no cracks, fine segmentation...)
- *A measurement of momentum and/or energy*

- A coverage of full solid angle (no cracks, fine segmentation...)
- *A measurement of momentum and/or energy*
- Detect, track and identify the particles (mass, charge, decay length)

- A coverage of full solid angle (no cracks, fine segmentation...)
- *A measurement of momentum and/or energy*
- Detect, track and identify the particles (mass, charge, decay length)
- *Fast, no dead time and no dead regions*

- A coverage of full solid angle (no cracks, fine segmentation...)
- *A measurement of momentum and/or energy*
- Detect, track and identify the particles (mass, charge, decay length)
- *Fast, no dead time and no dead regions*
- *Such an ideal detector does not exist !* Conception of a detector is a compromise between

- A coverage of full solid angle (no cracks, fine segmentation...)
- *A measurement of momentum and/or energy*
- Detect, track and identify the particles (mass, charge, decay length)
- *Fast, no dead time and no dead regions*
- *Such an ideal detector does not exist !* Conception of a detector is a compromise between
 - *Detectors technologies (advantage/disadvantage)*

- A coverage of full solid angle (no cracks, fine segmentation...)
- *A measurement of momentum and/or energy*
- Detect, track and identify the particles (mass, charge, decay length)
- *Fast, no dead time and no dead regions*
- ***Such an ideal detector does not exist !*** Conception of a detector is a compromise between
 - *Detectors technologies (advantage/disadvantage)*
 - *Space allocated*

- A coverage of full solid angle (no cracks, fine segmentation...)
- *A measurement of momentum and/or energy*
- Detect, track and identify the particles (mass, charge, decay length)
- *Fast, no dead time and no dead regions*
- ***Such an ideal detector does not exist !*** Conception of a detector is a compromise between
 - *Detectors technologies (advantage/disadvantage)*
 - *Space allocated*
 - *Cost*

- A coverage of full solid angle (no cracks, fine segmentation...)
- *A measurement of momentum and/or energy*
- Detect, track and identify the particles (mass, charge, decay length)
- *Fast, no dead time and no dead regions*
- ***Such an ideal detector does not exist !*** Conception of a detector is a compromise between
 - *Detectors technologies (advantage/disadvantage)*
 - *Space allocated*
 - *Cost*
- ***An optimized detector*** should provide all characteristics of the end products of a collision. Therefore it needs :

- A coverage of full solid angle (no cracks, fine segmentation...)
- *A measurement of momentum and/or energy*
- Detect, track and identify the particles (mass, charge, decay length)
- *Fast, no dead time and no dead regions*
- ***Such an ideal detector does not exist !*** Conception of a detector is a compromise between
 - *Detectors technologies (advantage/disadvantage)*
 - *Space allocated*
 - *Cost*
- ***An optimized detector*** should provide all characteristics of the end products of a collision. Therefore it needs :
 - *Monte Carlo simulation (Geant4) and*

- A coverage of full solid angle (no cracks, fine segmentation...)
- *A measurement of momentum and/or energy*
- Detect, track and identify the particles (mass, charge, decay length)
- *Fast, no dead time and no dead regions*
- ***Such an ideal detector does not exist !*** Conception of a detector is a compromise between
 - *Detectors technologies (advantage/disadvantage)*
 - *Space allocated*
 - *Cost*
- ***An optimized detector*** should provide all characteristics of the end products of a collision. Therefore it needs :
 - *Monte Carlo simulation (Geant4) and*
 - *test of prototypes in beam lines are keys elements of the*
conception of a detector



Particle identification (1)

LM

(for details clic

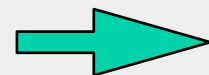



Particle identification (1)

LM

- What other information do we need?

(for details clic

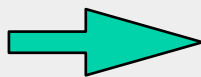

- What other information do we need?
- Since the interactions of charged hadrons are similar, the most direct way to distinguish them is to determine their *(rest) mass*

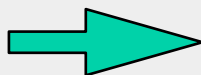

- What other information do we need?
- Since the interactions of charged hadrons are similar, the most direct way to distinguish them is to determine their *(rest) mass*
- Their momentum is measured by the tracking system, so this is equivalent to determining their velocity, since $p = \gamma m v$, so $m = p/\gamma v = p/\gamma\beta c$

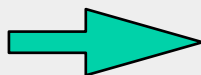

- What other information do we need?
- Since the interactions of charged hadrons are similar, the most direct way to distinguish them is to determine their *(rest) mass*
- Their momentum is measured by the tracking system, so this is equivalent to determining their velocity, since $p = \gamma m v$, so $m = p/\gamma v = p/\gamma\beta c$
- There are four main processes that depend on the velocity of a particle :
 1. Most direct is to measure the *Time Of Flight (TOF)* of the particles over a fixed distance
 2. Alternatively one can look at the detail of their interaction with matter
The main source of energy loss is via Ionization (dE/dx)
 3. If the velocity of the particle changes compared to the local speed of light it will radiate photons, detected as *Transition radiation*
 4. If a particle travels at greater than the local speed of light, it will radiate *Cherenkov radiation*

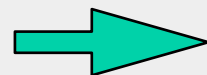

- ***For low-momentum***— typically up to a few GeV
 - charged particles can be identified by processes that depend on their velocity (β).
 - A simultaneous measurement of $p = \beta\gamma m$ and β allows extracting the mass.

- ***For low-momentum***— typically up to a few GeV
 - charged particles can be identified by processes that depend on their velocity (β).
 - A simultaneous measurement of $p = \beta\gamma m$ and β allows extracting the mass.
- ***For momenta above a few GeV,***
 - pions, kaons, and protons cannot be separated.
 - However electrons, muons, hadrons, and neutrinos interact differently with the matter. ***The measurement of their energies and/or momenta depend from their different modes of interaction.***



- ***For low-momentum***— typically up to a few GeV
 - charged particles can be identified by processes that depend on their velocity (β).
 - A simultaneous measurement of $p = \beta\gamma m$ and β allows extracting the mass.
- ***For momenta above a few GeV***,
 - pions, kaons, and protons cannot be separated.
 - However electrons, muons, hadrons, and neutrinos interact differently with the matter. ***The measurement of their energies and/or momenta depend from their different modes of interaction.***

Interaction with matter :

-  *Interaction of photons : (for details clic*
-  *Nuclear Interactions : (for details clic*

- ***For low-momentum***— typically up to a few GeV
 - charged particles can be identified by processes that depend on their velocity (β).
 - A simultaneous measurement of $p = \beta\gamma m$ and β allows extracting the mass.
- ***For momenta above a few GeV***,
 - pions, kaons, and protons cannot be separated.
 - However electrons, muons, hadrons, and neutrinos interact differently with the matter. ***The measurement of their energies and/or momenta depend from their different modes of interaction.***

Interaction with matter :

-  ***Interaction of photons :*** (for details clic 
-  ***Nuclear Interactions :*** (for details clic

- ***For low-momentum***— typically up to a few GeV
 - charged particles can be identified by processes that depend on their velocity (β).
 - A simultaneous measurement of $p = \beta\gamma m$ and β allows extracting the mass.
- ***For momenta above a few GeV***,
 - pions, kaons, and protons cannot be separated.
 - However electrons, muons, hadrons, and neutrinos interact differently with the matter. ***The measurement of their energies and/or momenta depend from their different modes of interaction.***

Interaction with matter :

•  ***Interaction of photons :*** (for details clic 

•  ***Nuclear Interactions :*** (for details clic 

Objects for Top Quark identification

- Mainly produced in pairs via strong interactions: $t\bar{t}$

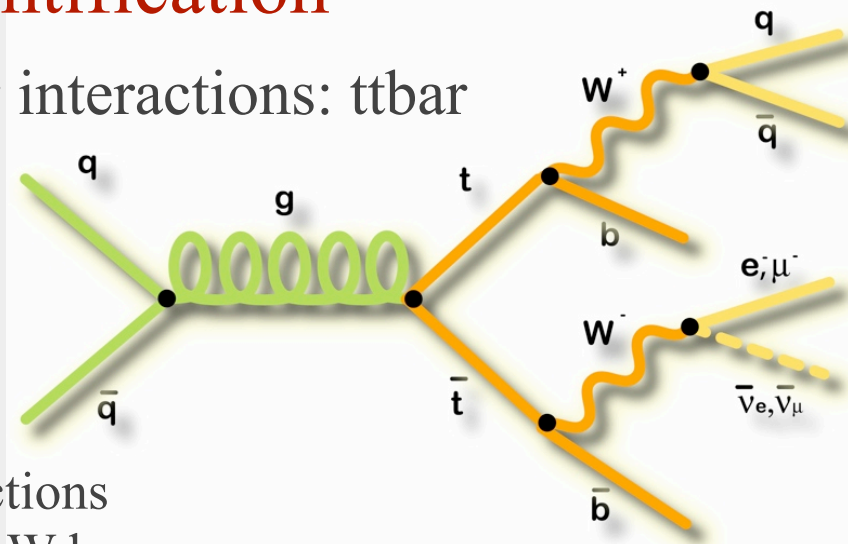
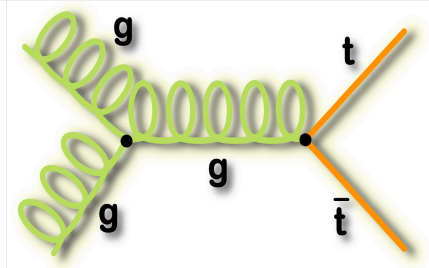
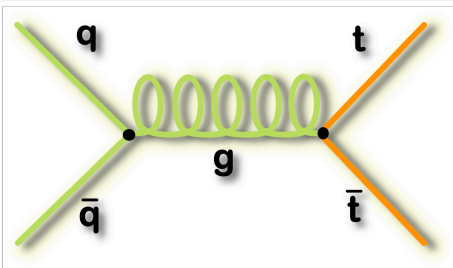

- Top quark decays via the electroweak interactions
- Final state characterized by the decay of the W boson
- **Dilepton** (lepton = e or μ) (7%): 2 leptons, **2 b quarks**, 2 neutrinos
- **Lepton+Jets** (lepton = e or μ) (34%): **2 b quarks**, 2 light quarks, 1 lepton, 1 neutrino
- **All-Jets** (44%): **2 b quarks**, 4 light quarks

Objects for Top Quark identification

- Mainly produced in pairs via strong interactions: $t\bar{t}$

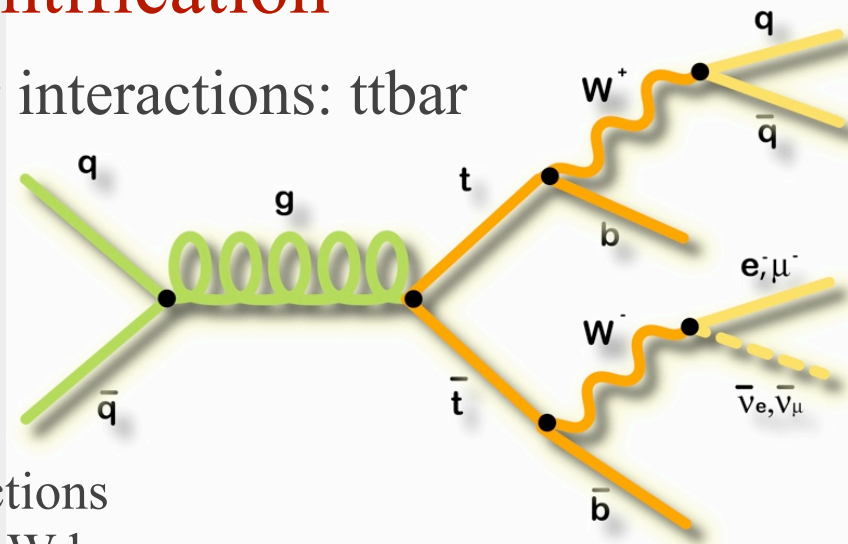
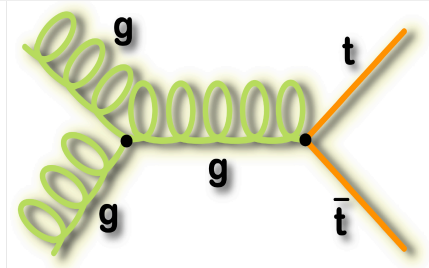
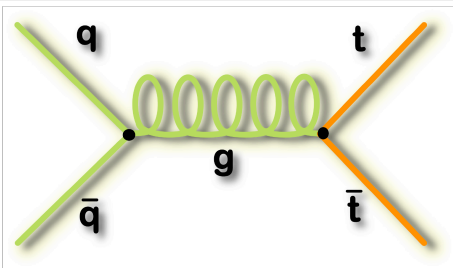

- Top quark decays via the electroweak interactions
- Final state characterized by the decay of the W boson
- **Dilepton** (lepton = e or μ) (7%): 2 leptons, **2 b quarks**, 2 neutrinos
- **Lepton+Jets** (lepton = e or μ) (34%): **2 b quarks**, 2 light quarks, 1 lepton, 1 neutrino
- **All-Jets** (44%): **2 b quarks**, 4 light quarks

Needed Objects

- *electrons*
- *muons*
- *b quarks*
- *Jets*
- *ETmiss*

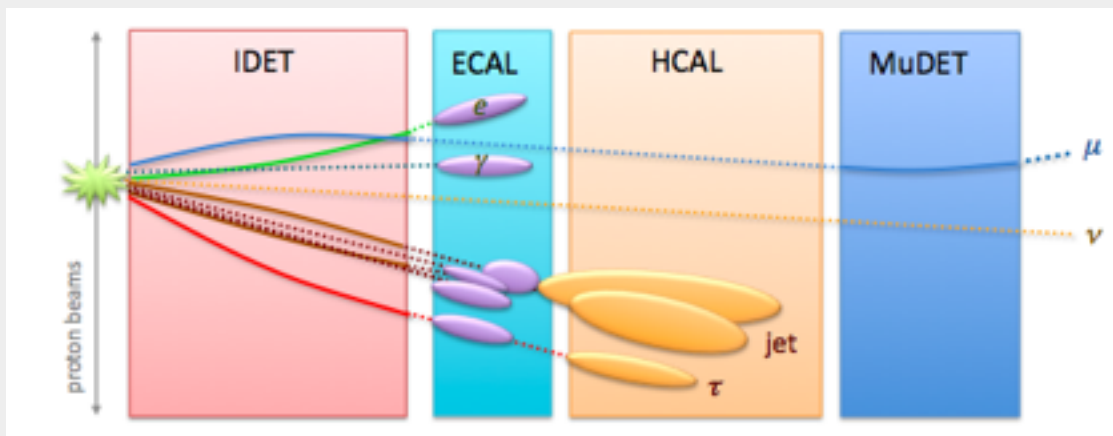

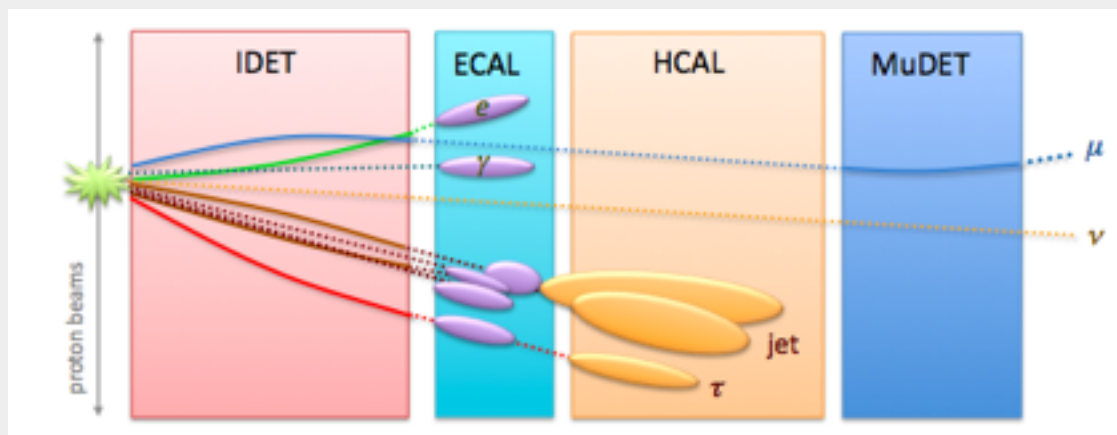

- Object reconstruction

- Tracking

- finding path of charged particles through the detector

- Calorimeter reconstruction

- finding energy deposits in calorimeters from charged and neutral particles

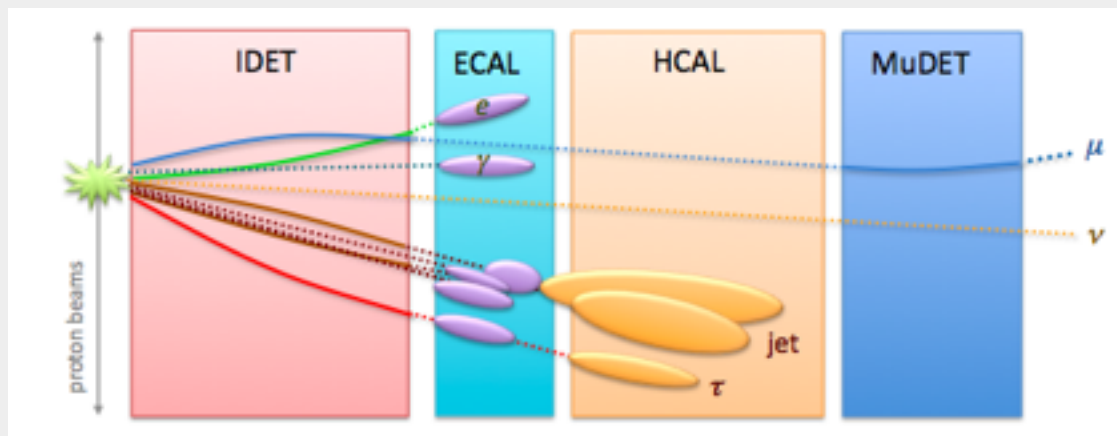

- Object reconstruction
 - Tracking
 - finding path of charged particles through the detector
 - Calorimeter reconstruction
 - finding energy deposits in calorimeters from charged and neutral particles
- Combined reconstruction : tracker + calorimeter informations
 - Electron/Photon identification
 - Muon identification
 - Jet finding

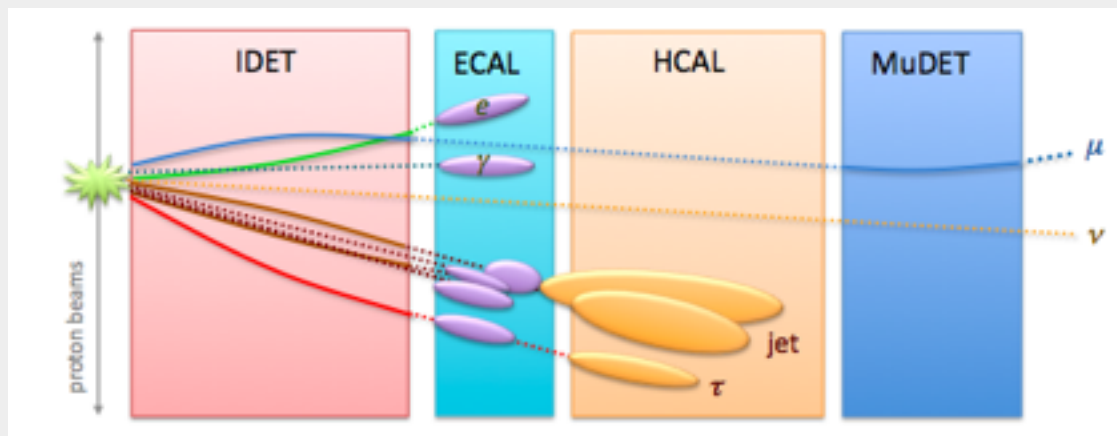

- Object reconstruction
 - Tracking
 - finding path of charged particles through the detector
 - Calorimeter reconstruction
 - finding energy deposits in calorimeters from charged and neutral particles
- Combined reconstruction : tracker + calorimeter informations
 - Electron/Photon identification
 - Muon identification
 - Jet finding
- Calibrations and alignments applied at nearly every step (see lectures 2 and 3)



Vertex detectors : b quarks ID *LM*

Requirements based on b-jets parameters

- B hadrons lifetime : average of ~ 1.6 ps
- semi-leptonic fraction $\sim 10\%$ for e, and 10% for μ
- $c\tau = 470$ microns \rightarrow impact parameter $d \sim 100$ microns
- need accuracy : < 20 microns on d

Requirements based on b -jets parameters

- B hadrons lifetime : average of ~ 1.6 ps
- semi-leptonic fraction $\sim 10\%$ for e , and 10% for μ
- $c\tau = 470$ microns \rightarrow impact parameter $d \sim 100$ microns
- need accuracy : < 20 microns on d

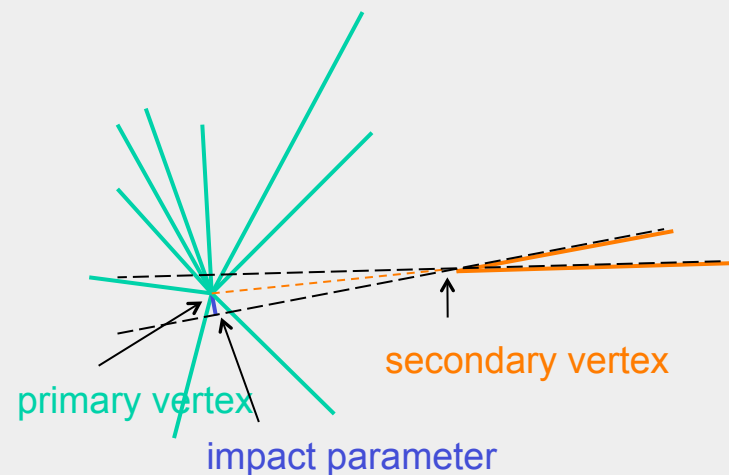

Requirements based on b-jets parameters

- B hadrons lifetime : average of ~ 1.6 ps
- semi-leptonic fraction $\sim 10\%$ for e, and 10% for μ
- $c\tau = 470$ microns \rightarrow impact parameter $d \sim 100$ microns
- need accuracy : < 20 microns on d

Accuracy limited by

- lever arm,
- granularity,
- number of layers

Solution:

- 3 layer pixel detector
- first layer as close as possible to beam pipe
- single hit accuracy < 15 microns in $r\phi$
- equipped with fast electronics

- Beware**
- of radiation damage
 - multiple scattering in material
 - power dissipation

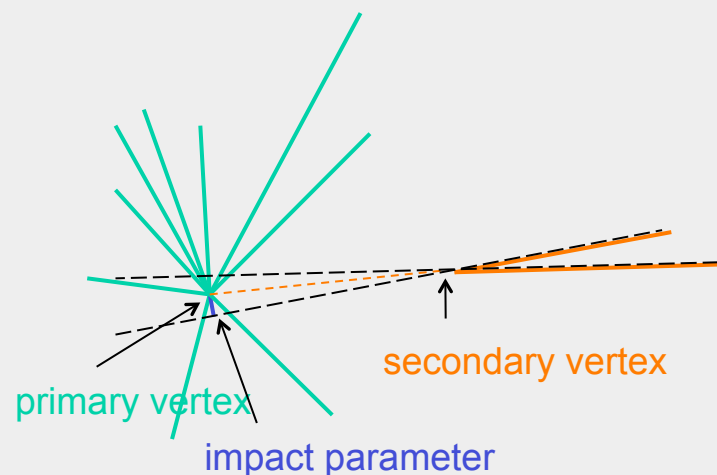



Objects: Electrons ID

LM

- **Signature**

- Energy deposited in EM Calorimeter
- Track pointing at the energy deposition and with momentum consistent with calorimeter energy
- Little or no energy in hadronic calorimeter

- **Signature**

- Energy deposited in EM Calorimeter
- Track pointing at the energy deposition and with momentum consistent with calorimeter energy
- Little or no energy in hadronic calorimeter

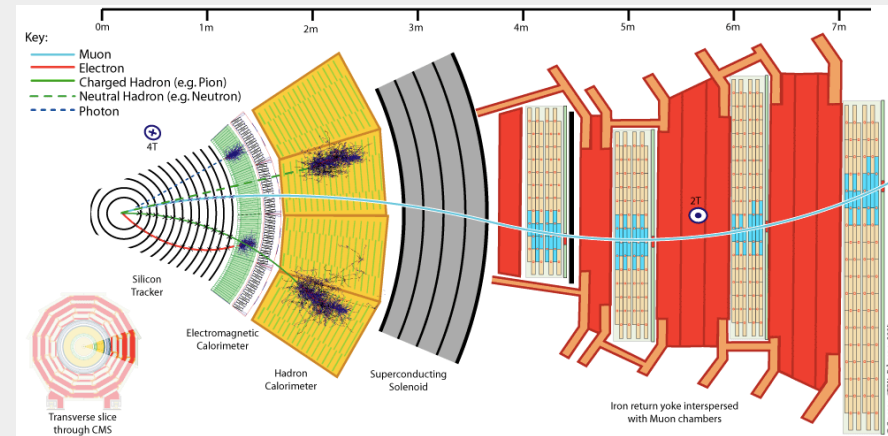

- **Signature**

- Energy deposited in EM Calorimeter
- Track pointing at the energy deposition and with momentum consistent with calorimeter energy
- Little or no energy in hadronic calorimeter

- **Backgrounds**

- Jets
- Early showering charged pions
- Conversions: $\pi^0 \rightarrow \gamma\gamma \rightarrow ee + X$
- Semileptonic b-decays
- Photon conversions
- **Photons similar to electrons**

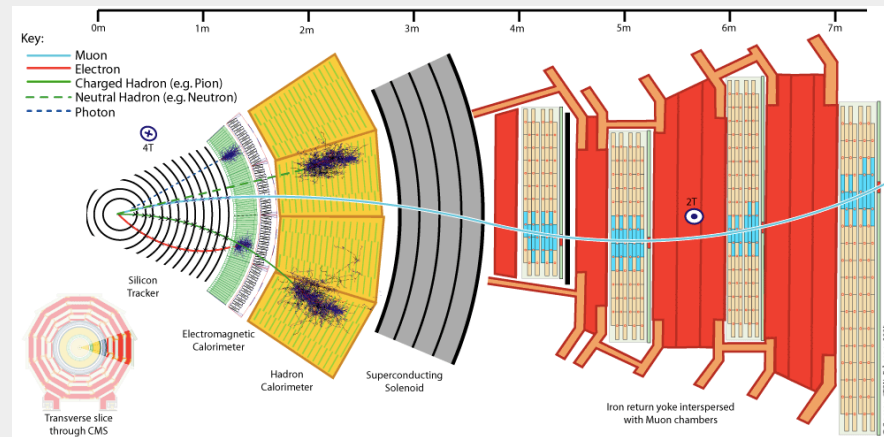



Objects: Muons ID

LIR

- **Signature**

- Track passes through all the detectors and is reconstructed in muon spectrometer
- Minimum ionizing energy deposits in EM and HAD calorimeter
- Track match between inner tracker and muon spectrometer

- **Signature**

- Track passes through all the detectors and is reconstructed in muon spectrometer
- Minimum ionizing energy deposits in EM ad HAD calorimeter
- Track match between inner tracker and muon spectrometer

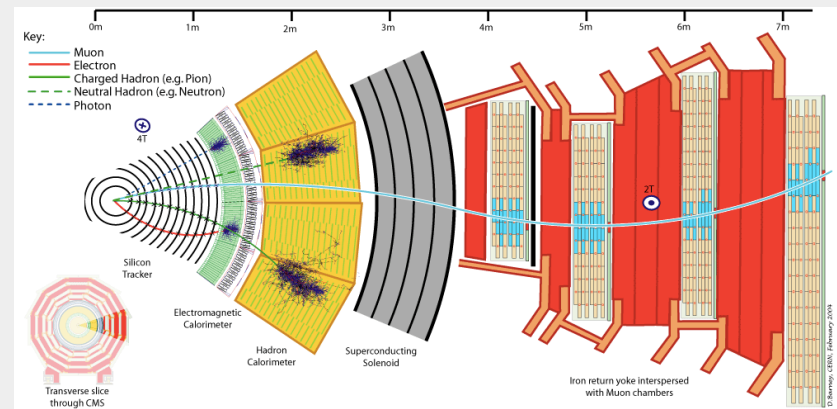

- **Signature**

- Track passes through all the detectors and is reconstructed in muon spectrometer
- Minimum ionizing energy deposits in EM and HAD calorimeter
- Track match between inner tracker and muon spectrometer

- **Backgrounds**

- Decays in flight: π and K decays inside jets
- Punchthrough
- Cavern background (LHC)

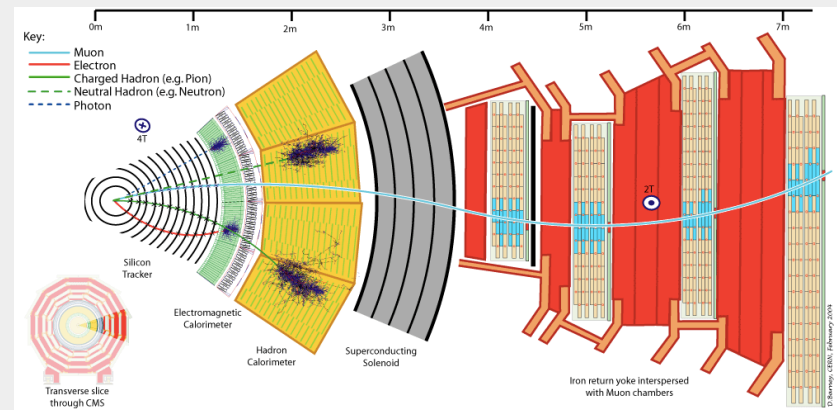

- **Signature**

- Track passes through all the detectors and is reconstructed in muon spectrometer
- Minimum ionizing energy deposits in EM ad HAD calorimeter
- Track match between inner tracker and muon spectrometer

- **Backgrounds**

- Decays in flight: π and K decays inside jets
- Punchthrough
- Cavern background (LHC)

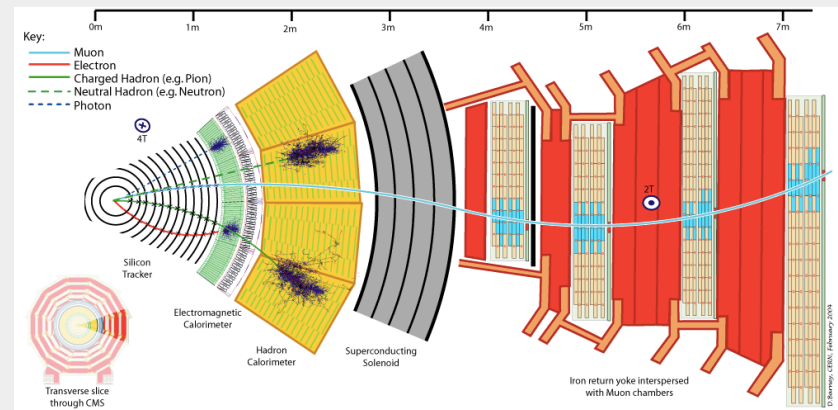

- **Identifying muons**

- Matching of track parameters between inner detector and muon system powerful at high p_T
- Verification of minimum ionizing energy in calorimeter

- **Signature**

- Track passes through all the detectors and is reconstructed in muon spectrometer
- Minimum ionizing energy deposits in EM ad HAD calorimeter
- Track match between inner tracker and muon spectrometer

- **Backgrounds**

- Decays in flight: π and K decays inside jets
- Punchthrough
- Cavern background (LHC)

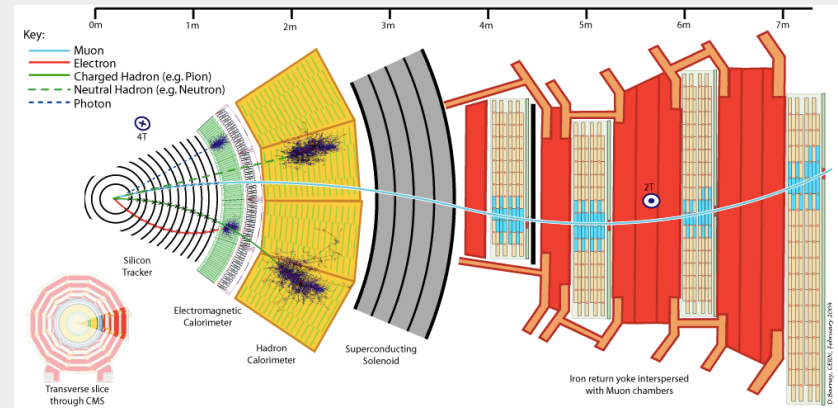

- **Identifying muons**

- Matching of track parameters between inner detector and muon system powerful at high p_T
- Verification of minimum ionizing energy in calorimeter

- **Performance**

- Measured using Z 's
- 60-100% depending on $|\eta|$

- Measurement of the kinematics of a hard parton emission requires

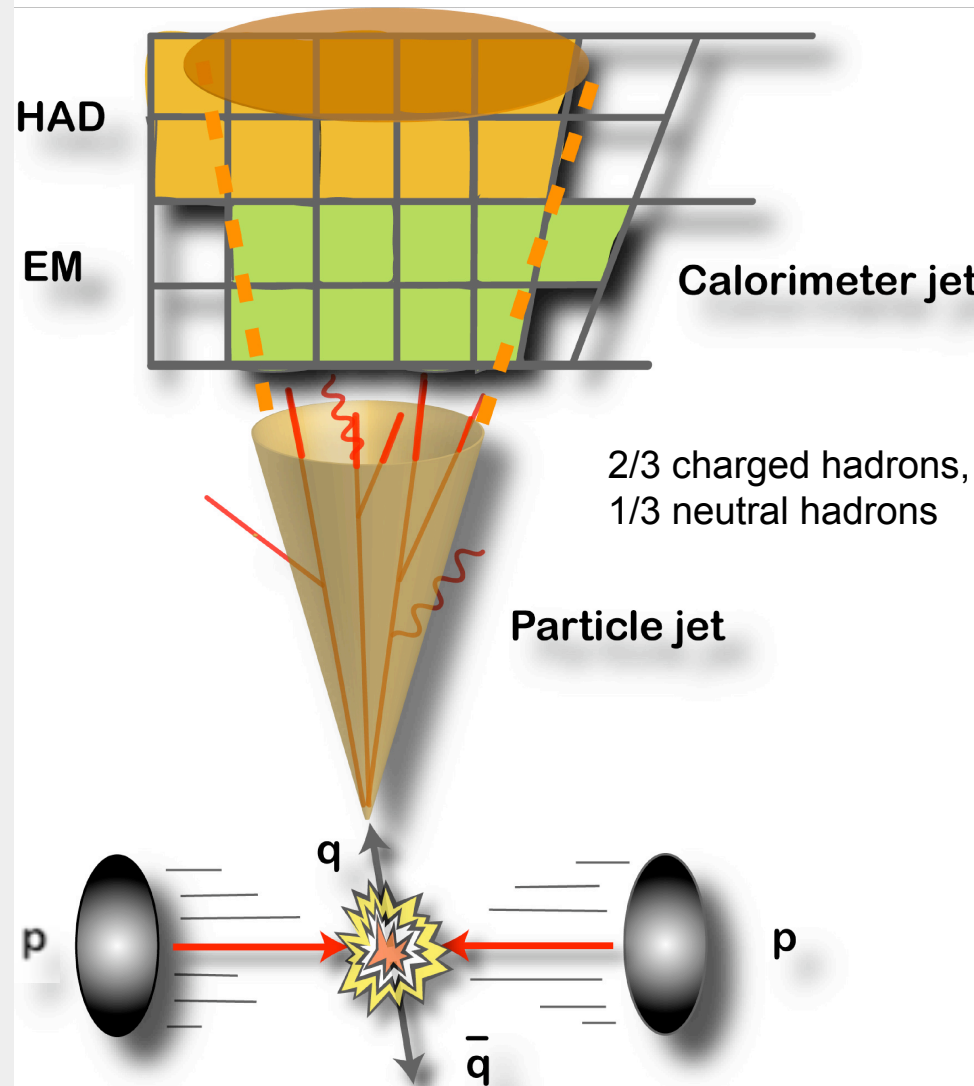

- Measurement of the kinematics of a hard parton emission requires

- Reconstruction:

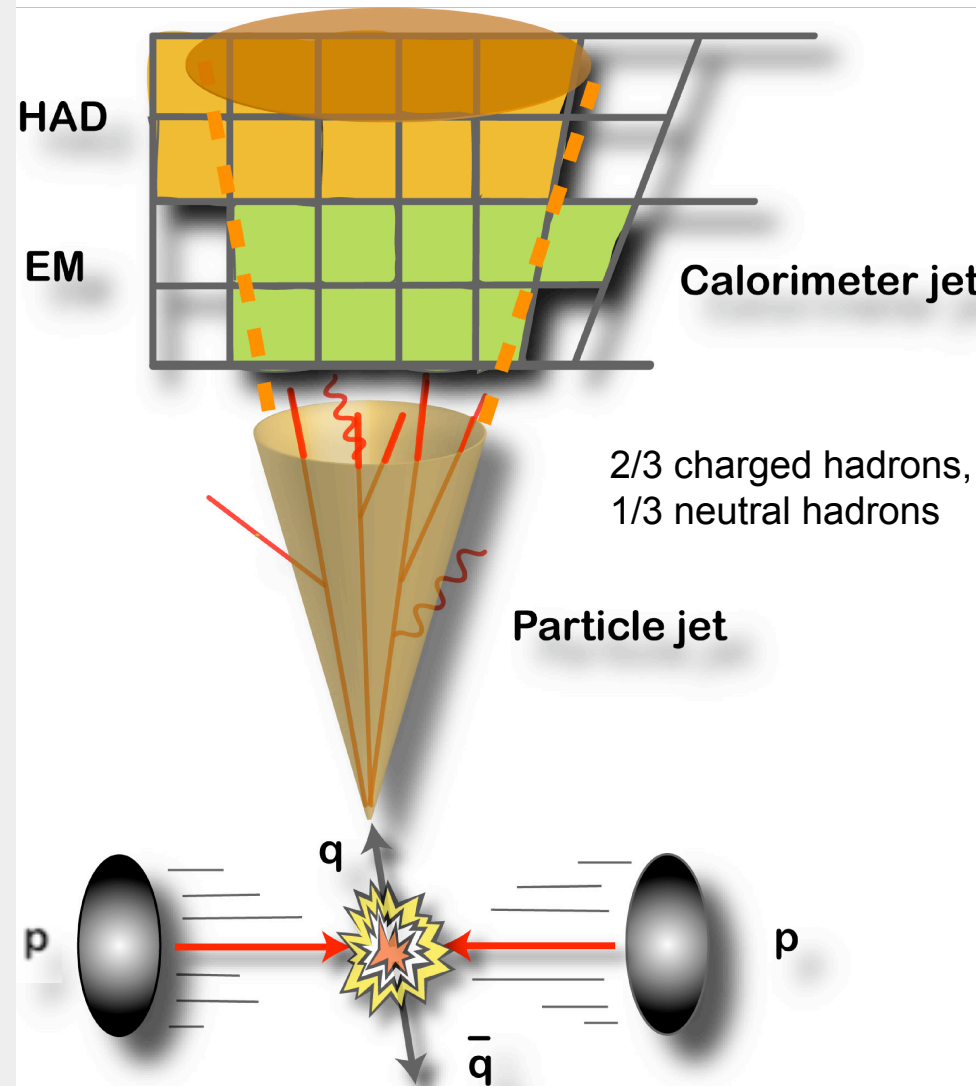

- Measurement of the kinematics of a hard parton emission requires

- Reconstruction:**

One needs : best matching to hard parton and jet identification. Many algorithms available: Cone, midpoint, KT

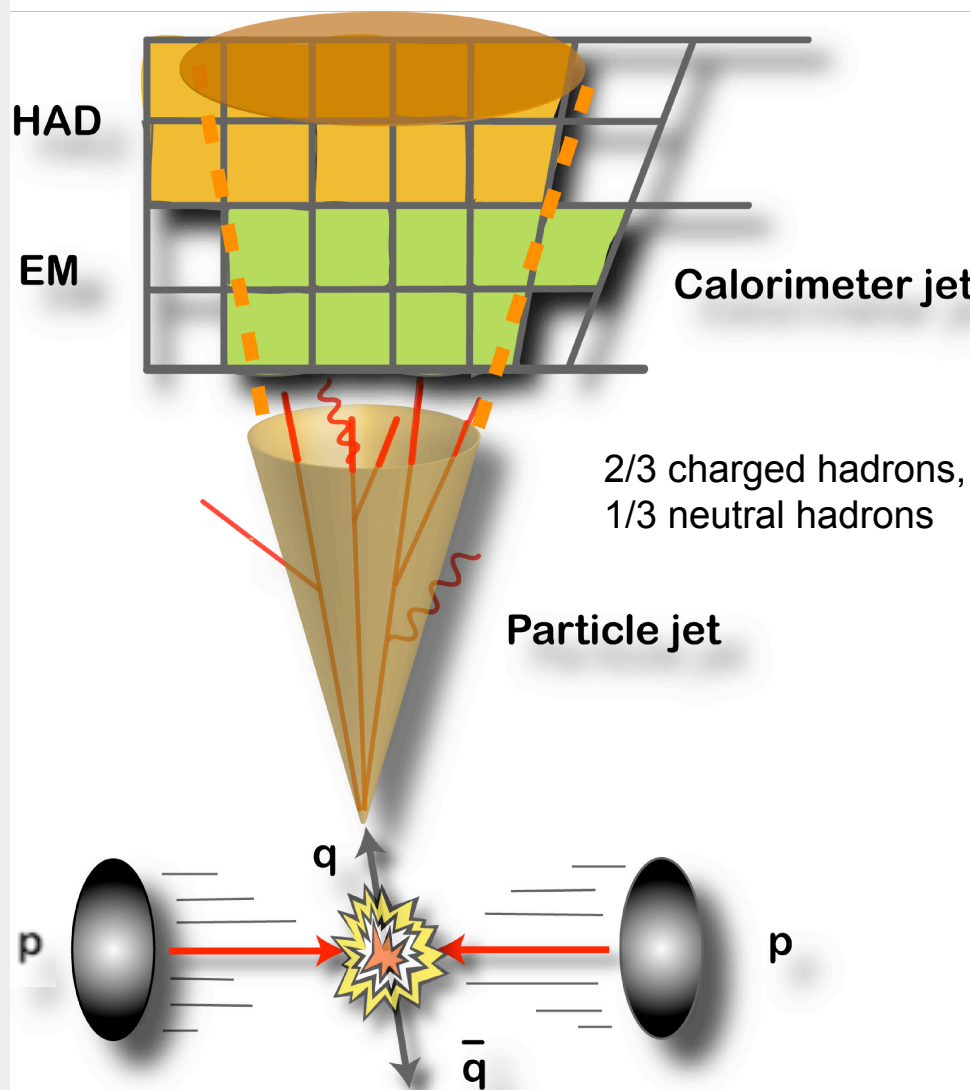

- Measurement of the kinematics of a hard parton emission requires

- Reconstruction:**

One needs : best matching to hard parton and jet identification. Many algorithms available: Cone, midpoint, KT

- Scale:**

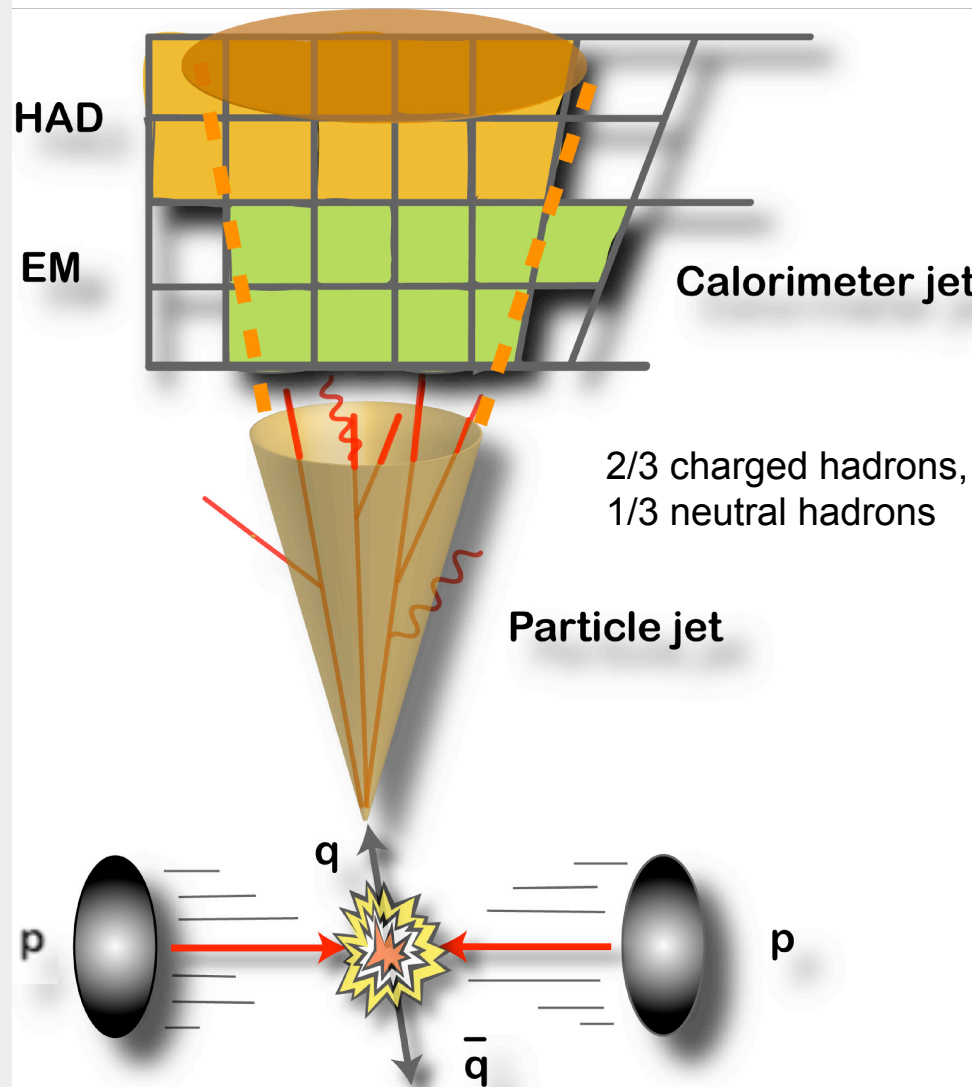

- Measurement of the kinematics of a hard parton emission requires

- Reconstruction:**

One needs : best matching to hard parton and jet identification. Many algorithms available: Cone, midpoint, KT

- Scale:**

calibration of the energy response, minimizing the measurement error

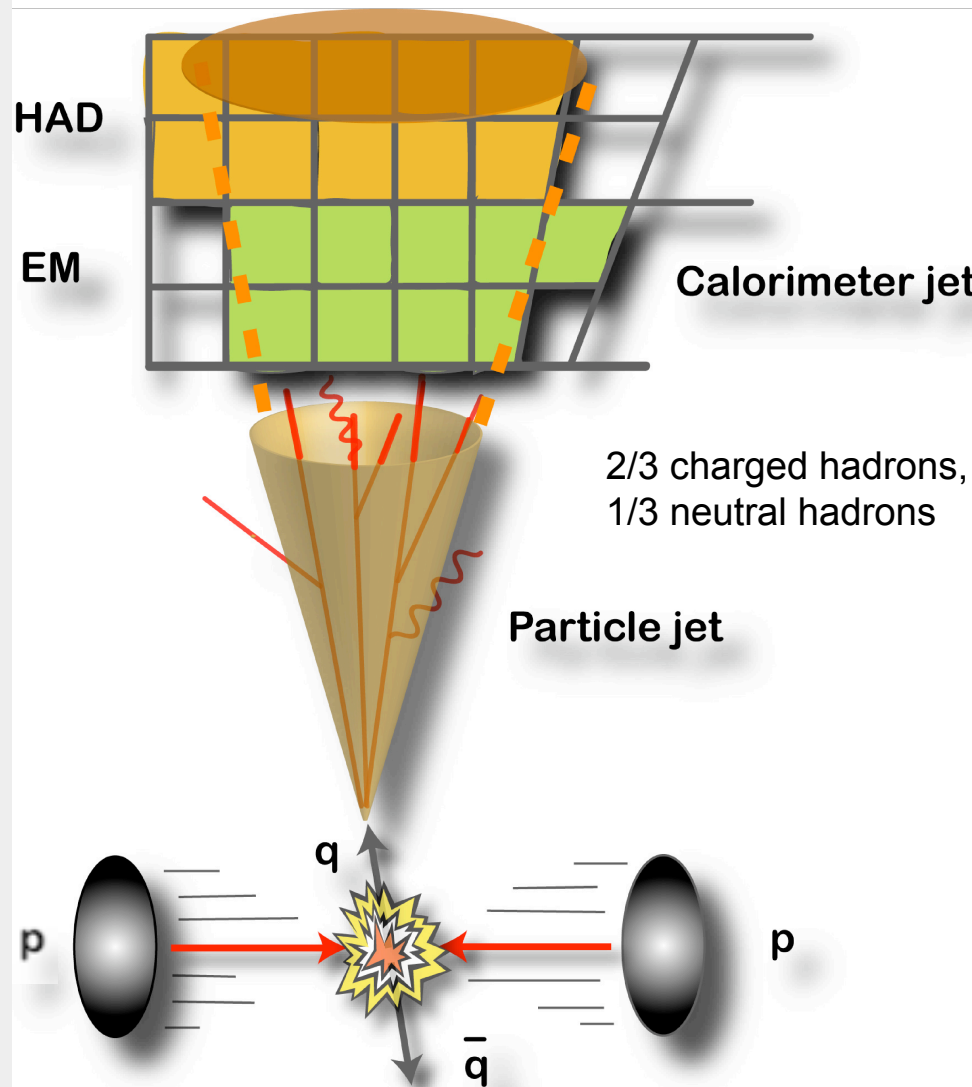

- Measurement of the kinematics of a hard parton emission requires

- Reconstruction:**

One needs : best matching to hard parton and jet identification. Many algorithms available: Cone, midpoint, KT

- Scale:**

calibration of the energy response, minimizing the measurement error

- Resolution:**

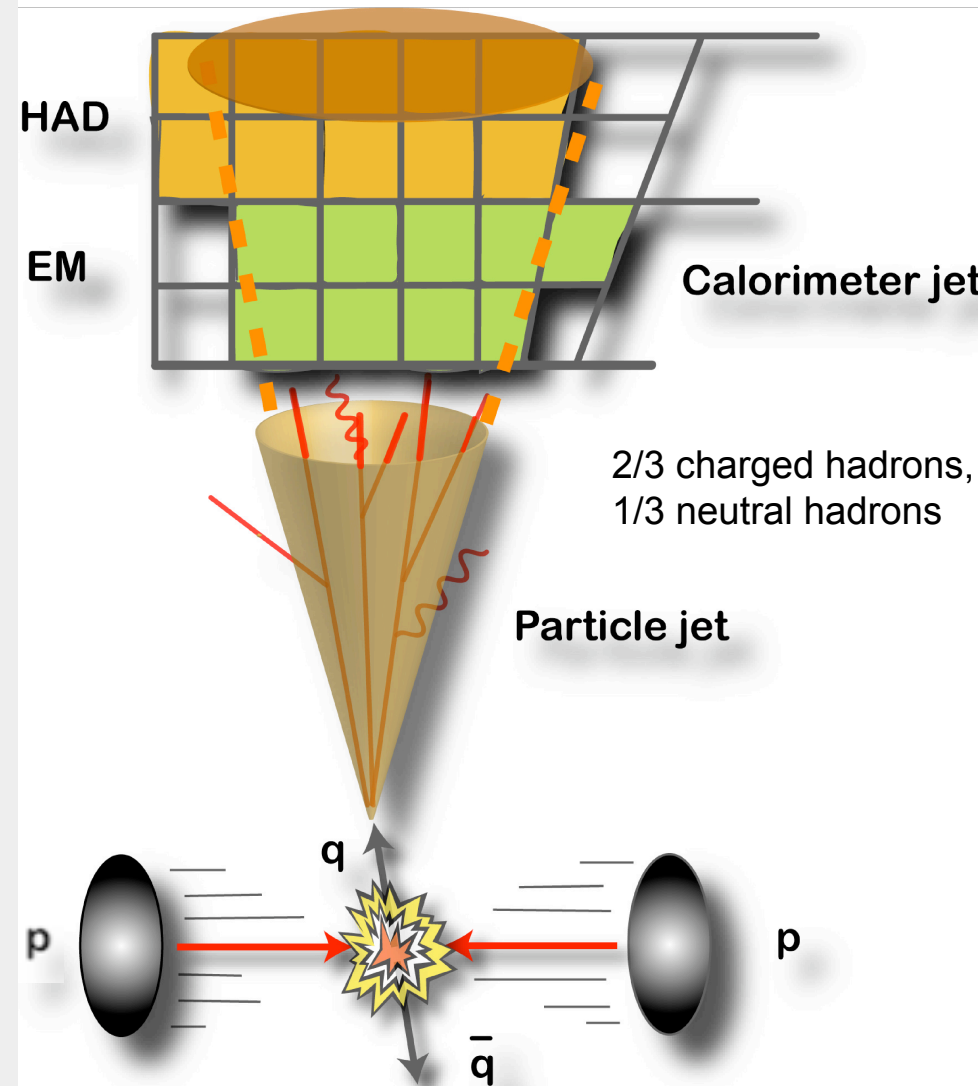

- Measurement of the kinematics of a hard parton emission requires

- Reconstruction:**

One needs : best matching to hard parton and jet identification. Many algorithms available: Cone, midpoint, KT

- Scale:**

calibration of the energy response, minimizing the measurement error

- Resolution:**

different reconstruction algorithms provide varied performance in the precision of the energy measurement

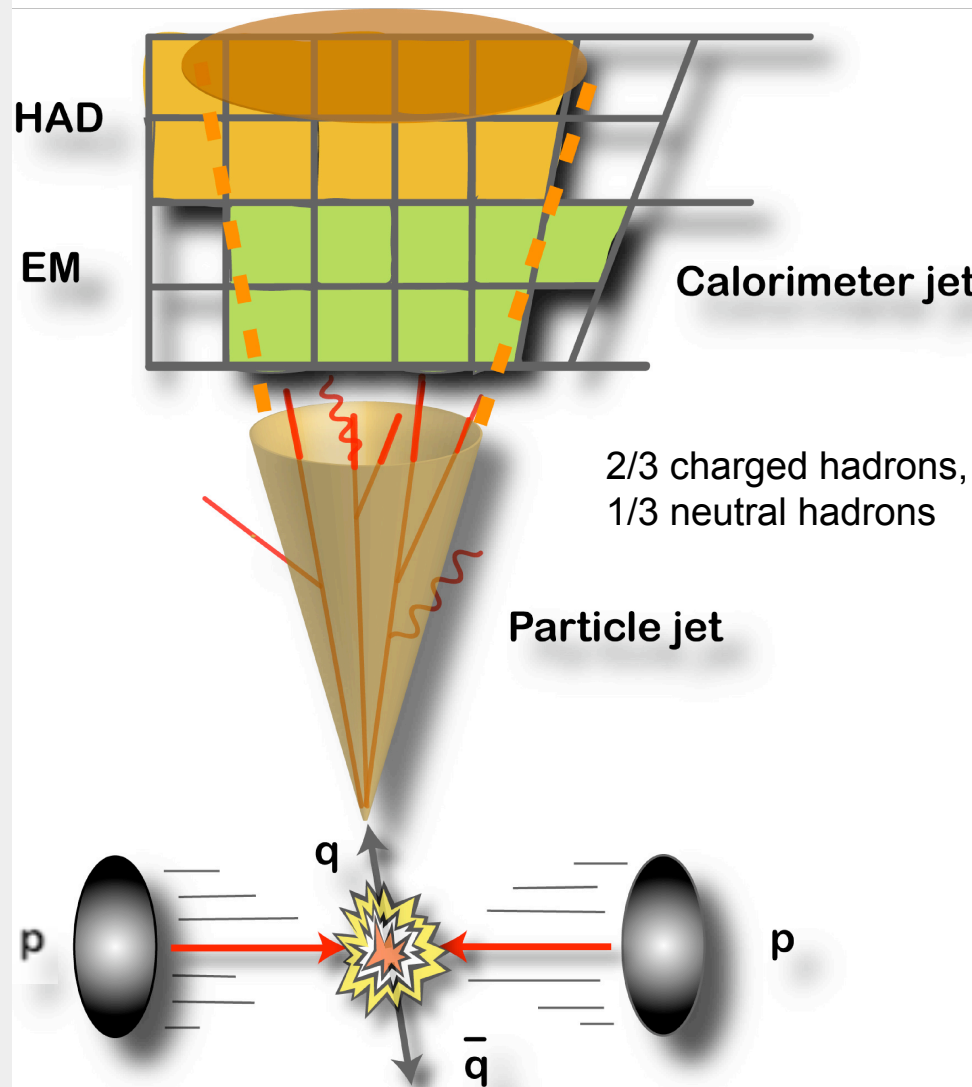

- Measurement of the kinematics of a hard parton emission requires

- Reconstruction:**

One needs : best matching to hard parton and jet identification. Many algorithms available: Cone, midpoint, KT

- Scale:**

calibration of the energy response, minimizing the measurement error

- Resolution:**

different reconstruction algorithms provide varied performance in the precision of the energy measurement

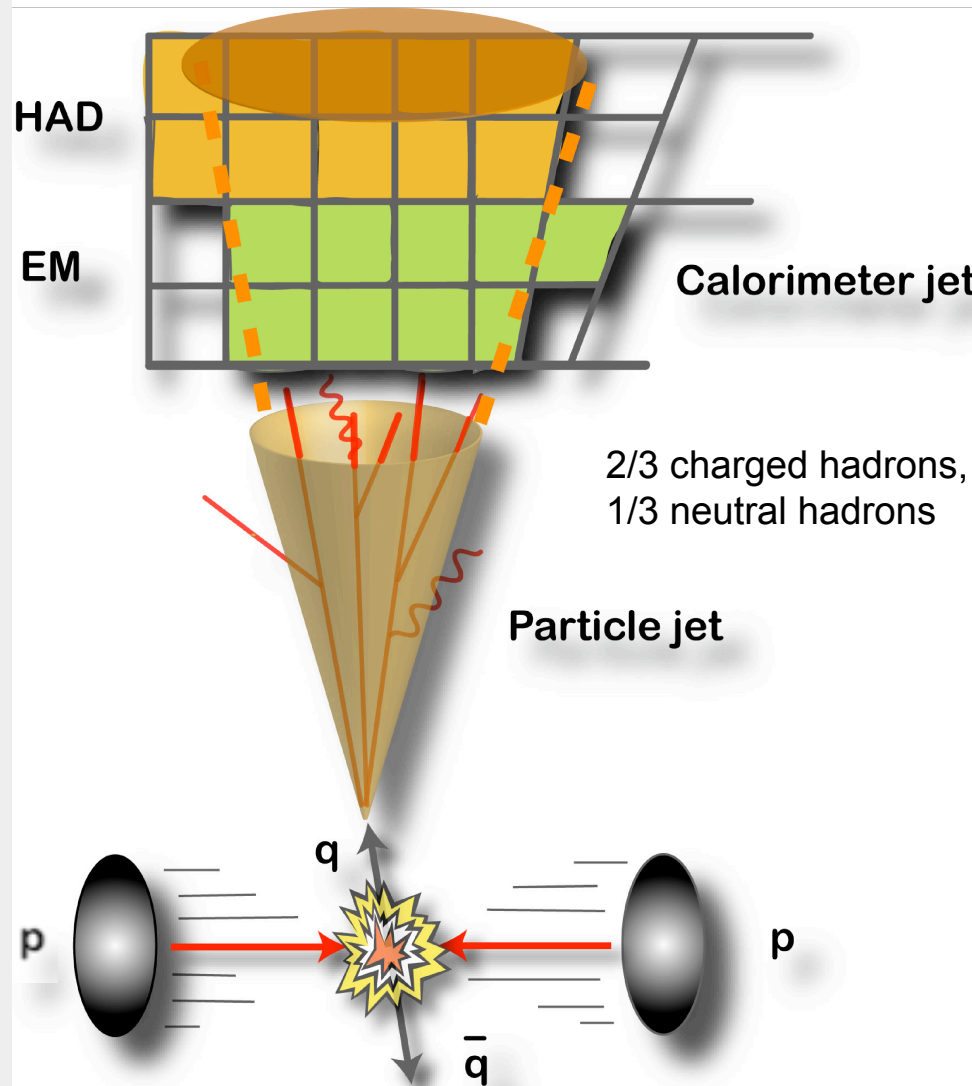

- Measurement of the kinematics of a hard parton emission requires

- Reconstruction:**

One needs : best matching to hard parton and jet identification. Many algorithms available: Cone, midpoint, KT

- Scale:**

calibration of the energy response, minimizing the measurement error

- Resolution:**

different reconstruction algorithms provide varied performance in the precision of the energy measurement

- Reconstruction and Energy Scale** are fundamental for precision measurements. **Resolution is critical for the successful identification of low S/B signal**

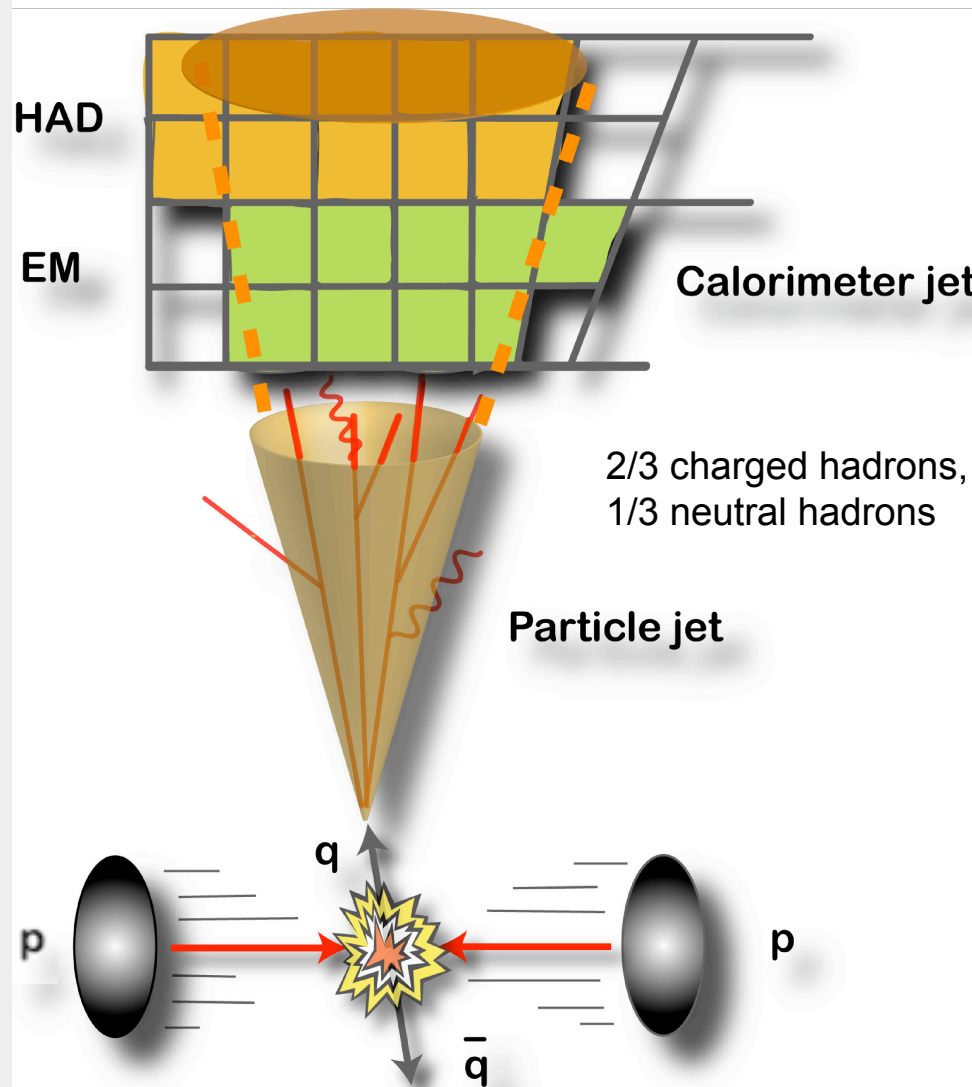



Objects: Neutrino ID

LM



Objects: Neutrino ID

LM

- **Signature**



- **Signature**
 - No interaction in the detector



- **Signature**
 - No interaction in the detector
- **Reconstruction**

- **Signature**
 - No interaction in the detector
- **Reconstruction**
 - Look for momentum imbalance and assign the missing momentum to the ν

- **Signature**
 - No interaction in the detector
- **Reconstruction**
 - Look for momentum imbalance and assign the missing momentum to the ν
 - But in hadron colliders, limited to using only the 2 transverse components of the momentum $\rightarrow p_T$

- **Signature**
 - No interaction in the detector
- **Reconstruction**
 - Look for momentum imbalance and assign the missing momentum to the ν
 - But in hadron colliders, limited to using only the 2 transverse components of the momentum $\rightarrow p_T$
 - $E_{T\text{miss}}$ Resolution depends on calorimeter resolution

- **Signature**
 - No interaction in the detector
- **Reconstruction**
 - Look for momentum imbalance and assign the missing momentum to the ν
 - But in hadron colliders, limited to using only the 2 transverse components of the momentum $\rightarrow p_T$
 - $E_{T\text{miss}}$ Resolution depends on calorimeter resolution
 - Degrades with detector imperfection (cracks) and pile up

- Efficiency**

- how often do we reconstruct the object – e.g. tracking efficiency

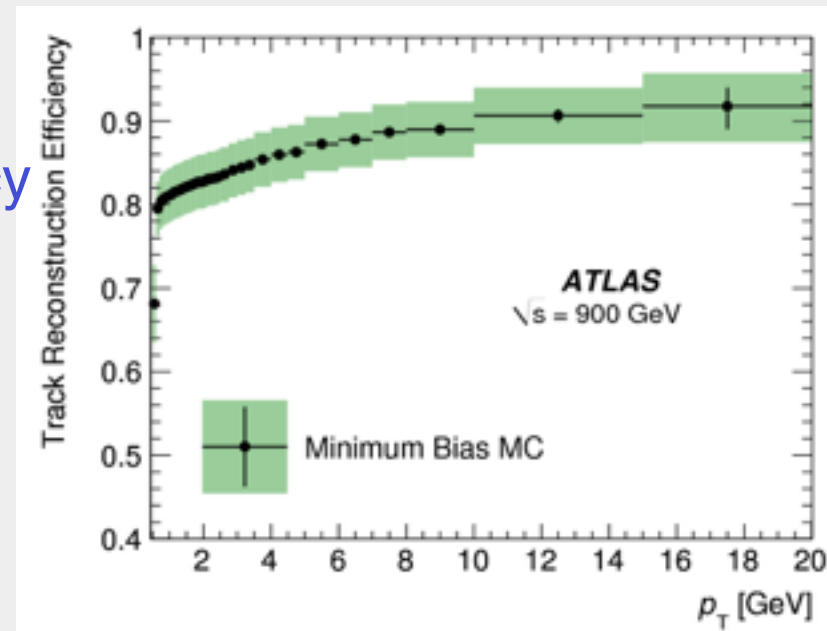

$$\text{Efficiency} = (\text{Number of Reconstructed Tracks}) / (\text{Number of True Tracks})$$



- **Efficiency**

- how often do we reconstruct the object – e.g. tracking efficiency

- **Resolution**

- how accurately do we reconstruct it – e.g. energy resolution

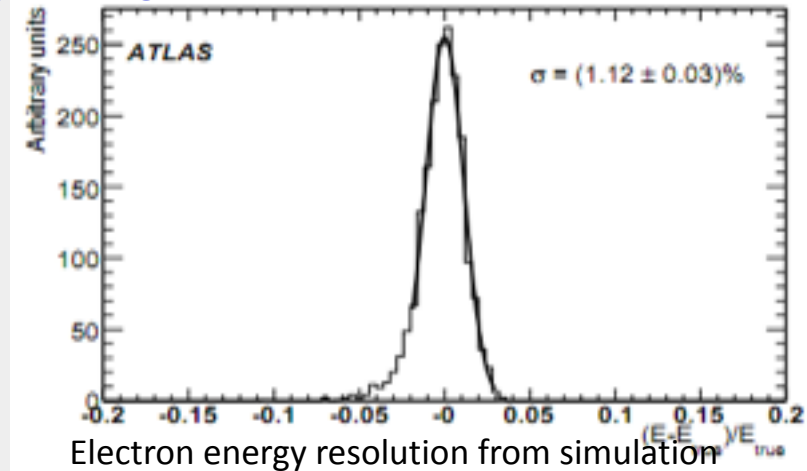

$$\text{Energy resolution} = (\text{Measured_Energy} - \text{True_Energy}) / \text{True_Energy}$$

- **Efficiency**

- how often do we reconstruct the object – e.g. tracking efficiency

- **Resolution**

- how accurately do we reconstruct a quantity – e.g. energy resolution

- **Fake rate**

- how often we reconstruct a different object as the object we are interested in – e.g. a jet faking an electron

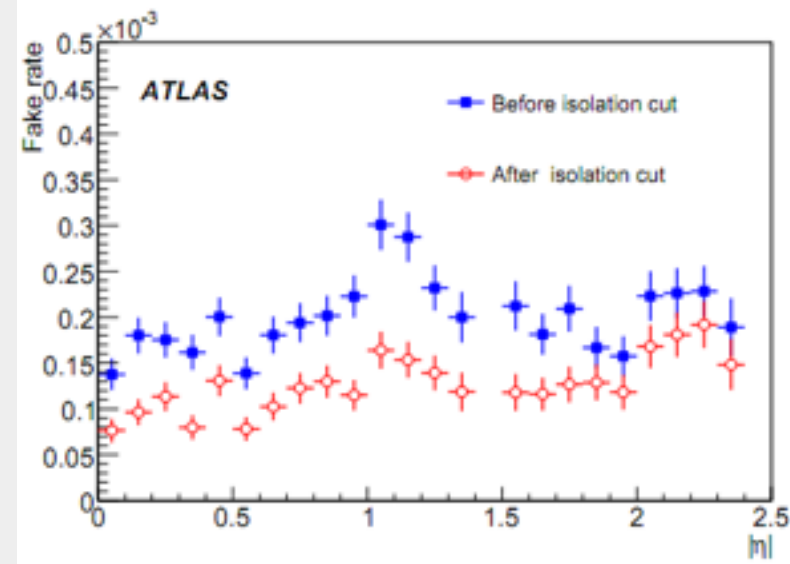

$$\text{Fake rate} = (\text{Number of jets reconstructed as an electron}) / (\text{Number of jets})$$

- **Efficiency**
 - how often do we reconstruct the object – e.g. tracking efficiency
- **Resolution**
 - how accurately do we reconstruct a quantity – e.g. energy resolution
- **Fake rate**
 - how often we reconstruct a different object as the object we are interested in – e.g. a jet faking a electron

- *For physics analysis it is important to have high efficiency, good resolution, and low fake rates*
- *to be able to measure the efficiencies, resolutions and fake rates and their uncertainties is not easy*
- *Robust against detector problems*
 - Noise
 - Dead regions of the detector
- *Be able to run within the computing resources limitations*
 - CPU time per event
 - Memory use

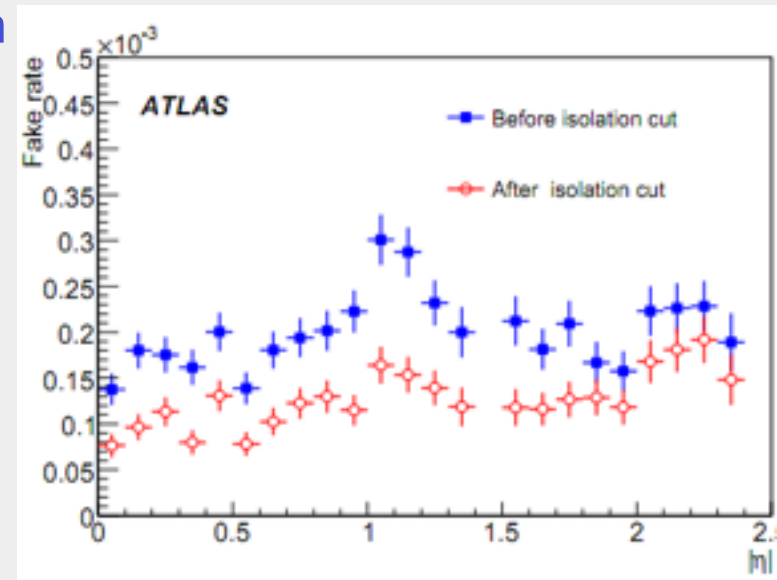



ID summary

LMR

- Particle identification is a crucial aspect of most high energy physics experiments, in addition to tracking and calorimetry

- Particle identification is a crucial aspect of most high energy physics experiments, in addition to tracking and calorimetry
- *Short-lived particles* are reconstructed from their decay products

- Particle identification is a crucial aspect of most high energy physics experiments, in addition to tracking and calorimetry
- *Short-lived particles* are reconstructed from their decay products
- *Most long-lived particles* seen in the experiment can be identified from their signatures in the various different detectors

- Particle identification is a crucial aspect of most high energy physics experiments, in addition to tracking and calorimetry
- *Short-lived particles* are reconstructed from their decay products
- *Most long-lived particles* seen in the experiment can be identified from their signatures in the various different detectors
- Distinguishing the different long-lived charged hadrons (π , K, p) is more challenging, and usually requires dedicated detectors

- Particle identification is a crucial aspect of most high energy physics experiments, in addition to tracking and calorimetry
- *Short-lived particles* are reconstructed from their decay products
- *Most long-lived particles* seen in the experiment can be identified from their signatures in the various different detectors
- Distinguishing the different long-lived charged hadrons (π , K, p) is more challenging, and usually requires dedicated detectors
- Their identification is based on four main processes:
TOF, dE/dx, Transition radiation and the Cherenkov effect



Lets look how were build the LHC detectors

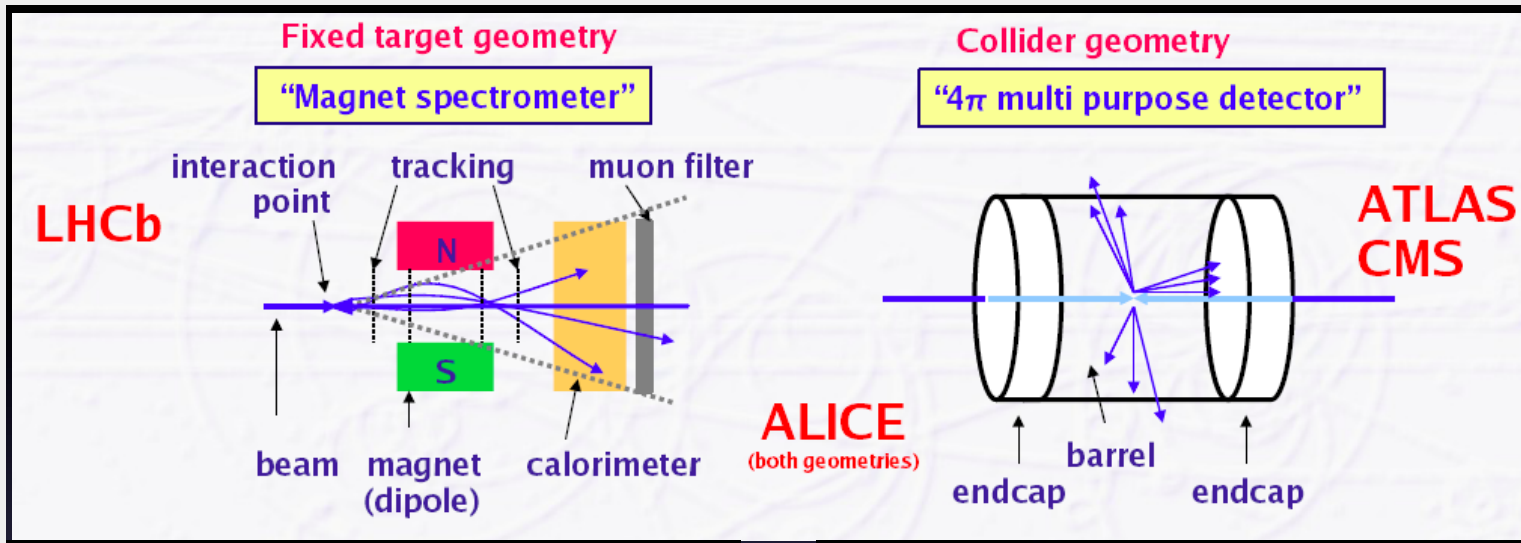

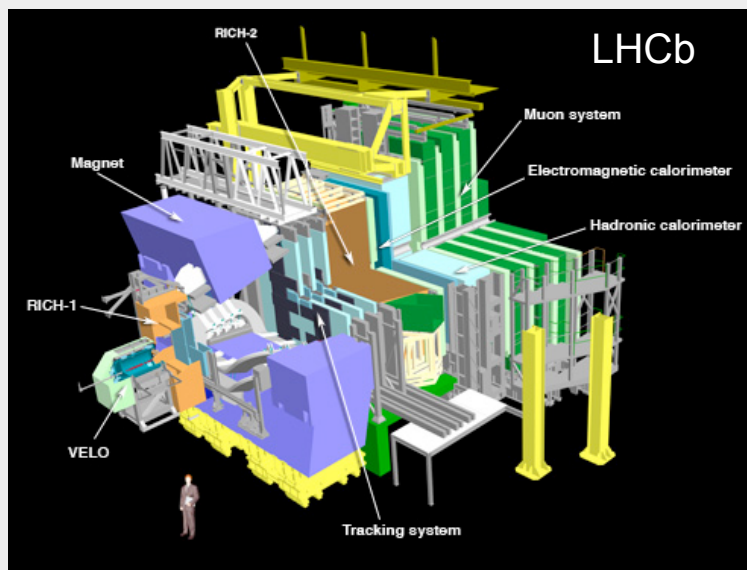
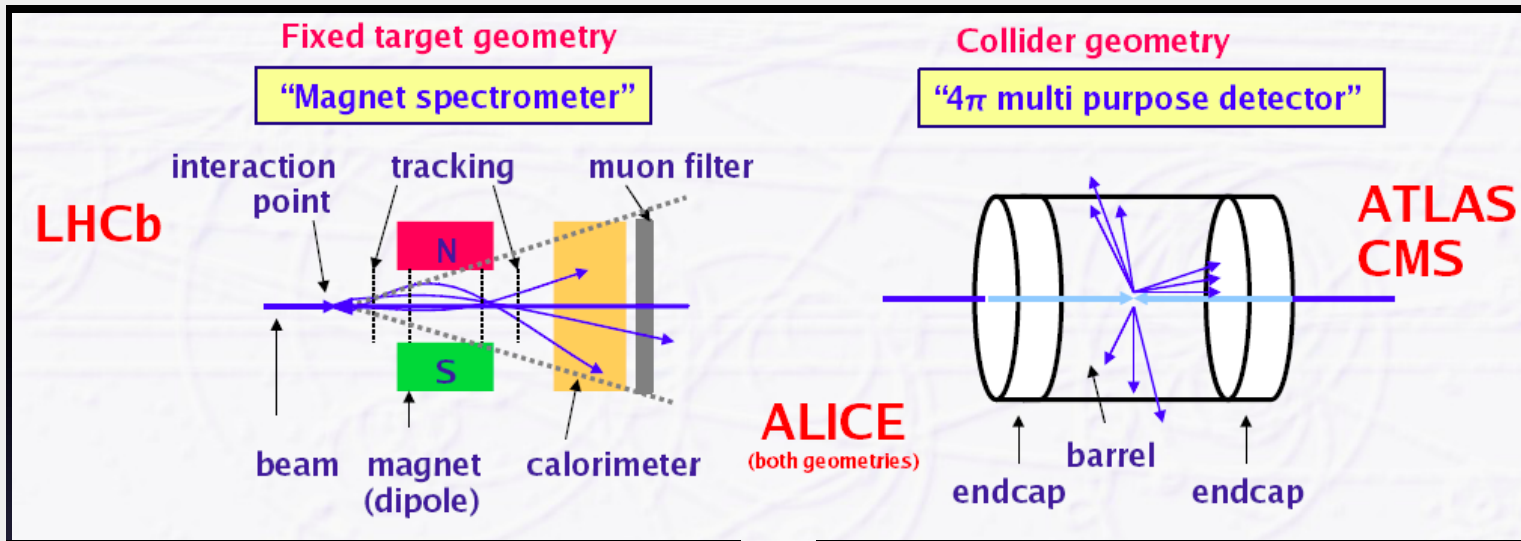

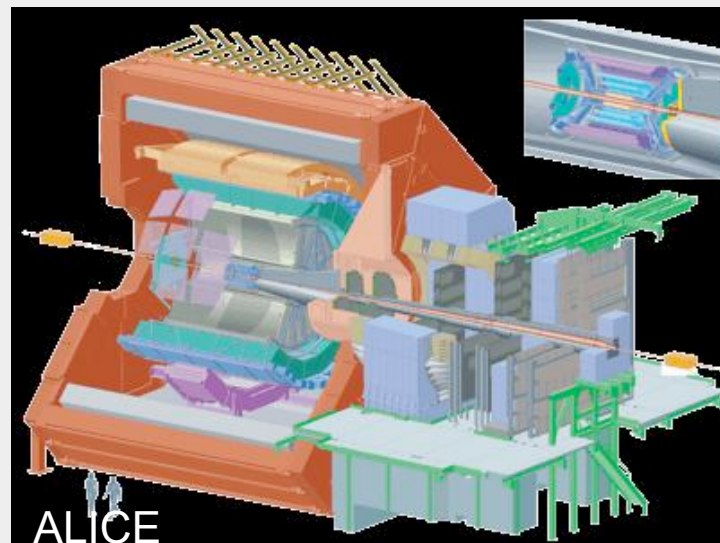
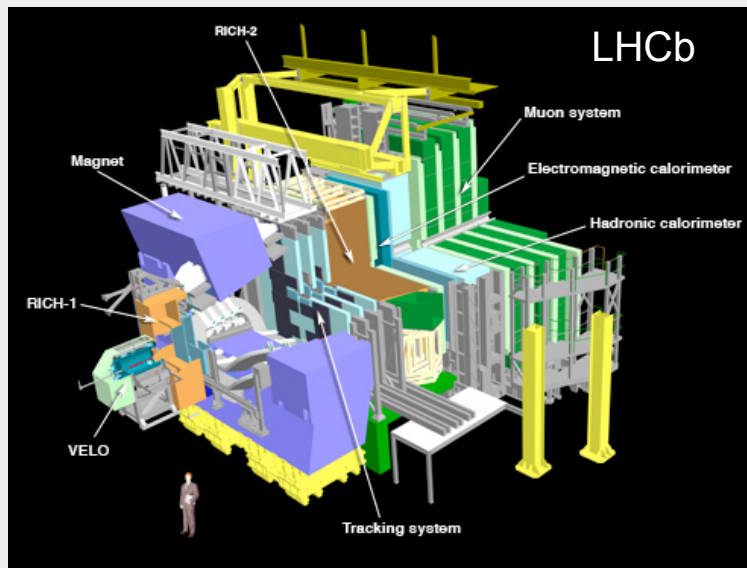
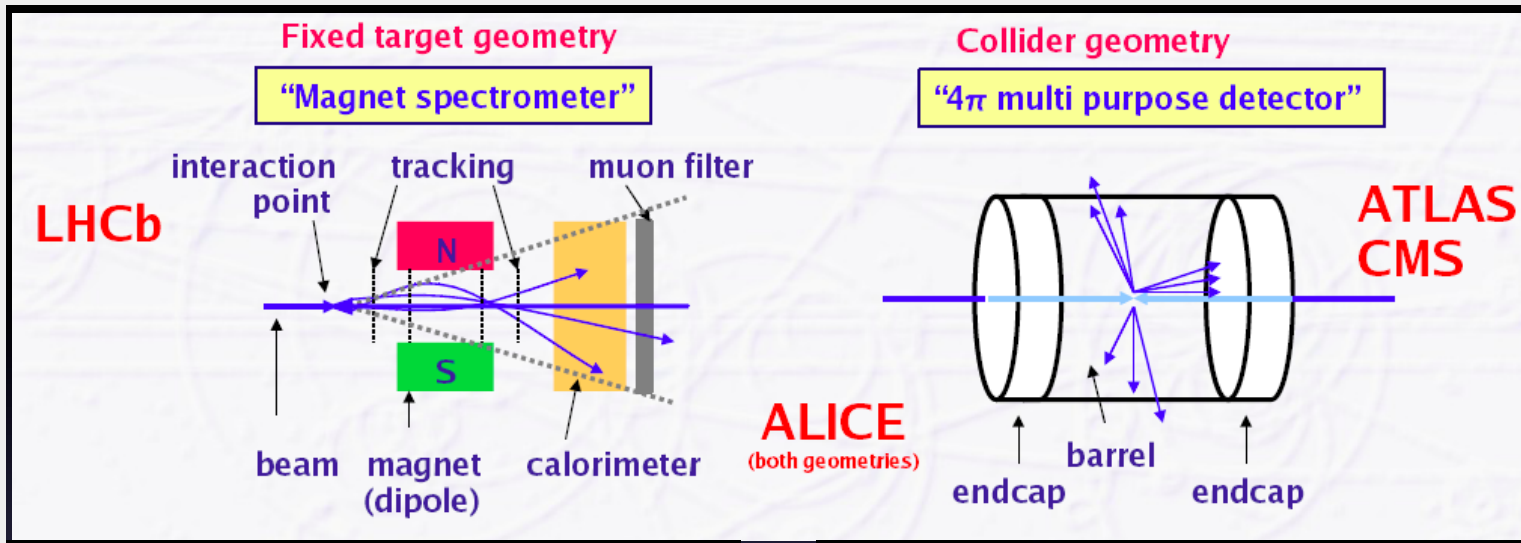

ATLAS 	Detector characteristics	
	Width:	44m
	Diameter:	22m
	Weight:	7000t

CERN AC - ATLAS V1997

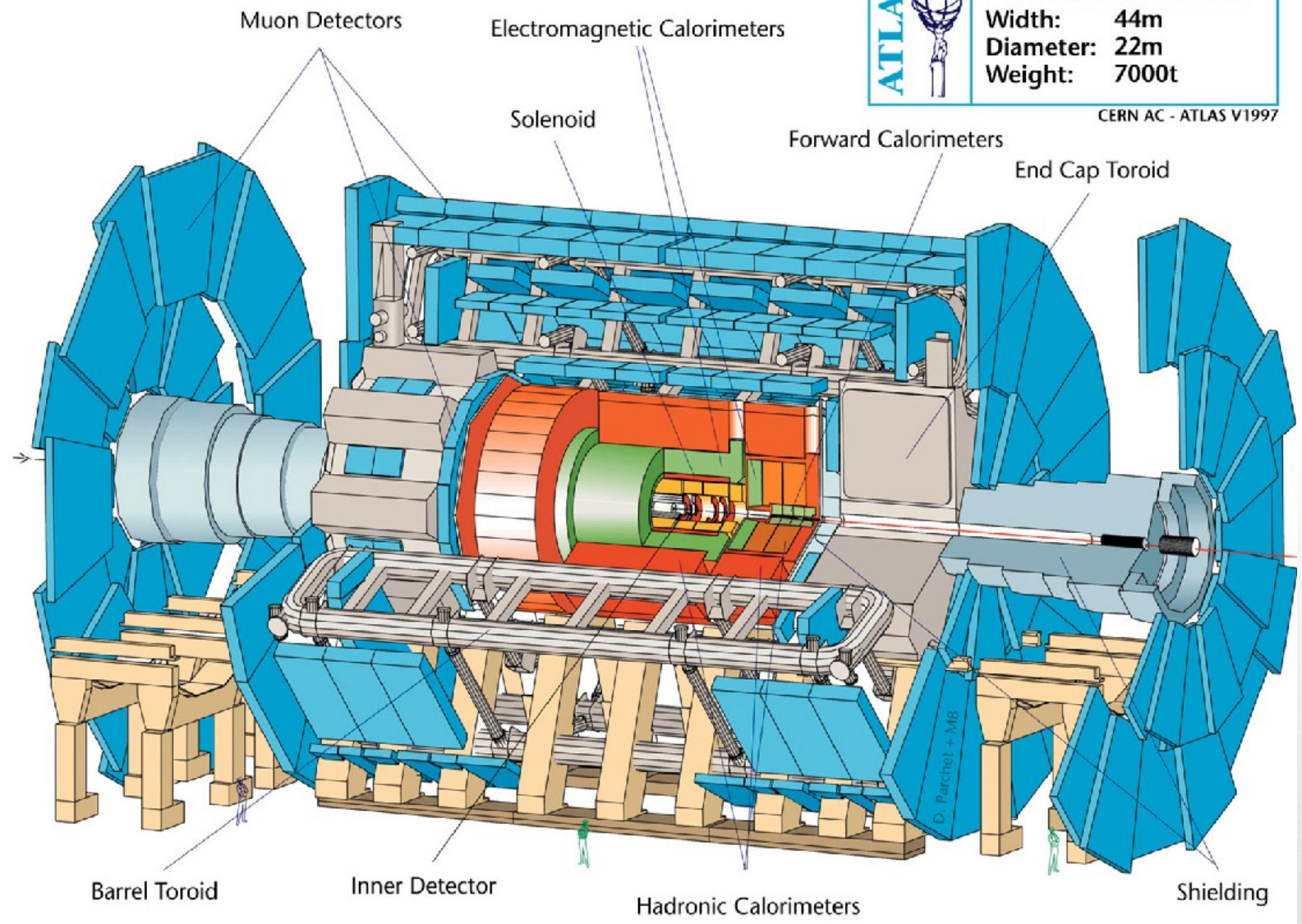



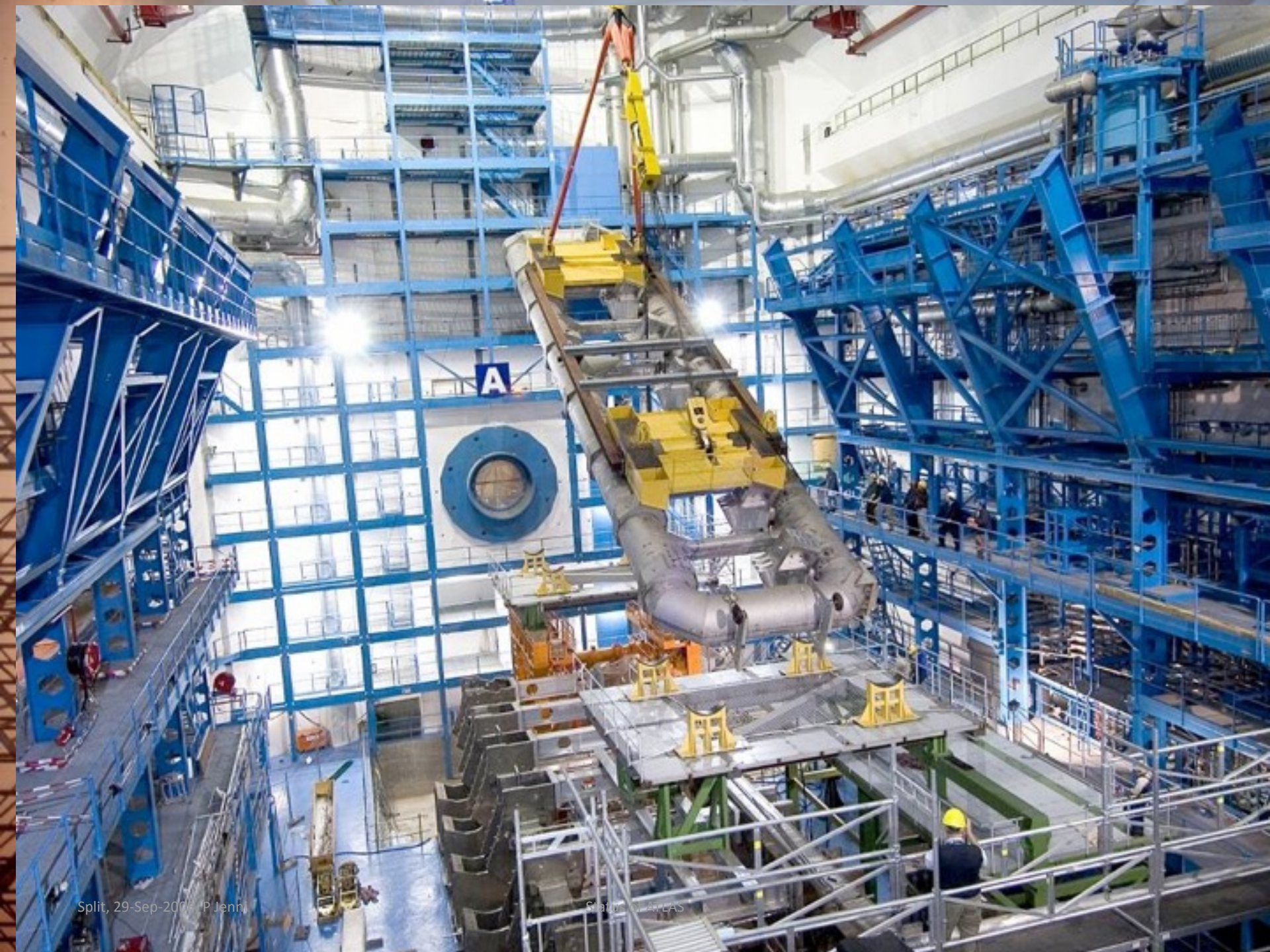









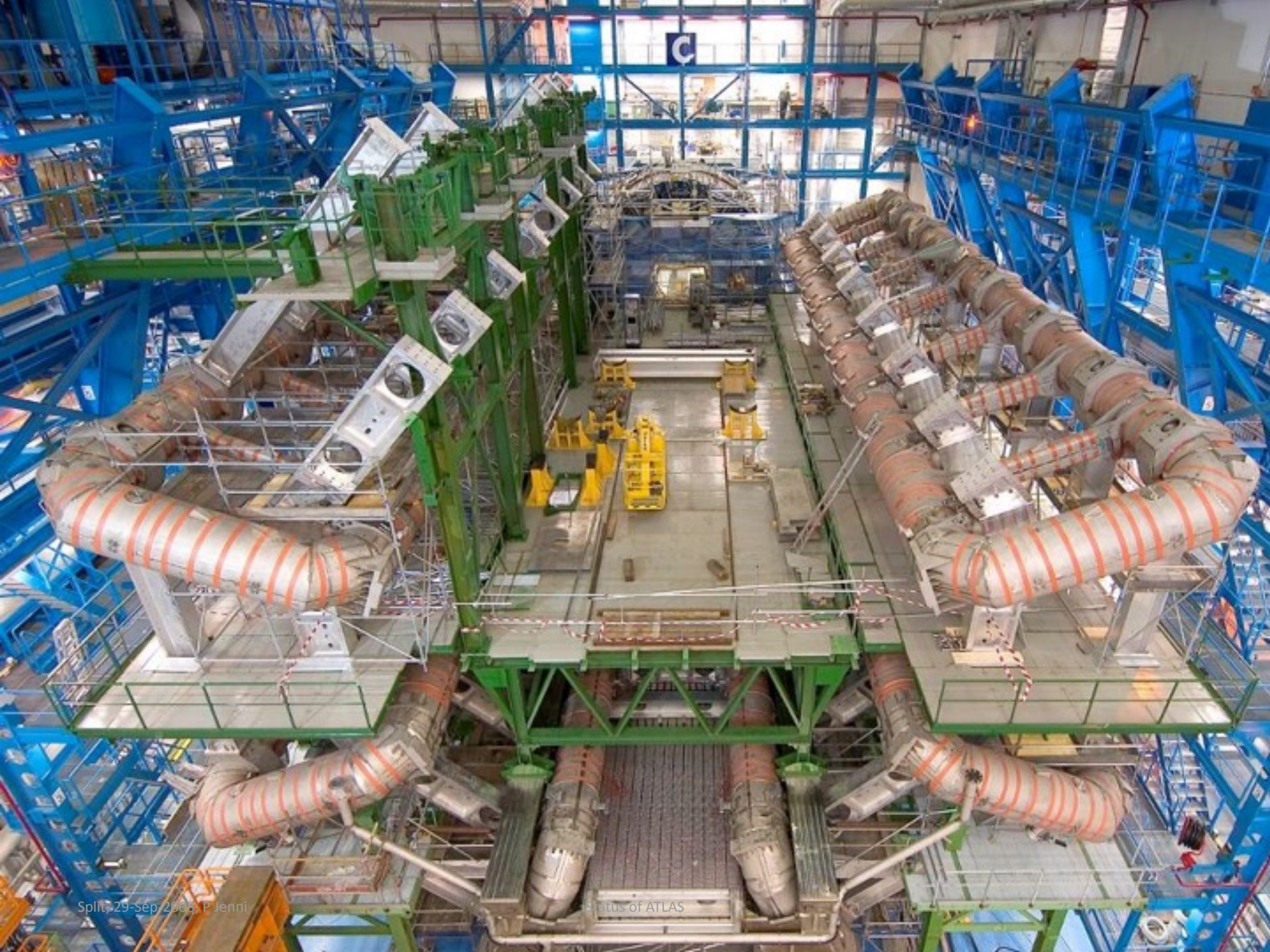



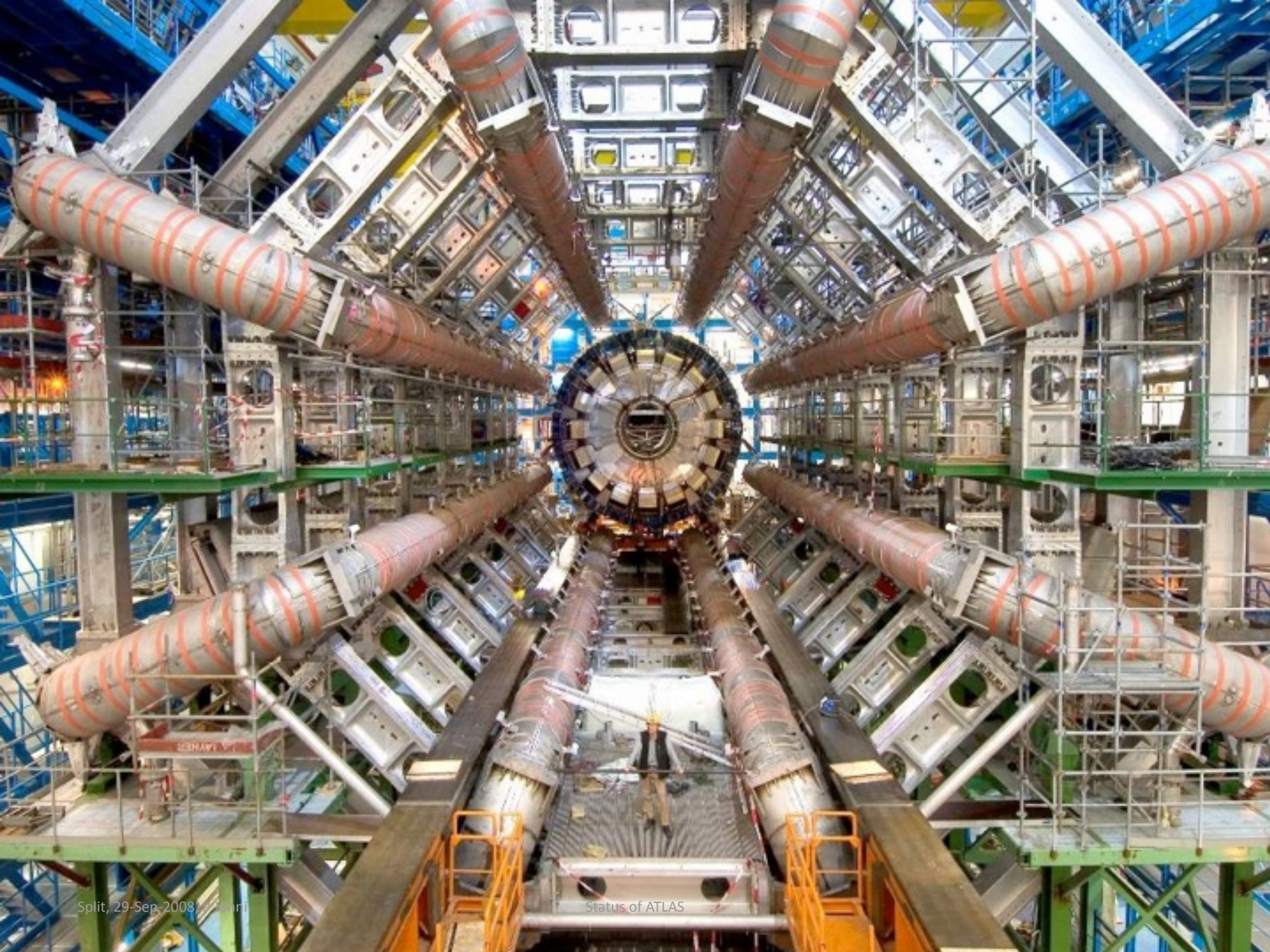

The Compact Muon Solenoid (CMS)

SUPERCONDUCTING COIL

CALORIMETERS
ECAL Scintillating PbWO₄ Crystals

HCAL Plastic scintillator copper sandwich

Total weight : 12,500 t
Overall diameter : 15 m
Overall length : 21.6 m
Magnetic field : 4 Tesla

IRON YOKE

TRACKERS

MUON ENDCAPS

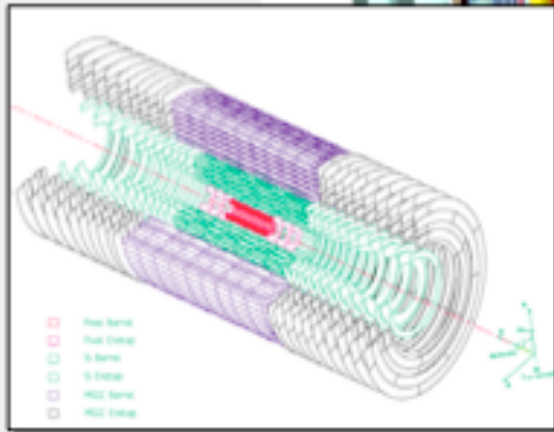

Silicon Microstrips
Pixels

MUON BARREL

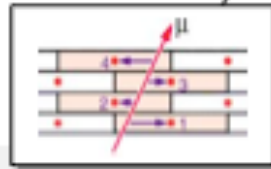

Drift Tube
Chambers (DT)

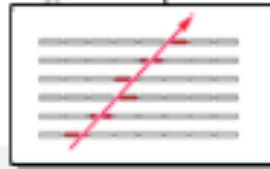

Resistive Plate
Chambers (RPC)

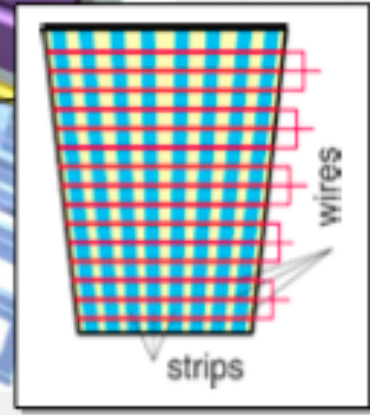

Cathode Strip Chambers (CSC)
Resistive Plate Chambers (RPC)

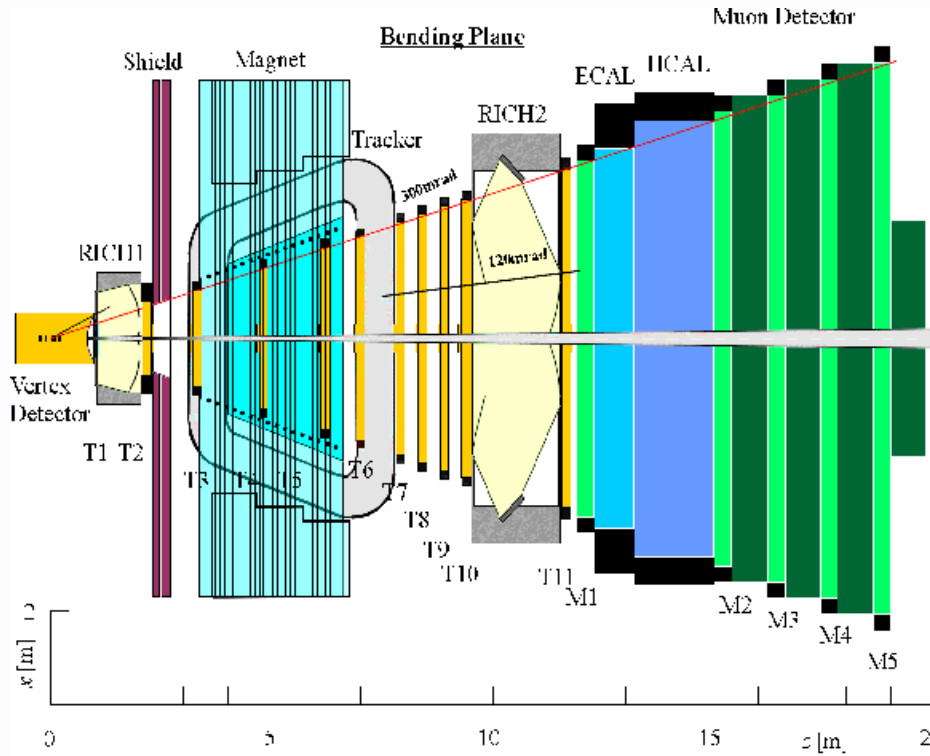

Detector Characteristics

- Length: 20 m
- Width: 12 m
- Height: 12 m
- Weight: 2'000 tons

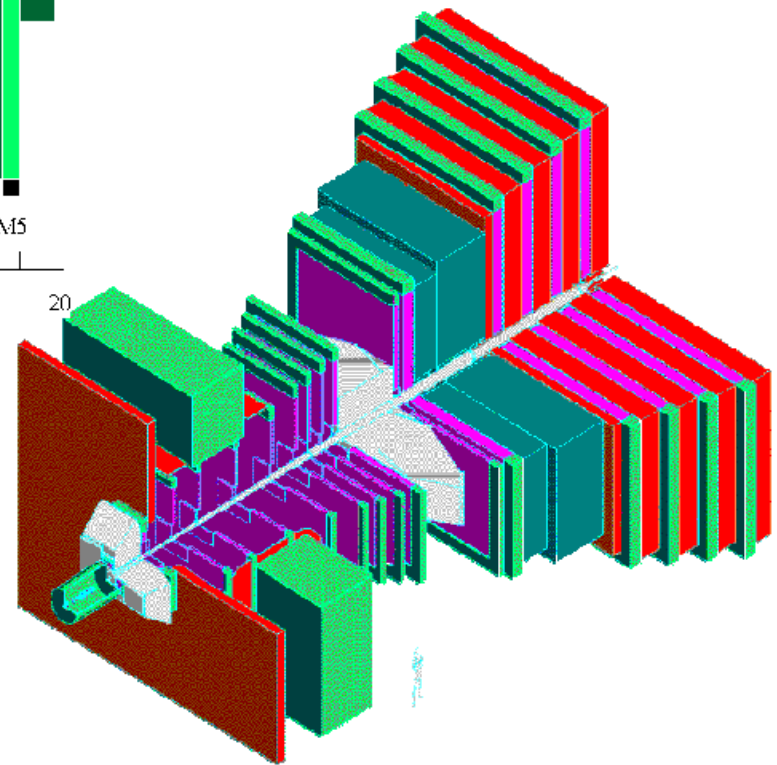

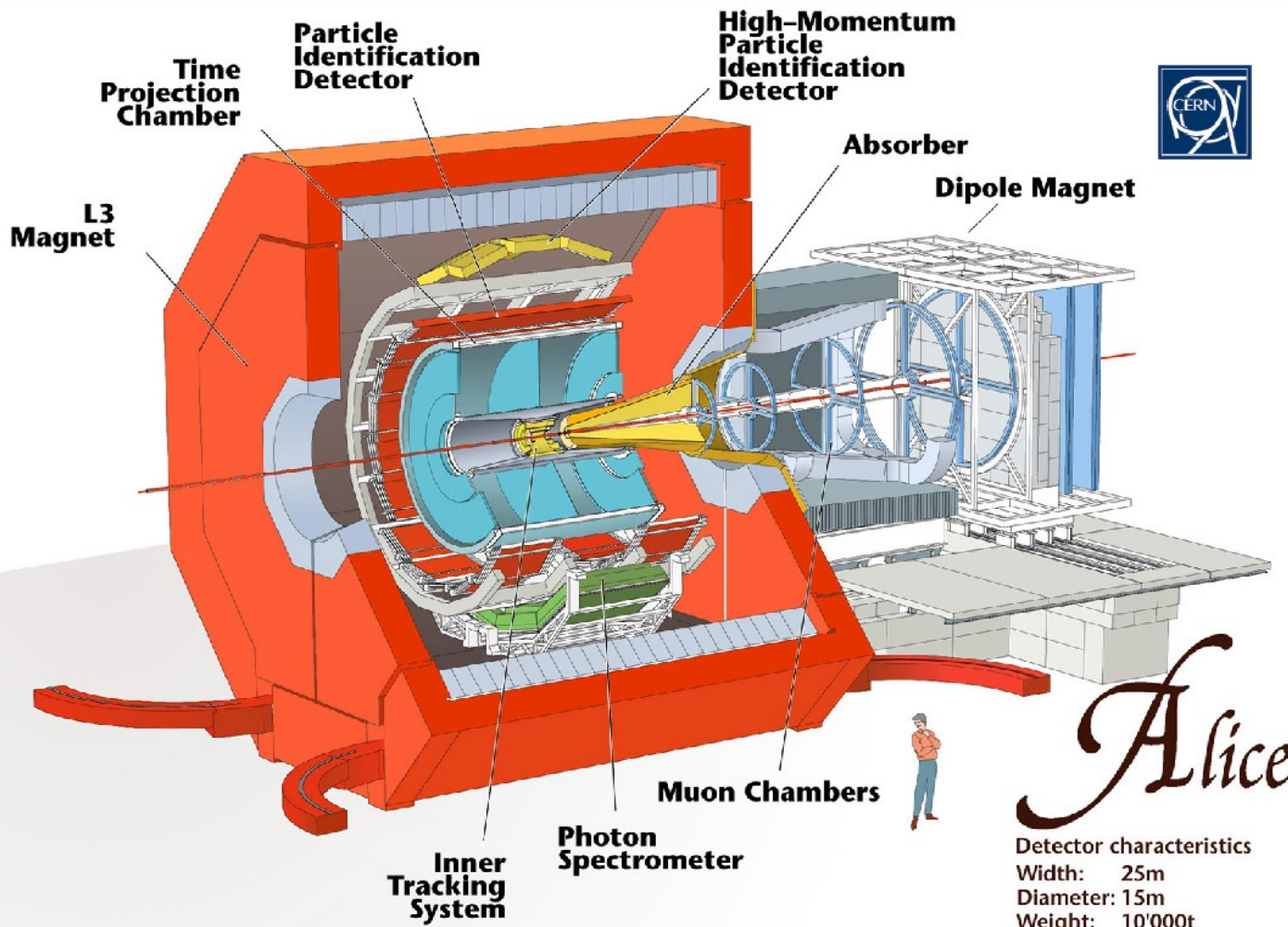

CERN AC - ALICE



Summary

LM

- *Particle physics, ‘born’ with the discovery of radioactivity and the electron at the end of the 19th century, has become ‘Big Science’ during the last 100 years.*

- *Particle physics, 'born' with the discovery of radioactivity and the electron at the end of the 19th century, has become 'Big Science' during the last 100 years.*
- *A large variety of instruments and techniques were developed for studying the world of particles.*

- *Particle physics, 'born' with the discovery of radioactivity and the electron at the end of the 19th century, has become 'Big Science' during the last 100 years.*
- *A large variety of instruments and techniques were developed for studying the world of particles.*
- *Imaging devices like the cloud chamber, emulsion and the bubble chamber took photographs of the particle tracks.*

- *Particle physics, 'born' with the discovery of radioactivity and the electron at the end of the 19th century, has become 'Big Science' during the last 100 years.*
- *A large variety of instruments and techniques were developed for studying the world of particles.*
- *Imaging devices like the cloud chamber, emulsion and the bubble chamber took photographs of the particle tracks.*
- *Logic devices like the Geiger Müller counter, the scintillator or the Cerenkov detector were (and are) widely used.*

- *Particle physics, 'born' with the discovery of radioactivity and the electron at the end of the 19th century, has become 'Big Science' during the last 100 years.*
- *A large variety of instruments and techniques were developed for studying the world of particles.*
- *Imaging devices like the cloud chamber, emulsion and the bubble chamber took photographs of the particle tracks.*
- *Logic devices like the Geiger Müller counter, the scintillator or the Cerenkov detector were (and are) widely used.*
- *Through the electronic revolution and the development of new detectors, both traditions merged into the 'electronics image' in the 1970ies.*

- *Particle physics, 'born' with the discovery of radioactivity and the electron at the end of the 19th century, has become 'Big Science' during the last 100 years.*
- *A large variety of instruments and techniques were developed for studying the world of particles.*
- *Imaging devices like the cloud chamber, emulsion and the bubble chamber took photographs of the particle tracks.*
- *Logic devices like the Geiger Müller counter, the scintillator or the Cerenkov detector were (and are) widely used.*
- *Through the electronic revolution and the development of new detectors, both traditions merged into the 'electronics image' in the 1970ies.*
- *Particle detectors with over 100 million readout channels are operating now at LHC.*

- ❖ *which particles are the most penetrating? depending on energy?*
- ❖ *what particle qualities (mass, charge,..) are the most important for the interaction with matter*
- ❖ *how to distinguish photons and electrons at 100 GeV in matter?*

- ❖ *compare decay and interaction probability for GeV pion*
- ❖ *compare λ_{hadr} and x_0 sizes of e.m. and hadronic showers*
- ❖ *multiple scattering angle vs. momentum of particle, vs. thickness of absorber*
- ❖ *compare ratio of particle energies to masses in hadronic and e.m. showers*
- ❖ *draw dE/dx from Bethe-Bloch for muons in iron in the range of 0.1 to 100 GeV*



Text books (a selection)

- C. Grupen, B. Shwartz, Particle Detectors, 2nd ed., Cambridge University Press, 2008
- G. Knoll, Radiation Detection and Measurement, 3rd ed. Wiley, 2000
- W. R. Leo, Techniques for Nuclear and Particle Physics Experiments, Springer, 1994
- R.S. Gilmore, Single particle detection and measurement, Taylor&Francis, 1992
- K. Kleinknecht, Detectors for particle radiation , 2nd edition, Cambridge Univ. Press, 1998
- W. Blum, W. Reigler, L. Rolandi, Particle Detection with Drift Chambers, Springer, 2008
- R. Wigmans, Calorimetry, Oxford Science Publications, 2000
- G. Lutz, Semiconductor Radiation Detectors, Springer, 1999

Review Articles

- Experimental techniques in high energy physics, T. Ferbel (editor), World Scientific, 1991.
- Instrumentation in High Energy Physics, F. Sauli (editor), World Scientific, 1992.
- Many excellent articles can be found in Ann. Rev. Nucl. Part. Sci.

Other sources

- Particle Data Book Phys. Lett. B592, 1 (2008) <http://pdg.lbl.gov/pdg.html>
- R. Bock, A. Vasilescu, Particle Data Briefbook <http://www.cern.ch/Physics/ParticleDetector/BriefBook/>
- ICFA schools lectures : <http://www.ifm.umich.mx/school/ICFA-2002/>
- O. Ullaland <http://lhcb-doc.web.cern.ch/lhcbdoc/presentations/lectures/Default.htm>
- Proceedings of detector conferences (Vienna VCI, Elba, IEEE, Como)
- Journals: Nucl. Instr. Meth. A, Journal of Instrumentation

Trigger and DAQ

- R. Fernow : Introduction to experimental particle physics (C.U.P. 1986)
- R. Frühwirth, M. Regler, R.K. Bock, H. Grote and D. Notz ; Data Analysis Techniques for High-Energy Physics (2nd ed.) (C.U.P. 2000)
- CERN-⁴⁸Latin American Schools of Physics : Usually an article on trigger and DAQ

Useful material & acknowledgments

■ I have taken part of the content of these lecture from Werner Riegler's summer student lectures in 2011 and Erika Garutti's DESY lecture notes

■ Useful books

- Detector for particle radiation, Konrad Kleinknecht
- Techniques for Nuclear and Particle Physics Experiments, W. R. Leo
- Particle Detectors, Claus Grupen
- Introduction to Experimental Particle Physics, R. Fernow
- The Physics of Particle Detectors, D. Green
- Review in data particle book on Passage of particles through matter
- Review in data particle book on Particle Detectors at accelerators

- **D.H. Wilkinson: *Ionization Chambers and Counters* (Cambridge Univ. Press, 1950)**
- **S.A. Korff: *Electron and Nuclear Counters* (Van Nostrand, 1955)**
- **P. Rice-Evans: *Spark, Streamer, Proportional and Drift Chambers* (Richelieu, 1974)**
- **F. Sauli: *Principles of Operation of Multiwire Proportional and Drift Chambers* (CERN 77-)**
- **Th. Ferbel, Editor: *Techniques and Concepts of High-energy Physics* (Plenum, 1983)**
- **R.C. Fernow: *Introduction to Experimental Particle Physics* (Cambridge Univ. Press, 1988)**
- **W.R. Leo: *Techniques for Nuclear and Particle Physics Experiments* (Springer, 1987)**
- **C. Fabjan and J. Pilcher, ed.: *Instrumentation in Elementary Particle Physics* (World Scientific, 1988)**
- **C.F.G. Delaney and E.C. Finch: *Radiation Detectors* (Clarendon Press, 1992)**
- **R. Gilmore: *Single Particle Detection and Measurement* (Taylor and Francis, 1992)**
- **F. Sauli, ed.: *Instrumentation in High Energy Physics* (World Scientific, 1992)**
- **K. Grupen: *Particle Detectors* (Cambridge Monographs on Part. Phys. 1996)**
- **K. Kleinknecht: *Detectors for Particle Radiation* (Cambridge Univ. Press 1998)**
- **G.F. Knoll: *Radiation Detection and Measurements, 3d Ed.* (Wiley, 2000)**
- **W. Blum, W. Riegler and L. Rolandi: *Particle Detection with Drift Chambers, 2d Ed.* (Springer, 2000)**

- Definitions and Units
- Time Of Flight
- Ionization
- Transition radiation
- Particle Detection principle
- About Cross Section
- Electromagnetic Shower Development
- Diffusion in gases
- Particle ID - Distinguishing particles nature
- Historical examples
- Applications
- Neutrino detectors
- Effective mass calculation
- Detector Systems

for details clic

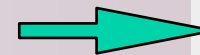

for details clic

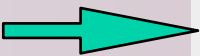

for details clic

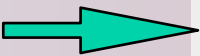

for details clic

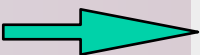

for details clic

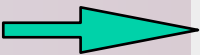

for details clic

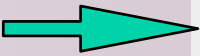

for details clic

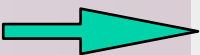

for details clic

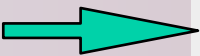

for details clic

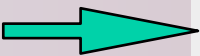

for details clic

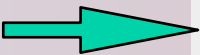

for details clic

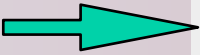

for details clic

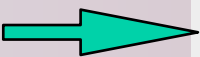

$$E^2 = p^2 c^2 + m_0^2 c^4$$

- energy E : measure in eV
- momentum p : measure in eV/c
- mass m_0 : measure in eV/c²

$$\beta = \frac{v}{c} \quad (0 \leq \beta < 1) \quad \gamma = \frac{1}{\sqrt{1 - \beta^2}} \quad (1 \leq \gamma < \infty)$$

$$E = m_0 \gamma c^2 \quad p = m_0 \gamma \beta c \quad \beta = \frac{pc}{E}$$

1 eV is a tiny portion of energy. 1 eV = 1.6 · 10⁻¹⁹ J



$$m_{bee} = 1\text{g} = 5.8 \cdot 10^{32} \text{ eV}/c^2$$

$$v_{bee} = 1\text{m/s} \rightarrow E_{bee} = 10^{-3} \text{ J} = 6.25 \cdot 10^{15} \text{ eV}$$

$$E_{LHC} = 14 \cdot 10^{12} \text{ eV}$$

For times practical units are

- 1 μs (10⁻⁶ s), an electron drifts in a gas 5 cm
- 1 ns (10⁻⁹ s), a relativistic e⁻ travels 30 cm
- 1 ps (10⁻¹² s), mean life time of a B meson

To rehabilitate LHC...

Total stored beam energy: $E_{total} = 10^{14} \text{ protons} \cdot 7 \cdot 10^{12} \text{ eV} \approx 7 \cdot 10^{26} \text{ eV} \approx 1 \cdot 10^8 \text{ J}$

this corresponds to a



$$m_{truck} = 100 \text{ T}$$

$$v_{truck} = 120 \text{ km/h}$$

Stored energy in LHC magnets ~ 1 GJ



$$m_{747} = 400 \text{ T}$$

$$v_{747} = 255 \text{ km/h}$$

- Simple concept: measure the time difference between two detector planes

$$\beta = d / c \Delta t$$
- At high energy, particle speeds are relativistic, closely approaching to c
- **For a 10 GeV K**, the time to travel 12 m is 40.05 ns, whereas for a π it would be 40.00 ns, so the difference is only 50 ps
- Modern detectors + readout electronics have resolution $\sigma_t \sim 10$ ns, fast enough for the LHC (bunch crossings 25 ns apart) but need $\sigma_t < 1$ ns to do useful TOF
- TOF gives good ID at low momentum
 Very precise timing required for $p > 5$ GeV

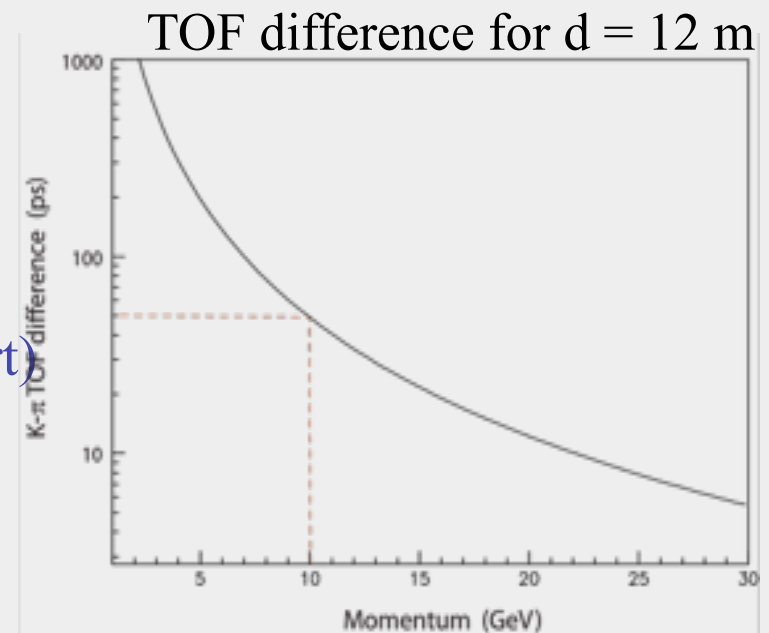
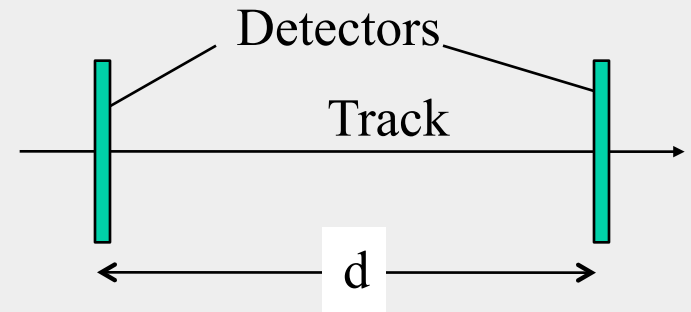

- Charged particles passing through matter can knock out electrons from atoms of the medium: ionization
- Energy loss described by the Bethe-Bloch formula, which gives the universal velocity dependence: $dE/dx \propto \log(\beta^2 \gamma^2) / \beta^2$
- This can be used to identify particles, particularly at low momentum where dE/dx varies rapidly
- **Advantage:** uses existing detectors needed for tracking
- Note: these techniques all provide signals for charged leptons e , μ as well as π , K , p
But $m_\mu \approx m_\pi$, so they are not well separated

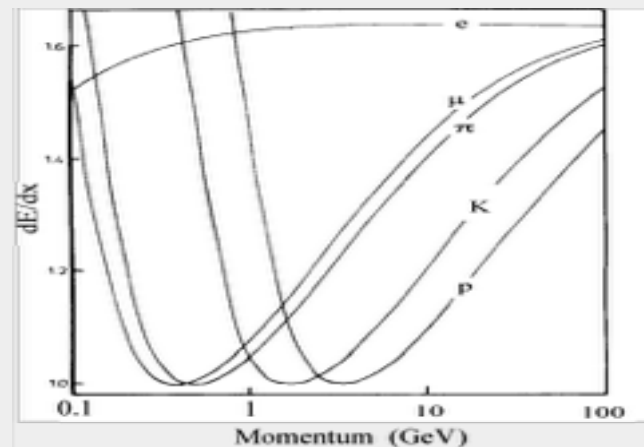
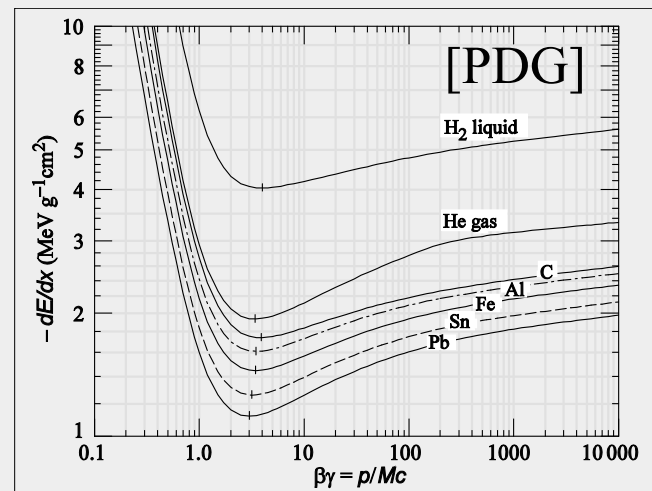

- Local speed of light in a medium with refractive index n is $c_p = c/n$
- If its relative velocity v/c_p changes, a particle will radiate photons:
 - Change of direction v (in magnetic field) \rightarrow Synchrotron radiation
 - Change of $|v|$ (passing through matter) \rightarrow Bremsstrahlung radiation
 - Change of refractive index n of medium \rightarrow Transition radiation
- Transition radiation** is emitted whenever a relativistic charged particle traverses the border between two media with different dielectric constants ($n \sim \sqrt{\epsilon}$)
- The energy emitted is proportional to the boost γ of the particle
 \rightarrow Particularly useful for electron ID
 Can also be used for hadrons at high energy
- Named after the Russian scientist P. Cherenkov who was the first to study the effect in depth (Nobel Prize 1958)

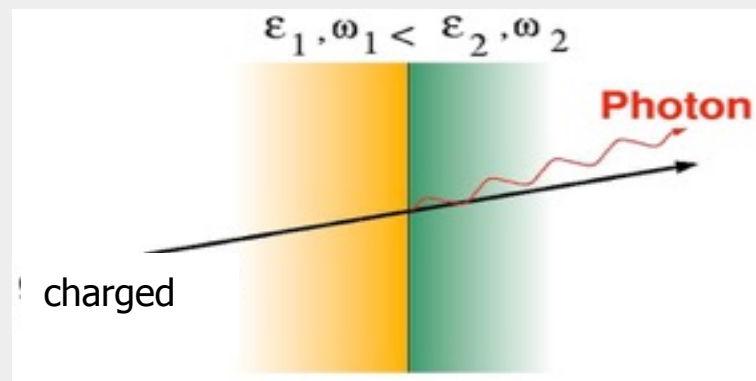

In order to detect a particle

- it must interact with the material of the detector
- transfer energy in some recognizable fashion

i.e. **The detection of particles happens via their energy loss in the material it traverses ...**

Possibilities:

Charged particles

Hadrons

Photons

Neutrinos

Ionization, Bremsstrahlung, Cherenkov ...

Nuclear interactions

Photo/Compton effect, pair production

Weak interactions

Energy loss
by multiple reactions

Total energy loss
via single interaction

→ charged particles

Particle Interactions – Examples

Ionization:

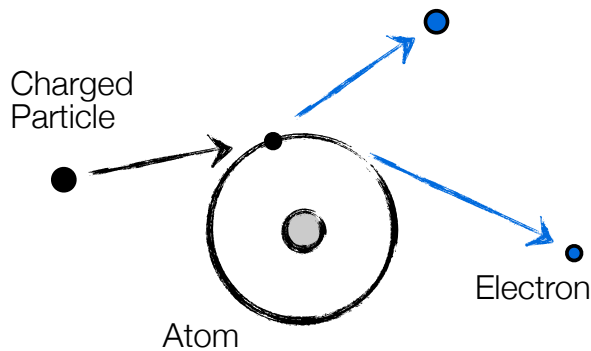
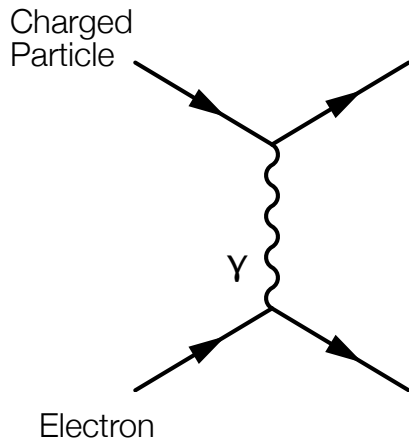

Pair production:

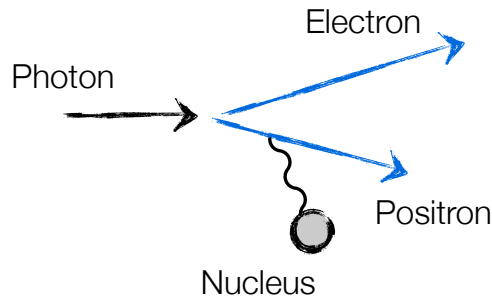
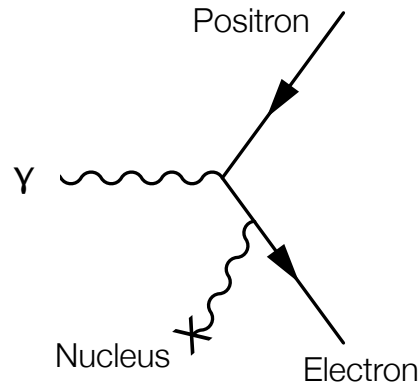

Compton scattering:

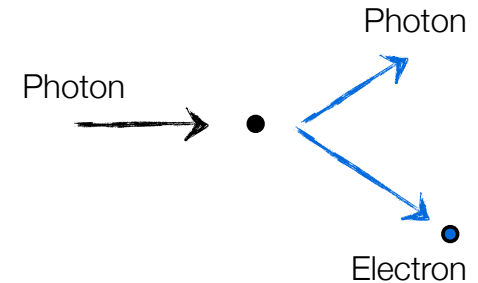
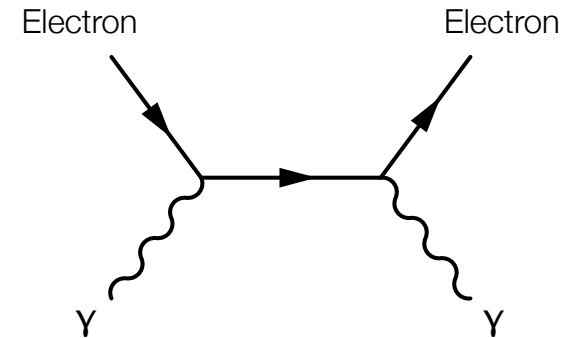

Energy Loss by Ionization – dE/dx

For now assume: $Mc^2 \gg m_e c^2$

i.e. energy loss for heavy charged particles
[dE/dx for electrons more difficult ...]

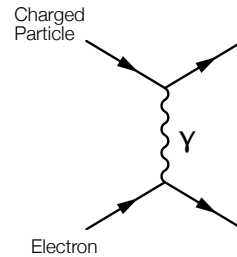

Interaction dominated
by elastic collisions with electrons ...

Bethe-Bloch Formula

$$-\left\langle \frac{dE}{dx} \right\rangle = K z^2 \frac{Z}{A} \frac{1}{\beta^2} \left[\frac{1}{2} \ln \frac{2m_e c^2 \beta^2 \gamma^2 T_{\max}}{I^2} - \beta^2 - \frac{\delta(\beta\gamma)}{2} \right]$$

$$\propto 1/\beta^2 \cdot \ln(\text{const} \cdot \beta^2 \gamma^2)$$

Energy Loss of Electrons

Bethe-Bloch formula needs modification

Incident and target electron have same mass m_e
Scattering of identical, indistinguishable particles

$$-\left\langle \frac{dE}{dx} \right\rangle_{\text{el.}} = K \frac{Z}{A} \frac{1}{\beta^2} \left[\ln \frac{m_e \beta^2 c^2 \gamma^2 T}{2I^2} + F(\gamma) \right]$$

[T: kinetic energy of electron]

$$W_{\max} = \frac{1}{2}T$$

Remark: different energy loss for electrons and positrons at low energy as
positrons are not identical with electrons; different treatment ...

Bethe-Bloch – Classical Derivation

Bohr 1913

Particle with charge ze and velocity v moves through a medium with electron density n .

Electrons considered free and initially at rest.

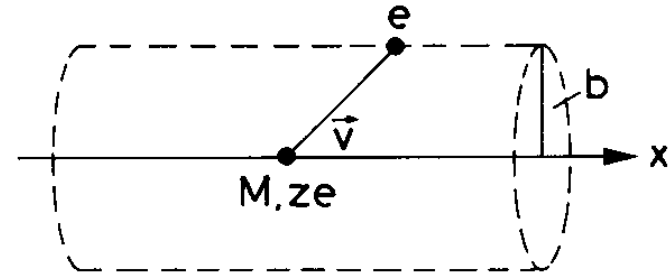

Interaction of a heavy charged particle with an electron of an atom inside medium.

Momentum transfer:

$$\Delta p_{\perp} = \int F_{\perp} dt = \int F_{\perp} \frac{dt}{dx} dx = \int F_{\perp} \frac{dx}{v}$$

Symmetry!
 Δp_{\parallel} : averages to zero

$$= \int_{-\infty}^{\infty} \frac{ze^2}{(x^2 + b^2)} \cdot \frac{b}{\sqrt{x^2 + b^2}} \cdot \frac{1}{v} dx = \frac{ze^2 b}{v} \left[\frac{x}{b^2 \sqrt{x^2 + b^2}} \right]_{-\infty}^{\infty} = \frac{2ze^2}{bv}$$

More elegant with Gauss law:

[infinite cylinder; electron in center]

$$\int E_{\perp} (2\pi b) dx = 4\pi(ze) \rightarrow \int E_{\perp} dx = \frac{2ze}{b}$$

and then ...

$$\begin{cases} F_{\perp} = eE_{\perp} \\ \Delta p_{\perp} = e \int E_{\perp} \frac{dx}{v} = \frac{2ze^2}{bv} \end{cases}$$

Bethe-Bloch – Classical Derivation

Bohr 1913

Energy transfer onto **single** electron
for **impact parameter** b :

$$\Delta E(b) = \frac{\Delta p^2}{2m_e}$$

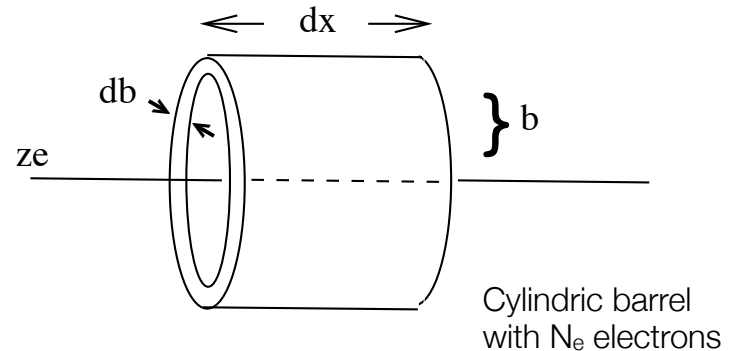

Consider cylindric barrel $\rightarrow N_e = n \cdot (2\pi b) \cdot db dx$

Energy loss **per path length** dx for
distance between b and $b+db$ in medium with **electron density** n :

Energy loss!

$$-dE(b) = \frac{\Delta p^2}{2m_e} \cdot 2\pi n b db dx = \frac{4z^2 e^4}{2b^2 v^2 m_e} \cdot 2\pi n b db dx = \frac{4\pi n z^2 e^4}{m_e v^2} \frac{db}{b} dx$$

Diverges for $b \rightarrow 0$; integration only
for relevant range $[b_{\min}, b_{\max}]$:

Bohr 1913

$$-\frac{dE}{dx} = \frac{4\pi n z^2 e^4}{m_e v^2} \cdot \int_{b_{\min}}^{b_{\max}} \frac{db}{b} = \frac{4\pi n z^2 e^4}{m_e v^2} \ln \frac{b_{\max}}{b_{\min}}$$

Bethe-Bloch – Classical Derivation

Bohr 1913

Determination of relevant range [b_{\min} , b_{\max}]:

[Arguments: $b_{\min} > \lambda_e$, i.e. de Broglie wavelength; $b_{\max} < \infty$ due to screening ...]

$$b_{\min} = \lambda_e = \frac{h}{p} = \frac{2\pi\hbar}{\gamma m_e v}$$

Use Heisenberg uncertainty principle or that electron is located within de Broglie wavelength ...

$$b_{\max} = \frac{\gamma v}{\langle \nu_e \rangle}; \quad \left[\gamma = \frac{1}{\sqrt{1-\beta^2}} \right]$$

Interaction time (b/v) must be much shorter than period of the electron (γ/v_e) to guarantee relevant energy transfer ...

[adiabatic invariance]

$$-\frac{dE}{dx} = \frac{4\pi z^2 e^4}{m_e c^2 \beta^2} n \cdot \ln \frac{m_e c^2 \beta^2 \gamma^2}{2\pi\hbar \langle \nu_e \rangle}$$

Deviates by factor 2 from QM derivation

Electron density: $n = N_A \cdot \rho \cdot Z/A$!!
Effective ionization potential: $I \sim h \langle \nu_e \rangle$

Bethe-Bloch Formula

[see e.g. PDG 2010]

$$-\left\langle \frac{dE}{dx} \right\rangle = K z^2 \frac{Z}{A} \frac{1}{\beta^2} \left[\frac{1}{2} \ln \frac{2m_e c^2 \beta^2 \gamma^2 T_{\max}}{I^2} - \beta^2 - \frac{\delta(\beta\gamma)}{2} \right]$$

[· ρ]
density

$$K = 4\pi N_A r_e^2 m_e c^2 = 0.307 \text{ MeV g}^{-1} \text{ cm}^2$$

$$T_{\max} = 2m_e c^2 \beta^2 \gamma^2 / (1 + 2\gamma m_e / M + (m_e / M)^2)$$

[Max. energy transfer in single collision]

$$N_A = 6.022 \cdot 10^{23}$$

[Avogadro's number]

$$r_e = e^2 / 4\pi \epsilon_0 m_e c^2 = 2.8 \text{ fm}$$

[Classical electron radius]

$$m_e = 511 \text{ keV}$$

[Electron mass]

$$\beta = v/c$$

[Velocity]

$$\gamma = (1 - \beta^2)^{-2}$$

[Lorentz factor]

z : Charge of incident particle

M : Mass of incident particle

Z : Charge number of medium

A : Atomic mass of medium

I : Mean excitation energy of medium

δ : Density correction [transv. extension of electric field]

Validity:

$$.05 < \beta\gamma < 500$$

$$M > m_\mu$$

Energy Loss of Charged Particles

Dependence on

Mass A

Charge Z

of target nucleus

Minimum ionization:

ca. $1 - 2 \text{ MeV/g cm}^{-2}$

[H_2 : 4 MeV/g cm^{-2}]

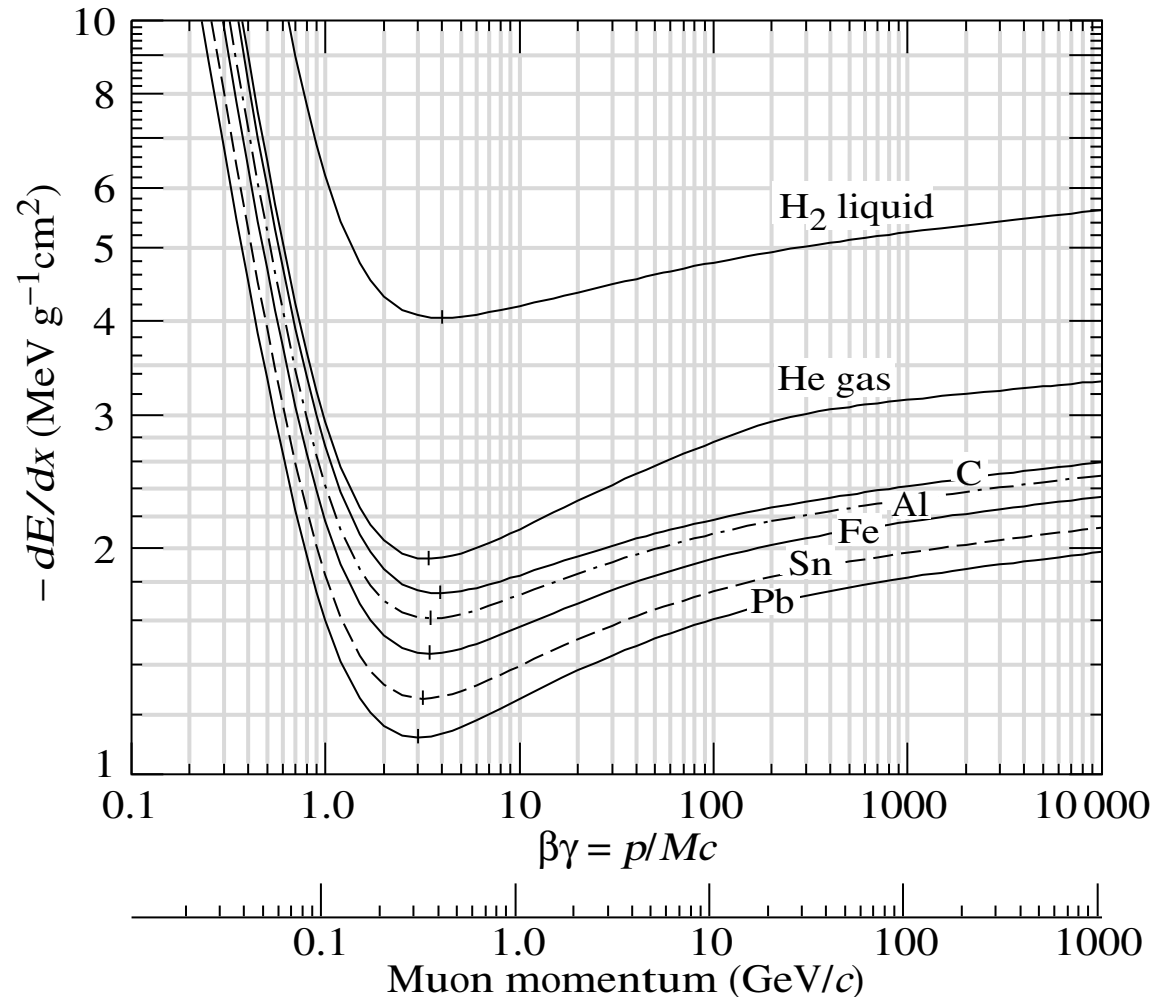

Bremsstrahlung

Bremsstrahlung arises if particles are accelerated in Coulomb field of nucleus

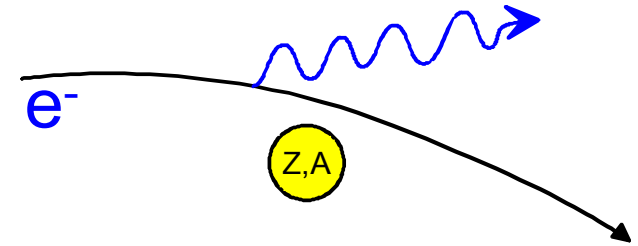

$$\frac{dE}{dx} = 4\alpha N_A \frac{z^2 Z^2}{A} \left(\frac{1}{4\pi\epsilon_0} \frac{e^2}{mc^2} \right)^2 E \ln \frac{183}{Z^{\frac{1}{3}}} \propto \frac{E}{m^2}$$

i.e. energy loss proportional to $1/m^2$ → main relevance for electrons ...
... or ultra-relativistic muons

Consider electrons:

$$\frac{dE}{dx} = 4\alpha N_A \frac{Z^2}{A} r_e^2 \cdot E \ln \frac{183}{Z^{\frac{1}{3}}}$$

$$\frac{dE}{dx} = \frac{E}{X_0} \quad \text{with} \quad X_0 = \frac{A}{4\alpha N_A Z^2 r_e^2 \ln \frac{183}{Z^{\frac{1}{3}}}}$$

[Radiation length in g/cm²]

$$\Rightarrow E = E_0 e^{-x/X_0}$$

After passage of one X_0 electron has lost all but $(1/e)^{\text{th}}$ of its energy

[i.e. 63%]

Total Energy Loss of Electrons

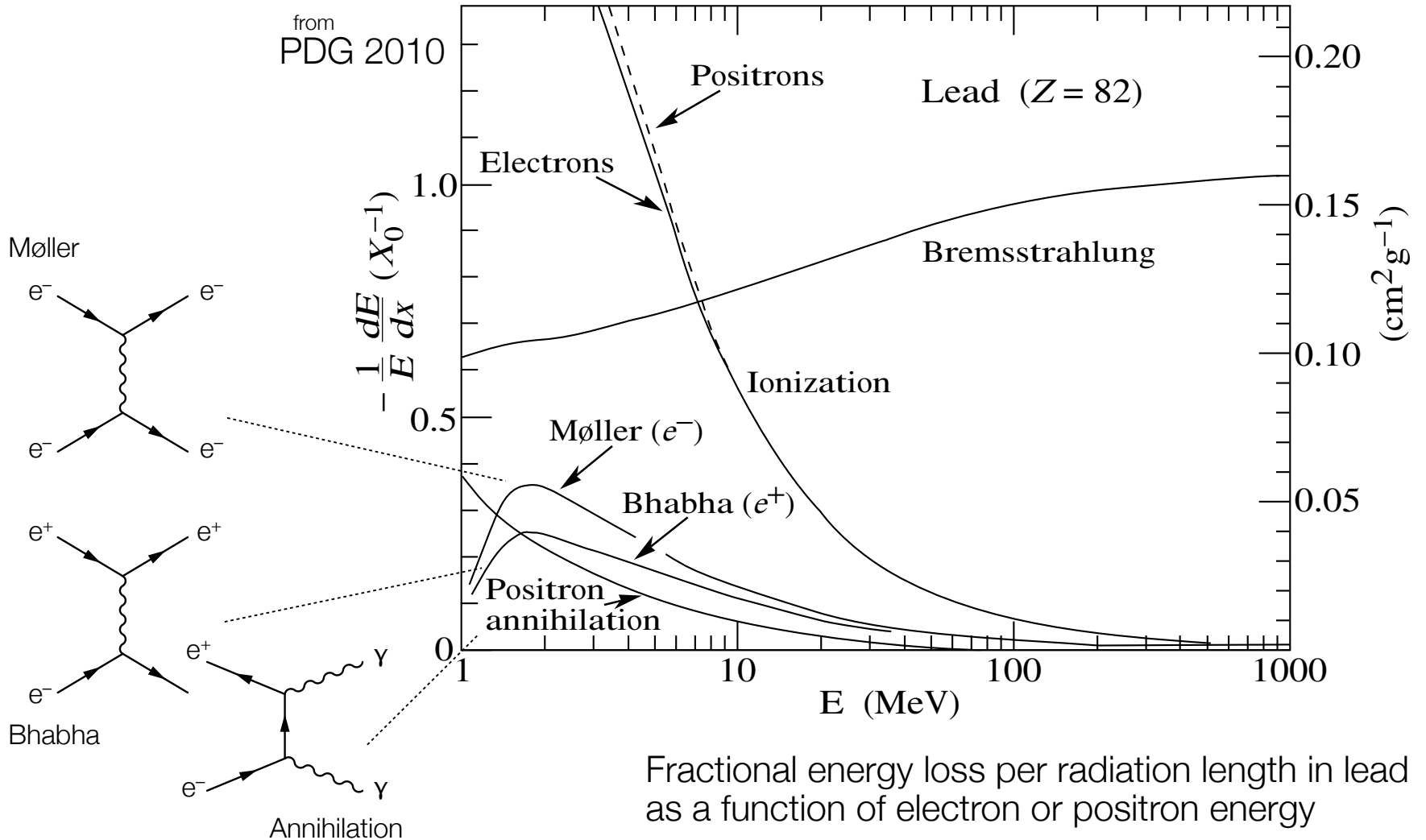

Energy Loss – Summary Plot for Muons

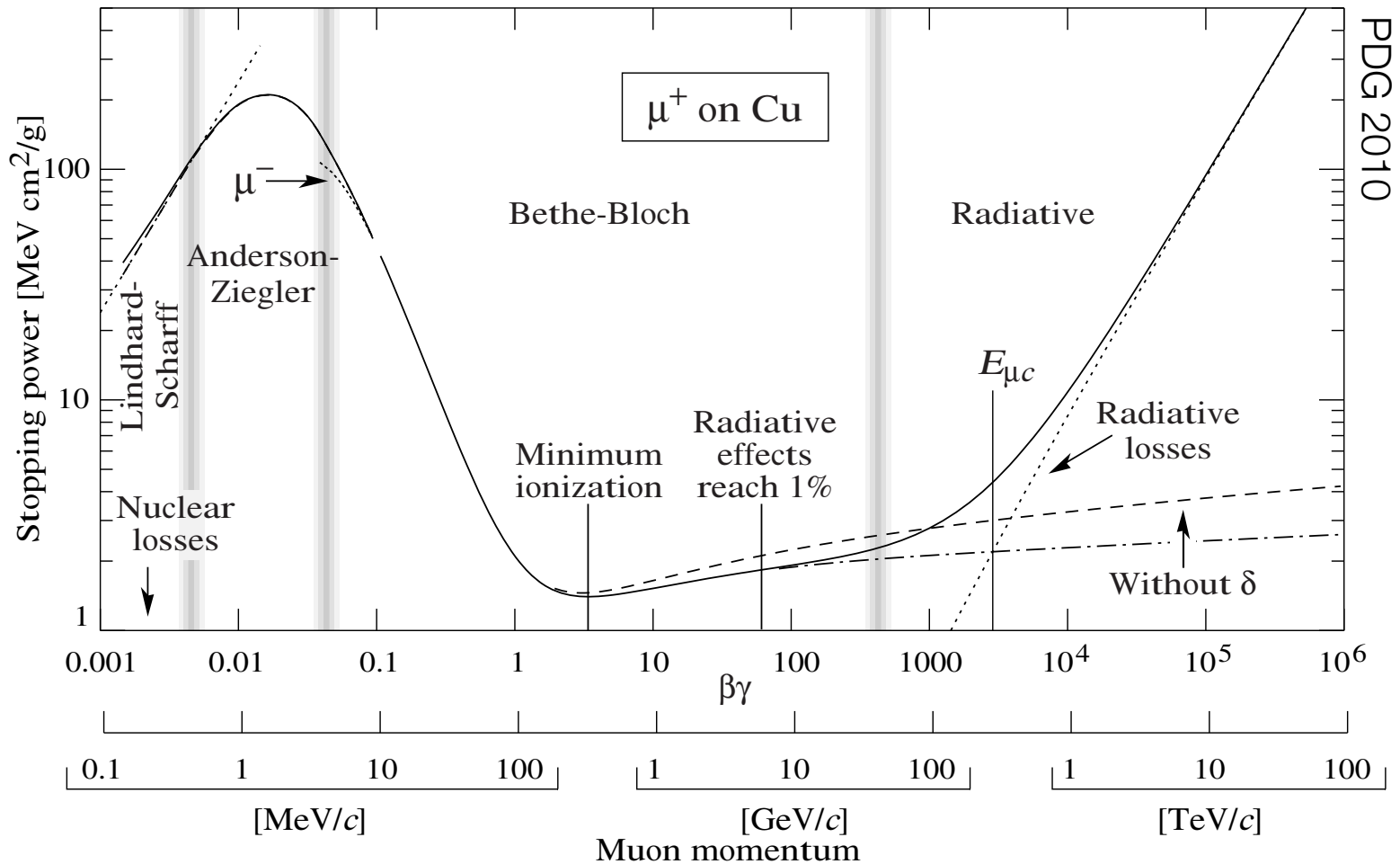

dE/dx and Particle Identification

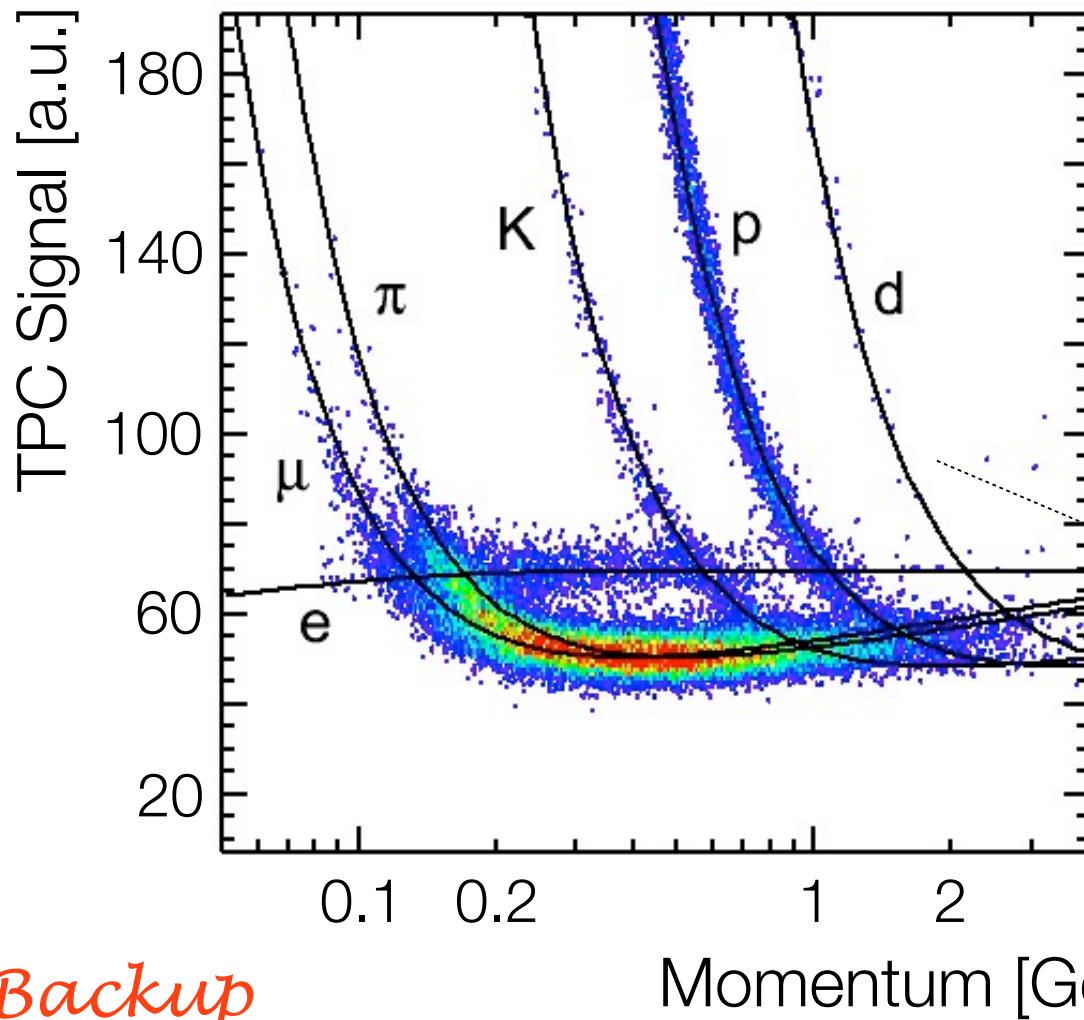

Measured energy loss

[ALICE TPC, 2009]

Bethe-Bloch

Remember:
dE/dx depends on β !

Incoming flux:

$$\Phi = \frac{1}{A} \cdot \frac{\Delta N}{\Delta t} = \frac{\dot{N}_{\text{in}}}{A}$$

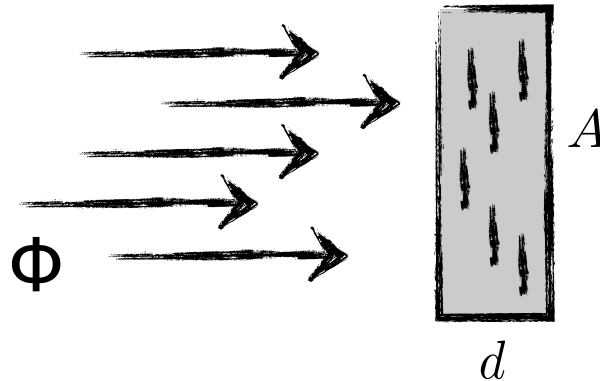

Reaction rate:

$$\begin{aligned} \dot{N}_{\text{reac}} &= \dot{N}_{\text{in}} \frac{A_{\text{tar}}}{A} = \Phi \cdot A_{\text{tar}} \\ &= \Phi \cdot N_{\text{tar}} \cdot \sigma \end{aligned}$$

Absorbing target area

$$\begin{aligned} A_{\text{tar}} &= \sigma \cdot N_{\text{tar}} \\ &= \sigma \cdot \frac{\rho \cdot A d}{m_{\text{mol}}} \cdot N_A \end{aligned}$$

with

- ρ : target density
- m_{mol} : molar mass
- N_A : $6.022 \cdot 10^{23} \text{ mol}^{-1}$

Cross section:

$$\begin{aligned} \sigma &= \frac{\text{Number of reactions (of given type) per unit time}}{\text{Incoming flux} \cdot \text{Number of target particles}} \\ &= \frac{\dot{N}_{\text{reac}}}{\Phi \cdot N_{\text{tar}}} = \frac{\dot{N}_{\text{reac}}}{\dot{N}_{\text{in}} \cdot N_A \cdot \rho \cdot d / m_{\text{mol}}} \end{aligned}$$

Transition rate W_{fi}

Unit: $[\sigma] = \text{cm}^2$

Fermi's Golden Rule

$$W_{fi} = 2\pi |M_{fi}|^2 \cdot \frac{dN}{dE_f}$$

Transition probability

Matrix element

Phase space

4-vector current

Propagator

$$M_{fi} = -i \int j_\mu^{(1)} \cdot \left(\frac{1}{q^2} \right) \cdot j_\mu^{(2)} d^4x$$

$$\begin{aligned} \sigma &\sim |M_{fi}|^2 \\ &\sim g^4 \cdot \left(\frac{1}{q^4} \right) \end{aligned}$$

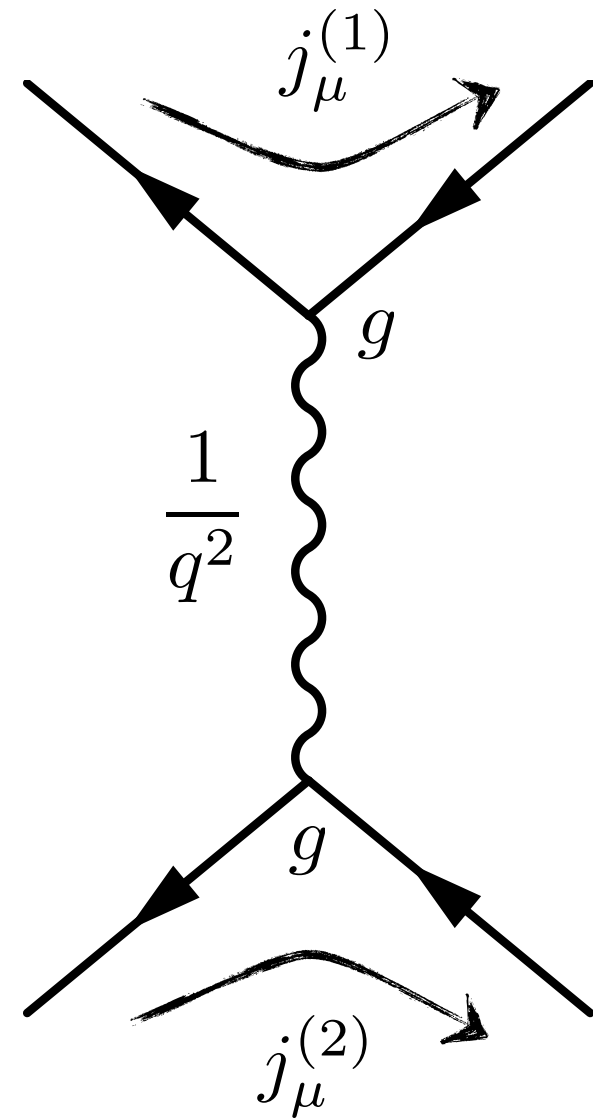

Standard

cross section unit:

$$[\sigma] = \text{mb}$$

with $1 \text{ mb} = 10^{-27} \text{ cm}^2$

or in

natural units:

$$[\sigma] = \text{GeV}^{-2}$$

with $1 \text{ GeV}^{-2} = 0.389 \text{ mb}$

$$1 \text{ mb} = 2.57 \text{ GeV}^{-2}$$

Estimating the
proton-proton cross section:

using: $\hbar c = 0.1973 \text{ GeV fm}$

$$(\hbar c)^2 = 0.389 \text{ GeV}^2 \text{ mb}$$

Proton radius: $R = 0.8 \text{ fm}$

Strong interactions happens up to $b = 2R$

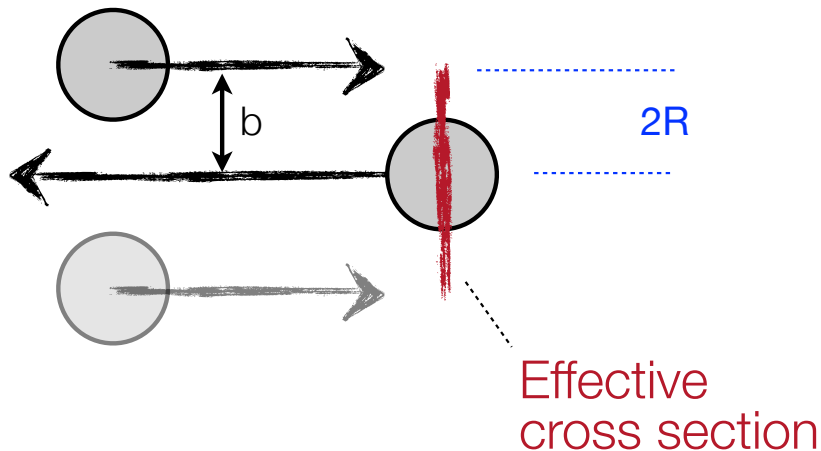

$$\sigma = \pi (2R)^2 = \pi \cdot 1.6^2 \text{ fm}^2$$

$$= \pi \cdot 1.6^2 \cdot 10^{-26} \text{ cm}^2$$

$$= \pi \cdot 1.6^2 \cdot 10 \text{ mb}$$

$$= 80 \text{ mb}$$

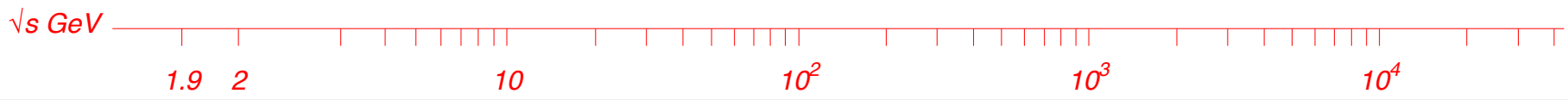
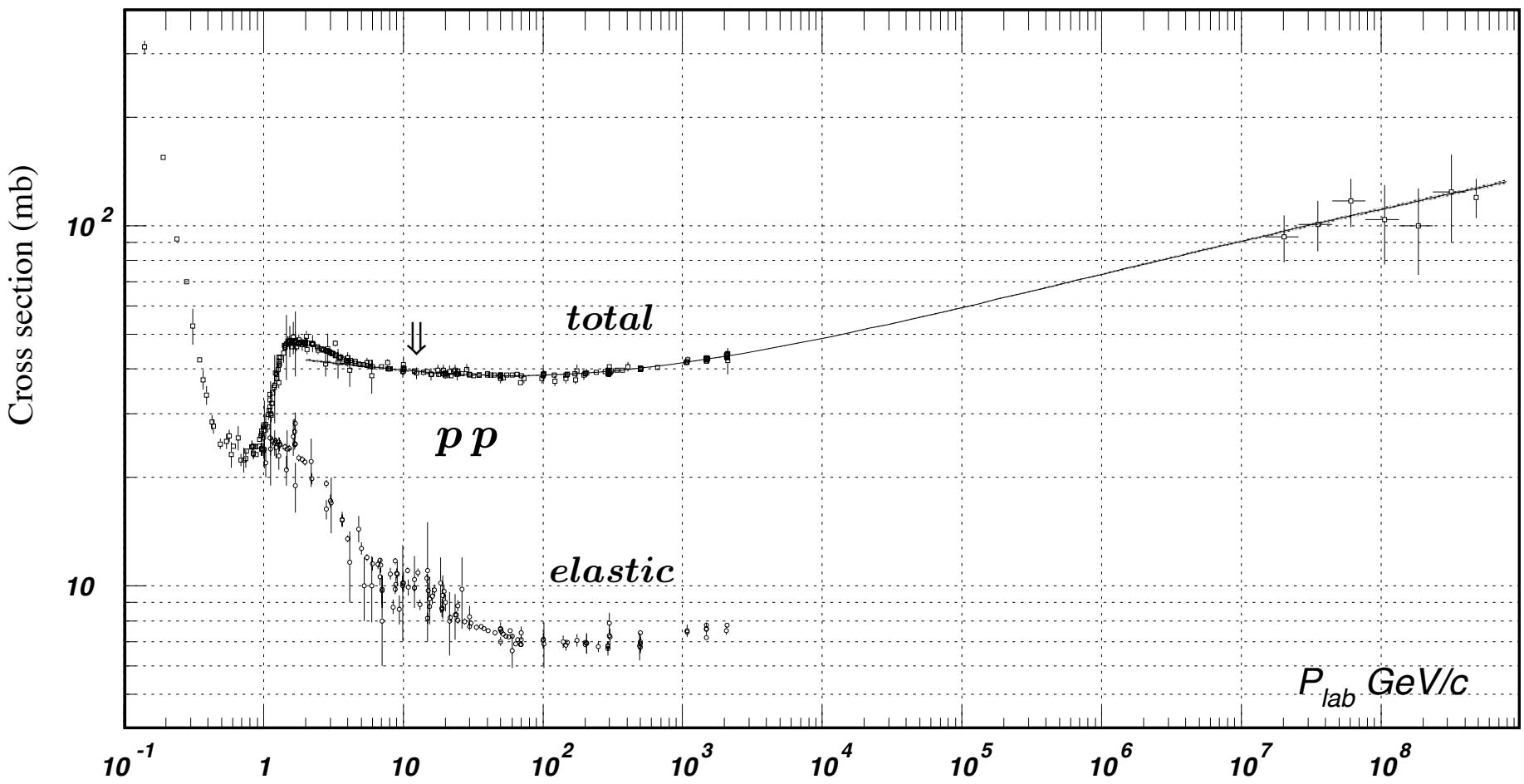

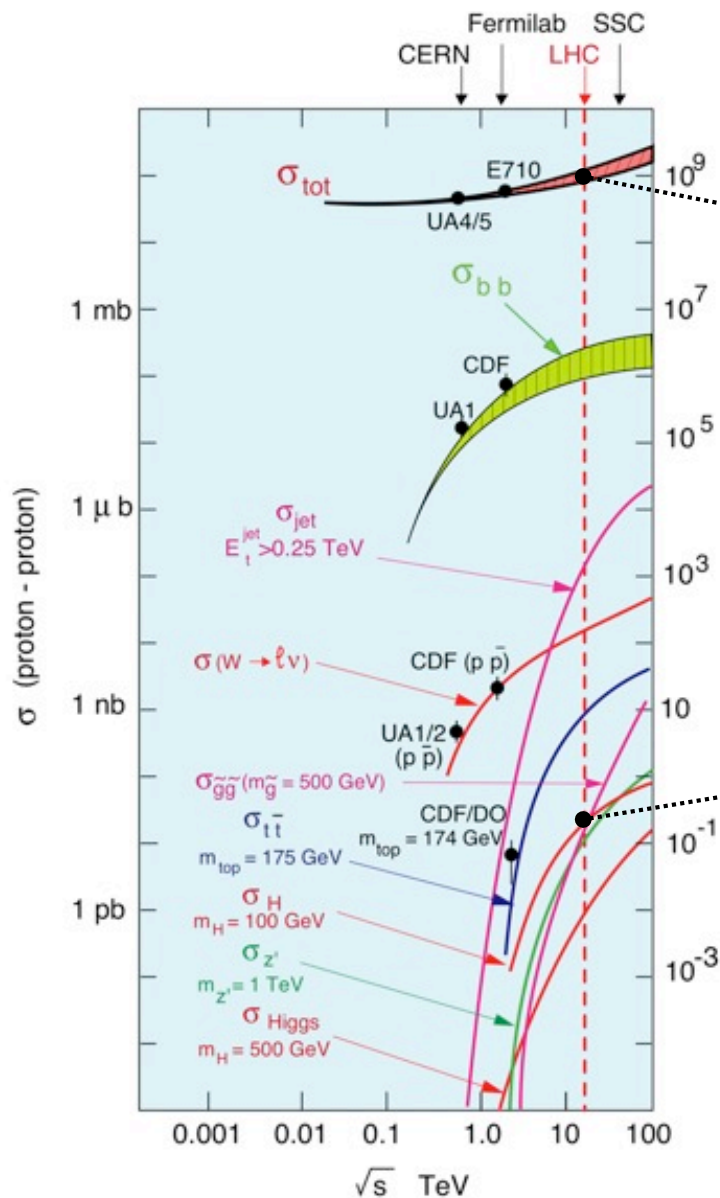

Events / sec for $\mathcal{L} = 10^{34} \text{ cm}^{-2} \text{ sec}^{-1}$

$\sim 10^{10}$

10^9 Events/sec
[1 Mbyte/Event]



Efficient rate reduction needed
[Storage rate: 100 Hz]

10 Events/min
[$m_H \approx 100 \text{ GeV}$]

with 0.2% $H \rightarrow \gamma\gamma$
1.5% $H \rightarrow ZZ$

Trigger !

To Backup

Electromagnetic Shower Development

Detecting a signal:

To Backup

- The contribution of an electromagnetic interaction to energy loss usually depends on the energy of the incident particle and on the properties of the absorber
- At “high energies” ($> \sim 10 \text{ MeV}$):
 - electrons lose energy mostly via Bremsstrahlung
 - photons via pair production
- Photons from Bremsstrahlung can create an electron-positron pair which can radiate new photons via Bremsstrahlung in a process that last as long as the electron (positron) has energy $E > E_c$
- At energies $E < E_c$, energy loss mostly by ionization and excitation
- Signals in the form of light or ions are collected by some readout system

Building a detector

- X_0 and E_c depends on the properties of the absorber material
- Full EM shower containment depends on the geometry of the detector

Electromagnetic Shower Development

A simple shower model (Rossi-Heitler)

B. Rossi, High Energy Particles, New York, Prentice-Hall (1952)

W. Heitler, The Quantum Theory of Radiation, Oxford, Clarendon Press (1953)

Considerations:

- Photons from bremsstrahlung and electron-positron from pair production produced at angles $\theta = mc^2/E$ (E is the energy of the incident particle) → **jet character**

Assumptions:

- $\lambda_{pair} \approx X_0$
- Electrons and positrons behave identically
- Neglect energy loss by ionization or excitation for $E > E_c$
- Each electron with $E > E_c$ gives up half of its energy to bremsstrahlung photon after $1X_0$
- Each photon with $E > E_c$ undergoes pair creation after $1X_0$ with each created particle receiving half of the photon energy
- Shower development stops at $E = E_c$
- Electrons with $E < E_c$ do not radiate → remaining energy lost by collisions

14

Electromagnetic Shower Development

A simple shower model

Shower development:

Start with an electron with $E_0 \gg E_c$

→ After $1X_0$: 1 e^- and 1 γ , each with $E_0/2$

→ After $2X_0$: 2 e^- , 1 e^+ and 1 γ , each with $E_0/4$

→ After tX_0 :

$$N(t) = 2^t = e^{t \ln 2}$$

$$E(t) = \frac{E_0}{2^t}$$

→ Number of particles increases exponentially with t
 → equal number of e^+ , e^- , γ

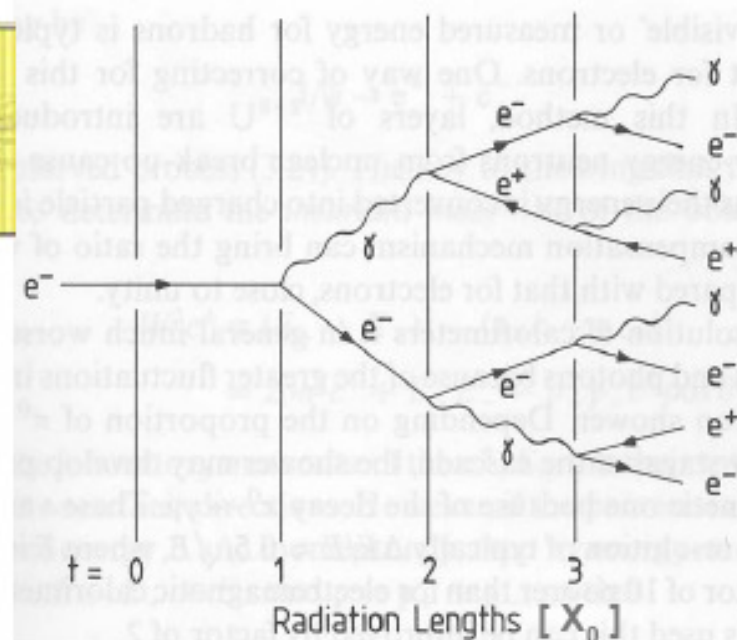
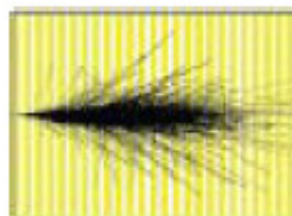

$$t(E') = \frac{\ln(E_0/E')}{\ln 2}$$

$$N(E > E') = \frac{1}{\ln 2} \frac{E_0}{E'}$$

→ Depth at which the energy of a shower particle equals some value E'

→ Number of particles in the shower with energy $> E'$

Maximum number of particles reached at $E = E_c \rightarrow$

$$t_{\max} = \frac{\ln(E_0/E_c)}{\ln 2}$$

$$N_{\max} = e^{t_{\max} \ln 2} = E_0/E_c$$

Electromagnetic Shower Development

A simple shower model

Concepts introduced with this simple model:

- Maximum development of the shower (multiplicity) at t_{\max}
- Logarithmic growth of t_{\max} with E_0 :
 - implication in the calorimeter longitudinal dimensions
- Linearity between E_0 and the number of particles in the shower

Electromagnetic Shower Development

A simple shower model

What about the energy measurement?

Assuming, say, energy loss by ionization

→ Counting charges:

→ Total number of particles in the shower:

$$N_{all} = \sum_{t=0}^{t_{max}} 2^t = 2 \times 2^{t_{max}} - 1 \approx 2 \times 2^{t_{max}} = 2 \frac{E_0}{E_c}$$

→ Total number of charge particles (e^+ and e^- contribute with 2/3 and γ with 1/3)

$$N_{e^+e^-} = \frac{2}{3} \times 2 \frac{E_0}{E_c} = \frac{4}{3} \frac{E_0}{E_c}$$

→ Measured energy proportional to E_0

Electromagnetic Shower Development

A simple shower model

What about the energy resolution?

Assuming Poisson distribution for the shower statistical process:

$$\frac{\sigma(E)}{E} = \frac{1}{\sqrt{N_{e^+e^-}}} = \frac{\sqrt{3E_c}/2}{\sqrt{E}}$$
$$\frac{\sigma(E)}{E} \propto \frac{1}{\sqrt{E}}$$

Resolution improves with E

Example: For lead (Pb), $E_c \approx 6.9$ MeV:

$$\frac{\sigma(E)}{E} = \frac{7.2\%}{\sqrt{E [GeV]}}$$

More general term:

$$\frac{\sigma(E)}{E} = \frac{a}{\sqrt{E}} \oplus b \oplus \frac{c}{E}$$

Noise, etc

Statistic fluctuations

Constant term
(calibration, non-linearity, etc)

Electromagnetic Shower Development

A simple shower model

Simulation of the energy deposit in copper as a function of the shower depth for incident electrons at 4 different energies showing the logarithmic dependence of t_{\max} with E .

EGS4* (electron-gamma shower simulation)

*EGS4 is a Monte Carlo code for doing simulations of the transport of electrons and photons in arbitrary geometries.

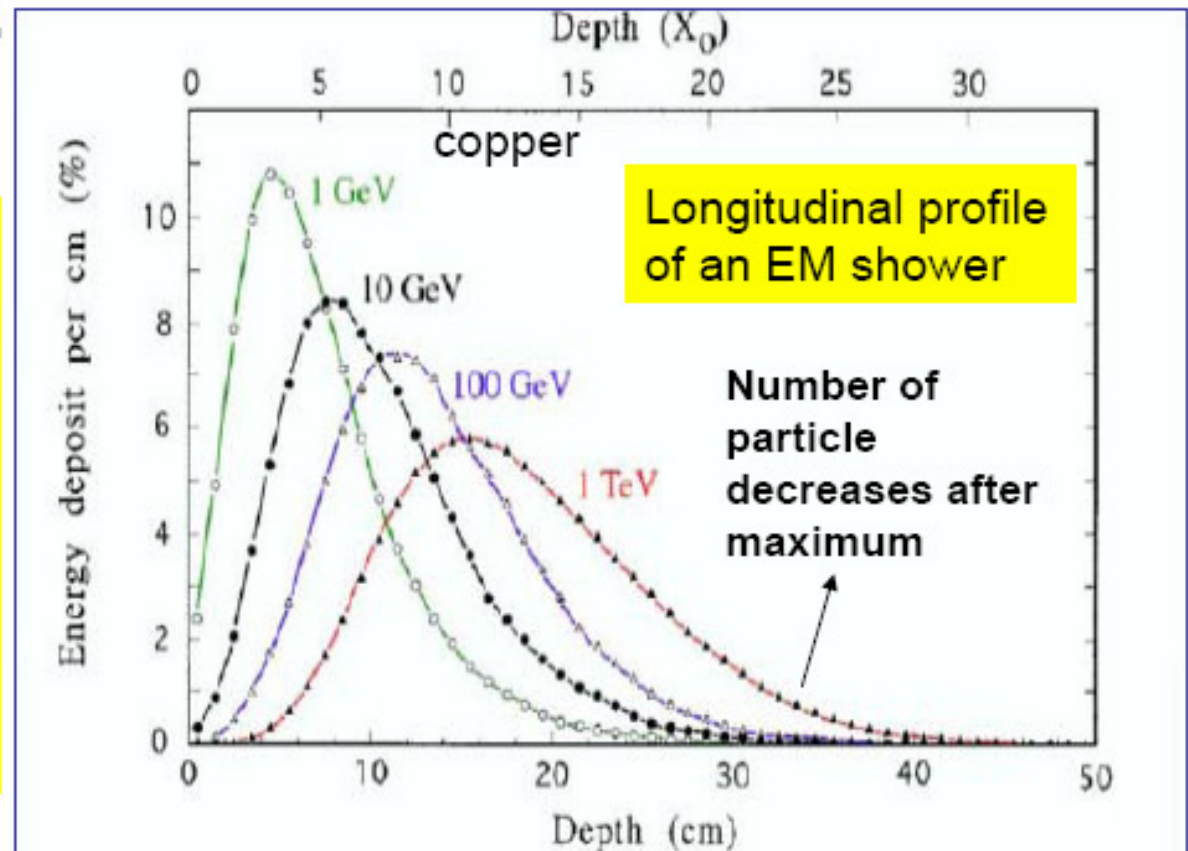

FIG. 2.9. The energy deposit as a function of depth, for 1, 10, 100 and 1000 GeV electron showers developing in a block of copper. In order to compare the energy deposit profiles, the integrals of these curves have been normalized to the same value. The vertical scale gives the energy deposit per cm of copper, as a percentage of the energy of the showering particle. Results of EGS4 calculations.

Electromagnetic Shower Development

Shower Profile

- Longitudinal development governed by the radiation length X_0
- Lateral spread due to electron undergoing multiple Coulomb scattering:
 - About **90%** of the shower up to the shower maximum is contained in a cylinder of radius $< 1X_0$
 - Beyond this point, electrons are increasingly affected by multiple scattering
 - Lateral width scales with the **Molière radius** ρ_M

$$\rho_M = X_0 \frac{E_s}{E_c} \left[\text{g/cm}^2 \right], \quad E_s \approx 21 \text{ MeV}$$

95% of the shower is contained laterally in a cylinder with radius $2\rho_M$

Electromagnetic Shower Development

Shower profile

From previous slide, one expects the longitudinal and transverse developments to scale with X_0

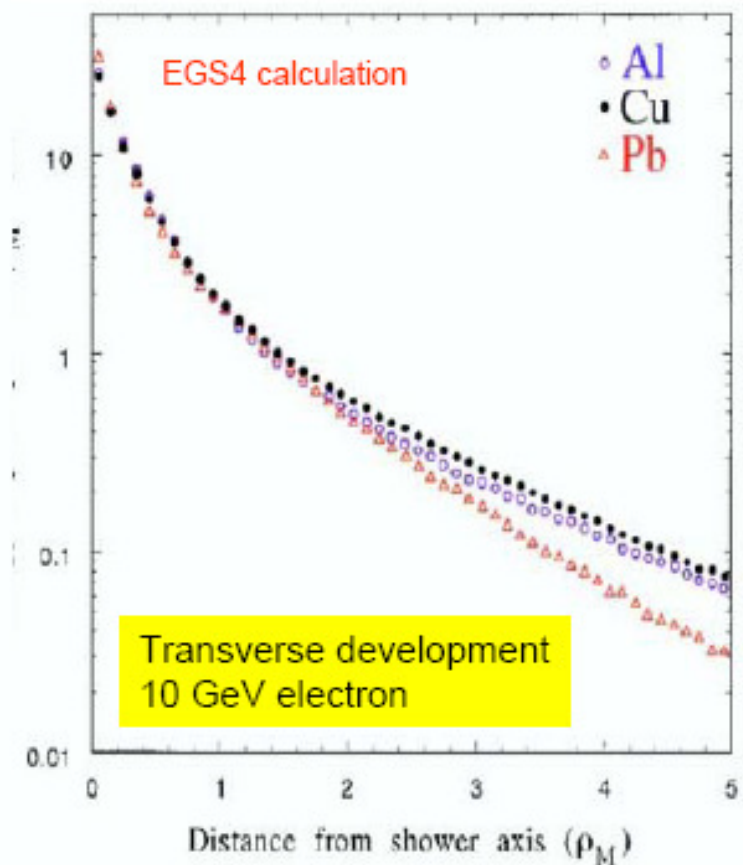
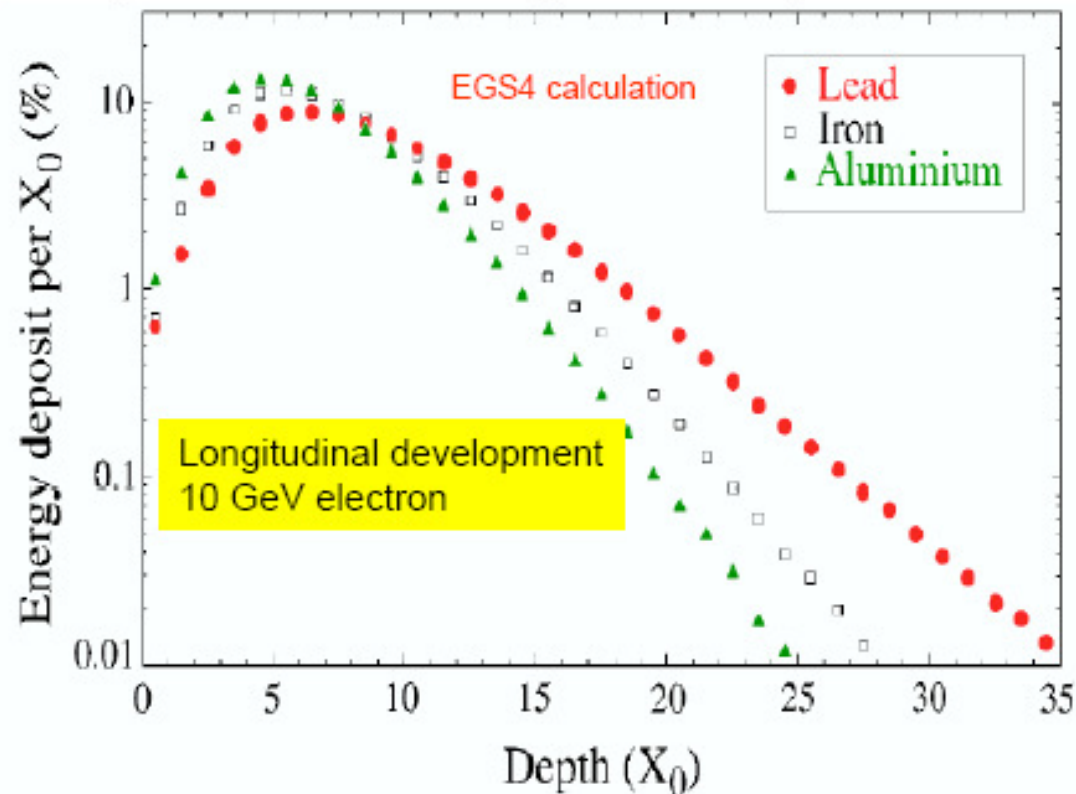

→ ρ_M less dependent on Z than X_0 :

$$X_0 \propto A/Z^2, \quad E_c \propto 1/Z \Rightarrow \rho_M \propto A/Z$$

Electromagnetic Shower Development

Energy deposition

The fate of a shower is to develop, reach a maximum, and then decrease in number of particles once $E_0 < E_c$

Given that several processes compete for energy deposition at low energies, it is important to understand how the fate of the particles in a shower.

→ Most of energy deposition by low energy e^\pm 's.

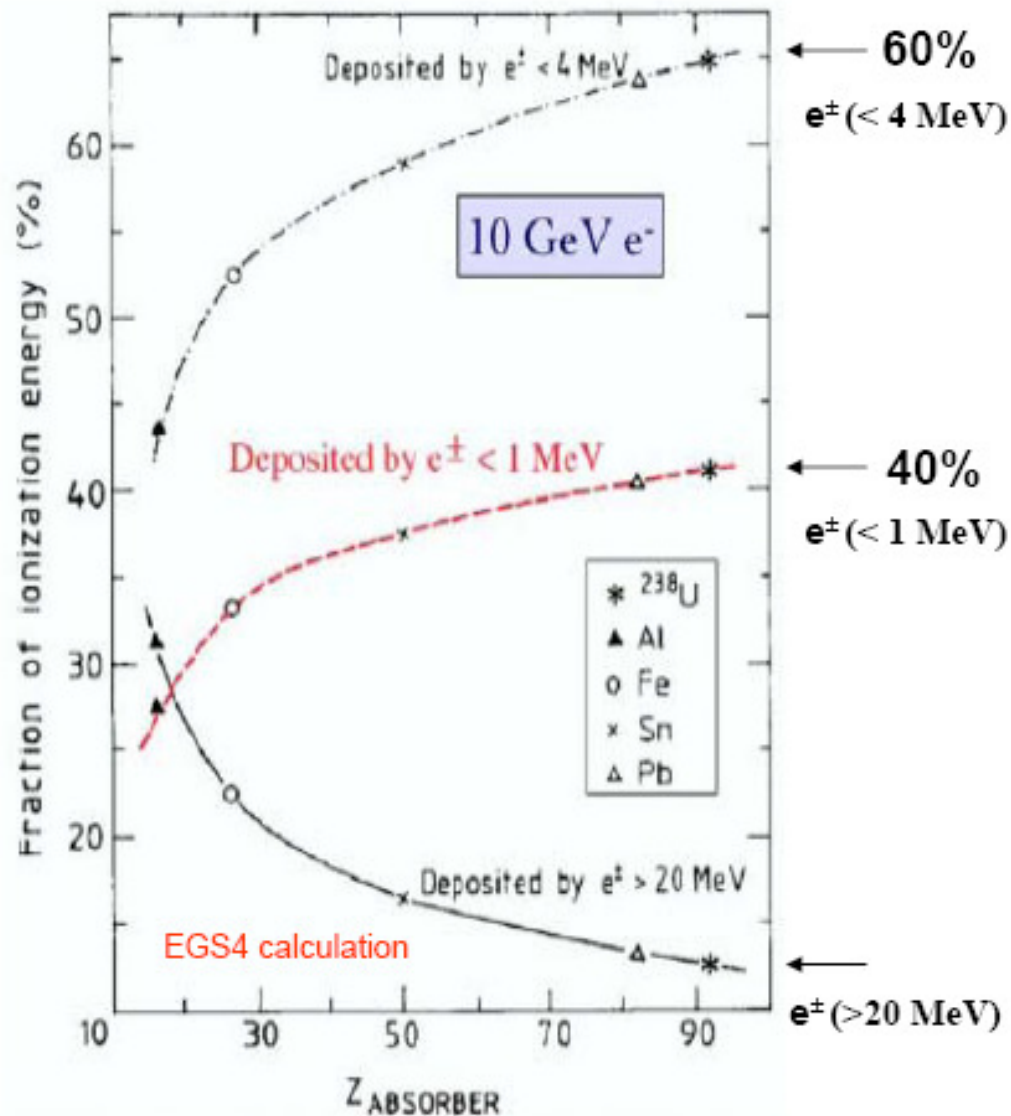
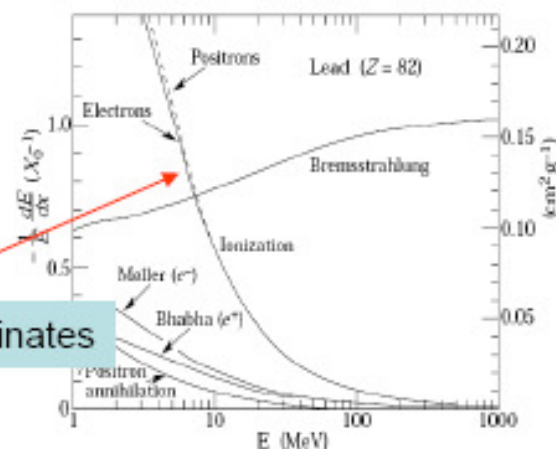

To Backup

Diffusion in gases (no E-field)

To Backup

- * In absence of other effects, at thermal energies, the mean speed of the charges (given by the Maxwell distribution of the energies) is:

$$v = \sqrt{\frac{8kT}{\pi m}} \quad \text{where } k \text{ is Boltzmann's constant, } T \text{ the temperature and } m \text{ the mass of the particle}$$

- * The charges diffuse by multiple collisions, and a local distribution follows a Gaussian law:

$$\frac{dN}{dx} = \frac{N_0}{\sqrt{4\pi Dt}} \exp\left(-\frac{x^2}{4Dt}\right) \quad \text{where } N_0 \text{ is the total number of charges, } x \text{ the distance from the point of creation and } D \text{ the diffusion coefficient}$$

- * Then the linear and volume r.m.s. of the spread are:

$$\sigma_x = \sqrt{2Dt}$$
$$\sigma_v = \sqrt{6Dt}$$

For instance, the radial spread of ions in air in normal conditions is about 1 mm after 1 second

Drift and mobility in gas

- * In the presence of an electric field, electrons and ions will drift in the gas. The drift velocity for electrons can be much higher w.r.t. ions since they are much lighter.
- * $\mu = v/E$ is the mobility of a charge where v is the drift velocity and E the electric field.
- * Ions :
 - Mean velocity v^+ is proportional to E/P
 - Mobility μ^+ is constant (average energy of ions almost unmodified up to very high electric fields)
- * Electrons:
 - Drift velocity $v^- = (e/2m).E.\tau$ where τ is the mean time between collision
 - Typical value around 5 cm/ μ s are obtained (ions thousand times slower)

Electrons drift and diffusion

Drift velocity and diffusion of electrons vary in a wide range, depending the gas mixture.

Relation between mobility and diffusion: $\frac{D}{\mu} = \frac{kT}{e} \approx 0.026 \text{ eV}$

The minimum diffusion at a given field is given by the thermal value: $\sigma_x = \sqrt{\frac{2kT}{e} \frac{x}{E}}$

Drift velocity:

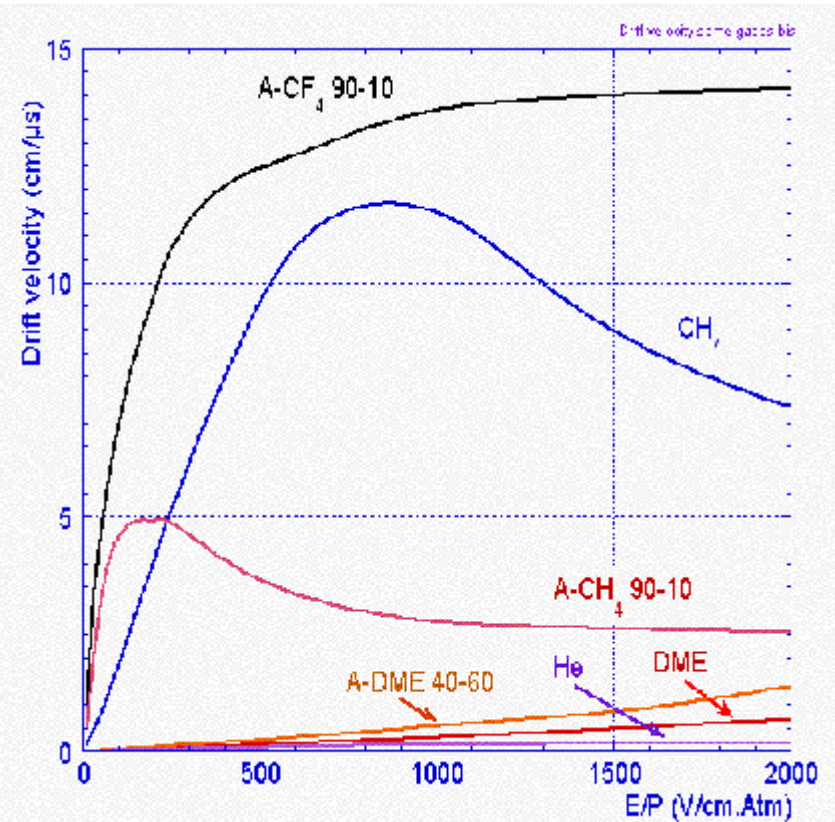

Diffusion:

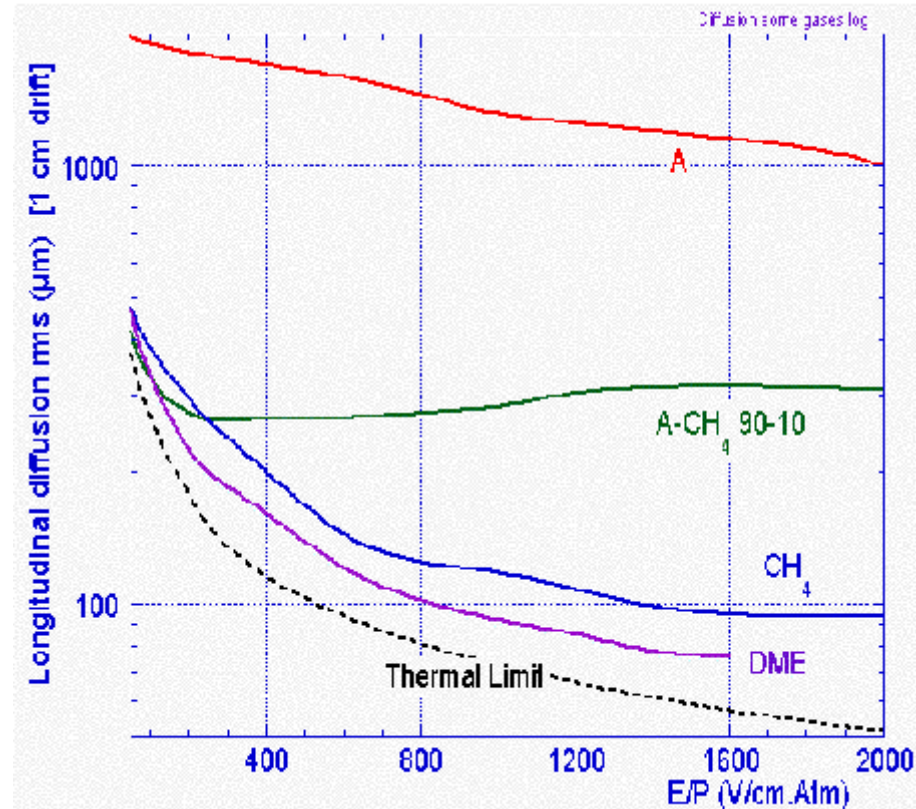

Magnetic field

The drifting electrons cloud is rotated by an angle θ_B in the plane perpendicular to E and B .

$$\vec{E} \perp \vec{B}$$

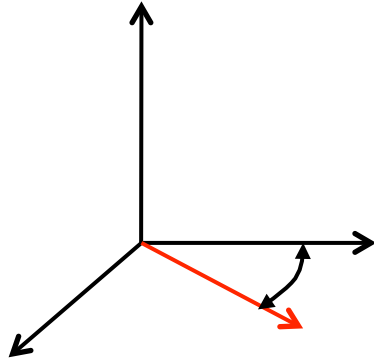

$$\tan \theta_B = \omega \tau$$

τ : mean collision time

$$v_B = \frac{E}{B} \frac{\omega \tau}{\sqrt{1 + \omega^2 \tau^2}}$$

$\omega = eB/m \rightarrow$ Larmor frequency

$$\vec{E} \parallel \vec{B}$$

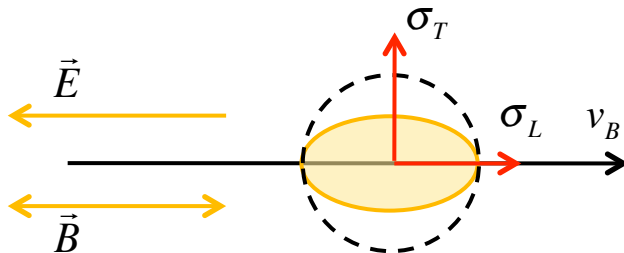

$$v_B = v_0$$

$$\sigma_L = \sigma_0$$

Drift velocity unchanged

$$\sigma_T = \frac{\sigma_0}{\sqrt{1 + \omega^2 \tau^2}}$$

Transverse diffusion is reduced

Transverse diffusion in magnetic field

In some gases the transverse diffusion is strongly reduced

→ improves the precision of the projected coordinate measurement in Time Projection Chambers

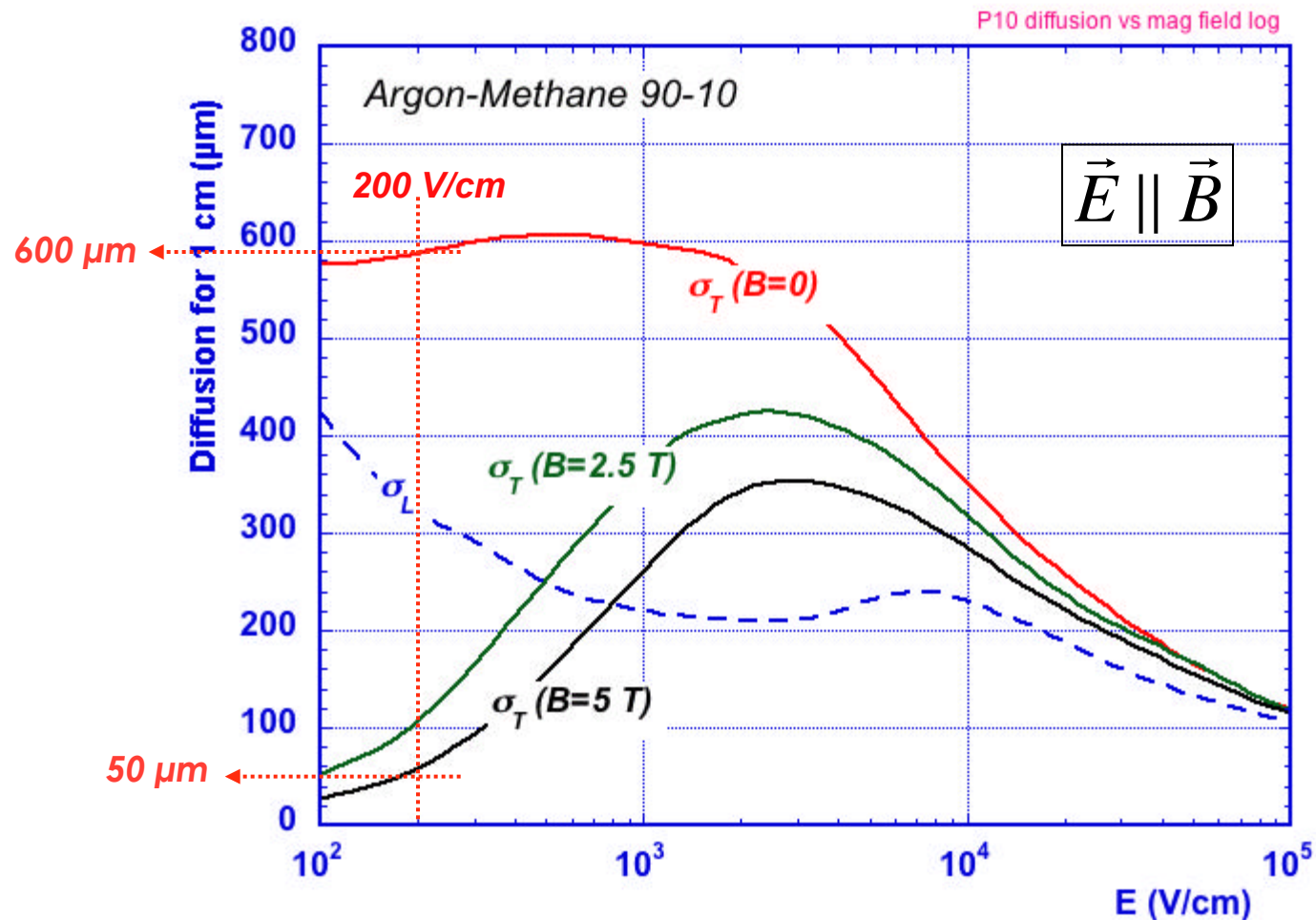

Avalanche phenomenon

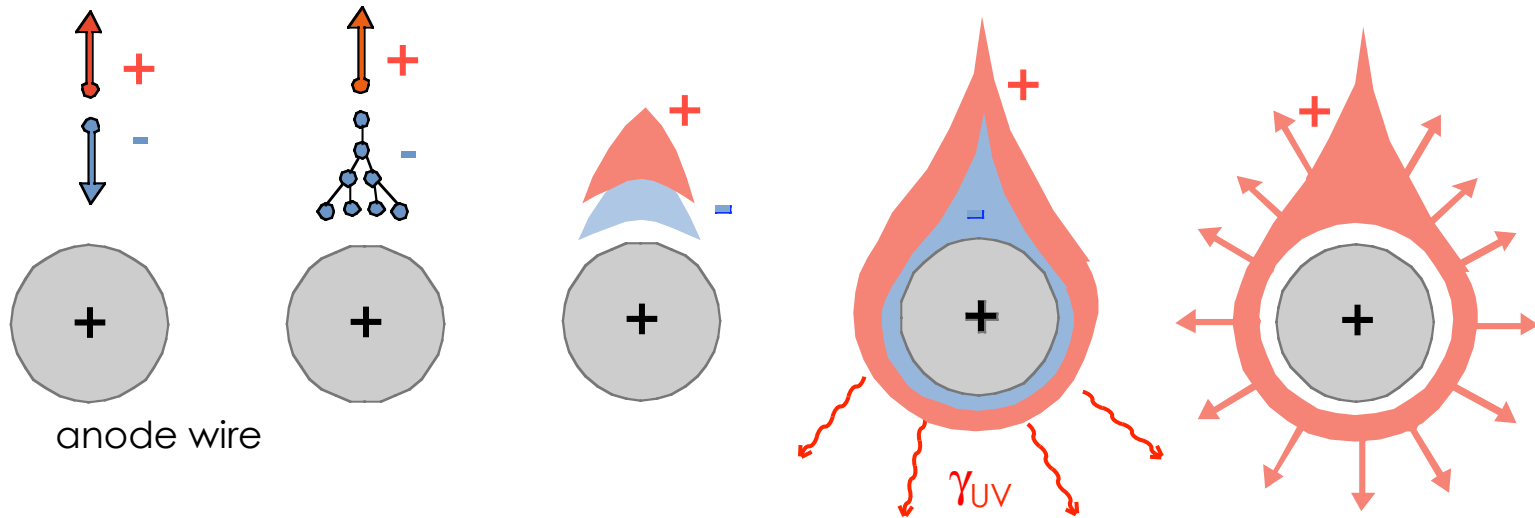

- * One electron drifts towards the anode wire:
 - Electric field is increasing
 - Ionizing collisions \rightarrow pair multiplication
- * Due to lateral diffusion and difference of velocity of electrons-ions, a drop-like avalanche develops near the wire
- * UV photons are emitted \rightarrow risk of uncontrolled amplification (spark)
- * Electrons are collected in a very short time (few ns) and ions drift slowly towards the cathode

Charge multiplication

- * $\alpha = 1/\lambda$ is the probability of ionization per unit length with λ the mean free path of the electron for a secondary ionizing collision
- * For n electrons, there will be $dn = n\alpha dx$ new electrons created in a path dx
- * Then $n = n_0 e^{\alpha x}$ with α : first Townsend coefficient
- * And we can define a multiplication factor M :

$$M = \frac{n}{n_0} = \exp\left[\int_{r_1}^{r_2} \alpha(x) dx\right] \quad \alpha \text{ is a function of } x \text{ (non uniform electric fields)}$$

- * Limitation of M : above 10^8 , sparks occur (Raether limit)
- * Calculating α (or gas gain) for different gases (model by Rose and Korff):

$$\frac{\alpha}{p} = A \exp\left(\frac{-Bp}{E}\right) \quad \text{where } A \text{ and } B \text{ depend on the gas}$$

To Backup

Particle ID

Distinguishing Particles

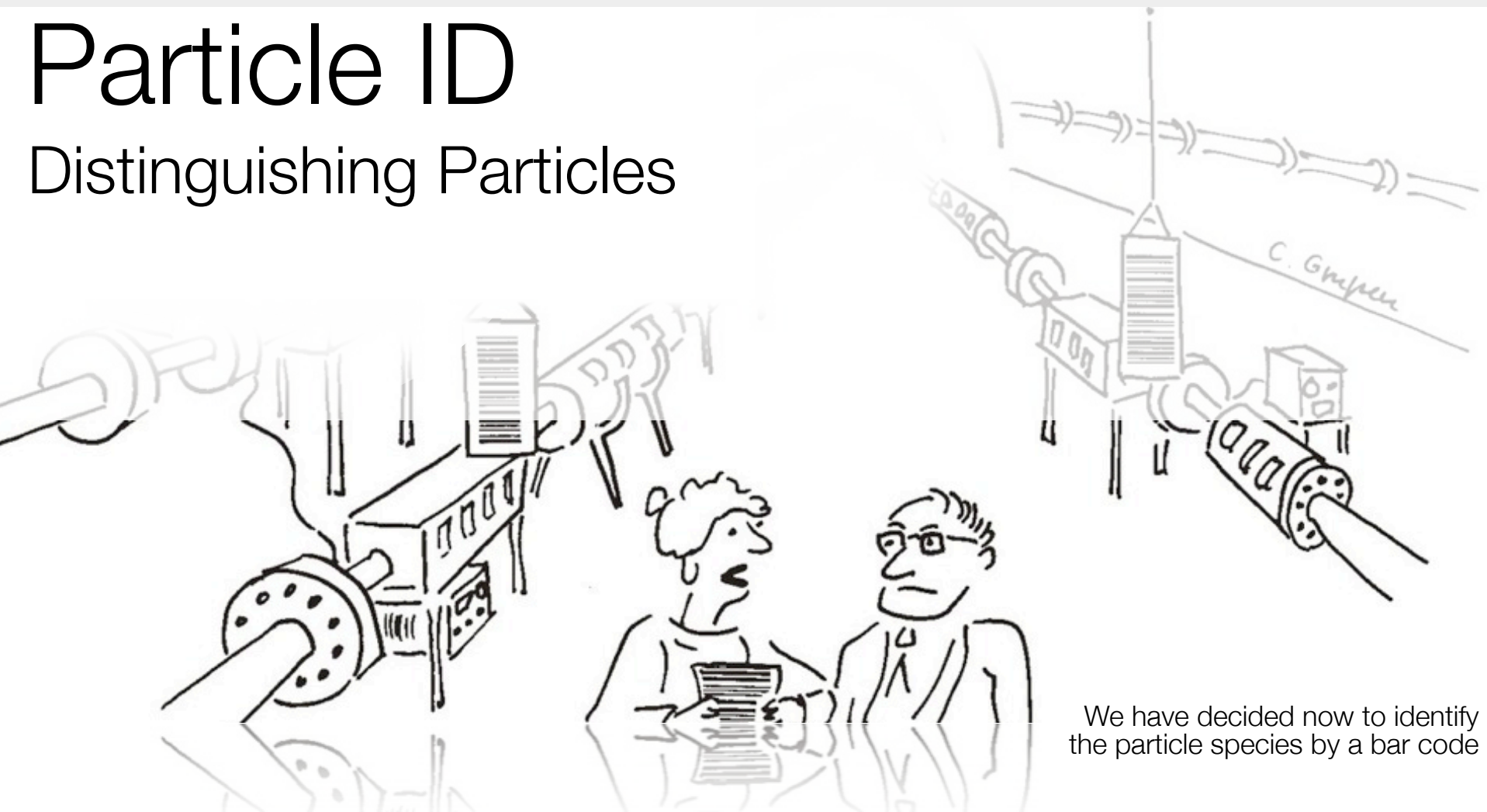

We have decided now to identify the particle species by a bar code

HEP detector: Measures particle momenta ...
by means of a spectrometer (tracker and magnetic field)

With p , γ , β calculate
particle mass m_0 ...

Need second observable
to identify particle type:

$$p = \gamma m_0 \beta c$$

Velocity:

Time-of flight

Cherenkov angle

Transition radiation

$$\tau \propto 1/\beta$$

$$\cos \theta = 1/\beta n$$

$$\gamma \geq 1000$$

γ, β

Energy loss:

Bethe-Bloch

$$\frac{dE}{dx} \propto \frac{z^2}{\beta^2} \ln(a\beta\gamma)$$

Total energy:

Calorimeter

$$E = \gamma m_0 c^2$$

Special signatures for neutrals:

- Photons : Total energy deposited in electromagnetic shower; use energy measurement, shower shape and information on neutrality (e.g. no track) ...
- Neutrons : Energy in calorimeter or scintillator (Li, B, ^3He) and information on neutrality (e.g. no track) ...
- K_0 , Λ , ... : Reconstruction of invariant masses ...
- Neutrinos : Identify products of charged and neutral current interactions ...

Muons:

Minimum ionizing particles; penetrates thick absorbers; measure signal behind complete detector ...

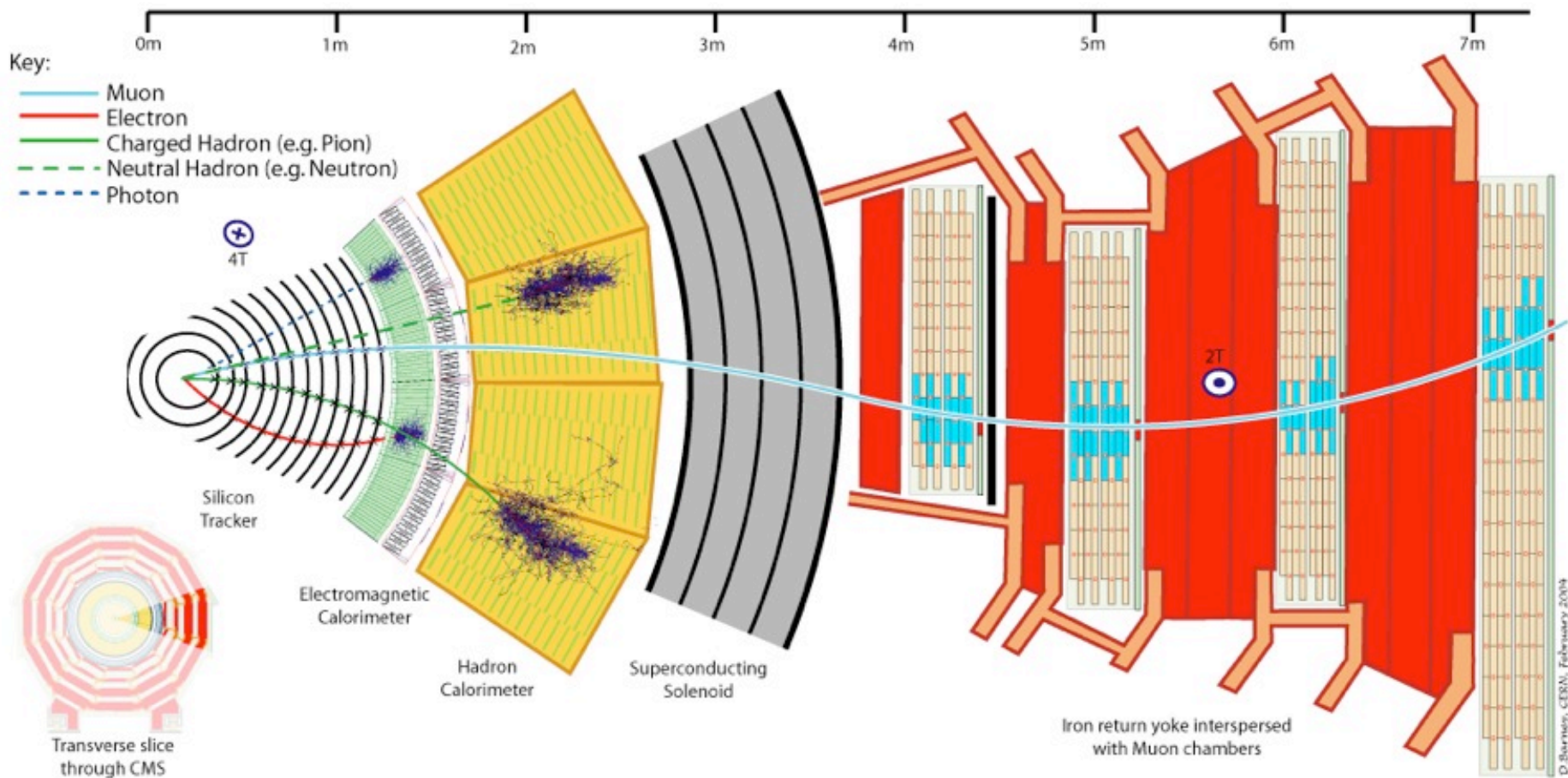

Particle ID [CMS Detector Slice]

Basic idea:

Measure signal time difference between two detectors with good time resolution
 [start and stop counter; also: beam-timing & stop counter]

Typical detectors:

- Scintillation counter
- Resistive Plate Chamber (RPC)

Coincidence setup or TDC measurement with common start/stop from interaction time

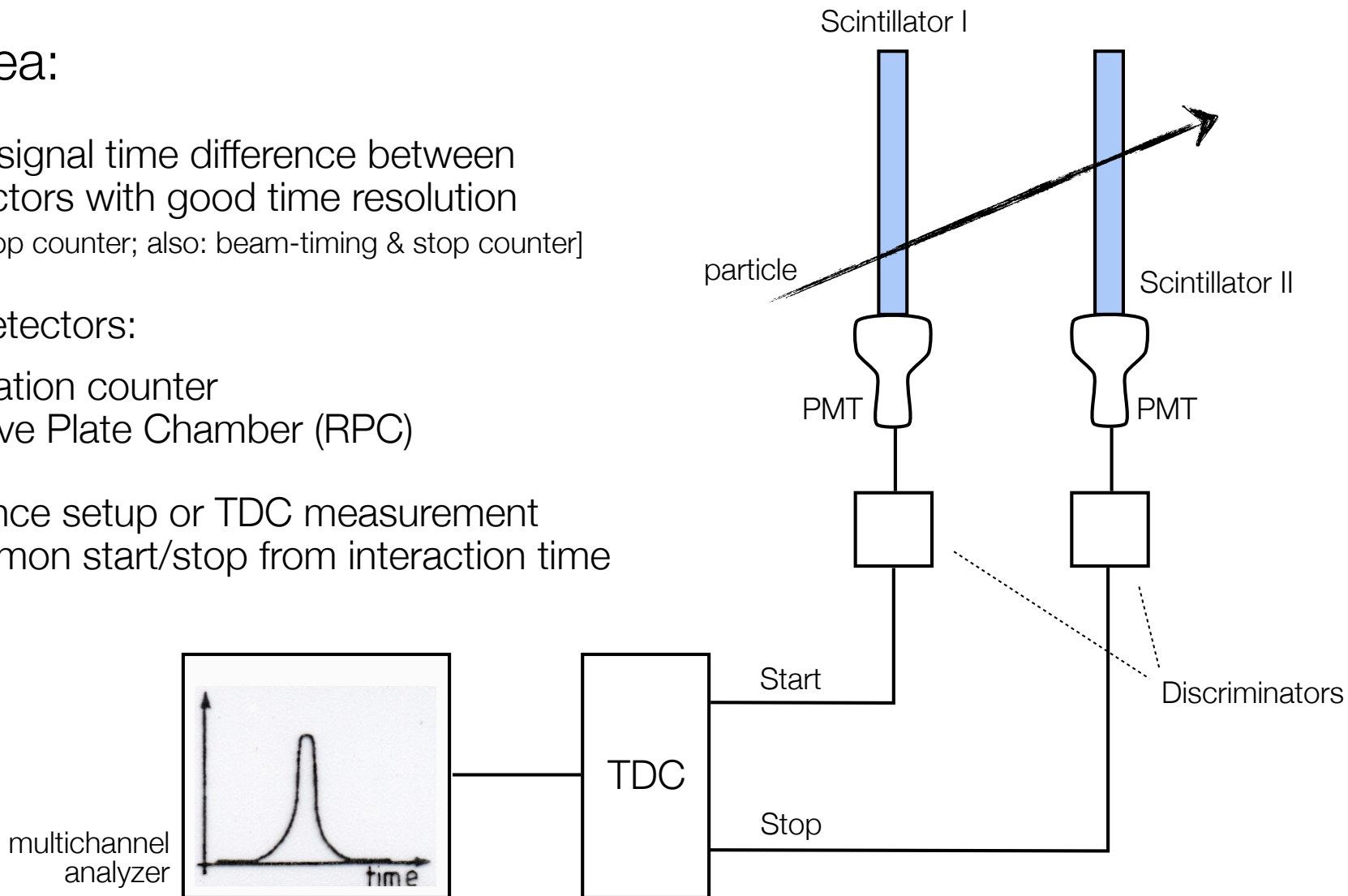

Distinguishing particles with ToF:

[particles have same momentum p]

Particle 1 : velocity v_1 , β_1 ; mass m_1 , energy E_1

Particle 2 : velocity v_2 , β_2 ; mass m_2 , energy E_2

Distance L : distance between ToF counters

$$\Delta t = L \left(\frac{1}{v_1} - \frac{1}{v_2} \right) = \frac{L}{c} \left(\frac{1}{\beta_1} - \frac{1}{\beta_2} \right)$$

$$= \frac{L}{pc^2} (E_1 - E_2) = \frac{L}{pc^2} \left(\sqrt{p^2 c^2 + m_1^2 c^4} - \sqrt{p^2 c^2 + m_2^2 c^4} \right)$$

Relativistic particles, $E \simeq pc \gg m_i c^2$:

$$\Delta t \approx \frac{L}{pc^2} \left[\left(pc + \frac{m_1^2 c^4}{2pc} \right) - \left(pc + \frac{m_2^2 c^4}{2pc} \right) \right]$$

$$\Delta t = \frac{Lc}{2p^2} (m_1^2 - m_2^2)$$

For $L = 2$ m:

Requiring $\Delta t \geq 4\sigma_t$ K/ π separation possible up to $p = 1$ GeV if $\sigma_t \approx 200$ ps ...

Cherenkov counter, RPC : $\sigma_t \approx 40$ ps ...

Scintillator counter : $\sigma_t \approx 80$ ps ...

Example:

Pion/Kaon separation ...
 [$m_K \approx 500$ MeV, $m_\pi \approx 140$ MeV]

Assume:

$p = 1$ GeV, $L = 2$ m ...

$$\rightarrow \Delta t \approx \frac{2 \text{ m} \cdot c}{2 (1000)^2 \text{ MeV}^2 / c^2} (500^2 - 140^2) \text{ MeV}^2 / c^4$$

$$\approx 800 \text{ ps}$$

Use relativistic rise of dE/dx
for particle identification ...

Key problem: Landau fluctuations

Need to make many dE/dx measurements
and truncate large energy-loss values ...

[determination of 'truncated mean']

Energy loss distribution;
50 GeV pions and kaons ...
[1 cm layer Ar/Methane]

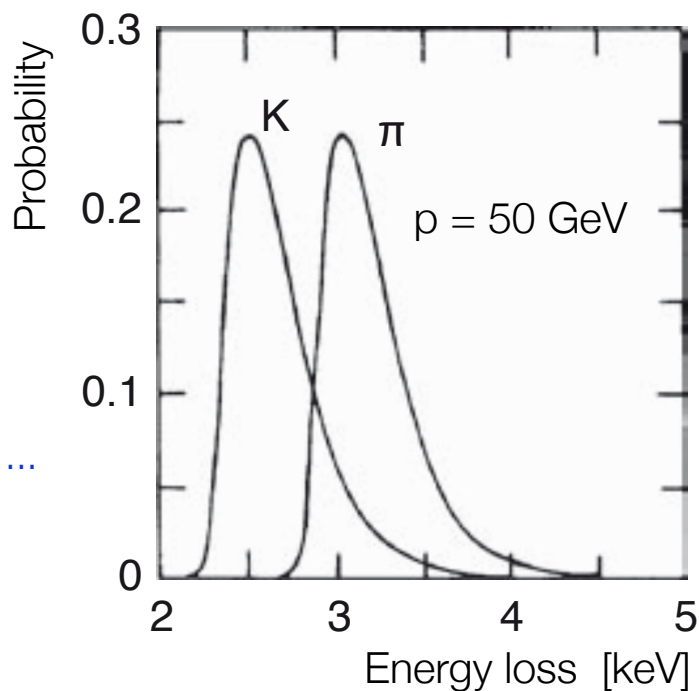

Average energy loss in
a 1 cm layer of argon-methane

μ/π separation impossible, but
 $\pi/K/p$ generally be achievable

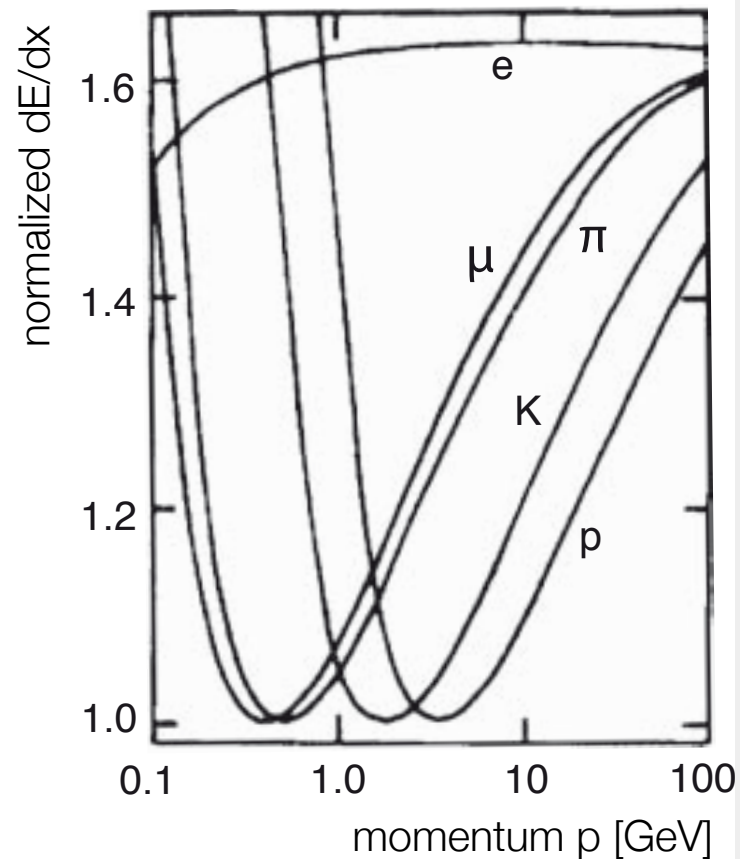

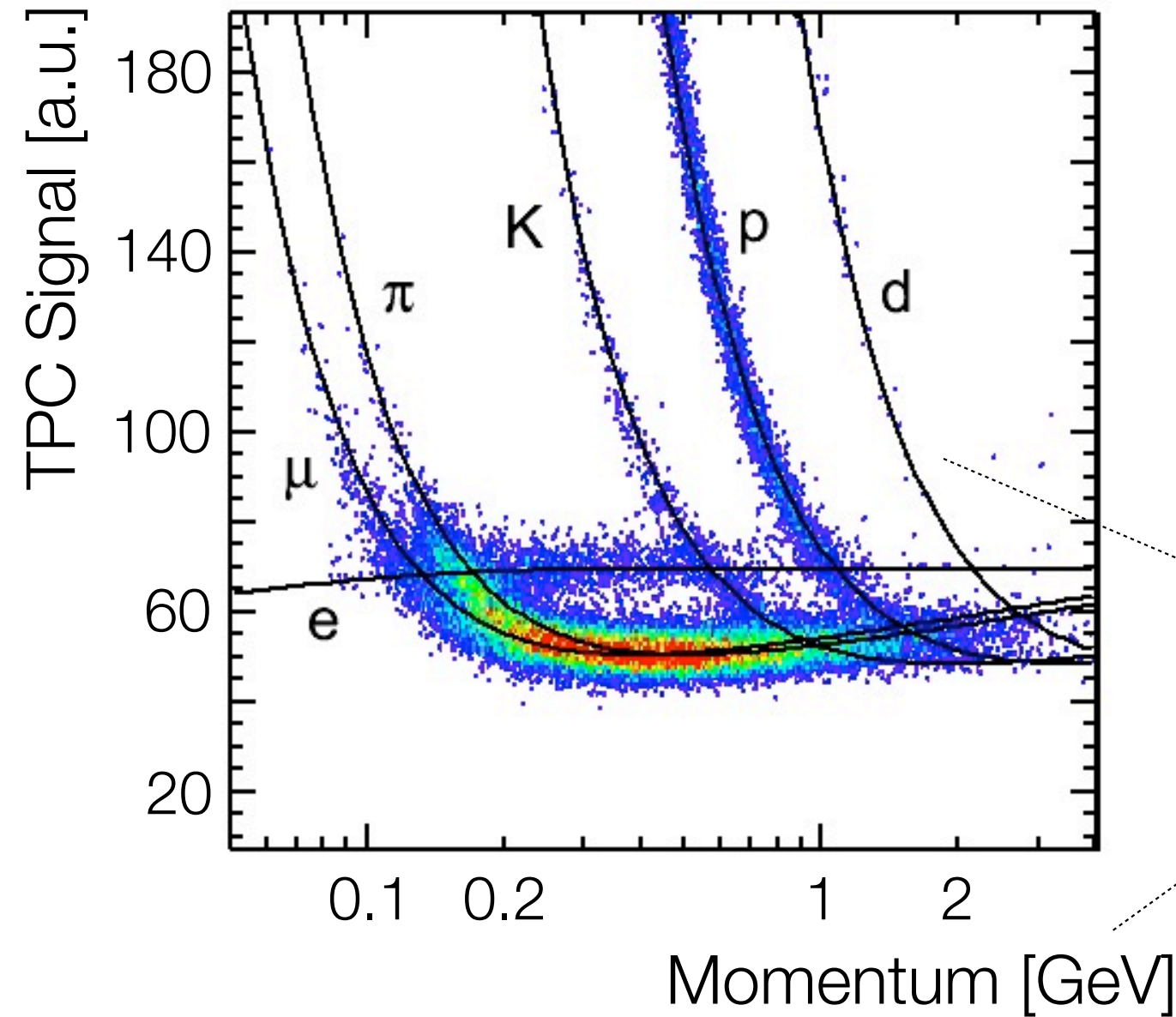

Measured energy loss

[ALICE TPC, 2009]

Bethe-Bloch

Remember:
 dE/dx depends on β !

Truncated
energy loss distributions
for various momenta ...
[ALPEH TPC]

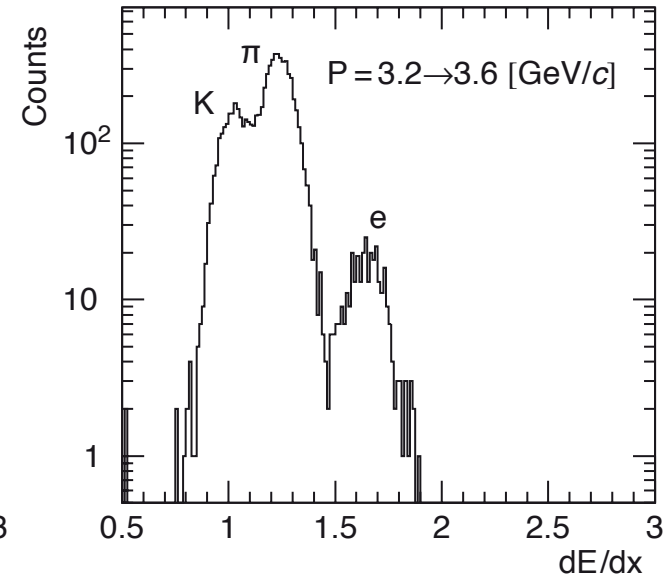
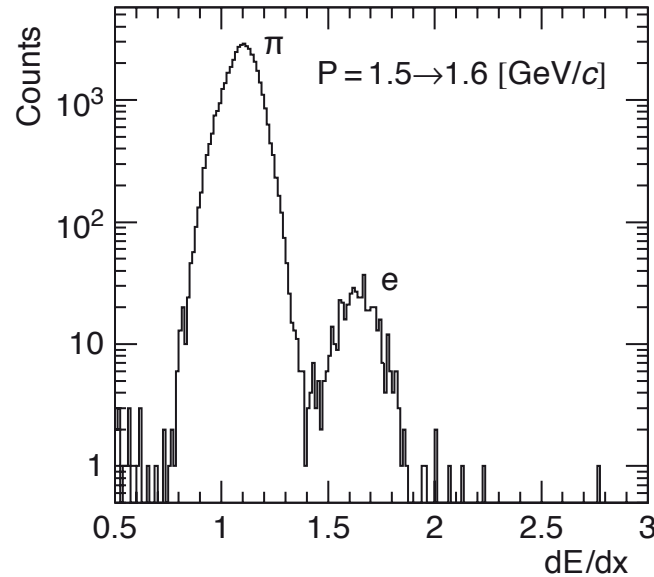
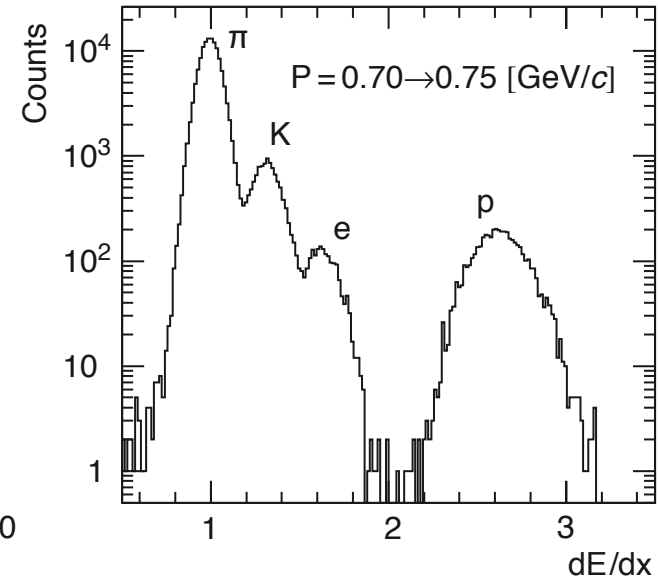
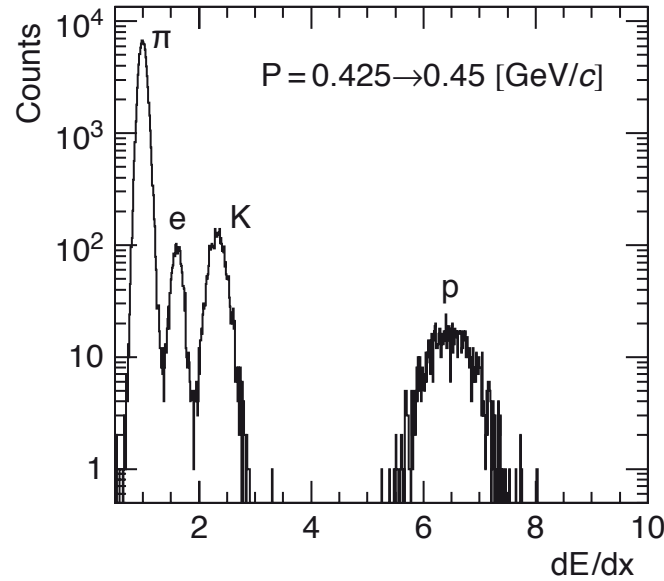

Reminder:

Polarization effect ...

Cherenkov photons emitted if $v > c/n$...

Cherenkov angle:

$$\cos \theta_c = \frac{1}{n\beta}$$

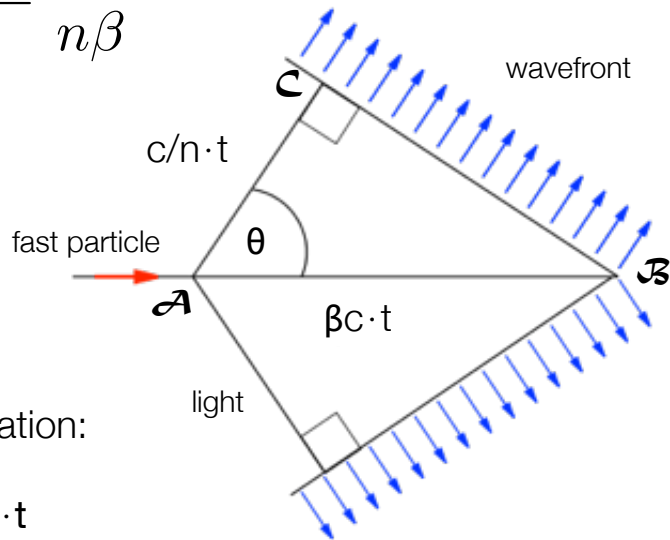

Simple Geometric derivation:

$$AB = \beta c \cdot t$$

$$AC = c/n \cdot t$$

$$\cos \theta = AC / AB = c/n \cdot t / (\beta c \cdot t)$$

$$= 1/n\beta$$

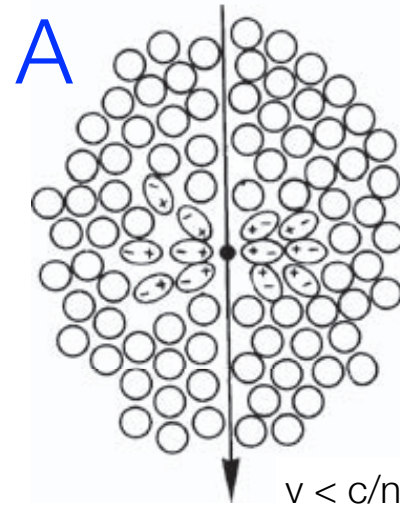

A: $v < c/n$

Induced dipoles symmetrically arranged around particle path; no net dipole moment; no Cherenkov radiation



B: $v > c/n$

Symmetry is broken as particle faster the electromagnetic waves; non-vanishing dipole moment; radiation of Cherenkov photons

To Backup

Threshold detection:

Observation of Cherenkov radiation $\rightarrow \beta > \beta_{\text{thr}}$

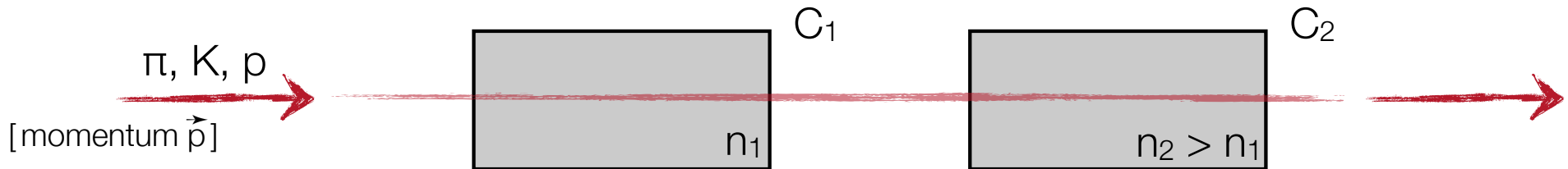

Choose n_1, n_2 in such a way that for:

$$n_2 : \quad \beta_{\pi}, \beta_K > 1/n_2 \text{ and } \beta_p < 1/n_2$$

$$n_1 : \quad \beta_{\pi} > 1/n_1 \text{ and } \beta_K, \beta_p < 1/n_1$$

Light in C_1 and C_2 \rightarrow identified pion

Light in C_2 and not in C_1 \rightarrow identified kaon

Light neither in C_1 and C_2 \rightarrow identified proton

Differential Cherenkov detectors:

Selection of narrow velocity interval for actual measurement ...

Threshold velocity:

[$\cos \theta = 1$]

$$\beta_{\min} = \frac{1}{n}$$

Maximum velocity:

[$\theta = \theta_{\max} = \theta_i$]

$$\sin \theta_t = 1/n$$

$$\cos \theta_{\max} = \sqrt{1 - \sin^2 \theta_t} = 1/n\beta_{\max}$$

$$\beta_{\max} = \frac{1}{\sqrt{n^2 - 1}}$$

Cherenkov angle limited by total reflection

Example:

Diamond, $n = 2.42 \rightarrow \beta_{\min} = 0.413, \beta_{\max} = 0.454$,
i.e. velocity window of $\Delta\beta = 0.04$...

Suitable optic allows $\Delta\beta/\beta \approx 10^{-7}$

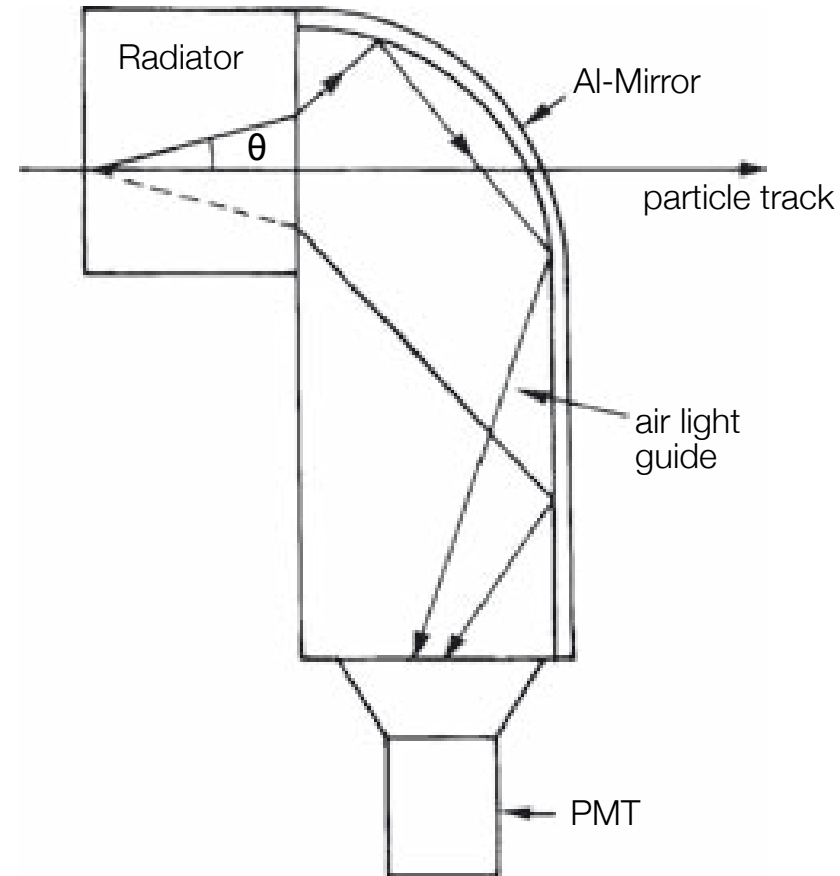

Working principle of a differential Cherenkov counter

Ring Imaging Cherenkov Counter

Optics such that photons emitted under certain angle form ring ...

Focal length of spherical mirror: $f = R_s/2$...

Cherenkov light emitted under angle: θ_C ...

Radius of Cherenkov ring: $r = f \cdot \theta_C = R_s/2 \cdot \theta_C$...

$$\rightarrow \beta = \frac{1}{n \cos(2r/R_s)}$$

Determination of β from r

Photon detection:

Photomultiplier, MWPC

Parallel plate avalanche counter ...

Gas detectors filled with photosensitive gas ...
[e.g. vapor addition or TMAE ($C_5H_{12}N_2$)]

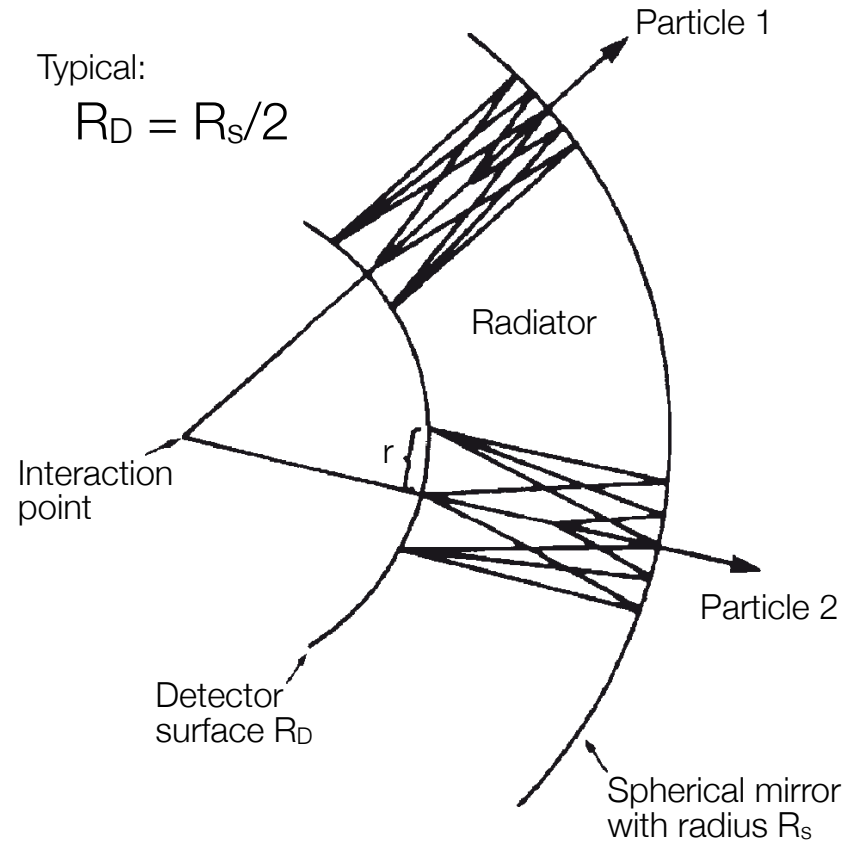

Working principle of a Ring Imaging Cherenkov Counter (RICH)

Transition radiation occurs if a relativist particle (large γ) passes the boundary between two media with different refraction indices ...

[predicted by Ginzburg and Frank 1946; experimental confirmation 70ies]

Effect can be explained by rearrangement of electric field ...

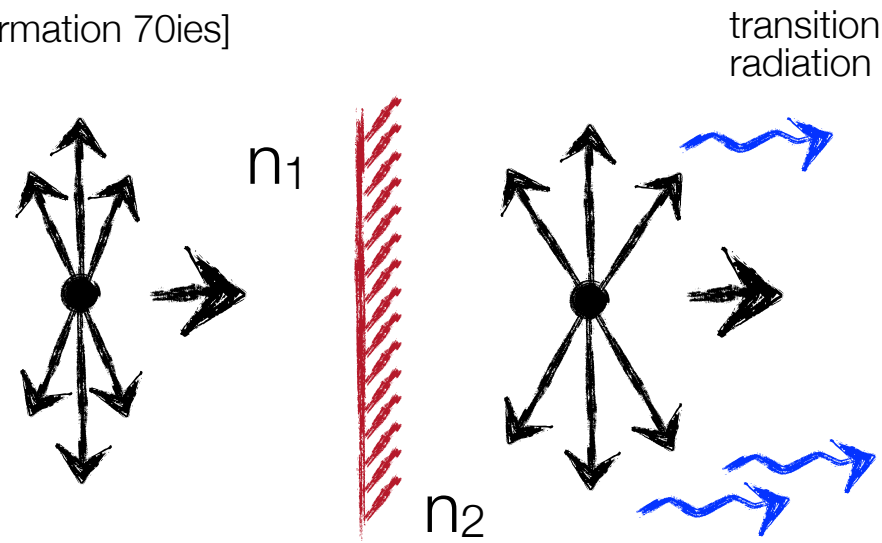
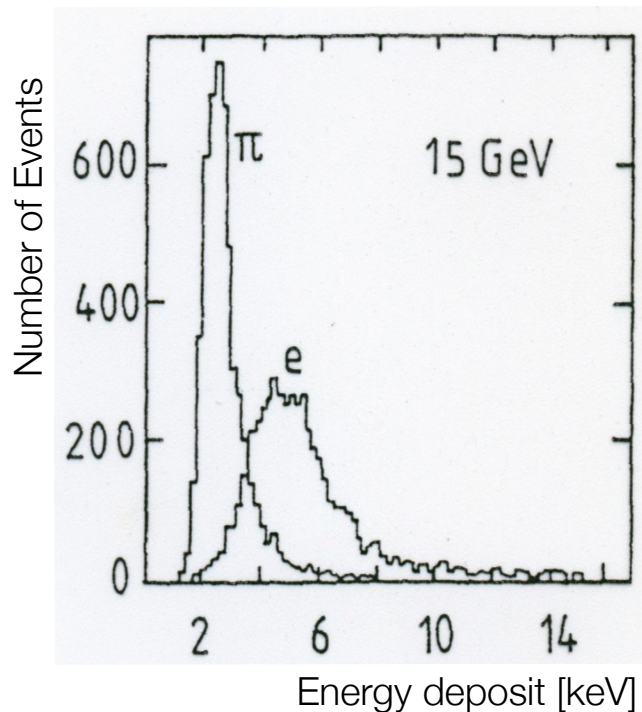

Rearrangement of electric field yields transition radiation

Energy loss distribution for 15 GeV pions and electrons in a TRD ...

Historical examples

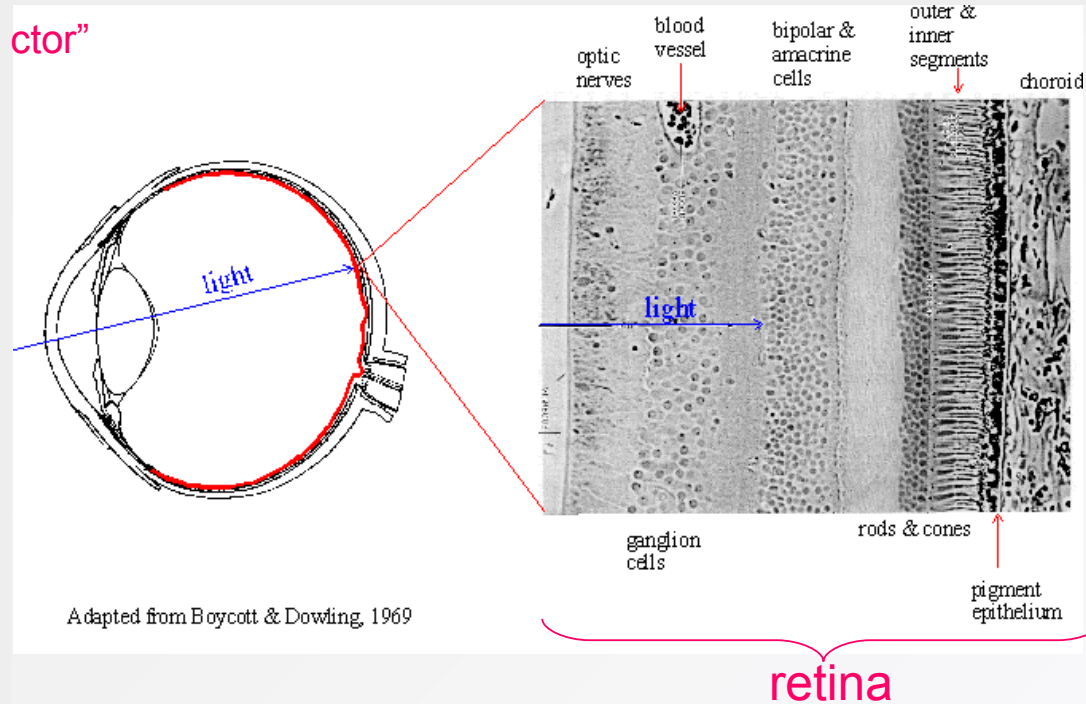

cathode ray tube

J. Plücker 1858 → J.J. Thomson 1897

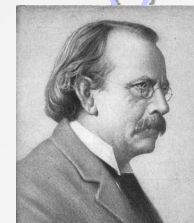
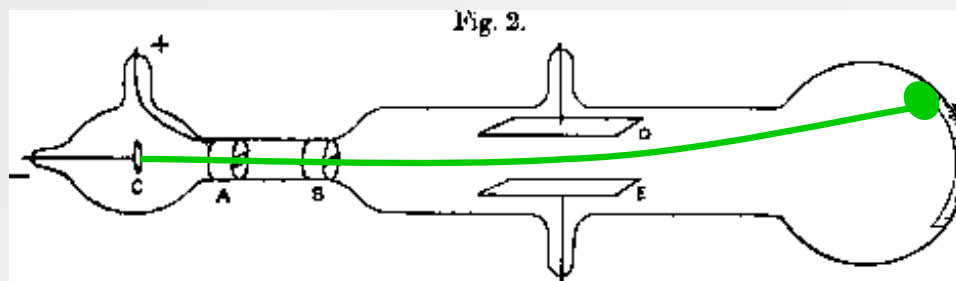

Scintillation of glass

accelerator

manipulation

detector

By E or B field

From: J.J. Thomson: Cathode Rays.
Philosophical Magazine, 44, 293 (1897).

To Backup

Historical Development

First

Detection of
 α -, β - and γ -rays

1896

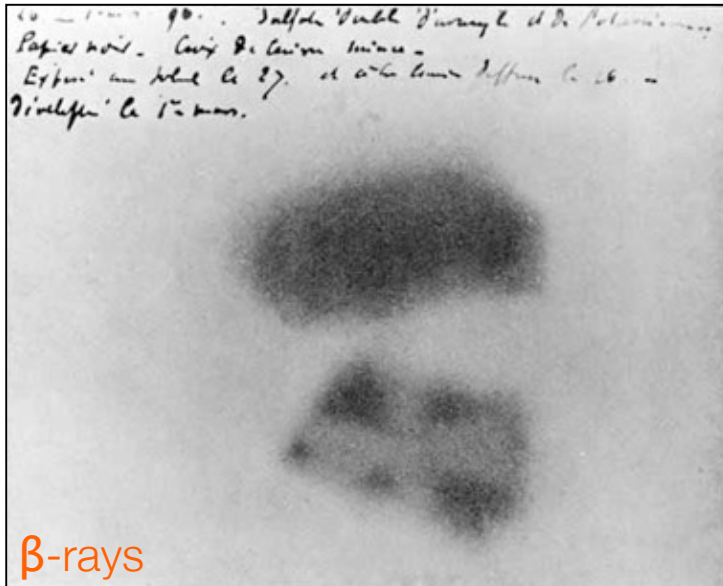

Image of Becquerel's photographic plate which has been fogged by exposure to radiation from a uranium salt.



1896

An x-ray picture taken by Wilhelm Röntgen of Albert von Kölliker's hand at a public lecture on 23 January 1896.

Historical Development

Rutherford's scattering experiment

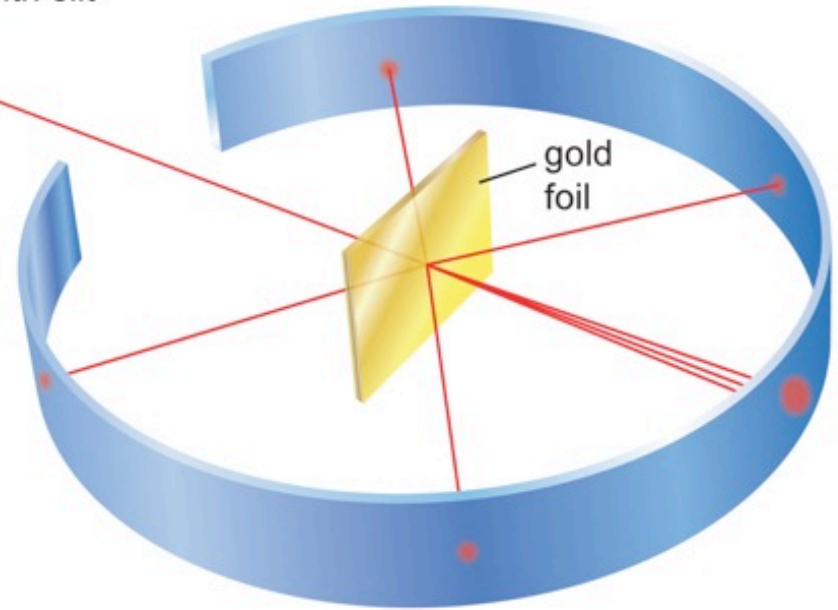
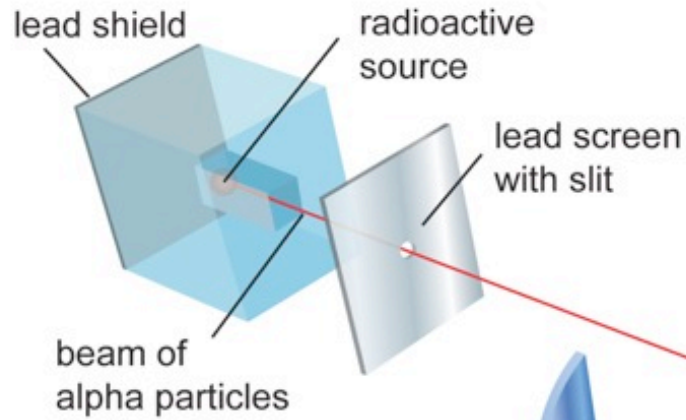

Microscope +
Scintillating ZnS screen

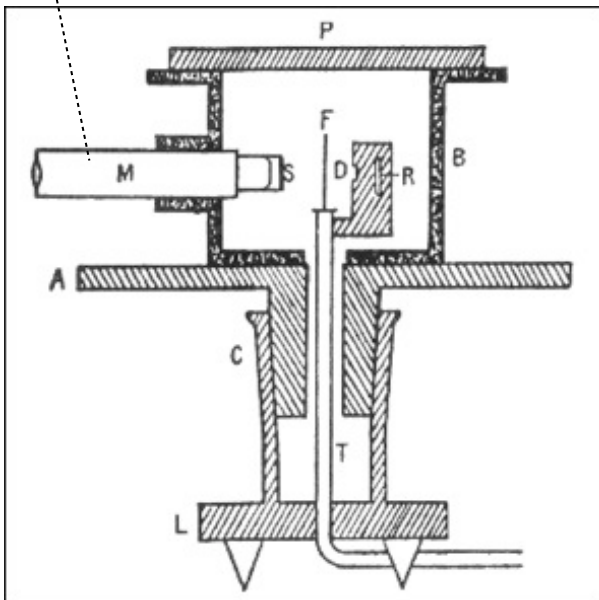

Rutherford's original
experimental setup

Schematic view
of Rutherford experiment

1911

Geiger Counter



E. Rutherford 1909



H. Geiger 1927

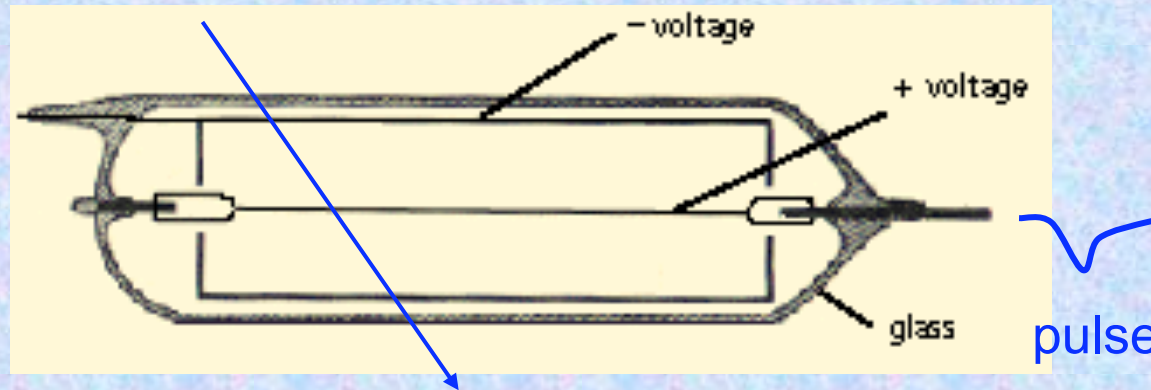

The Geiger counter, later further developed and then called Geiger-Müller counter

First electrical signal from a particle

E. Rutherford and H. Geiger, Proc. Royall Soc. A81 (1908) 141

H. Geiger and W. Mülller, Phys. Zeits. 29 (1928) 839

Historical Development

Detection of cosmic rays

[Hess 1912; Nobel prize 1936]

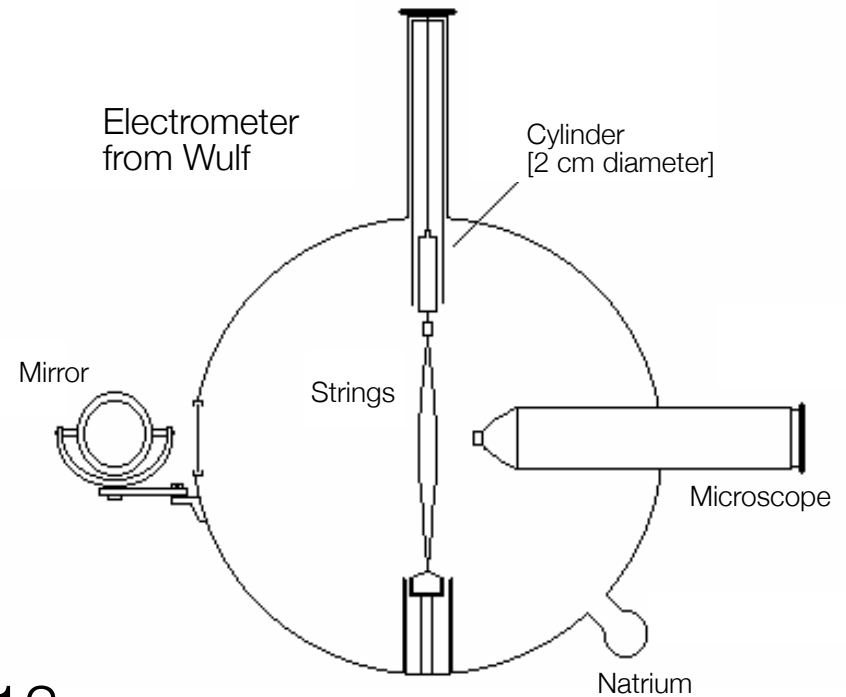

1912

Victor F. Hess before his 1912 balloon flight in Austria during which he discovered cosmic rays.



First Tracking Detector: Wilson Chamber

Cloud chamber (1911 by Charles T. R. Wilson, Noble Prize 1927)

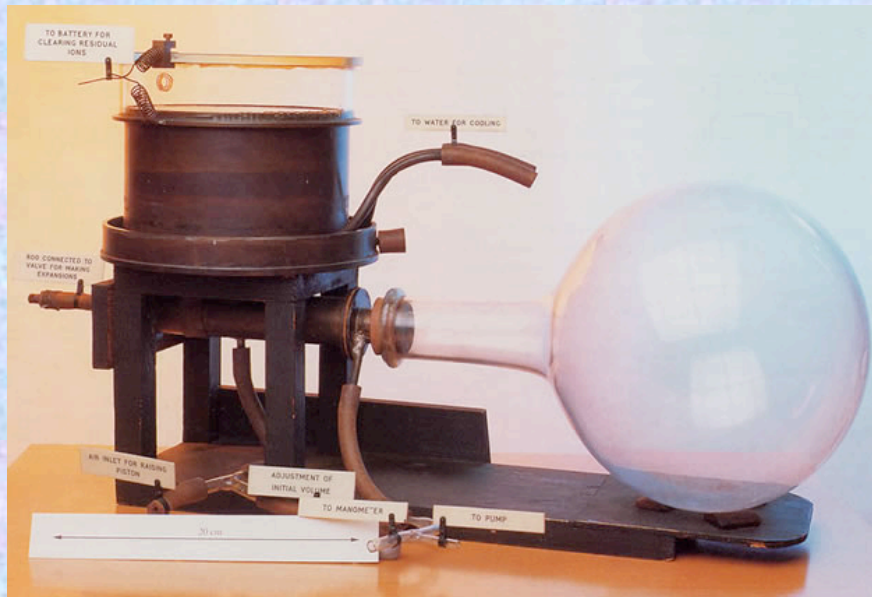

The general procedure was to allow water to evaporate in an enclosed container to the point of saturation and then lower the pressure, producing an over-saturated volume of air. Then the passage of a charged particle would condense the vapor into tiny droplets, producing a visible trail marking the particle's path, their number per unit of length being proportional to the density of ionization (dE/dx).

was used at discovery of the positron (1932 by Carl Anderson, Noble Prize 1936)

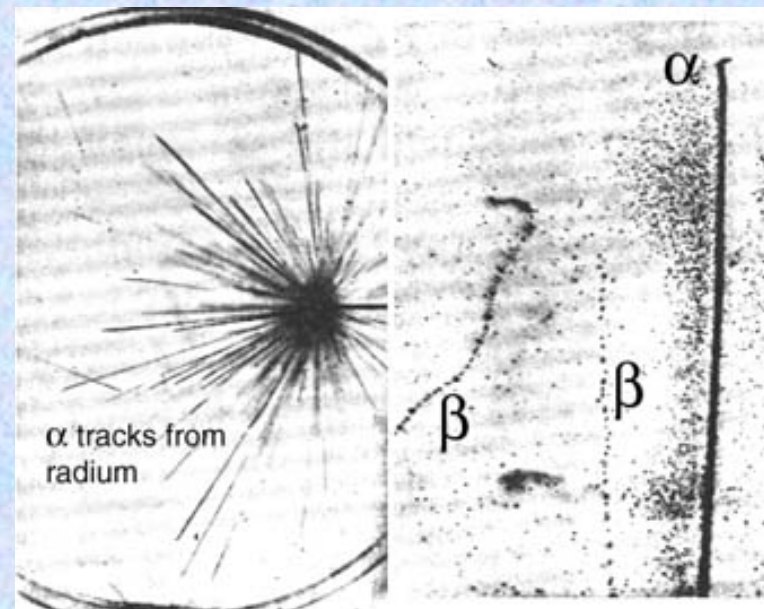

Historical Development

Discovery of antimatter

[Anderson 1932; Nobel prize 1936]

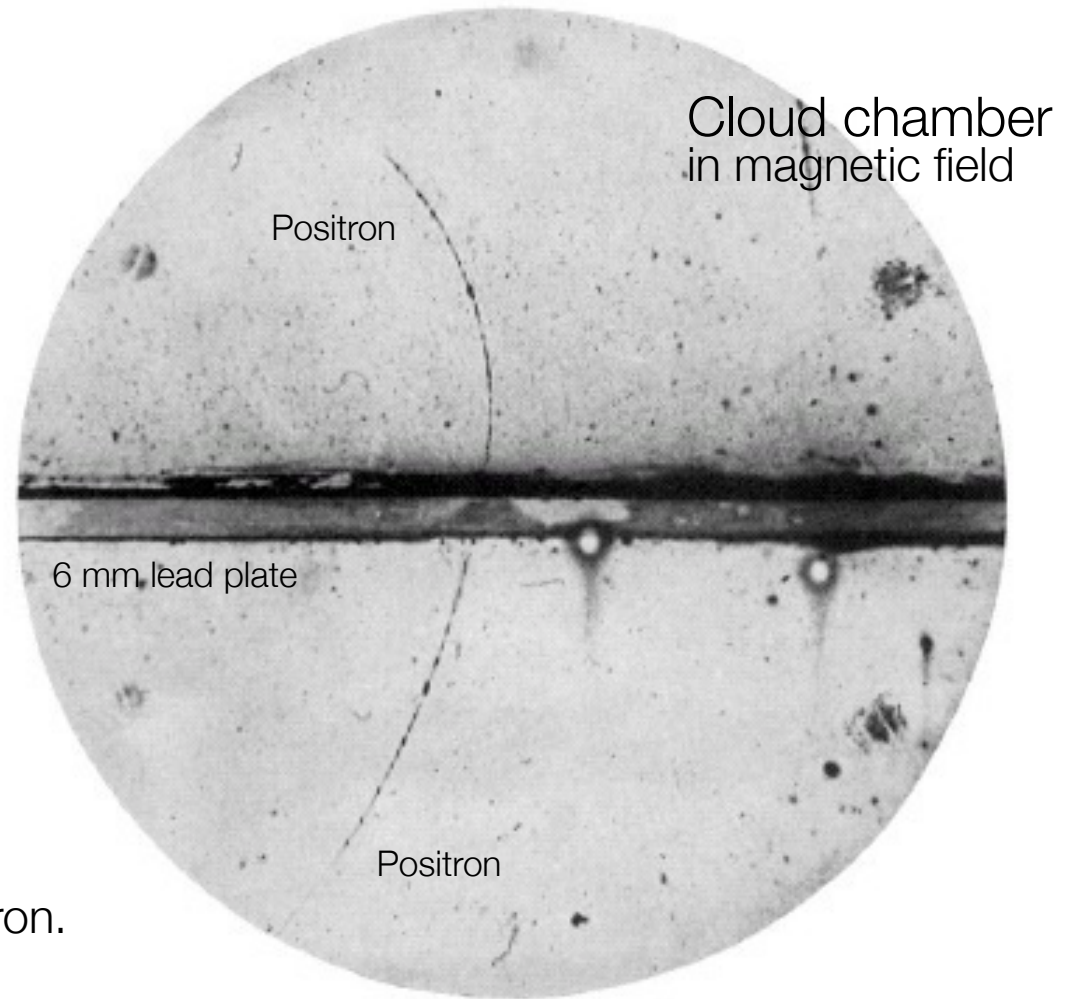

63 MeV positron passing through lead plate emerging as 23 MeV positron.

The length of this latter pass is at least ten times greater than the possible length of a proton path of this curvature.

Historical Development

Discovery of the pion
Nuclear emulsion technique

[Powell 1947; Nobel prize 1950]

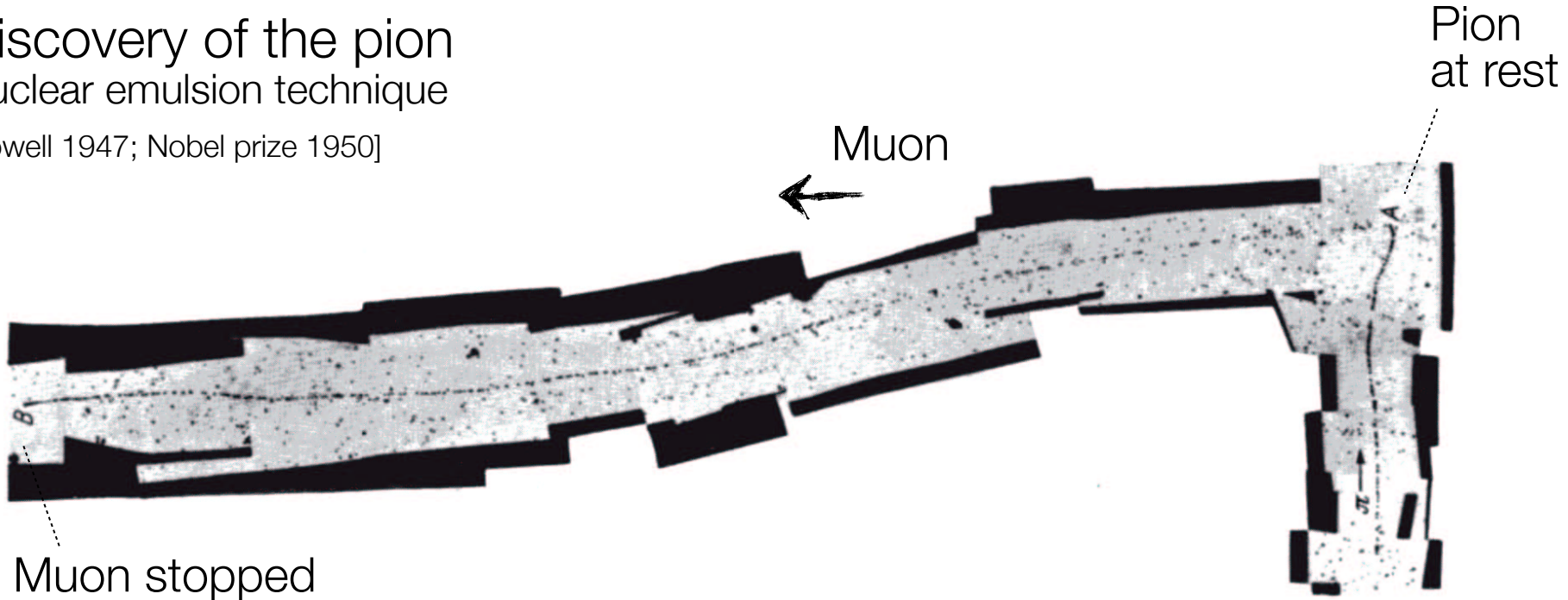

$$\pi \rightarrow \mu \nu$$

$$\mu \rightarrow e \nu \nu \text{ [not seen]}$$

Pion

Bubble Chamber

Donald Glaser



BNL Image Library

Similar principle as cloud chamber:

- **Bubble chamber (1952 by Donald Glaser, Noble Prize 1960)**
 - (4.8 x 1.85 m²) chamber with liquid (e.g. H₂) at boiling point (“superheated”)
 - charged particles leave trails of ions
 - formation of small gas bubbles around ions

was used at discovery of the “neutral current” (1973 by Gargamelle Collaboration, no Noble Prize yet)

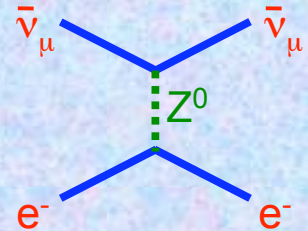

Gargamelle bubble chamber

CERN

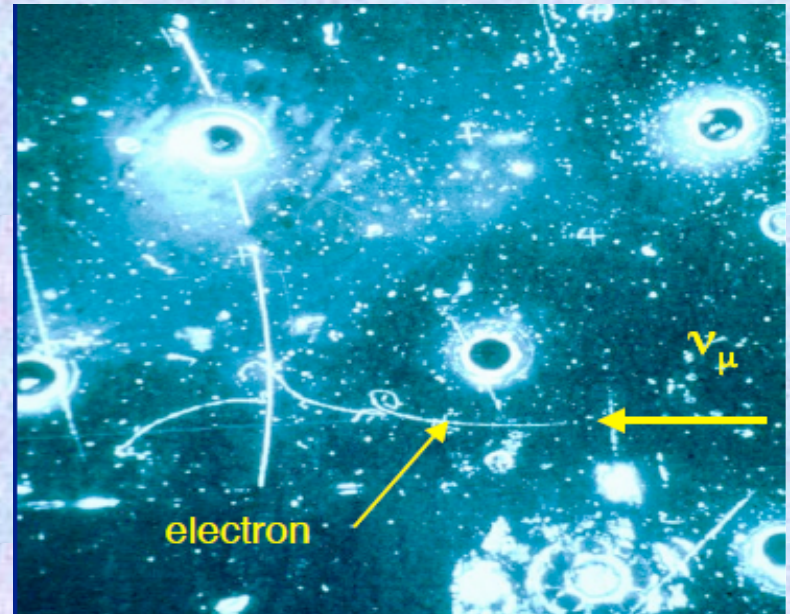

Historical Development

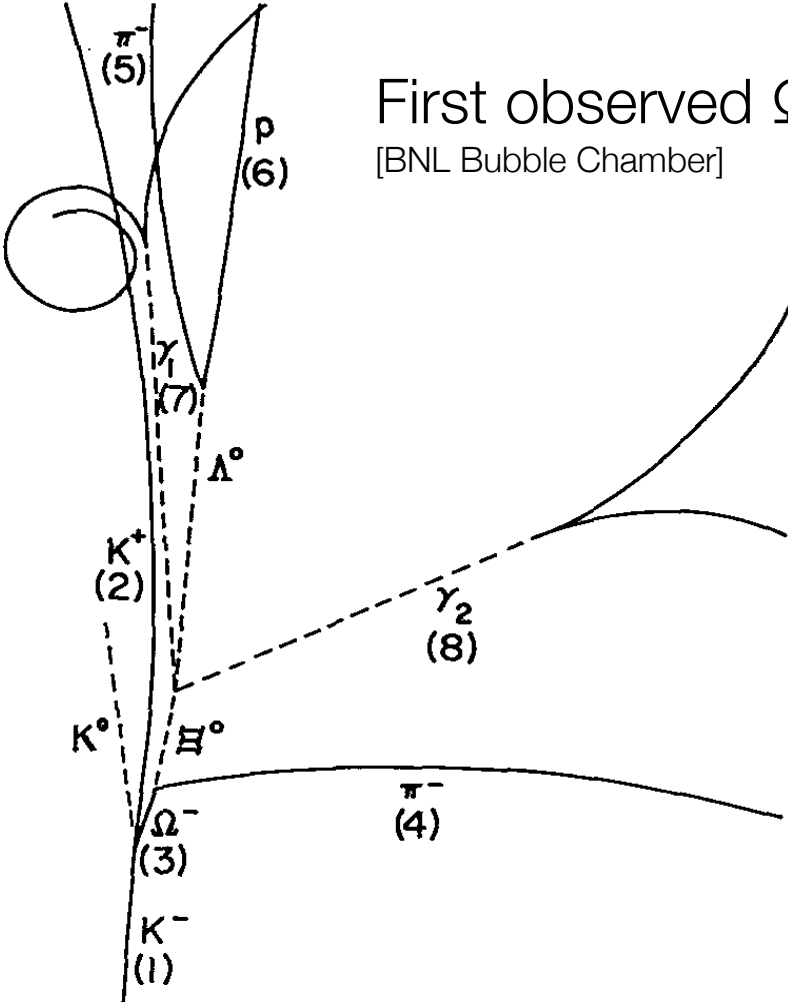
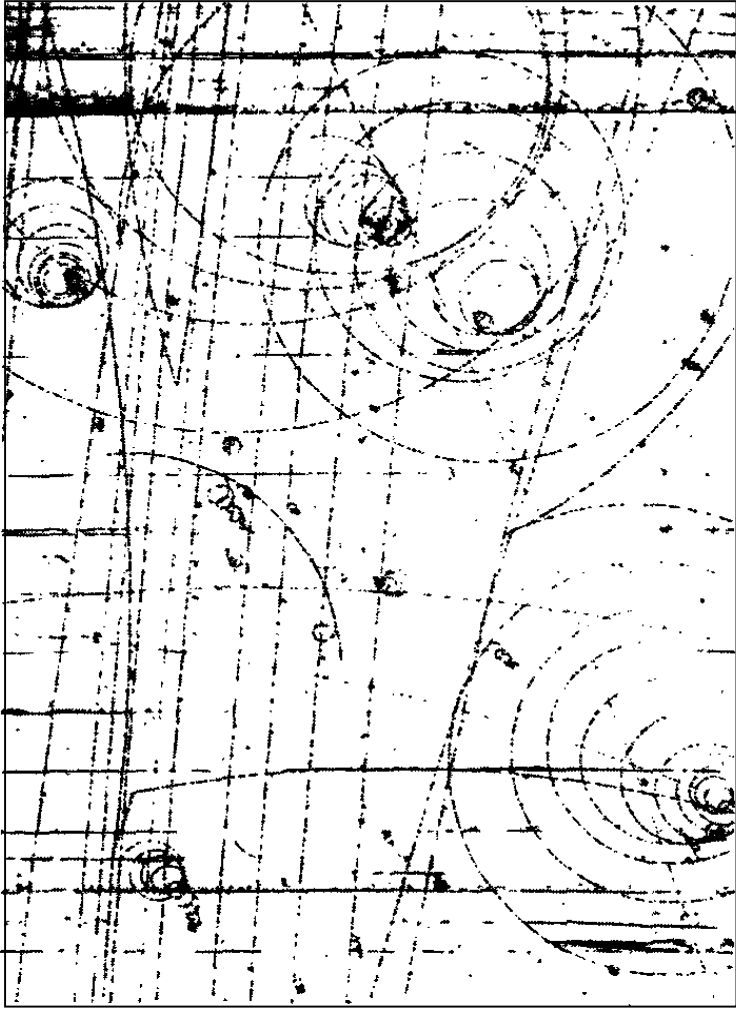

First observed Ω^- event
[BNL Bubble Chamber]

Historical Development



Discovery of the muon neutrino (1962)

Leon M. Lederman
Melvin Schwartz
Jack Steinberger
[Nobel prize 1988]

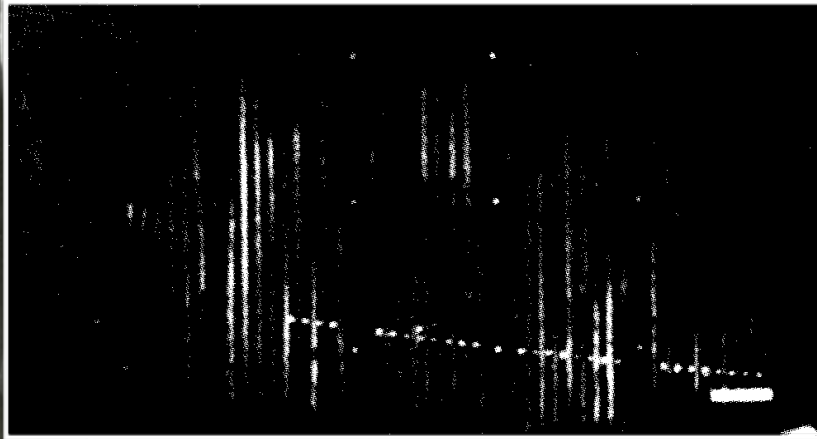

Single muon event from original publication

Melvin Schwartz in front of the spark chamber used to discover the muon neutrino

Large Size Multi-Wire Proportional Chamber (1972)

Geiger - Müller tube just good for single tracks with limited precision (no position information) → in case of more tracks more tubes are needed or...

Multi Wire Proportional Chamber → 1968 by Georges Charpak, Nobel Prize 1992)

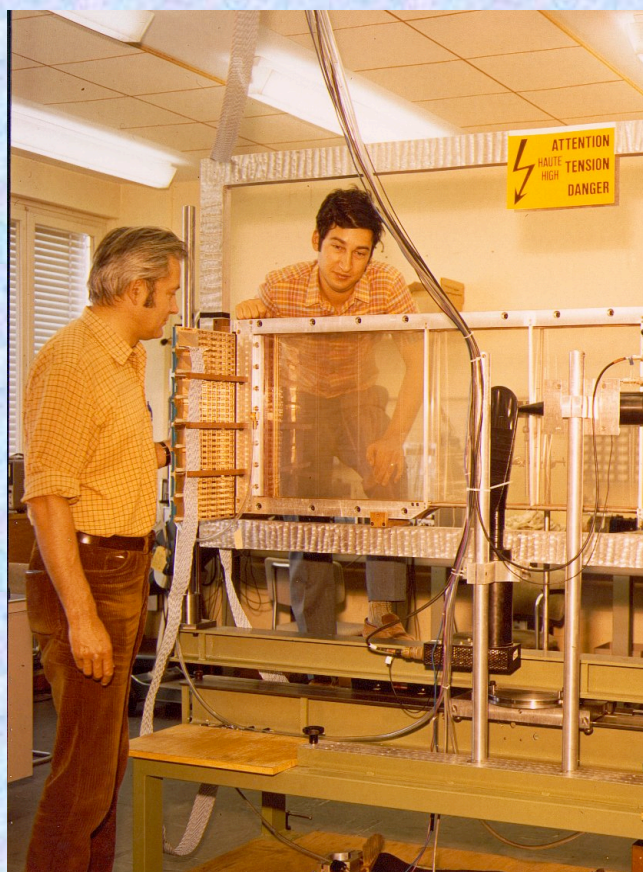

The Nobel Prize in Physics 1992

The Royal Swedish Academy of Sciences awards the 1992 Nobel Prize in Physics to **Georges Charpak** for his invention and development of particle detectors, in particular the multiwire proportional chamber.

Georges Charpak
CERN, Geneva, Switzerland

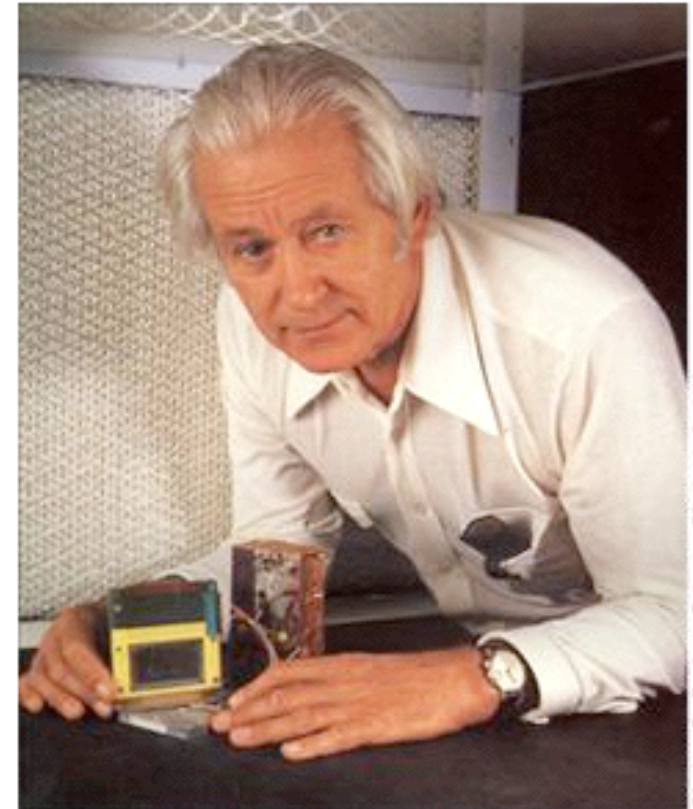
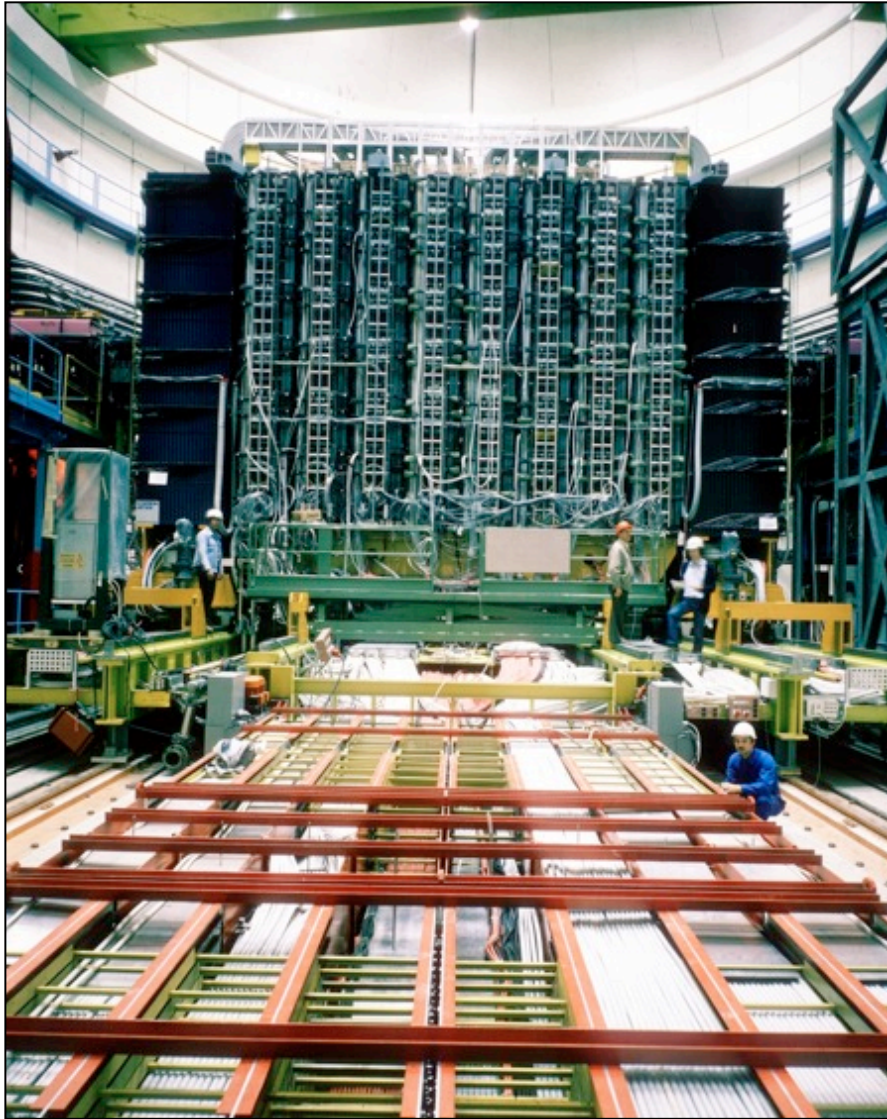

Photo: D. Parker, Science Photo Lab, UK

Historical Development



UA1
Detector

Discovery of the W/Z boson (1983)

Carlo Rubbia
Simon Van der Meer

[Nobel prize 1984]

First Z^0 particle seen by UA1

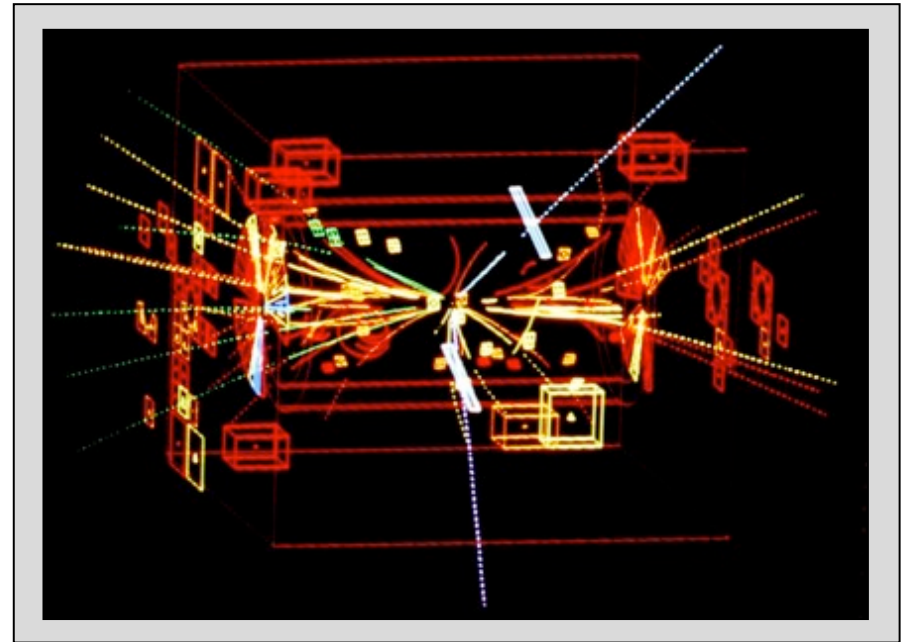

Historical Development

Some relevant Nobel Prizes

1901	Physics	Wilhelm C. Röntgen	X-rays (1896) [Photographic plate]
1903	Physics	Antoine H. Becquerel Marie Curie Pierre Curie	Radioactivity (1896/99) [Photographic plate & electrometer]
1905	Physics	Philipp Lenard	Lenard window (1904) [Phosphorescent material]
1908	Chemistry	Ernest Rutherford	Atomic nucleus (1911) [Scintillating crystals]
1927	Physics	Charles T. R. Wilson	Cloud chamber (1912)
1935	Physics	James Chadwick	Neutron discovery (1932) [Ionization chamber]
1936	Physics	Victor F. Hess Carl D. Anderson	Cosmic rays (1912) Positron discovery (1932) [Electrometer & cloud chamber]

Historical Development

Some relevant Nobel Prizes

1948	Physics	Patrick M. S. Blackett	e^+e^- Production ... (1933) [Advanced cloud chambers]
1950	Physics	Cecil F. Powell	Pion discovery (1947) [Photographic emulsion]
1953	Physics	Walter Bothe	Coincidence method (1924)
1958	Physics	Pavel A. Cherenkov	Cherenkov effect (1934)
1959	Physics	Emilio G. Segrè Owen Chamberlain	Antiproton discovery (1955) [Spectrometer; Cherenkov counter ...]
1960	Physics	Donald A. Glaser	Bubble chamber (1953)
1976	Physics	Burton Richter Samuel C.C. Ting	J/ψ discovery (1974) [AGS Synchrotron; pBe collisions] [SLAC e^+e^- collider; MARK I]
1980	Physics	James Cronin Val Fitch	CP violation (1963) [Spark chamber; spectrometer]

Historical Development

Some relevant Nobel Prizes

1984	Physics	Carlo Rubbia, Simon Van der Meer	W/Z discovery (1983) [SPS; 4π multi-purpose detector]
1988	Physics	Leon M. Lederman Melvin Schwartz Jack Steinberger	Muon neutrino (1962) [Neutrino beam; spark chambers]
1990	Physics	Jerome I. Friedman Henry W. Kendall Richard E. Taylor	Proton structure (1972+) [ep scattering; spectrometer]
1989	Physics	Hans G. Dehmelt Wolfgang Paul	Electron g-2 (1986) [Ion trap technique]
1992	Physics	Georges Charpak	Multi-Wire Chamber (1968)
2002	Physics	Raymond Davis Jr. Masatoshi Koshiba	Cosmic neutrino (1986) [Large area neutrino detector]



Applications

LM

Application 1

- 1/ Explain the difference between electrons and heavy ions when they interact with matter. Why the trajectory is different from the range in the case of electrons?
- 2/ Which effect arises when an electron beam is passing through an absorber?
- 3/ What is the critical energy for electrons in Pb ($Z=82$)? Are such electrons relativists?
- 4/ Below which energy the Bremsstrahlung is $<5\%$? In order to have a good protection against relativist electrons, is it worth to use light or heavy materials?
- 5/ Calculate E_c for Carbon ($Z=6$). Calculate Bremsstrahlung ratio for 10 MeV electrons in carbone and compare with Pb. Then for 300 MeV.

Application 1

1/ Heavy ions: collisions with electrons (no deviation, distance depending on the energy and material) then atomic collisions at low energy. The trajectory is almost equal to the path in the matter.

Electrons: collisions with electrons (deviation, numerous collisions when energy decreasing). Atomic collisions (radiative losses) arise at high E. Due to the high number of deviations, the trajectory of electrons is larger than their range.

2/ Bremsstrahlung is the major effect to take into account (for radioprotection purposes for instance). It is proportional to E and Z^2 .

$$3/ \quad E_c^e = 800 \text{ MeV} / (82 + 1.2) = 9.62 \text{ MeV}$$

$$E = (\gamma - 1) m_0 c^2 \Rightarrow \gamma = 19.8$$

$$\beta = v/c = \sqrt{1 - 1/\gamma^2} = 0.9987$$

4/ If r is the Bremsstrahlung ratio then $r = [\text{brem}] / [\text{brem} + \text{coll}]$ and $1/r = 1 + [\text{coll}] / [\text{brem}] = 1 + 700/ZE$

→ $E = 449 \text{ keV}$

In any cases, it is better to minimize the Bremsstrahlung and so to use a low Z material.

5/ $Z=6$ so $E_c = 111,1 \text{ MeV}$.

For 10 MeV electrons the Brem. ratio is 7.9% in carbone and 54% in lead.

For 300 MeV electrons the Brem. ratio is 72% in carbone and 97% in lead.

Application 2

1/ In water, what is the minimum kinetic energy for an electron to undergo a Cherenkov effect?

2/ Calculate this energy for a proton and an alpha.

Water index of refraction: $n=4/3$

$$m_0^e c^2 = 0,511 \text{ MeV}$$

$$m_0^p c^2 = 938,3 \text{ MeV}$$

$$m_0^n c^2 = 939,6 \text{ MeV}$$

Application 2

The velocity of the charged particle must be $v > \frac{3}{4} \cdot c$

Electron kinetic energy is:

$$T = mc^2 - m_0c^2 \quad \text{with} \quad m = \frac{m_0}{\sqrt{1 - \frac{v^2}{c^2}}}$$

So $E_e > 0,26 \text{ MeV}$; $E_p > 480 \text{ MeV}$; $E_\alpha > 1,922 \text{ GeV}$

Application 3

Photons detection:

A gamma source is located behind an aluminium plate of 0.5 cm thickness and detected by a counter at a distance of 4 cm with an effective detection area of 5 cm².

The source is emitting 3700 photons/sec with an energy of 0,95 MeV.

For such photons, the mass attenuation coefficient of aluminium is 0,1 cm²/g.

If the detection efficiency of the counter is 90%, calculate the number of counts per second in the detector.

Aluminium mass density: 2,7 g/cm³

Application 3

Number of photons detected is related to the solid angle fraction, the photons attenuation in the aluminium and the detection efficiency.

$$N = N_0 \times \frac{S_{eff}}{4\pi r^2} \times \exp(-\mu_m \rho x) \times \textit{efficiency}$$

$$N = 3700 \times \frac{5}{4\pi 4^2} \times \exp(-0,1 \times 2,7 \times 0,5) \times 0,9 = 72,4 \text{ } \gamma \cdot s^{-1}$$

To Backup

Energy loss for photons → three major physics mechanisms :

- Photo electric effect : absorption of a photon by an atom ejecting an electron

$$\sigma = Z^5 \alpha^4 \left(\frac{m_e c^2}{E_\gamma} \right)^n \quad n = 7/2 \text{ for } E \ll m_e c^2 \text{ and } \rightarrow 1 \text{ for } E \gg m_e c^2$$

Strong dependence with Z, dominant at low photon energy

- Compton scattering

$$\sigma_C^e \propto \frac{\ln E_\gamma}{E_\gamma} \text{ and atomic compton} = Z \sigma_C^e$$

- Pair creation (similar to bremsstrahlung) : dominant for $E \gg m_e c^2$

$$\sigma_{\text{pair}} \approx 4\alpha r_e^2 Z^2 \left(\frac{7}{9} \ln \frac{183}{Z^{1/3}} \right) = \frac{A}{N_A} \left(\frac{7}{9} \frac{1}{X_0} \right) \text{ Independent of energy !}$$

Probability of pair creation in $1 X_0$ is $e^{-7/9}$, mean free path of a photon before creating a e^+e^- pair is $\Lambda_{\text{pair}} = 9/7 X_0$

Energy loss for photons

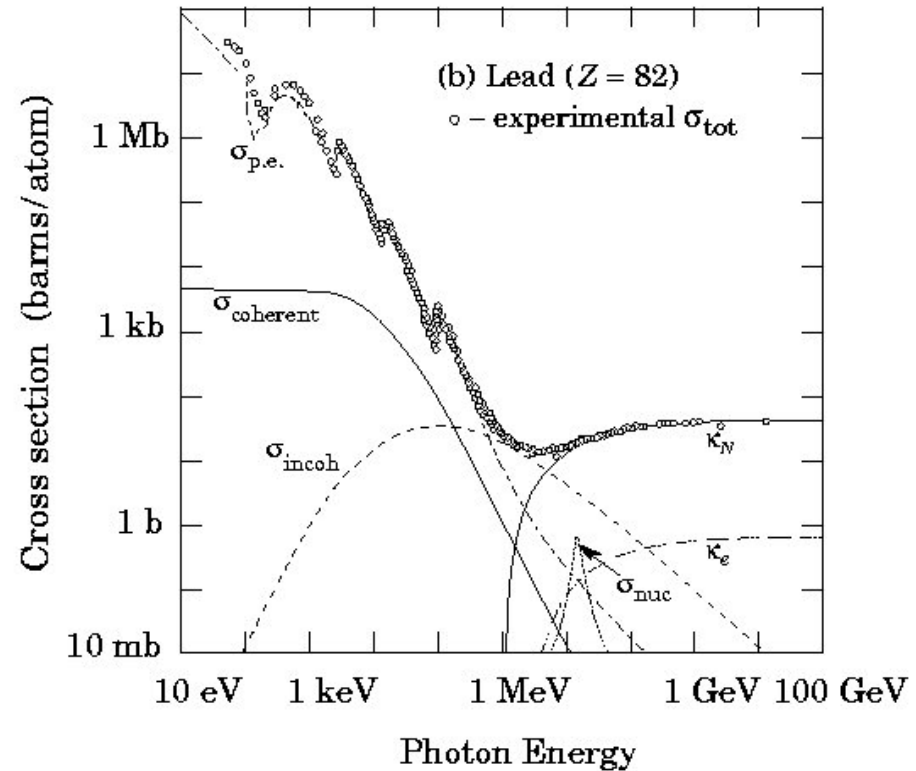
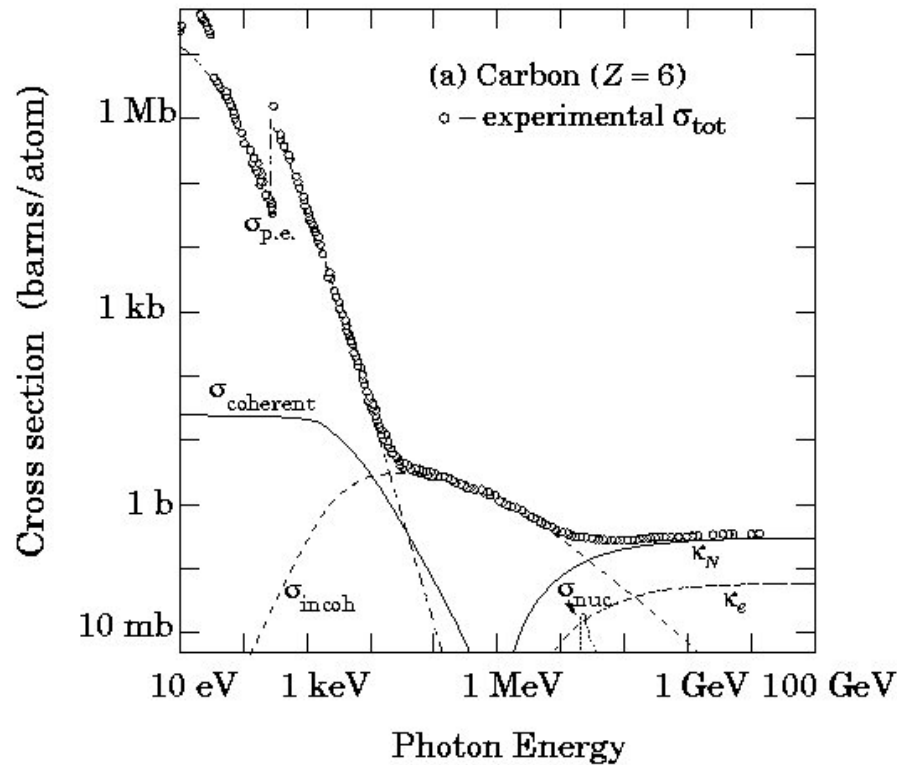

$\sigma_{\text{p.e.}}$ = Atomic photoelectric effect (electron ejection, photon absorption)

σ_{Rayleigh} = Rayleigh (coherent) scattering—atom neither ionized nor excited

σ_{Compton} = Incoherent scattering (Compton scattering off an electron)

κ_{nuc} = Pair production, nuclear field

κ_e = Pair production, electron field

$\sigma_{\text{g.d.r.}}$ = Photonuclear interactions.

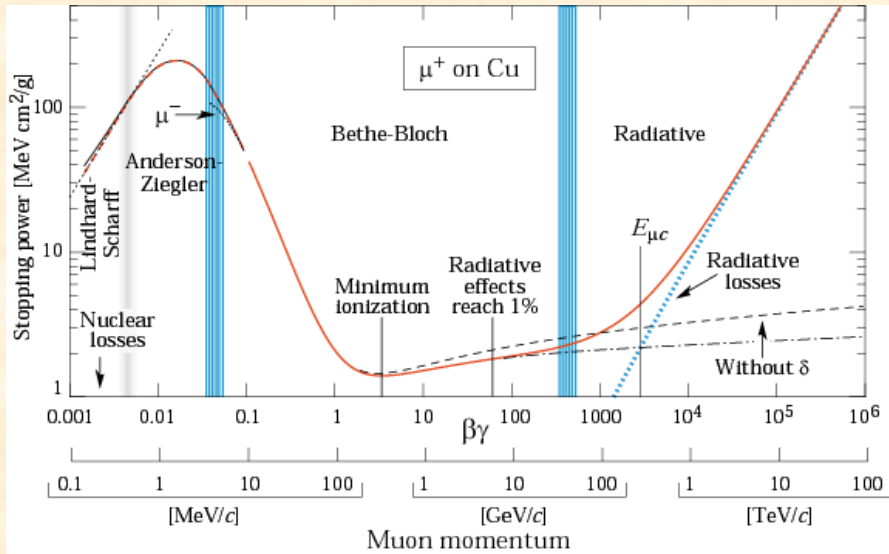

Bethe-Bloch for heavy particles

$$\text{Stopping Power} \equiv \frac{dE}{dx} \equiv E \cdot \rho \frac{1}{X_0}$$

Electron (positron) interaction with matter

Define Radiation Length X_0 as the Radiative Mean Path :
 i.e. the distance over which the energy of electron/positron is reduced by a factor e by Bremsstrahlung.
 Measured in units of [g/cm²]

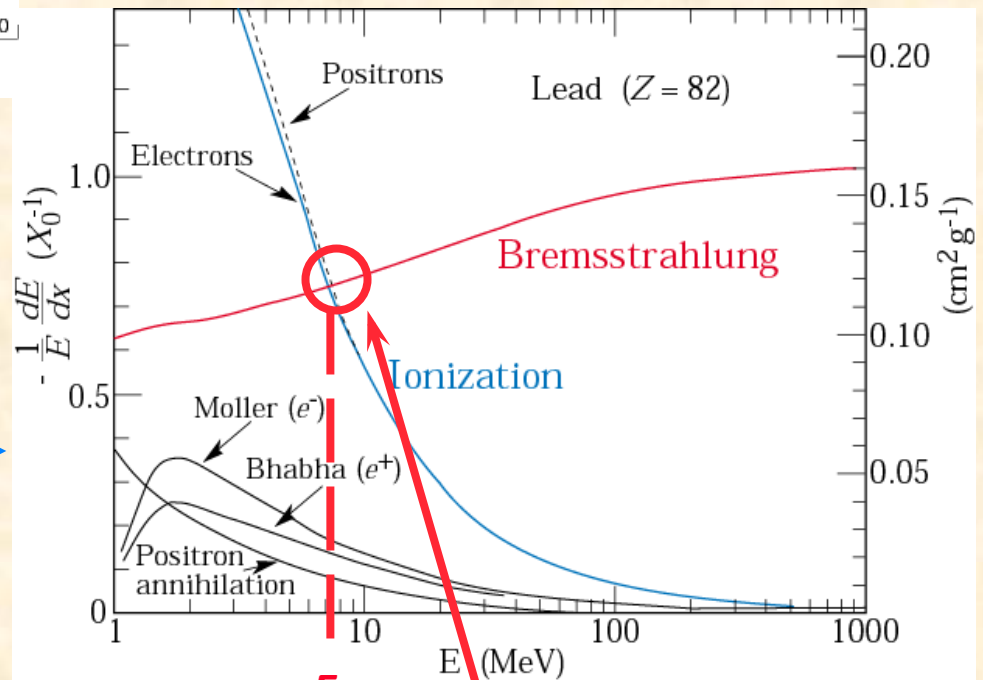

Critical energy E_c
 Ionization = Bremsstrahlung

Energy (kinetic) loss by Coulomb interaction of charged particles with the atoms/ electrons :

- ❑ Excitation : the atom (or molecule) is excited to a higher level

atom* \rightarrow atom + γ

low energy photons of de-excitation

\rightarrow light detection

- ❑ Ionization : the electron is ejected from the atom

electron / ion pair

\rightarrow charge detection

- ❑ Instead of ionization/excitation real photon can be produced under certain conditions

\rightarrow Cerenkov or Transition radiation

Contribute very little to the energy loss (< 5%), can be neglected but they are used for particle ID

Bethe-Bloch:

$$\frac{dE}{dx} = Kz^2 \frac{Z}{A} \frac{1}{\beta^2} \left[\frac{1}{2} \ln \frac{2m_e c^2 \beta^2 \gamma^2 T_{\max}}{I^2} - \beta^2 - \frac{\delta}{2} \right]$$

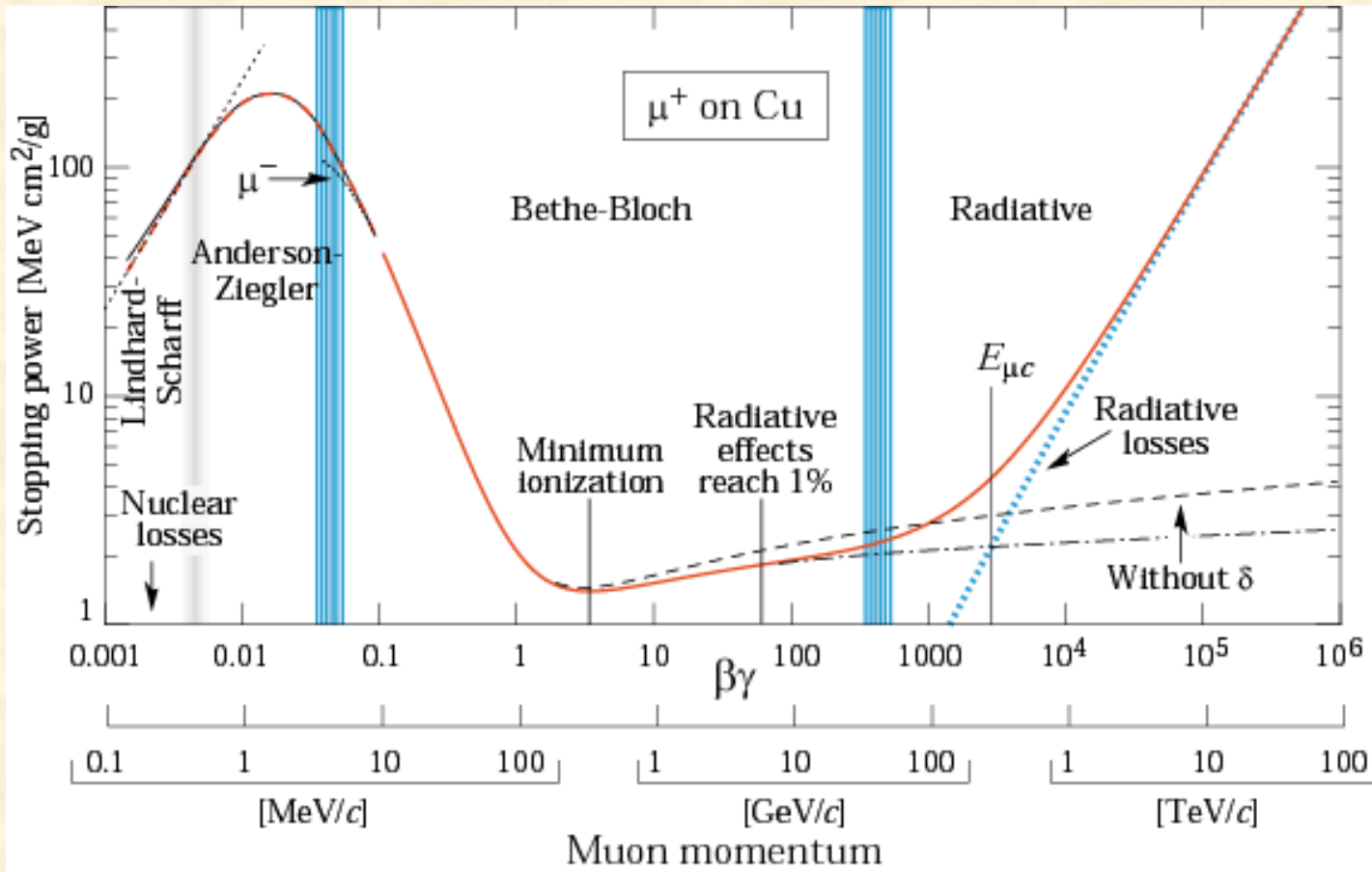

Stopping power ($-\langle dE/dx \rangle$) for positive muons in copper as a function of $\beta\gamma = p/Mc$ over nine orders of magnitude in momentum (12 orders of magnitude in kinetic energy). Solid curves indicate the total stopping power.

Minimum Ionizing Particle :

- Minimum at $\beta\gamma \sim 3 \dots 4$
- Similar for all elements $\sim 2 \text{ MeV}/(\text{g}/\text{cm}^2)$

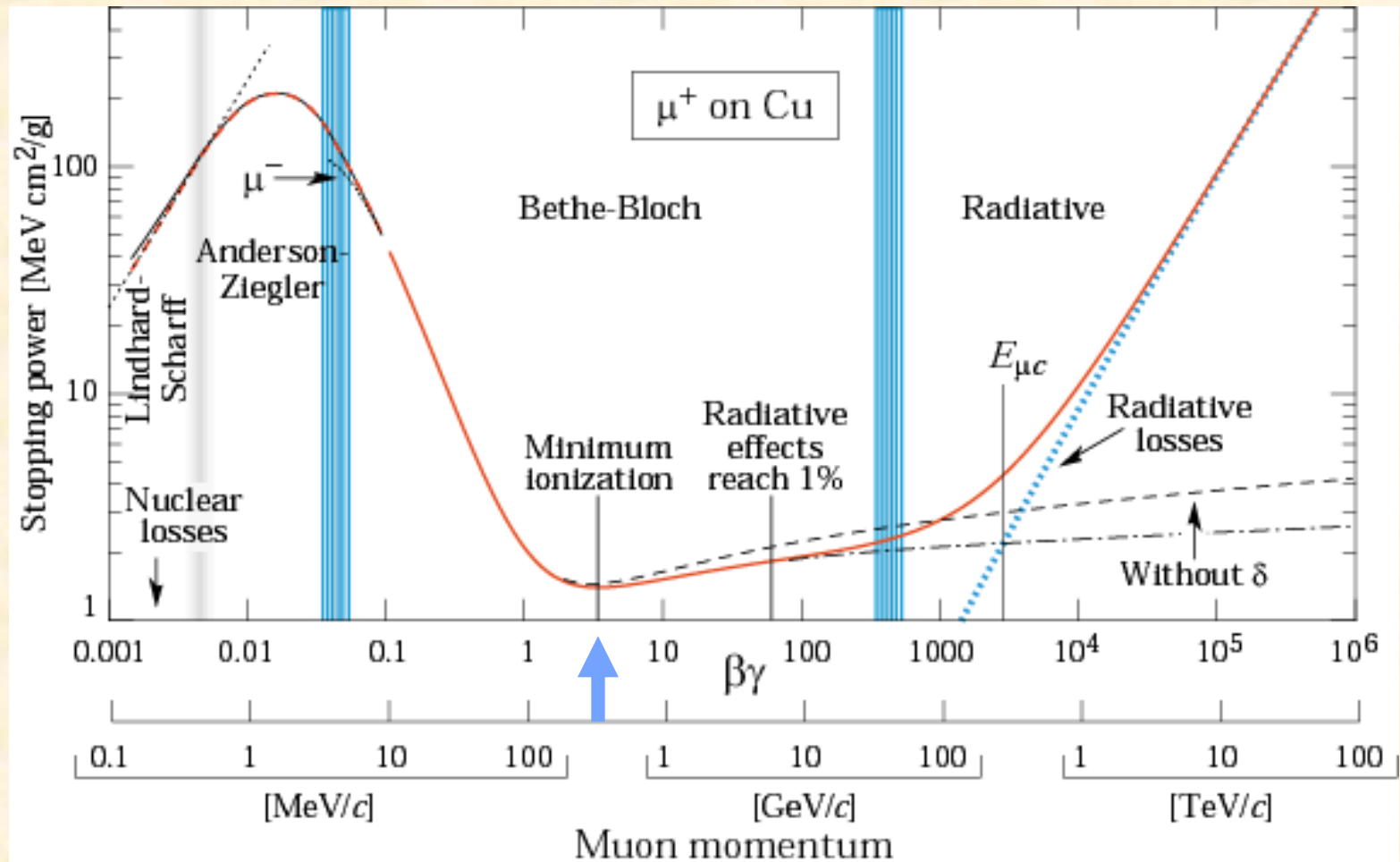

Cherenkov radiation detectors

Unique tool to identify charged particles with a high separation power over a range of momentum from few hundred MeV/c up to several hundred GeV/c

A charged particle with velocity $\beta=v/c$ in a medium with refractive index $n=n(\lambda)$ may emit light along a conical wave front.

Radiator
+
Photon detector

The angle of emission is given by:

$$\cos \Theta_c = \frac{1}{\beta \cdot n} \quad \begin{array}{l} \cos \theta_{\max} = 1/n \\ \beta_{\min} = 1/n \end{array}$$

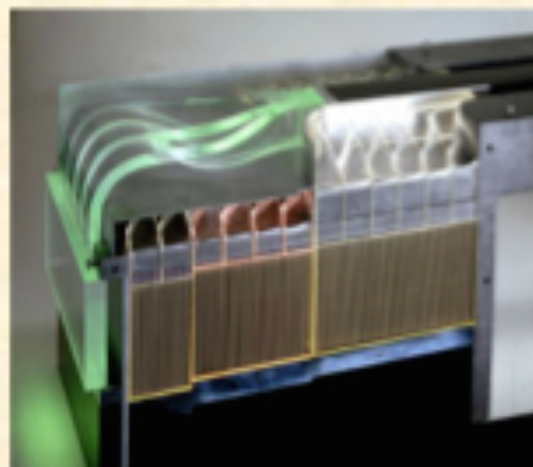

- Particle ID : Threshold (detect Cherenkov light) and Imaging (measure Cherenkov angle) techniques
- Fast particle counters, tracking detectors, performing complete event reconstruction,

Neutrino detectors

To Backup

Stopping power

- We have seen that to stop a 450 GeV muon beam one needs 900m of concrete.
- Muons interact mostly by electromagnetic interaction.
- Neutrino are neutral and interact only through the weak interaction
=> most of them will go through a 900m block of concrete without interacting (and even through the earth)!
- There is no detector capable of detecting all neutrinos from a beam.
=> we can only sample a fraction of the neutrinos passing through a detector

Super Kamiokande

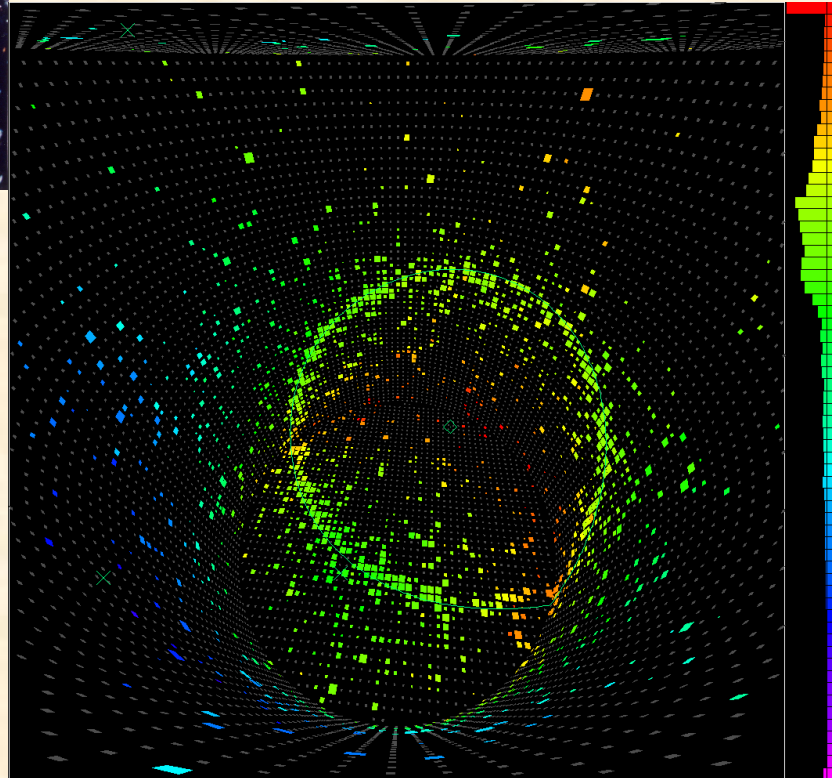
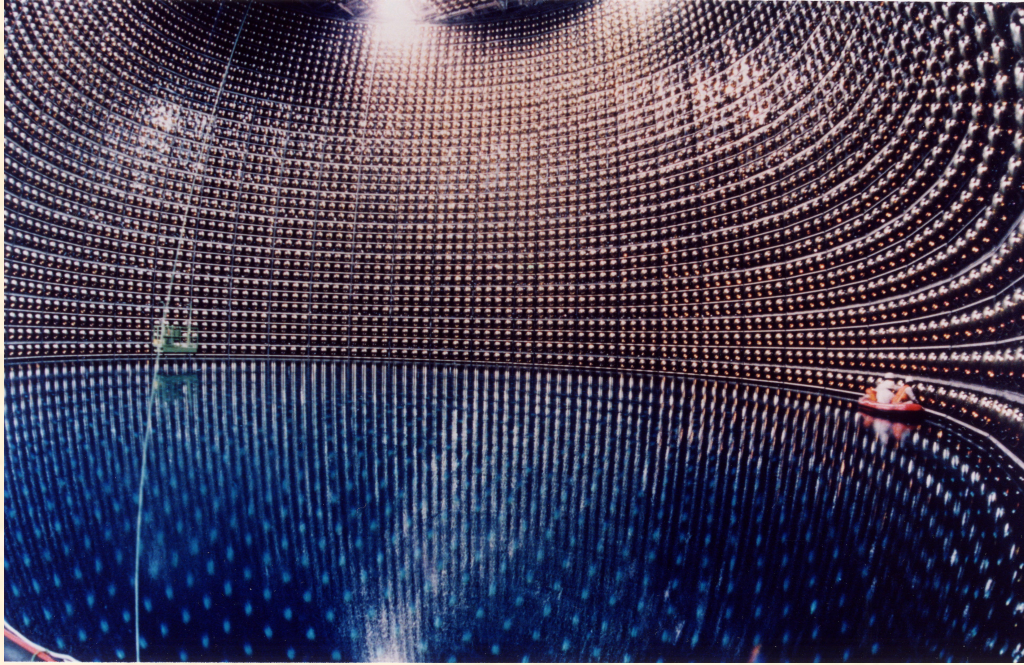

- One of the most successful neutrino observatory (Nobel prize 2002)
- 50 000 tonne of pure water
- Located under Mount Kamioka in Japan.

Sudbury Neutrino Observatory

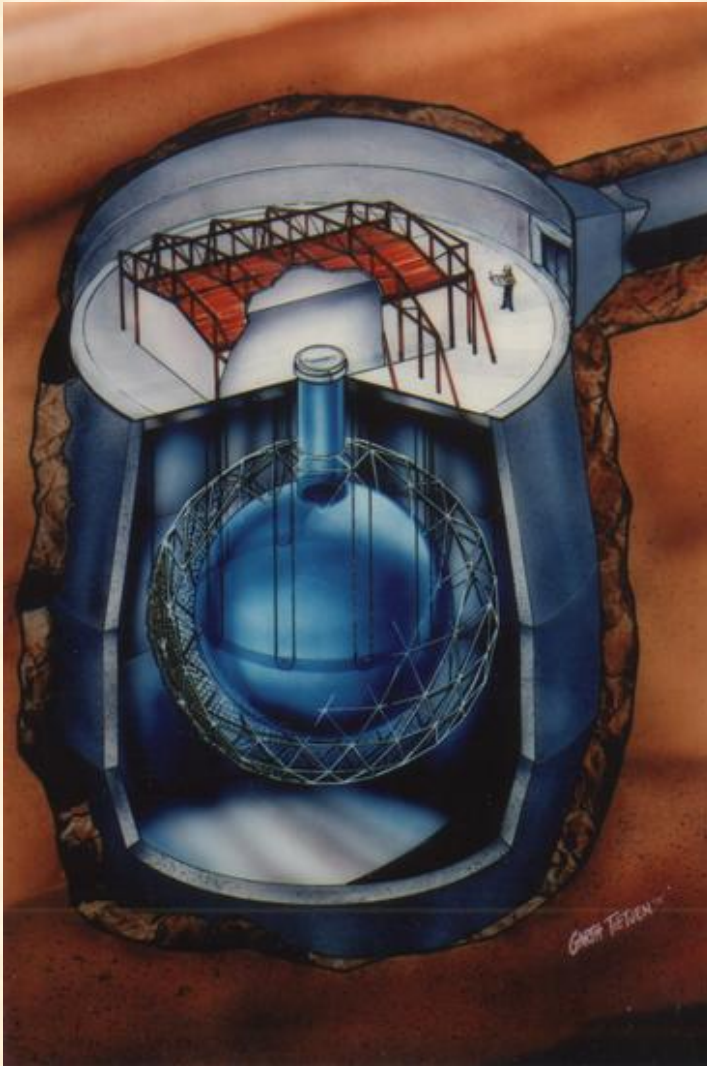

- 1000 tonnes of heavy water.
- Located in Ontario, Canada
- Because heavy water contains a lot of neutrons, SNO is sensitive to both Neutral currents and charged currents
=> unique in the world.
=> Confirmed solar neutrinos oscillations

Antares / IceCube

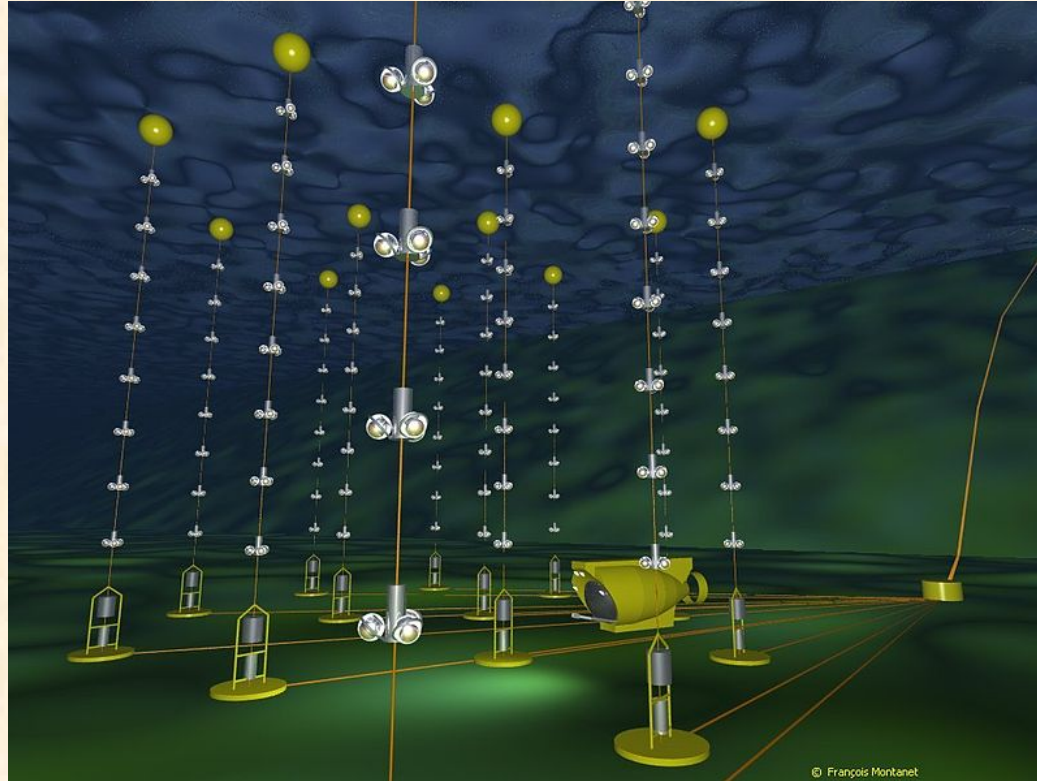

- Because neutrino are (almost) unaffected by matter, they may give a different picture of the Universe than photons or cosmic rays
=> Neutrino telescopes in sea, lake (Baikal) or ice!

To Backup

- From relativistic kinematics, the relation between energy E , momentum p , and (rest) mass m is: $E^2 = p^2 + m^2$
- Consider a particle that decays and gives two daughter particles:

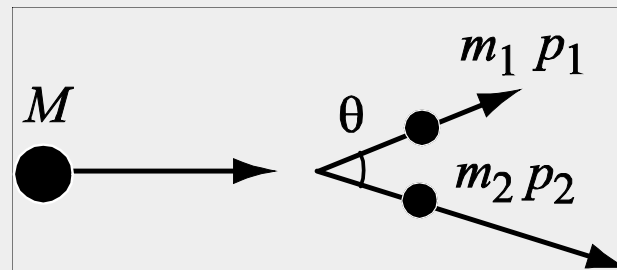

- The invariant mass of the two particles from the decay:

$$M^2 = m_1^2 + m_2^2 + 2 (E_1 E_2 - p_1 p_2 \cos \theta)$$

- to reconstruct the parent mass a precise knowledge of the momentum and the angle θ of decay products is needed, there are obtained :
- from the tracking system,
 - and their particle type, which determines their masses m_1 and m_2

Example: find Higgs boson via its decay :

$$p + p \rightarrow H X \rightarrow Z^0 Z^{0*} X \rightarrow e^+ e^- \mu^+ \mu^- X$$

Compute (from the measured kinematics) :

$$m_H^2 = (E_{Z^0} + E_{Z^{0*}})^2 - (\vec{p}_{Z^0} + \vec{p}_{Z^{0*}})^2$$

Also for each Z^0 compute (e.g. for $Z^0 \rightarrow \mu^+ \mu^-$) :

$$m_{Z^0}^2 = (E_{\mu^+} + E_{\mu^-})^2 - (\vec{p}_{\mu^+} + \vec{p}_{\mu^-})^2$$

The same for the other Higgs decay mode : $H \rightarrow \gamma\gamma$

In all cases we have to reconstruct tracks (EM clusters for photons) and measure momenta, energies and identify particles (charge and mass hypothesis).



Hadron Colliders: Kinematics

• Given the characteristics of the collisions lets define some useful variables

• **Transverse momentum, p_T (very useful)**

- Particles that escape detection ($\theta < 3^\circ$) have $p_T \approx 0$
- Transverse momentum conserved imply $\sum p_{Ti} \approx 0$
- **Longitudinal momentum and energy, p_z (not useful)**

• If particles that escape detection have large p_T

- It imply that the visible $\sum p_{Ti}$ is not conserved

• **Polar angle, θ (very useful)**

- Not Lorentz invariant
- Rapidity: y

$$y = \frac{1}{2} \ln \frac{E + p_z}{E - p_z}$$

For $m=0$

$$y = \eta = -\ln\left(\tan \frac{\theta}{2}\right)$$

• Pseudorapidity: η

• **Azimuthal angle, ϕ (very useful)**

- Well measured since detectors have complete coverage and are azimuthally symmetric at a given η

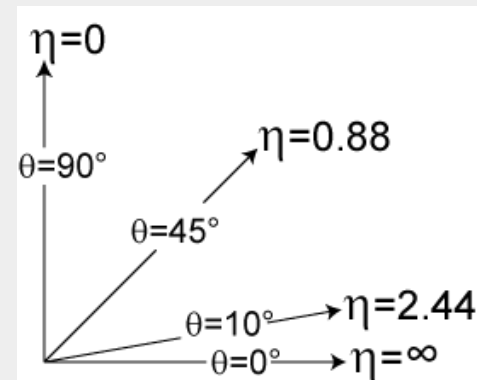

Ionization

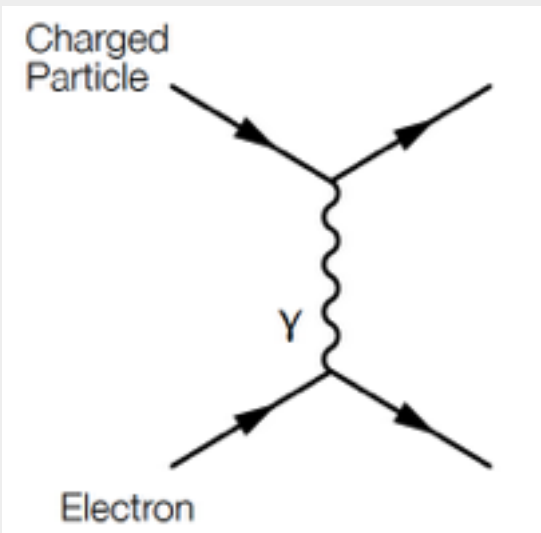

Pair production

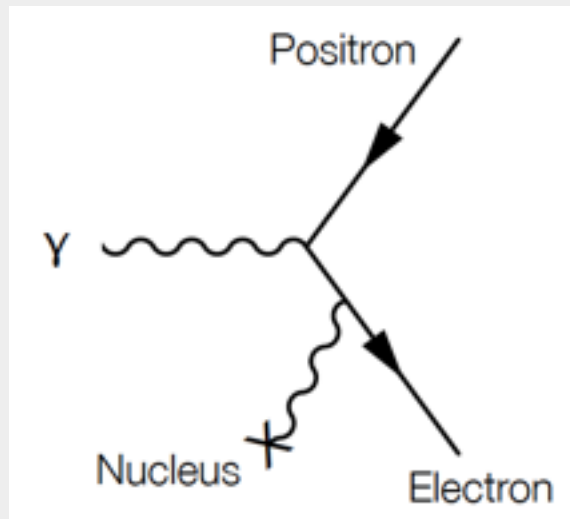

Compton scattering

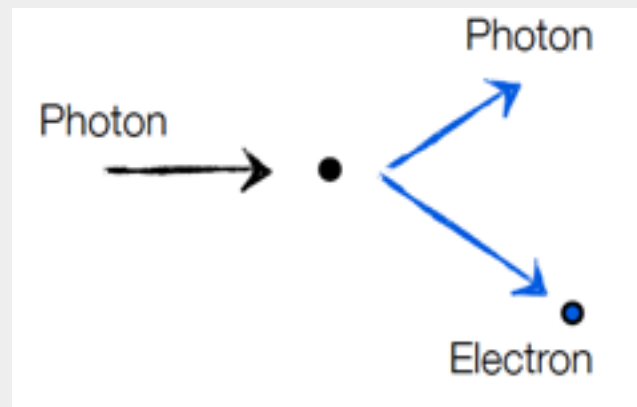
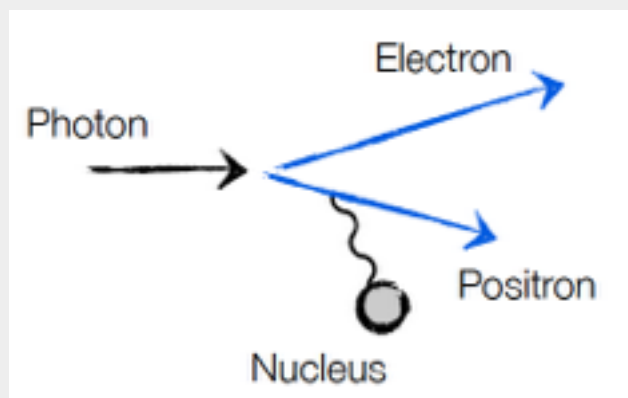
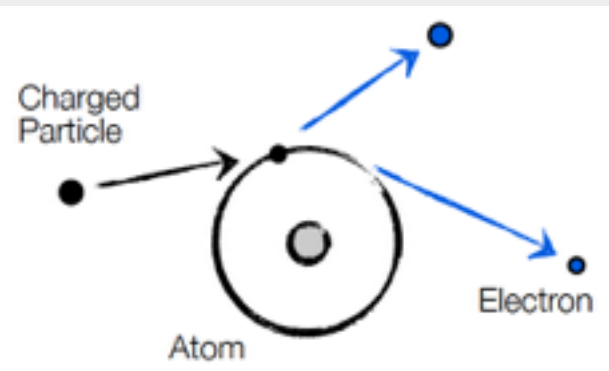
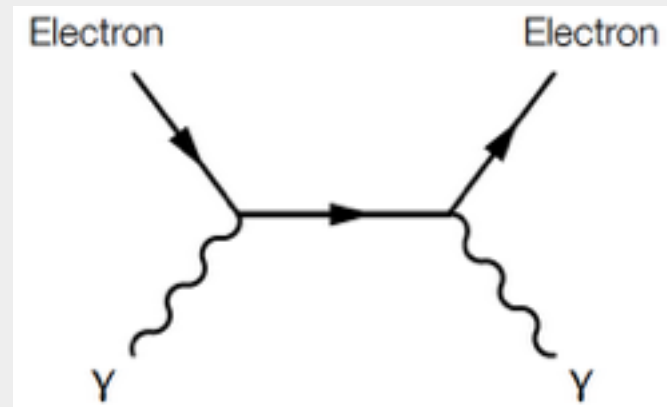

Delta-electrons

Non-destructive methods: charged particles

Gaseous detectors

Measure: hit and/or drift time

- Position resolution: $\sim 50 \mu\text{m}$
 - Tracks reconstruction
- + Magnetic field
 - Momentum

Measure: energy losses dE/dx

- Particle ID

Silicon detectors

Measure: hits and/or amplitude

- Position resolution: $\sim 5 \mu\text{m}$
 - Tracks & **Vertices** reconstruction

Cherenkov detectors

Measure: Cherenkov photons

- Particle ID

Transition radiation detectors, ...

To Backup

Destructive methods

Calorimeters: electromagnetic and hadronic

Measure: shower energy and/or shower shape

→ Energy resolution

→ Position resolution: ~few mm

→ Particle ID

Muon detectors

Measure: hits

→ Muon track reconstruction after absorber

→ Particle ID

Typical arrangement of subdetectors

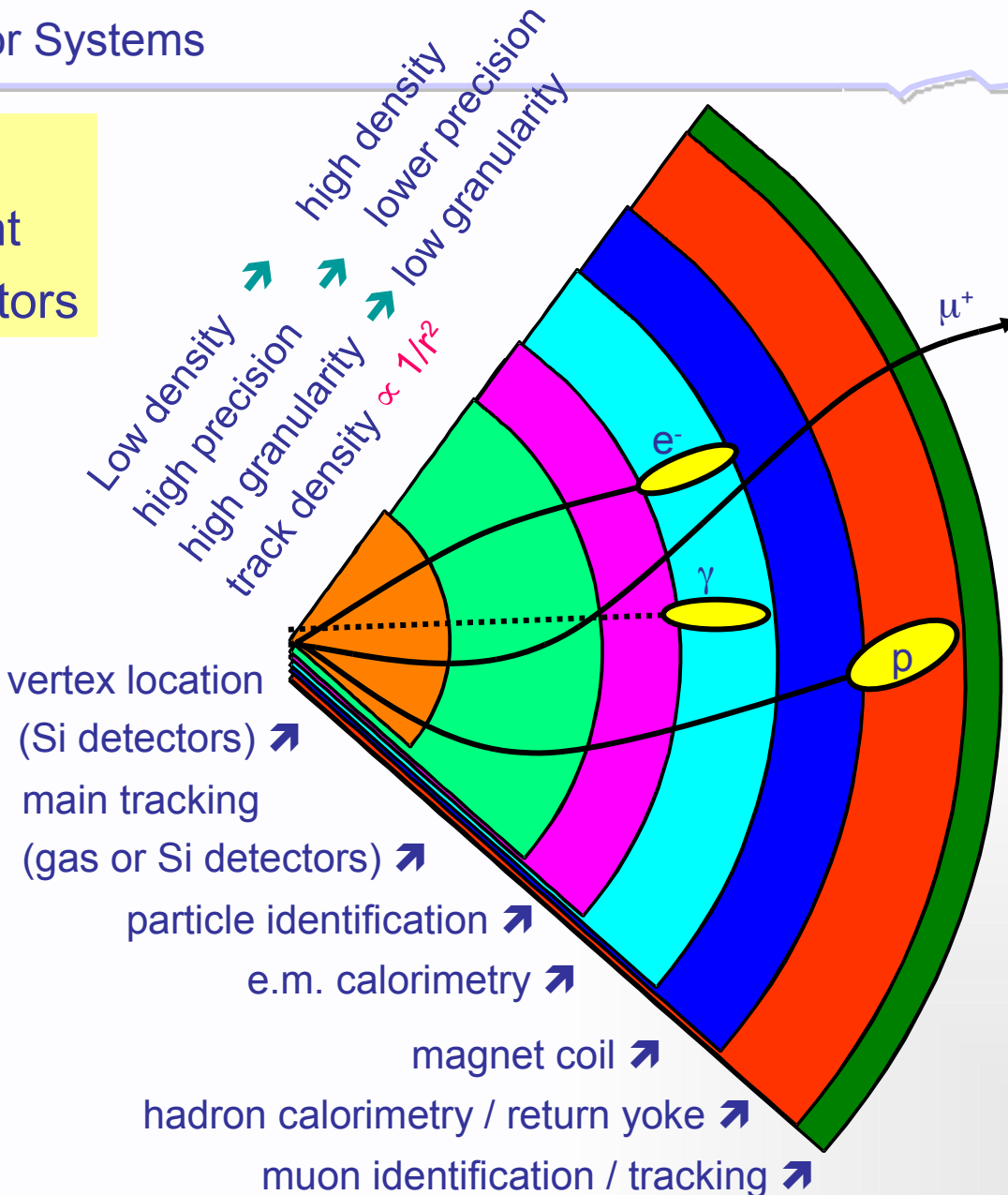

ATLAS and CMS require high precision tracking also for high energetic muons → large muon systems with high spatial resolution behind calorimeters.

IN A P-P COLLISION

