

Status, Progress and Plans for CLIC Beam Delivery System

Deepa Angal-Kalinin

ASTeC, STFC Daresbury Laboratory and
The Cockcroft Institute

Outline

- ❑ CLIC BDS designs
- ❑ Updates since CLIC08
- ❑ Preparation for the CDR

CLIC Beam Delivery System Layout : 3 TeV CM

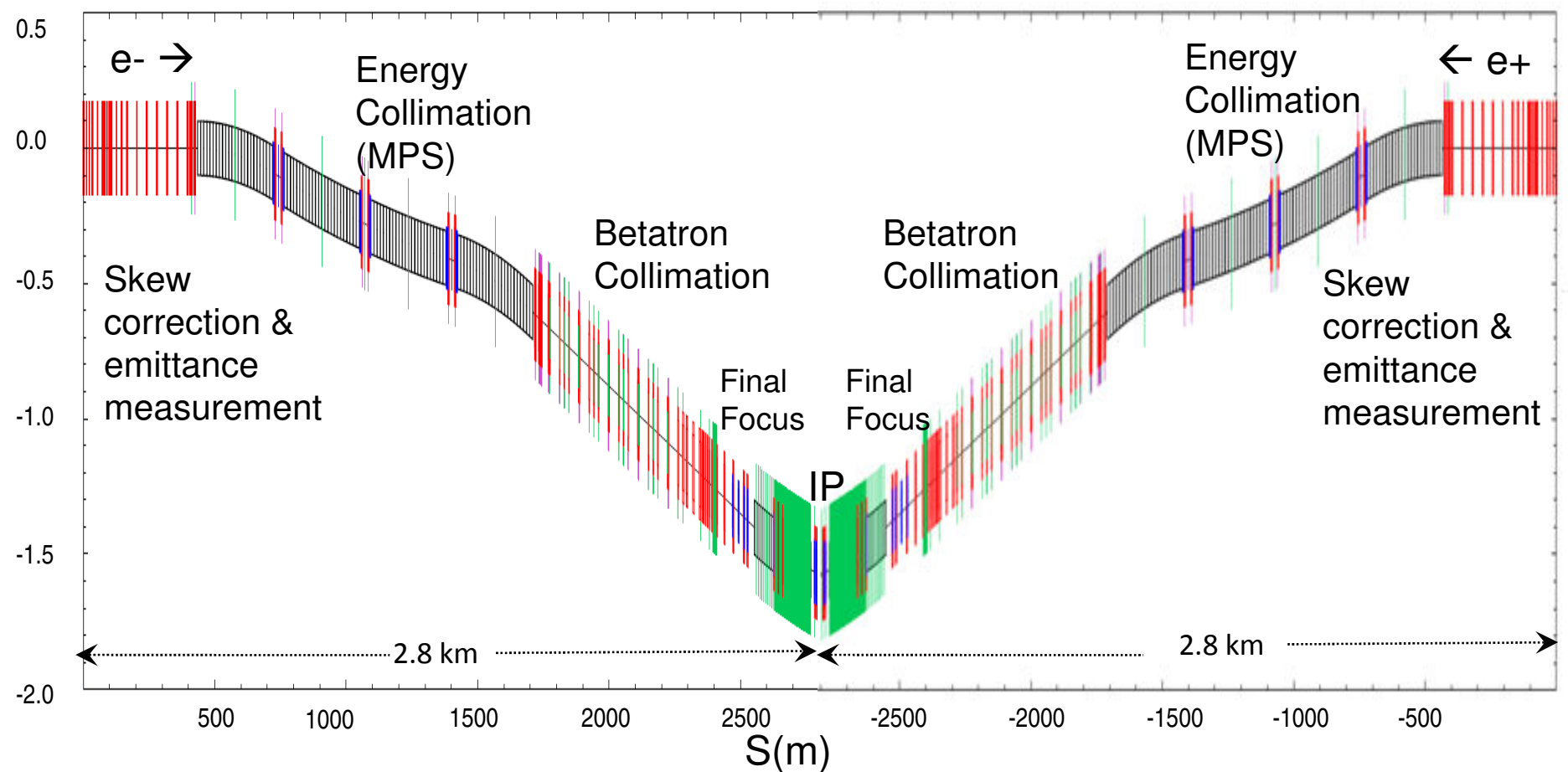

One interaction region @crossing angle of 20 mrad with push-pull arrangements for two detectors.

Optics of 1.5 TeV BDS

Diagnostics Energy Collimation Betatron Collimation Final Focus

$L^* = 3.5$ m
Total length = 2.75 km

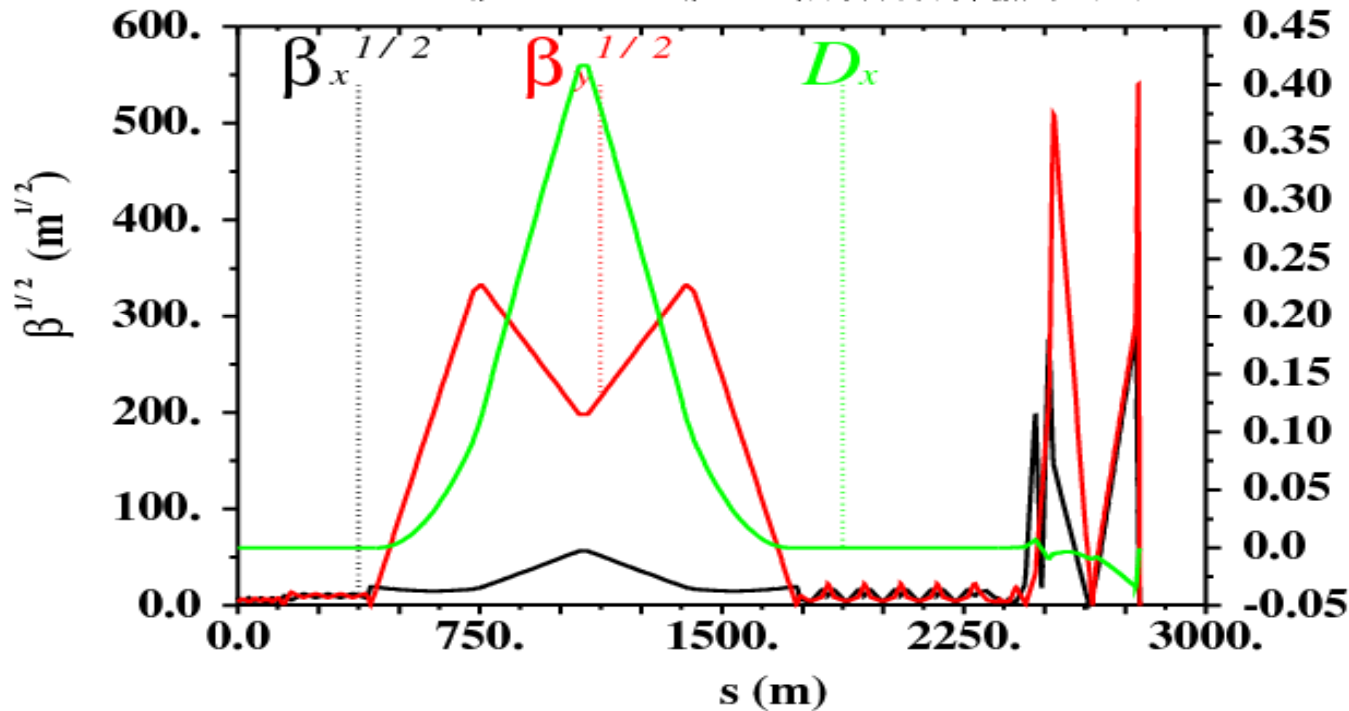

IP beam parameters

β_x^*	6.94 mm
β_y^*	0.068 mm

Optics of 250 GeV BDS

Shorter beam delivery system design at 500 GeV CM.

Design optimised from beam dynamics point of view : beam spot at energy spoiler & better control of aberrations

$L^* = 3.5$ m

Total length = 1.73 km

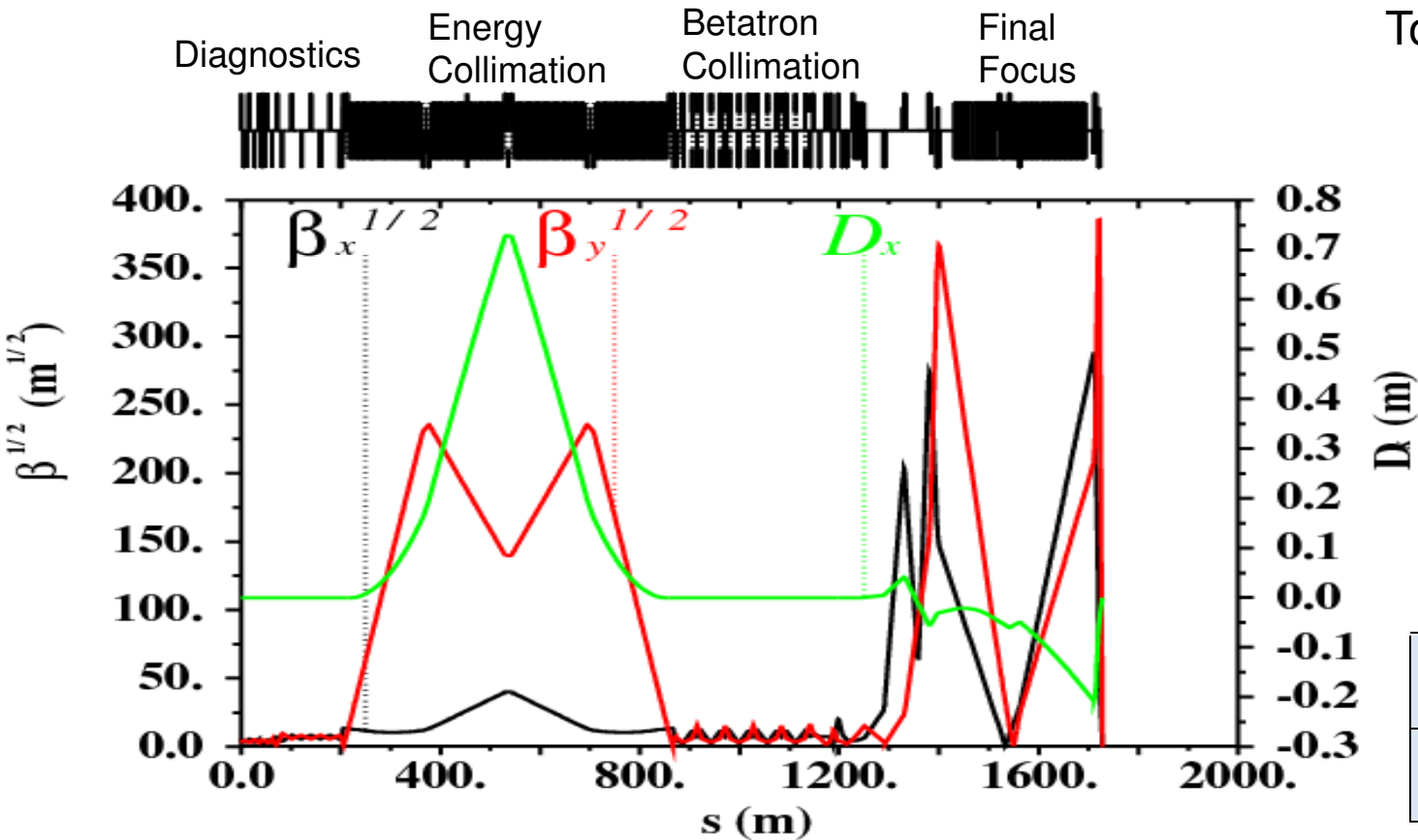

IP beam parameters

β_x^*	8.0 mm
β_y^*	0.2 mm

Layout for 500 GeV and 3 TeV CM designs

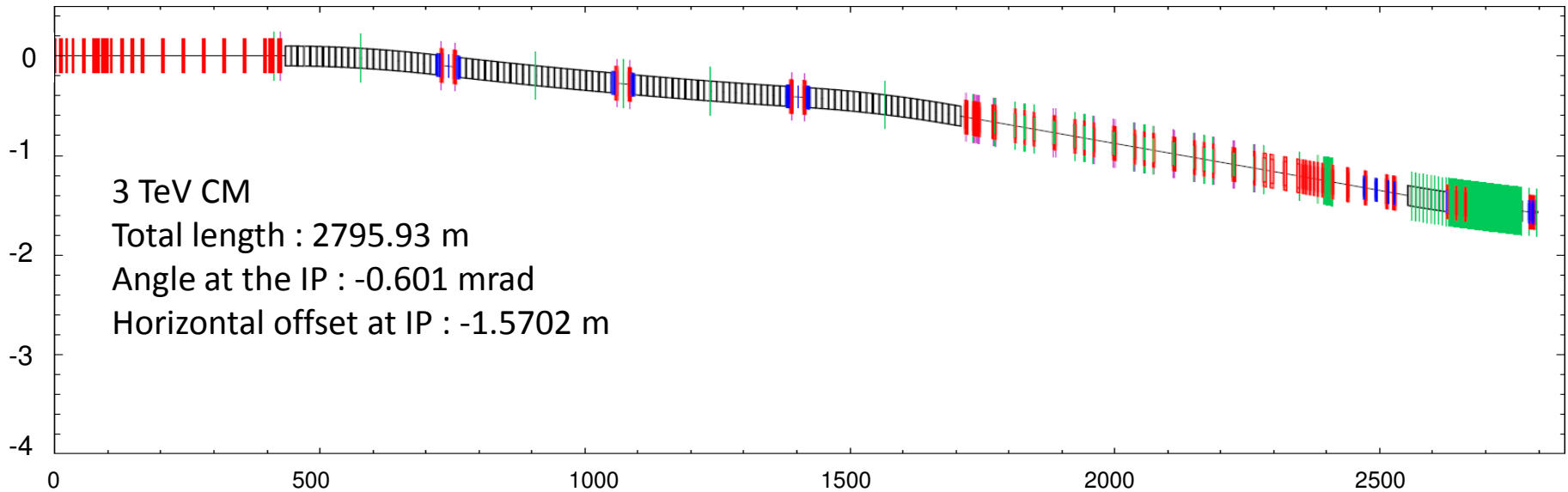

- Keep the locations of IP, post collision lines and main beam dumps the same.
- Need to optimise the design considering the upgrade scenario.

'From 500 GeV to 3 TeV', D. Angal-Kalinin, WG3, Wednesday

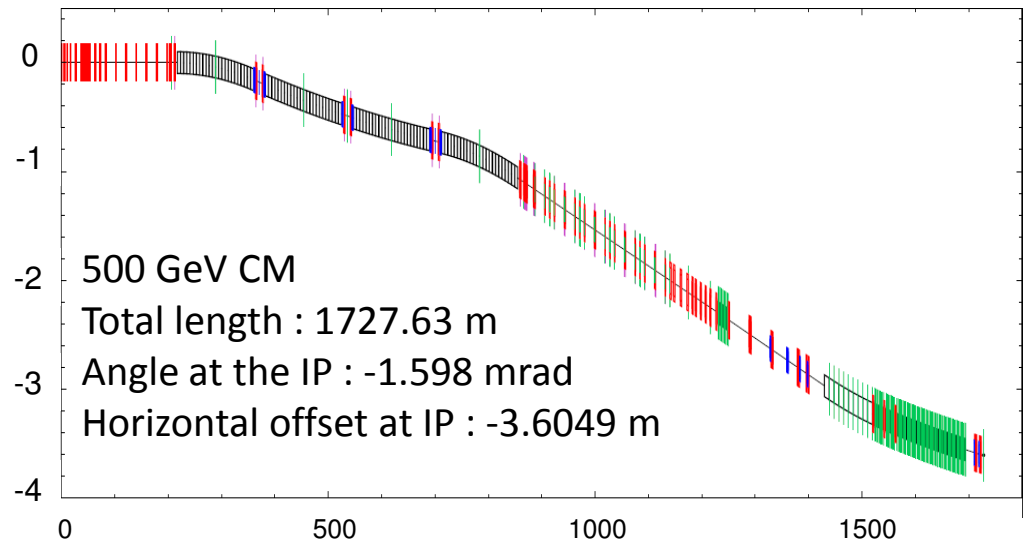

Energy Collimation

- ❑ Protection against mis-steered or errant beams with energy errors $> 1.3\%$. E-spoiler half-gap: $a_x = D_x \delta = 3.51 \text{ mm}$
- ❑ The energy spoiler needs surviving a deep impact of an entire bunch train
- ❑ Need suitable material and geometry for survivability and wake fields
- ❑ Be spoiler proves to be suitable but reach fracture temperatures. The implications of fractures need to be understood better
- ❑ Other alternatives 'crystal', 'dielectric' in R&D stage

*'Collimation review', J. Resta Lopez,
'Dielectric collimators', A. Kanareykin,
WG3, Wednesday*

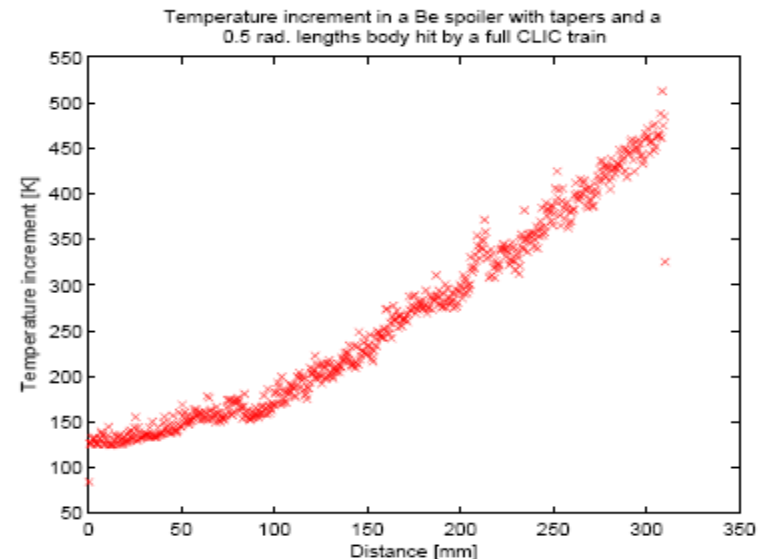
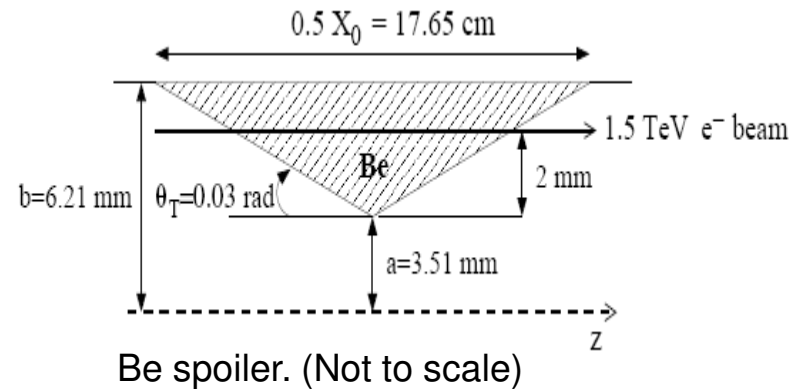

Will not reach melting temp (1267K)
but will reach fracture temp (370 K)

J.L.Fernandez-Hernando

Betatron Collimation

- ❑ 4 pairs of collimators in x,y plane to collimate at IP/FD phases.
- ❑ New optimisation of betatron collimation depths using ray-tracing calculations along Final Doublet (B. Dalena).
- ❑ New collimation depths : $15 \sigma_x$ & $55 \sigma_y$ (compared to old $10 \sigma_x$ and $44 \sigma_y$).
- ❑ New collimation apertures : 0.12 mm in x and 0.1 mm in y (old 0.08 mm in both x & y)
- ❑ Collimation efficiency and loss of luminosity in presence of wakes
- ❑ Consumable spoilers (synergies with LHC phase 2 collimation)

Talks by J. Resta Lopez & F. Jackson,
Wednesday, WG3

Collimator Wakefields + $0.2 \sigma_y$ vertical beam position jitter effect

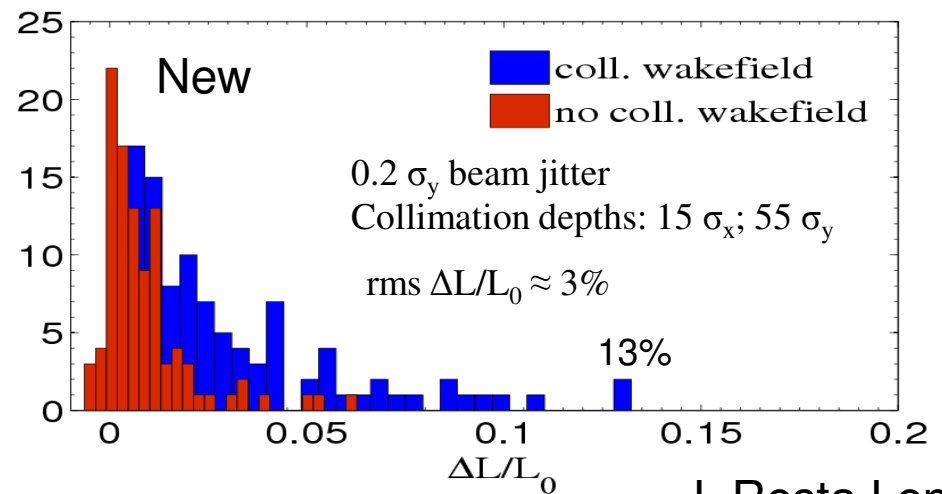
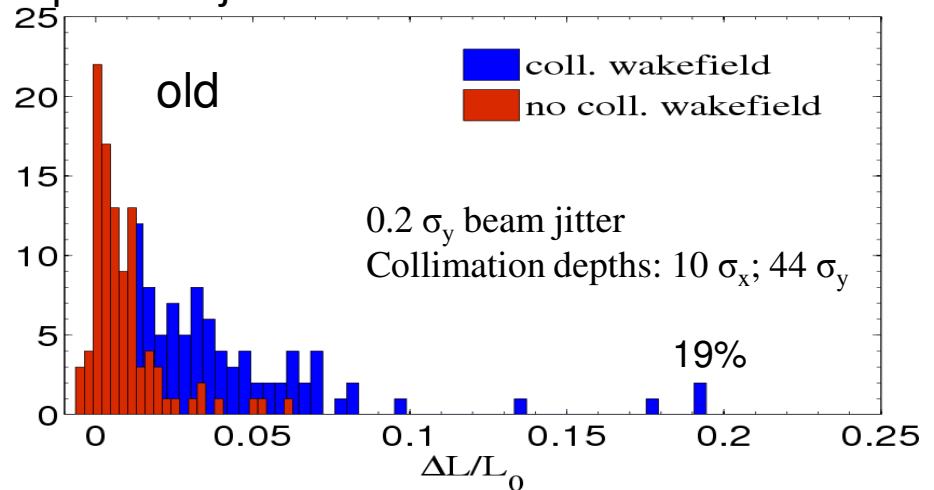

J. Resta Lopez

Loss Map along BDS & backgrounds

- Development of codes for realistic simulations (BDSIM-PLACET interface, HTGEN-PLACET)
 - collimation studies simultaneously including wakefield effects and production of secondary particles
 - Muon flux estimates : $\sim 2 \times 10^5$ muons per train. Will need magnetized tunnel fillers.

'HTGEN and muons in the CLIC BDS', H. Burkhardt

'Beam-beam backgrounds', B. Dalena

'Very Forward Region and Beam-Beam-Background', A. Sailer

Wednesday, WG3

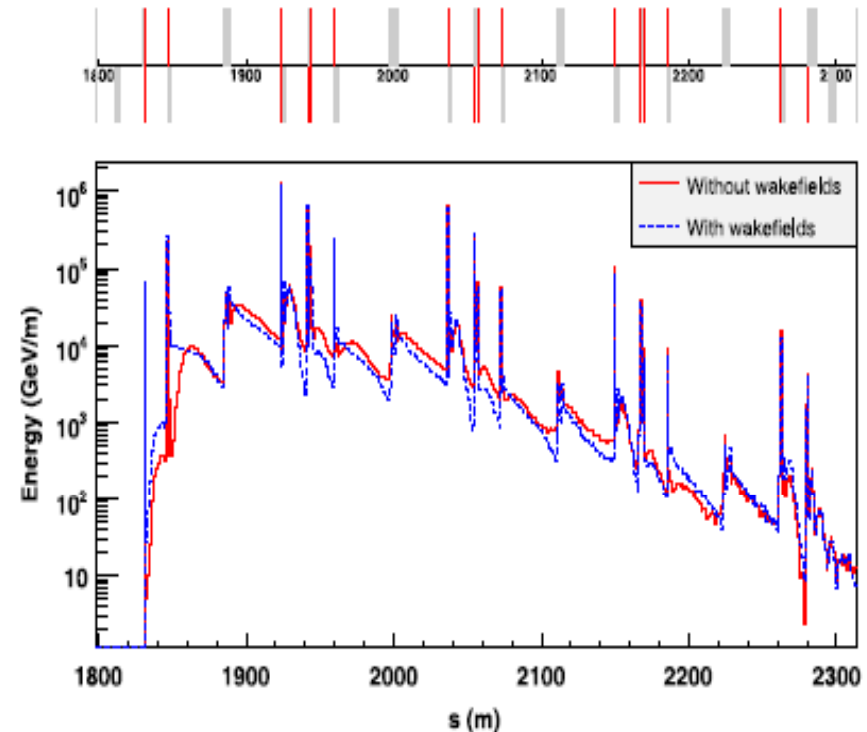

Energy deposition along BDS from halo particles, with & without wake fields.

[Agapov et al, PRSTAB 2009]

Luminosity loss due to ISR

- Luminosity Loss due to ISR in CLIC-BDS at 3TeV CM $\sim 20\%$
 - $\sim 10\%$ of luminosity loss due to Final Doublet.
 - $\sim 10\%$ of luminosity loss due to SBEND in the FFS.
- Interaction region studies
 - Luminosity loss due to detector solenoids depend on field shape and its overlap with QD0
 - Anti-DID increases the luminosity loss up to 25%
 - Vertical spot size increase

Position of emitted photons

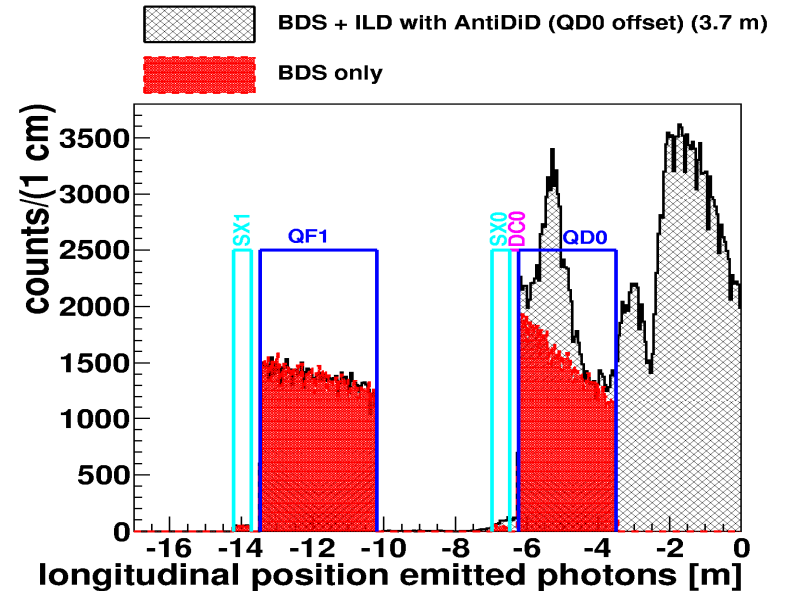

'Solenoid and SR effects', B. Dalena, WG3, Wednesday

'Solenoid effects and compensation', B. Dalena, WG5, Wednesday

B. Dalena

Crab System

- ❑ Critical issues for crab system
 - ❑ Synchronisation between cavity RF phases on e+ and e- sides : CLIC 6 fsec (ILC 83 fsec)
 - ❑ Wake fields from the crab cavities
- ❑ CI (EUCARD) is focusing on these critical issues in collaboration with SLAC
- ❑ Proposed travelling wave structure with high group velocity and one Klystron (>20 MW pulsed) with output phase control and Intra bunch delay line adjustment for phase control

- ❑ Significant progress on the design since CLIC08, planned beam tests at SLAC to determine the maximum gradient for the proposed structures and beam tests at CTF3 to validate other critical parameters

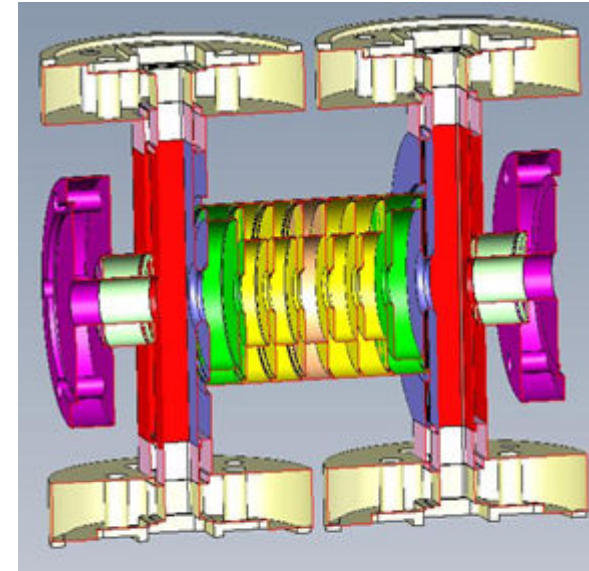

Cavity under construction @CI

'Crab cavities', A. Dexter, WG5, Wednesday.

Final Focus Tuning

- ❑ CLIC IP beam parameters ($\sigma_y=1\text{nm}$, $\xi\sim 60000$) are most challenging compared to FFTB, ATF2, ILC
- ❑ Tuning algorithms are fundamental.
- ❑ Need to improve tuning performance:
 - ❑ Explore other algorithms than simplex
 - ❑ Tune in a beta squeeze sequence
 - ❑ Relax the optics
- ❑ Crucial to achieve $10\ \mu\text{m}$ pre-alignment.

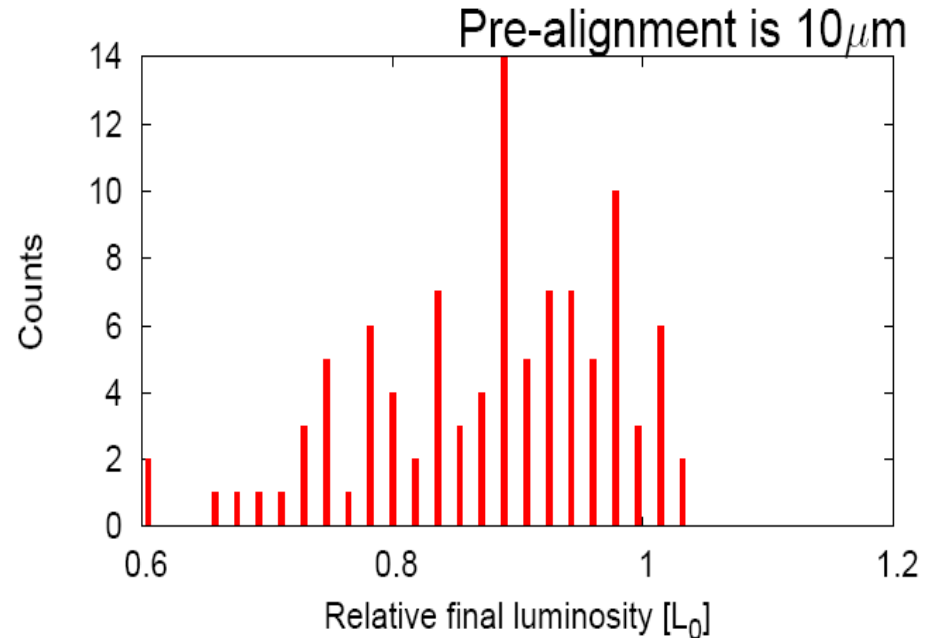

Present status of FFS tuning : 80% of the cases reach 80% of the luminosity in 18000 iterations.

CLIC08 : $L^* = 8\text{m}$ proposal

A. Seryi proposed to double the L^* to simplify achieving stability of FD and ease the MDI.

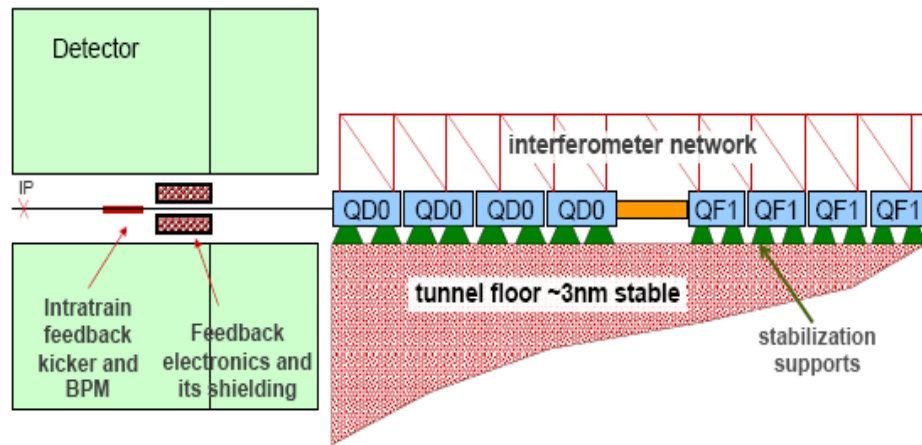

	$L^*=3.5\text{ m}$	$L^*=8\text{m}$
Luminosity	L_0	$0.72L_0$
β_y	0.07 mm	0.1 mm
QD0 jitter	0.15 nm	0.18 nm
QD0 support	detector	ground
QD0 tech	PM	PM
QD0 grad tolerances	5×10^{-6}	3×10^{-6}
Final focus length	400 m	800 m
Chromaticity	ξ	2ξ
Prealignment	$10\ \mu\text{m}$	$2\ \mu\text{m}$

R. Tomas

*'Review of FFS design, options and Tuning',
A. Seryi, WG3, Wednesday.*

IP Intra-train beam based feedback

- ❑ To correct beam-beam relative position at the IP, a strip-line kicker is located upstream of QD0, BPM at $\pi/2$ phase advance from IP
- ❑ Due to latency constraints - no angle intra-train feedback
- ❑ Reducible latency time of ~ 10 ns (electronics) + TOF – demonstrated by FONT3
- ❑ The IP Feedback is able to recover $\sim 99\%$ of the nominal luminosity for Ground Motion model A, 98% for model B, 31% for model C and 42% for model K

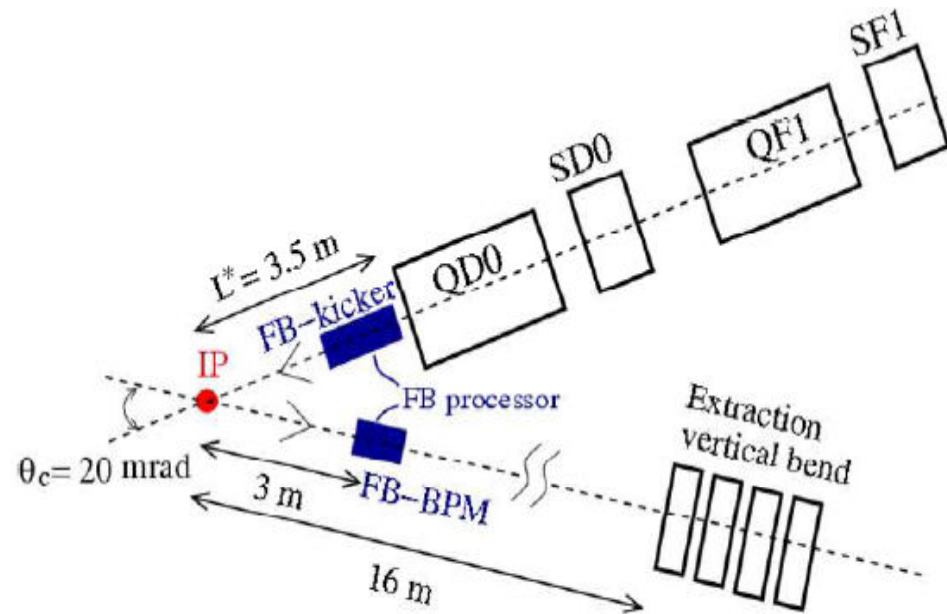

'IP beam feedbacks', J. Resta Lopez, WG5, Wednesday

Upstream polarimetry & spectrometry

- ❑ No dedicated chicanes for these measurements due to space constraints, but suitable location exists in the energy collimation chicane with 20m drift space for laser beam crossing & is upstream of energy collimation which is desirable.
- ❑ Conceptual layout using first dipole of energy collimator chicane to measure the energy with resolution of 0.04%. Needs to be included in the lattice by adjusting the fields of first dipoles to provide the required drift space. Should not affect the optics severely.

May be possible to include dedicated chicanes for both polarimetry and spectrometry at 500 GeV CM if different layout is acceptable?

'Polarimetry at CLIC', T. Hartin, WG5, Thursday

Collective effects

- ❑ Ion instability : not developed if pressure in BDS < 10 nTorr
- ❑ Resistive wall wake fields : 8mm Cu beam-pipe is enough to neglect resistive wall. Only QD0 has small aperture.
- ❑ Collimator & crab wakefields
- ❑ Coherent synchrotron radiation – negligible.

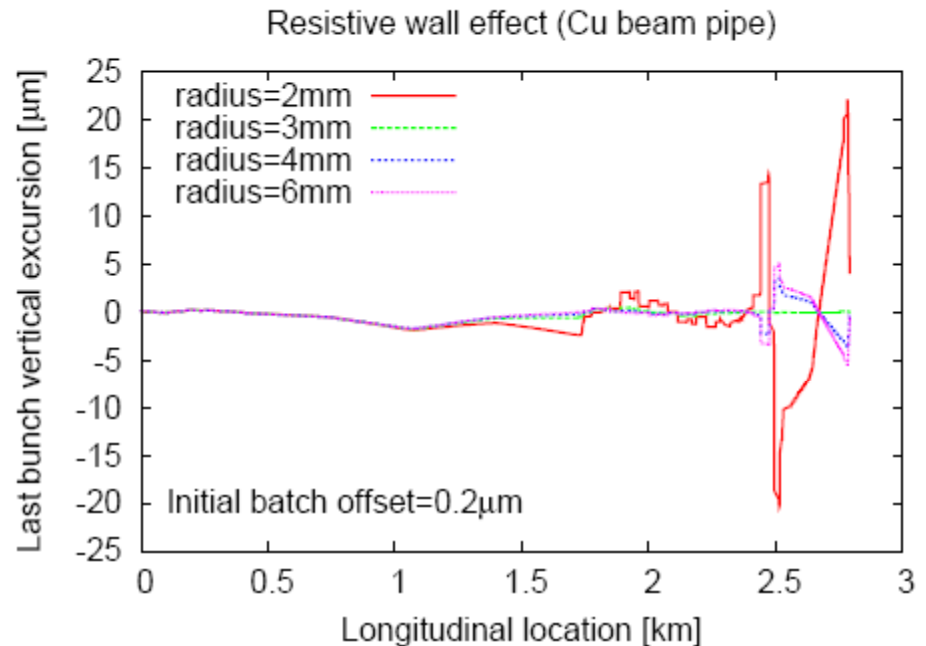

'Collective effects review', G. Rumolo, WG3, Wednesday

Post Collision Line

(Uppsala, CERN, CI)

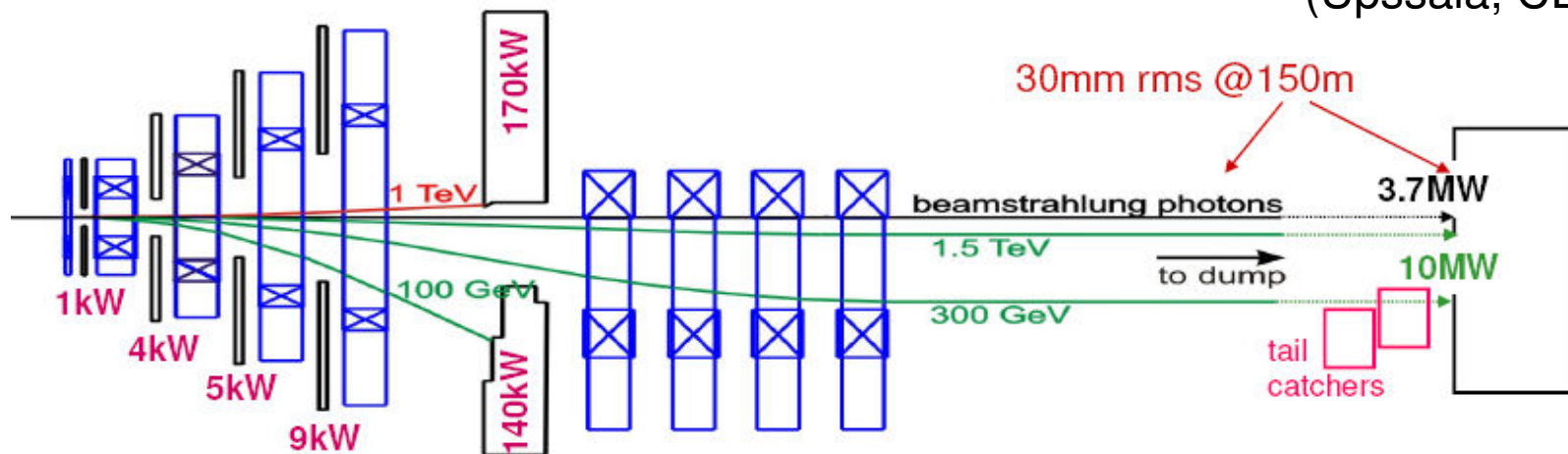

Beam power: 10 MW, beamstrahlung power : 4MW, coherent pairs : 170kW

Vertical chicane to separate particles from the e+e- pairs with the wrong sign charge & low energy tail. Work in progress for realistic beam line, beam diagnostics, background to the IP.

'Post collision line review' E. Gschwendtner & 'Electromagnetic background from the spent beam line', M. Salt , WG3, Wednesday

ILC Beam Dumps

- ❑ ILC needs 17 MW beam dump (@1 TeV CM)
- ❑ Substantial progress (SLAC + BARC, India) in the dump design since CLIC08.

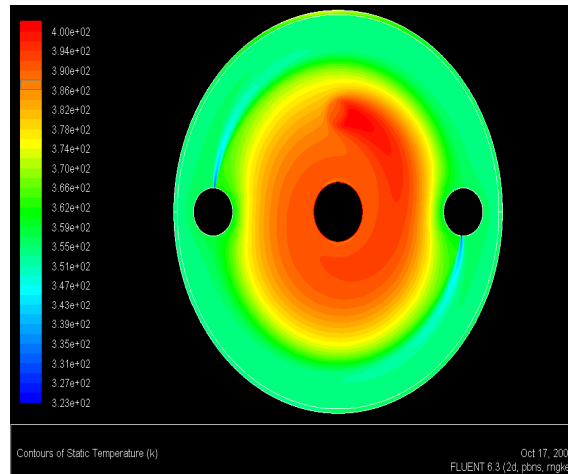
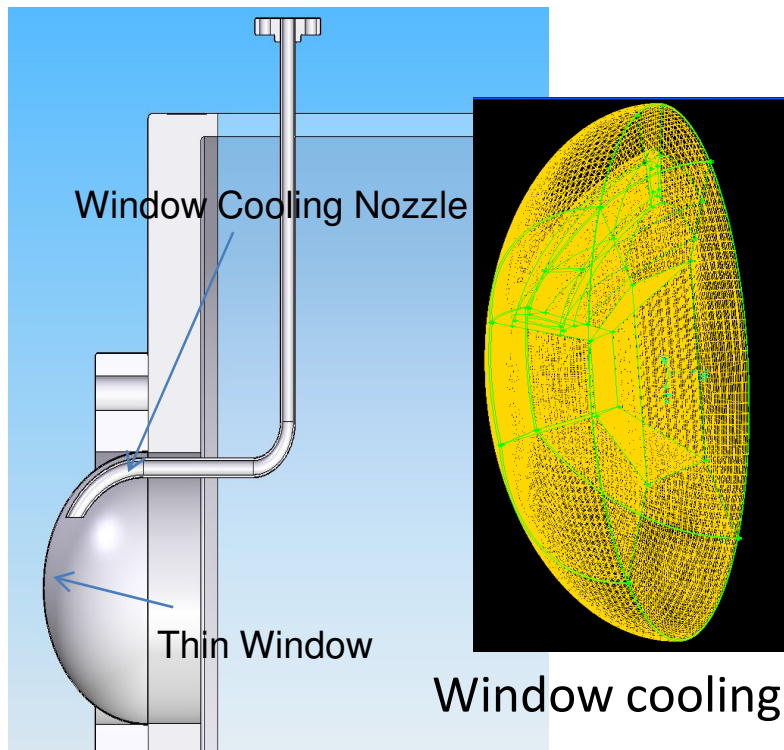

Steady state temperature distribution

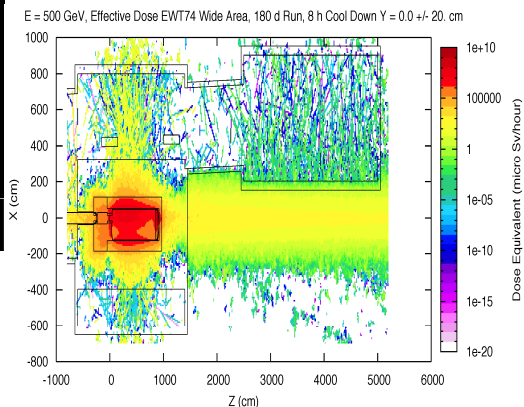

Preliminary activation studies

Beam damage testing of thin windows critical.

ATF2

- Commissioning started December'08
- Measured Extraction emittance is very close to the damping ring emittance.
- Re-producible $\varepsilon_y \sim 10\text{-}30\text{ pm}$: Systematic 'manual' BBA on selected quads and careful dispersion + coupling measurement and correction
- Goal is towards achieving sub- μm σ_y beam size by Dec'09 and first evidence of BSM σ_y measurement

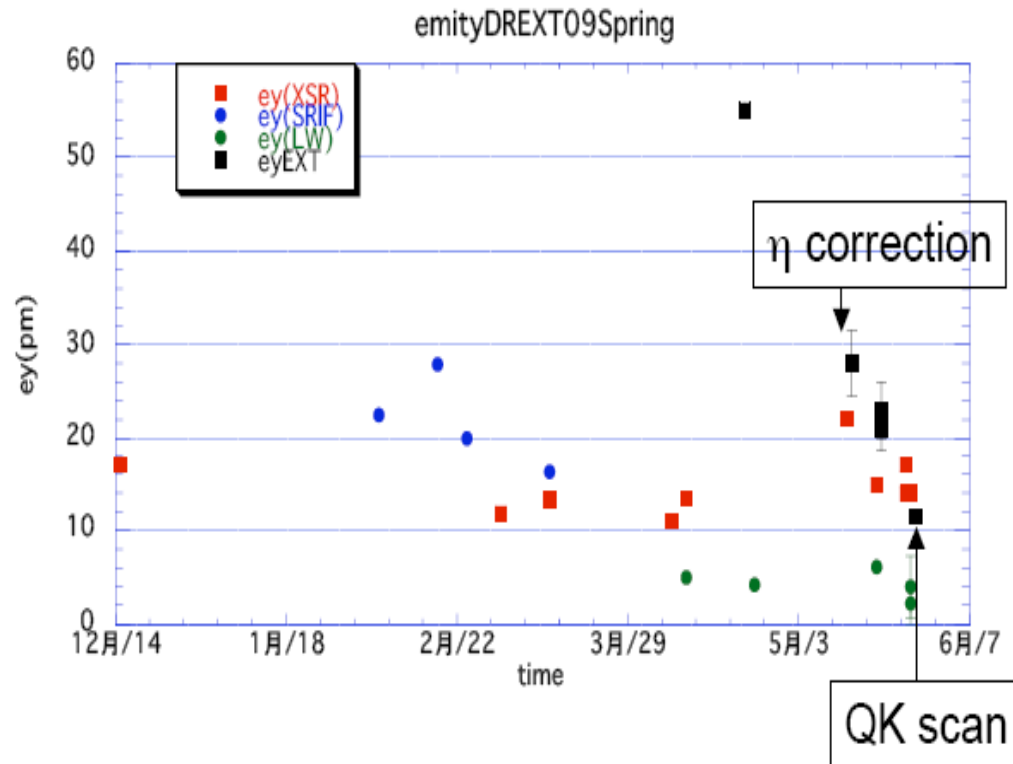

3 ATF2 related talks (Kubo, Okugi, Eduardo), WG3, Thursday

Plans towards CDR

- Assess L* situation (may be intermediate L*?, push-pull, range of L*)
- Specify the requirements of lower energy operations in BDS
- Compatibility of 500GeV lattice with 3TeV lattice
- FFS Tuning algorithms
- Final certification of collimator design
- Crab cavity solution
- SR deposition, secondaries, muon walls
- Post collision line and diagnostics
- Design and optimization of IR region for push-pull
- Temperature stability requirements
- Final Doublet Magnet requirements, radiation damage of PM quads?
-

Hope to have more detailed list at the end of this workshop!

Acknowledgements to
Rogelio Tomas & Javier Resta Lopez for providing CLIC specific
information
&
ATF2 and ILC BDS/MDI colleagues