



# Extraction and Recombination Septa and Kickers status

Jan Borburgh, M. Atanasov, W. Bartmann, L. Ducimetiere, Mike Hourican, T.,  
Kramer, Thierry Masson, Antoine Prost, L. Sermeus

# Outline

- PSB extraction area and septa
- BE.KFA14L1
- BE.SMH15L1
- BT.SMV10
- BT.KFA10
- BT.SMV20
- BT.KFA20
- Conclusions

# Equipment concerned

KFA14L1 - Horizontal  
Extraction Kicker

BESMH - Horizontal  
Extraction Septum

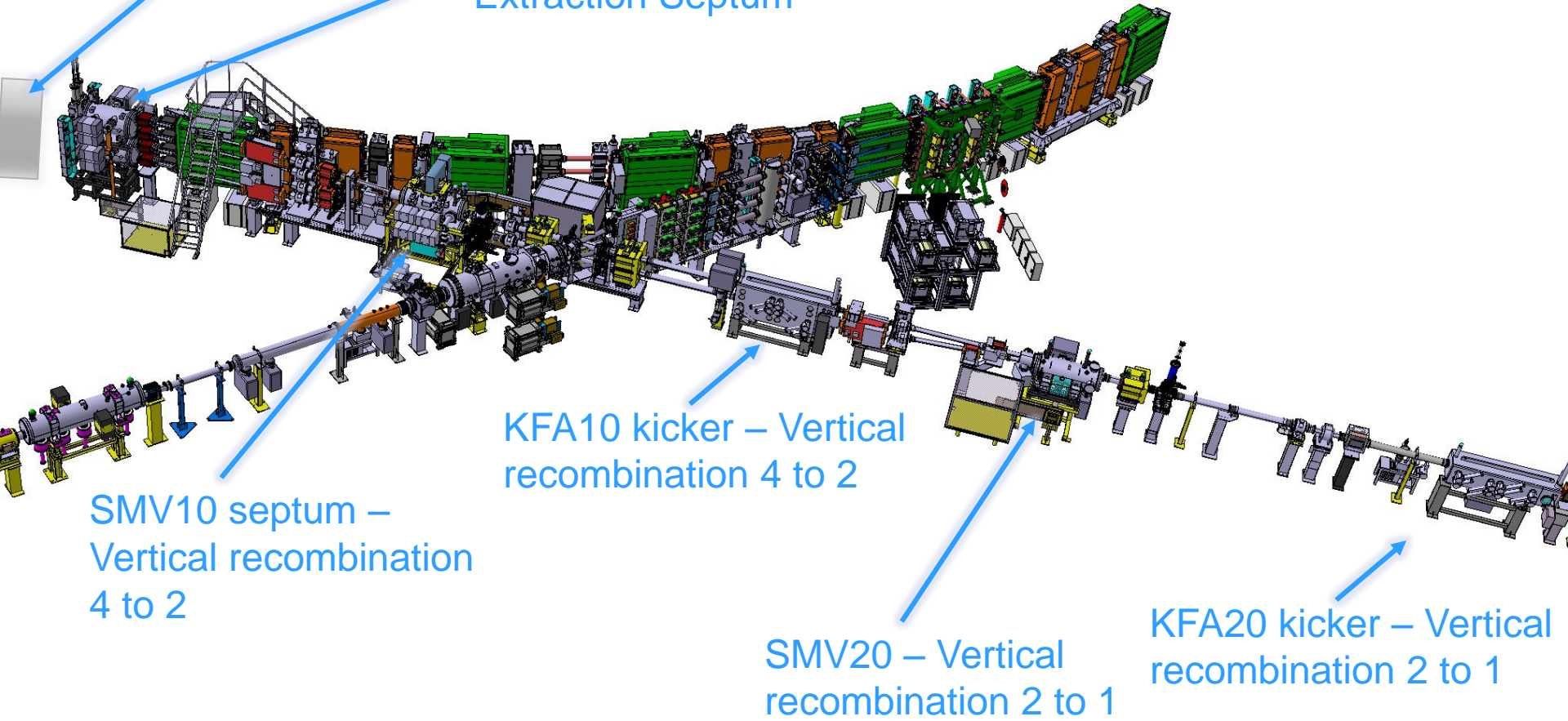

# Extraction BE.KFA14L1

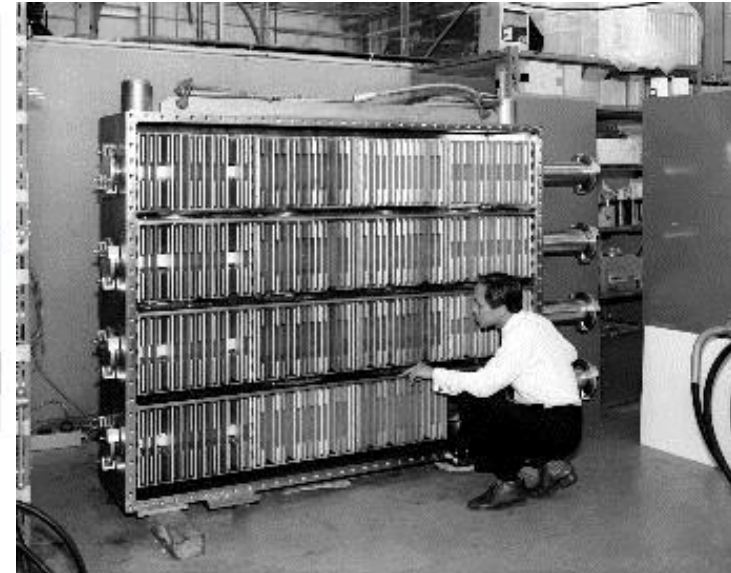
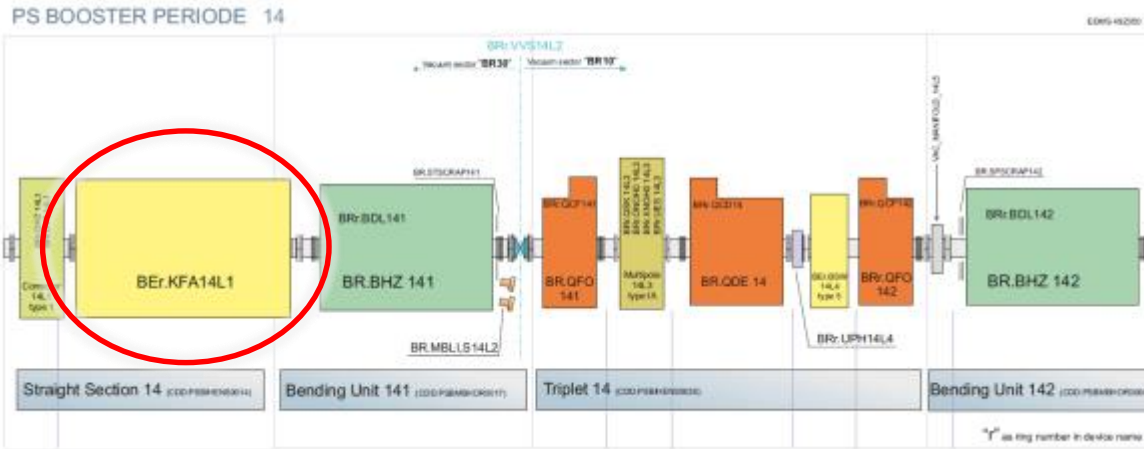

- 1 vacuum tank installed ~1970
- 16 magnets (4 per ring, 2 types)
- No spare

All magnets have been refurbished in 2000 for the 1.4 GeV upgrade.

The poor quality glued original ferrite blocks have been replaced by C shaped ones of 8C11 type.



# Extraction BE.KFA14L1

- 1 generator per ring supplies for magnets in parallel
- PFL made of 4x25 Ohm SF<sub>6</sub> cables in //
- Transmission cables same type as PFLs
- Nominal Voltage @ 2GeV → 55 kV (max. 60 kV); increased breakdown risk

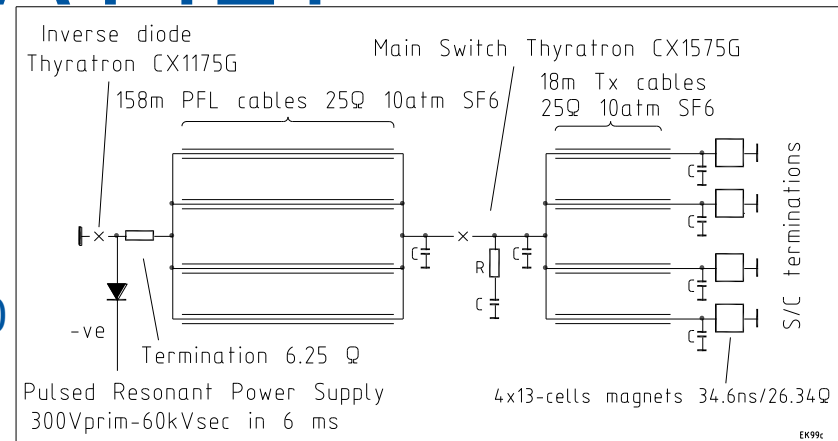

- ‘PSB to PS Kicker’ functional spec released.
- System measured in lab:
  - no saturation
  - rise time assumed to be within spec
- LIU planning:
  - Design and build improved full spare (lower beam impedance, improved magnet impedance matching)
  - Ready by end of LS2; not installed



# BESMH

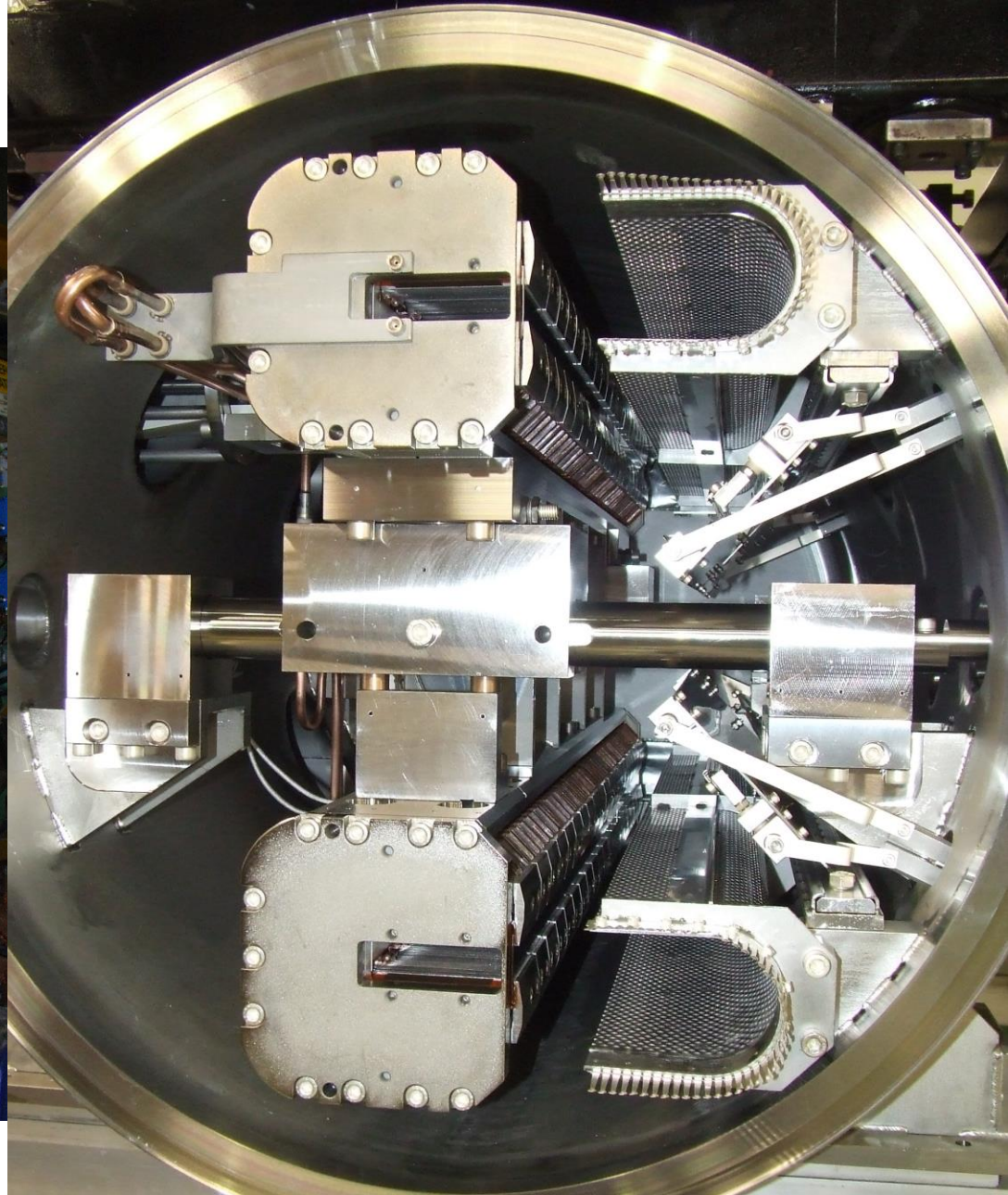
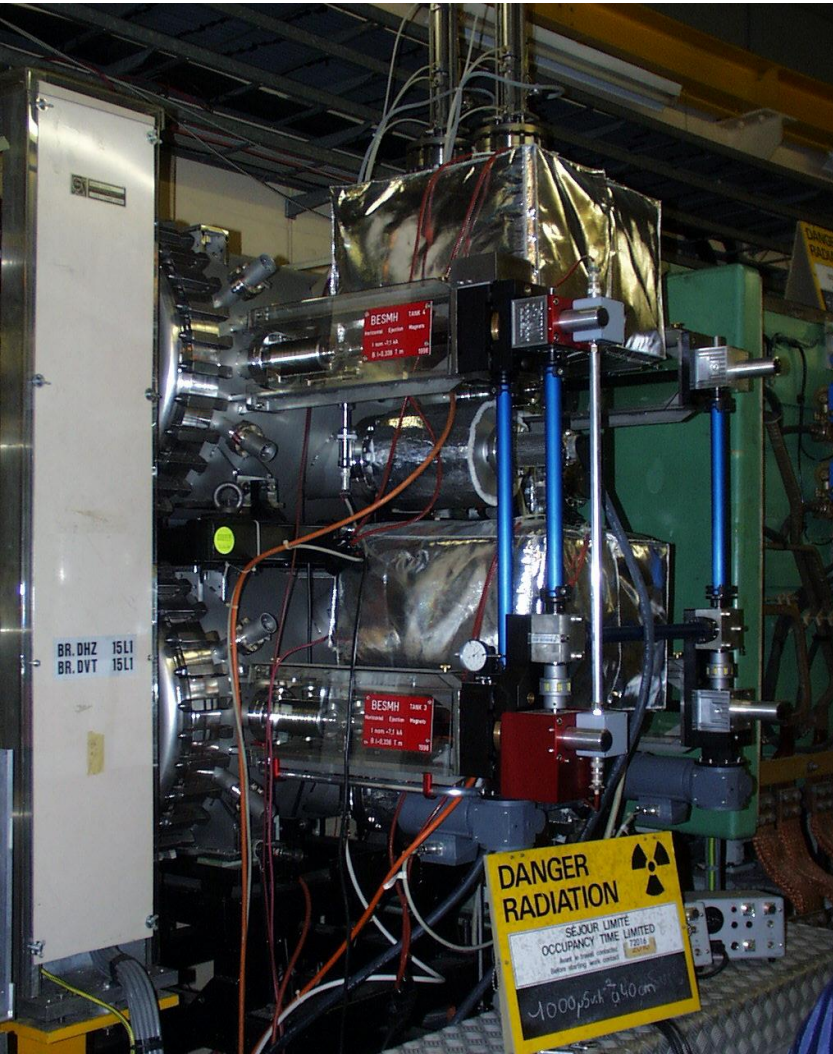

# BESMH Horizontal Extraction Septum

## Scope of the upgrade

- Excitation current increased from 7 kA to 9.6 kA
- Deflection angle increased from 47 mrad to 49 mrad
- Cross section of in-vacuum copper busbars increased from 200 mm<sup>2</sup> to 400 mm<sup>2</sup>
- In-parallel cooling scheme per vacuum tank – cooling capacity increased from 1.9 l/min to 6.6 l/min
- No change of envelope and no impact on other facilities => no ECR
- No functional nor engineering specification planned.



# BESMH Horizontal Extraction Septum

## Project status and outlook

- 1 system (tanks 1 and 2) upgraded, ready for installation during EYETS.
- 1 system (tanks 3 and 4) currently installed in the booster since 1998. To be upgraded after exchange and a cool-down period.

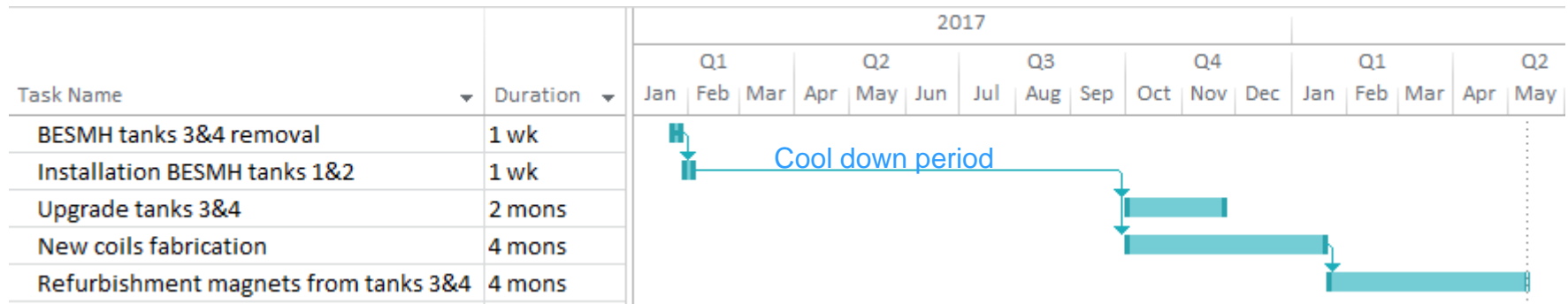

Budget requested: 60 kCHF; code 99236

Spent 59.5 kCHF

APT WU completed

No APT WU for installation (standard exchange covered by exploitation).

# BT<sub>1</sub><sup>4</sup>.SMV10

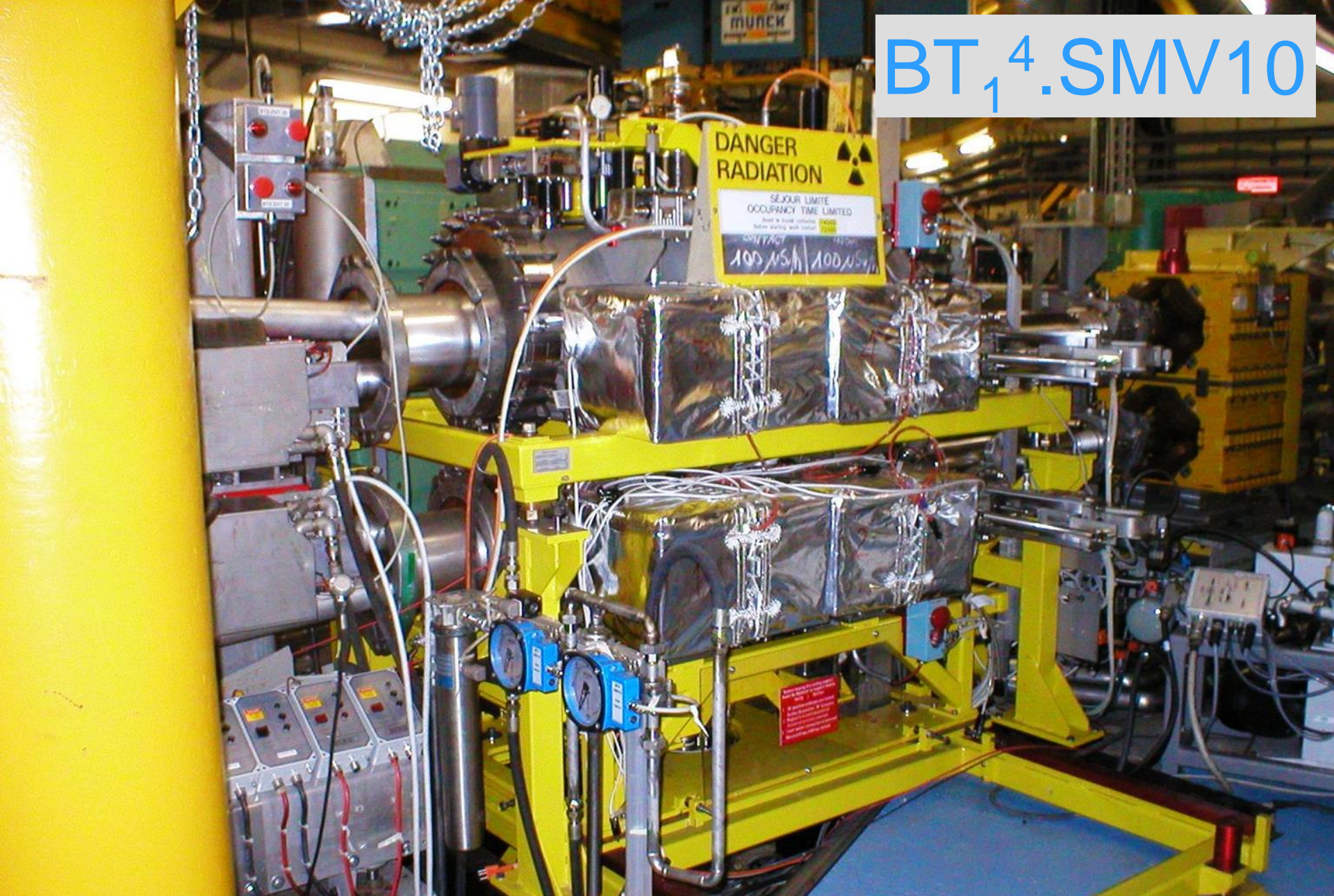

# SMV10 vertical recombination 4 to 2

## Scope of the upgrade

- Increase of magnetic length to 1225 mm -> increase magnet physical length to 1300 mm;
- Preserve aperture (60.4 h x 102 v);
- 6 magnets to be built: 2 operational + 4 spares;
- Displace beam observation equipment (ECR released: EDMS [1494819](#));
- ECR for the upgrade released (EDMS [1459318](#));
- Functional specification released (EDMS [1461559](#));
- Engineering specification to be compiled.

# SMV10 vertical recombination 4 to 2

## Project status and outlook

- Design finished.
- Part procurement started

Tentative planning, pending available (human) resources:

- 2 magnets to be constructed by end of 2016 – possibly ready for installation during next year's EYETS
- 2 operational spares to be ready for Q2 2017
- 2 spares for Q3 2019

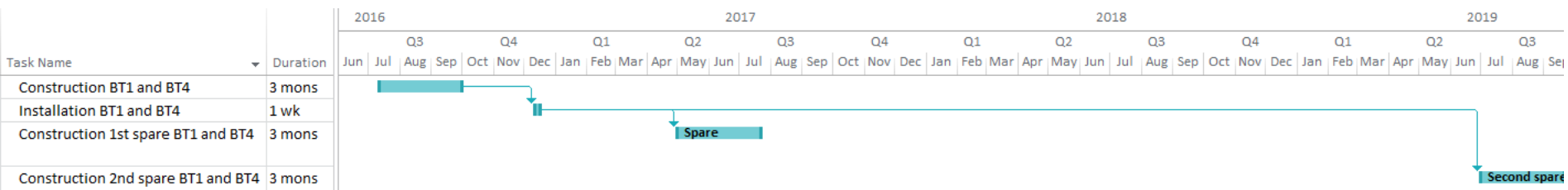

# Kicker BT.KFA10

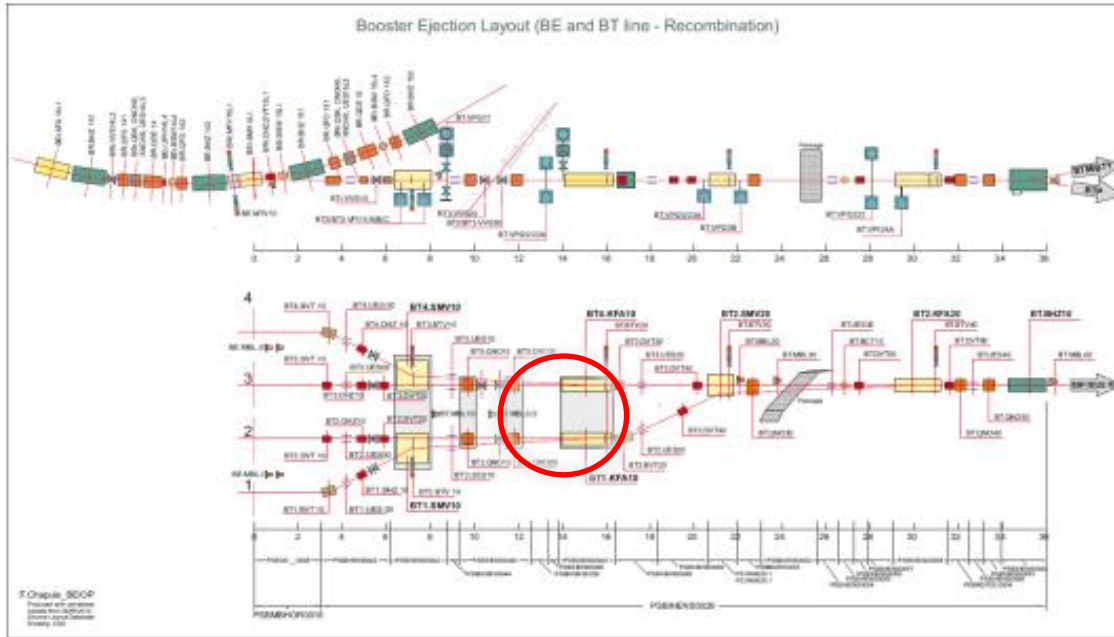

- 1 vacuum tank installed ~1970
- 4 magnets (2 per ring, 2 types)
- Glued ferrite C cores of unknown type (4L1?)
- No spare



# Kicker BT.KFA10

- 1 generator per ring (2&3) supplies two magnets in parallel
- PFL made of 4x25 Ohm SF<sub>6</sub> cables in //
- Transmission cables same type as PFLs
- Nominal Voltage @ 2GeV → 55 kV (max. 60 kV)
- 'PSB to PS Kicker' functional spec released.
- System to be re-measured in tunnel in December 2015 (rise time likely outside spec)
- LIU planning:
  - Build new full spare with vacuum tank
    - Design and produce parts in 2016
    - Build new kicker in 2017
    - Install during LS2

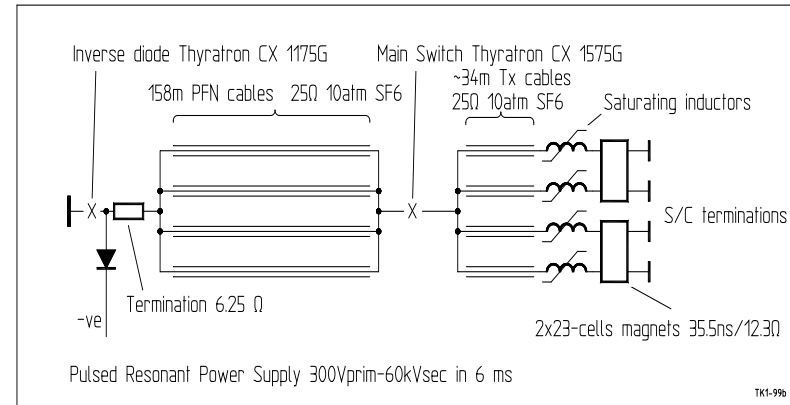

**NOTE: measurements in tunnel crucial to be able to design new kicker!**

# Work to be done: BT.KFA10

1. Measure present kicker rise time as it doesn't fit the predicted values.

Measurement performed in the ring. It seems that the poor rise time is due to the presently assumed 4L1 ferrite.

Measurements will be repeated in December with a improved vertical resolution oscilloscope.

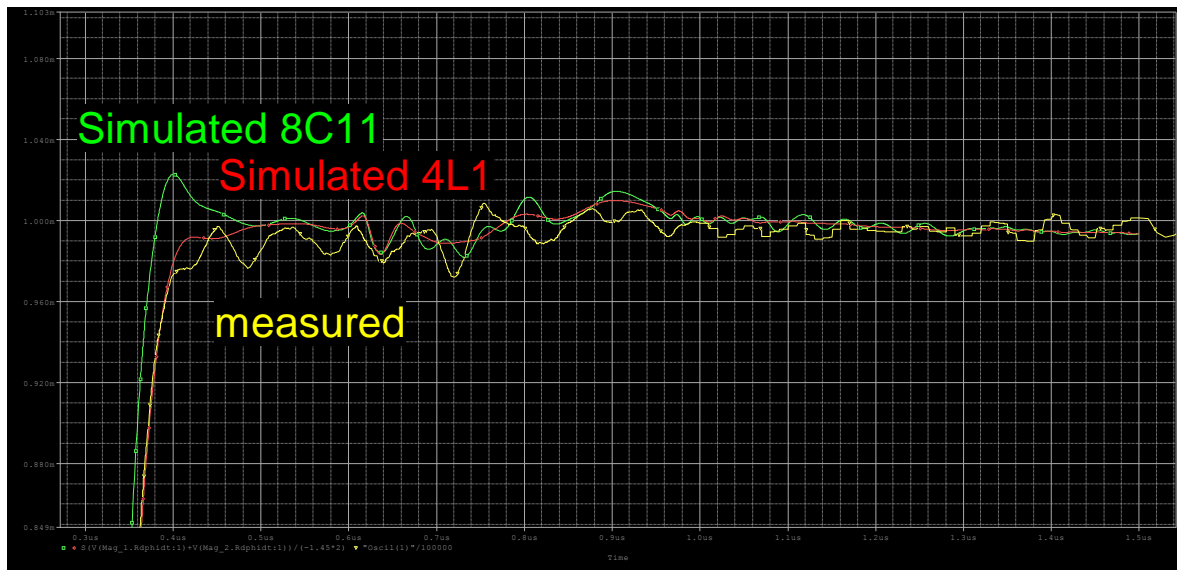

BT1.KFA10

Kick rise time (2-98)%

-measured 121ns

-simulated 8C11: 101ns

-simulated 4L1: 125ns

# Work to be done: BT.KFA10

2. Produce CATIA 3D models and 2D drawings of the present vacuum tank, magnets, connection boxes.
  - 3D models ready.
  - ENMME waiting for our feedback before doing 2D drawings.
  - Ferrite cross sectional area to be increased to prevent saturation at the ends.
3. Build new magnets (with new ferrite blocks) and vacuum tank and install it in the PSB during LS2.
  - Not started yet.
  - The magnet configuration must be slightly modified to pulse them from the same side.
  - This work should have the highest priority.
4. Measure BT.KFA10 configuration in Lab. By using spare BT2.KFA20 (equipped with 8C11 ferrite).
  - Aim to do this before/during YETS 2015-2016
5. Modify the present kicker magnets after exchange to have an operational spare.



# SMV20



# SMV20 vertical recombination 2 to 1

## Scope of the upgrade

- Increase magnetic length to 1225 mm -> increase magnet physical length to 1300 mm;
- Preserve aperture (60.4 h x 102 v);
- 3 magnets to be built: 1 operational + 2 spares;
- Displace beam observation equipment (ECR released: EDMS [1494823](#));
- ECR for the upgrade released (EDMS [1459320](#));
- Functional specification released (EDMS [1461559](#));
- Engineering specification to be compiled.

# SMV20 vertical recombination 2 to 1

## Project status and outlook

- Design finalised
- Part procurement started

### Initial planning:

- 2 magnets to be constructed in 2017 – installation in LS2
- 1 spare for Q3 2019

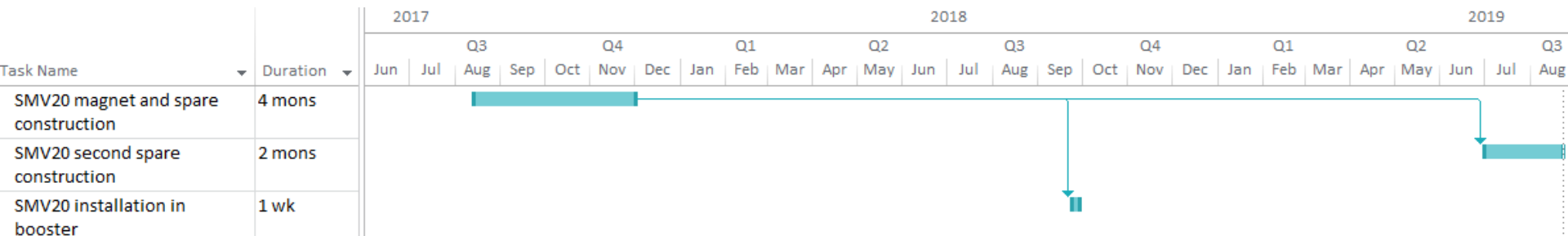

# Transfer BT2.KFA20

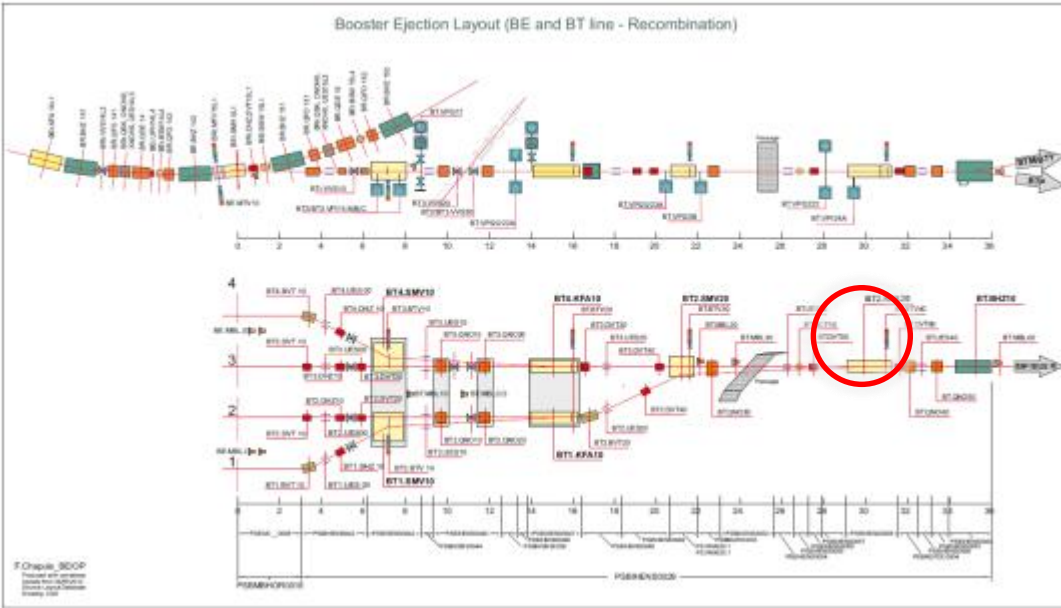

- 1 vacuum tank refurbished in 2000
- 2 magnets designed for 800 MeV beam deflection (same as BT.KFA10 ones)
- 1 fully operational spare exists
- Ferrite type is CMD5005 (equivalent 8C11)

# Transfer BT2.KFA20

- 1 generator (magnets are charged with the PFL)
- PFL made of 4x25 Ohm SF<sub>6</sub> cables in //
- Transmission cables same type as PFLs
- Nominal Voltage @ 2GeV → 36.5 kV (max. 37 kV)
- Required  $\int B \cdot dl$  for 2 GeV can be achieved.
- Rise time of system unclear. Cannot measure  $\int B \cdot dl$  waveform in PSB; Spare system not identical.
- It will be verified if a change in optics can provide some additional margin for this equipment.

**NOTE: Crucial to do precise measurements on system in BT line to know what needs to be done!**

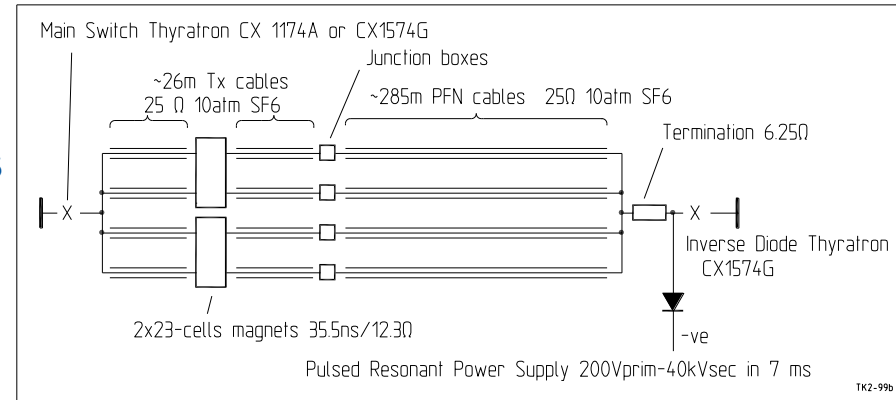

# Work to be done: BT2.KFA20

1. Perform measurements in the ring to confirm the predicted rise time better than 105 ns.

Measurements will be hopefully made in December. Vacuum chamber to be opened to install a magnetic field probe and measure the kick of one magnet.



Improvements, if necessary, to be studied after the measurement.

# Conclusions

- Extraction kicker spare 14L1 will be prepared, but less critical since present system compliant with requirements.
- Extraction septum ready for installation. Parts for upgrading the spare are available.
- Recombination septa mechanical parts manufacture is ongoing and deliverables are arriving on schedule. Installation likely in LS2, not before.
- Recombination kicker KFA10 outside specifications, a new kicker will be built. Design phase is on critical path now.
- Recombination kicker KFA20 dynamic performance unclear, but required beam deflection is within reach with present system.
- Crucial to do precise measurements on kickers in BT line to determine what needs to be improved to respect rise time specification!

# Documentation

PSB-MSMI-ES-0001 – FS of the BT.SMV recombination septa (EDMS [1461559](#))

PSB-MSMIC-EC-0001 – ECR for the upgrade of BT.SMV10 (EDMS [1459318](#))

PSB-MSMID-EC-0001 – ECR for the upgrade of BT.SMV20 (EDMS [1459320](#))

PSB-LJ-EC-002 – ECR for the relocation of BI equipment BT.BTV10/30 (EDMS [1494819](#))

PSB-LJ-EC-003 – ECR for the relocation of BI equipment BT.BTV30 (EDMS [1494823](#))

PS-MKKIK-ES-0001 – FS for PSB to PS kicker systems (EDMS [1488286](#))