

Perspectives on Neutrinos and the Dark Sector

Brian Batell
CERN



Invisibles I 5
June 22-26, 2015

History lesson - 1930s:

- Back then, the “Standard Model” was photon, electron, nucleons

- Beta decay: $n \rightarrow p + e^{-}$

Continuous spectrum!

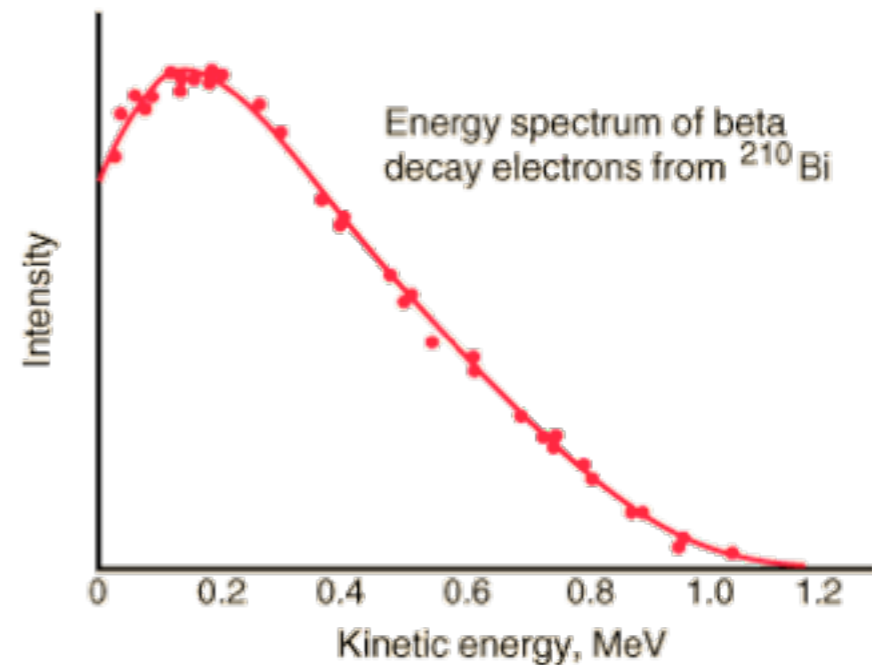

- Pauli proposes a radical solution - the neutrino!



- Perfect example of a **hidden sector**!

- neutrino is electrically neutral (QED gauge singlet)
- very weakly interacting and light

- interacts with “Standard Model” through “portal” -

$$(\bar{p}\gamma^{\mu}n)(\bar{e}\gamma_{\mu}\nu)$$

Today, 2015 - Where are we?

- Higgs!
- Triumph of the Standard Model!

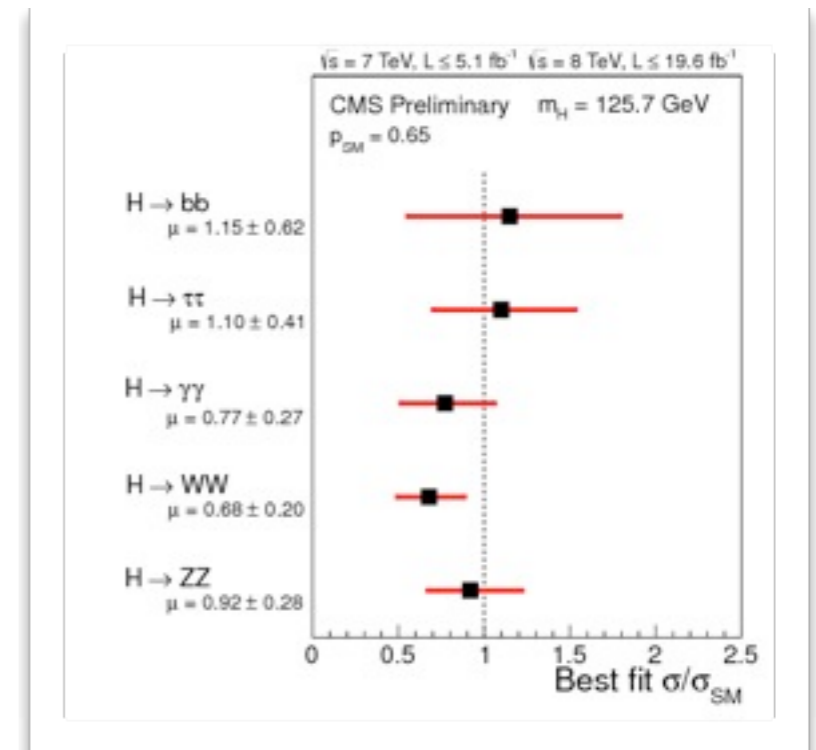
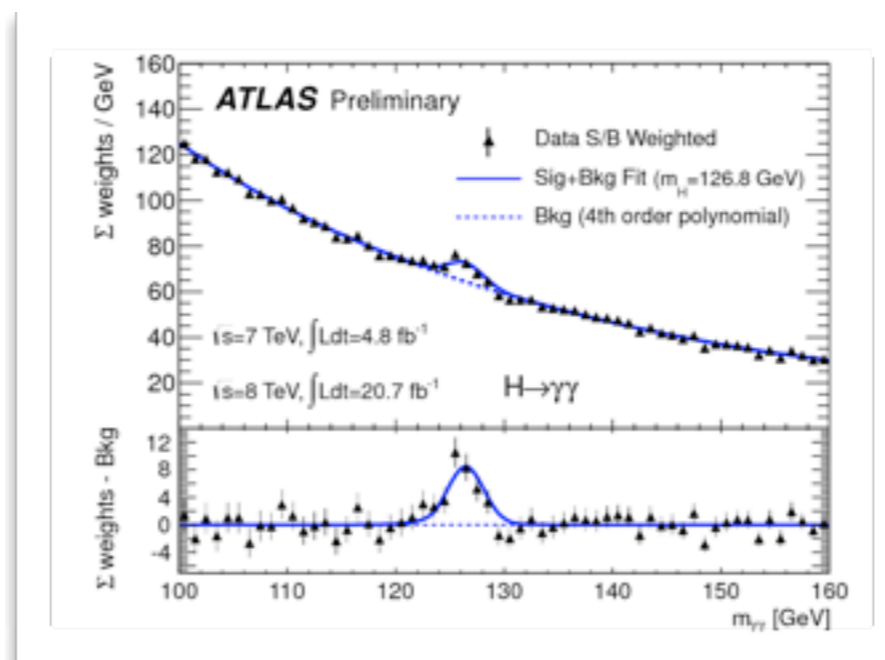

- Still, many reasons to believe there is new physics

Theoretical: Naturalness (Higgs, CC), Flavor, Strong CP, Unification, Gravity ...

Empirical: Dark Matter, Neutrino Oscillations, Baryon Asymmetry

- Unfortunately, there are no guarantees of discovery
 - All searches for new physics are now fishing expeditions



Neutrino Mass from the Dark Sector

LHN

Neutrino portal

- Right handed neutrinos, N , are Standard Model gauge singlet fermions
- Deep connection to the SM structure in the UV ... e.g. SO(10) GUT?
- Or, alternatively, neutral fermions from a dark sector?
- Firm evidence that this “portal” operates in nature via ν - oscillations

Portals

$$LHN$$

Neutrino portal

$$(\mu S + \lambda S^2) H^\dagger H$$

Higgs Portal

$$-\frac{\kappa}{2} B_{\mu\nu} V^{\mu\nu}$$

Vector Portal

- Only three renormalizable portals - can be generated at a high scale
- Point of departure for systematic studies of dark sectors
- May mediate interactions with dark matter

Motivations for Dark Sectors

- Neutrino Mass
- Dark Matter
- Strong CP (axion)
- Flavor (flavons)
- SUSY (SUSY breaking, gravitino)
- Inflation
- Electroweak naturalness (Neutral Naturalness, Relaxion,...)

Where is the New Physics?

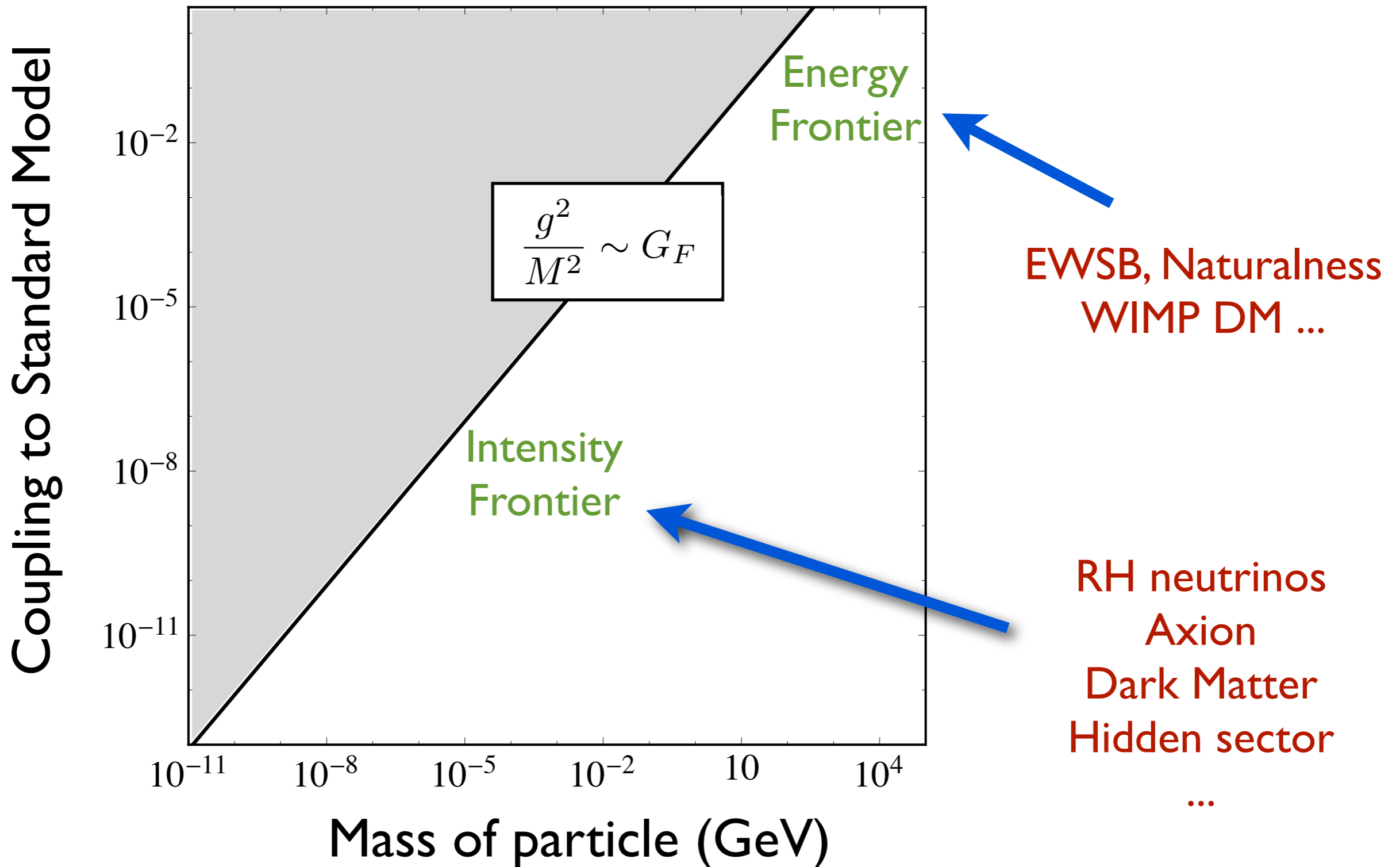

The Scale of New Physics

Theoretical hints (naturalness) - unambiguously points towards new scale

Hierarchy problem

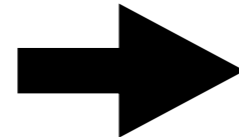

$$v \sim 100 \text{ GeV}$$

Cosmological Constant

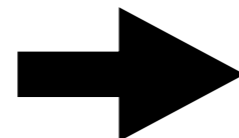

$$\rho_{\text{vac}}^{1/4} \sim 10^{-3} \text{ eV} \quad (m_\nu \sim 0.1 \text{ eV})$$

Empirical hints - no firm prediction for the new physics scale!

Matter-Antimatter Asymmetry

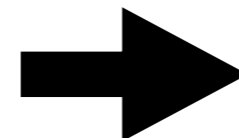

?

Dark Matter

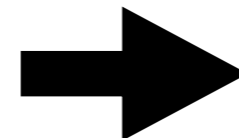

?

Neutrino mass

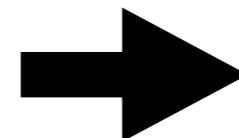

?

We must search High and Low for New Physics!

How do we study neutrinos?

- (Weak) Decays of heavy particles (μ , hadrons, W , Z , $t \dots$)
- Reactors
- Fixed-Target/Dump experiments
- Astrophysical systems (stars, supernovae, cosmic-rays ...)

We can use similar means to study dark sectors

Fixed-target neutrino oscillation experiment

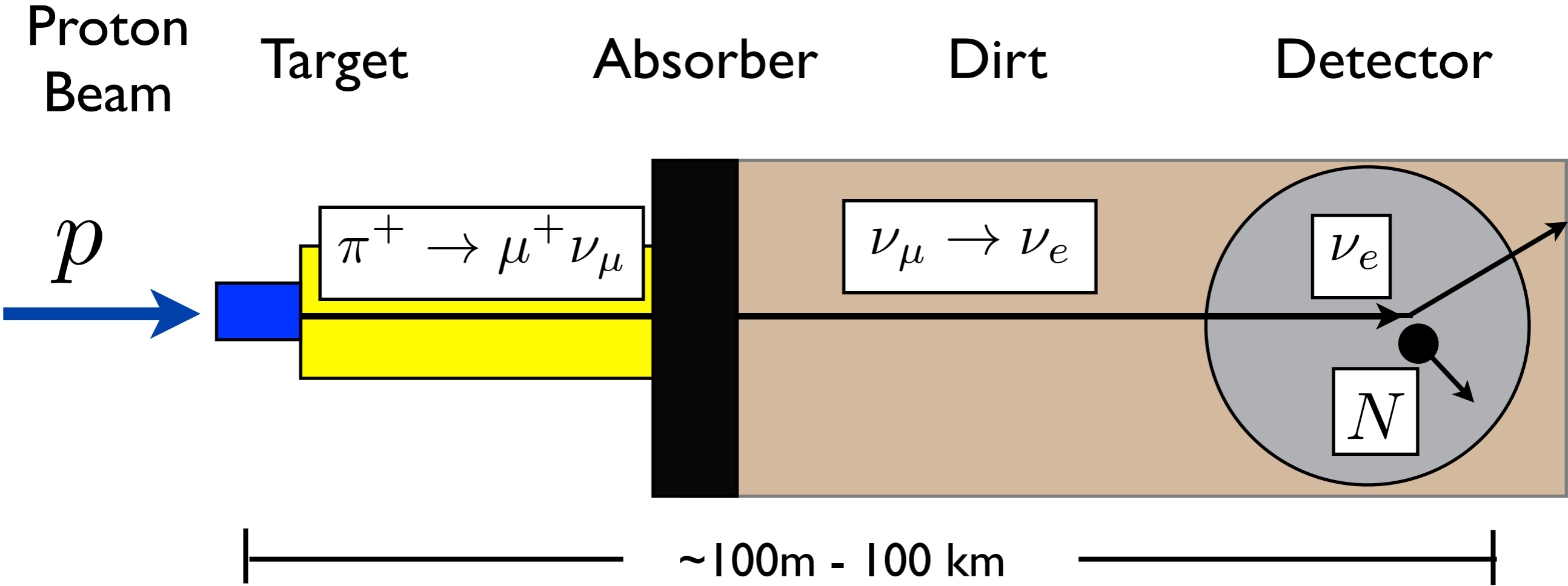

Relativistic Dark Matter Beam

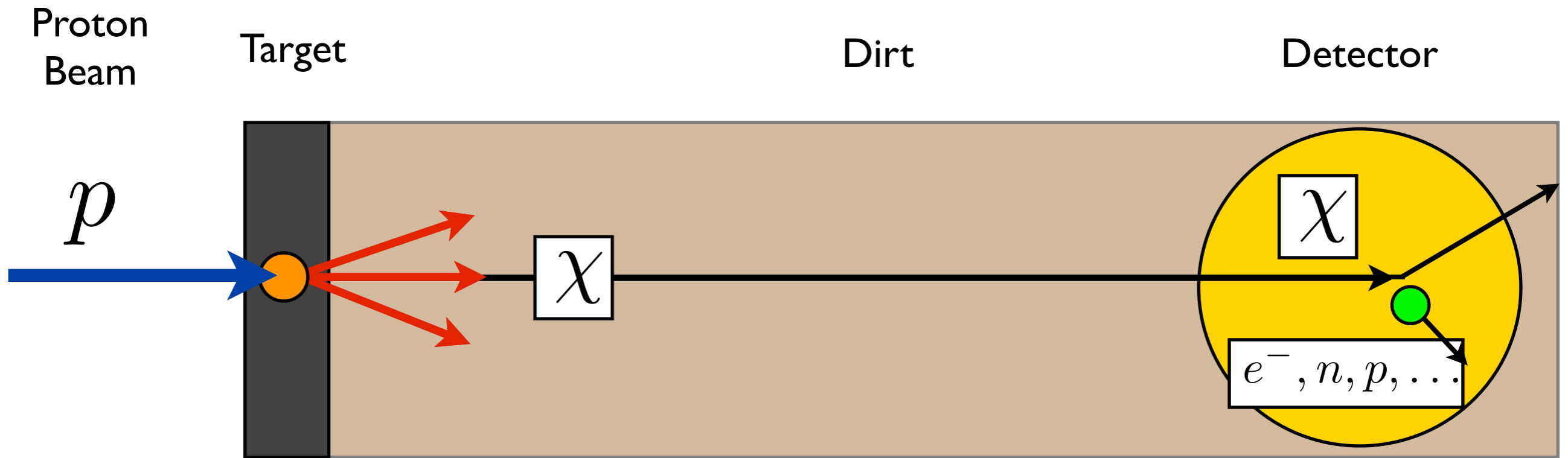

[BB, Pospelov Ritz, '09]

[deNiverville, Pospelov Ritz, '11]

[McKeen, deNiverville, Ritz, '12]

- Superior sensitivity for many models with light DM + light mediator
- Can be done with existing neutrino experiments (e.g. [MiniBooNE](#), [MINOS](#), [NOvA](#), [MicroBooNE](#), [T2K](#), ...)
- Provides a strong motivation for intense proton sources (e.g. [CERN](#), [FNAL](#), [JPARC](#))

Production of the Dark Matter beam

Hadron decays

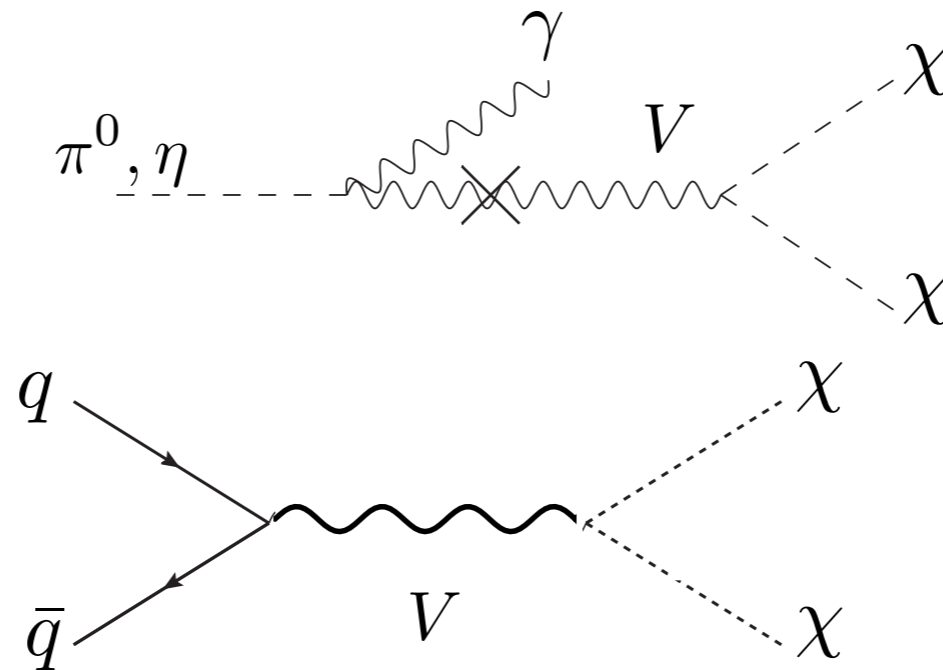

Direct production

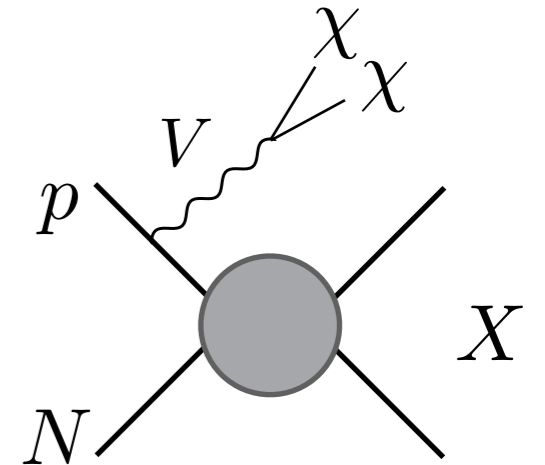

Detection via scattering - anomalous neutral currents

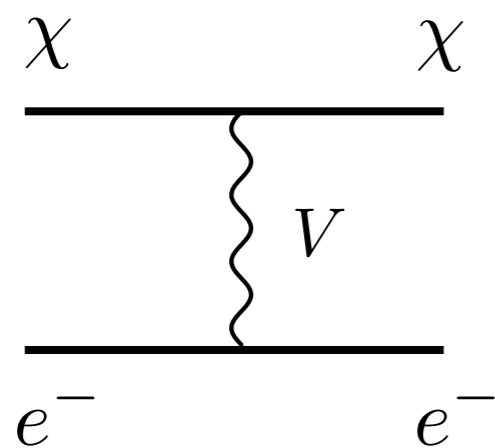

χ - e^- elastic

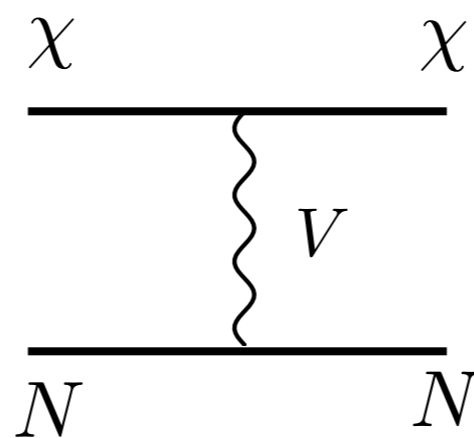

χ -nucleon elastic

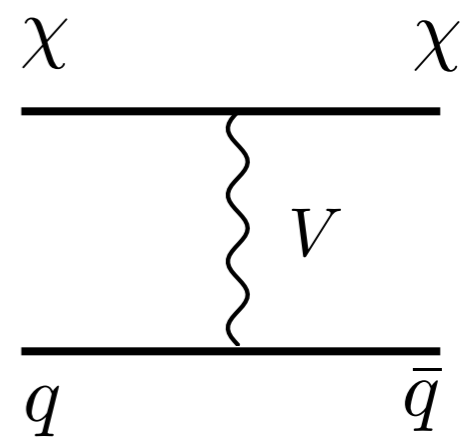

deep inelastic

LSND

Production: $\pi^0 \rightarrow \gamma V \rightarrow \gamma \chi \bar{\chi}$

Sensitivity to $\chi e \rightarrow \chi e$

[Auerbach et al. (LSND Collaboration), '01]

- LAMPF, 800 MeV protons, $\sim 10^{23}$ POT
- water / high Z target
- detector: 30m off axis from target, cylindrical, 170 tons mineral oil

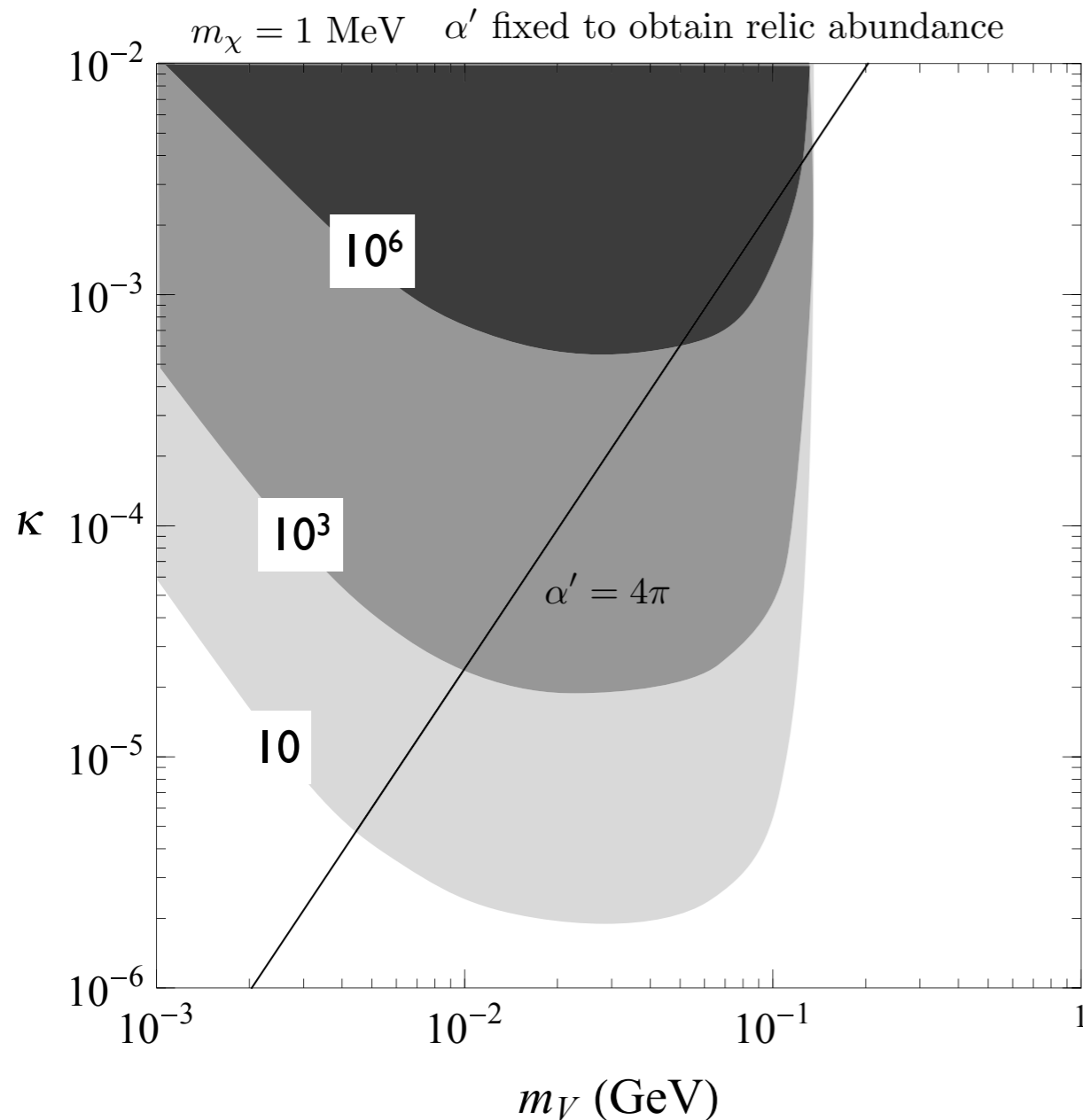

BB, Pospelov, Ritz

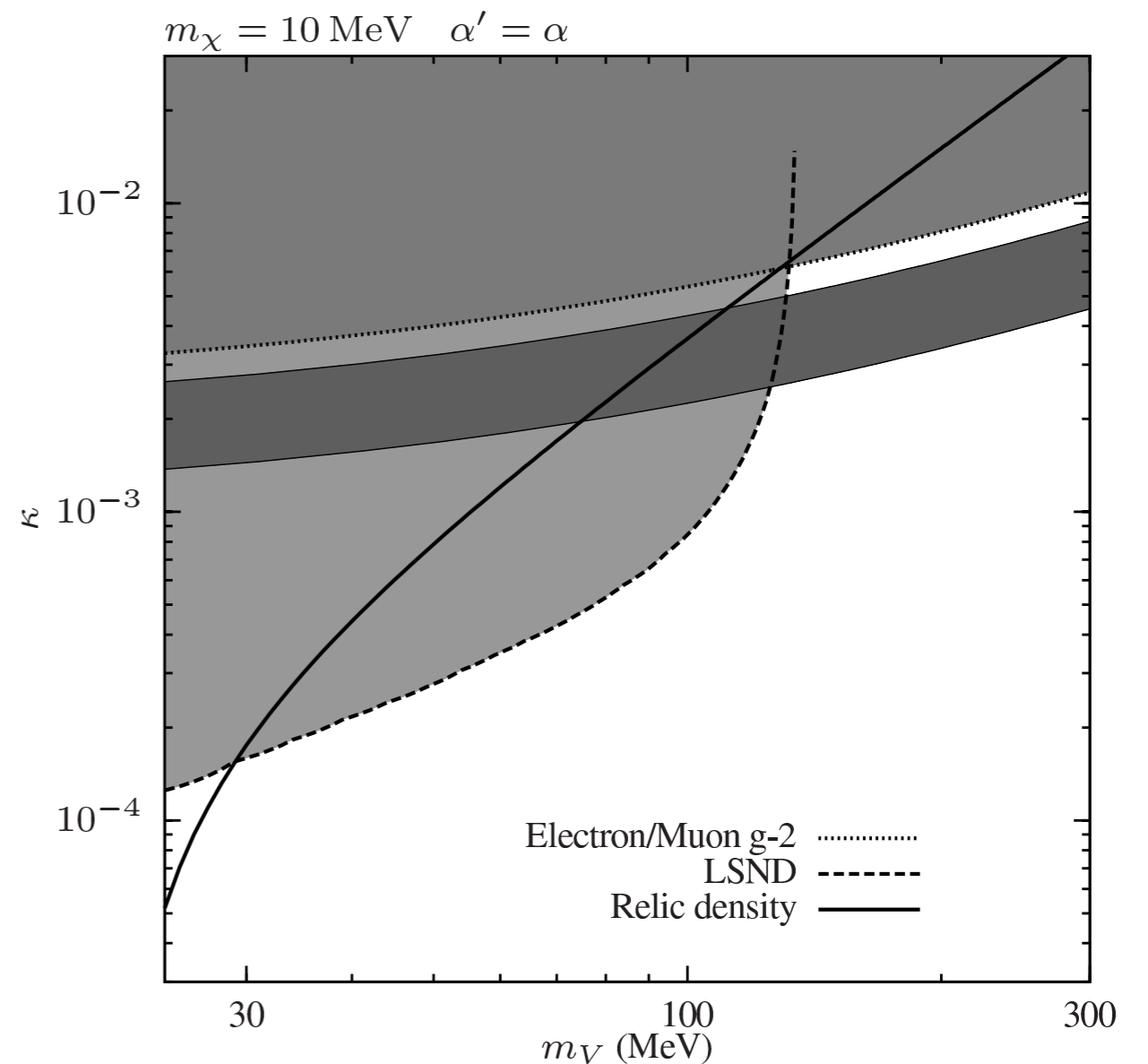

deNiverville, Pospelov, Ritz

MiniBooNE Dedicated Dark Matter Search

[Dharmapalan et al., (MiniBooNE Collaboration), arXiv:1211.2258]

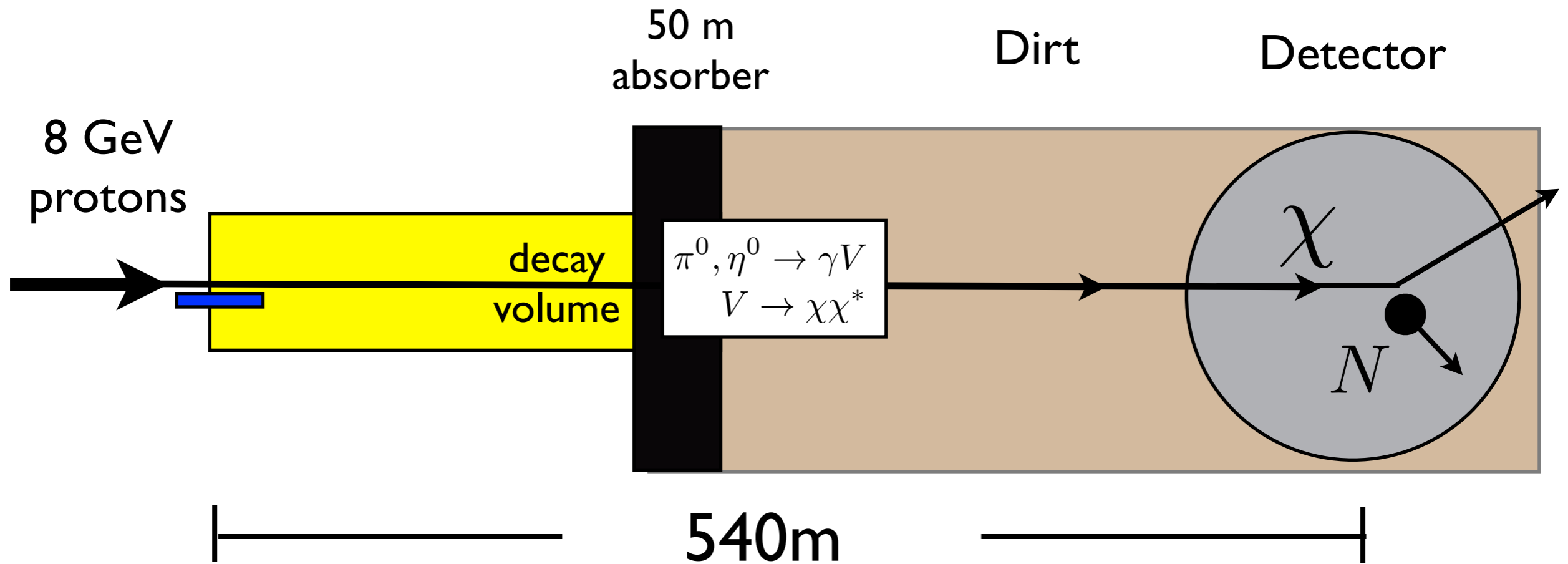

- Basic idea: direct protons onto beam dump to reduce neutrino flux
- Potential to use DM timing delay to reject neutrino backgrounds
- Run completed last fall, analysis underway, results later this year!

MiniBooNE sensitivity to leptophobic DM

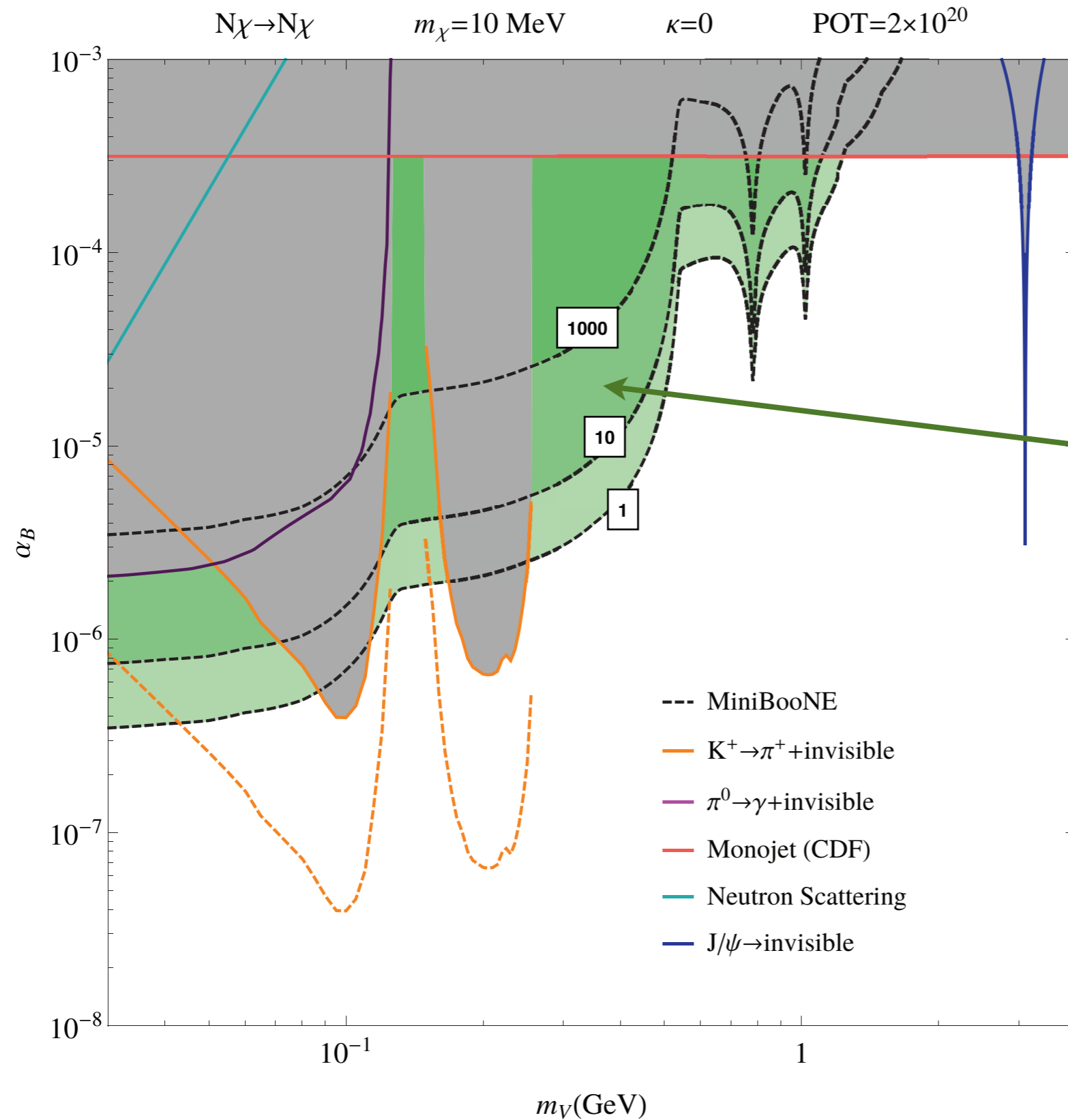

MiniBooNE
signal

Unique sensitivity
over much of the
parameter space!

Going to higher masses

(see talk by P. Coloma)

FNAL Main Injector (120 GeV)
CERN SPS (400 GeV)

DM energetic - deeply inelastic events

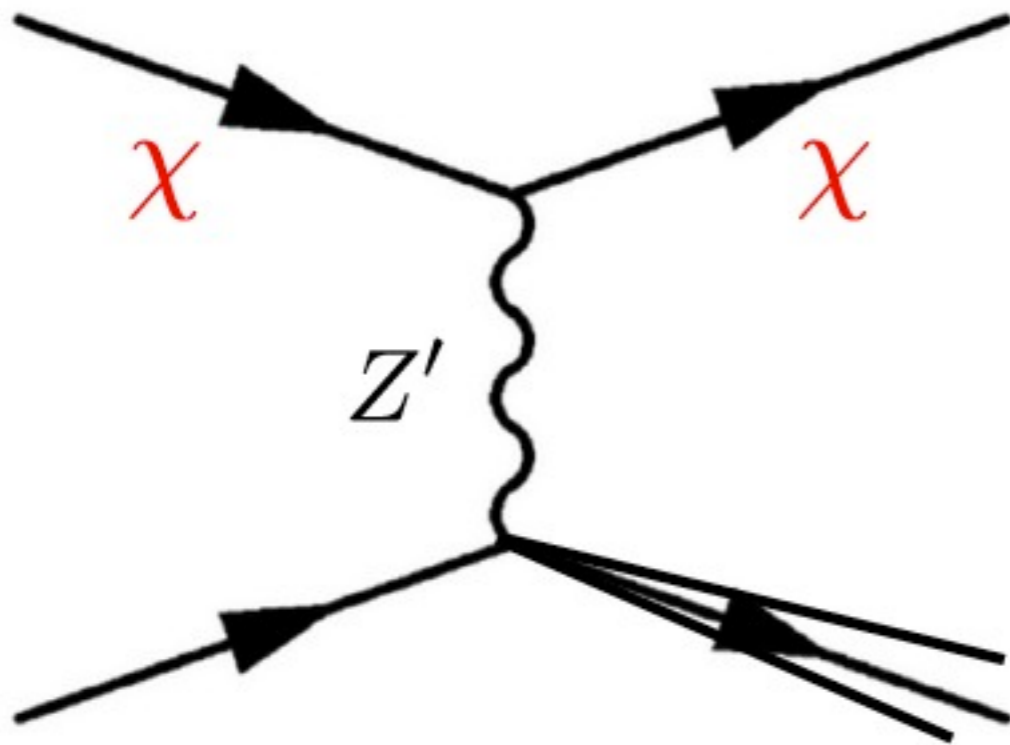

[Soper, Spannowsky, Tait, Wallace]
[Dobrescu, Frugiuele]

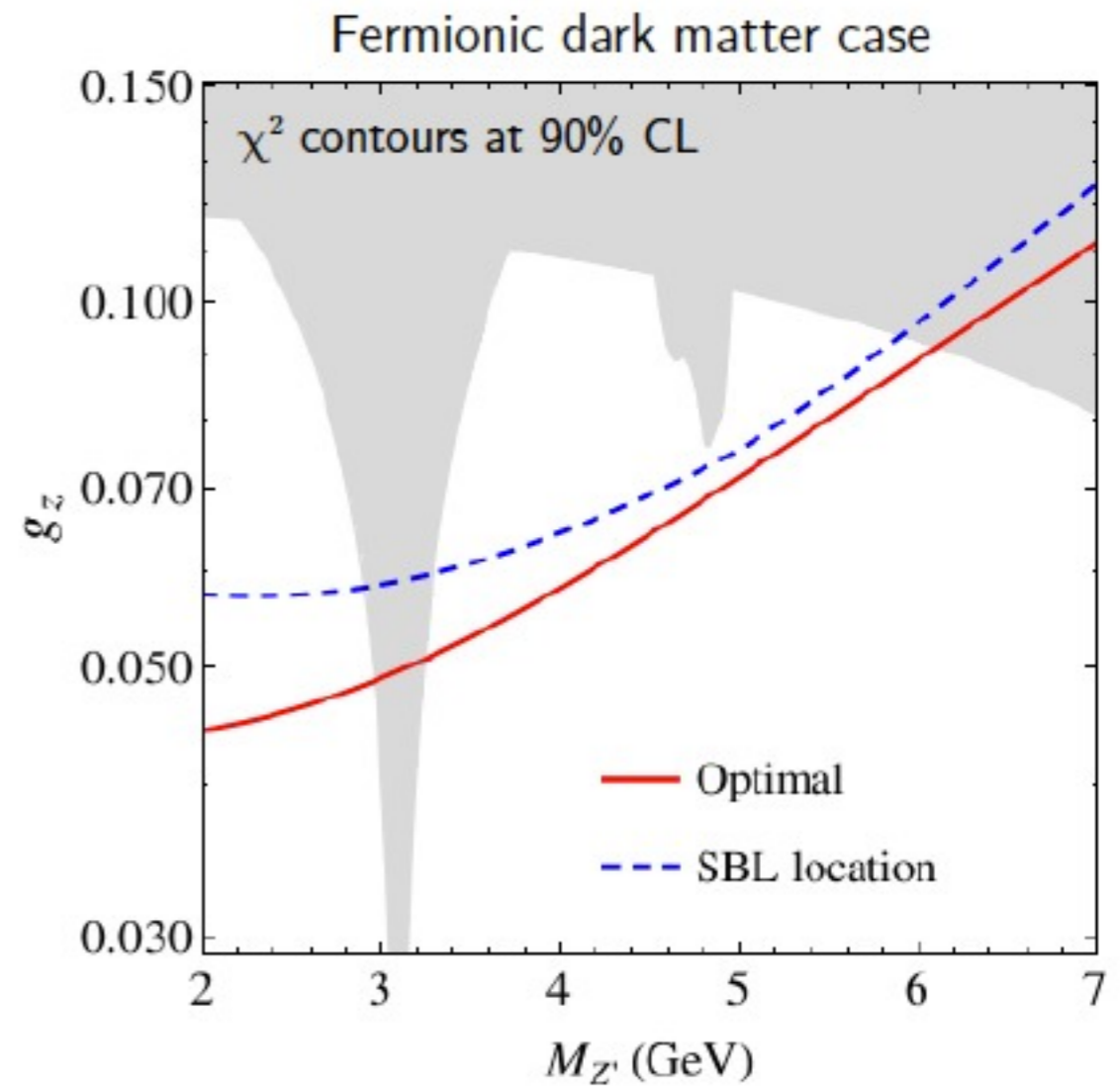

Many promising proposals to probe Sub-GeV Dark Matter

- Direct detection via scattering with electrons [Essig, Mardon, Volansky]
- Electron Beam fixed target - scattering experiments
 - BDX (Beam Dump eXperiment) [Izaguirre, Krnjaic, Schuster, Toro]
- Fixed target - missing momentum experiments
 - SPS Proposal P348 <http://p-348.web.cern.ch/>
[Andreas et al. 1312.3309] (See also [Kahn, Thaler] [Izaguirre, Krnjaic, Schuster, Toro])
- Neutrino factories, e.g., DAEdULUS [Kahn et al]

SHiP experiment (Search for Hidden Particles)

<http://www.cern.ch/ship>

- New Fixed target facility proposed at CERN
- 400 GeV protons, $\sim 10^{20}$ protons-on-target
- Powerful capability to search for weakly interacting, long-lived particles that decay visibly

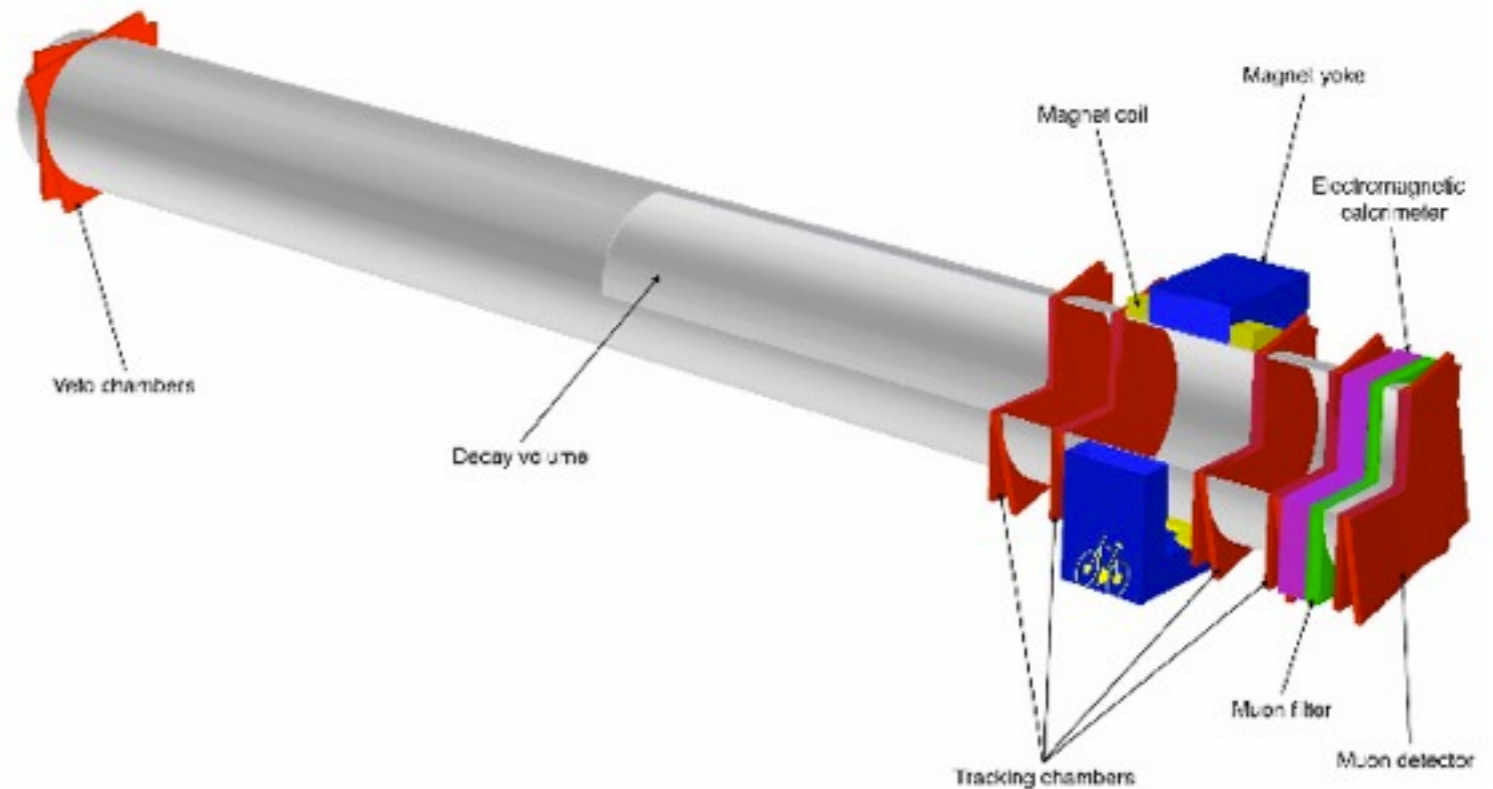

SHiP sensitivity to Heavy Neutral Lepton (i.e. right handed neutrino)

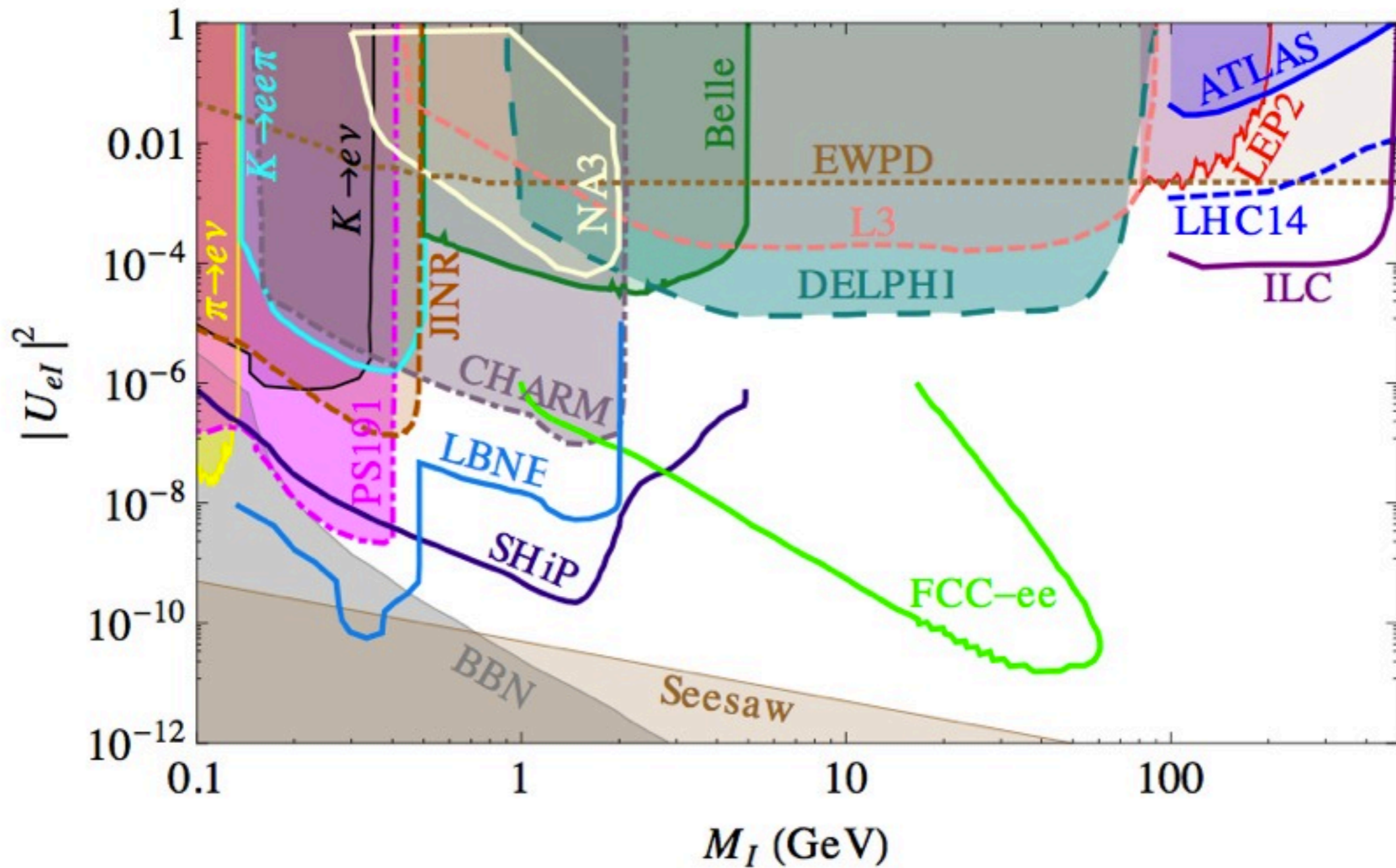

Can also search for many other light weakly coupled states (e.g. dark photon, dark scalars, ...)

Neutral Naturalness

[Chacko, Harnik Goh+Burdman]
 [Barbieri, Gregoire, Hall]
 [Craig, Knapen, Longhi]

...

Twin Higgs

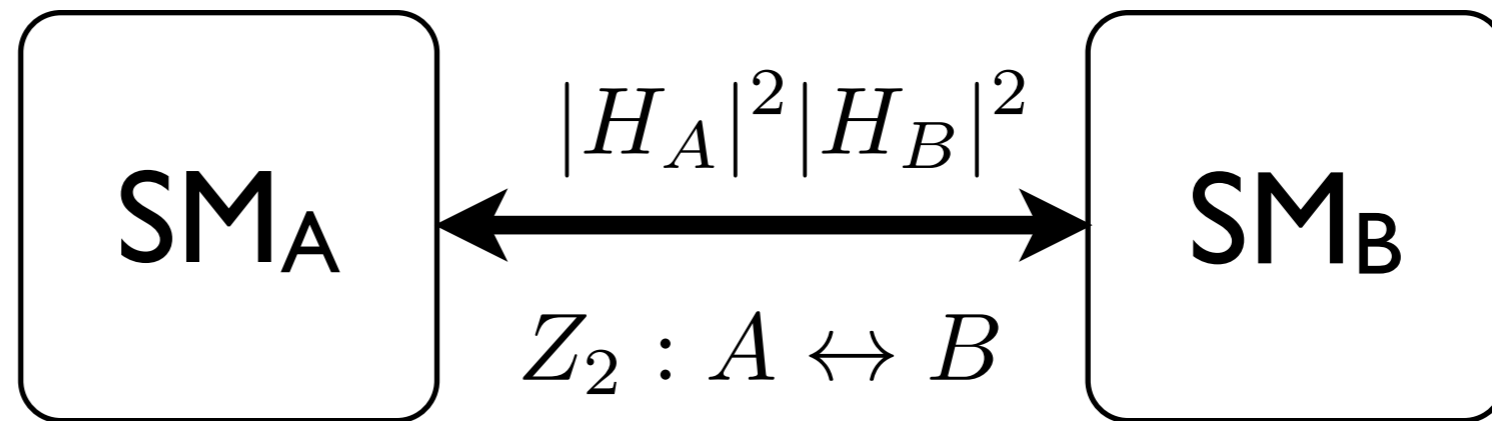

Neutral top partners!

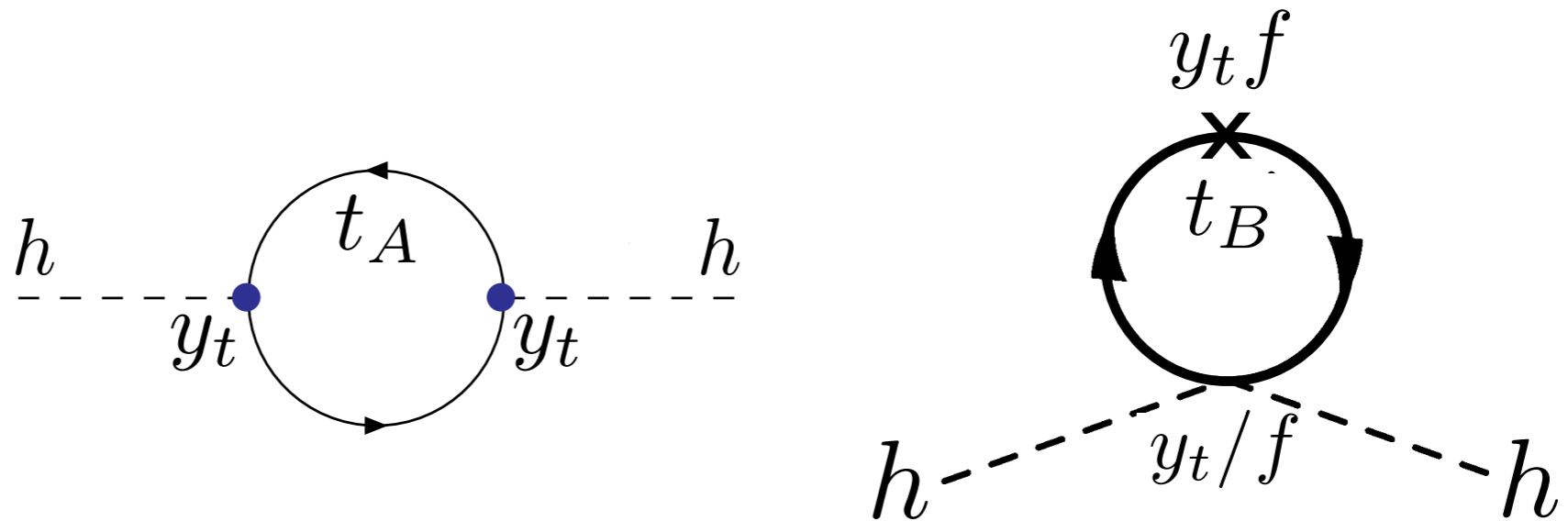

Most symmetric version of this scenario features a full copy of the SM \Rightarrow rich dark sector!

Twin Dark Matter

[Garcia Garcia, Lasenby, March-Russell]

[Craig, Katz]

[Farina]

[see also earlier work on Mirror-DM by Foot, ...]

- Many potential DM candidates in the Twin sector
 - Twin \mathcal{T} , twin baryons, twin atoms, ...
- Provides an attractive framework for Asymmetric Dark Matter

- Z_2 symmetry provides rationale for the similarity of QCD and dark QCD confinement scales

- UV completion required at ~ 10 TeV scale; can provide transfer operators

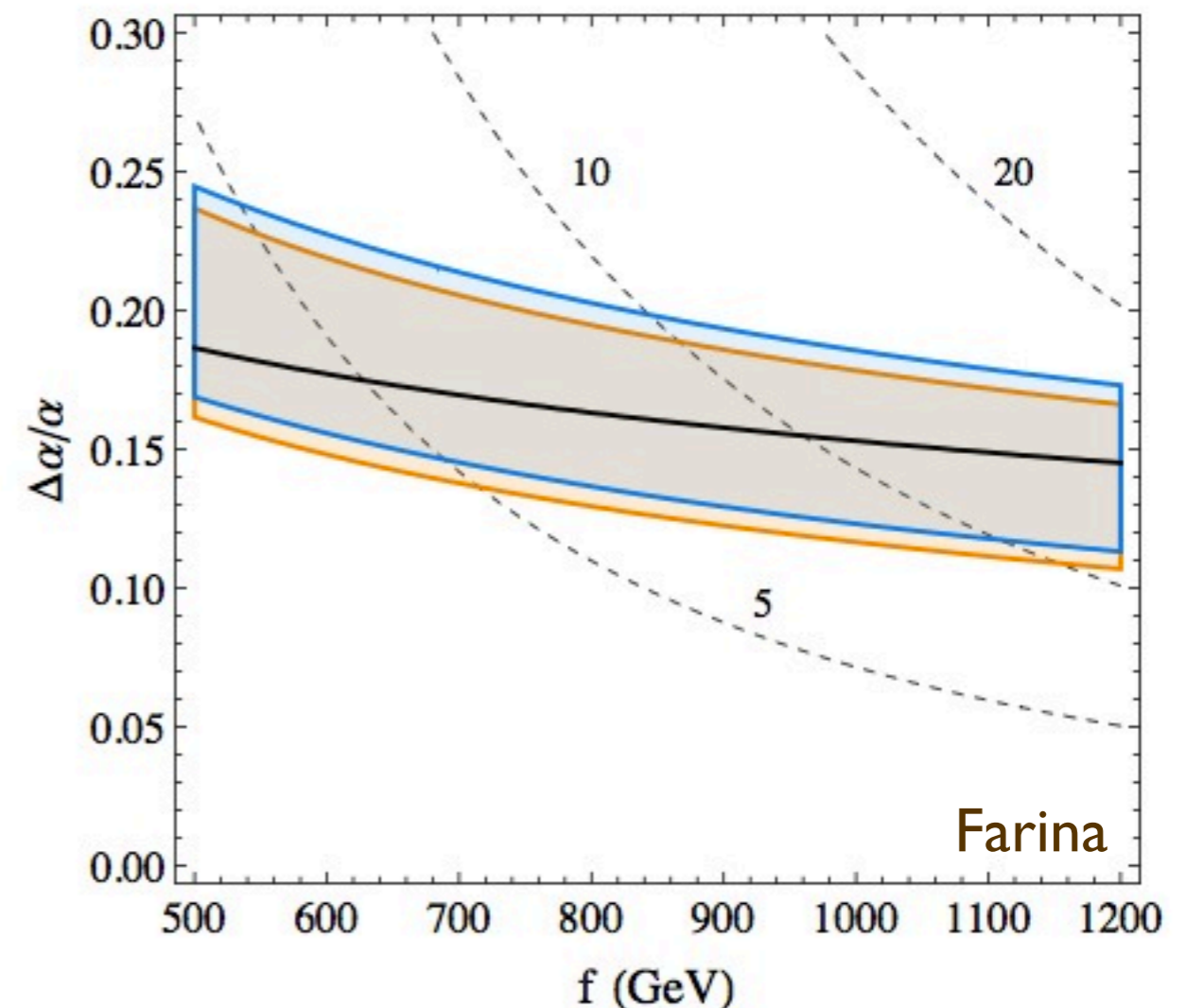

Neutrino mass from the twin sector: “Natural Neutrinos”

BB, McCullough

Basic idea: Right Handed Neutrinos are the Top Partners

Naturalness

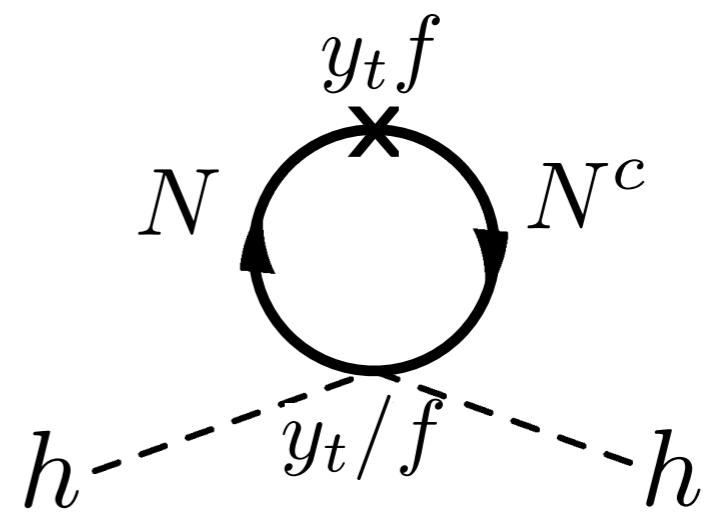
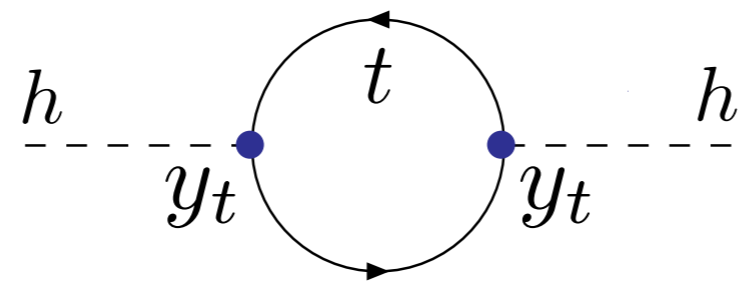

See-saw

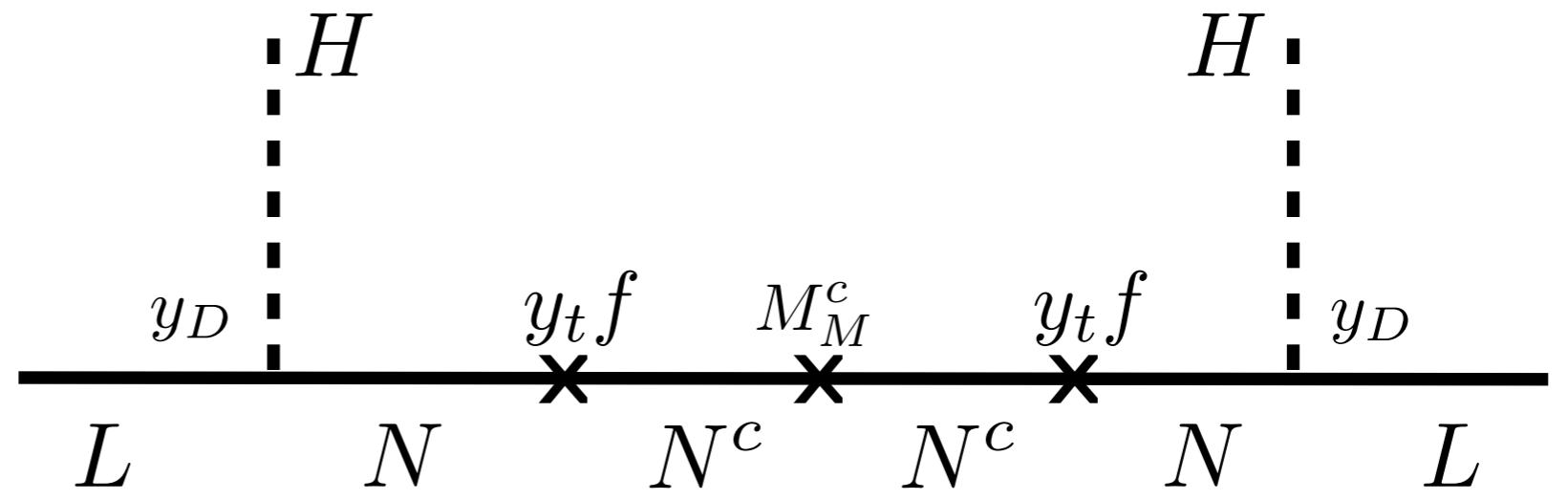

Neutrino mass \Rightarrow broken twin color SU(3) broken

- 2 loop top-gluon contribution to Higgs mass: $\delta\mu^2 = \frac{3y_t^2 g_3^2}{4\pi^4} \Lambda^2 \Rightarrow$ Mild tuning of order 10% for $\Lambda \sim 5 \text{ TeV}$
- 6 Weyl Right-Handed Neutrino top partners $N_i, N_i^c, \quad i = 1, 2, 3$

- One twin SU(3) invariant mass term coming from top Yukawa:

$$\mathcal{L} \supset M_N N N^c + \text{h.c.}, \quad M_N = \lambda_t f + \mathcal{O}(v^2/f) \lesssim \text{TeV}$$

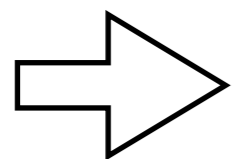

Naturalness robustly predicts TeV - scale see-saw!

- Twin SU(3) breaking mass terms (suppressed):

$$\mathcal{L} \supset y_D L H N + y_D^c L H N^c + \frac{1}{2} M_M N N + \frac{1}{2} M_M^c N^c N^c + \text{h.c.}$$

Example: inverse seesaw

[Mohapatra, Valle]

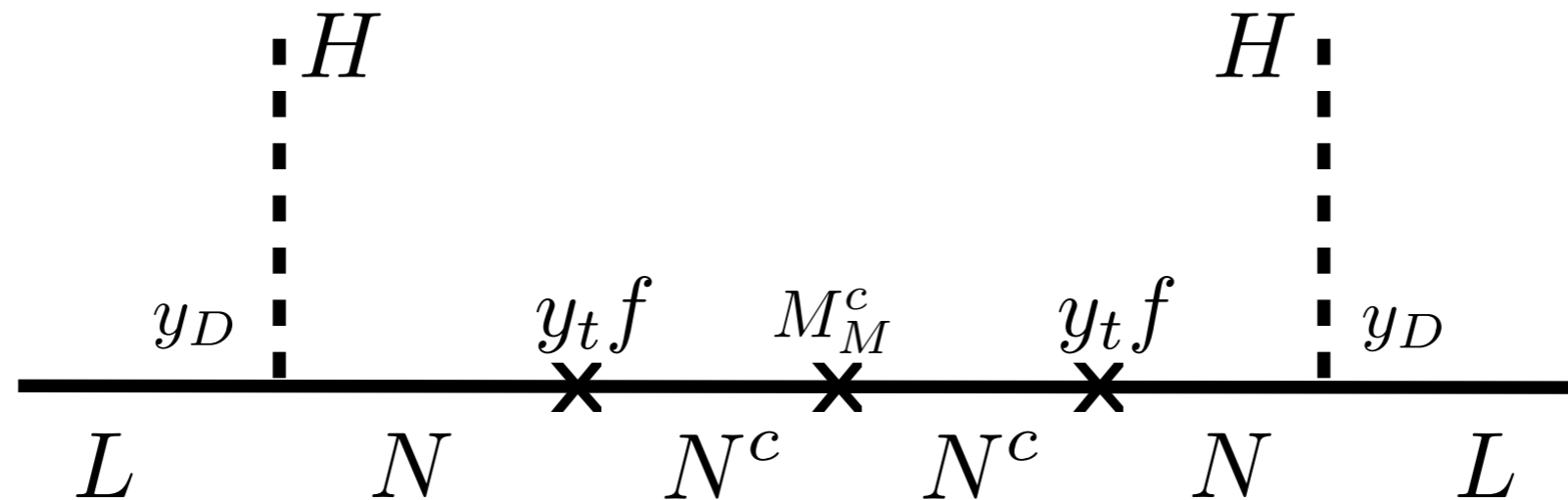

$$m_\nu \sim \frac{y_D^2 v^2 M_M^c}{M_N^2} \quad \longrightarrow \quad \text{Both } y_D \text{ and } M_M^c \text{ must be non-zero}$$

- y_D can be large, novel phenomenological consequences ...
- y_D shouldn't be too large, Naturalness suggests $y_D \lesssim \mathcal{O}(0.1)$
- Majorana mass softly breaks the global symmetry, should be less than about $f \sim \text{TeV}$

Phenomenology of Natural Neutrinos

Large neutrino Yukawas - PMNS Non-unitarity

- W, Z boson decays (including invisible Z width)
- Z-pole asymmetries
- W-boson mass
- Weak mixing angle measurements
- Lepton flavor universality tests (W, tau-lepton and meson decays)
- Lepton Flavor violating decays
- Quark Flavor CKM parameters

Precision electroweak, Higgs couplings

High energy collider signals (challenging)

Outlook

- There are rich connections between neutrinos and dark sectors!
 - Neutrinos provide canonical example of light weakly coupled particles
 - Experimental methods to study neutrinos can be adapted for dark sectors
 - Neutrino mass may originate in the dark sector (e.g. Natural Neutrinos)
- Many other important connections I didn't have time to cover :
 - RH-Neutrinos as dark matter, Astrophysical signals of neutrinos/dark sectors, neutrino portal to dark matter, neutrinos as a signal from the dark sector, new interactions for “sterile” neutrinos, ...

We must get the most out of our experiments by having diverse physics program (neutrinos, dark matter, other new light states,...)

Exploration of theoretical connections between seemingly unrelated phenomena is worthwhile