

Physics opportunities at future high-energy colliders

- ❑ Present questions in particle physics
- ❑ Main options for future high-E colliders and their physics case

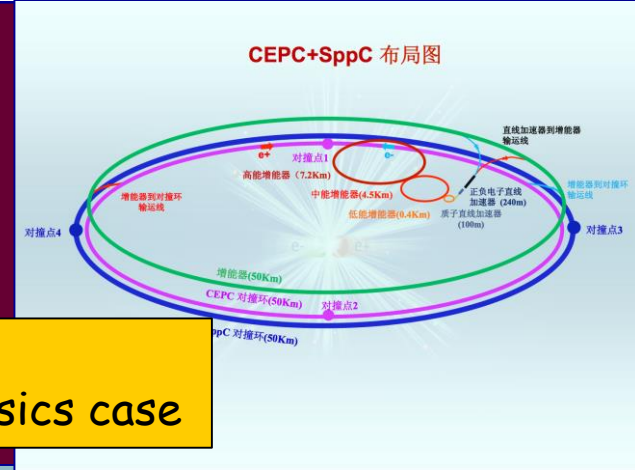

Fabiola Gianotti, CERN Physics Department
Invisible15, Madrid, 26/6/2015

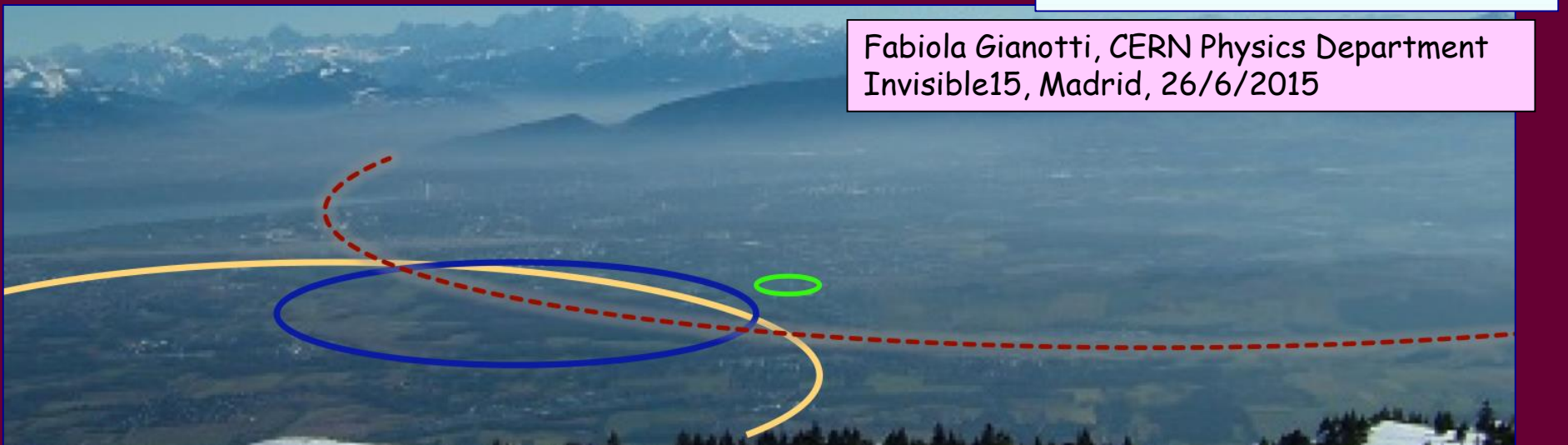

What did we accomplish so far in particle physics ?

With the discovery of the Higgs boson, we have completed the Standard Model (> 50 years of theoretical and experimental efforts !)

Note: fermions (c, b, t, τ) discovered at accelerators in the US, bosons (g, W, Z, H) in Europe ...

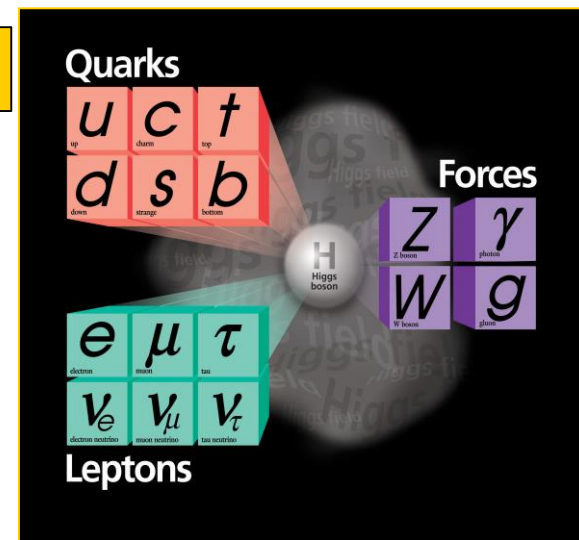

We have tested the Standard Model with very high precision (wealth of measurements since early '60s, in particular at accelerators)

- it works BEAUTIFULLY (puzzling ...)
- no significant deviations observed (but difficult to accommodate non-zero neutrino masses)

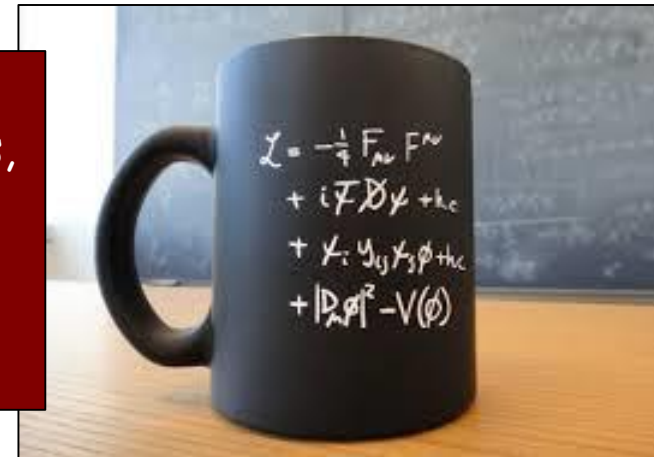

However: SM is not a complete theory of particle physics, as several outstanding questions remain, raised also by experimental observations (e.g. dark matter, Universe's accelerated expansion) that cannot be explained within the SM.

These questions require NEW PHYSICS

Main questions in today's particle physics (a non-exhaustive list ..)

Why is the Higgs boson so light (so-called "naturalness" or "hierarchy" problem) ?

What is the origin of the matter-antimatter asymmetry in the Universe ?

Why 3 fermion families ? Do neutral leptons, charged leptons and quarks behave similarly?

What is the origin of neutrino masses and oscillations ?

What is the composition of dark matter (23% of the Universe) ?

What is the cause of the Universe's accelerated expansion (today: dark energy ? primordial: inflation ?)

Why is Gravity so weak ?



Puzzling: NO evidence of new physics from LHC (yet ...)

But Where Is Everybody?



N. Arkani-Hamed

In other words: at what E scale(s) are the answers to these questions ?

These questions are compelling, difficult and intertwined → require all approaches we have in hand (made possible also by strong advancements in accelerator and detector technologies): high-E colliders, neutrino experiments (solar, short/long baseline, reactors, $0\nu\beta\beta$ decays), cosmic surveys, dark matter direct and indirect detection, precision measurements of rare decays and phenomena, dedicated searches (WIMPS, axions, dark-sector particles), ...

Main questions and main approaches to address them

	High-E colliders	High-precision experiments	Neutrino experiments	Dedicated searches	Cosmic surveys
Higgs , EWSB	x				
Neutrinos	x		x	x	x
Dark Matter	x			x	
Flavour, CP-violation	x	x	x	x	
New particles and forces	x	x	x	x	
Universe acceleration					x

Combination of ALL these complementary approaches crucial to explore the largest range of E scales, properly interpret signs of new physics → build coherent picture of underlying theory

Luminosity of a collider

n. of particles per bunch n. of bunches n. of turns per second or repetition rate

$$L = \frac{N^2 k_b f}{4 \rho S_x S_y}$$

beam size at IP

Achieved peak luminosity in LHC Run-1: $\sim 7.7 \times 10^{33} \text{ cm}^{-2} \text{ s}^{-1}$

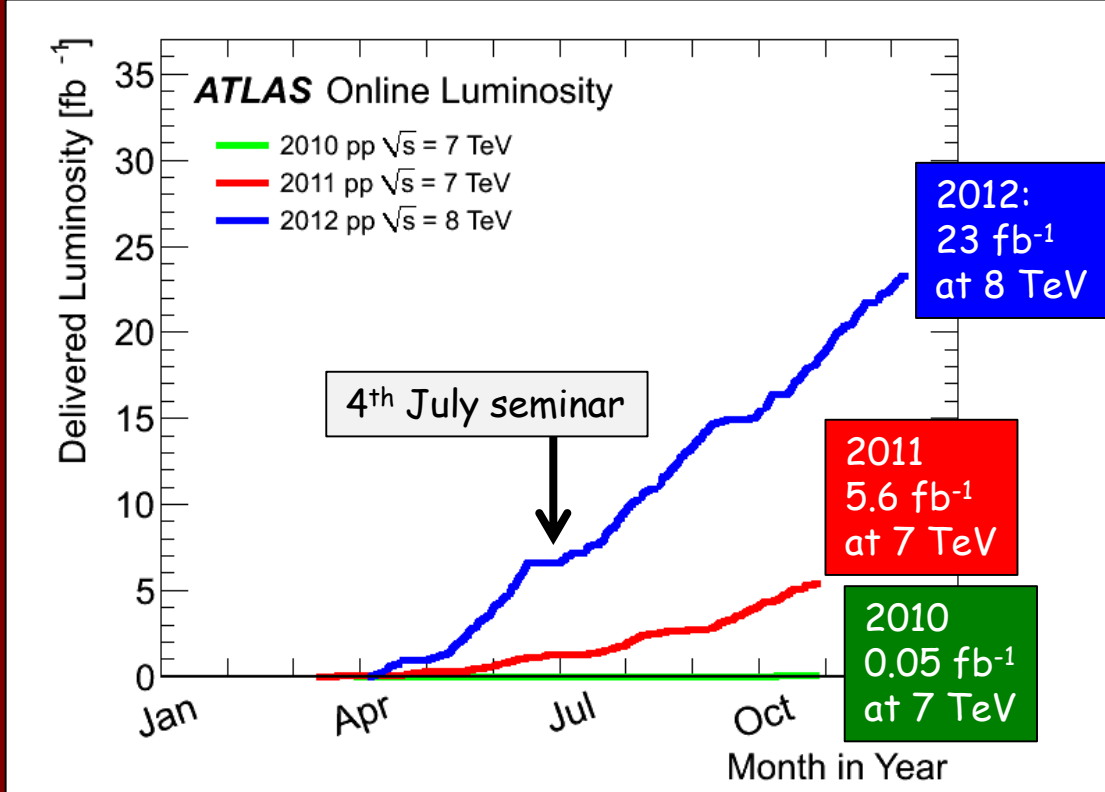

$$N = \int L dt \times \sigma (pp \rightarrow X)$$

3 main complementary ways to search for (and study) new physics at accelerators

Direct

production of a given (new or known) particle

e.g.: Higgs production at future e^+e^- linear/circular colliders at $\sqrt{s} \sim 250$ GeV through the HZ process
 → need high E and high L

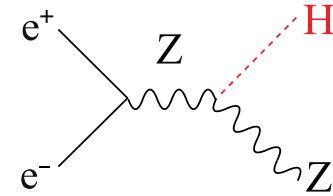

Indirect

precise measurements of known processes

→ look for (tiny) deviations from SM expectation from quantum effects (loops, virtual particles)
 → sensitivities to E-scales $\Lambda \gg \sqrt{s}$ → need high E and high L

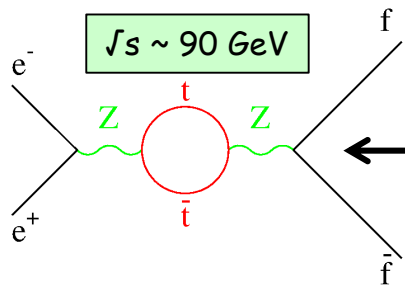

E.g. top mass predicted by LEP1 and SLC in 1993:
 $m_{\text{top}} = 177 \pm 10$ GeV; first direct evidence at Tevatron in 1994: $m_{\text{top}} = 174 \pm 16$ GeV

$$\mathcal{L}_{\text{eff}} = \mathcal{L}_{\text{SM}} + \frac{C_{\text{NP}}}{\Lambda^2} O_{ij}$$

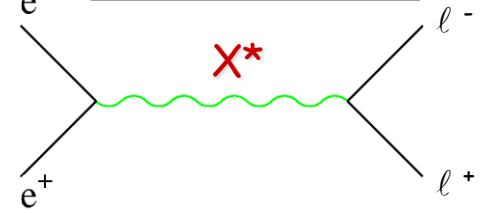

Rare processes

suppressed in SM → could be enhanced by New Physics

e.g. neutrino interactions, rare decay modes → need intense beams, ultra-sensitive (massive) detectors ("intensity frontier")

E.g. transitions between charged leptons of different families with Lepton-Flavour-Violation: $\mu \rightarrow e \gamma$ (MEG@PSI), $\mu \rightarrow e$ (COMET@JPARC, Mu2e@FNAL). Suppressed in SM, can occur if new physics
 Note: flavour violation observed for ν (e.g. $\nu_\mu \rightarrow \nu_e$) and quarks (e.g. $t \rightarrow Wb$)

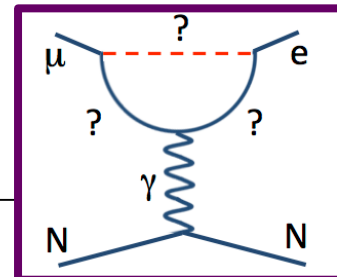

e^+e^- colliders

vs

pp colliders

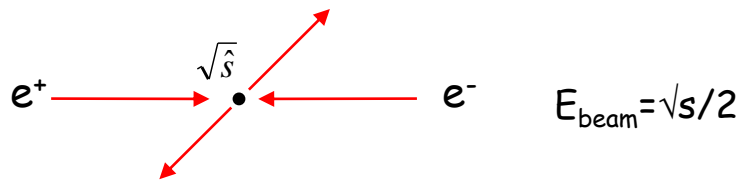

Energy of elementary interaction known
→ strong constraint for final-state reconstruction

$$\sqrt{\hat{s}} = E(e^-) + E(e^+) = \sqrt{s}$$

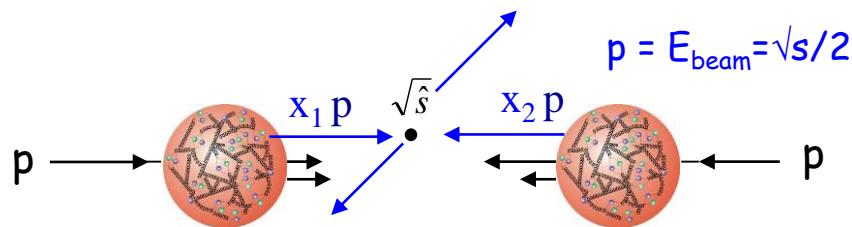

Energy of elementary interaction not known

$$\sqrt{\hat{s}} = \sqrt{x_1 x_2 s} < \sqrt{s}$$

Only two elementary particles collide
→ clean final states

Elementary interaction (hard) + interaction of “spectator” q,g (soft) overlap in detector

Mainly EW processes → “democratic” production of all kinematic accessible particles coupling to Z/γ*

EW processes suffer from huge backgrounds from strong processes → detector performance!

In rings \sqrt{s} limited by e^\pm synchrotron radiation:

$$E_{\text{loss}} \sim \frac{E_{\text{beam}}^4}{R} \frac{1}{m_e^4} \quad E_{\text{loss}} \sim 2.5 \text{ GeV/turn} \quad \text{LEP2 (} E_{\text{beam}} \sim 100 \text{ GeV)}$$

Synchrotron radiation is $\sim (m_p/m_e)^4 \sim 10^{13}$ smaller

clean environment → precision measurements are optimal

high energy easier to achieve → ideal machines for discovery at energy frontier

Note: this is an oversimplified picture ! Many discoveries at e^+e^- machines (τ -lepton, gluon, etc.) and beautiful precision measurements at hadron colliders (W mass, B-physics, etc.)

Options for and physics potential of future high-energy colliders

- Linear and circular e^+e^- colliders
- Very high-E proton-proton colliders

Disclaimer: due to time limitation, I will not discuss other opportunities ($\mu\mu$, ep , $\gamma\gamma$ colliders)

The present and near/medium-term future: LHC and HL-LHC

New LHC / HL-LHC Plan

Schedule
being
updated

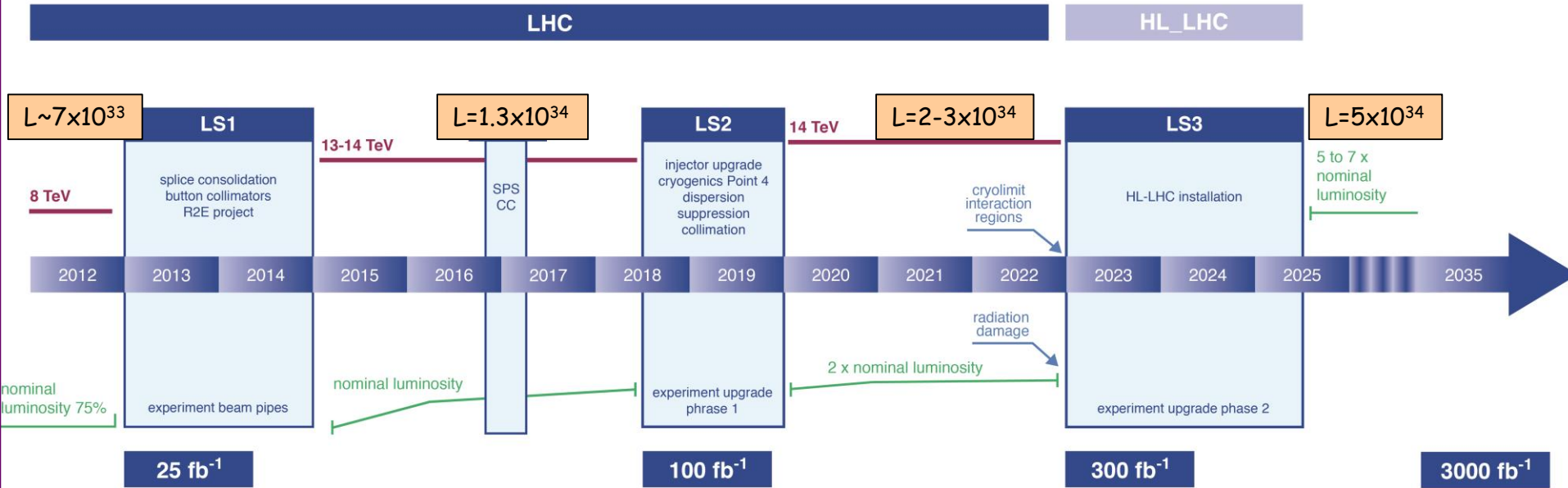

Full exploitation of LHC project with HL-LHC ($\sqrt{s} \sim 14$ TeV, 3000 fb⁻¹) is crucial

- ❑ Present highest-E accelerator:
 - detailed direct exploration of the TeV scale up to $m \sim 10$ TeV
 - measurements of Higgs couplings to few percent
- ❑ Results will inform the future

Future high-E e^+e^- colliders

$$L \sim 10^{34} - 10^{35} \text{ cm}^{-2} \text{ s}^{-1}$$

\sqrt{s} (GeV)	Main physics goals
90	Z-boson precision EW measurements beyond LEP, SLC
180	WW precision physics (mass at threshold)
250	Higgs precision physics (HZ)
350	Higgs precision physics (HZ, H $\nu\nu$), top precision physics (mass at threshold)
500-3000	$t\bar{t}H$, HH (including self-couplings), direct searches for new physics

Complementary

Linear colliders

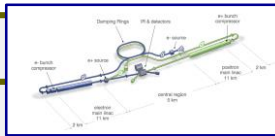

Circular colliders

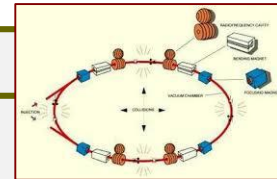

\sqrt{s} reach

multi-TeV

limited to $< 500 \text{ GeV}$
by synchrotron radiation $SR \sim E^4_{\text{beam}}/Rm^4$

Luminosity

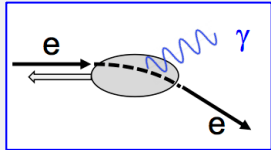

low repetition rate (few Hz)
 $\rightarrow L$ from squeezing beams to $\sim \text{nm}$ size
 \rightarrow large beamstrahlung

large number of continuously circulating bunches \rightarrow larger beam size
 \rightarrow smaller beamstrahlung
 \rightarrow cleaner environment, smaller E spread

Injection

fresh bunches need to be injected at each cycle

short L lifetime ($\sim 30'$) due to burn-off
 \rightarrow continuous top-up e^\pm injection

L vs \sqrt{s}

increases at high E
(beam size decreases)

increases at low E
(less SR \rightarrow RF power accelerates more bunches)

Number of interaction regions

1

several

International Linear Collider (ILC)

Technical Design
Report released
in June 2013

Total length: 31 km

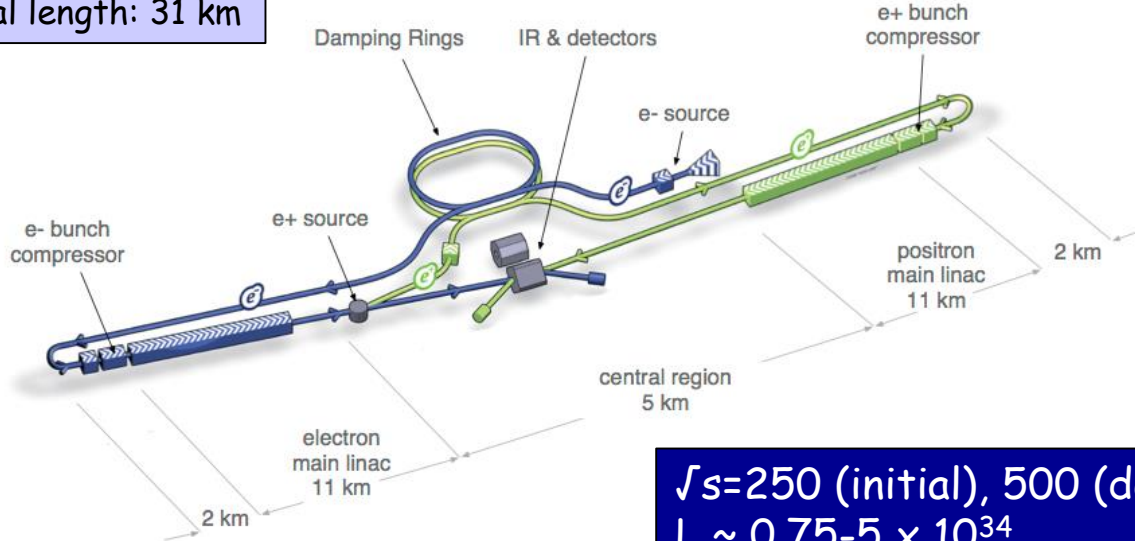

\sqrt{s} = 250 (initial), 500 (design), 1000 (upgrade) GeV
 $L \sim 0.75 - 5 \times 10^{34}$
(running at \sqrt{s} = 90, 160, 350 GeV also envisaged)

Main challenges:

- ❑ ~ 15000 SCRF cavities (1700 cryomodules), 31.5 MV/m gradient
- ❑ 1 TeV machine requires extension of main Linacs (50 km) and 45 MV/m
- ❑ Positron source; suppression of electron-cloud in positron damping ring
- ❑ Final focus: squeeze and collide nm-size beams

- ❑ Japan interested to host → decision ~2018 based also on ongoing international discussions
Mature technology: 20 years of R&D experience worldwide
(e.g. European xFEL at DESY is 5% of ILC, gradient 24 MV/m, some cavities achieved > 30 MV/m)
→ Construction could technically start ~2019, duration ~10 years → physics could start ~2030

Compact Linear Collider (CLIC)

Conceptual Design Report end 2012

Main challenges:

- ❑ 100 MV/m accelerating gradient needed for compact (50 km) multi-TeV (up to 3 TeV) collider
- ❑ Short (156 ns) beam trains → bunch spacing 0.5 ns to maximize luminosity
- ❑ Keep RF breakdown rate small
- ❑ 2-beam acceleration (new concept): efficient RF power transfer from low-E high-intensity drive beam to (warm) accelerating structures for main beam
- ❑ Power consumption (~600 MW !)
- ❑ Preservation of nm size beams and final focus
- ❑ Detectors: huge beamstrahlung background (20 TeV per beam train in calorimeters at $\sqrt{s}=3$ TeV) → 1-10 ns time stamps needed

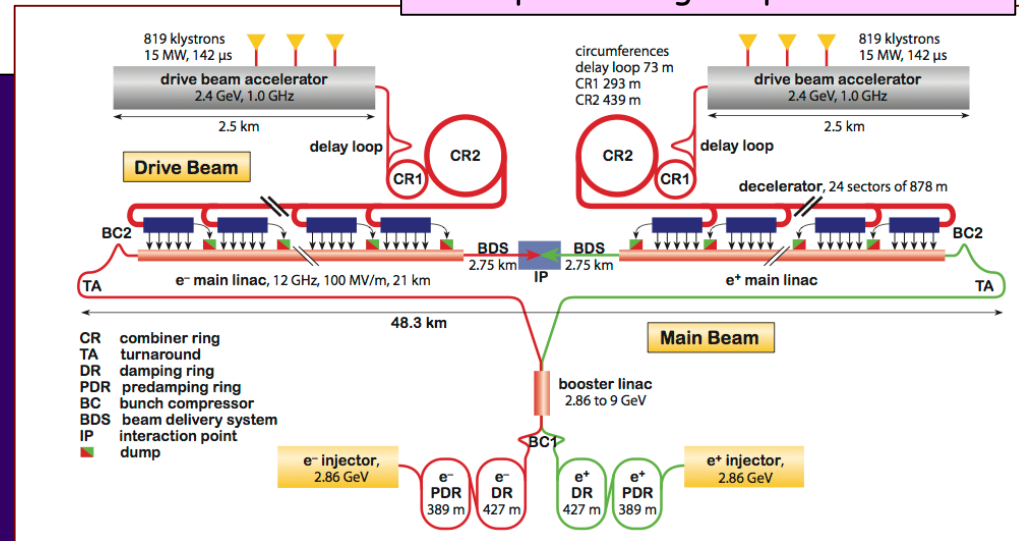

Parameter	Unit	500 GeV	3 TeV
Centre-of-mass energy ^(*)	TeV	0.5	3.0
Repetition frequency	Hz	50	50
Number of bunches per train		354	312
Bunch separation	ns	0.5	0.5
Accelerating gradient	MV/m	80	100
Total luminosity	$10^{34} \text{ cm}^{-2} \text{ s}^{-1}$	2.3	5.9
Luminosity above 99% of \sqrt{s}	$10^{34} \text{ cm}^{-2} \text{ s}^{-1}$	1.4	2.0

(*) Currently optimizing for initial stage at $\sqrt{s}=350$ GeV

If decision to proceed in ~2018 → construction could technically start ~2024, duration ~6 years for $\sqrt{s} \leq 500$ GeV (26 km Linac) → physics could start 2030++

Future high-energy circular colliders

China: 50-70 km e^+e^- $\sqrt{s}=240$ GeV (CepC)
followed by 50-90 TeV pp collider (SppC)
in same tunnel

50 km e^+e^- machine + 2 experiments:

- ❑ pre-CDR submitted
- ❑ construction: 2021-2027
- ❑ data-taking: 2028-2035

Best beach & cleanest air
Summer capital of China

Possible site:
Qinghungdao

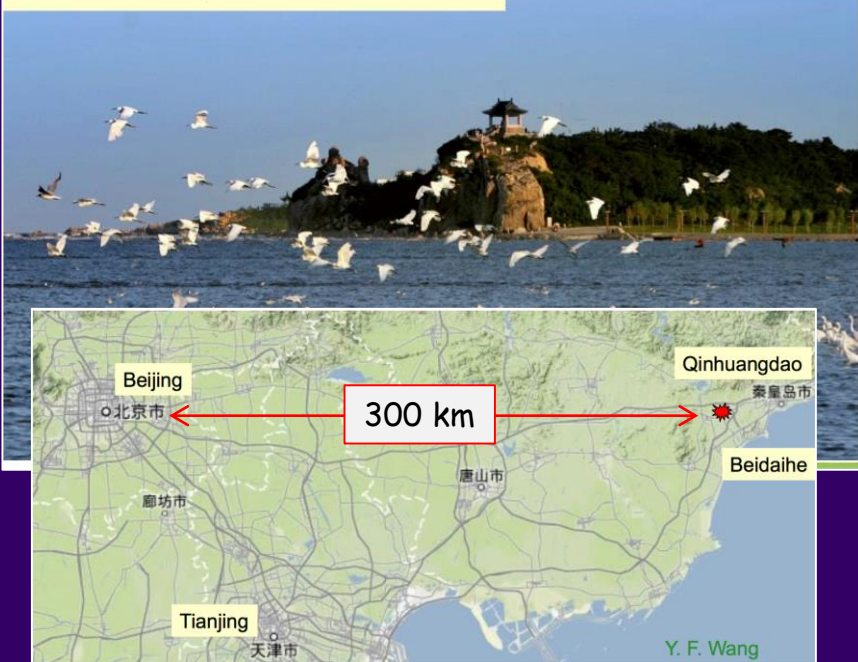

Parameters are indicative and
fast evolving, as no CDR yet

CERN FCC: international design study for
Future Circular Colliders in 80-100 km ring:

- ❑ 100 TeV pp: ultimate goal (FCC-hh)
 - ❑ 90-350 GeV e^+e^- : possible intermediate step (FCC-ee)
 - ❑ $\sqrt{s}=3.5-6$ TeV ep: option (FCC-eh)
- Goal of the study: CDR in ~2018.

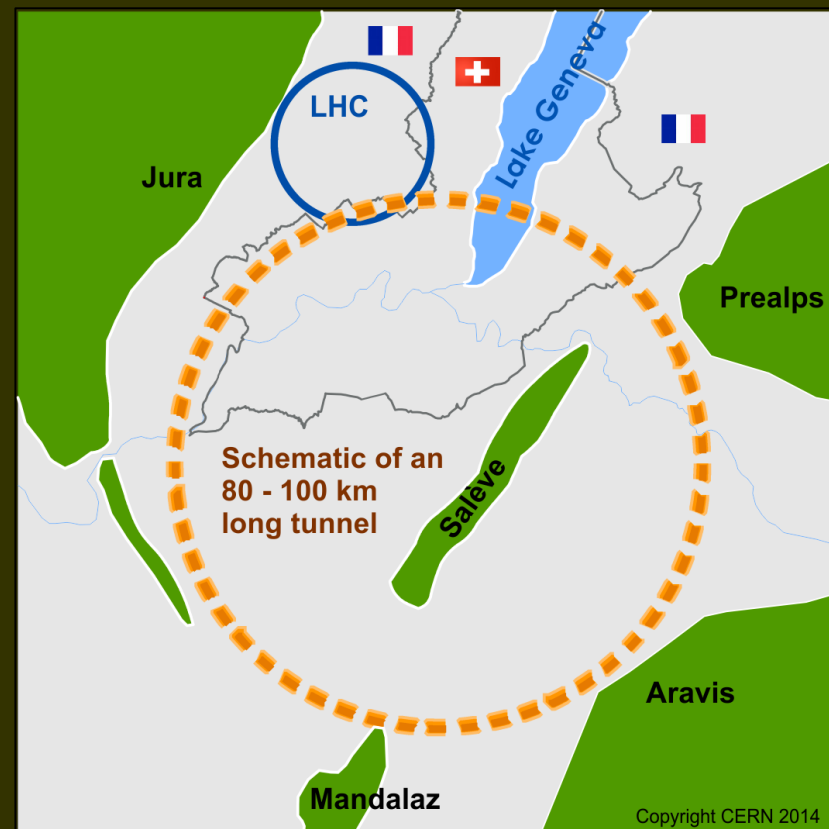

Summary of e^+e^- colliders main parameters

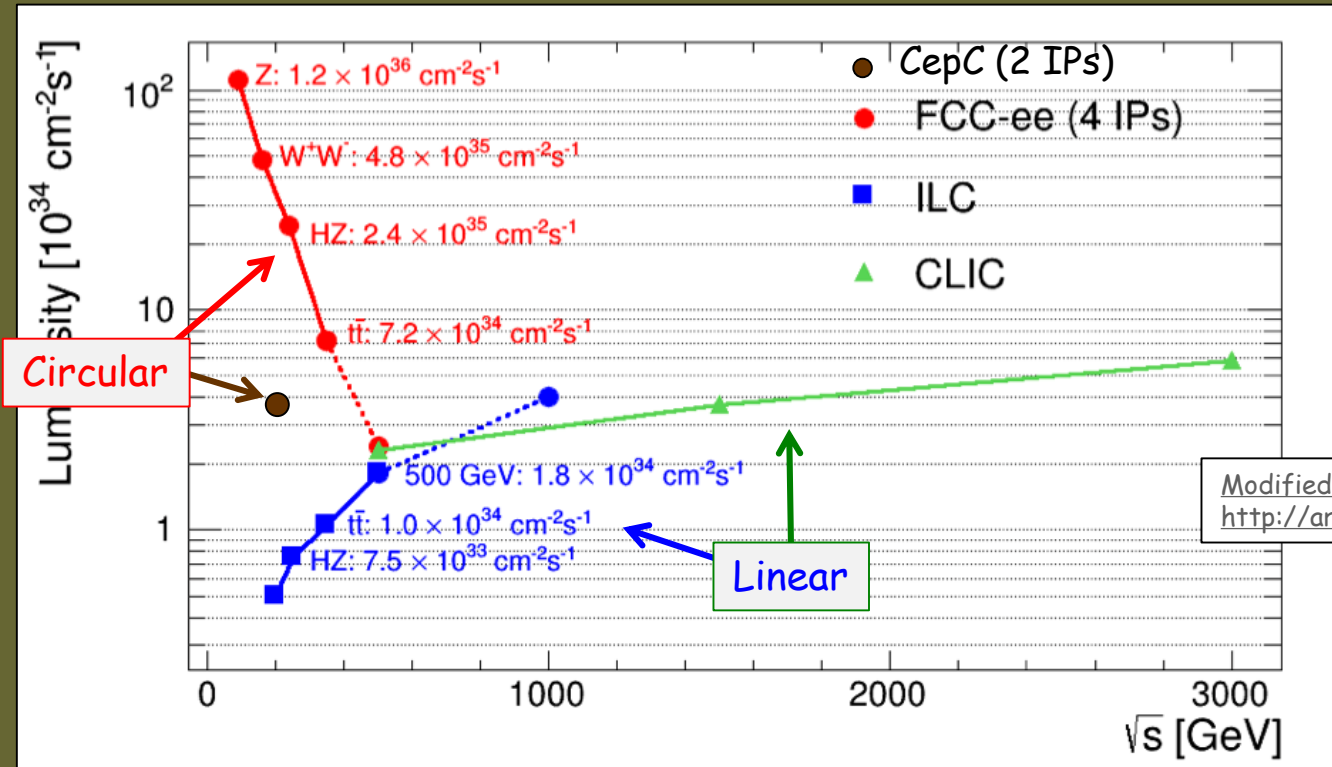

Some typical energy points only

	Size km	\sqrt{s} GeV	RF MV/m	L per IP 10^{34}	Bunch/train x-ing rate(Hz)	σ_x μm	σ_y nm	Lumi within 1% of \sqrt{s}	Long. polarisation e^-/e^+
CEPC	54	240	20	1.8	4×10^5	74	160	>99%	considered
FCC-ee	100	240	20	6	2×10^7	22	45	>99%	considered
ILC	31	250	14.7	0.75	5	0.7	7.7	87%	80%/30%
ILC	31	500	31.5	1.8	5	0.5	5.9	58%	80%/30%
CLIC	48	3000	100	6	50	0.04	1	33%	80%/considered

Future pp colliders

	Ring (km)	Magnets (T)	\sqrt{s} (TeV)	L (10^{34})
LHC	27	8.3	14	up to 5
HE-LHC	27	16-20	26-33	5
SppC-1	50	12	50	2
SppC-2	70	19	90	2.8
FCC-hh	100	16	100	≥ 5

$$p(\text{TeV}) = 0.3 B(\text{T}) R(\text{km})$$

Magnet technology:
 Nb_3Sn ok up to 16 T;
 HTS=High-Temperature-Superconductors
 needed for 20 T

May reach $\sim 2 \times 10^{35}$

More parameters of 100 TeV FCC-hh

	HL-LHC	FCC-hh
Bunch spacing	25	5-25
N. of bunches	2808	10600
Pile-up	140	170
E-loss/turn	7 keV	5 MeV
SR power/ring	3.6 kW	2.5 MW
Interaction Points	4	4
Stored beam energy	390 MJ	8.4 GJ

Challenges (many, daunting, ...):
 magnet technology, tunnel excavation,
 stored beam energy, ...

As an Airbus 380 at full speed

Cross sections vs \sqrt{s}

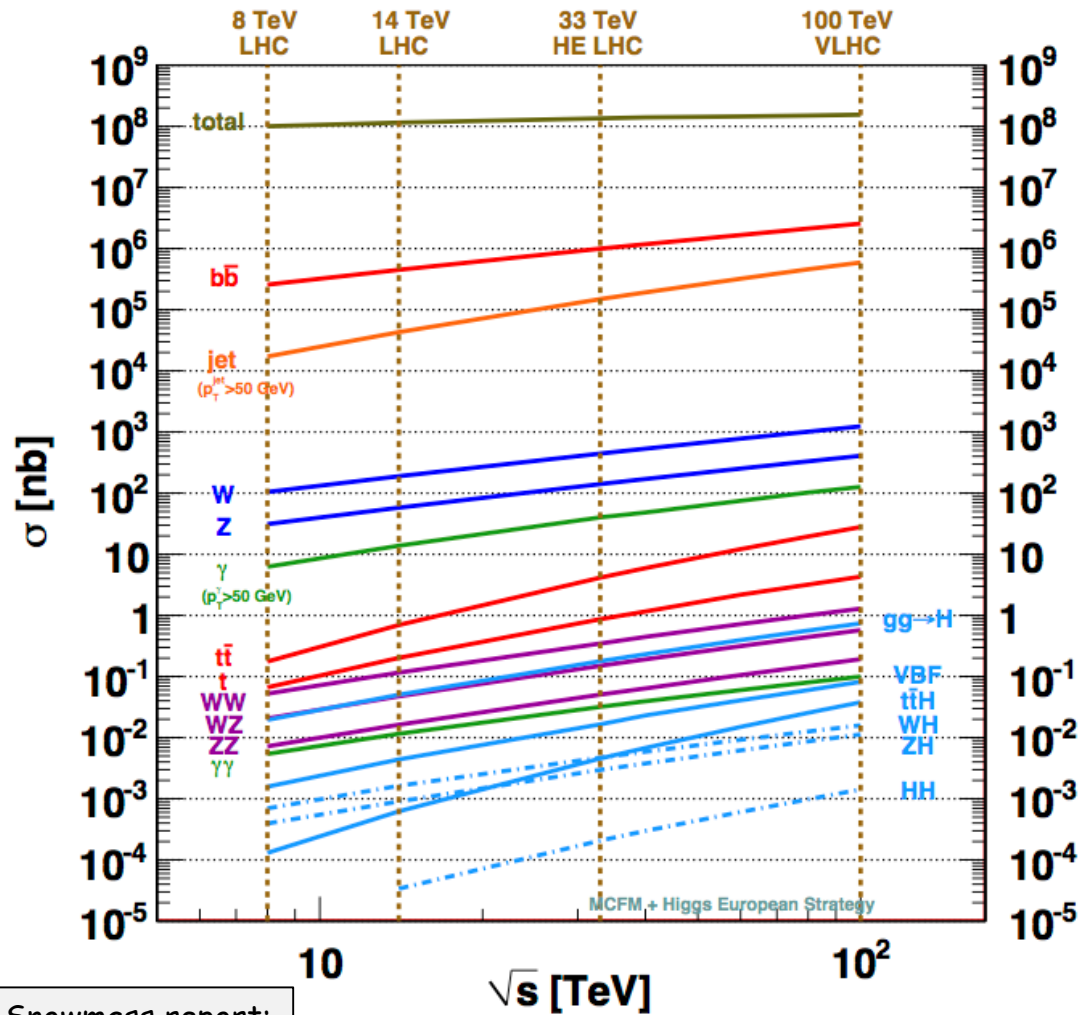

Snowmass report:
arXiv:1310.5189

Process	$\sigma (100 \text{ TeV})/\sigma (14 \text{ TeV})$
Total pp	1.25
W	~ 7
Z	~ 7
WW	~ 10
ZZ	~ 10
tt	~ 30
H	~ 15 (ttH ~ 60)
HH	~ 40
stop ($m=1 \text{ TeV}$)	$\sim 10^3$

→ With 10000/fb at $\sqrt{s}=100 \text{ TeV}$ expect: 10^{12} top, 10^{10} Higgs bosons, 10^8 $m=1 \text{ TeV}$ stop pairs, ...

The Higgs boson as a door into new physics ?

Impact of New Physics on Higgs couplings to fermions and bosons

$\Delta\kappa/\kappa \sim 5\%/\Lambda_{NP}^2$ (Λ_{NP} in TeV)

Scenarios exist with no new particles observable at LHC
 → New Physics would appear only through deviations to H couplings
 → 0.1-1% experimental precision needed for discovery

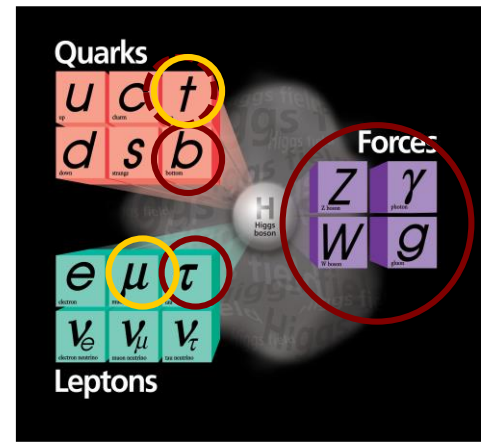
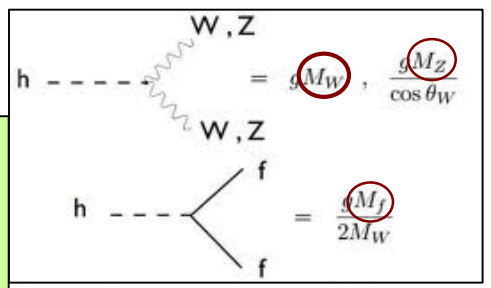

Higgs couplings from studies of:

- decays (direct or via loops): $H \rightarrow ZZ, WW, \gamma\gamma(\text{loop}), bb, \tau\tau, cc, \mu\mu$
- production: $WH, ZH, ttH, gg \rightarrow H(\text{loop})$

In addition: self couplings $H \rightarrow HH$

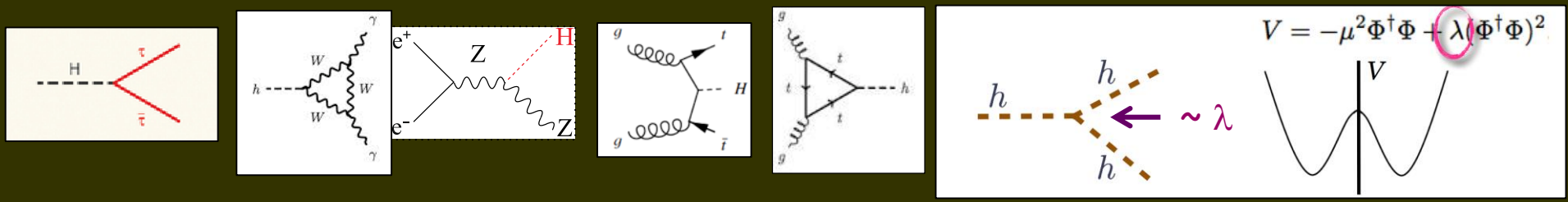

LHC Run-1: ~20% precision on couplings to bosons and 3rd generation fermion (ttH indirect)
 LHC 14 TeV, 300 fb⁻¹ (~2023): 5-10% precision

HL-LHC:

- 2-5% for most couplings
- first direct observation of couplings to top ($ttH \rightarrow tt\gamma\gamma$) and 2nd family fermions ($H \rightarrow \mu\mu$)
- Higgs self-coupling ?

Integrated luminosities correspond to 10 years of running (3-5 years at each \sqrt{s}) for e^+e^- and 5 years with 2 experiments for pp

	\sqrt{s} (TeV)	L (ab ⁻¹)	N_H (10 ⁶)	$N_{t\bar{t}H}$	N_{HH}
FCC-ee*	0.24+0.35	10	2	--	--
ILC	0.25+0.5	0.75	0.2	1000	100
ILC-1TeV	0.25+0.5+1	1.75	0.5	3000	400
CLIC	0.35+1.4+3	3.5	1.5	3000	3000

$t\bar{t}H, HH$: heavy final states
 \rightarrow require energy (≥ 0.5 TeV)!

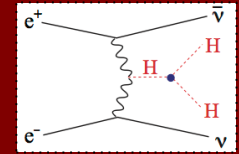
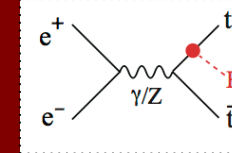

HL-LHC	14	3	180	3600 $t\bar{t}\gamma\gamma$	250 $b\bar{b}\gamma\gamma$
FCC-hh	100	6	5400	12000 $t\bar{t}4l$	20000 $b\bar{b}\gamma\gamma$

* 4 IP

<10% of events usable

Couplings to "light particles"

$K_W, K_Z, K_g, K_c, K_\tau, K_b$:
 best measurements (few 0.1%) at
 FCC-ee (clean; luminosity)

Couplings derived from heavy final states:

- K_t : best measurements ($\leq 5\%$) at
 HL-LHC, ILC(1000), CLIC, FCC-hh
- K_{HH} (self-couplings): best measurements ($\sim 10\%$)
 at ILC(1000), CLIC, FCC-hh
 (heavy final state \rightarrow energy)

Rare decays: K_μ, K_ν

Best measurements (few 1%) at
 HL-LHC, FCC-ee, FCC-hh, ILC (1000), CLIC
 (luminosity and/or energy)

Direct and indirect sensitivity to high-E new physics

e^+e^- colliders

- ❑ Direct: discovery potential for new particles coupling to Z/γ^* up to $m \sim \sqrt{s}/2$
- ❑ Indirect: via precise measurements
 \rightarrow ILC/CLIC/FCC-ee can probe up to $\Lambda_{NP} \sim O(100)$ TeV

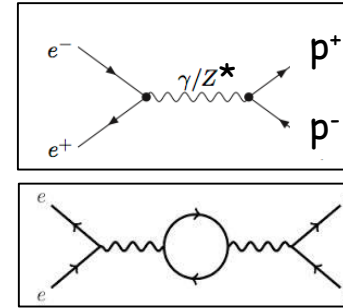

HL-LHC (3000 fb^{-1}):

- ❑ Direct: discovery potential up to $m \sim 10$ TeV for single particles ($\sim 30\%$ larger than 300 fb^{-1})
- ❑ Indirect sensitivity up to ~ 50 TeV (e.g. quark compositeness scale)

A 100 TeV pp collider is the instrument to explore the 10-50 TeV E-scale directly

Examples:

- Discovery potential for excited quarks q^* (expected if quarks are composite): $m \sim 50$ TeV
- Discovery potential for Z' (expected if additional forces exist): $m \sim 30$ TeV
- Discovery potential for SUSY squarks and gluinos (pair produced): $m \sim 15$ TeV



SUSY has excellent candidate for dark matter (lightest neutralino χ^0): discovery reach up to ~ 4 TeV \rightarrow cover most of region allowed by cosmology

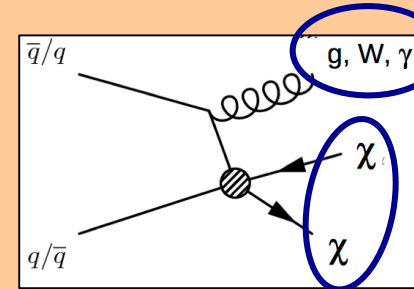

Mono-jet/ γ /W from initial-state radiation provides trigger

χ^0 are invisible \rightarrow missing E

SUSY would also explain why Higgs mass is so light ("naturalness" problem)

Conclusions

The extraordinary success of the LHC is the result of the ingenuity, vision and perseverance of the worldwide HEP community, and of more than 20 years of talented, dedicated work → the demonstrated strength of the community is an asset also for future, even more ambitious, projects.

With the discovery of a Higgs boson, after > 50 years of superb theoretical and experimental work the SM is now complete. However major questions remain.

The full exploitation of the LHC, and more powerful future accelerators, will be needed to address them and to advance our knowledge of fundamental physics.

No doubt that future high-E colliders are extremely challenging projects
Didn't the LHC also look close-to-impossible in the '80s ??

However: the correct approach, as scientists, is not to abandon our exploratory spirit, nor give up to financial and technical challenges. The correct approach is to use our creativity to develop the technologies needed to make future projects financially and technically affordable

We already did so in the past ... →

From E. Fermi, preparatory notes for a talk on
 "What can we learn with High Energy Accelerators ?"
 given to the American Physical Society, NY, Jan. 29th 1954

For these reasons...clamoring for higher and higher....

Slide 1 - MeV - M\$ versus time.

Extrapolating to 1994...5 hi 9 Mev or hiest cosmic...170 B\$....preliminary design....8000 km, 20000 gauss

Slide 2 - 5 hi 15 eV machine.

What we can learn impossible to guess...main element surprise...some things look for but see others....Experiens on pions...sharpening knowledge...~~aspis here and odd way~~...certainly look for multiple production...
What experiments

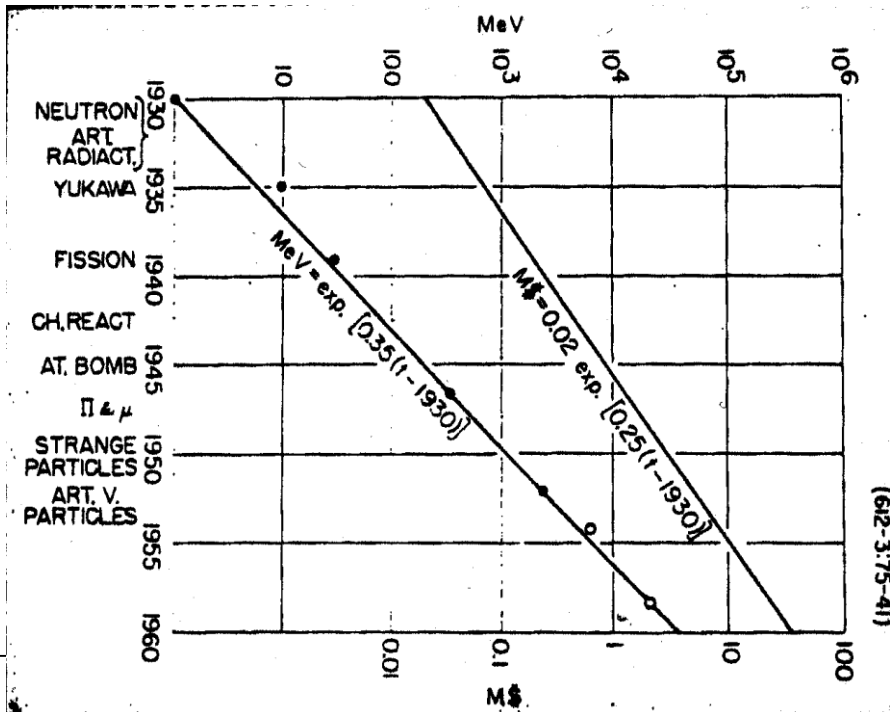

Fermi's extrapolation to year 1994:
 2T magnets, R=8000 km (fixed target !),
 $E_{beam} \sim 5 \times 10^3 \text{ TeV} \rightarrow \sqrt{s} \sim 3 \text{ TeV}$
 Cost : 170 B\$

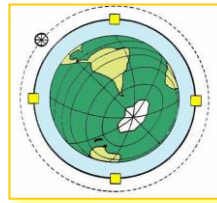

Was that hopeless ??

We have found the solution:
 we have invented colliders
 and superconducting magnets ...
 and built the Tevatron and the LHC

THANK YOU !



SPARES

How to choose the future high-E collider project(s) ?



LHC Run-1 brought us a certitude: the Higgs boson as the key of EWSB

- $H(125)$ needs to be studied with the highest precision → door to new physics ?
- low m_H makes H accessible to both circular and linear colliders, with different pros/cons
- complete exploration of EWSB needed (HH production, $V_L V_L$ scattering, look for possible new dynamics, etc.) → requires multi-TeV energies

LHC Run-2 and beyond may (hopefully !) bring additional "no-lose theorems":

- if new (heavy) physics is discovered
 - completion of spectrum and detailed measurements of new physics likely require multi-TeV energies
- if indications emerge for the scale of new physics in the 10-100 TeV region (e.g. from dijet angular distributions → Λ compositeness)
 - need the highest-energy pp collider to probe directly the scale of new physics



Regardless of the detailed scenario, and even in the absence of theoretical/experimental preference for a specific E scale, the directions for future high-E colliders are clear:

- highest energy → to explore directly E scales of 10-100 TeV
- highest precision → to probe the largest E scales indirectly → possibly up to few 100 TeV

Thanks also to great technology progress, many scientifically strong opportunities are available: none of them is easy, none is cheap.

Decision on how to proceed, and the time profile of the projects, depends on science (LHC results), technology maturity, cost and funding availability, global (worldwide) perspective

Main questions in today's particle physics

Higgs boson and EWSB

- m_H natural or fine-tuned ?
→ if natural: what new physics/symmetry?
- does it regularize the divergent $V_L V_L$ cross-section at high $M(V_L V_L)$? Or is there a new dynamics ?
- elementary or composite Higgs ?
- is it alone or are there other Higgs bosons ?
- origin of couplings to fermions
- coupling to dark matter ?
- does it violate CP ?
- cosmological EW phase transition
(is it responsible for baryogenesis ?)

Neutrinos:

- ν masses and their origin
- what is the role of H(125) ?
- Majorana or Dirac ?
- CP violation
- additional species ? sterile ν ?

Dark matter:

- composition: WIMP, sterile neutrinos, axions, other hidden sector particles, ..
- one type or more ?
- only gravitational or other interactions ?

The two epochs of Universe's accelerated expansion:

- primordial: is inflation correct ?
which (scalar) fields? role of quantum gravity?
- today: dark energy (why is Λ so small?) or gravity modification ?

Quarks and leptons:

- why 3 families ?
- masses and mixing
- CP violation in the lepton sector
- matter and antimatter asymmetry
- baryon and charged lepton number violation

Physics at the highest E-scales:

- how is gravity connected with the other forces ?
- do forces unify at high energy ?

LHC schedule beyond LS1

LS2 starting in 2018 (July) => 18 months + 3 months BC
 LS3 LHC: starting in 2023 => 30 months + 3 months BC
 Injectors: in 2024 => 13 months + 3 months BC

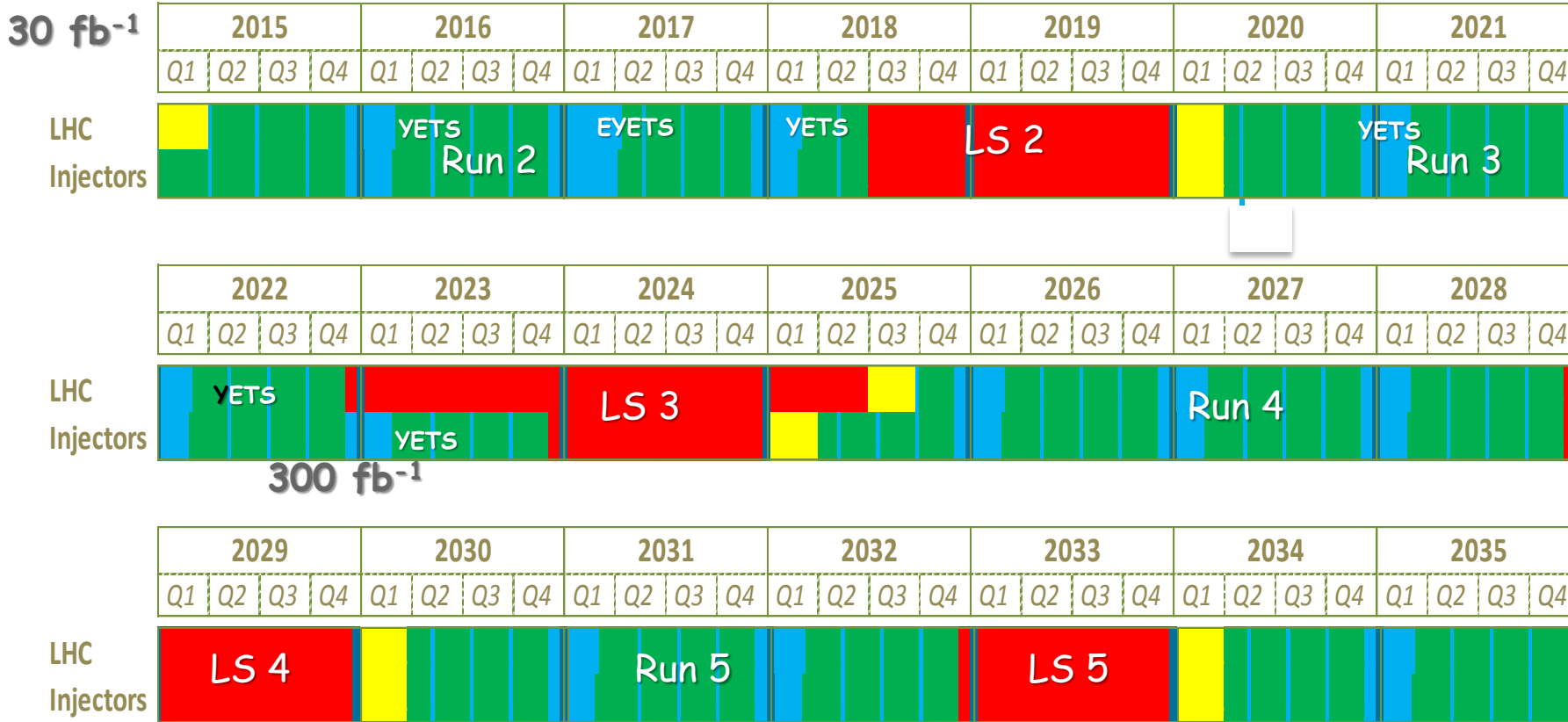
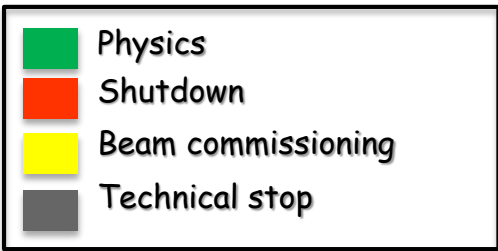

(Extended) Year End Technical Stop: (E)YETS

3'000 fb⁻¹

LHC schedule approved by CERN management and LHC experiments spokespersons and technical coordinators (December 2013)

Higgs production vs \sqrt{s}

e^+e^- colliders

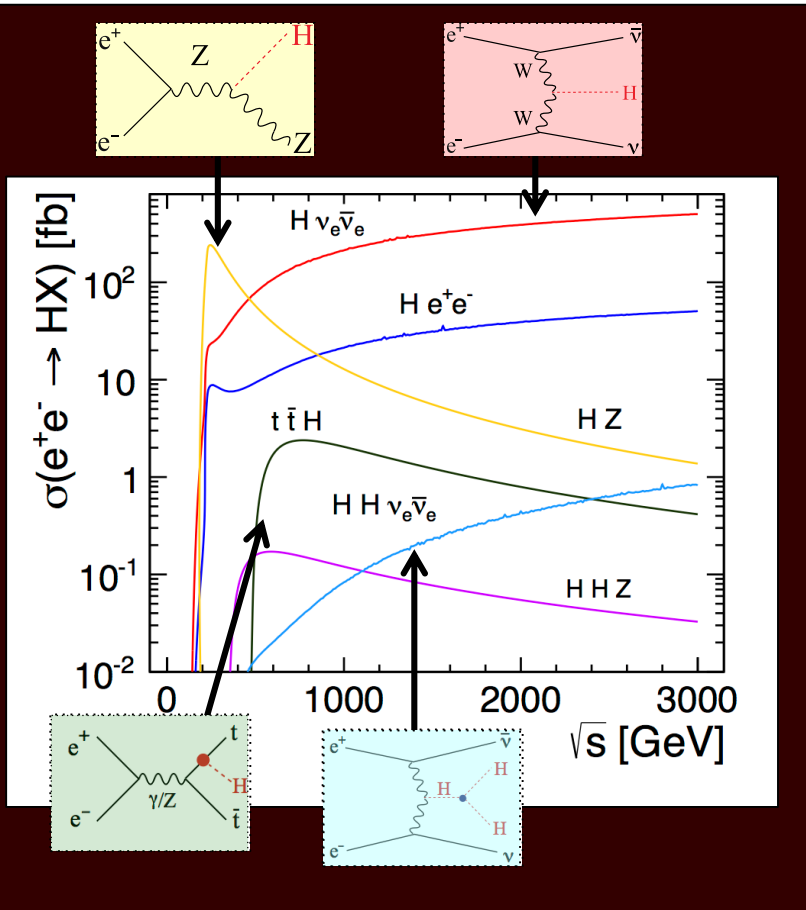

pp colliders

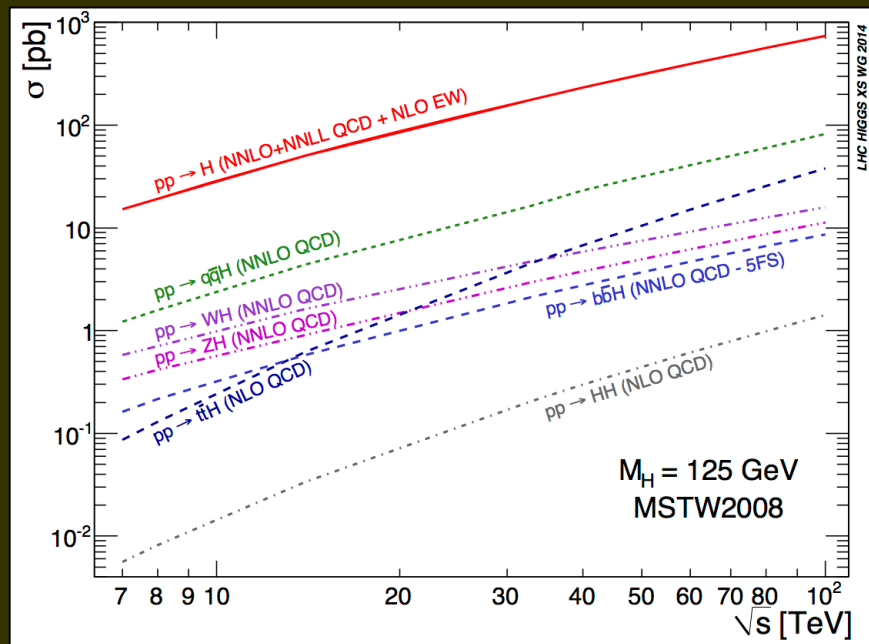
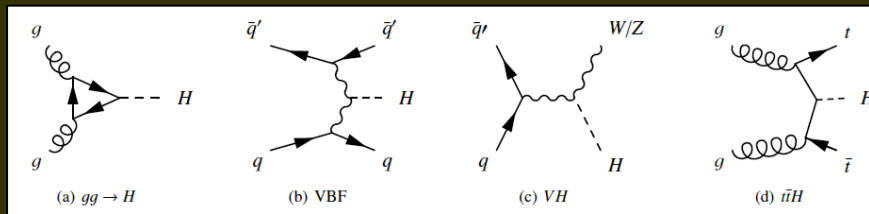

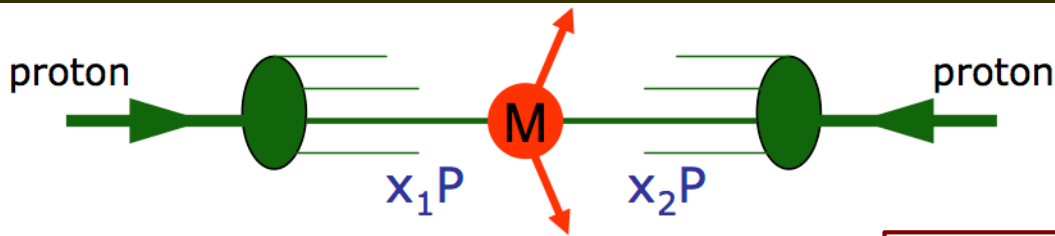

$$M^2 = (p_1 + p_2)^2 \equiv \hat{s} = x_1 x_2 s$$

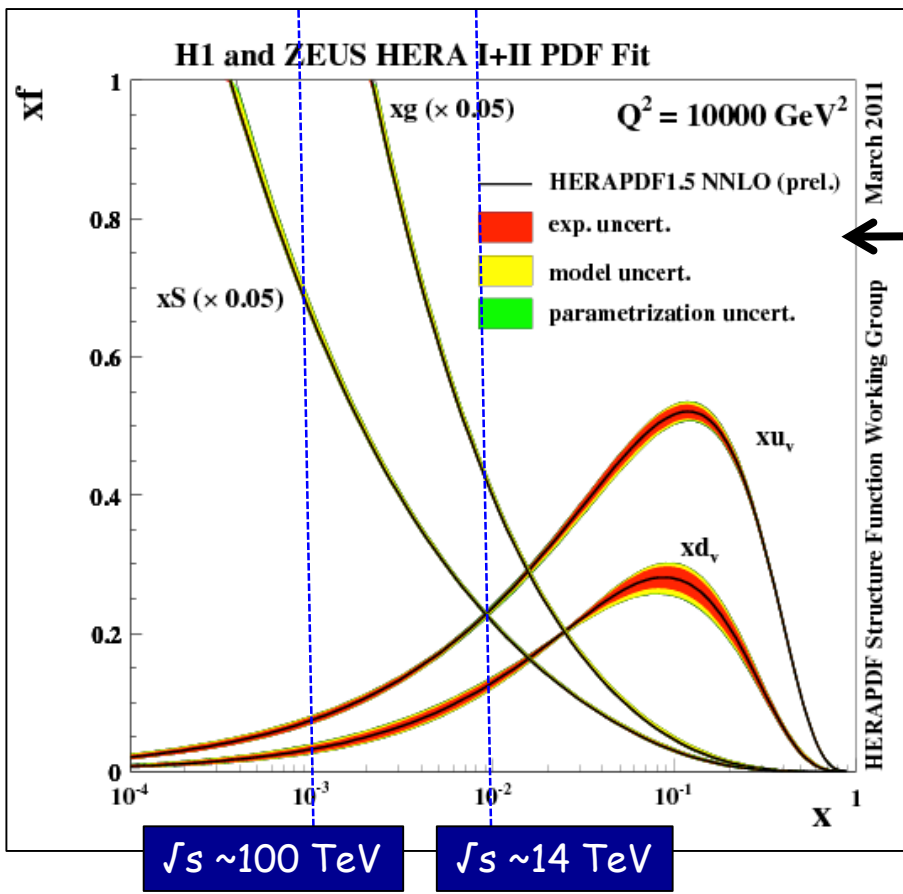

Parton Distribution Functions (PDF) in the proton for $Q^2 \sim m_H^2$

Elementary cross-sections scale like $\sim 1/s$. However, for a fixed mass M of the produced particle, the needed $x_{1,2}$ to produce it decrease with increasing \sqrt{s} . Since the number of gluons increases dramatically at small x , the resulting cross-section increases with \sqrt{s} (LHC and future hadron machines can be de facto considered as "gluon-gluon colliders")

Table 3.1. Summary table of the 250–500 GeV baseline and luminosity and energy upgrade parameters. Also included is a possible 1st stage 250 GeV parameter set (half the original linac length)

			Baseline 500 GeV Machine			1st Stage	L Upgrade	E_{CM} Upgrade	
			250	350	500	250	500	A 1000	B 1000
Centre-of-mass energy	E_{CM}	GeV	250	350	500	250	500		
Collision rate	f_{rep}	Hz	5	5	5	5	5	4	4
Electron linac rate	f_{linac}	Hz	10	5	5	10	5	4	4
Number of bunches	n_b		1312	1312	1312	1312	2625	2450	2450
Bunch population	N	$\times 10^{10}$	2.0	2.0	2.0	2.0	2.0	1.74	1.74
Bunch separation	Δt_b	ns	554	554	554	554	366	366	366
Pulse current	I_{beam}	mA	5.8	5.8	5.8	5.8	8.8	7.6	7.6
Main linac average gradient	G_a	MV m ⁻¹	14.7	21.4	31.5	31.5	31.5	38.2	39.2
Average total beam power	P_{beam}	MW	5.9	7.3	10.5	5.9	21.0	27.2	27.2
Estimated AC power	P_{AC}	MW	122	121	163	129	204	300	300
RMS bunch length	σ_z	mm	0.3	0.3	0.3	0.3	0.3	0.250	0.225
Electron RMS energy spread	$\Delta p/p$	%	0.190	0.158	0.124	0.190	0.124	0.083	0.085
Positron RMS energy spread	$\Delta p/p$	%	0.152	0.100	0.070	0.152	0.070	0.043	0.047
Electron polarisation	P_-	%	80	80	80	80	80	80	80
Positron polarisation	P_+	%	30	30	30	30	30	20	20
Horizontal emittance	$\gamma\epsilon_x$	μm	10	10	10	10	10	10	10
Vertical emittance	$\gamma\epsilon_y$	nm	35	35	35	35	35	30	30
IP horizontal beta function	β_x^*	mm	13.0	16.0	11.0	13.0	11.0	22.6	11.0
IP vertical beta function	β_y^*	mm	0.41	0.34	0.48	0.41	0.48	0.25	0.23
IP RMS horizontal beam size	σ_x^*	nm	729.0	683.5	474	729	474	481	335
IP RMS vertical beam size	σ_y^*	nm	7.7	5.9	5.9	7.7	5.9	2.8	2.7
Luminosity	L	$\times 10^{34} \text{ cm}^{-2} \text{ s}^{-1}$	0.75	1.0	1.8	0.75	3.6	3.6	4.9
Fraction of luminosity in top 1%	$L_{0.01}/L$		87.1%	77.4%	58.3%	87.1%	58.3%	59.2%	44.5%
Average energy loss	δ_{BS}		0.97%	1.9%	4.5%	0.97%	4.5%	5.6%	10.5%
Number of pairs per bunch crossing	N_{pairs}	$\times 10^3$	62.4	93.6	139.0	62.4	139.0	200.5	382.6
Total pair energy per bunch crossing	E_{pairs}	TeV	46.5	115.0	344.1	46.5	344.1	1338.0	3441.0

CEPC 参数表

Number of IPs	2
Energy (GeV)	120
Circumference (km)	53.6
SR loss/turn (GeV)	3.01
N_e /bunch (10^{11})	3.71
Bunch number	50
Beam current (mA)	16.6
SR power /beam (MW)	50
B_0 (T)	0.065
Bending radius (km)	6.1
Momentum compaction (10^{-4})	0.415
β_{IP} x/y (m)	0.8/0.0012 (ratio:667)
Emittance x/y (nm)	6.8/0.02 (ratio:333)
Transverse σ_{IP} (um)	73.7/0.16 (ratio:470)
ξ_x /IP	0.104
ξ_y /IP	0.074
V_{RF} (GV)	6.87
f_{RF} (MHz)	700
Nature bunch length σ_z (mm)	2.26
Bunch length include BS (mm)	2.6
Nature Energy spread (%)	0.13
Energy acceptance RF(%)	5.4
Energy acceptance(%)	2
n_y	0.22
δ_{BS} (%)	0.07
Life time due to beamstrahlung-Telnov (minute)	2028
Life time due to simulation (minute)	150
L_{max} /IP ($10^{34}\text{cm}^{-2}\text{s}^{-1}$)	1.82

SppC参数表

Physics performance and beam parameters						
Peak luminosity per IP	1.0E34	5.0E34	5.0E34	5.0E34	1.2E+35	cm⁻²s⁻¹
Beta function at collision	0.55	0.15	0.35	1.1	0.75	m
Circulating beam current	0.584	1.12	0.478	0.5	1.0	A
Max beam-beam tune shift perIP	0.01	0.015	0.01	0.01	0.0075	
Bunch separation	25	25	25	25 5	25	ns
Number of bunches	2808	2808	2808	10600 (8900) 53000 (44500)	5333	
Bunch population	1.15E11	2.2E11	1.0E11	1.0E11	2.0E+11	
Normalized rms transverse emittance	3.75	2.5	1.38	2.2	3.3	mm
Beam life time due to burn-off	45	15.4	5.7	19.1/15.9	8.7	hour
Total / inelastic cross section	111/85	111/85	129/93	153/108	140	mbarn
Reduction factor in luminosity (F)					0.85	
Full crossing angle	285	590	185	74	139	mrاد
rms bunch length	75.5	75.5	75.5	80/75.5	75.5	mm
rms IP spot size	16.7	7.1	5.2	6.8	8.5	mm
Beta at the 1st parasitic encounter					19.5	m
rms spot size at the 1st parasitic encounter					43.3	mm
Stored energy per beam	0.392	0.694	0.701	8.4/7.0	5.4	GJ
SR power per ring	0.0036	0.0073	0.0962	2.4/2.9	1.5	MW
Arc SR heat load	0.17	0.33	4.35	28.4/44.3	45.8	W/m
Energy loss per turn	0.0067	0.0067	0.201	4.6/5.86	1.49	MeV



Lepton collider FCC-ee parameters

- **Design choice: max. synchrotron radiation power set to 50 MW/beam**
 - Defines the max. beam current at each energy.
 - 4 Physics working points
 - Optimization at each energy (bunch number & current, emittance, etc).

Parameter	Z	WW	H	$t\bar{t}_{\text{bar}}$	LEP2
E/beam (GeV)	45	80	120	175	104
I (mA)	1450	152	30	6.6	3
Bunches/beam	16700	4490	170	160	4
Bunch popul. [10^{11}]	1.8	0.7	3.7	0.86	4.2
L ($10^{34} \text{ cm}^{-2}\text{s}^{-1}$)	28.0	12.0	4.5	1.2	0.012

- For H and $t\bar{t}_{\text{bar}}$ working points the beam lifetime of ~few minutes is dominated by Beamstrahlung (momentum acceptance of 2%).



	CepC	FCC-ee		
Ring (km)	53.6	100		
\sqrt{s} (GeV)	240	240	350	90
E loss per turn (GeV)	3	1.7	7.5	0.03
Total RF voltage (GV)	6.9	5.5	11	2.5
Beam current (mA)	16.6	30	6.6	1450
N. of bunches	50 (one ring!)	1360	98	16700
L ($10^{34} \text{ cm}^{-2} \text{ s}^{-1}$)/IP	1.8	6	1.8	28
e^\pm /bunch (10^{11})	3.7	0.46	1.4	1.8
σ_y/σ_x at IP (μm)	0.16/74	0.045/22	0.045/45	0.25/121
Interaction Points	2	4	4	4
Lumi lifetime (min)	60	21	15	213
SR power/beam	50 MW	50 MW		

Main challenges:

- ❑ FCC ring size
- ❑ Synchrotron radiation \rightarrow 100 MW RF system with high efficiency
- ❑ Beam polarization for beam energy calibration at Z-pole and WW threshold to $<100 \text{ keV}$ to measure m_Z , m_W to $< \text{MeV}$ at FCC-ee
- ❑ Machine design with large energy acceptance over full \sqrt{s} span

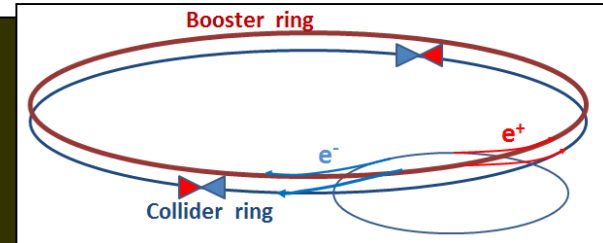

Note: Super-KEKB is an excellent "prototype", with more stringent requirements on positron rate, momentum acceptance, lifetime, β_y^*

Measurements of Higgs couplings

CMS Projection

300 fb⁻¹

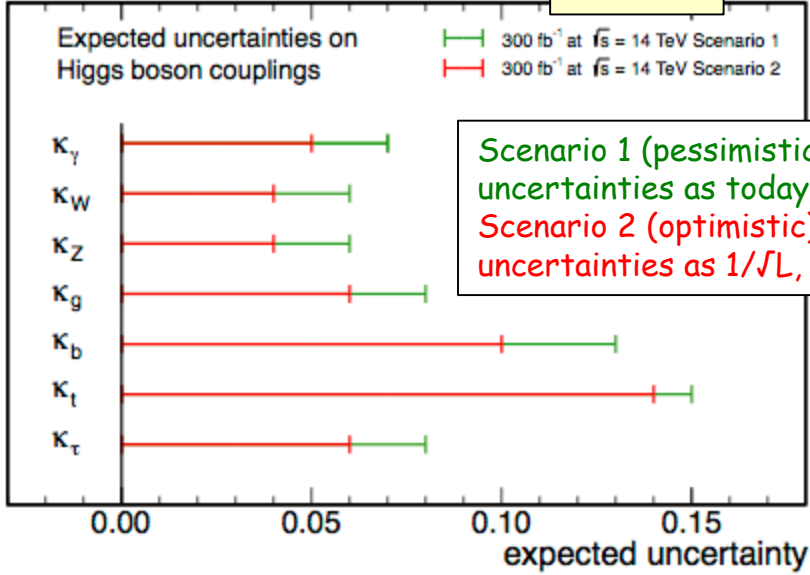

CMS Projection

3000 fb⁻¹

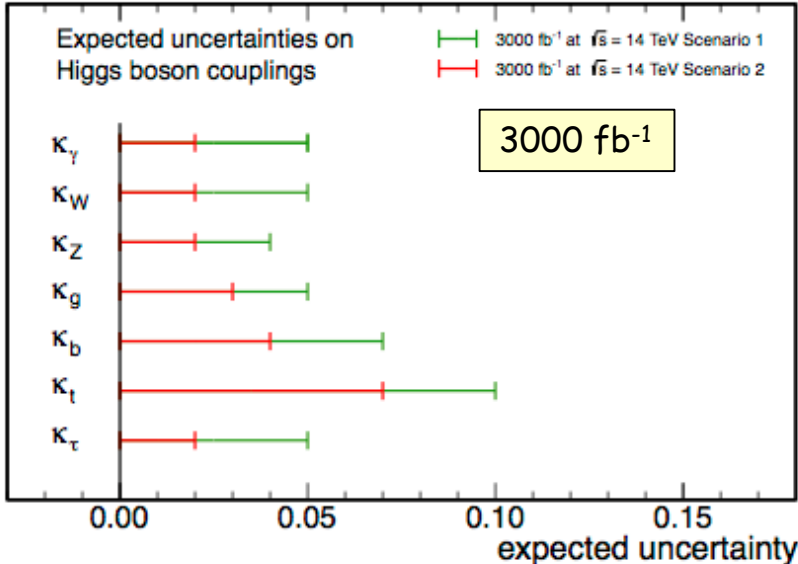

$k_i =$ measured coupling normalized to SM prediction
 $\lambda_{ij} = k_i / k_j$

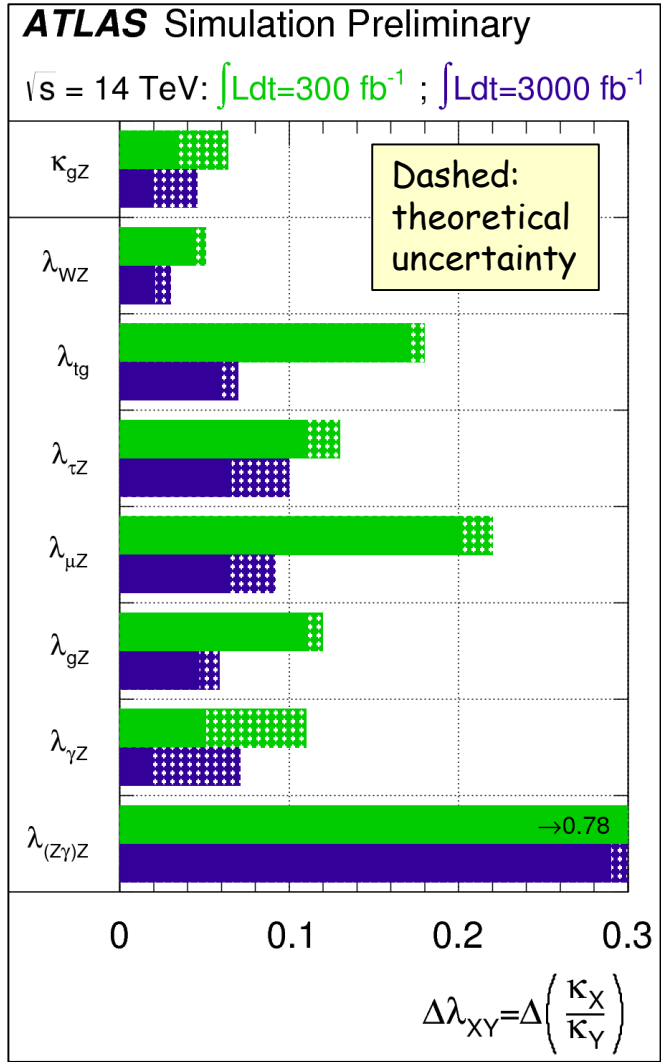

- Main conclusions:
- 3000 fb⁻¹: typical precision 2-10% per experiment (except rare modes) → 1.5-2x better than with 300 fb⁻¹
 - Crucial to also reduce theory uncertainties

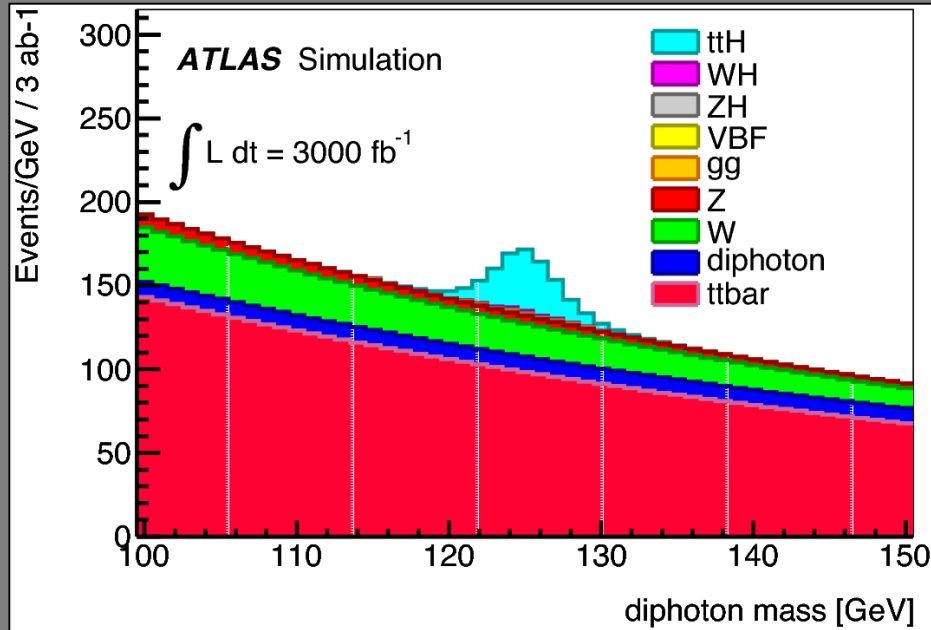

ttH production
with $H \rightarrow \gamma\gamma$

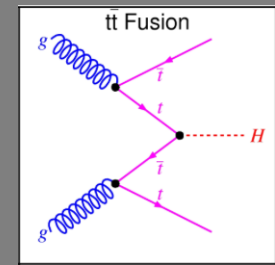

- Gives direct access to Higgs-top coupling (intriguing as top is heavy)
- Today's sensitivity: 6xSM cross-section
- With 3000 fb⁻¹ expect 200 signal events ($S/B \sim 0.2$) and $> 5\sigma$
- Higgs-top coupling can be measured to about 10%

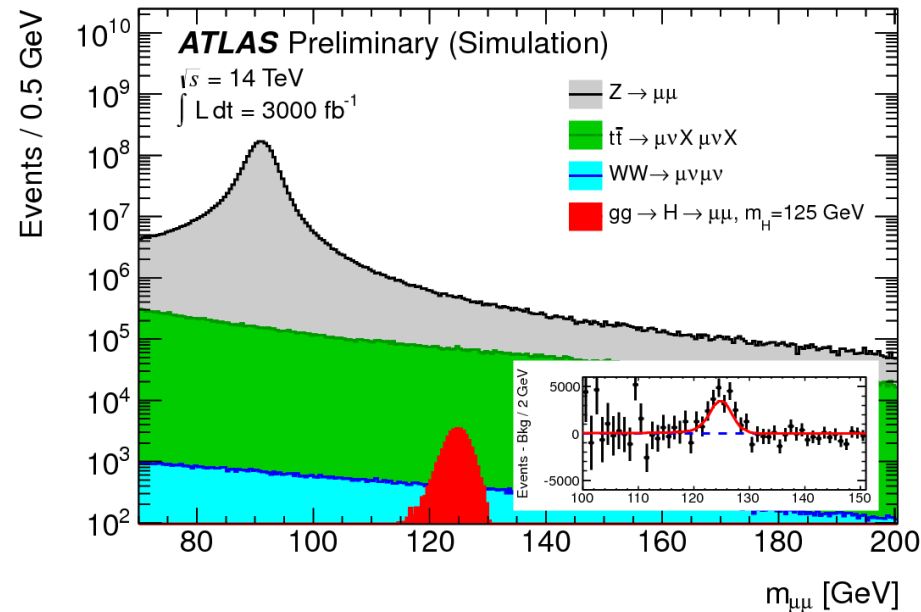

$H \rightarrow \mu\mu$

- Gives direct access to Higgs couplings to fermions of the second generation.
- Today's sensitivity: 8xSM cross-section
- With 3000 fb⁻¹ expect 17000 signal events (but: $S/B \sim 0.3\%$) and $\sim 7\sigma$ significance
- Higgs-muon coupling can be measured to about 10%

Higgs cross sections (LHC HXS WG)

Process	$\sqrt{s} = 14$ TeV	$\sqrt{s} = 33$ TeV	$\sqrt{s} = 40$ TeV	$\sqrt{s} = 60$ TeV	$\sqrt{s} = 80$ TeV	$\sqrt{s} = 100$ TeV
ggF^a	50.35 pb	178.3 pb (3.5)	231.9 pb (4.6)	394.4 pb (7.8)	565.1 pb (11.2)	740.3 pb (14.7)
VBF^b	4.40 pb	16.5 pb (3.8)	23.1 pb (5.2)	40.8 pb (9.3)	60.0 pb (13.6)	82.0 pb (18.6)
WH^c	1.63 pb	4.71 pb (2.9)	5.88 pb (3.6)	9.23 pb (5.7)	12.60 pb (7.7)	15.90 pb (9.7)
ZH^c	0.904 pb	2.97 pb (3.3)	3.78 pb (4.2)	6.19 pb (6.8)	8.71 pb (9.6)	11.26 pb (12.5)
ttH^d	0.623 pb	4.56 pb (7.3)	6.79 pb (11)	15.0 pb (24)	25.5 pb (41)	37.9 pb (61)
$gg \rightarrow HH^e(\lambda=1)$	33.8 fb	207 fb (6.1)	298 fb (8.8)	609 fb (18)	980 fb (29)	1.42 pb (42)

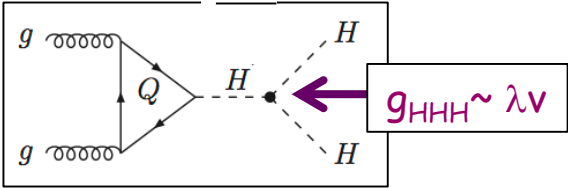

Higgs self-couplings difficult to measure at any facility (energy is mainly needed ..)

	HL-LHC	ILC500	ILC500-up	ILC1000	ILC1000-up	CLIC1400	CLIC3000	HE-LHC	VLHC
\sqrt{s} (GeV)	14000	500	500	500/1000	500/1000	1400	3000	33,000	100,000
$\int \mathcal{L} dt$ (fb ⁻¹)	3000	500	1600 [‡]	500/1000	1600/2500 [‡]	1500	+2000	3000	3000
λ		83%	46%	21%	13%	21%	10%	20%	8%

HL-LHC studies not completed yet ... ~30% precision expected, but need 3000 fb⁻¹

Vector boson scattering $W^\pm W^\pm \rightarrow W^\pm W^\pm$

At high energies, $WW \rightarrow WW$ and $ZZ \rightarrow ZZ$ processes test if the Higgs fully explains electroweak symmetry-breaking: vector boson scattering (VBS) processes

Sensitive to anomalous four-gauge boson interactions (quartic gauge coupling, QGC)

Search for $W^\pm W^\pm jj$ production in dilepton+2 jet final states, $m(jj) > 500$ GeV

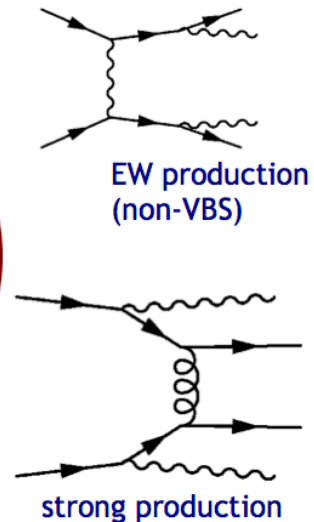
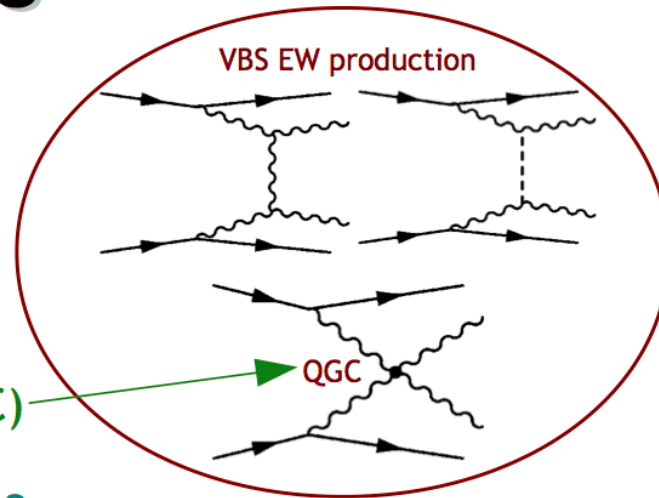

$$\mathcal{L} = \mathcal{L}_{SM} + \sum_i \left[\frac{a_i}{\Lambda} \mathcal{O}_i^{(5)} + \frac{c_i}{\Lambda^2} \mathcal{O}_i^{(6)} + \frac{e_i}{\Lambda^4} \mathcal{O}_i^{(8)} \dots \right]$$

Observation of **anomalous quartic gauge coupling** would indicate **new physics in the electroweak symmetry breaking sector!**

- HL-LHC enhances discovery range for new higher-dimension electroweak operators by more than a factor of two

Parameter	dimension	channel	Λ_{UV} [TeV]	300 fb ⁻¹		3000 fb ⁻¹	
				5 σ	95% CL	5 σ	95% CL
$c_{\phi W}/\Lambda^2$	6	ZZ	1.9	34 TeV ⁻²	20 TeV ⁻²	16 TeV ⁻²	9.3 TeV ⁻²
f_{S0}/Λ^4	8	W [±] W [±]	2.0	10 TeV ⁻⁴	6.8 TeV ⁻⁴	4.5 TeV ⁻⁴	0.8 TeV ⁻⁴
f_{T1}/Λ^4	8	WZ	3.7	1.3 TeV ⁻⁴	0.7 TeV ⁻⁴	0.6 TeV ⁻⁴	0.3 TeV ⁻⁴
f_{T8}/Λ^4	8	Z $\gamma\gamma$	12	0.9 TeV ⁻⁴	0.5 TeV ⁻⁴	0.4 TeV ⁻⁴	0.2 TeV ⁻⁴
f_{T9}/Λ^4	8	Z $\gamma\gamma$	13	2.0 TeV ⁻⁴	0.9 TeV ⁻⁴	0.7 TeV ⁻⁴	0.3 TeV ⁻⁴



Λ_{UV} : unitarity violation bound corresponding to the sensitivity with 3000 fb⁻¹

SM discovery expected with 185 fb⁻¹

BSM contribution at TeV Scale might be observed at 300 fb⁻¹!
If BSM discovered in 300 fb⁻¹ dataset, then the coefficients on the new operators could be measured to 5% precision with 3000 fb⁻¹

The problem of the stability of the Higgs mass a.k.a "naturalness"

As any other particle (e^\pm , ...) in quantum mechanics Higgs mass receives radiative corrections

$$M_H^2 = M_{\text{bare}}^2 + \left(\text{Higgs loop} \right) + \left(\text{top loop} \right) + \left(\text{W/Z loop} \right)$$

Mostly small, except top contribution: $\sim m_t^2 \Lambda^2$
 $\Lambda^2 =$ energy scale up to which the SM is valid
 (or, equivalently, new physics sets in)

2 solutions

1) "Naturalness": Higgs mass stabilized by new physics that cancel the divergences.
 E.g. SUSY: the contribution of the supersymmetric partner of the top (stop) gives rise to the same contribution with opposite sign \rightarrow cancellation

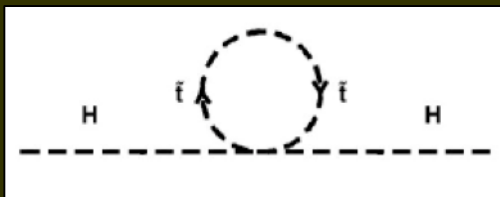
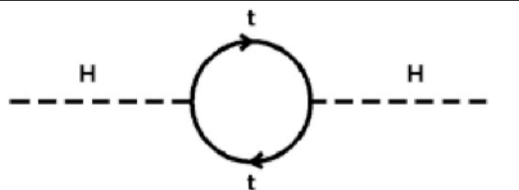

BUT: cancellation only works if stop mass not much larger than top mass \rightarrow this is one of most compelling motivations for SUSY (or new physics) at TeV scale

2) "Fine tuning": the bare mass cancels the radiative corrections \rightarrow this becomes more and more "acrobatic" the higher the scale Λ up to which SM is valid (w/o new physics)

E.g. $\Lambda = 10 \text{ TeV} \rightarrow M^2(\text{rad. corr}) = 8265625 \text{ GeV}^2 \rightarrow$ need fine-tuned $M_{\text{bare}}^2 = 8281250 \text{ GeV}^2$
 to get $M_H^2 = (125 \text{ GeV})^2 = 15262 \text{ GeV}^2$

$\Lambda = 10^{19} \text{ GeV} \rightarrow$ need fine tuning of M_{bare} to the 33rd digit !! \rightarrow UNNATURAL

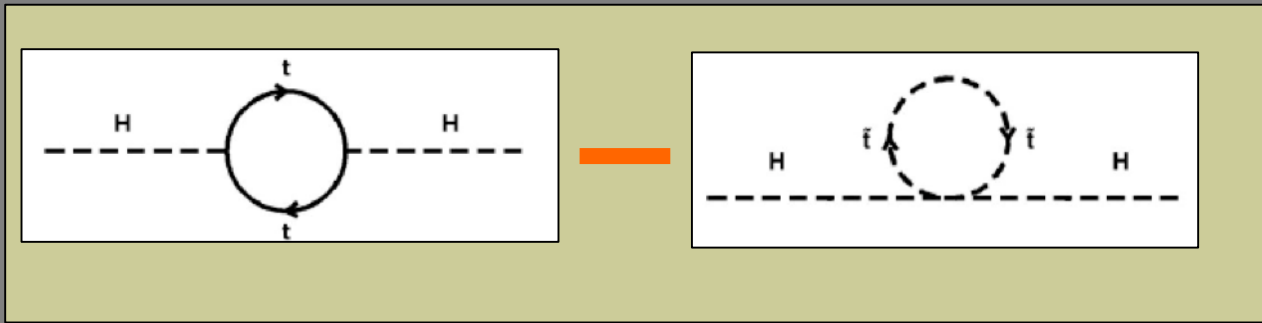

To stabilize the Higgs mass (without too much fine-tuning), the stop should not be much heavier than $\sim 1-1.5$ TeV (note: the rest of the SUSY spectrum can be heavier)

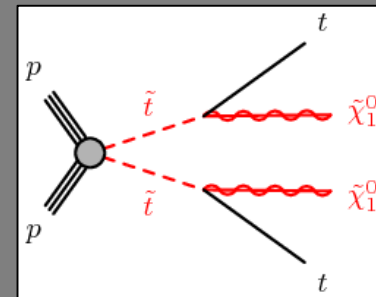
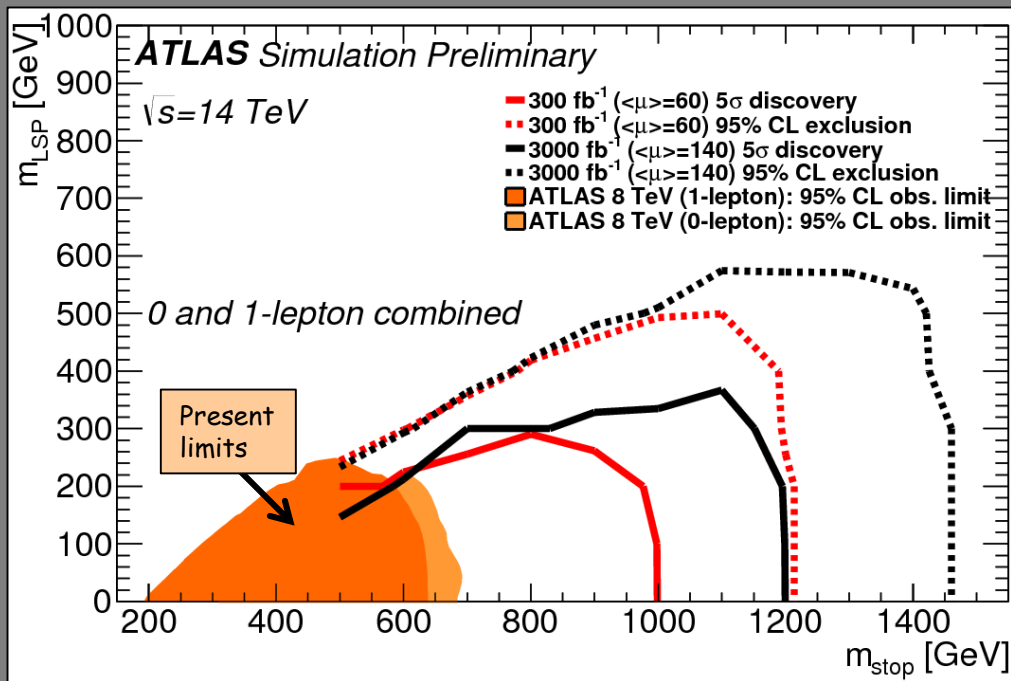

Mass reach extends by ~ 200 GeV from 300 to 3000 fb⁻¹
 \rightarrow most of best motivated mass range will be covered at HL-LHC

Dark Matter Direct Detection Experiments: Limits and Future Sensitivity

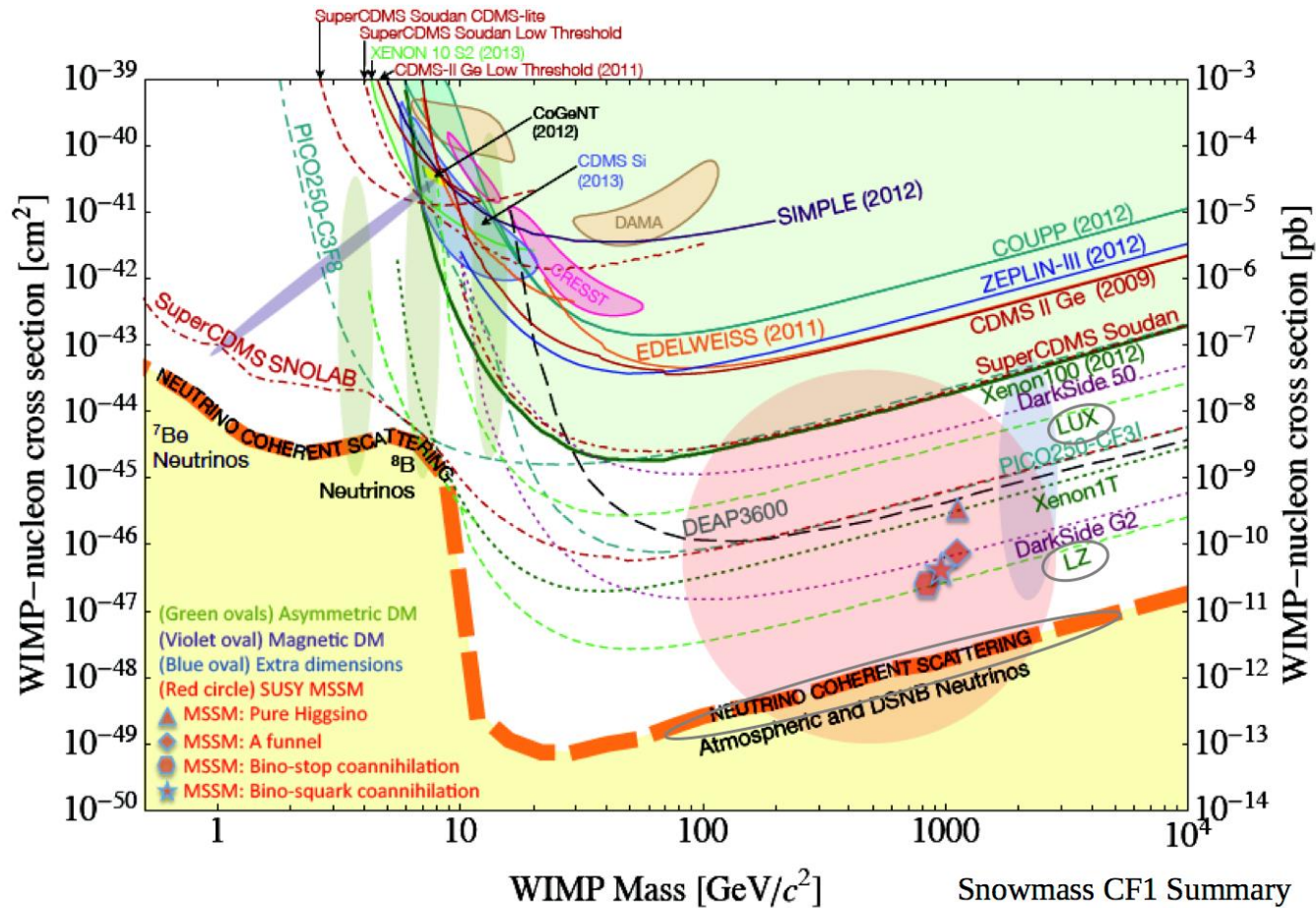

Why is the Higgs so light ?



Need new physics (close-by, \sim TeV scale) to "stabilize" the divergent Higgs mass

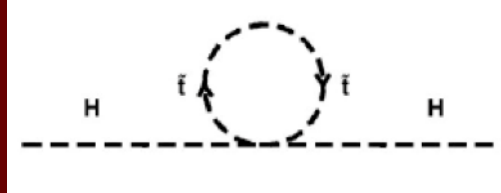
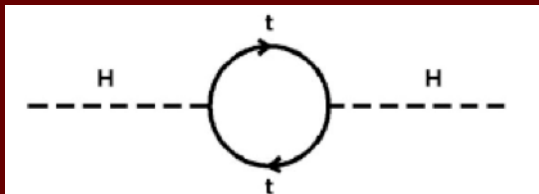

In the SM, corrections to m_H diverge as $\Delta M_H^2 \sim \Lambda^2$ ($\Lambda = E$ scale up to which SM is valid)
"Naturalness" problem

E.g. the SUSY partner of the top (stop) gives rise to same diagram with opposite sign \rightarrow cancellation
Searches for stop quarks so far unsuccessful
HL-LHC can probe up to 1.5 TeV

Dark Matter searches

Fraction of minimal SUSY parameter space that can be excluded at 95% CL by present experimental constraints and direct DM searches at pp colliders

Arbey, Battaglia, Mahmoudi

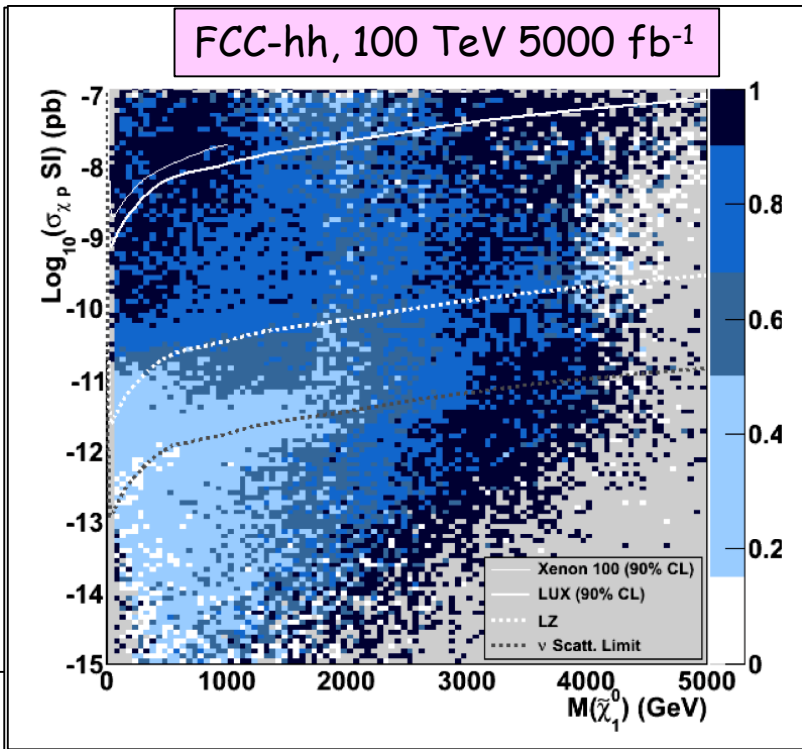

A 100 TeV pp collider would allow a definitive exploration of EWSB

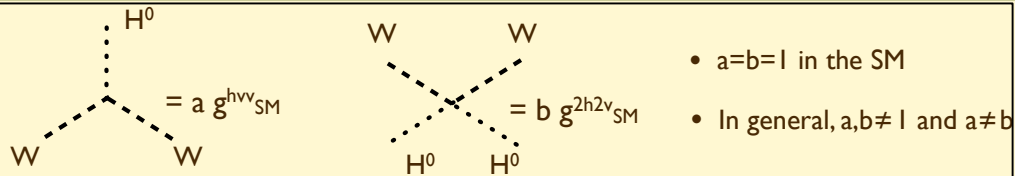

By providing direct access to EW theory in the unbroken regime ($\sqrt{s} \gg v=246 \text{ GeV}$)

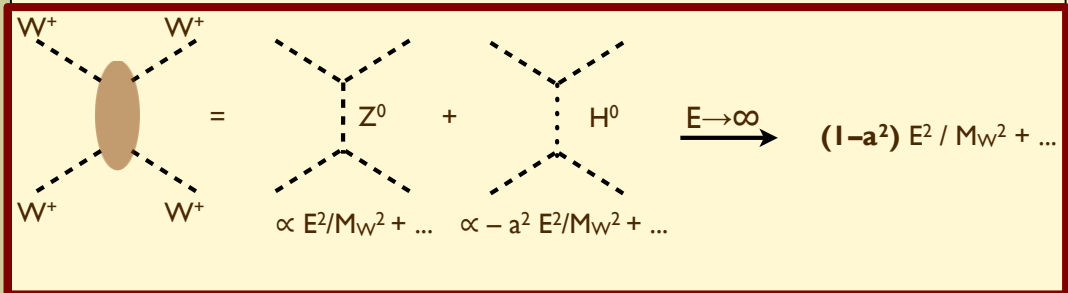

$V_L V_L$ scattering violates unitarity at $m_{VV} \sim \text{TeV}$ without Higgs exchange diagrams

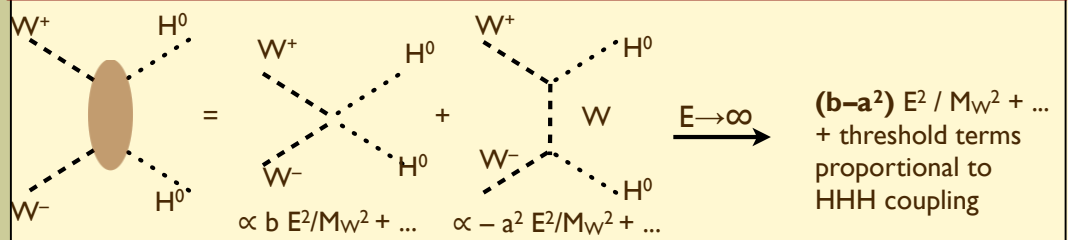

KEYWORD: ENERGY !

Important to verify that:

- ❑ H (125) regularizes the theory \rightarrow a crucial "closure test" of the SM
- ❑ Or, else: observe deviations in VV production compared to SM expectation \rightarrow anomalous quartic (VVVV) gauge couplings and/or new heavy resonances \rightarrow new physics (Note: several models predict SM-like Higgs but different physics at high E)

- ❑ ILC 1 TeV, 1 ab^{-1} : indirect sensitivity to new resonances up to $m \sim 6 \text{ TeV}$ (exploit e^\pm polarization)
- ❑ CLIC 3 TeV, 1 ab^{-1} : indirect sensitivity to composite Higgs scale $\Lambda \sim 30 \text{ TeV}$ from $VV \rightarrow hh$
- ❑ 100 TeV pp: huge cross-sections at high-mass: $\sigma \sim 100 \text{ fb}$ $m_{WW} > 3 \text{ TeV}$; $\sigma \sim 1 \text{ fb}$ $m_{HH} > 2 \text{ TeV}$ \rightarrow detailed direct studies

Evidence for EW VBS reported recently by ATLAS in $pp \rightarrow W^\pm W^\pm jj$ channel giving 2 same-sign leptons and 2 high-mass jets ($m_{jj} > 500 \text{ GeV}$)

Significance of EW VBS signal: $\sim 3.6\sigma$ for large rapidity gap between 2 jets

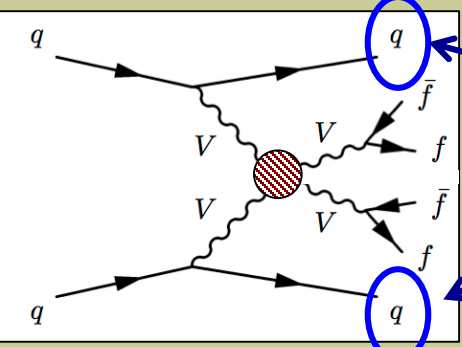

Tagging these forward quarks (jets) is crucial signature to distinguish EW VBS from the background

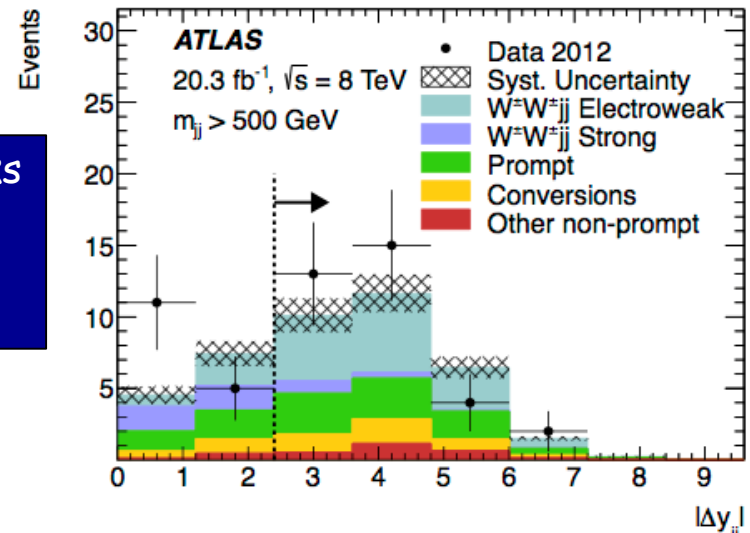

- ❑ HL-LHC: measure SM EW cross-section to 10%; x2 higher sensitivity to anomalous couplings than LHC@300 fb⁻¹, ~5% precision on parameters if new physics observed at LHC@300 fb⁻¹
 - ❑ ILC 1 TeV, 1 ab⁻¹: indirect sensitivity to new resonances up to $m \sim 6 \text{ TeV}$ (exploit e^\pm polarization)
 - ❑ CLIC 3 TeV, 1 ab⁻¹: indirect sensitivity to composite Higgs scale $\Lambda \sim 30 \text{ TeV}$ from $VV \rightarrow hh$
 - ❑ 100 TeV pp: huge cross-sections at high-mass: $\sigma \sim 100 \text{ fb}$ $m_{WW} > 3 \text{ TeV}$; $\sigma \sim 1 \text{ fb}$ $m_{HH} > 2 \text{ TeV}$
- detailed direct studies

Maximum jet rapidity vs \sqrt{s}
 → calorimeter coverage over $|\eta| \geq 6$ needed at 100 TeV pp collider (ATLAS, CMS: $|\eta| < 5$)
 → challenging: pile-up, radiation, ... !!

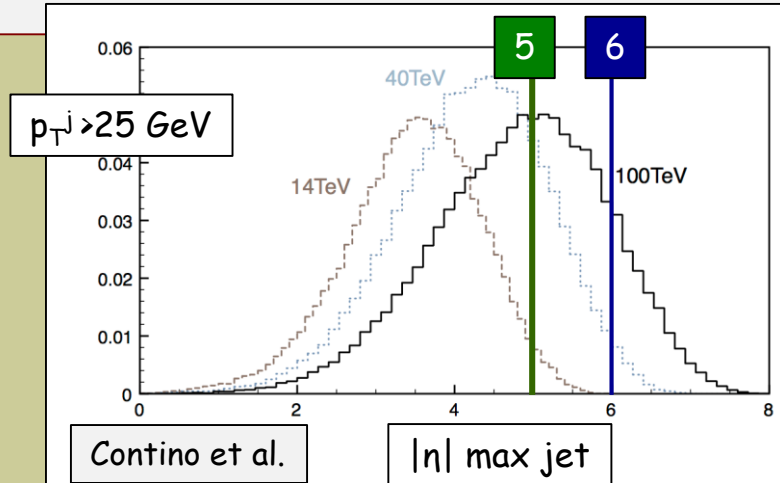

Contino et al.

$|\eta|_{\text{max jet}}$