

# Rare B Decays: Theory and Experiment

Barcelona 18-20 April 2016



## Inclusive Semileptonic Penguin Decays Subleading power factorisation

Tobias Hurth

Johannes Gutenberg-University Mainz



# Prologue

# Self-consistency of the SM

Do we need new physics beyond the SM ?

- It is possible to extend the validity of the SM up to the  $M_P$  as weakly coupled theory.

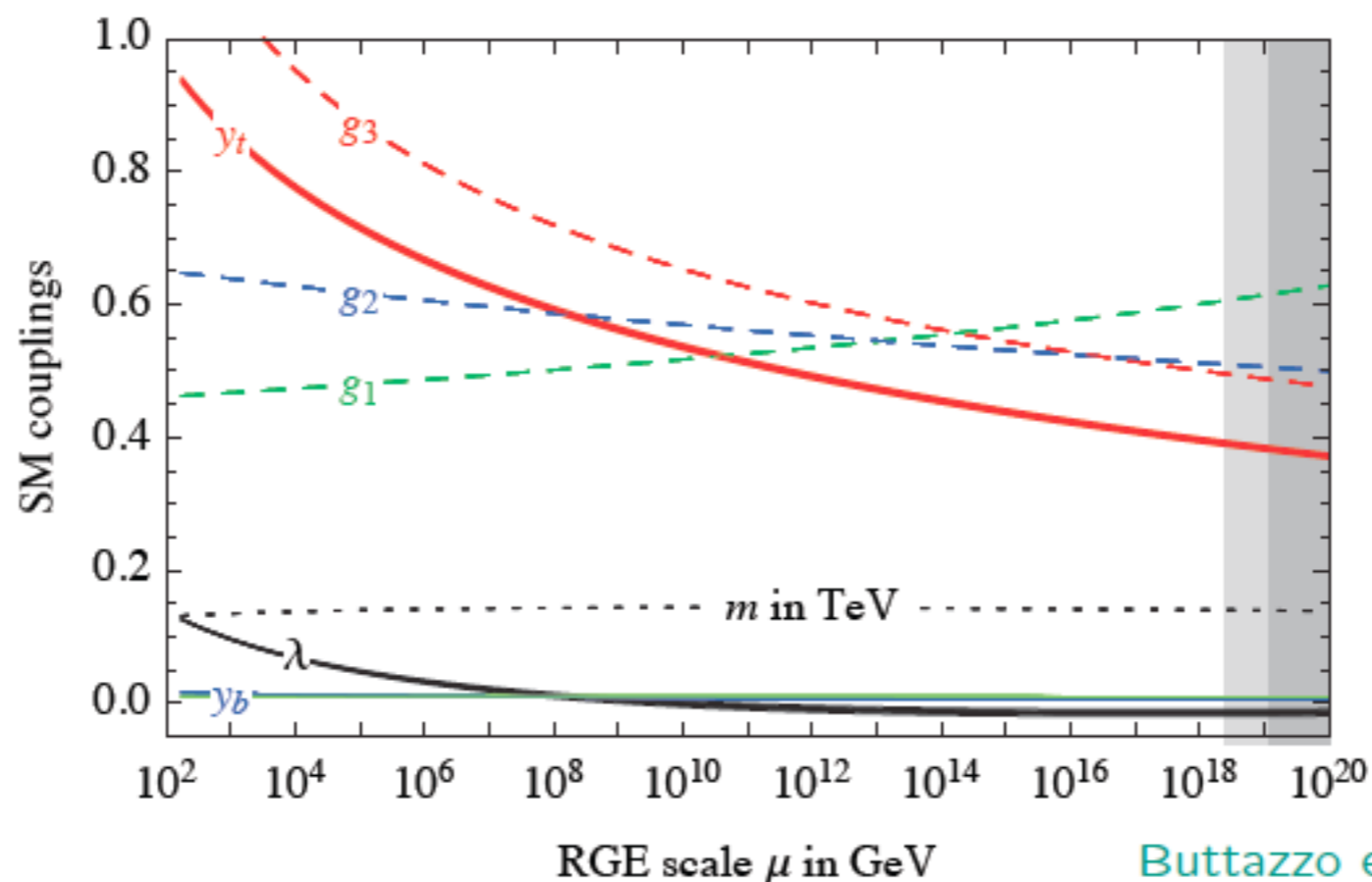

High-energy extrapolation shows that the Yukawa couplings, weak gauge couplings and the Higgs self coupling remain perturbative in the entire energy domain between the electroweak and Planck scale (no Landau poles!).

- Renormalizability implies no constraints on the free parameters of the SM Lagrangian.

# Experimental evidence beyond SM

- **Dark matter** (visible matter accounts for only 4% of the Universe)
- **Neutrino masses** (Dirac or Majorana masses ?)
- **Baryon asymmetry of the Universe** (new sources of CP violation needed)

## **Caveat:**

Answers perhaps wait at energy scales which we do not reach with present experiments.

# Inclusive Semileptonic Penguin Decays

Based on

Huber, Hurth, Lunghi arXiv:1503.0449

Inclusive  $B \rightarrow X_s \ell^+ \ell^-$ : Complete angular analysis and a thorough study of collinear photons

Benzke, Fickinger, Hurth, Turczyk to appear

Subleading power factorization in  $B \rightarrow X_s \ell^+ \ell^-$

Hurth, Mahmoudi, Neshatpour arXiv:1603.00865

On the anomalies in the latest LHCb data

# Motivation

- Radiative and semileptonic rare B decayse are highly sensitive probes for new physics
- Exclusive modes are experimentally easier (LHCb), but have larger theoretical uncertainties (issue of unknown power corrections !)
- Inclusive modes require Belle-II for full exploitation (complete angular analysis) but are theoretically very clean
- Inclusive modes allow for crosschecks of recent LHCb anomalies

# Theoretical tools for flavour precision observables

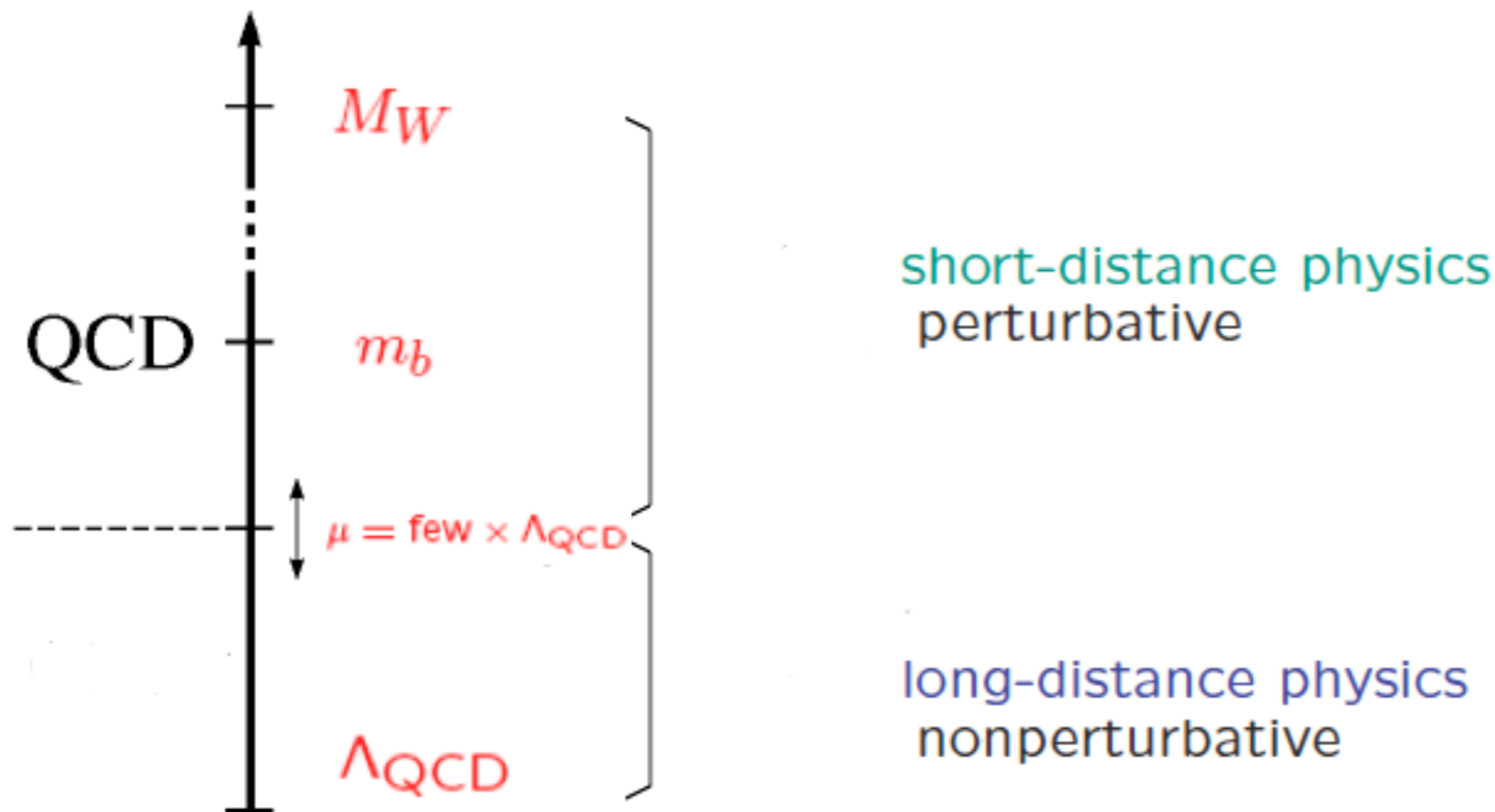

## Factorization theorems: separating long- and short-distance physics

- Electroweak effective Hamiltonian:  $H_{eff} = -\frac{4G_F}{\sqrt{2}} \sum C_i(\mu, M_{heavy}) \mathcal{O}_i(\mu)$
- $\mu^2 \approx M_{New}^2 \gg M_W^2$ : 'new physics' effects:  $C_i^{SM}(M_W) + C_i^{New}(M_W)$

How to compute the hadronic matrix elements  $\mathcal{O}_i(\mu = m_b)$  ?

# Inclusive modes $B \rightarrow X_s \gamma$ and $B \rightarrow X_s \ell^+ \ell^-$

How to compute the hadronic matrix elements  $\mathcal{O}_i(\mu = m_b)$  ?

Heavy mass expansion for inclusive modes:

$$\Gamma(\bar{B} \rightarrow X_s \gamma) \xrightarrow{m_b \rightarrow \infty} \Gamma(b \rightarrow X_s^{\text{parton}} \gamma), \quad \Delta^{\text{nonpert.}} \sim \Lambda_{QCD}^2 / m_b^2$$

No linear term  $\Lambda_{QCD} / m_b$  (perturbative contributions dominant)

Chay, Georgi, Grinstein 1990

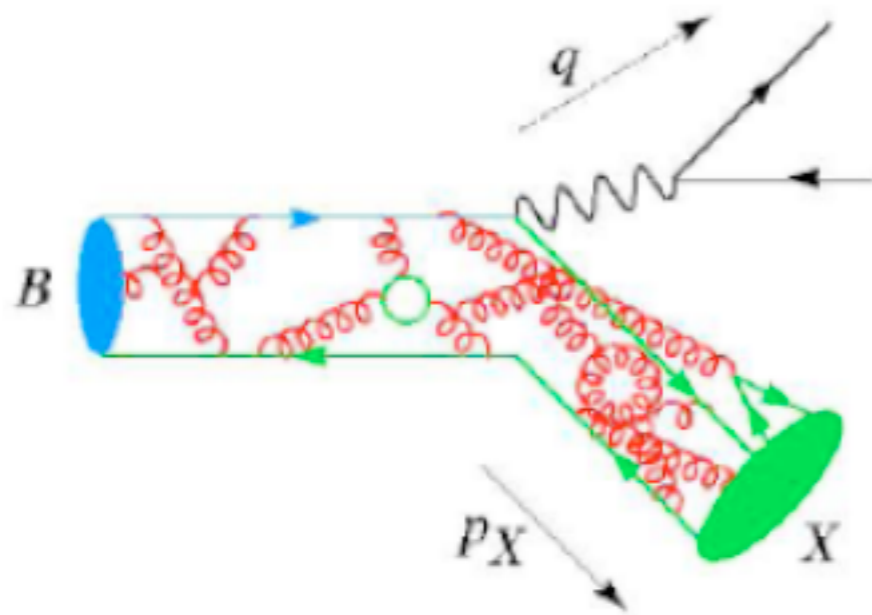



## Inclusive modes $B \rightarrow X_s \gamma$ and $B \rightarrow X_s l^+ l^-$

How to compute the hadronic matrix elements  $\mathcal{O}_i(\mu = m_b)$  ?

Heavy mass expansion for inclusive modes:

$$\Gamma(\bar{B} \rightarrow X_s \gamma) \xrightarrow{m_b \rightarrow \infty} \Gamma(b \rightarrow X_s^{\text{parton}} \gamma), \quad \Delta^{\text{nonpert.}} \sim \Lambda_{QCD}^2 / m_b^2$$

No linear term  $\Lambda_{QCD}/m_b$  (perturbative contributions dominant)

### An old story:

- If one goes beyond the leading operator ( $\mathcal{O}_7, \mathcal{O}_9$ ):  
breakdown of local expansion

### A new dedicated analysis:

naive estimate of non-local matrix elements leads to 5% uncertainty.

[Benzke, Lee, Neubert, Paz, arXiv:1003.5012](#)



Analysis in  $B \rightarrow X_s l l$  in this talk; [Benzke, Fickinger, Hurth, Turczyk](#)

## Exclusive modes $B \rightarrow K^{(*)} \ell \bar{\ell}$

QCD-improved factorization: BBNS 1999

$$\mathcal{T}_a^{(i)} = C_a^{(i)} \xi_a + \phi_B \otimes T_a^{(i)} \otimes \phi_{a,K^*} + O(\Lambda/m_b)$$

- Separation of **perturbative hard kernels** from **process-independent nonperturbative** functions like form factors
- **Relations between formfactors** in large-energy limit
- **Limitation: insufficient information on power-suppressed  $\Lambda/m_b$  terms** (breakdown of factorization: 'endpoint divergences')

.....

## Difference between exclusive and inclusive $b \rightarrow s\gamma, \ell\ell$ modes:

### Inclusive

$\Lambda^2/m_b^2$  corrections can be calculated for the leading operators in the local OPE .

$\Lambda/m_b$  corrections to the subleading operators correspond to nonlocal matrix elements and can be estimated !

### Exclusive

No theory of  $\Lambda/m_b$  corrections at all within QCD factorization formula (in the low- $q^2$  region); these corrections can only be "guesstimated" !

## Significance of the LHCb anomalies depend on the assumptions on the power corrections

Ciuchini et al. (arXiv:1512.07157): Fit produces 20-50% nonfact. power corrections on the observable level in the critical bins.

Hurth et al. (arXiv:1603.00865): Assumption of 60% nonfact. power corrections on the amplitude level lead to 17-20 % on the observable level ( $S_3, S_4, S_5$ ) only.

# Previous predictions versus LHCb Monte Carlo ( $10 \text{ fb}^{-1}$ )

Egede, Hurth, Matias, Ramon, Reece, arXiv:0807.2589, arXiv:1005.0571

– unknown  $\Lambda/m_b$  power corrections

$$A_{\perp,\parallel,0} = A_{\perp,\parallel,0}^0 (1 + c_{\perp,\parallel,0}) \text{ vary } c_i \text{ in a range of } \pm 10\% \text{ and also of } \pm 5\%$$

Guesstimate

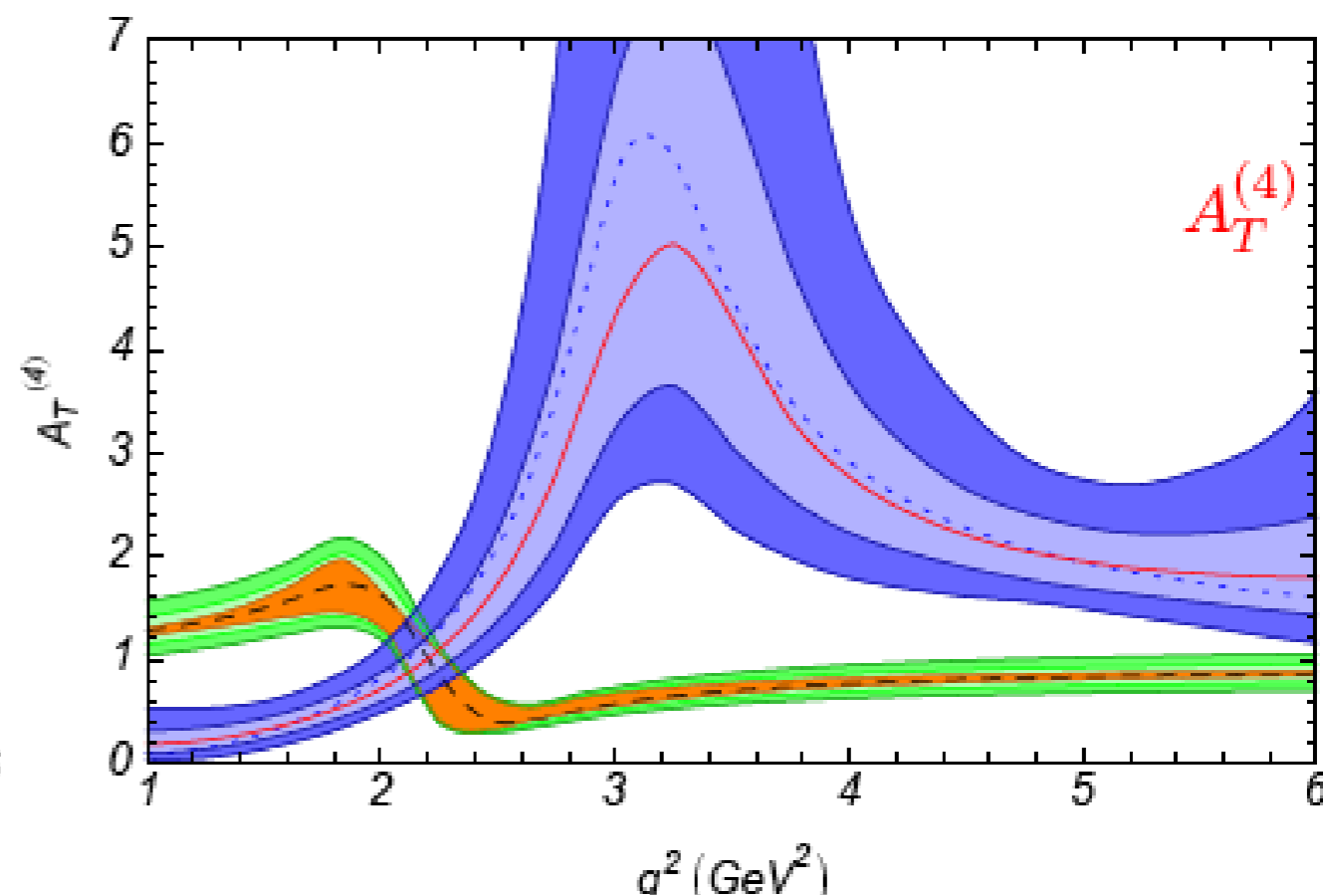
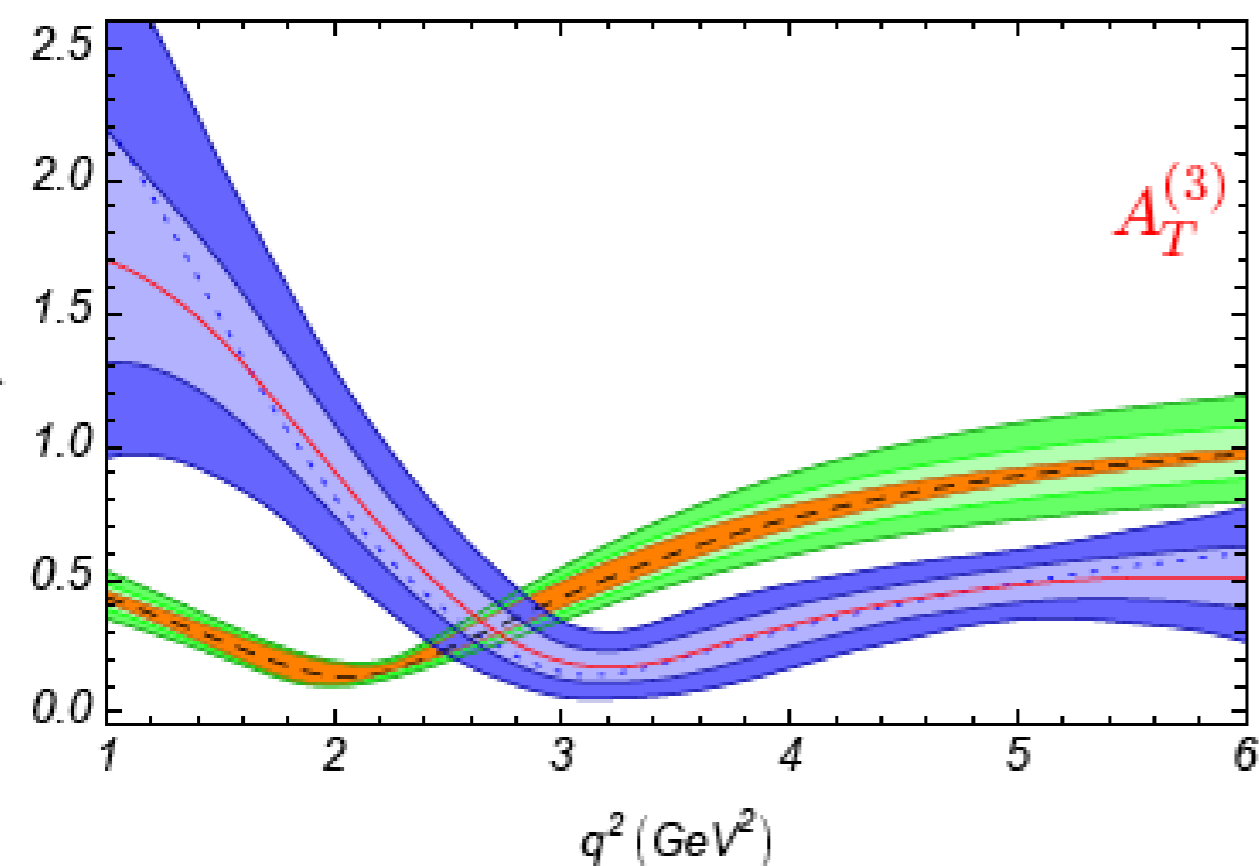

The experimental errors assuming SUSY scenario (b) with large-gluino mass and positive mass insertion, is compared to the theoretical errors assuming the SM.

# Previous predictions versus LHCb Monte Carlo ( $10 \text{ fb}^{-1}$ )

Egede, Hurth, Matias, Ramon, Reece, arXiv:0807.2589, arXiv:1005.0571

– unknown  $\Lambda/m_b$  power corrections

$$A_{\perp,\parallel,0} = A_{\perp,\parallel,0}^0 (1 + c_{\perp,\parallel,0}) \text{ vary } c_i \text{ in a range of } \pm 10\% \text{ and also of } \pm 5\%$$

Guesstimate

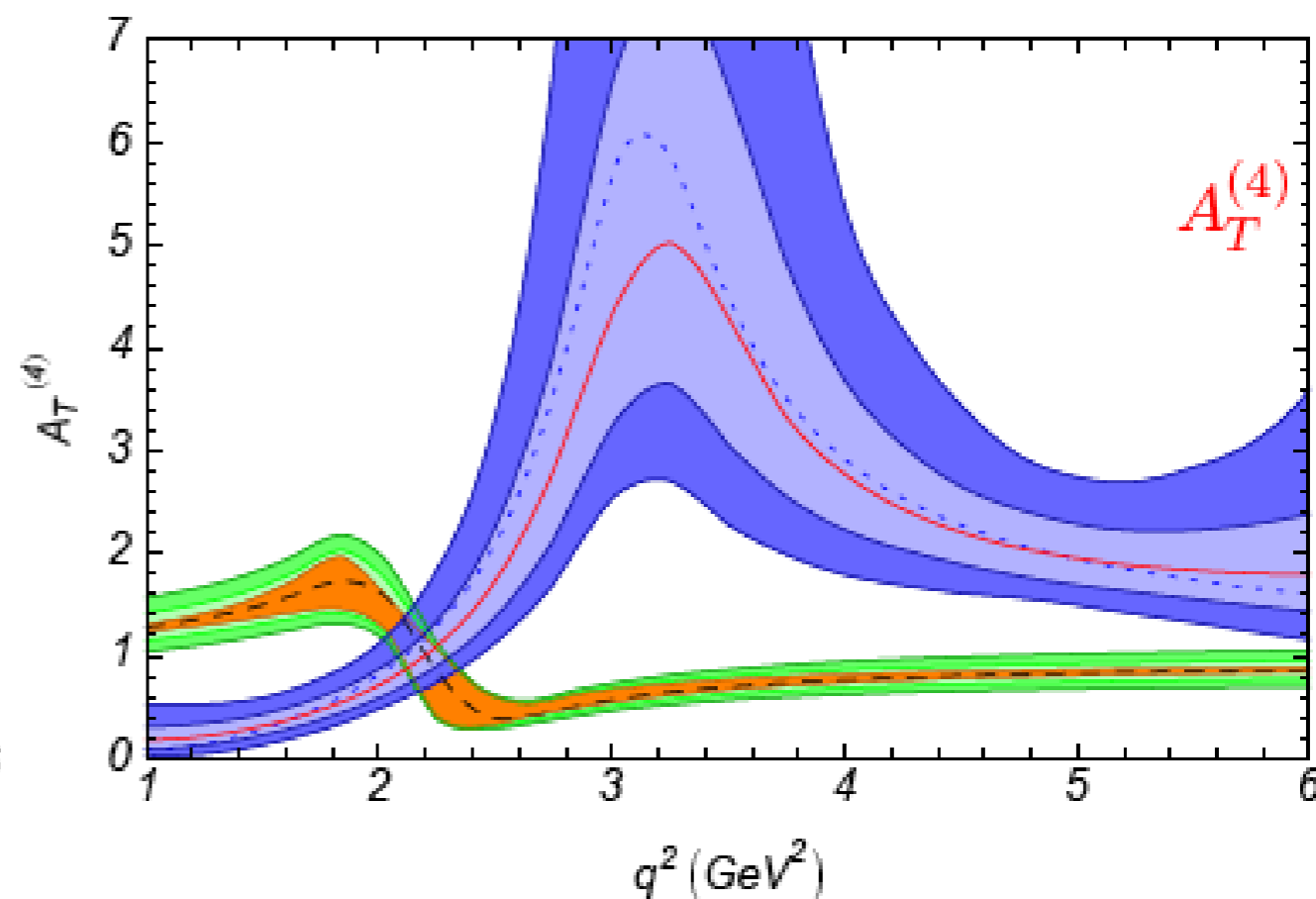
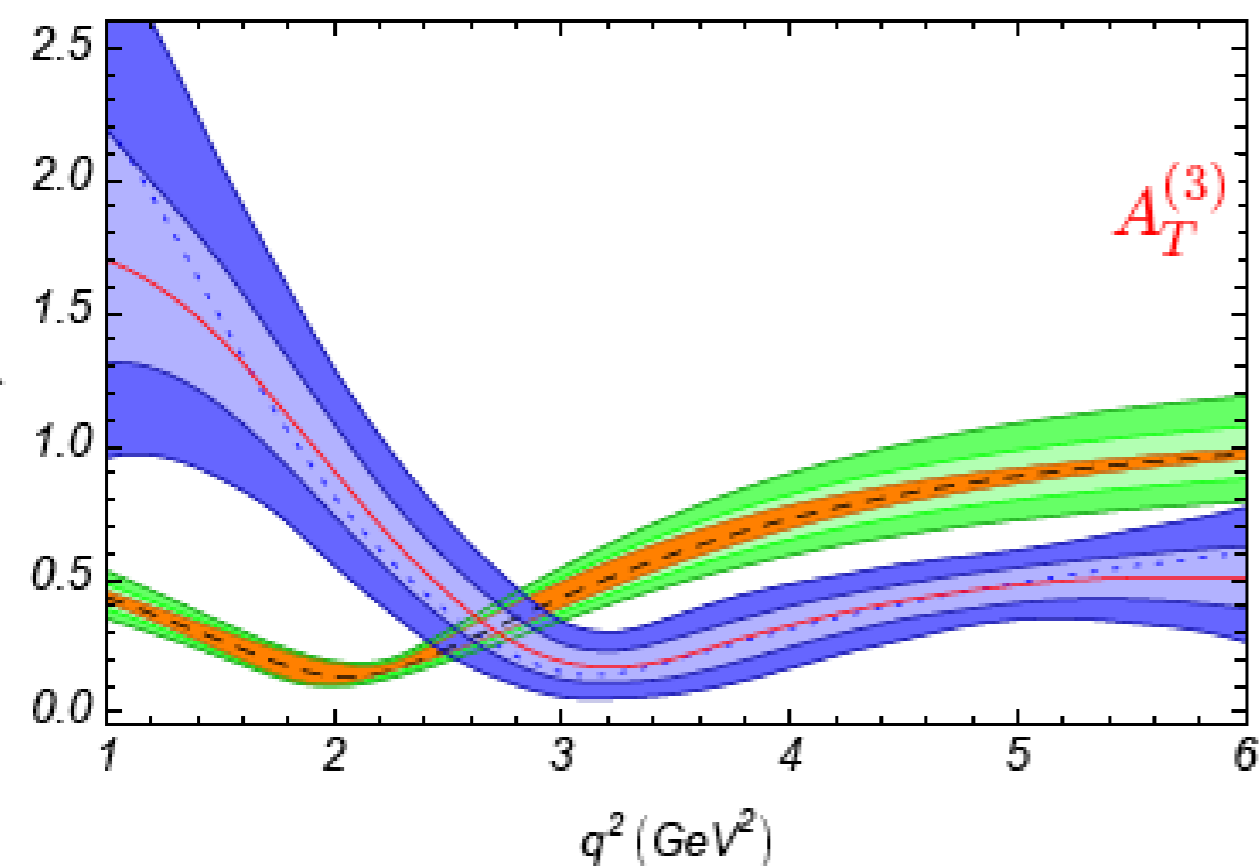

This was the dream in 2008

# Calculations beyond guessing numbers

Any reasonable calculation is better than a fit!

Methods offered in the analysis of  $B \rightarrow K\ell^+\ell^-$  to calculate power corrections [Kjodjamirian et al. arXiv: 1211.0234](#), also [1006.4945](#)

Crosschecking errors and correlations of formfactor calculation in [Zwicky et al. arXiv: 1503.0553](#) by independent LCSR analysis

# Crosscheck of LHCb anomalies with various ratios $R(e/\mu)$

Hurth, Mahmoudi, Neshatpour arXiv:1603.00865

Altmannshofer, Straub arXiv:1503.06199

$R_K$  is theoretically rather clean compared to LHCb anomalies and its tension with the SM cannot be explained by power corrections. But both tensions might be healed by new physics in  $C_9^\mu$

Observable	95% C.L. prediction
$\text{BR}(B \rightarrow X_s \mu^+ \mu^-) / \text{BR}(B \rightarrow X_s e^+ e^-)_{q^2 \in [1,6](\text{GeV})^2}$	[0.61, 0.93]
$\text{BR}(B \rightarrow X_s \mu^+ \mu^-) / \text{BR}(B \rightarrow X_s e^+ e^-)_{q^2 > 14.2(\text{GeV})^2}$	[0.68, 1.13]
$\text{BR}(B^0 \rightarrow K^{*0} \mu^+ \mu^-) / \text{BR}(B^0 \rightarrow K^{*0} e^+ e^-)_{q^2 \in [1,6](\text{GeV})^2}$	[0.65, 0.96]
$\langle F_L(B^0 \rightarrow K^{*0} \mu^+ \mu^-) \rangle / \langle F_L(B^0 \rightarrow K^{*0} e^+ e^-) \rangle_{q^2 \in [1,6](\text{GeV})^2}$	[0.85, 0.96]
$\langle A_{FB}(B^0 \rightarrow K^{*0} \mu^+ \mu^-) \rangle / \langle A_{FB}(B^0 \rightarrow K^{*0} e^+ e^-) \rangle_{q^2 \in [4,6](\text{GeV})^2}$	[-0.21, 0.71]
$\langle S_5(B^0 \rightarrow K^{*0} \mu^+ \mu^-) \rangle / \langle S_5(B^0 \rightarrow K^{*0} e^+ e^-) \rangle_{q^2 \in [4,6](\text{GeV})^2}$	[0.53, 0.92]
$\text{BR}(B^0 \rightarrow K^{*0} \mu^+ \mu^-) / \text{BR}(B^0 \rightarrow K^{*0} e^+ e^-)_{q^2 \in [15,19](\text{GeV})^2}$	[0.58, 0.95]
$\langle F_L(B^0 \rightarrow K^{*0} \mu^+ \mu^-) \rangle / \langle F_L(B^0 \rightarrow K^{*0} e^+ e^-) \rangle_{q^2 \in [15,19](\text{GeV})^2}$	[0.998, 0.999]
$\langle A_{FB}(B^0 \rightarrow K^{*0} \mu^+ \mu^-) \rangle / \langle A_{FB}(B^0 \rightarrow K^{*0} e^+ e^-) \rangle_{q^2 \in [15,19](\text{GeV})^2}$	[0.87, 1.01]
$\langle S_5(B^0 \rightarrow K^{*0} \mu^+ \mu^-) \rangle / \langle S_5(B^0 \rightarrow K^{*0} e^+ e^-) \rangle_{q^2 \in [15,19](\text{GeV})^2}$	[0.87, 1.01]
$\text{BR}(B^+ \rightarrow K^+ \mu^+ \mu^-) / \text{BR}(B^+ \rightarrow K^+ e^+ e^-)_{q^2 \in [1,6](\text{GeV})^2}$	[0.58, 0.95]
$\text{BR}(B^+ \rightarrow K^+ \mu^+ \mu^-) / \text{BR}(B^+ \rightarrow K^+ e^+ e^-)_{q^2 \in [15,22](\text{GeV})^2}$	[0.58, 0.95]

Table 3: Predicted ratios of observables with muons in the final state to electrons in the final state, considering the two operator fit within the  $\{C_9^\mu, C_9^e\}$  set.



# Crosscheck of LHCb anomalies with inclusive modes

Hurth, Mahmoudi, Neshatpour, arXiv:1410.4545

if SM deviations in  $R_K$  and  $P'_5$  persist until Belle-II

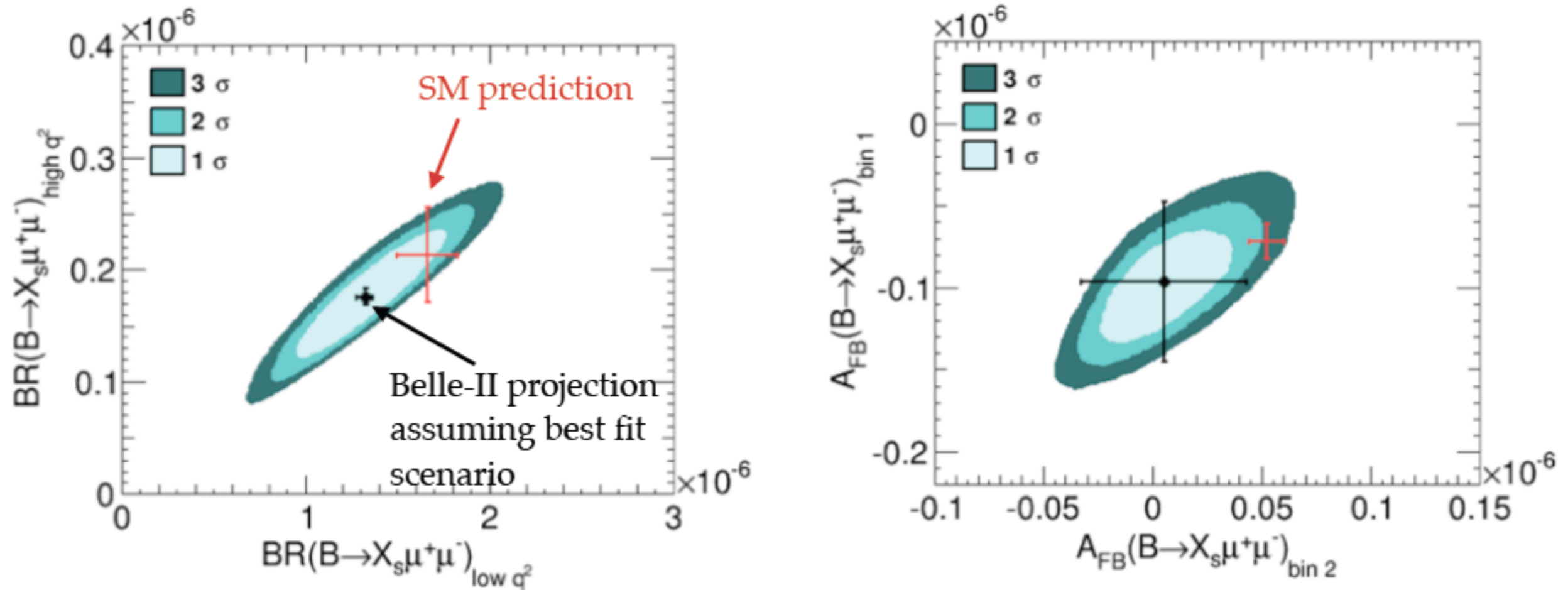

If NP then the effect of  $C_9$  and  $C'_9$  are large enough to be checked at Belle-II with theoretically clean modes.

# New physics sensitivity

Huber, Hurth, Lunghi, arXiv:1503.04849

Constraints on Wilson coefficients  $C_9/C_9^{\text{SM}}$  and  $C_{10}/C_{10}^{\text{SM}}$

$$R_i = \frac{C_i(\mu_0)}{C_i^{\text{SM}}(\mu_0)}$$

that we obtain at 95% C.L. from present experimental data  
(red low  $q^2$ , green high  $q^2$ )

that we will obtain at 95% C.L. from  $50ab^{-1}$  data at Belle-II  
(yellow)

$B \rightarrow X_s e e$

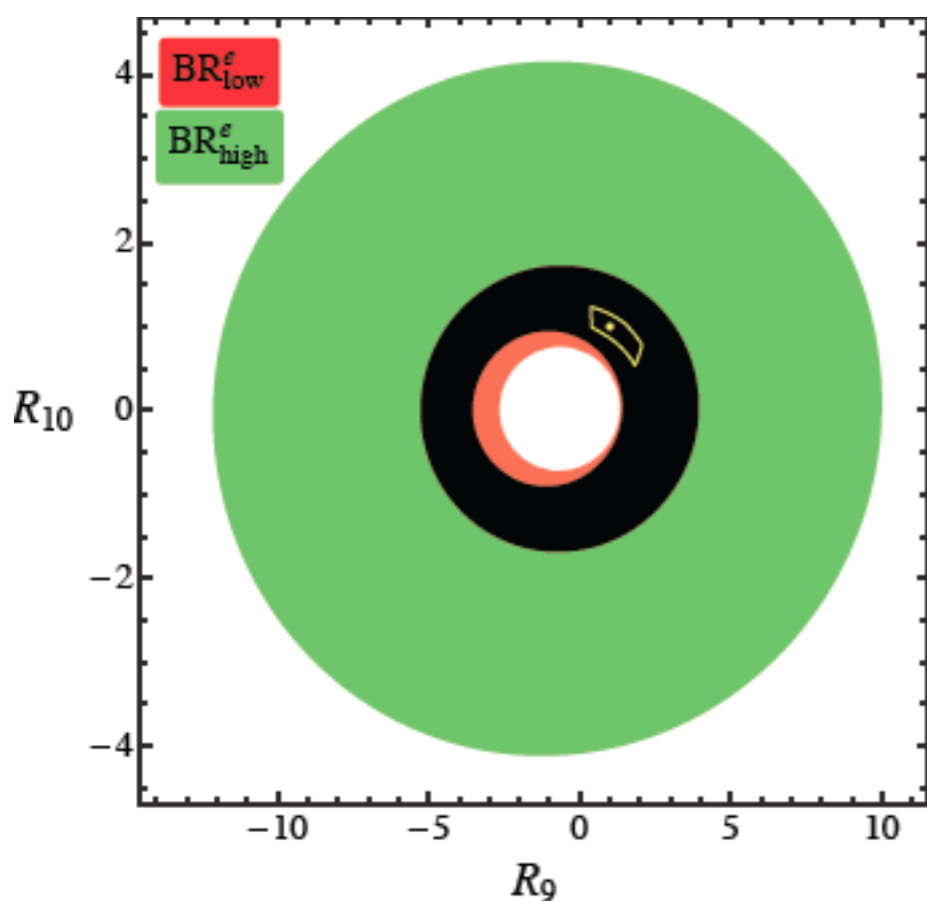

$B \rightarrow X_s \mu \mu$

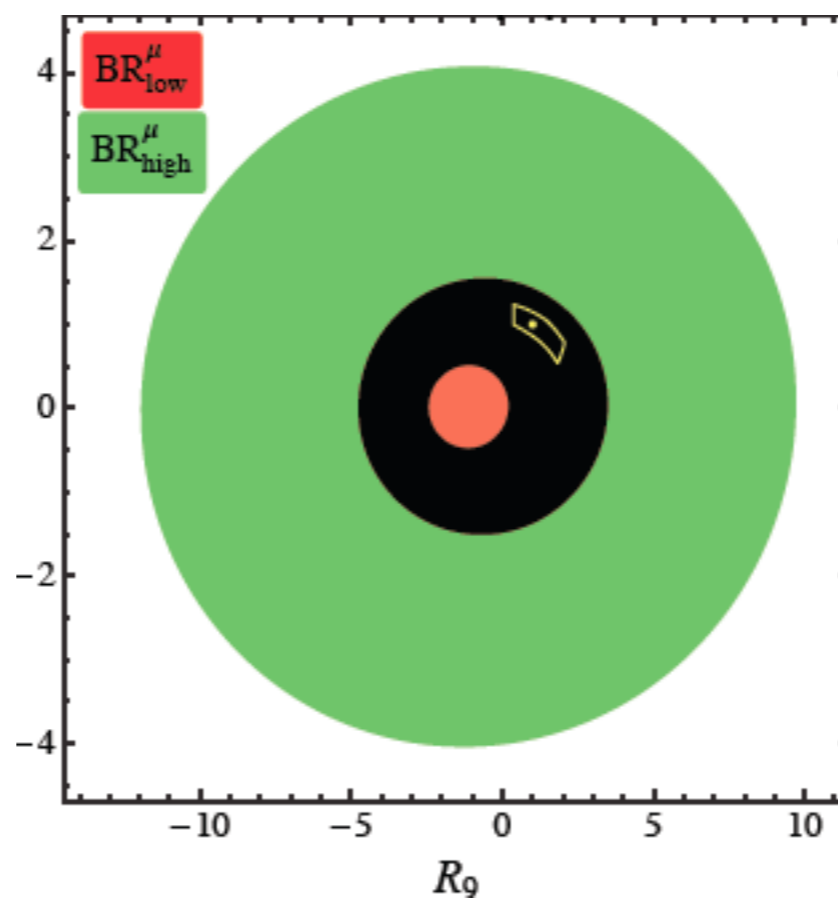

$B \rightarrow X_s l l$

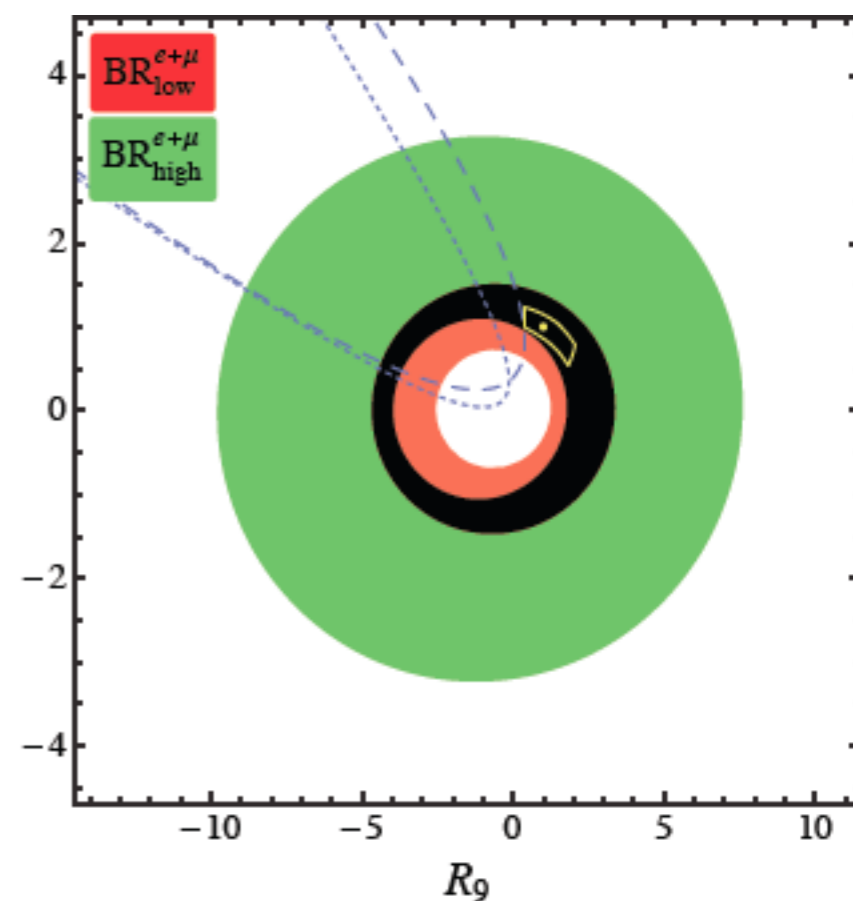

# Complete angular analysis of inclusive $B \rightarrow X_s ll$

Huber, Hurth, Lunghi, arXiv:1503.04849

- "Latest" Belle measurement of branching ratio is based on less than 30% of the total luminosity

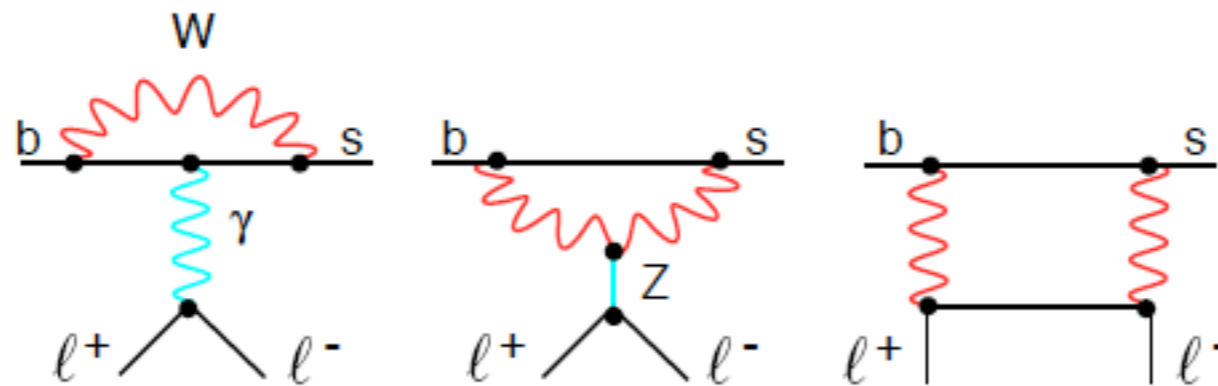

- Phenomenological analysis to NNLO QCD and NLO QED for all angular observables
- Electromagnetic effects due to energetic photons are large and calculated analytically and crosschecked against Monte Carlo generator events

Size of logs depend on experimental set-up

We assume no photons are included in the definition of  $q^2$  (di-muon channel at Babar/Belle, di-electron at Belle)

Babar's di-electron channel: Photons that are emitted in a cone of 35 mrad angular opening are included in  $q^2$

Monte Carlo techniques needed to estimate this effect !

# Complete angular analysis of inclusive $B \rightarrow X_s \ell \ell$

Huber, Hurth, Lunghi, arXiv:1503.04849

- "Latest" Belle measurement of branching ratio is based on less than 30% of the total luminosity

$$\frac{d^2\Gamma}{dq^2 dz} = \frac{3}{8} [(1 + z^2) H_T(q^2) + 2z H_A(q^2) + 2(1 - z^2) H_L(q^2)] \quad (z = \cos \theta_\ell)$$

$$\frac{d\Gamma}{dq^2} = H_T(q^2) + H_L(q^2) \qquad \frac{dA_{\text{FB}}}{dq^2} = 3/4 H_A(q^2)$$

- Phenomenological analysis to NNLO QCD and NLO QED for all angular observables
- Electromagnetic effects due to energetic photons are large and calculated analytically and crosschecked against Monte Carlo generator events

Size of logs depend on experimental set-up  $\alpha_{\text{em}} \log(m_b^2/m_\ell^2)$

We assume no photons are included in the definition of  $q^2$  (di-muon channel at Babar/Belle, di-electron at Belle)

Babar's di-electron channel: Photons that are emitted in a cone of 35 mrad angular opening are included in  $q^2$

Monte Carlo techniques needed to estimate this effect !

# Monte Carlo analysis

Huber, Hurth, Lunghi, arXiv:1503.04849

(event generator EVTGEN, hadronization JETSET, EM radiation PHOTOS)

$$\frac{[\mathcal{B}_{ee}^{\text{low}}]_{q=p_{e^+}+p_{e^-}+p_{\gamma_{\text{coll}}}}}{[\mathcal{B}_{ee}^{\text{low}}]_{q=p_{e^+}+p_{e^-}}} - 1 = 1.65\%$$

$$\frac{[\mathcal{B}_{ee}^{\text{high}}]_{q=p_{e^+}+p_{e^-}+p_{\gamma_{\text{coll}}}}}{[\mathcal{B}_{ee}^{\text{high}}]_{q=p_{e^+}+p_{e^-}}} - 1 = 6.8\%$$

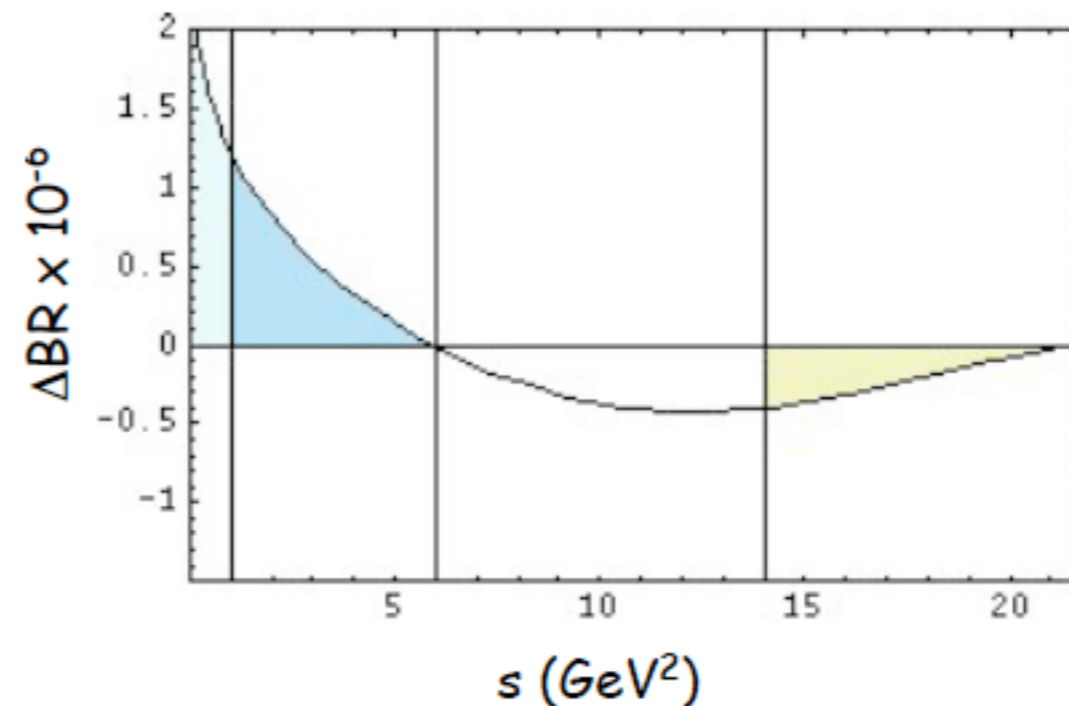
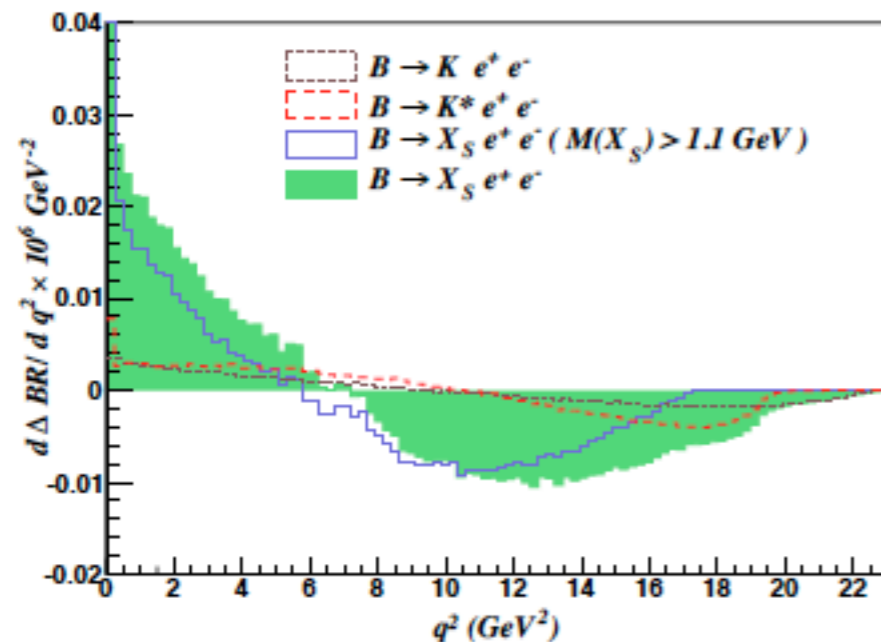
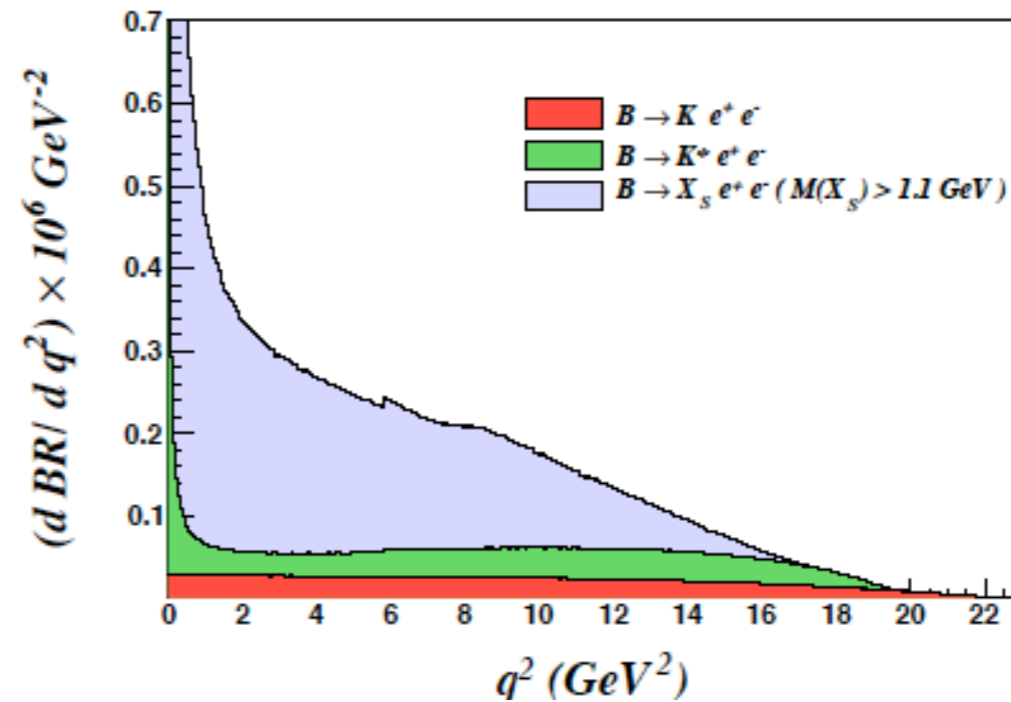
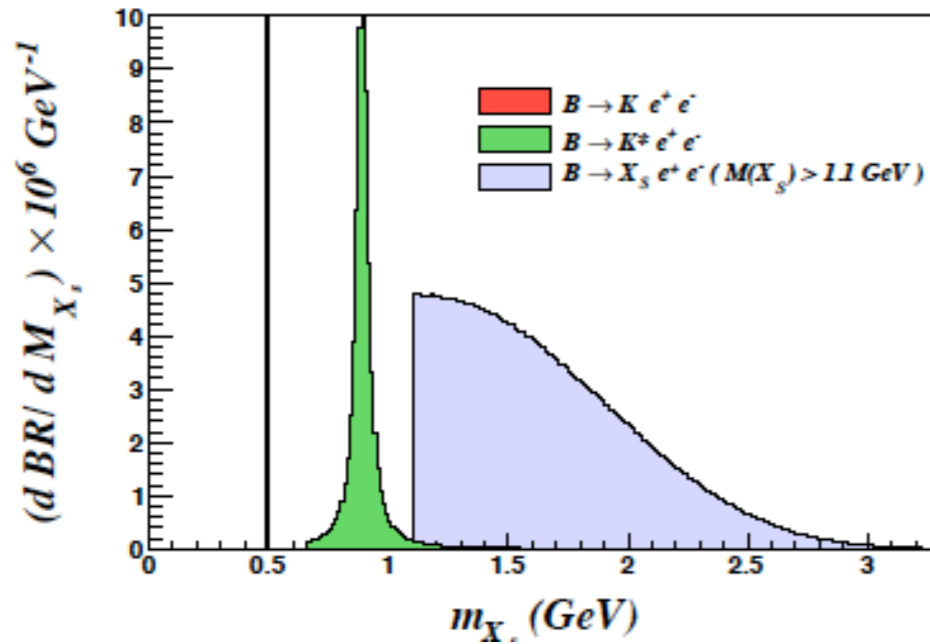

# Subleading contributions in $B \rightarrow X_s l^+ l^-$

- On-shell- $c\bar{c}$ -resonances  $\Rightarrow$  cuts in dilepton mass spectrum necessary :  
 $1\text{GeV}^2 < q^2 < 6\text{GeV}^2$  and  $14.4\text{GeV}^2 < q^2 \Rightarrow$  perturbative contributions dominant

$$\frac{d}{ds} BR(\bar{B} \rightarrow X_s l^+ l^-) \times 10^{-5}$$

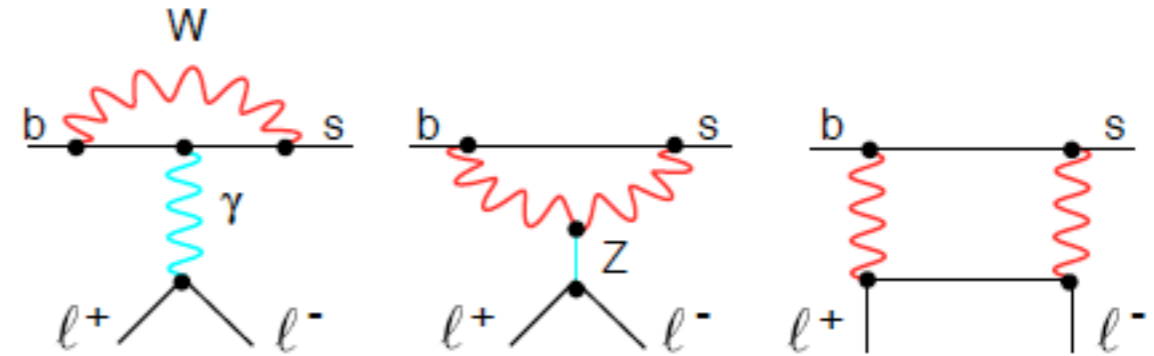
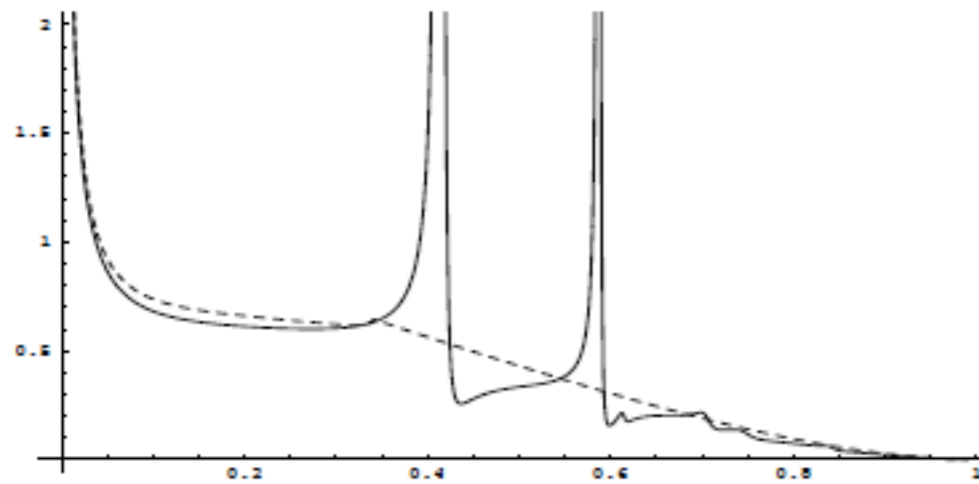

- Again additional subtleties  $\Rightarrow$  additional uncertainties
  - Locally: breakdown of OPE in  $\Lambda_{QCD}/m_b$  in the high- $s$  ( $q^2$ ) endpoint  
 Partonic contribution vanishes in the limit  $s \rightarrow 1$ , while the  $1/m_b^2$  corrections in  $R(s)$  tend towards a nonzero value.

Theoretically: s-quark propagator in the correlator of OPE:

$$S_s(k) = \frac{\not{k} + i \not{D}}{k^2 + 2ik \cdot D - \not{D} \not{D} + i\epsilon}$$

Endpoint region of the  $q^2$  spectrum in  $\bar{B} \rightarrow X_s l^+ l^-$  different from endpoint region of the photon spectrum of  $\bar{B} \rightarrow X_s \gamma$ :

$q^2 \approx m_b^2 \approx M_B^2 \Rightarrow k \sim \Lambda, \quad k^2 \sim \Lambda^2 \Rightarrow$  complete breakdown of OPE

no partial all-orders resummation possible, shape-function irrelevant

Buchalla, Isidori

Practically: for integrated high- $s$  ( $q^2$ ) spectrum one finds an effective expansion ( $s_{\min} \approx 0.6$ ): Ghinculov,Hurth,Isidori,Yao hep-ph/0312128

$$\int_{s_{\min}}^1 ds R(s) = \left[ 1 - \frac{1.6\lambda_2}{m_b^2(1 - \sqrt{s_{\min}})^2} + \frac{1.8\rho_1 + 1.7f_1}{m_b^3(1 - \sqrt{s_{\min}})^3} \right] \times \int_{s_{\min}}^1 ds R(s)|_{m_b \rightarrow \infty}$$

- Hadronic invariant-mass cut is imposed in order to eliminate the background like  $b \rightarrow c (\rightarrow se^+\nu)e^-\bar{\nu} = b \rightarrow se^+e^- +$  missing energy
  - \* Babar,Belle:  $m_X < 1.8$  or  $2.0 GeV$
  - \* high- $q^2$  region not affected by this cut
  - \* kinematics:  $X_s$  is jetlike and  $m_X^2 \leq m_b \Lambda_{QCD} \Rightarrow$  shape function region
  - \* SCET analysis: universality of jet and shape functions found:
    - the 10-30% reduction of the dilepton mass spectrum can be accurately computed using the  $\bar{B} \rightarrow X_s \gamma$  shape function
    - 5% additional uncertainty for  $2.0 GeV$  cut due to subleading shape functions
- Lee,Stewart hep-ph/0511334
- Lee,Ligeti,Stewart,Tackmann hep-ph/0512191
- Lee,Tackmann arXiv:0812.0001 (effect of subleading shape functions)
- Bell,Beneke,Huber,Li arXiv:1007.3758 (NNLO matching QCD  $\rightarrow$  SCET)

# Subleading power factorization in $B \rightarrow X_s l^+ l^-$

Benzke, Fickinger, Hurth, Turczyk, to appear

## Hadronic cut

Additional cut in  $X_s$  necessary to reduce background affects only low- $q^2$  region.

Hadronic invariant  $m_X^2 < 1.8(2.0) \text{GeV}^2$ , jet-like  $X_s$

Multiscale problem  $\rightarrow$  SCET

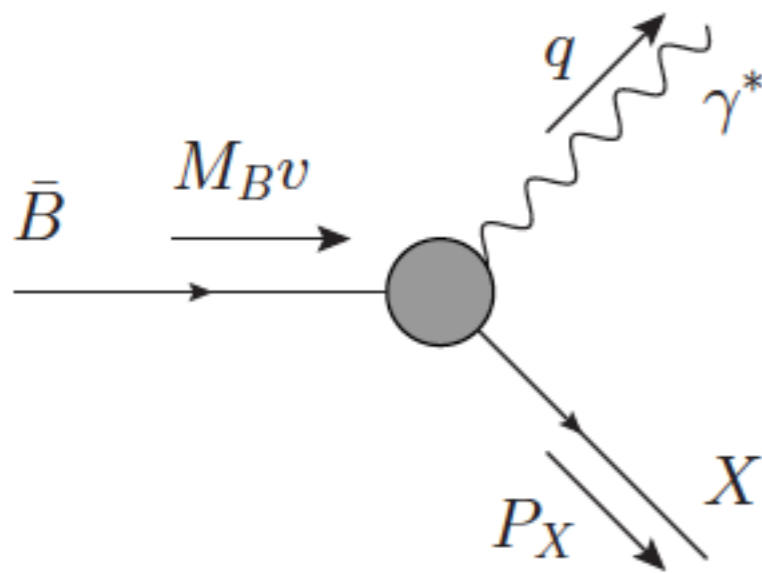

$$m_X^2 = P_X^2 = (M_B - n \cdot q)(M_B - \bar{n} \cdot q)$$

$$M_B^2 \sim m_b^2 \gg m_X^2 \sim \Lambda_{\text{QCD}} m_b \gg \Lambda_{\text{QCD}}^2$$



# Allowed regions

low- $q^2$

Red:  $q^2 = [1, 5, 6] \text{ GeV}^2$  [Dotted, Solid, Dashed]

Black:  $M_x = [0.495, 1.25, 2] \text{ GeV}$  [Dotted, Solid, Dashed]

Blue: anti-hard-collinear component scaling

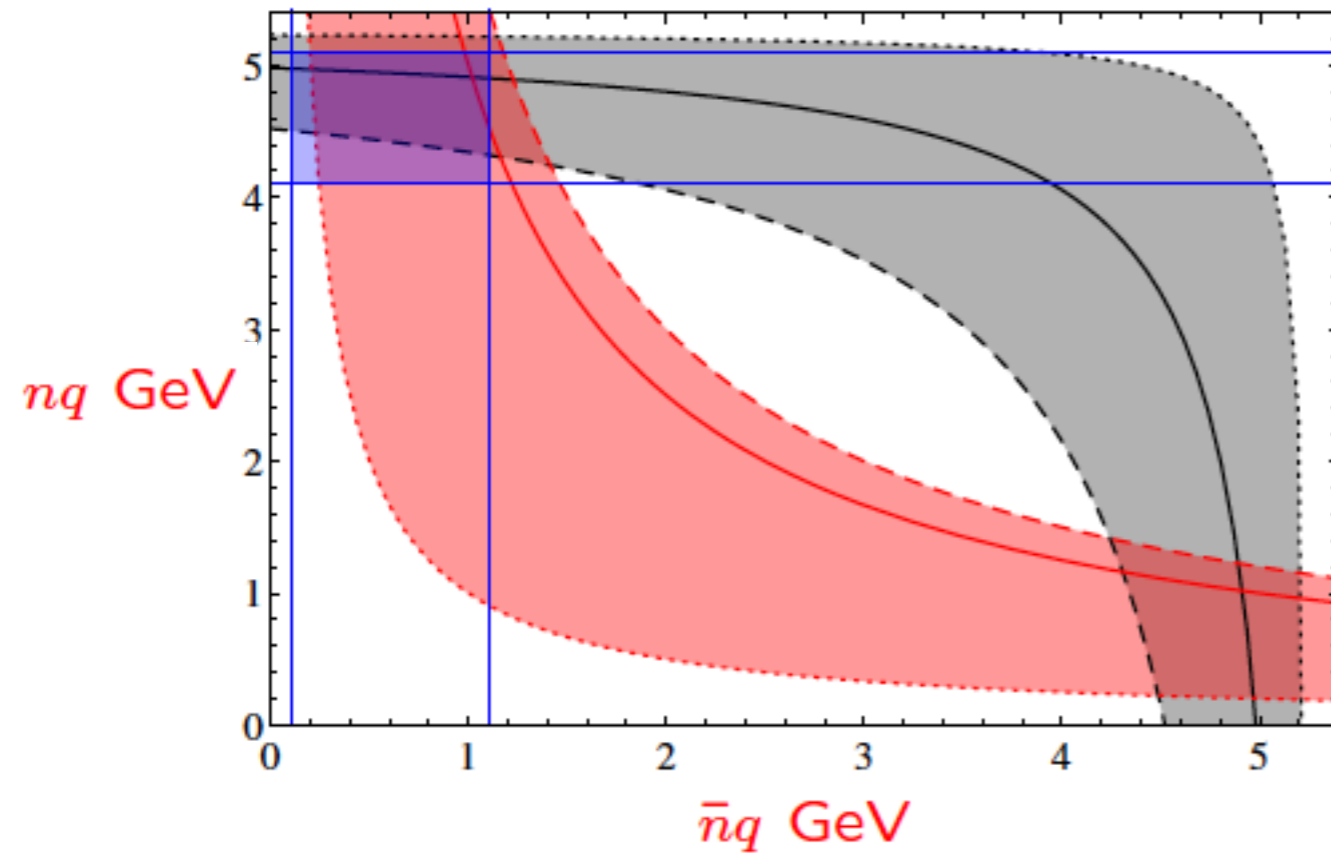

high- $q^2$

Red:  $q^2 = [15, 17, 22] \text{ GeV}^2$  [Dotted, Solid, Dashed]

Black:  $M_x = [0.495, 1.25, 2] \text{ GeV}$  [Dotted, Solid, Dashed]

Blue: hard component scaling

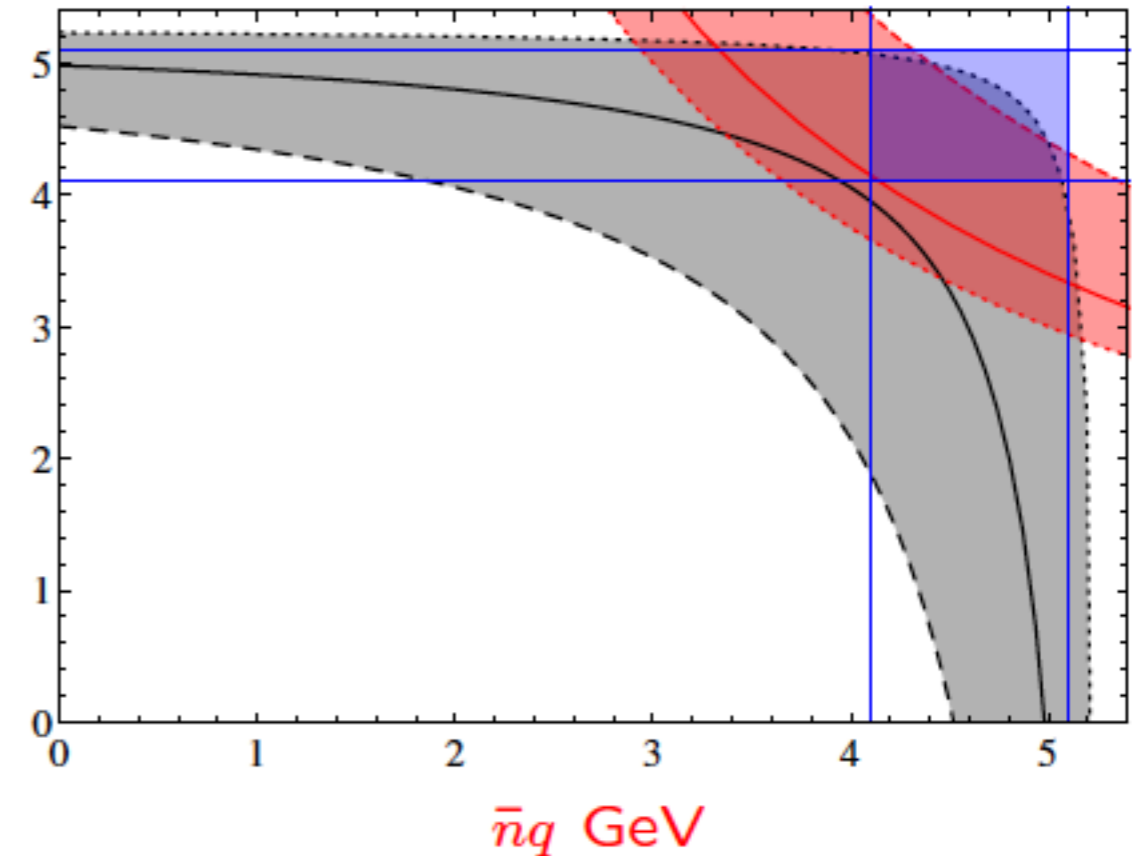

## Scaling

$$\lambda = \Lambda_{\text{QCD}}/m_b$$

$$m_X^2 \sim \lambda \Rightarrow m_b - n \cdot q \sim \lambda$$

# Scaling

$M_X = [0.5, 1.6, 2]$  GeV [Black, Blue, Red]

Upper lines :  $P_X^-$ , lower lines :  $P_X^+$

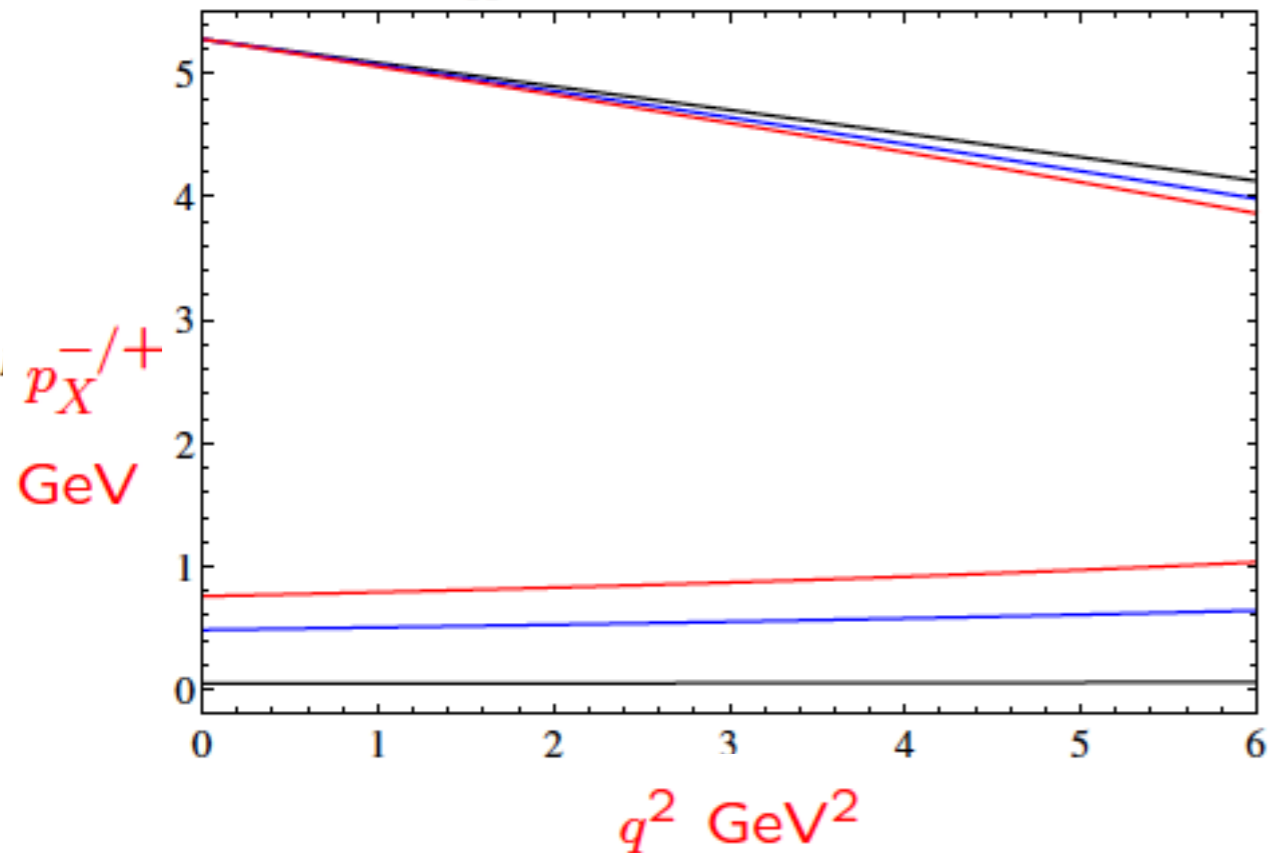

$M_X = [0.5, 1.6, 2]$  GeV [Black, Blue, Red]

Upper lines :  $q^+$ , lower lines :  $q^-$

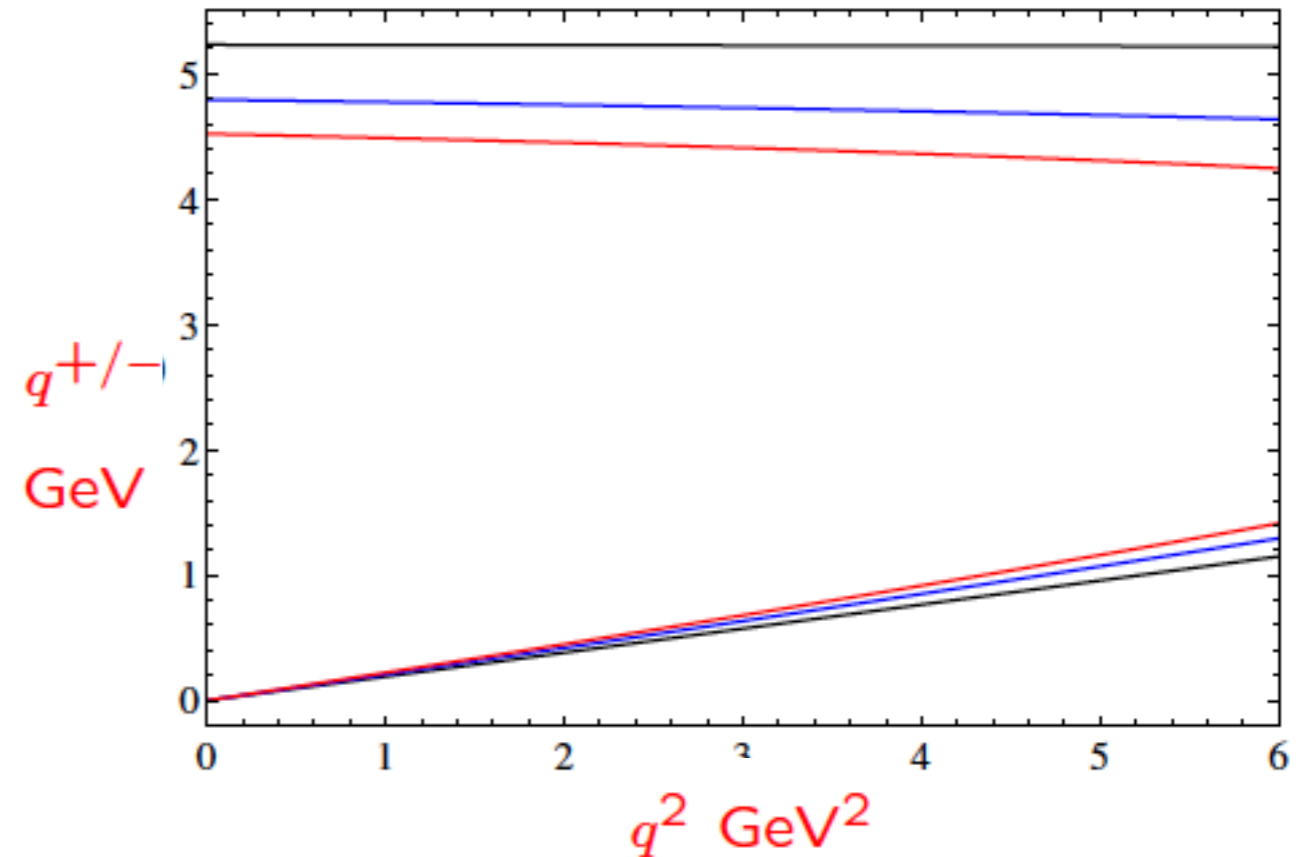

For  $q^2 < 6 \text{ GeV}^2$  the scaling of  $np_X$  and  $\bar{n}p_X$  implies  $\bar{n}q$  is of order  $\lambda$ , means  $q$  anti-hard-collinear (just kinematics).

Stewart and Lee assume  $\bar{n}q$  to be order 1, means  $q$  is hard.

This problematic assumption implies a different matching of SCET/QCD.

## Shapefunction region

Local OPE breaks down for  $m_X^2 \sim \lambda$ :

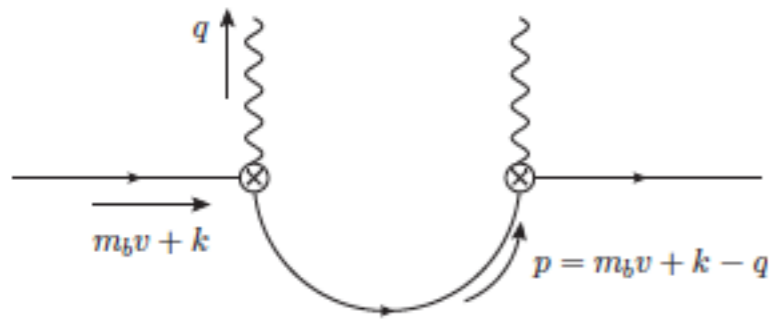

$$\frac{1}{(m_b v + k - q)^2} = \frac{1}{m_b - n \cdot q} \left( 1 - \frac{n \cdot k}{m_b - n \cdot q} + \dots \right) \frac{1}{m_b - \bar{n} \cdot q}$$

Resummation of leading contributions into a shape function.

(scaling of  $\bar{n}q$  does not matter here; zero in case of  $B \rightarrow X_s \gamma$ )

**Factorization theorem**  $d\Gamma \sim H \cdot J \otimes S$

The hard function  $H$  and the jet function  $J$  are perturbative quantities.

The shape function  $S$  is a non-perturbative non-local HQET matrix element.

(universality of the shape function, uncertainties due to subleading shape functions)

# Calculation at subleading power

Example of **direct** photon contribution which factorizes

$$d\Gamma \sim H \cdot j \otimes S$$

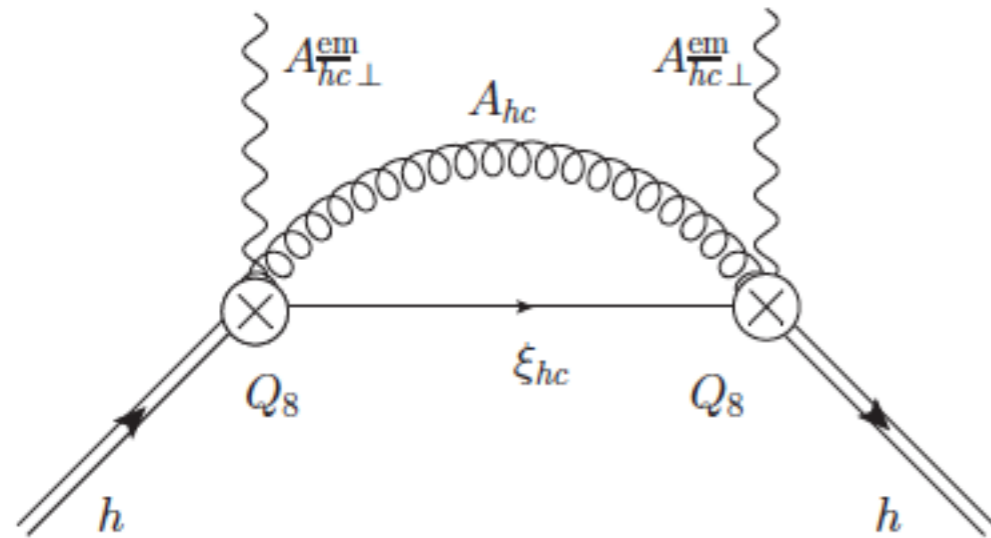

$\rightarrow \frac{\alpha_s}{m_b}$  in low  $m_\chi^2$  region

Example of **resolved** photon contribution (double-resolved) which factorizes

$$d\Gamma \sim H \cdot J \otimes s \otimes \bar{J} \otimes \bar{J}$$

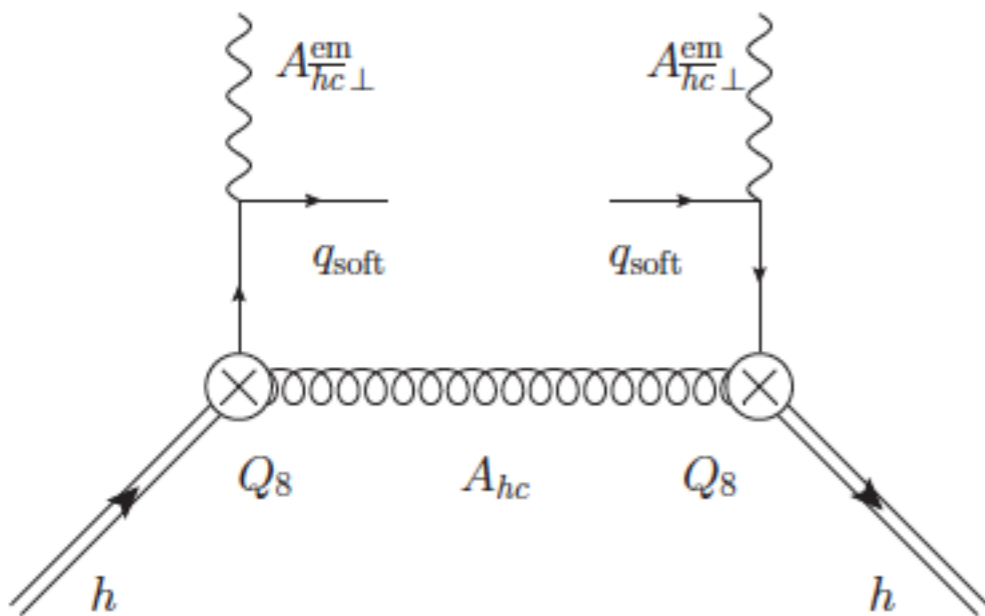

$\rightarrow \frac{\Lambda}{m_b}$

Shape function is non-local in two light-cone directions.

It survives  $M_\chi \rightarrow 1$  limit (irreducible uncertainty).

## Interference of $Q_8$ and $Q_8$

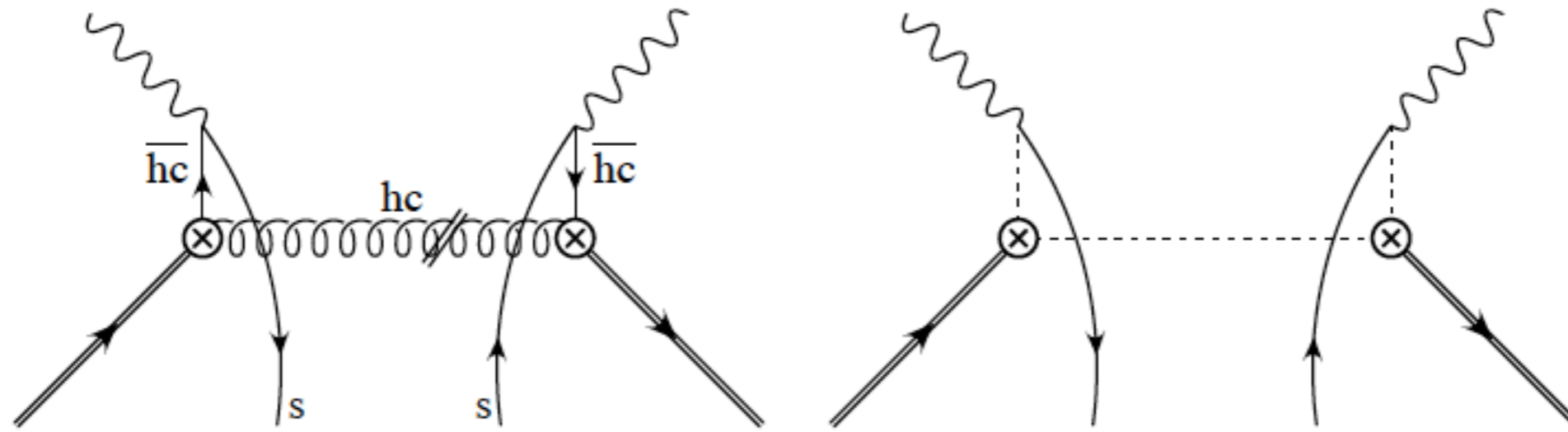

$$\frac{d\Gamma^{\text{res}}}{dn \cdot q d\bar{n} \cdot q} \sim \frac{e_s^2 \alpha_s}{m_b} \int d\omega \delta(\omega + p_+) \int \frac{d\omega_1}{\omega_1 + \bar{n} \cdot q + i\epsilon} \int \frac{d\omega_2}{\omega_2 + \bar{n} \cdot q - i\epsilon} g_{88}(\omega, \omega_1, \omega_2)$$

$$g_{88}(\omega, \omega_1, \omega_2) = \frac{1}{M_B} \langle \bar{B} | \bar{h}(\mathbf{tn}) \dots s(\mathbf{tn} + \mathbf{u}\bar{\mathbf{n}}) \bar{s}(\mathbf{r}\bar{\mathbf{n}}) \dots h(\mathbf{0}) | \bar{B} \rangle_{\text{F.T.}}$$

## Interference of $Q_1$ and $Q_7$

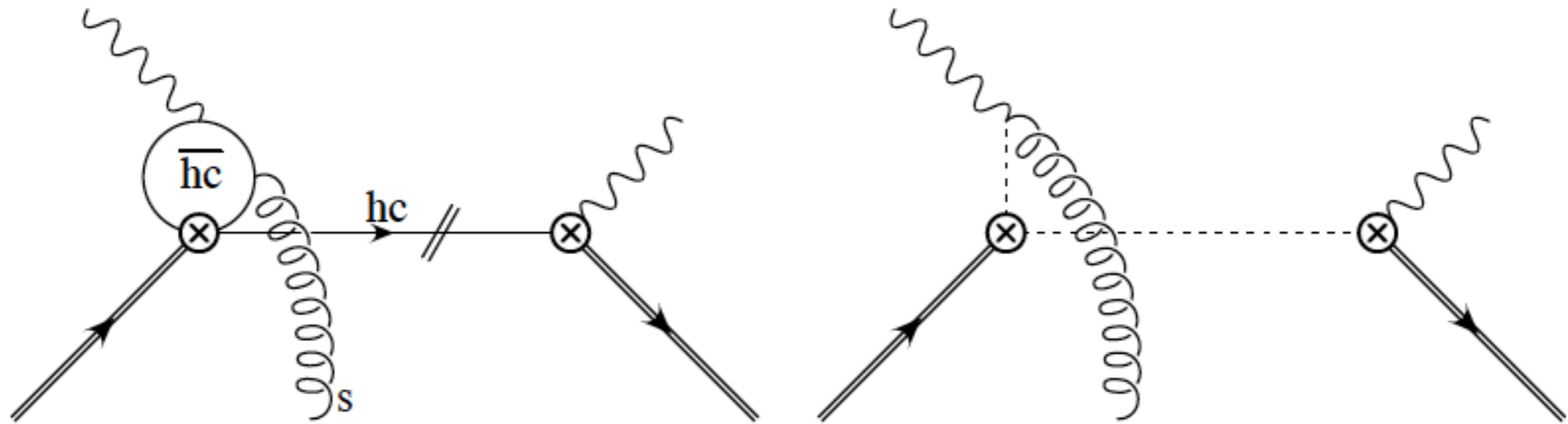

$$\frac{d\Gamma^{\text{res}}}{dn \cdot q d\bar{n} \cdot q} \sim \frac{1}{m_b} \int d\omega \delta(\omega + p_+) \int \frac{d\omega_1}{\omega_1 + i\epsilon}$$

$$\frac{1}{\omega_1} \left[ \bar{n} \cdot q \left( F \left( \frac{m_c^2}{n \cdot q \bar{n} \cdot q} \right) - 1 \right) - (\bar{n} \cdot q + \omega_1) \left( F \left( \frac{m_c^2}{n \cdot q (\bar{n} \cdot q + \omega_1)} \right) - 1 \right) \right.$$

$$\left. + \bar{n} \cdot q \left( G \left( \frac{m_c^2}{n \cdot q \bar{n} \cdot q} \right) - G \left( \frac{m_c^2}{n \cdot q (\bar{n} \cdot q + \omega_1)} \right) \right) \right] g_{17}(\omega, \omega_1)$$

$$g_{17}(\omega, \omega_1) = \int \frac{dr}{2\pi} e^{-i\omega_1 r} \int \frac{dt}{2\pi} e^{-i\omega t} \frac{1}{M_B} \langle \bar{B} | \bar{h}(t\mathbf{n}) \dots G_s^{\alpha\beta}(r\bar{\mathbf{n}}) \dots h(0) | \bar{B} \rangle$$

Expansion for  $m_c \sim m_b$  leads to Voloshin term in the total rate ( $-\lambda_2/m_c^2$ ), the terms stays non-local for  $m_c < m_b$ .

## Factorization formula

In the  $m_X^2 \sim \lambda$  and  $q^2 \sim \lambda$  region we have the following factorization formula

$$d\Gamma \sim H \cdot J \otimes S + \frac{1}{m_b} \sum H \cdot j_i \otimes S + \frac{1}{m_b} \sum H \cdot J \otimes s_i + \frac{1}{m_b} \sum H \cdot J \otimes s_i \otimes \bar{J} + \frac{1}{m_b} \sum H \cdot J \otimes s_i \otimes \bar{J} \otimes \bar{J} + \mathcal{O}\left(\frac{1}{m_b^2}\right)$$

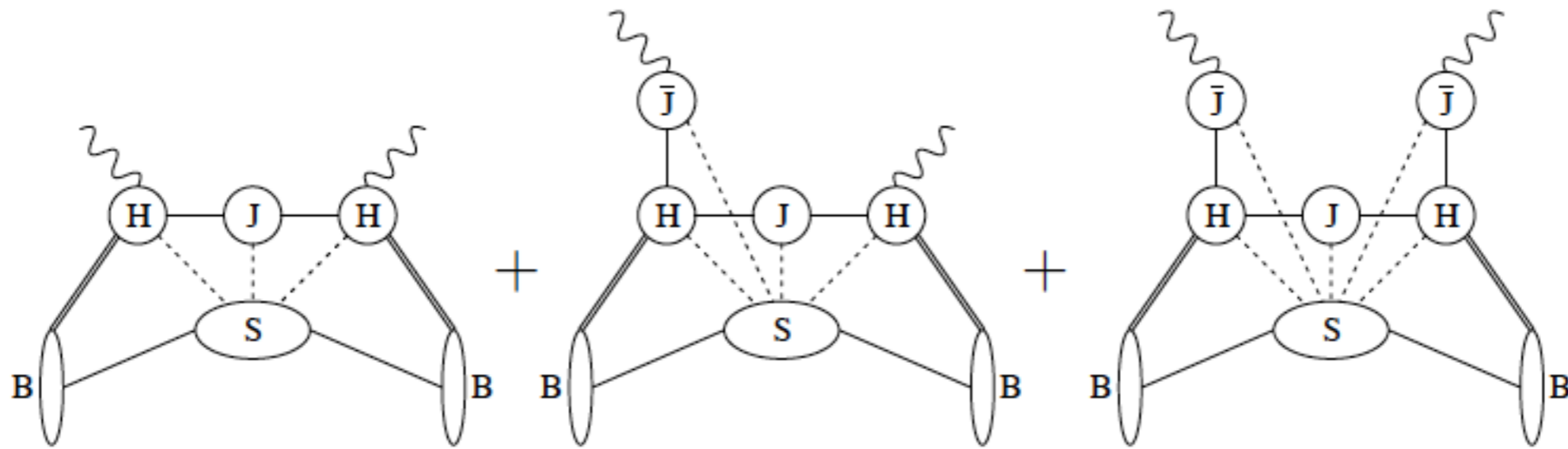

## Numerical evaluation (work in progress)

Similar subleading shape functions as in  $B \rightarrow X_s \gamma$

Use vacuum insertion approximation, PT invariance,....

## Summary

- For  $q$  anti-hard-collinear we have identified a new type of subleading power corrections.
- In the resolved contributions the photon couples to light partons instead of connecting directly to the effective weak-interaction vertex.
- They constitute an irreducible uncertainty because they survive the  $M_X \rightarrow 1$  limit.





# Mainz Institute for Theoretical Physics

## ACTIVITIES 2016

### SCIENTIFIC PROGRAMS

---

#### NA62 Kaon Physics Handbook

Augusto Ceccucci CERN, Giancarlo D'Ambrosio INFN Naples  
Ulrich Haisch Univ. Oxford, Rainer Wanke JGU

**January 11-22, 2016**

#### Composite Dynamics: from Lattice to LHC Run II

Giacomo Cacciapaglia IPN Lyon  
Francesco Sannino CP<sup>3</sup> Origins, Thomas Flacke KAIST

**April 4-15, 2016**

#### Dark Matter in the Milky Way

Fabio Iocco ICTP-SAIFR & IFT-UNESP, São Paulo  
Arianna Di Cintio DARK, Univ. Copenhagen  
Miguel Pato Univ. Stockholm  
Christoph Weniger Univ. Amsterdam

**May 2-13, 2016**

#### Neutron Skins of Nuclei

Charles Horowitz Indiana Univ.  
Jorge Piekarewicz Florida State Univ.  
Concettina Sfienti, Marc Vanderhaeghen JGU

**May 17-27, 2016**

#### Exploring the Energy Ladder of the Universe

Pasquale Di Bari, Steve King Univ. Southampton  
Qaisar Shafi Univ. Delaware

**May 30-June 10, 2016**

### TOPICAL WORKSHOPS

---

#### Determination of the Fundamental Parameters in QCD

Irinel Caprini IFIN-HH Bucharest  
Konstantyn Chetyrkin INR Moskau  
Cesareo A. Dominguez Univ. Cape Town  
Antonio Pich Univ. Valencia, Hubert Spiesberger JGU

**March 7-12, 2016**

#### Flavor and Electroweak Symmetry Breaking

Giulia Ricciardi Univ. Naples Federico II  
Tobias Hurth, Matthias Neubert JGU

**June 13-24, 2016, Capri, Italy**

#### Understanding the First Results from LHC Run II

Tilman Plehn Univ. Heidelberg  
Graham Kribs Univ. Oregon  
Shufang Su Univ. Arizona  
Tim Tait UC Irvine

**June 27-July 22, 2016**

#### Effective Field Theories as Discovery Tools

Wolfgang Altmannshofer Perimeter Inst.  
Yang Bai Univ. Wisconsin Madison  
Monika Blanke KIT Karlsruhe  
Felix Yu, Jose Zurita JGU

**August 22-September 9, 2016**

### MITP SUMMER SCHOOL

---

#### New Physics on Trial at LHC Run II

Joachim Brod, Maikel De Vries  
Anna Kaminska, Felix Yu  
Matthias Neubert JGU

**July 25-August 5, 2016**

#### Relativistic Hydrodynamics: Theory and Modern Applications

Francesco Becattini Florence Univ.  
Dmitri Kharzeev Stony Brook Univ. & BNL  
Dirk H. Rischke Goethe Univ. Frankfurt  
Dam Thanh Son Univ. Chicago  
Mikhail Stephanov Univ. Illinois, Chicago

**October 10-14, 2016**

For more details: <http://www.mitp.uni-mainz.de>

**Extra**

## Quark-hadron duality violated in $\bar{B} \rightarrow X_s \ell^+ \ell^-$ ? BBNS, arXiv:0902.4446

Within integrated branching ratio the resonances  $J/\psi$  and  $\psi'$  exceed the perturbative contributions **by two orders** of magnitude.

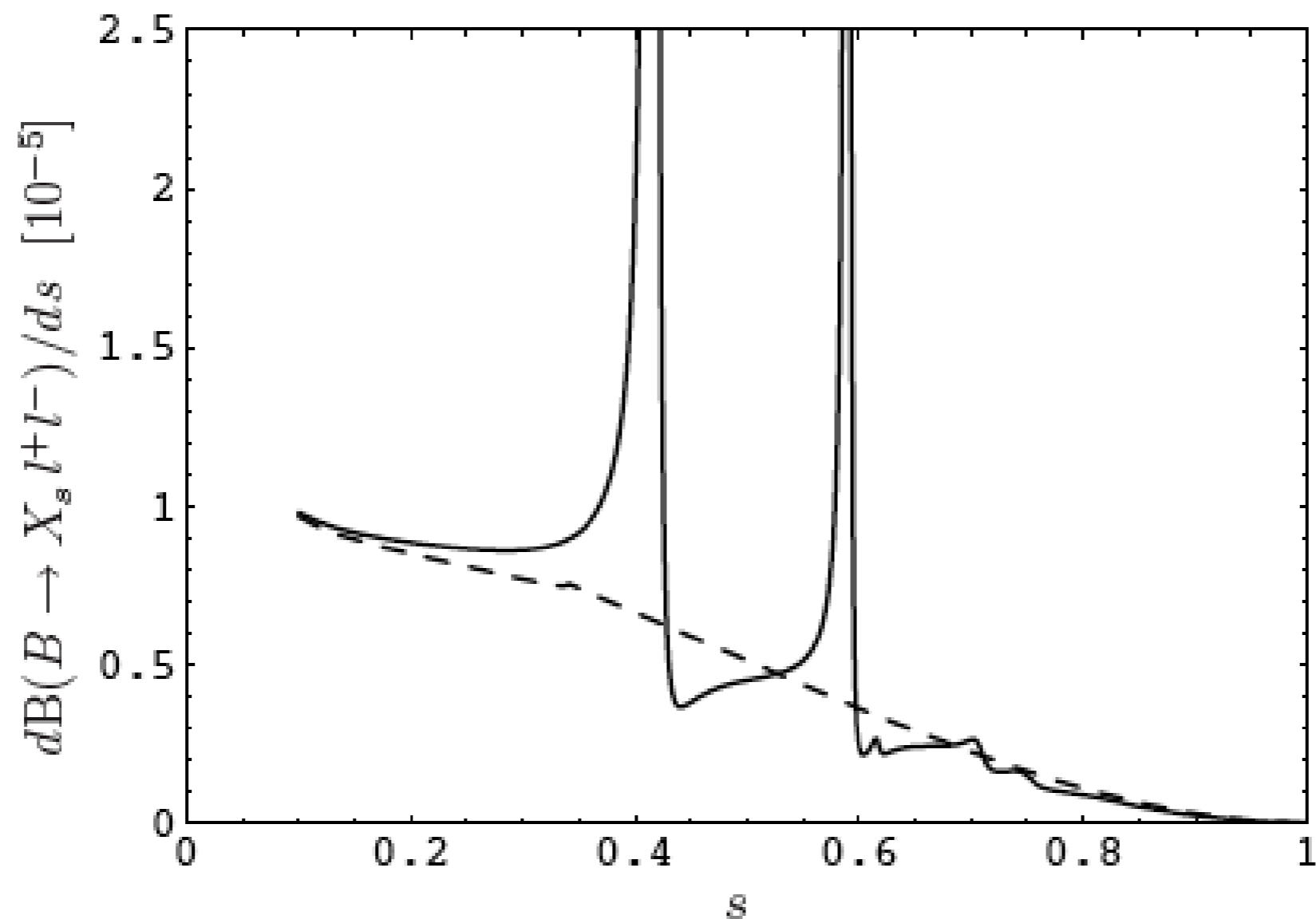

Quark-hadron duality violated in  $\bar{B} \rightarrow X_s \ell^+ \ell^-$  ? BBNS, arXiv:0902.4446

Within integrated branching ratio the resonances  $J/\psi$  and  $\psi'$  exceed the perturbative contributions **by two orders** of magnitude.

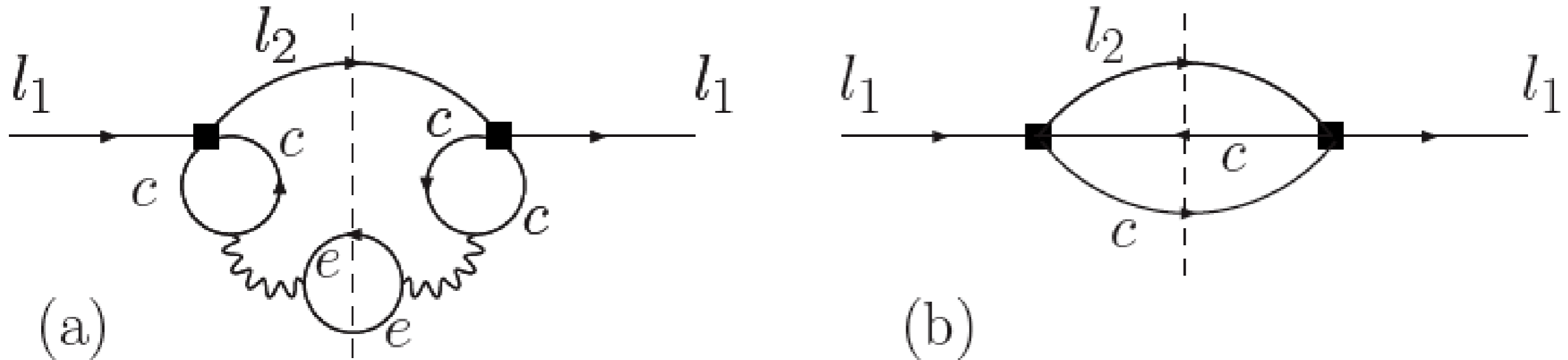

The rate  $l_1 \rightarrow l_2 e^+ e^-$  (a) is connected to the integral over  $|\Pi(q^2)|^2$  for which global duality is **NOT** expected to hold.

In contrast the inclusive hadronic rate  $l_1 \rightarrow l_2 X$  (b) corresponds to the imaginary part of the correlator  $\Pi(q^2)$ .

# Signs for lepton non-universality ?

LHCb; arXiv:1406.6482

$$R_K \equiv \frac{\mathcal{B}(B^+ \rightarrow K^+ \mu^+ \mu^-)}{\mathcal{B}(B^+ \rightarrow K^+ e^+ e^-)} = 0.745_{-0.074}^{+0.090} (\text{stat}) \pm 0.036 (\text{syst}) \quad 2.6\sigma \text{ deviation from SM}$$

Theoretically rather clean

Hiller, Schmaltz; Ghosh et al.; Biswas et al.;  
Straub et al.; Hurth et al.; Glashow et al. ....

## Global fits to the $b \rightarrow sll$ data

Hurth, Mahmoudi, Neshatpour, arXiv:1410.4545

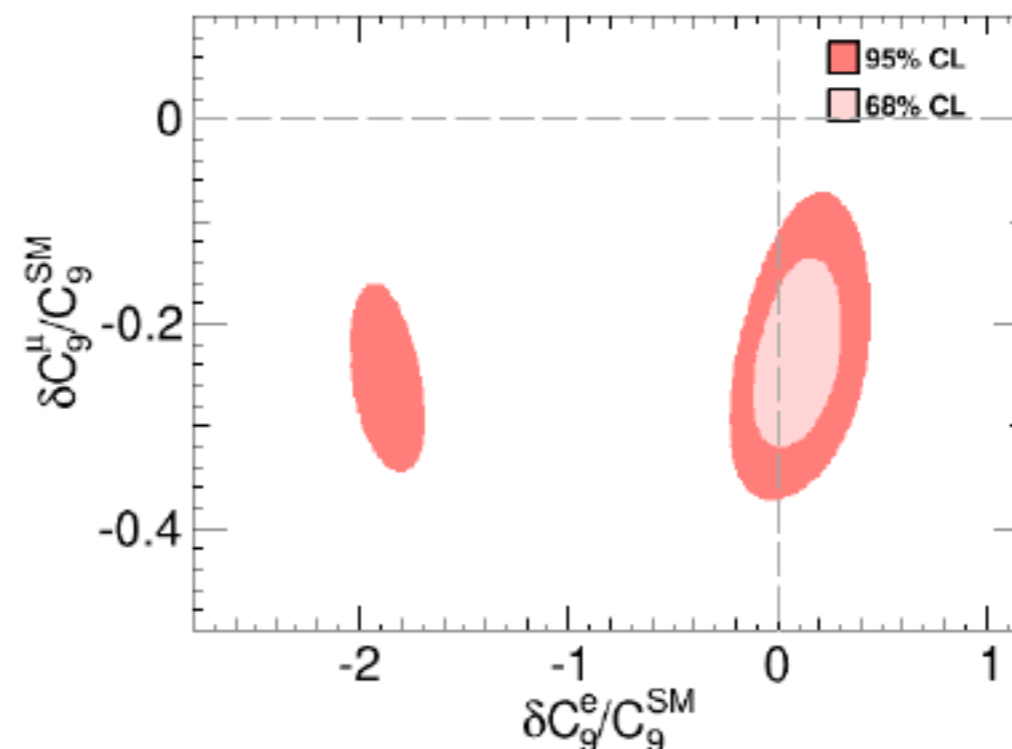
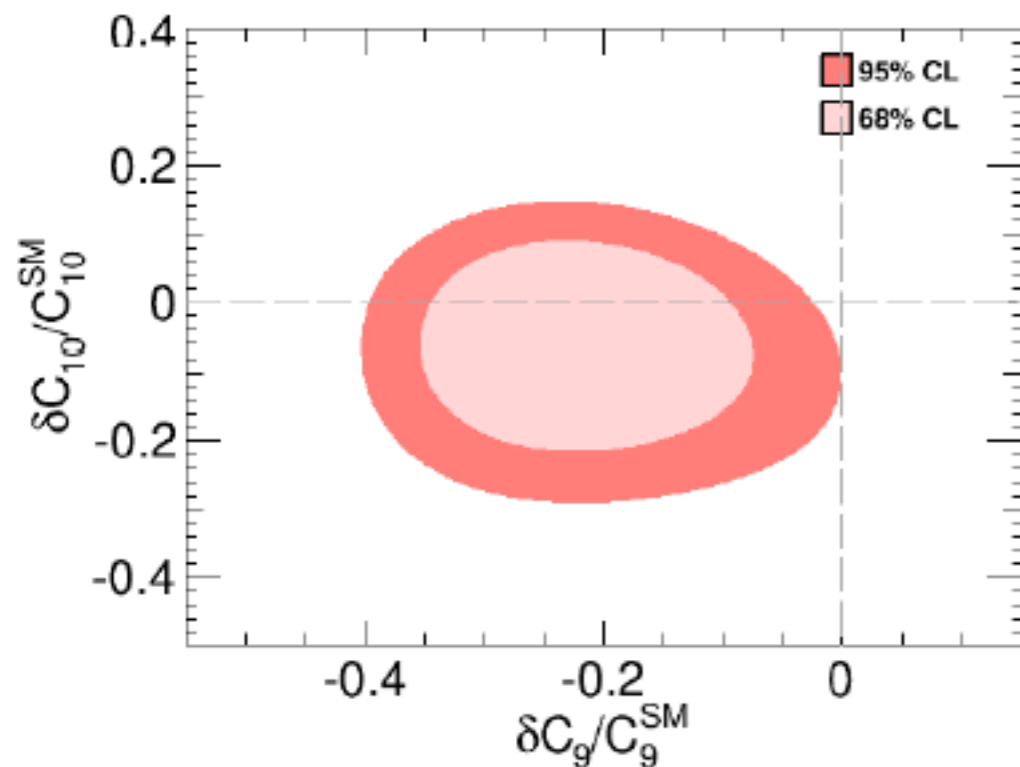

Fit results for two operators

Tensors, scalars difficult, sign for tension in  $C_9^\mu$

Electromagnetic corrections are taken into account !

# Review of previous calculations for $B \rightarrow X_s l l$

- On-shell- $c\bar{c}$ -resonances  $\Rightarrow$  cuts in dilepton mass spectrum necessary :  
 $1\text{GeV}^2 < q^2 < 6\text{GeV}^2$  and  $14.4\text{GeV}^2 < q^2 \Rightarrow$  perturbative contributions dominant

$$\frac{d}{d\hat{s}} BR(\bar{B} \rightarrow X_s l^+ l^-) \times 10^{-5}$$

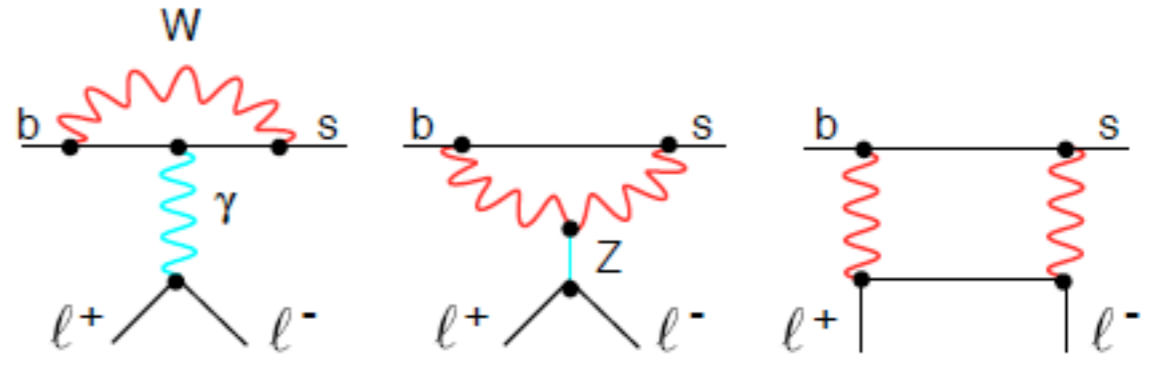
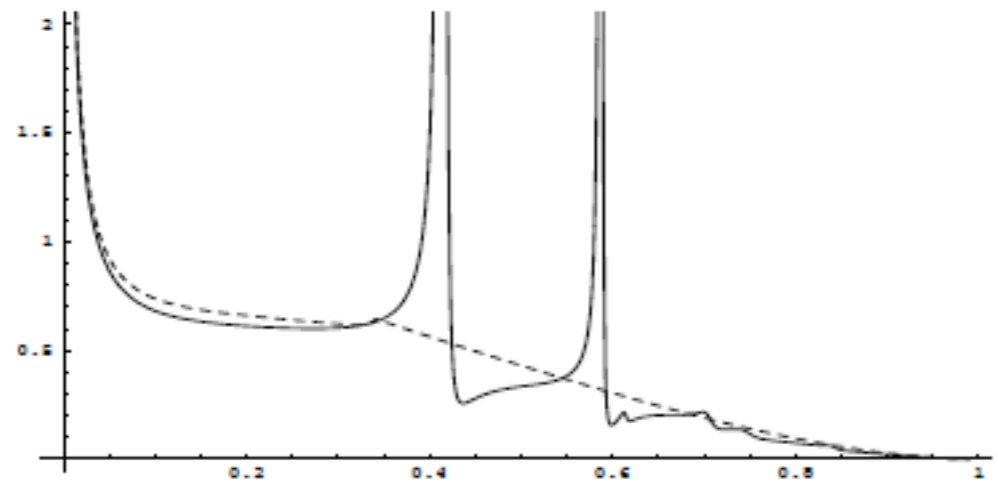

$$\hat{s} = q^2/m_b^2$$

- NNLL prediction of  $\bar{B} \rightarrow X_s l^+ l^-$ : dilepton mass spectrum  
 Asatryan, Asatrian, Greub, Walker, hep-ph/0204341;  
 Ghinculov, Hurth, Isidori, Yao hep-ph/0312128:

$$BR(\bar{B} \rightarrow X_s l^+ l^-)_{Cut: q^2 \in [1\text{GeV}^2, 6\text{GeV}^2]} = (1.63 \pm 0.20) \times 10^{-6}$$

$$BR(\bar{B} \rightarrow X_s l^+ l^-)_{Cut: q^2 > 14.4\text{GeV}^2} = (4.04 \pm 0.78) \times 10^{-7}$$

NNLL QCD corrections  $q^2 \in [1\text{GeV}^2, 6\text{GeV}^2]$   
 central value: -14%, perturbative error: 13%  $\rightarrow$  6.5%

- Further refinements:
  - Completing NNLL QCD corrections:  
Mixing into  $\mathcal{O}_9$  (+1%), NNLL matrixelement of  $\mathcal{O}_9$  (-4%)
  - NLL QED two-loop corrections to Wilson coefficients  
-1.5% shift for  $\alpha_{em}(\mu = m_b)$ , -8.5% for  $\alpha_{em}(\mu = m_W)$   
Bobeth, Gambino, Gorbahn, Haisch, hep-ph/0312090
  - QED two-loop corrections to matrix elements  
Large collinear logarithm  $Log(m_b/m_\ell)$  which survive integration  
if a restricted part of the dilepton mass spectrum is considered  
+2% effect in the low- $q^2$  region for muons, for the electrons  
the effect depends on the experimental cut parameters  
Huber, Lunghi, Misiak, Wyler, hep-ph/0512066
- NNLL prediction of  $\bar{B} \rightarrow X_s \ell^+ \ell^-$ : forward-backward-asymmetry (FBA)  
Asatrian, Bieri, Greub, Hovhannisyan, hep-ph/0209006;  
Ghinculov, Hurth, Isidori, Yao, hep-ph/0208088, hep-ph/0312128:

$$A_{FB} \equiv \frac{1}{\Gamma_{semilep}} \left( \int_0^1 d(\cos \theta) \frac{d^2\Gamma}{dq^2 d \cos \theta} - \int_{-1}^0 d(\cos \theta) \frac{d^2\Gamma}{dq^2 d \cos \theta} \right)$$

( $\theta$  angle between  $\ell^+$  and  $B$  momenta in dilepton CMS)

$$A_{FB}(q_0^2) = 0 \quad \text{for} \quad q_0^2 \sim C_7/C_9 \quad q_0^2 = (3.90 \pm 0.25) GeV^2$$

- "Latest" Belle measurement of branching ratio is based on less than 30% of the total luminosity

Belle hep-ex/0503044 (!!!) (based  $152 \times 10^6 B\bar{B}$  events)

Babar hep-ex/0404006 (!!!) (based  $89 \times 10^6 B\bar{B}$  events)

## Integrated luminosity of B factories

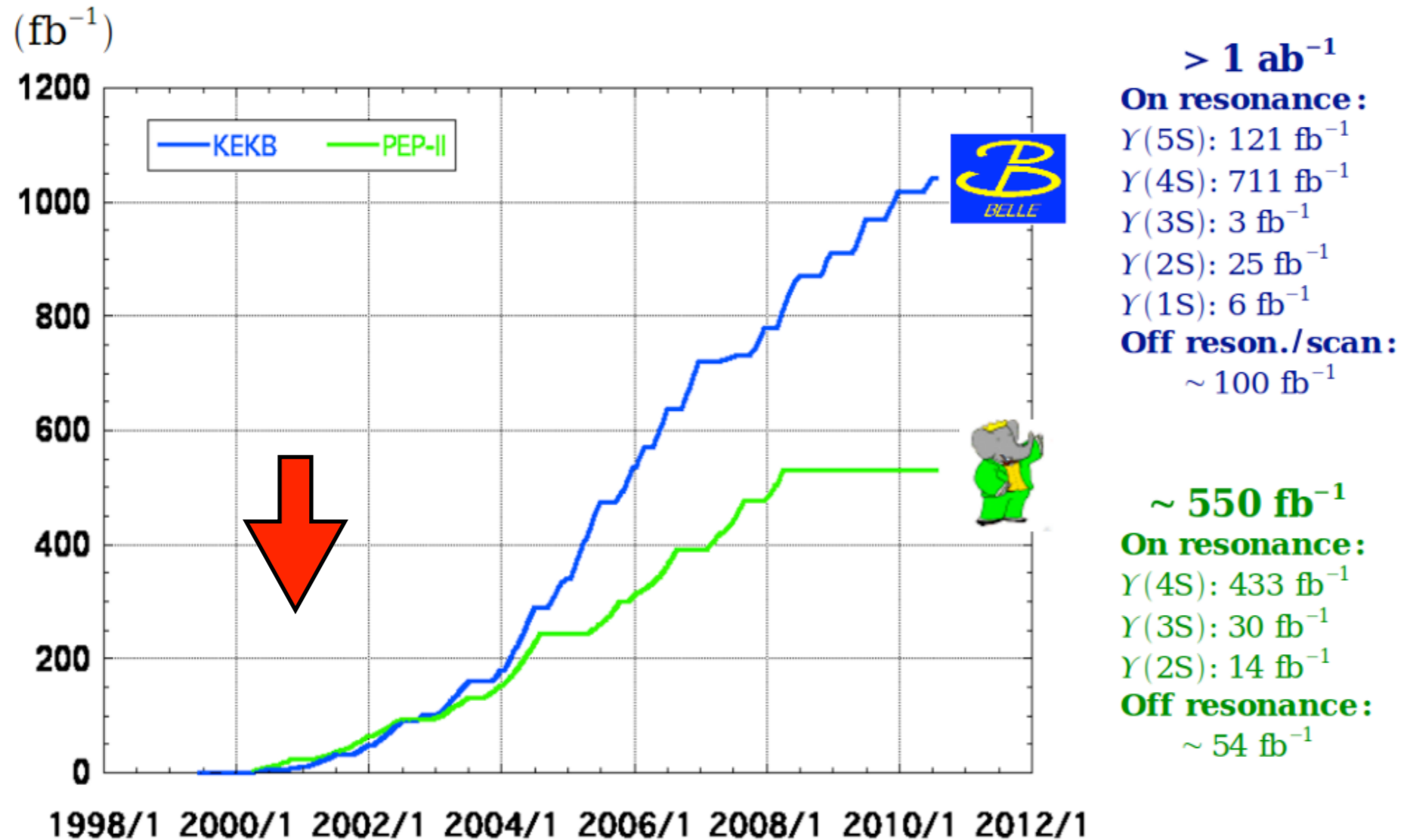

### Two new analyses from the *B* factories:

New Babar analysis on dilepton spectrum arXiv:1312.3664

New Belle analysis on AFB arXiv:1402.7134



- Observables

$$\frac{d^2\Gamma}{dq^2 dz} = \frac{3}{8} [(1+z^2) H_T(q^2) + 2z H_A(q^2) + 2(1-z^2) H_L(q^2)] \quad (z = \cos \theta_\ell)$$

$$\frac{d\Gamma}{dq^2} = H_T(q^2) + H_L(q^2)$$

$$\frac{dA_{\text{FB}}}{dq^2} = 3/4 H_A(q^2)$$

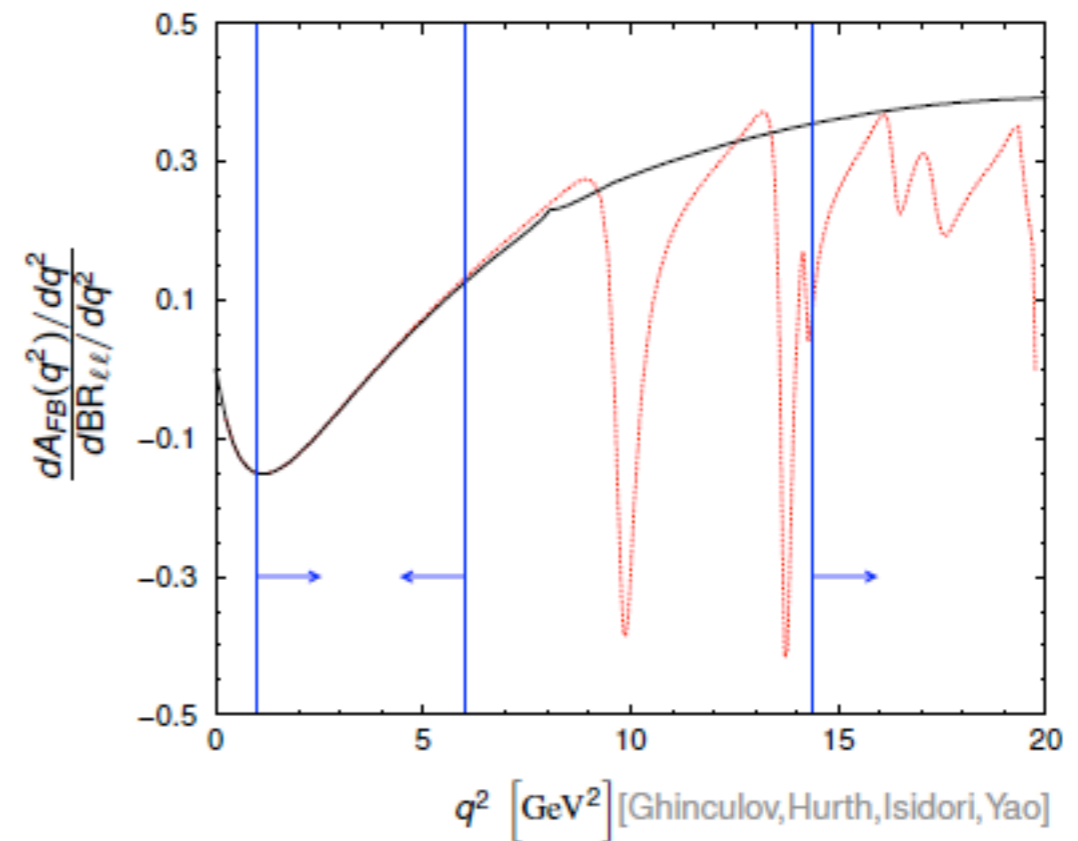
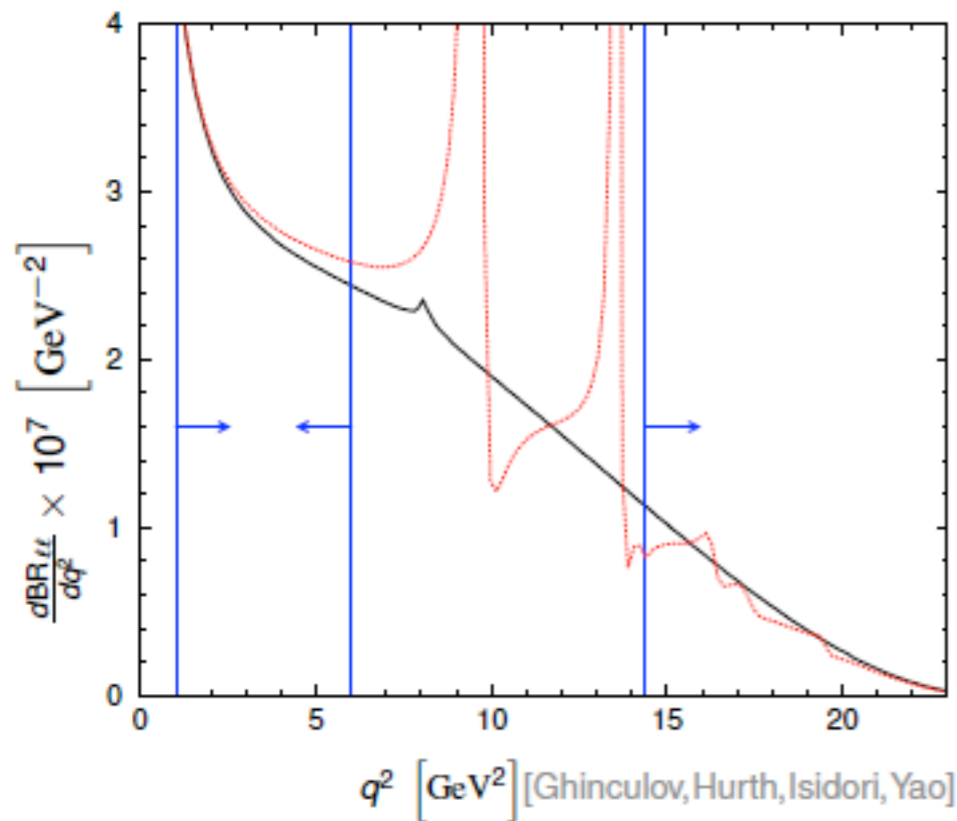

Low- $q^2$  region:  $1 \text{ GeV}^2 < q^2 < 6 \text{ GeV}^2$

High- $q^2$  region:  $q^2 > 14.4 \text{ GeV}^2$

- Dependence on Wilson coefficients

$$H_T(q^2) \propto 2s(1-s)^2 \left[ \left| C_9 + \frac{2}{s} C_7 \right|^2 + |C_{10}|^2 \right]$$

$$H_A(q^2) \propto -4s(1-s)^2 \operatorname{Re} \left[ C_{10} \left( C_9 + \frac{2}{s} C_7 \right) \right]$$

$$H_L(q^2) \propto (1-s)^2 \left[ |C_9 + 2 C_7|^2 + |C_{10}|^2 \right]$$

$H_T$  suppressed in low- $q^2$  window

- Devide low- $q^2$  bin in two bins (zero of  $H_A$  in low- $q^2$ )

Lee,Ligeti,Stewart, Tackmann hep-ph/0612156

- Most important input parameters

$$m_b^{\text{1S}} = (4.691 \pm 0.037) \text{ GeV}, \quad \bar{m}_c(\bar{m}_c) = (1.275 \pm 0.025) \text{ GeV}$$

$$|V_{ts}^* V_{tb} / V_{cb}|^2 = 0.9621 \pm 0.0027, \quad BR_{b \rightarrow c e \nu}^{\text{exp.}} = (10.51 \pm 0.13) \%$$

- Perturbative expansion (NNLO QCD + NLO QED)  $\alpha_s$   $\kappa = \alpha_{\text{em}} / \alpha_s$

$$A = \kappa \left[ A_{LO} + \alpha_s A_{NLO} + \alpha_s^2 A_{NNLO} + \mathcal{O}(\alpha_s^3) \right]$$

$$+ \kappa^2 \left[ A_{LO}^{\text{em}} + \alpha_s A_{NLO}^{\text{em}} + \alpha_s^2 A_{NNLO}^{\text{em}} + \mathcal{O}(\alpha_s^3) \right] + \mathcal{O}(\kappa^3)$$

$$\text{LO} = \alpha_{\text{em}} / \alpha_s, \quad \text{NLO} = \alpha_{\text{em}}, \quad \text{NNLO} = \alpha_{\text{em}} \alpha_s$$

- Normalization:

Huber,Hurth,Lunghi, arXiv:1503.04849

$$\frac{d BR(\bar{B} \rightarrow X_s l l)}{d \hat{s}} = BR_{b \rightarrow c e \nu}^{exp.} \left| \frac{V_{ub}}{V_{cb}} \right|^2 \frac{1}{C} \frac{d\Gamma(\bar{B} \rightarrow X_s l l)/d\hat{s}}{\Gamma(\bar{B} \rightarrow X_u e \bar{\nu})}$$

$$C = \left| \frac{V_{ub}}{V_{cb}} \right|^2 \frac{\Gamma(\bar{B} \rightarrow X_c e \bar{\nu})}{\Gamma(\bar{B} \rightarrow X_u e \bar{\nu})} = 0.574 \pm 0.019 \quad \text{Gambino,Schwanda, arXiv:1307.4551}$$

- Collinear Photons give rise to log-enhanced QED corrections  $\alpha_{\text{em}} \log(m_b^2/m_\ell^2)$
- Higher powers of  $z$  in double differential decay width
  - Definition of  $H_i$  ? Sensitivity for QED observables ?

We use Legendre polynomials for  $H_T$  and  $H_L$  and  $\text{Sign}(z)$  for  $H_A$

We can construct QED sensitive observables (vanish in absence of QED) by Legendre projectors  $P_3(z)$  or  $P_4(z)$ :  $10^{-8}$

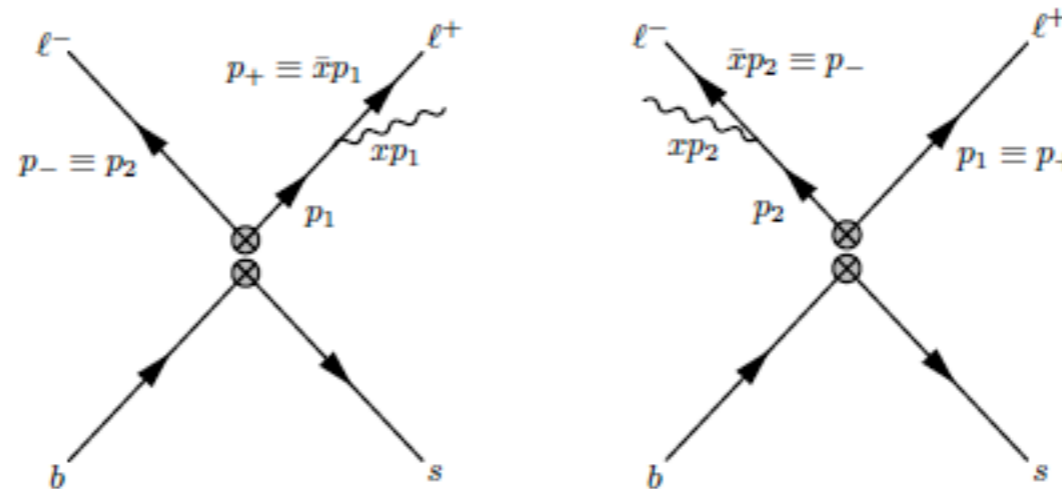

- Collinear Photons give rise to log-enhanced QED corrections  $\alpha_{\text{em}} \log(m_b^2/m_\ell^2)$
- Higher powers of  $z$  in double differential decay width
  - Definition of  $H_i$  ? Sensitivity for QED observables ?
- Size of logs depend on experimental set-up

$$q^2 = (p_{e^+} + p_{e^-})^2 \quad \text{vs.} \quad q^2 = (p_{e^+} + p_{e^-} + p_{\gamma,\text{coll}})^2$$

- We assume no photons are included in the definition of  $q^2$  (di-muon channel at Babar/Belle, di-electron at Belle)
- Babar's di-electron channel: Photons that are emitted in a cone of 35 mrad angular opening are included in  $q^2$

Monte Carlo techniques needed to estimate this effect

$$\frac{[\mathcal{B}_{ee}^{\text{low}}]_{q=p_{e^+}+p_{e^-}+p_{\gamma,\text{coll}}}}{[\mathcal{B}_{ee}^{\text{low}}]_{q=p_{e^+}+p_{e^-}}} - 1 = 1.65\%$$

$$\frac{[\mathcal{B}_{ee}^{\text{high}}]_{q=p_{e^+}+p_{e^-}+p_{\gamma,\text{coll}}}}{[\mathcal{B}_{ee}^{\text{high}}]_{q=p_{e^+}+p_{e^-}}} - 1 = 6.8\%$$

## Results

Low- $q^2$  ( $1\text{GeV}^2 < q^2 < 6\text{GeV}^2$ )

$$BR(B \rightarrow X_s ee) = (1.67 \pm 0.10) 10^{-6}$$

$$BR(B \rightarrow X_s \mu\mu) = (1.62 \pm 0.09) 10^{-6}$$

Babar:  $BR(B \rightarrow X_s ll) =$

$$= (1.60 (+0.41 - 0.39)_{stat} (+0.17 - 0.13)_{syst} (\pm 0.18)_{mod}) 10^{-6}$$

good agreement with SM

## Results

High- $q^2$ , Theory:  $q^2 > 14.4\text{GeV}^2$ , Babar:  $q^2 > 14.2\text{GeV}^2$

$$BR(B \rightarrow X_s ee) = (0.220 \pm 0.070) 10^{-6}$$

$$BR(B \rightarrow X_s \mu\mu) = (0.253 \pm 0.070) 10^{-6}$$

Babar:  $BR(B \rightarrow X_s ll) =$

$$(0.57 (+0.16 - 0.15)_{stat} (+0.03 - 0.02)_{syst}) 10^{-6}$$

$2\sigma$  higher than SM

Significant higher values predicted in Greub et al. due to missing power and QED corrections and different cut Greub,Pilipp,Schupbach,arXiv:0810.4077

(but perfect agreement if we use their prescriptions)

## Further refinement

Normalization to semileptonic  $B \rightarrow X_u l \nu$  decay rate **with the same cut** reduces the impact of  $1/m_b$  corrections in the high- $q^2$  region significantly.

Ligeti,Tackmann arXiv:0707.1694

Theory prediction for ratio

$$R(s_0)_{ee} = (2.25 \pm 0.31) 10^{-3}$$

$$R(s_0)_{\mu\mu} = (2.62 \pm 0.30) 10^{-3}$$

Largest source of error are CKM elements ( $V_{ub}$ )

Note: Additional  $O(5\%)$  uncertainty due to nonlocal power corrections  $O(\alpha_s \Lambda/m_b)$



**Further results** in units of  $10^{-6}$ 

$$H_L[1, 3.5]_{ee} = 0.64 \pm 0.03$$

$$H_L[1, 3.5]_{\mu\mu} = 0.68 \pm 0.04$$

$$H_L[3.5, 6]_{ee} = 0.50 \pm 0.03$$

$$H_L[3.5, 6]_{\mu\mu} = 0.53 \pm 0.03$$

$$H_L[1, 6]_{ee} = 1.13 \pm 0.06$$

$$H_L[1, 6]_{\mu\mu} = 1.21 \pm 0.07$$

$$H_T[1, 3.5]_{ee} = 0.29 \pm 0.02$$

$$H_T[1, 3.5]_{\mu\mu} = 0.21 \pm 0.01$$

$$H_T[3.5, 6]_{ee} = 0.24 \pm 0.02$$

$$H_T[3.5, 6]_{\mu\mu} = 0.19 \pm 0.02$$

$$H_T[1, 6]_{ee} = 0.53 \pm 0.04$$

$$H_T[1, 6]_{\mu\mu} = 0.40 \pm 0.03$$

$$H_A[1, 3.5]_{ee} = -0.103 \pm 0.005$$

$$H_A[1, 3.5]_{\mu\mu} = -0.110 \pm 0.005$$

$$H_A[3.5, 6]_{ee} = +0.073 \pm 0.012$$

$$H_A[3.5, 6]_{\mu\mu} = +0.067 \pm 0.012$$

$$H_A[1, 6]_{ee} = -0.029 \pm 0.016$$

$$H_A[1, 6]_{\mu\mu} = -0.042 \pm 0.016$$

Total error  $\mathcal{O}(5 - 8\%)$ . Still dominated by scale uncertainty.