

LabVIEW and the LHC



The Large Hadron Collider



Rapid Application Development Environment



based on LabVIEW

Outline

- MTA
- Why RADE?
- The challenge
- The Scope
- Coping with large applications
- RADE today
- Future

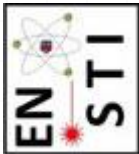

EN-STI-ECE-MTA

**Measurements
Tests &
Analysis**

 Sofia Lina ALDOSA BAZQUEZ	 Odd Eystein ANDRÉSSON	 Antoine BENOIT	 Anja BLANCO ALONSO	 Olivier CHARDONNIERE	 Alicia DE DIOS FUENTE	 Kevin DEVILLE
 Christophe André DIONISIO BARRETO	 Paula FERNÁNDEZ LÓPEZ	 Maria de Fatima GÓMEZ DE LA CRUZ	 Robert KALLAI	 Philippe Roger MALAORNE	 Takuo Tapani MATSUDA	
 Rikke HØRCK KNUDSEN	 Urszula Olivia MIŁOZINSKA	 Jakub Wojciech RACHUŁKI	 Eric RASOASEHO DI MICHEL	 Hubert REYMOND	 Adrican RULLART	 Joseph TAGG

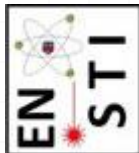

labview.support@cern.ch

Outline

- MTA
- Why RADE?
- The challenge
- The Scope
- Coping with large applications
- RADE today
- Future

Why was RADE developed?

The Origin



- 10.000+ Magnets
- 1750 Circuits
- 13000+ Tests

Outline

- MTA
- Why RADE?
- The challenge
- Coping with large applications
- RADE today
- Future

The Challenge

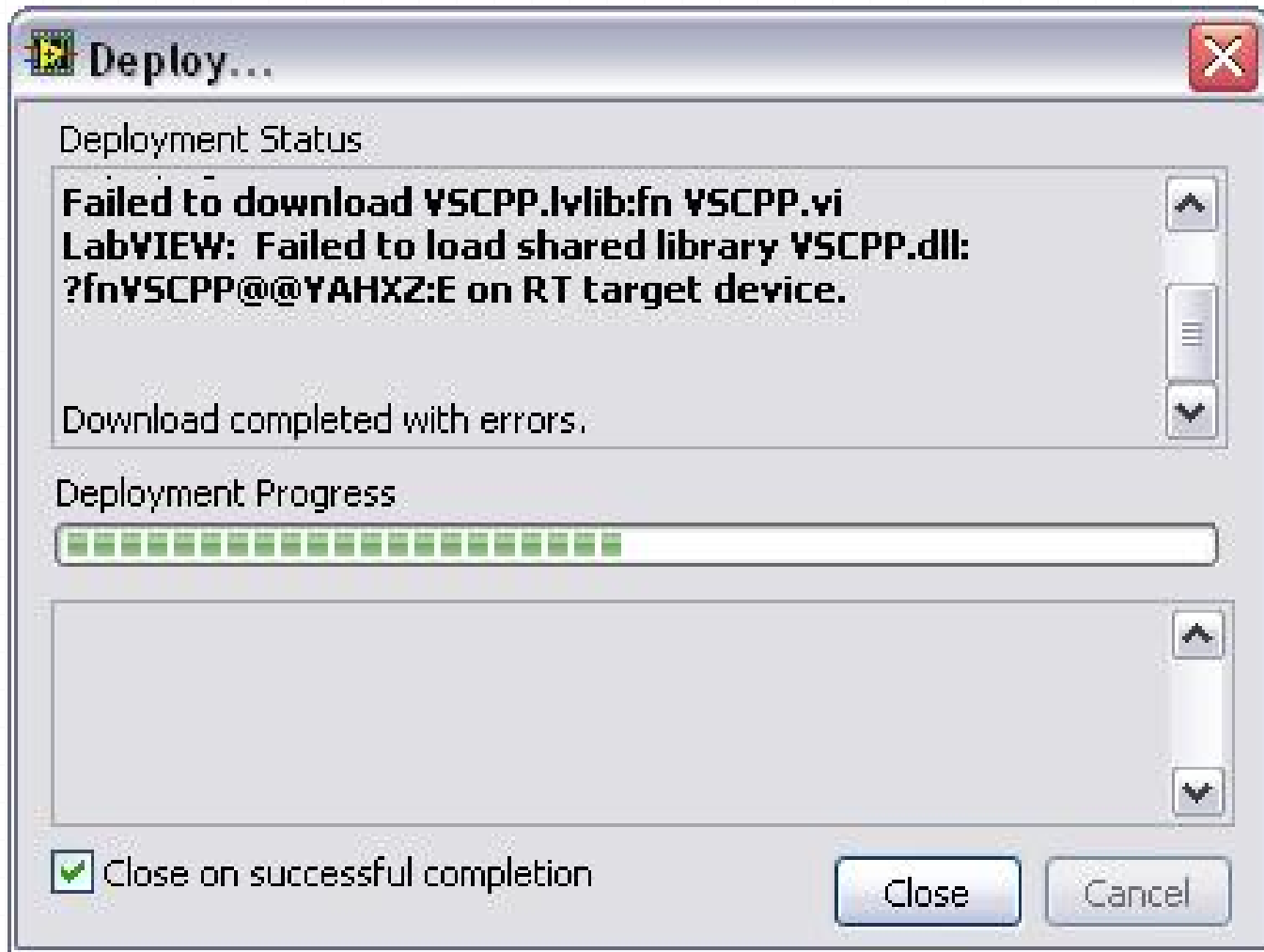

The Challenge

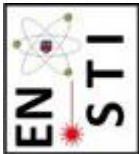
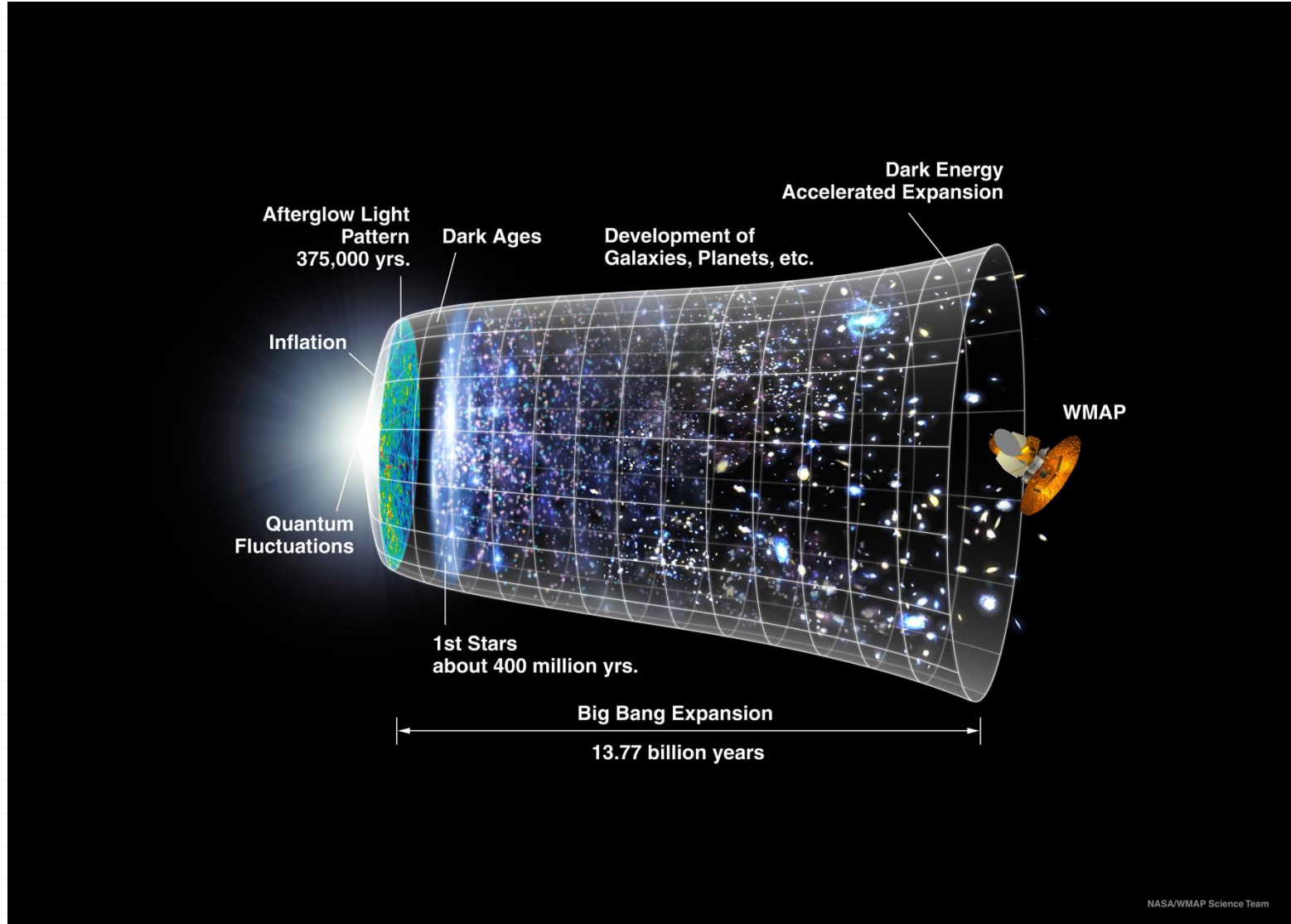

The Challenge



Linux

Windows

Mac

GPN

TN



DB

CM
W

RBA
C

Timing

Files

PLC

DAQ

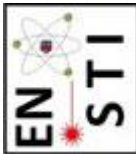
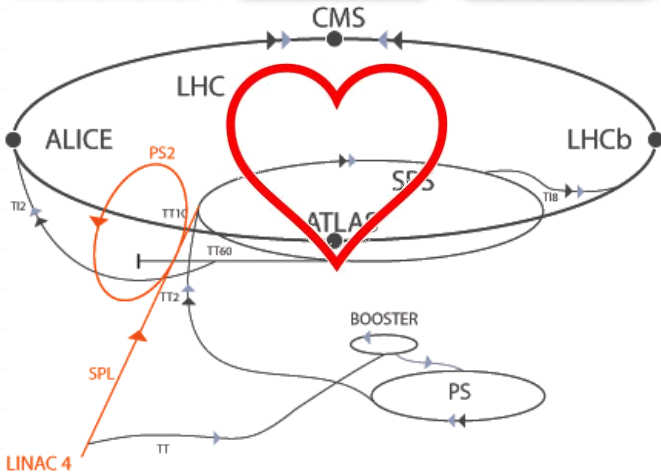

RAD(E)

RAD(E) (rapid application development) is a concept that products can be developed faster and of higher quality through:

- Gathering requirements
- Prototyping
- Defer design improvements to the next release
- Less formality in reviews and communication
- Re-use of software components

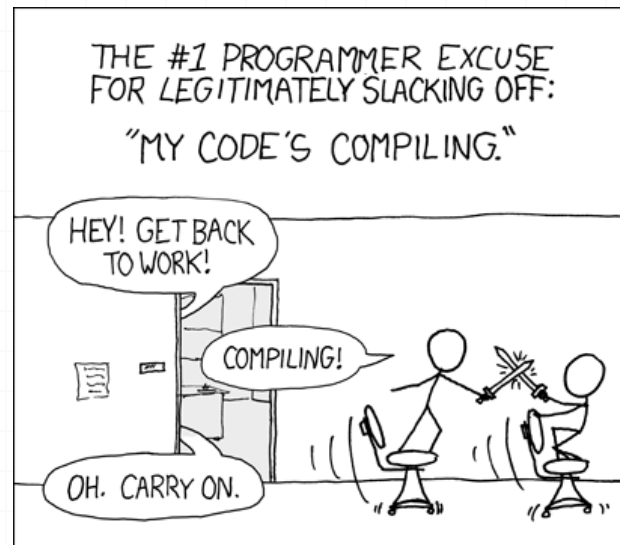

Development Methods

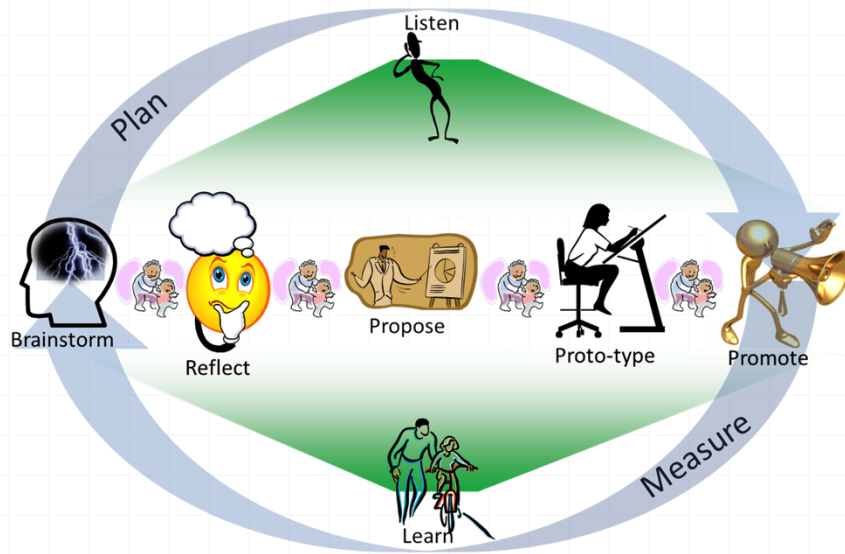

Extreme Programming methods

- Small increments
- Minimal planning
- Cross-functional team working on all aspects
- Demonstrated to the stakeholders frequently
- Minimizing risks
- Fast changes and adaptations.

Outline

- MTA
- Why RADE?
- The challenge
- The Scope
- Coping with large applications
- RADE today
- Future

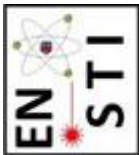

Application characteristics:

- Short development time
- Rapidly evolving
- Light and independent

The Scope

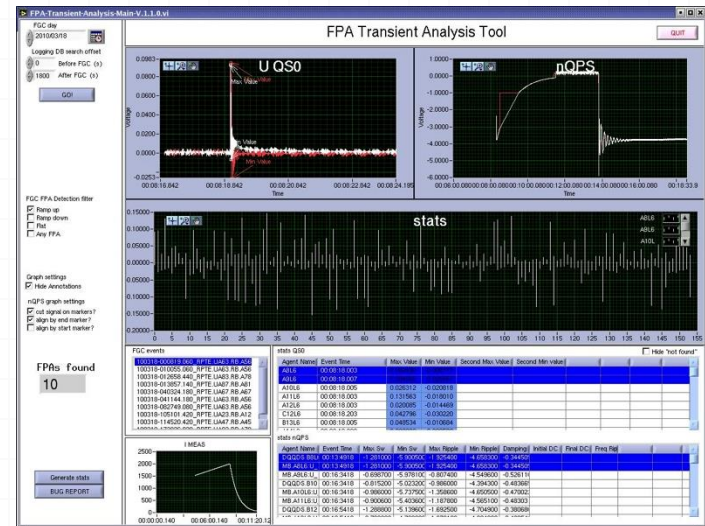
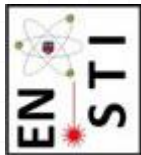

Initial Requirements

- Fast programming
- Rapid learning curve
- Drag and drop GUI development
- Wide range of analysis libraries
- Light/independent environment
- Integration with CERN infrastructures

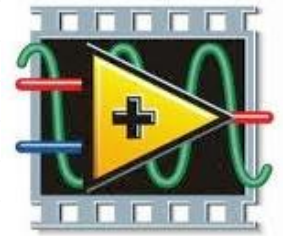

LabVIEW



RADE Palette

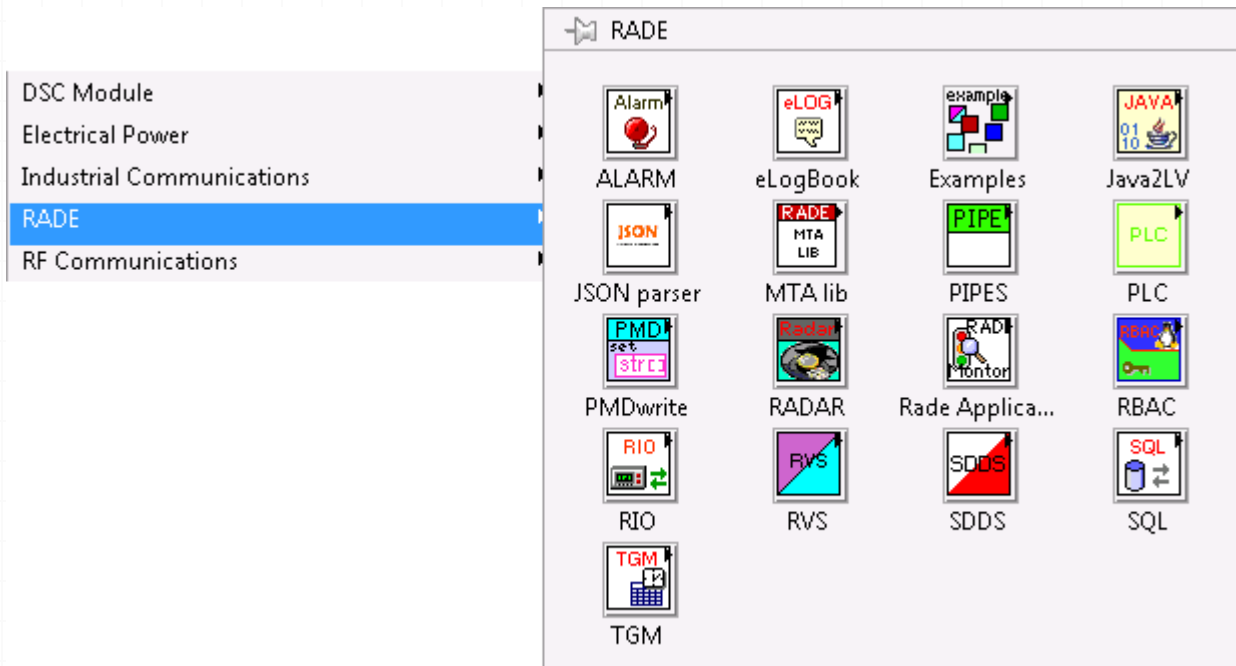

RADE Core Technology

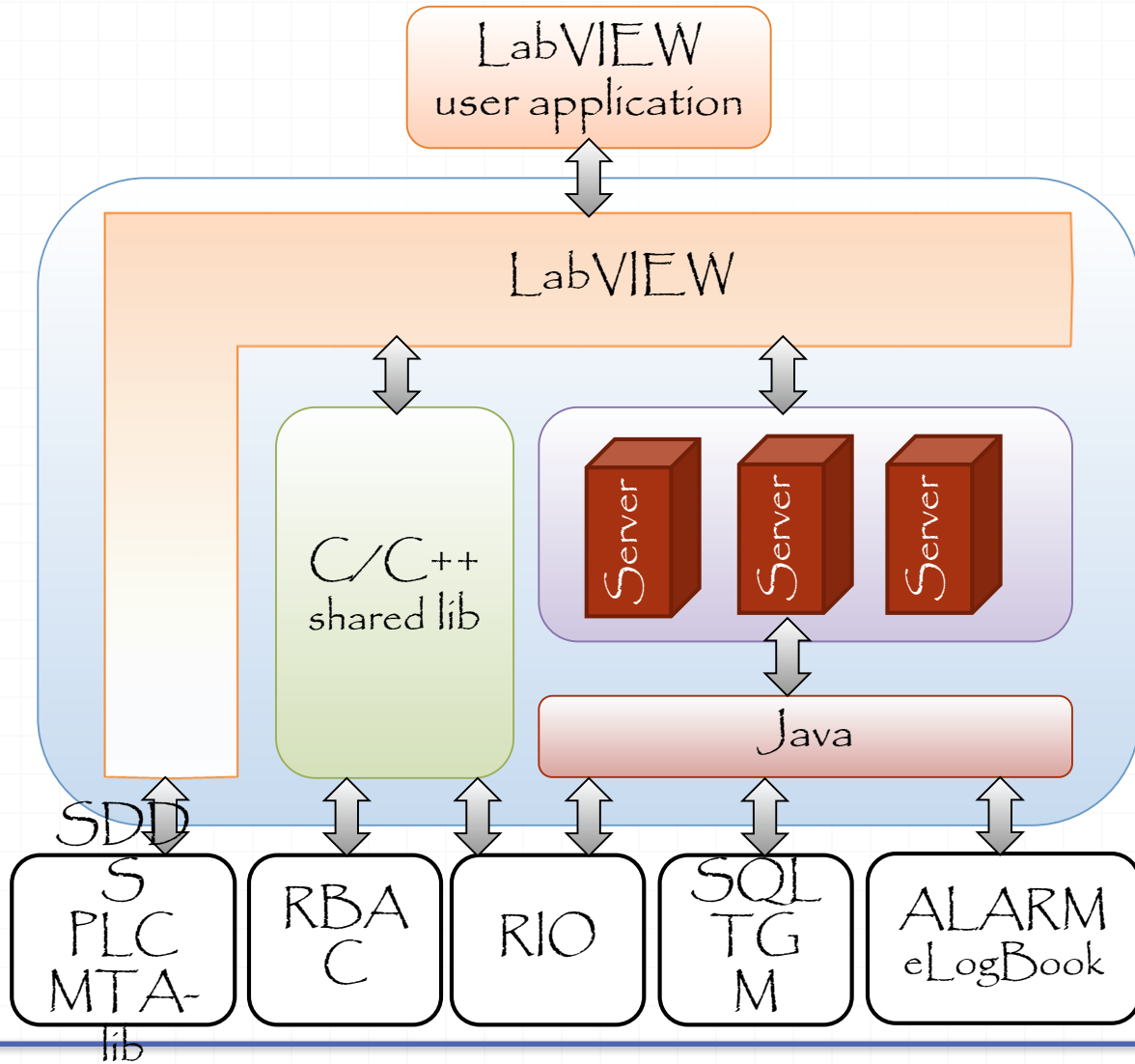

Sources, Targets and Interactions

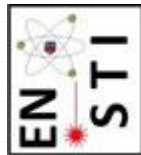

RADE Applications

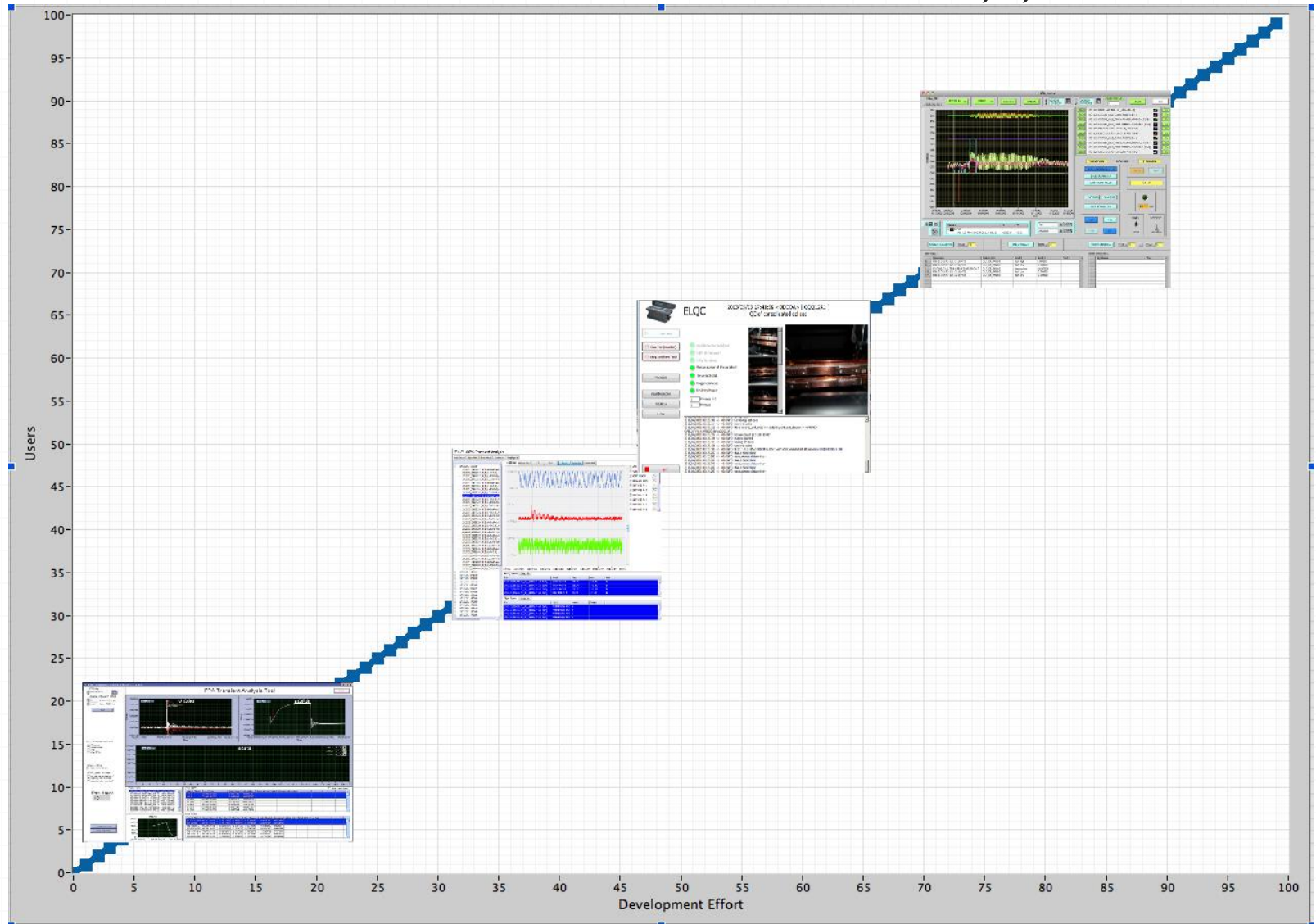

Outline

- MTA
- Why RADE?
- The challenge
- The Scope
- Coping with large applications
- RADE today
- Future

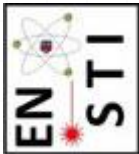

Coping With Large Applications

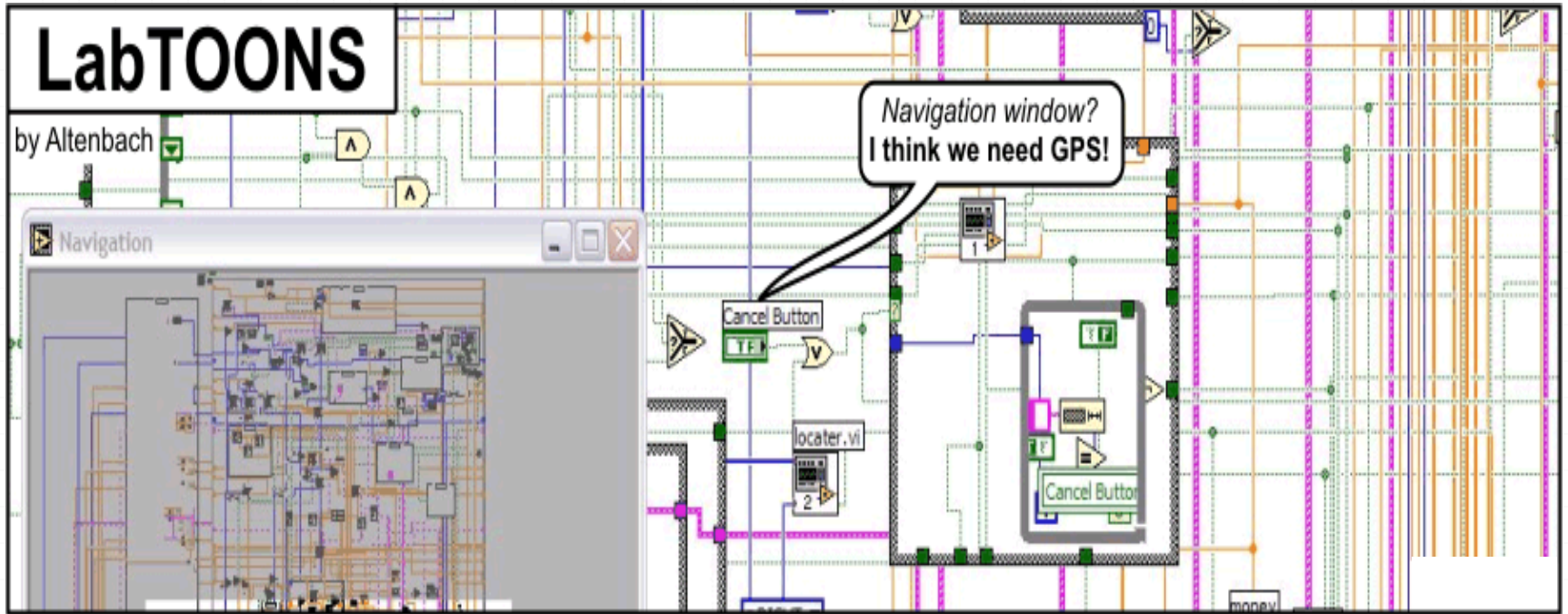

Large Application Requirements

Sources, Targets and Interactions

- Fast programming
- Rapid learning curve
- Drag and drop GUI development
- Wide range of analysis libraries
- Light/independent environment
- Integration with CERN infrastructures
- **Source control and distribution**
- **Instance generation**
- **Templates and documentation**
- **Automated tests and builds**

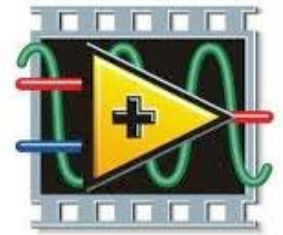

LabVIEW



Source Control



This screenshot shows the LabVIEW source control interface. On the left, three block diagrams are displayed in a 'Compare' view, with red circles highlighting differences between the 'Thurs - developer 1.vi', 'Base - base.vi', and 'Yours - developer 2.vi' versions. The central pane shows a 'Message' window with a list of changes. The foreground shows the 'My VI.vi Front Panel' window with the 'Tools' menu open, highlighting the 'TortoiseSVN' option. A red arrow labeled 'New Menu' points to the 'TortoiseSVN' menu, which contains options like 'Update...', 'Commit...', 'Update to Revision...', 'Revert...', 'Add...', 'Rename...', 'Delete...', 'Lock...', 'Unlock...', 'Show Log...', and 'About JKI TSVN Tool...'. The 'Commit...' option is highlighted with a mouse cursor.

This screenshot shows the context menu for TortoiseSVN. The 'Collapse' section is expanded, showing options like 'Explore', 'Open', 'Search...', 'Open as Notebook in OneNote', 'Sharing and Security...', 'SVN Checkout...', and 'TortoiseSVN'. The 'TortoiseSVN' sub-menu is open, displaying options such as 'Repo-browser', 'Export...', 'Create repository here', 'Import...', 'Settings', 'Help', and 'About'. The 'Send To' menu is also visible, showing 'Export...' and 'Import...' options.



Continuous Integration

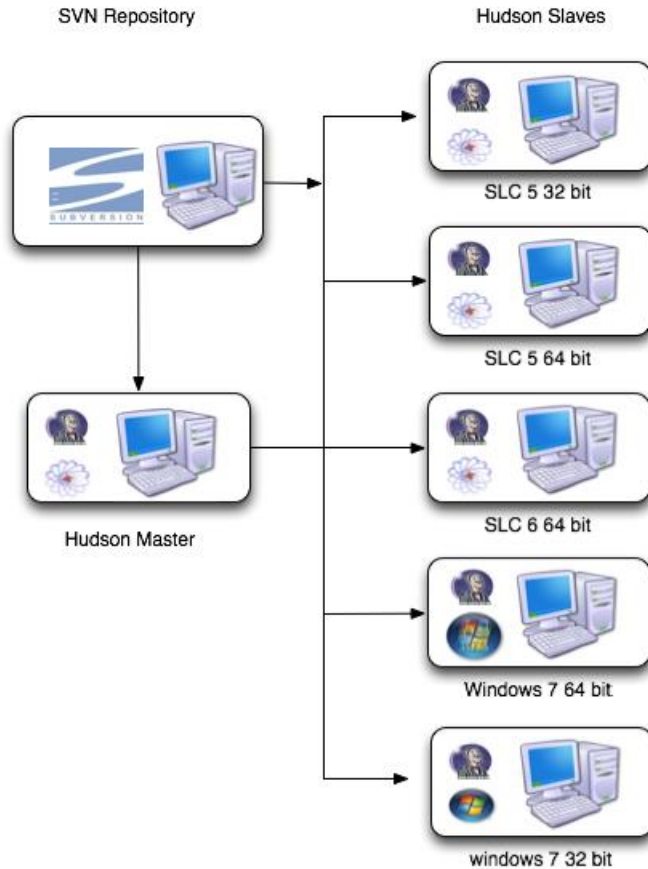

Linux Windows and Mac
Open stack and VPN



Continuous Integration

Hudson

search pma | log out

ENABLE AUTO REFRESH

add description

Hudson

New Job

Manage Hudson

People

Build History

New View

My Views

Build Queue

0-Build_RADE_Release_win	✖
0-Build_RADE_Release_mac	✖
cmww_win7_64	✖
Unittest-MI	✖
TGM-MI	✖
Templates-MI	✖
SQL-MI	✖
SDDS-MI	✖
RVS-MI	✖
RIO-DIMWrapper-MI	✖
RIO-CMWWrapper-MI	✖
RBAC-MI	✖
RADAR-MI	✖
PMDwrite-MI	✖
PLC-MI	✖
PIPES-MI-Template	✖
MTA-lib-MI	✖
JSON-MI	✖
Jars2LV-MI	✖
FESA-MI	✖
examples-MI	✖

<http://abcopm04-8080/hudson/queue/item/2860/cancelQueue>

All	Backup Hudson jobs	JavaBuilds	Linux library test	RADE builds	Windows library test	cpp builds	+
S	W	Job ↓	Last Success	Last Failure	Last Duration	Console	
●	☀	0-Build_RADE_all	6 days 20 hr (#24)	N/A	0.25 sec	📄	🔄
●	☀	0-Build_RADE_Release_linux	1 mo 4 days (#33)	20 days (#46)	50 min	📄	🔄
●	☀	0-Build_RADE_Release_mac	4 mo 5 days (#28)	20 days (#56)	12 min	📄	🔄
●	☀	0-Build_RADE_Release_win	1 mo 4 days (#17)	20 days (#29)	41 min	📄	🔄
●	☀	ALARM-MI	19 days (#489)	N/A	15 min	📄	🔄
●	☀	ALARM-Windows-MI	19 days (#223)	N/A	11 min	📄	🔄
●	☀	Backup-jobs	2 days 20 hr (#502)	20 hr (#504)	0.33 sec	📄	🔄
●	☀	cmww_SLC5	20 hr (#165)	N/A	2 min 3 sec	📄	🔄
●	☀	cmww_SLC6	19 days (#108)	N/A	8 min 38 sec	📄	🔄
●	☀	cmww_win7_64	N/A	1 day 20 hr (#44)	16 min	📄	🔄
●	☀	CO-MI	19 days (#443)	N/A	8 min 41 sec	📄	🔄
●	☀	CO-Windows-MI	19 days (#453)	N/A	54 sec	📄	🔄
●	☀	DBService-build	20 hr (#417)	N/A	16 min	📄	🔄
●	☀	DIPService_1_0_0-Build	20 hr (#387)	N/A	27 min	📄	🔄
●	☀	eLogBook-MI	19 days (#291)	N/A	16 min	📄	🔄
●	☀	eLogBook-Windows-MI	19 days (#225)	N/A	10 min	📄	🔄
●	☀	examples-MI	19 days (#421)	N/A	8 min 45 sec	📄	🔄
●	☀	examples-Windows-MI	19 days (#393)	N/A	59 sec	📄	🔄
●	☀	FESA-MI	19 days (#424)	N/A	9 min 8 sec	📄	🔄
●	☀	FESA-Windows-MI	19 days (#404)	N/A	2 min 5 sec	📄	🔄
●	☀	InCA-prev-build	20 hr (#378)	N/A	8 min 33 sec	📄	🔄
●	☀	InCa_1_0_1-Build	19 hr (#418)	N/A	20 min	📄	🔄
●	☀	JAPC_RDA_BLM_1_0_0-Build	3 days 19 hr (#450)	19 hr (#453)	10 min	📄	🔄
●	☀	Jars2LV-MI	19 days (#421)	N/A	8 min 41 sec	📄	🔄
●	☀	Java2LV-Windows-MI	19 days (#399)	N/A	59 sec	📄	🔄
●	☀	JSON-MI	19 days (#299)	N/A	13 min	📄	🔄
●	☀	LSA_1_0_0-Build	3 days 19 hr (#89)	19 hr (#92)	17 min	📄	🔄
●	☀	LVSservice-build	19 hr (#380)	N/A	9 min 0 sec	📄	🔄
●	☀	MTA-lib-MI	19 days (#419)	N/A	13 min	📄	🔄



Continuous Integration



Project

CURRENT PROJECT
EN Industrial Control...

Manage Compute

- Overview
- Instances
- Volumes
- Images & Snapshots
- Access & Security

[Logged in as: oddoa](#)
[Settings](#)
[Help](#)
[Submit a ticket](#)
[Sign Out](#)

Overview

Limit Summary



Instances
Used 28 of 100



VCPUs
Used 67 of 100



RAM
Used 134.0 GB of 250.0 GB



Available Volumes
Used 0 of 0



Available Volume Storage
Used 0 of 4.9TB

Select a period of time to query its usage:

From: To: The date should be in YYYY-mm-dd format.

Active Instances: 29 Active RAM: 142GB This Period's VCPU-Hours: 575.17 This Period's GB-Hours: 34510.22

Usage Summary

Instance Name	VCPUs	Disk	RAM	Uptime
cvi-analytics-svr	4	80	8GB	6 months
cvi-bip-fv	4	80	8GB	6 months
cvi-icenexus	2	40	4GB	5 months
cvw-piquet01	2	40	4GB	4 months, 1 week

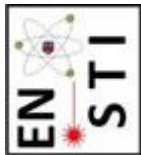

Continuous Integration

Preference for cloud platform
Buyer responses (cloud infrastructure implemented/planned)

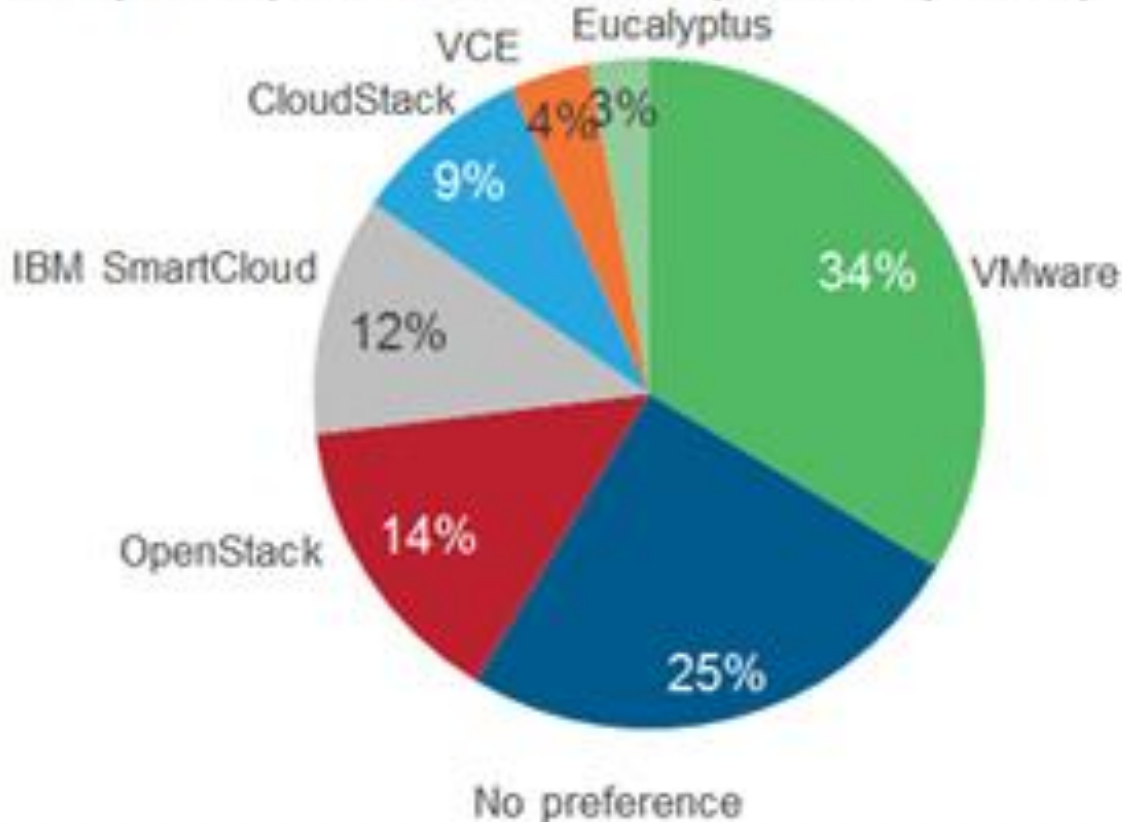

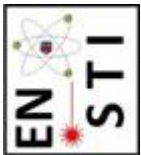

Continuous Integration

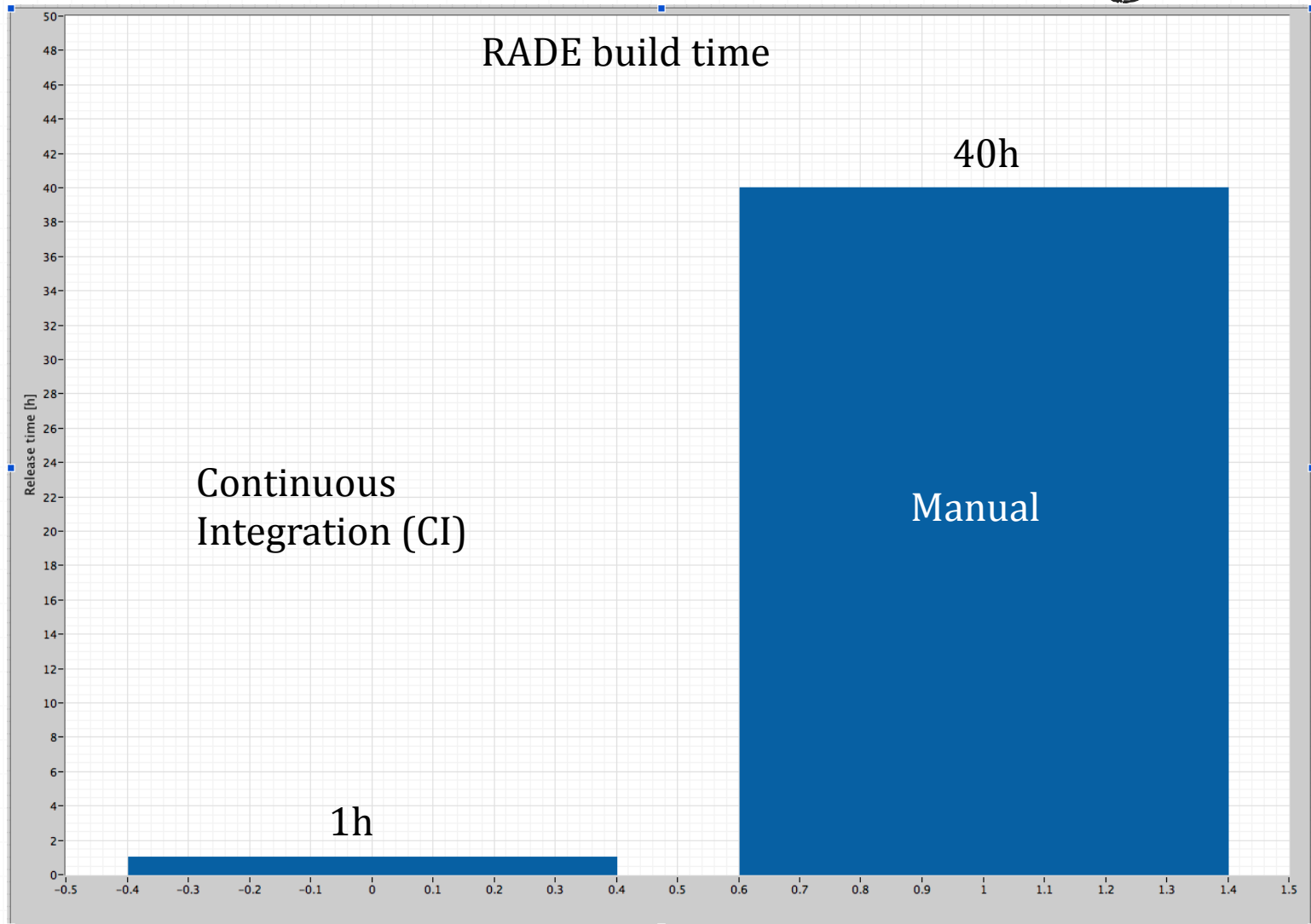

Software repository

The screenshot displays the Nexus Repository Manager OSS web interface. The top navigation bar includes the Sonatype logo and the text "Nexus Repository Manager OSS". The main content area is divided into several sections:

- Repositories Table:** A table listing various repositories with columns for Repository, Type, Health Check, Format, Policy, Repository Status, and Repository Path. The "Releases" repository is highlighted.
- Releases Section:** A sub-section with tabs for "Browse Index", "Browse Storage", "Configuration", "Routing", "Summary", and "Artifact Upload".
- Artifact Details:** A detailed view of a Maven artifact with the following information:
 - Group: rade.Library.Mac.2015
 - Artifact: CO
 - Version: CO-1.1.0
 - Extension: tar.gz
 - XML: `<dependency>
<groupId>rade.Library.Mac.2015</groupId>`



Nexus





Distribution

EN Home / Frameworks / RADE / RADE-Getting-Started / RADE-install Tools ▾

RADE-install

Added by Unknown User (atarasen), last edited by Odd Oyvind Andreassen on Feb 10, 2014 (view change)

Home Getting Started Libraries Download Support Glossary

RADE is available through CMF.

If your computer doesn't have the CMF agent installed you can get RADE from the locations linked below.

	Windows	Linux Local (64 bit)	Linux Local (32 bit)	Linux (NFS)	Mac OSX
LabVIEW 2010	RADE 10	RADE 10	RADE 10	RADE is installed centrally	RADE 10 OSX DMG
LabVIEW 2011	RADE 11	RADE 11	RADE 11	RADE is installed centrally	RADE 11 OSX DMG
LabVIEW 2012	RADE 12	RADE 12	RADE 12	RADE is installed centrally	RADE 12 OSX DMG
LabVIEW 2013	RADE 13	RADE 13	RADE 13	RADE is installed centrally	RADE 13 OSX DMG

- If the installation doesn't start automatically run RADE_13.exe from \\cern.ch\dfs\Services\PMA\rade\builds\RADE_13.exe

Beta-version of RADE for LabVIEW-2010

Windows	Linux
Windows version	RADE-10-beta.rpm

Installing on Mac



The mac package is not signed so in order to install the RADE framework on your machine you have to allow all applications in your security settings (Preferences >> Security & Privacy):

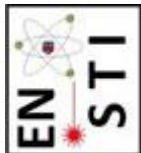

Online Installer



Distribution

RADE-Installer.vi rev. 145

Log In  Add  LabVIEW version

LV version  Remove  Nexus 

Name	Category	Local version	Remote version	Status	Developer	Source
MTA Lib				not installed	oddoa	
RBAC				not installed	oddoa	
JAPC				not installed	vshaipov	
RADAR				not installed	vshaipov	
CMW Wrapper				not installed	ostrue	

00:49:40.767 --> executing: core:idle

RADE Installer

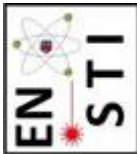

Distribution

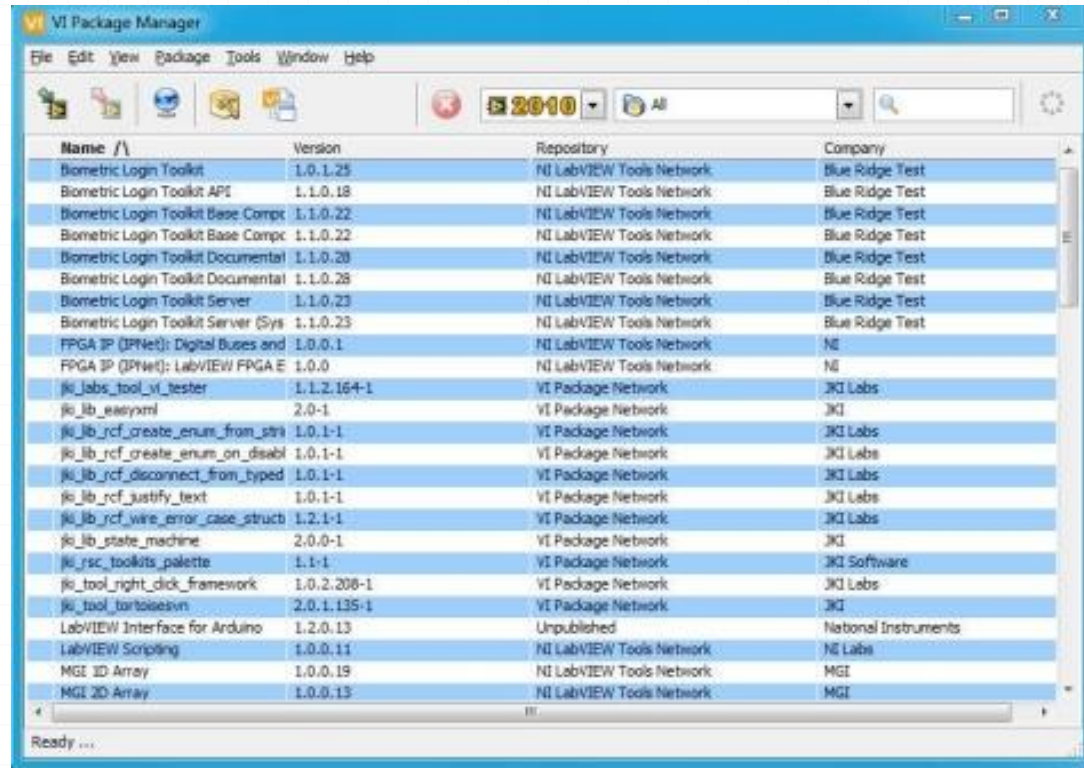

Name \ /	Version	Repository	Company
Biometric Login Toolkit	1.0.1.25	NI LabVIEW Tools Network	Blue Ridge Test
Biometric Login Toolkit API	1.1.0.18	NI LabVIEW Tools Network	Blue Ridge Test
Biometric Login Toolkit Base Comp	1.1.0.22	NI LabVIEW Tools Network	Blue Ridge Test
Biometric Login Toolkit Base Comp	1.1.0.22	NI LabVIEW Tools Network	Blue Ridge Test
Biometric Login Toolkit Documental	1.1.0.28	NI LabVIEW Tools Network	Blue Ridge Test
Biometric Login Toolkit Documental	1.1.0.28	NI LabVIEW Tools Network	Blue Ridge Test
Biometric Login Toolkit Server	1.1.0.23	NI LabVIEW Tools Network	Blue Ridge Test
Biometric Login Toolkit Server (Sys	1.1.0.23	NI LabVIEW Tools Network	Blue Ridge Test
FPGA IP (IPNet): Digital Buses and	1.0.0.1	NI LabVIEW Tools Network	NI
FPGA IP (IPNet): LabVIEW FPGA E	1.0.0	NI LabVIEW Tools Network	NI
jki_labs_tool_vi_tester	1.1.2.164-1	VI Package Network	JKI Labs
jk_lib_easyxml	2.0-1	VI Package Network	JKI
jk_lib_rcf_create_enum_from_str	1.0.1-1	VI Package Network	JKI Labs
jk_lib_rcf_create_enum_on_disabl	1.0.1-1	VI Package Network	JKI Labs
jk_lib_rcf_disconnect_from_typed	1.0.1-1	VI Package Network	JKI Labs
jk_lib_rcf_justify_text	1.0.1-1	VI Package Network	JKI Labs
jk_lib_rcf_wire_error_case_struct	1.2.1-1	VI Package Network	JKI Labs
jk_lib_state_machine	2.0.0-1	VI Package Network	JKI
jk_rsc_toolkits_palette	1.1-1	VI Package Network	JKI Software
jk_tool_right_click_framework	1.0.2.208-1	VI Package Network	JKI Labs
jk_tool_tartoisevn	2.0.1.135-1	VI Package Network	JKI
LabVIEW Interface for Arduino	1.2.0.13	Unpublished	National Instruments
LabVIEW Scripting	1.0.0.11	NI LabVIEW Tools Network	NI Labs
MGE 3D Array	1.0.0.19	NI LabVIEW Tools Network	MGE
MGE 2D Array	1.0.0.13	NI LabVIEW Tools Network	MGE

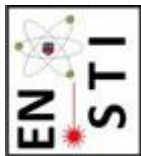

Dedicated Templates

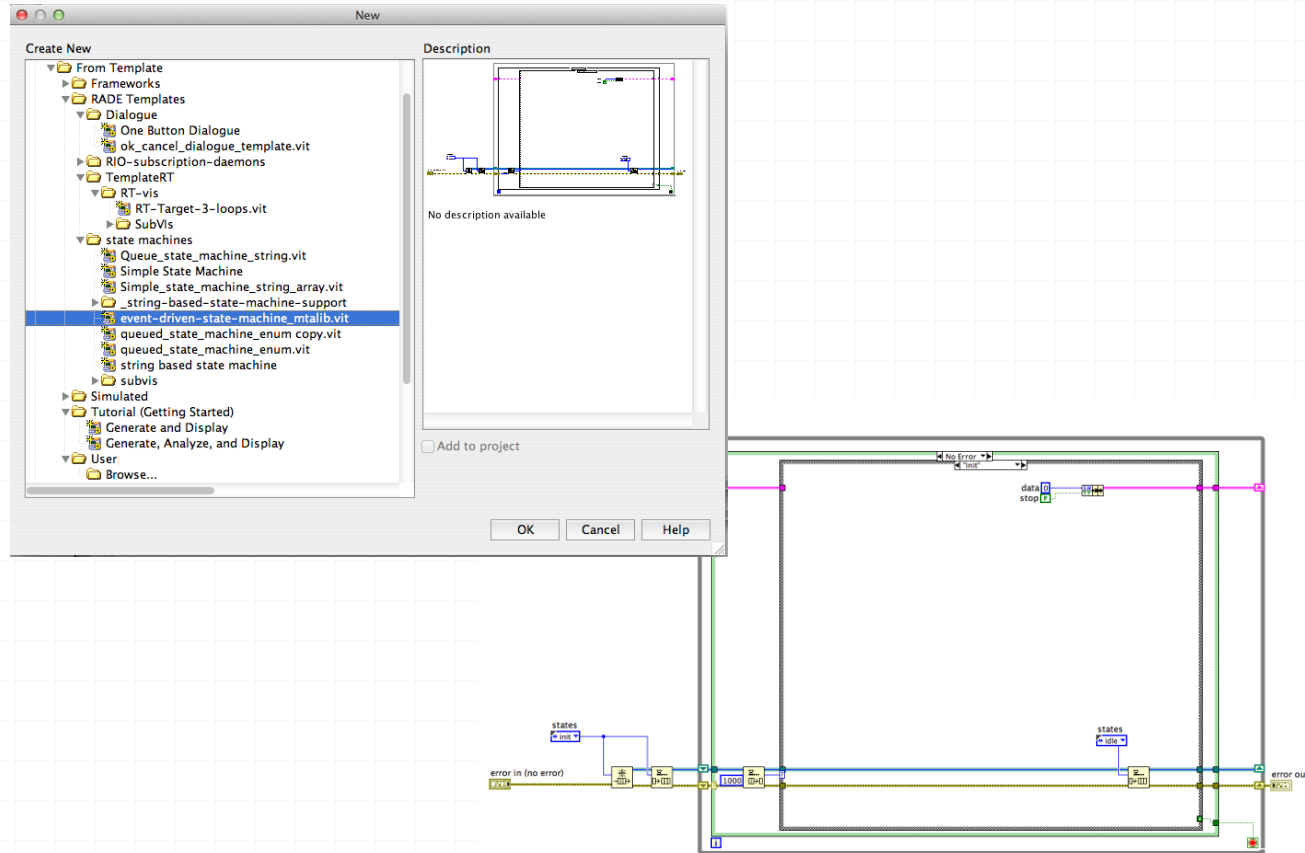

Project Generation

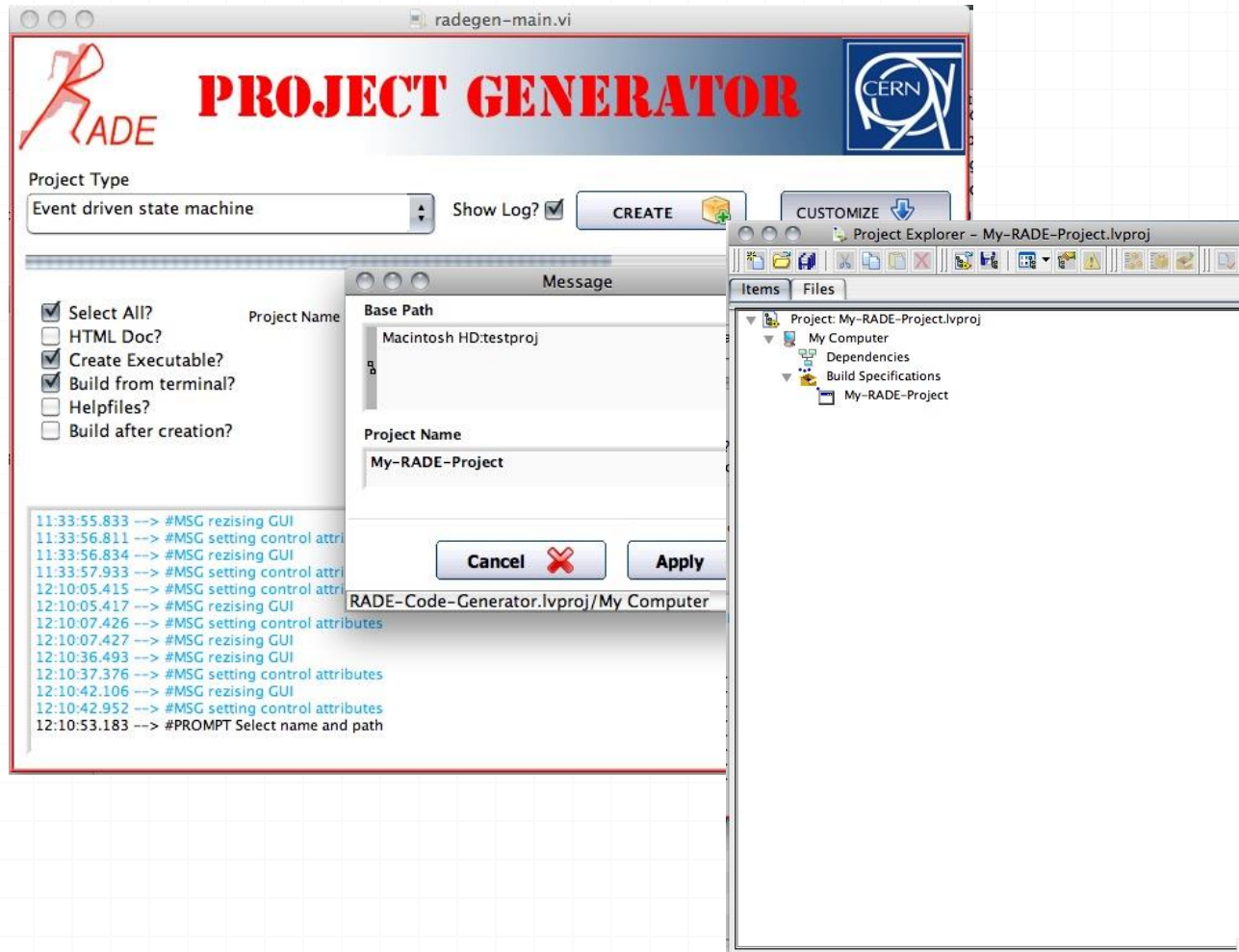

Typical design

Create, Use & Destroy

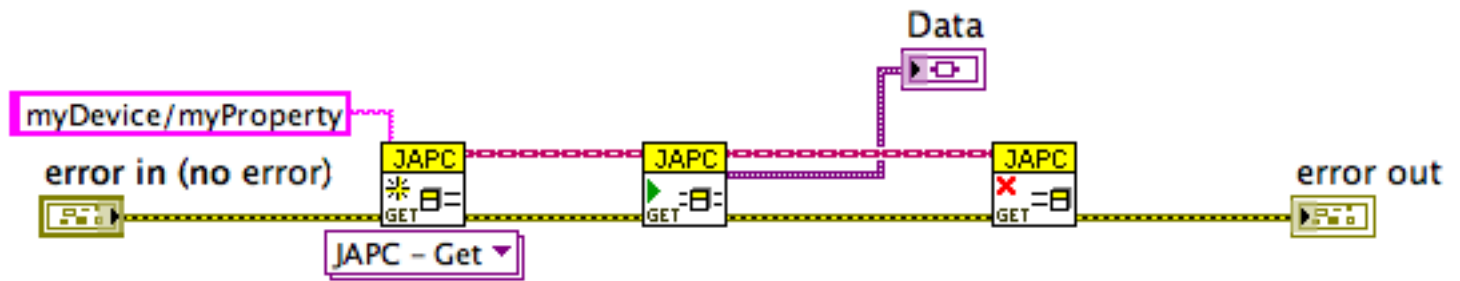

Development help

- Design patterns and templates in RADE
- LabVIEW Guides
<http://j2eeps.cern.ch/wikis/display/EN/LabVIEW+Guides>
- Code review: make maintainable, and performant

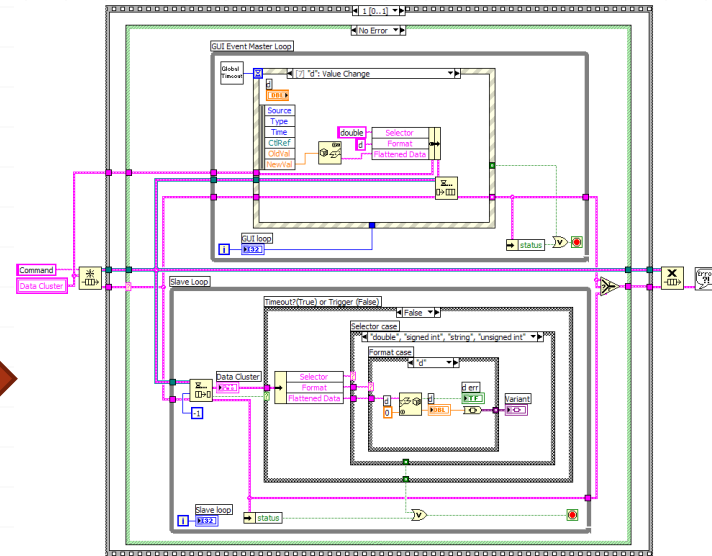
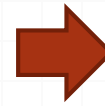
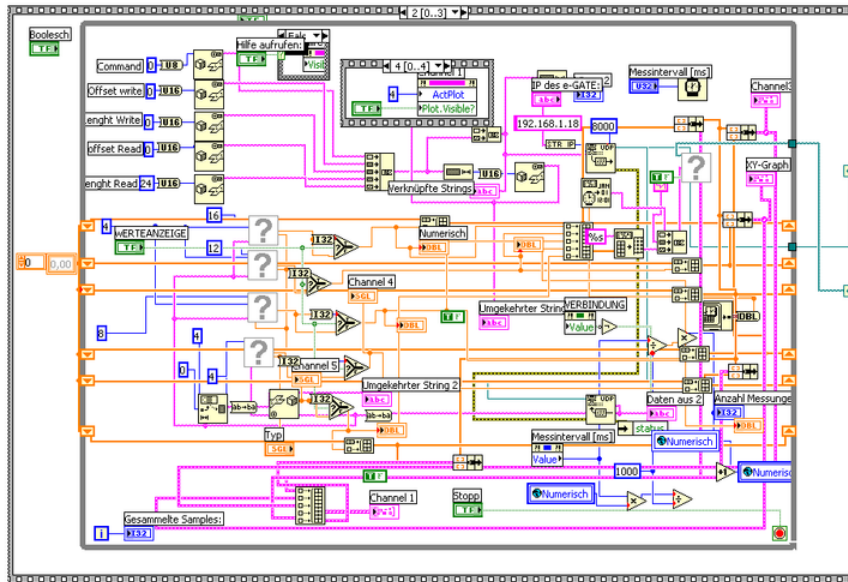

Peer Programming

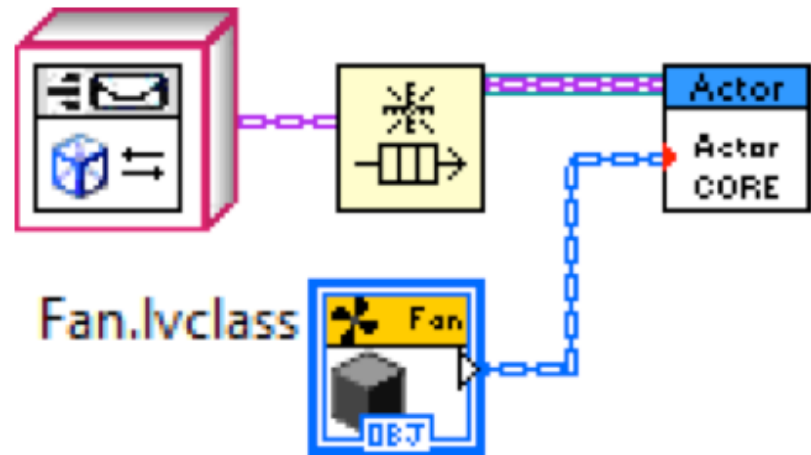
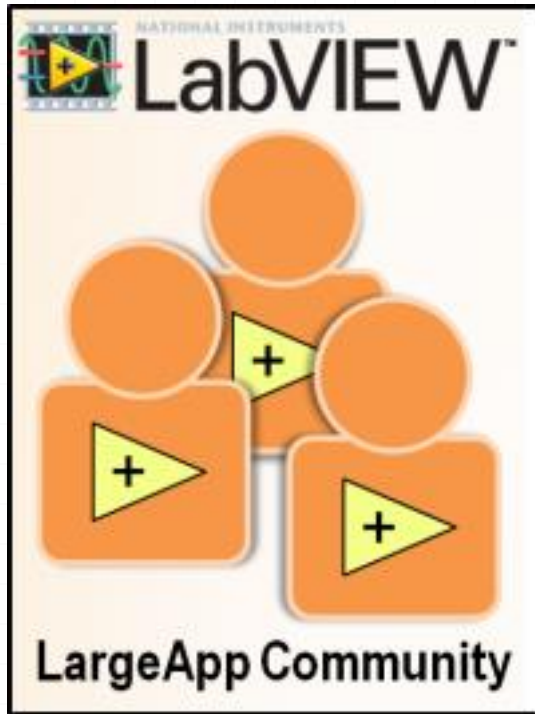

The missing link

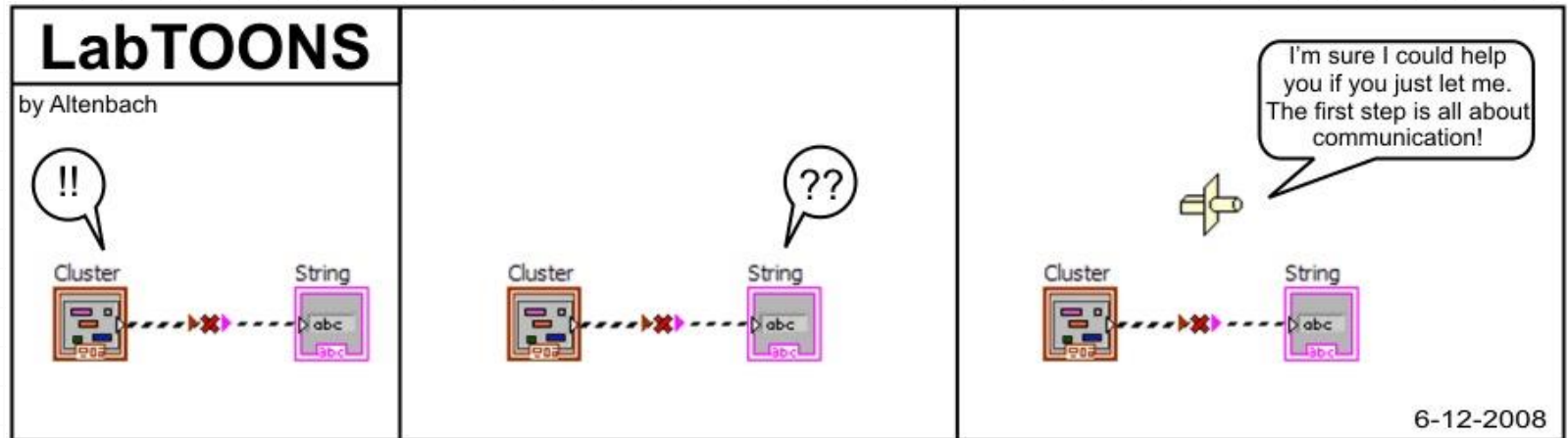

Middleware integration



Operators

Clients

- RIO palette (Rade Input/Output)
 - Get, Set and Subscribe



Server

- Device/property/field definitions

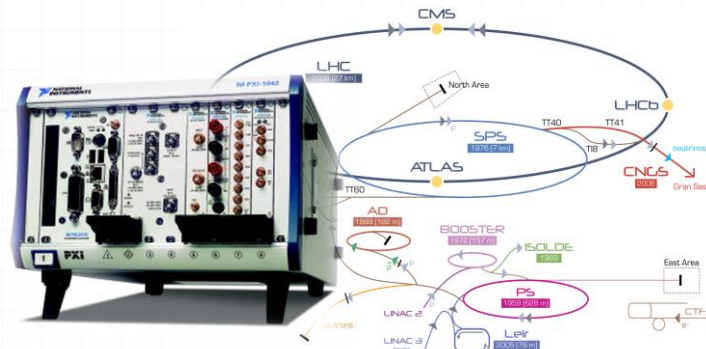

PXI on the accelerator complex

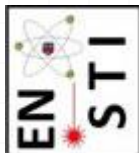

Distributed Architecture

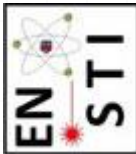
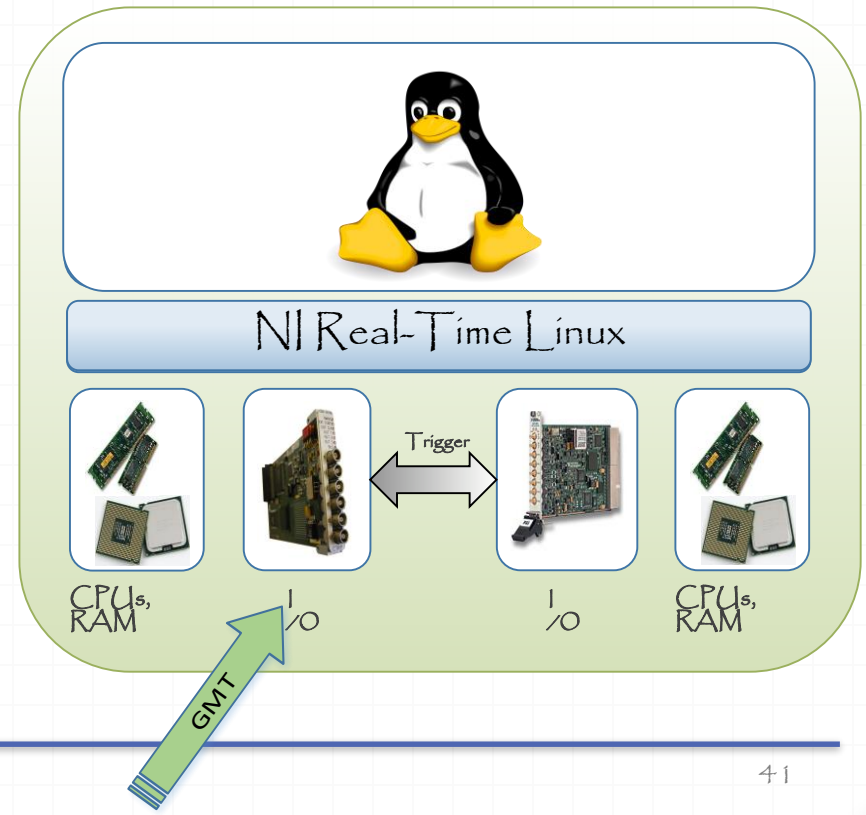
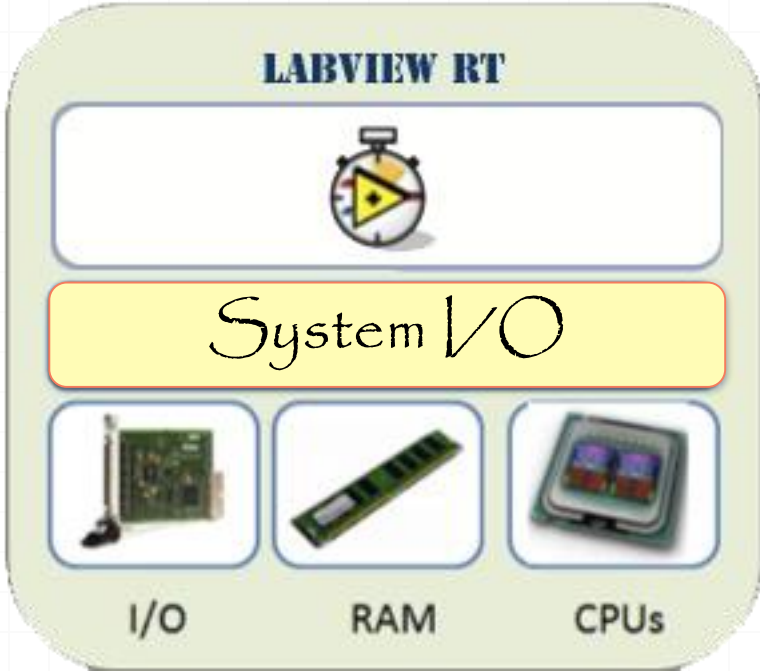

Outline

- MTA
- Why RADE?
- The challenge
- The Scope
- Coping with large applications
- RADE today
- Future

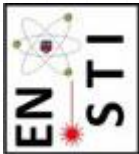

RADE today



- RADE has become adult
- LabVIEW has started getting out of the Lab
- Copes with the classical software development challenges
- Enables LabVIEW to be used for accelerator applications

The Framework

Sources, Targets and Interactions

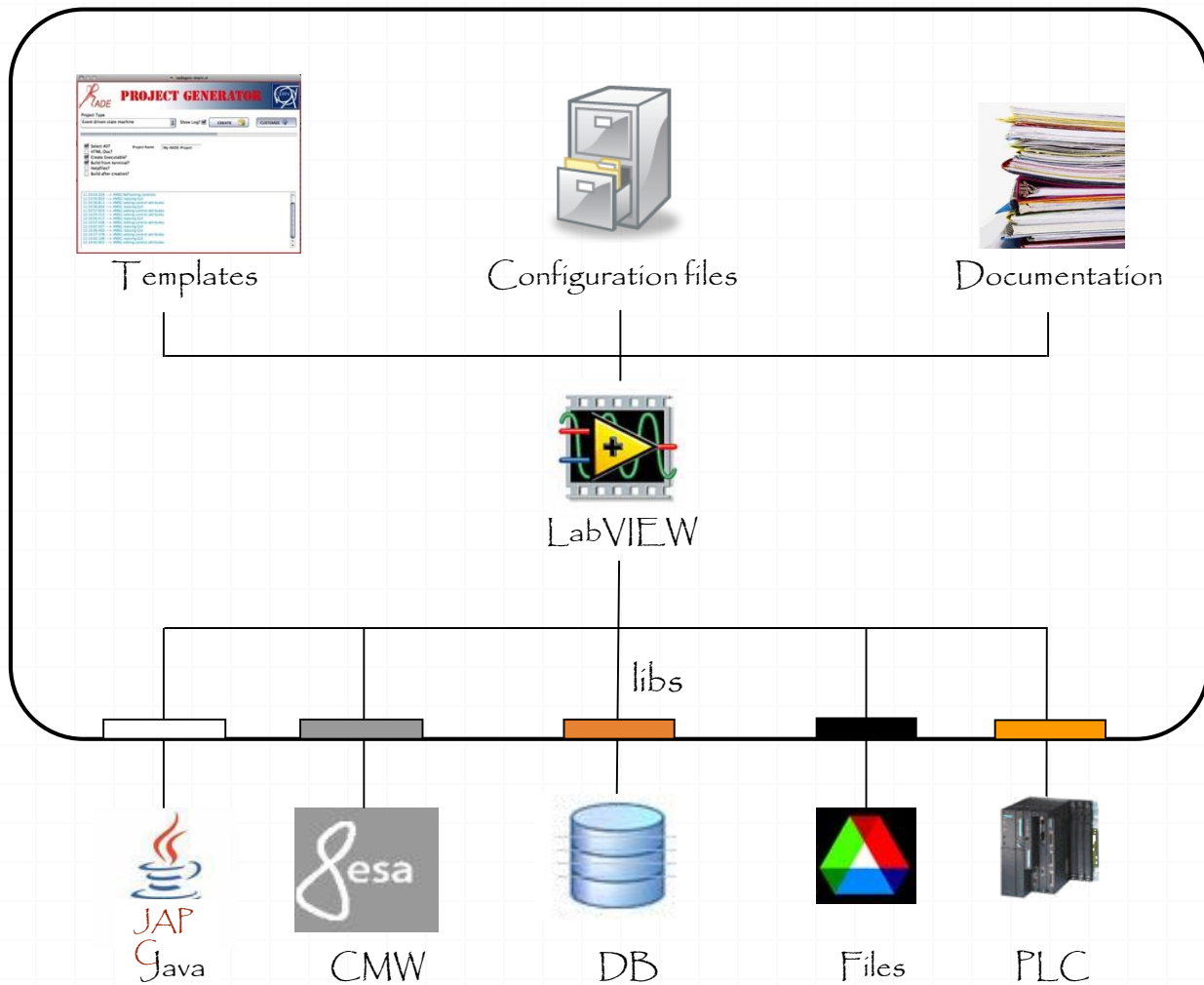

Training



Support

Hardware Support



Hardware



- PXI
- CompactRIO
- DAQ



&

Software



- LabVIEW
- TestStand
- DIAdem
- and other NI products

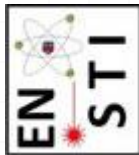

Outline

- MTA
- Why RADE?
- The challenge
- The Scope
- Coping with large applications
- RADE today
- Future

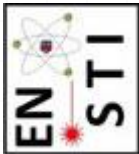

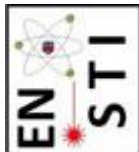

Future Challenges

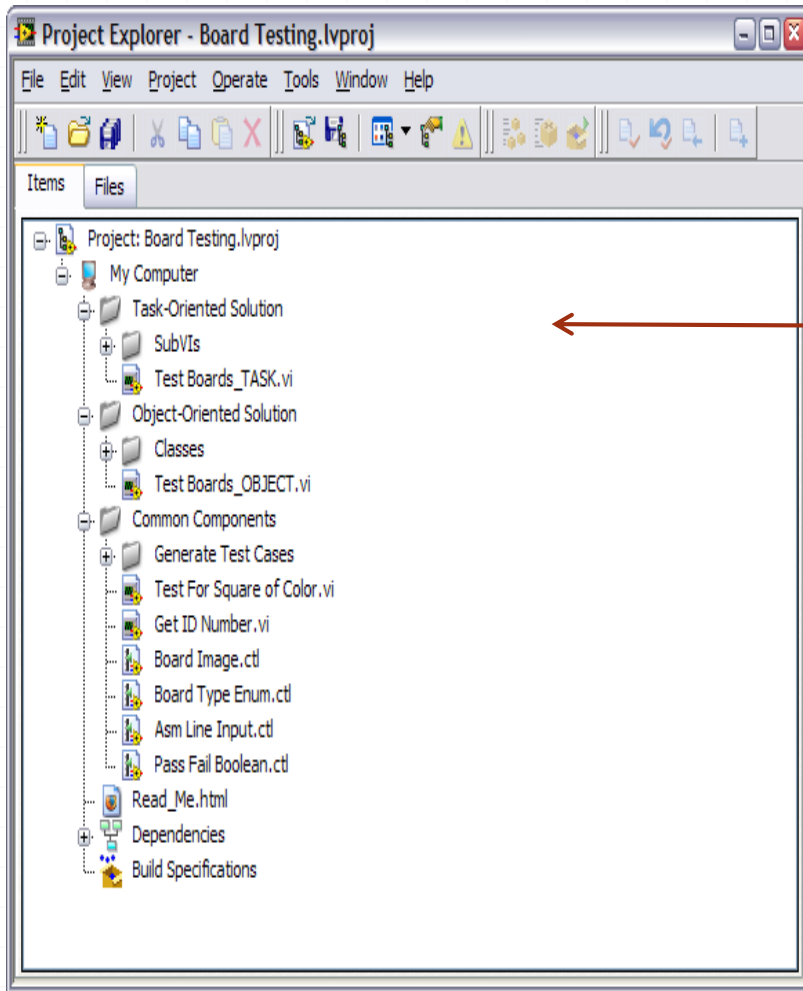

Large system management

- How to manage a large installation?

Management System

- Monitoring
- Security
- Re-install
- Updates



Watch these!

- The LHC by Brian Cox
- Extreme programming by Elisabeth Hendrickson
- What the agile manifesto left out by Brian Marick
- Practicing Continuous Integration by David Cramer
- The Actor Framework by Stephen Mercer
- ZMQ is the answer by Ian Barber

Questions

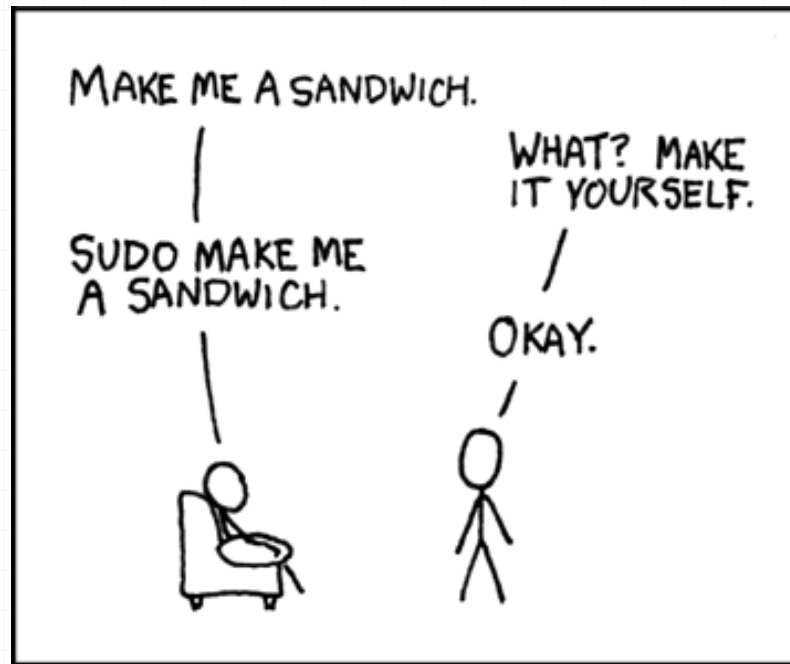

www.cern.ch/RADE

[RADE](#)
[About](#)
[Download](#)
[Support](#)
[Training](#)

RADE is a Rapid Application Development Environment based on LabVIEW.

It's the solution at CERN to develop expert tools, machine development analysis and independent test facilities in integration with the CERN control systems.

- [RADE Modules](#)
- [What is new in RADE?](#)

RADE Modules

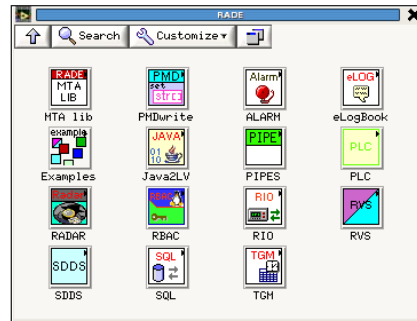

Library	Icon	Description
MTALib		MTA library. Contains extensions of standard LabVIEW functions for Array, Boolean, Comparison and other palettes.
ALARM		Activating and terminating alarms for the LHC ALARM System.
eLogBook		Adding events and file-attachment to events into eLogBook.
RIO		RADE Input/Output provides an access to a live data from the front-ends. Provides GET, SET and Subscription possibilities for any RDA supported device. RIO is the combination of JAPC and FESA palettes of RADE's previous versions.
PIPES		Using pipes for Read and Write operations.