

# The Compact Muon Solenoid Detector

Piotr Traczyk

Torino/CERN

# The **S** in CMS - Solenoid

- CMS is built around a superconducting solenoid generating a magnetic field of 4 Tesla
- The current necessary for this - 20 kA...
- Superconducting NbTi wire cooled to  $\sim 4\text{K}$
- 13m length, 6m inner diameter - enough to fit the tracker and calorimeters inside
- (cost  $\sim 80$  MCHF)

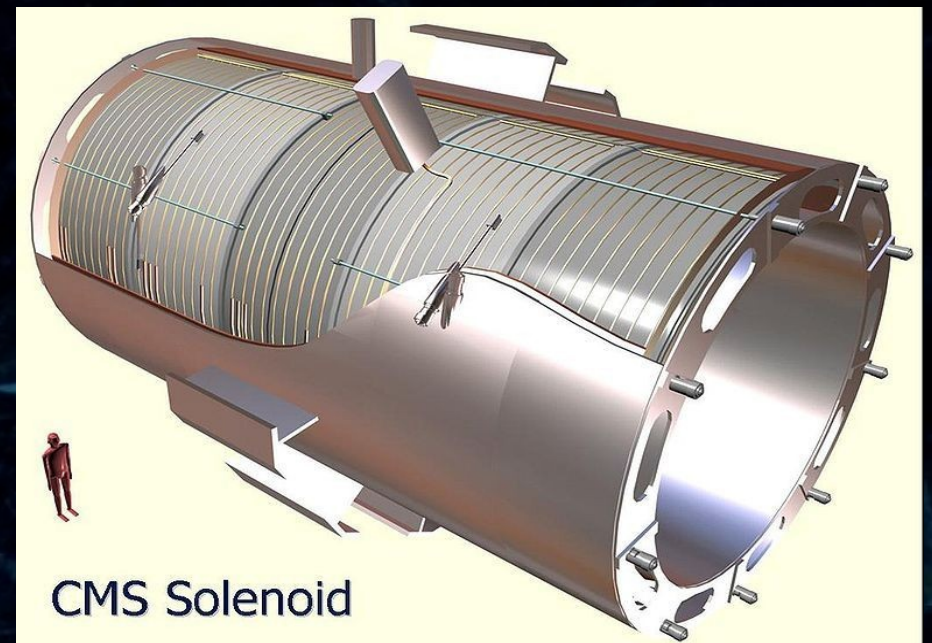

# Magnets in particle detectors

ATLAS A Toroidal LHC Apparatus

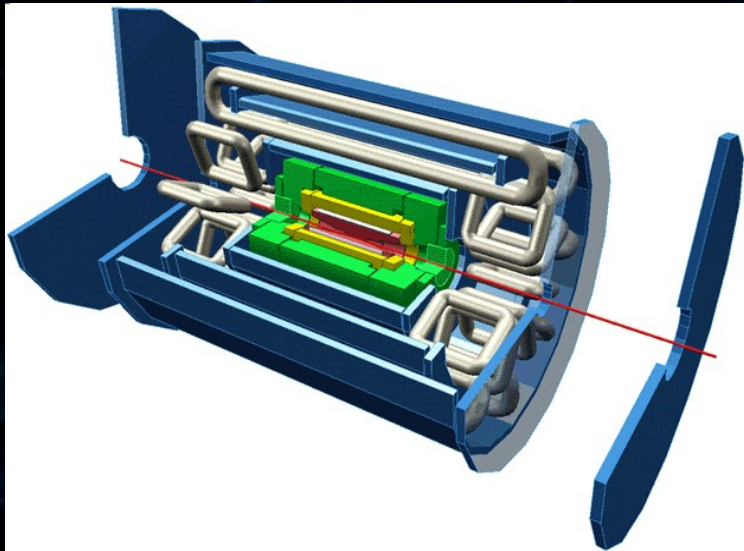

CMS Compact Muon Solenoid

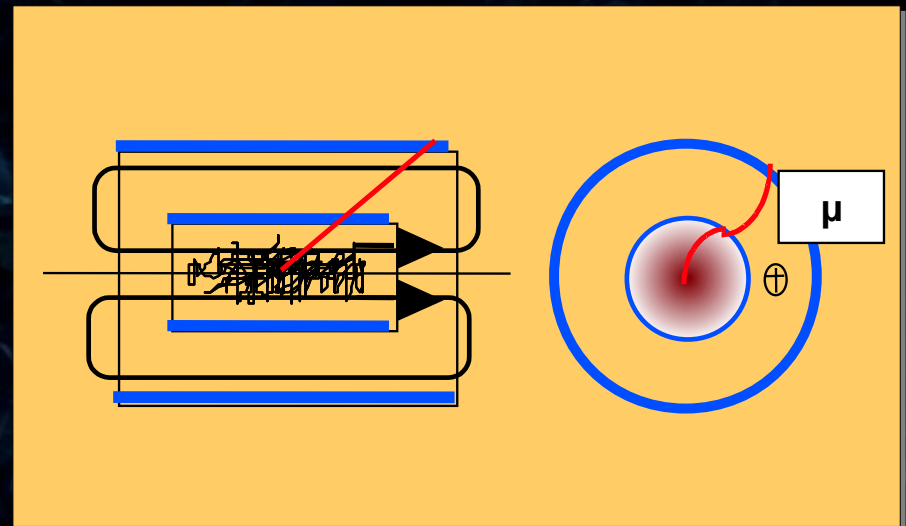
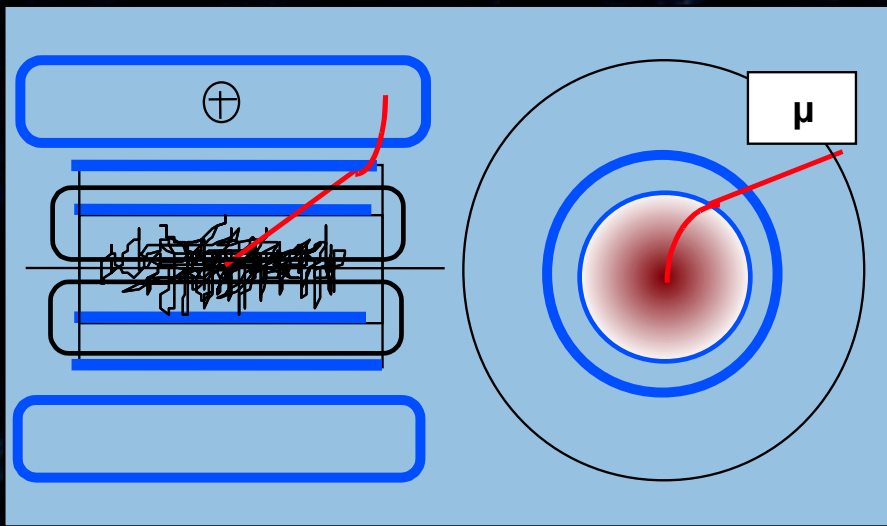
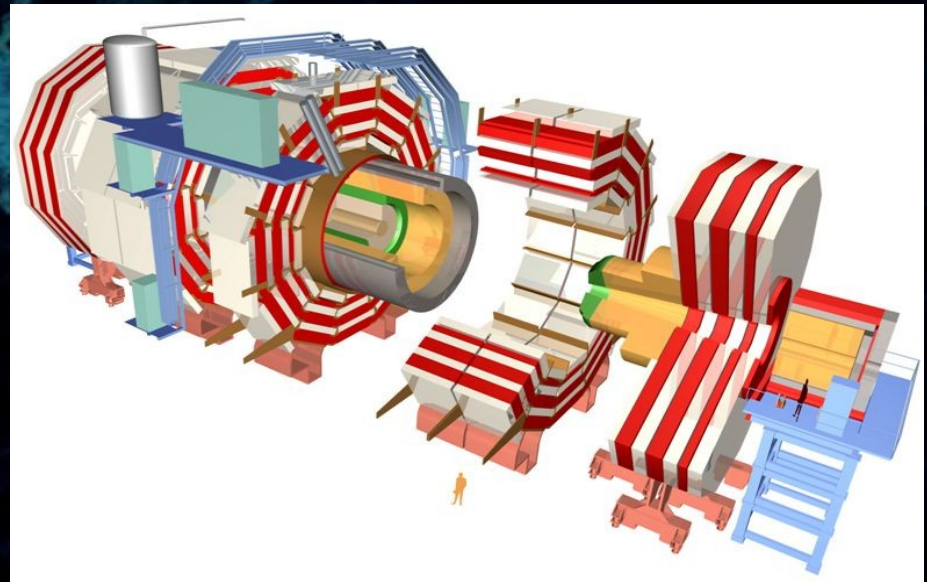

# CMS detector overview

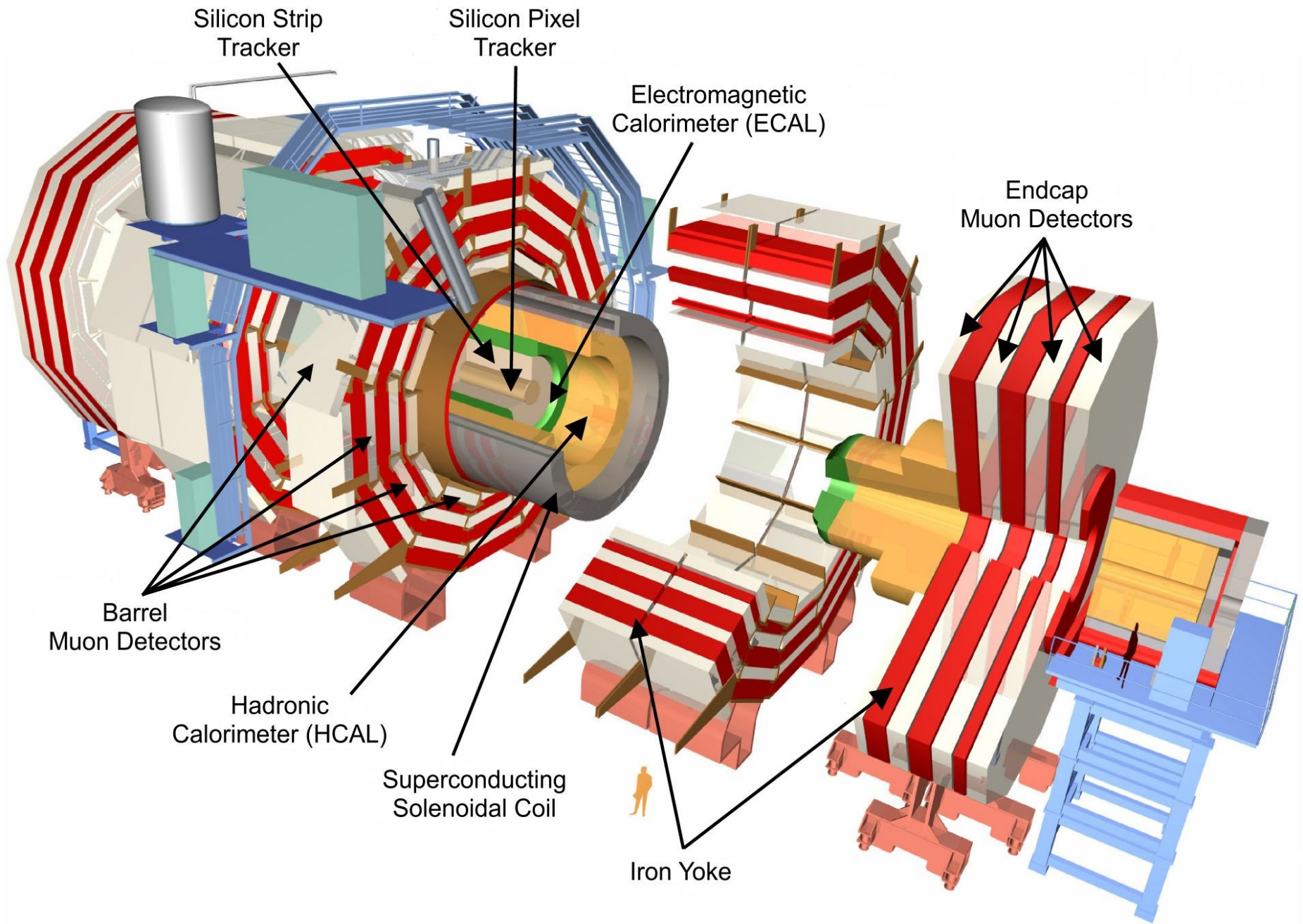

# Two ways to detect a particle

(in CMS)

# Two ways to detect a particle

(in CMS)

See the track



Or

Catch



# Two ways to detect a particle

(in CMS)

## Tracking detector

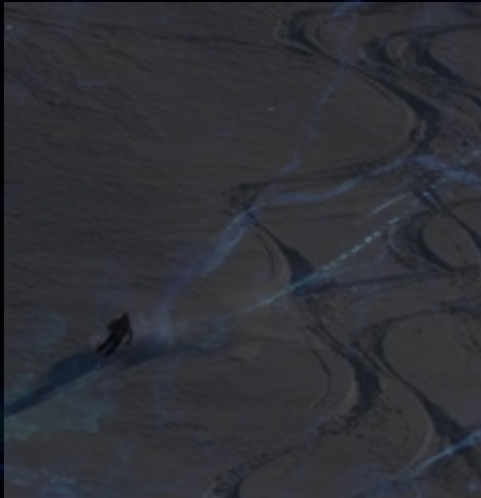

Or

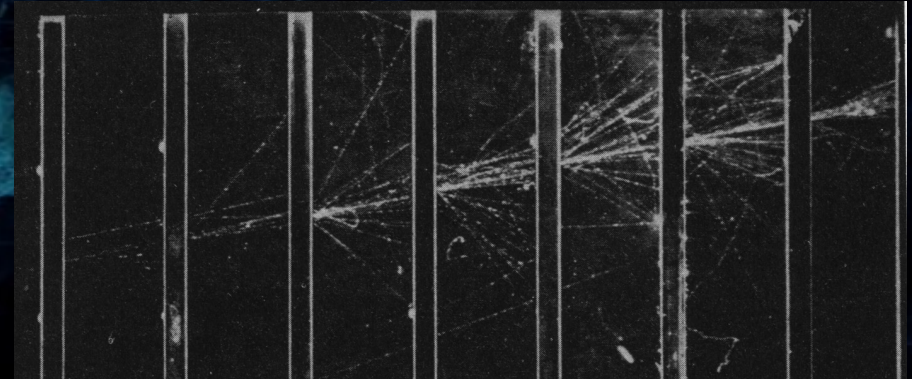

## Calorimeter

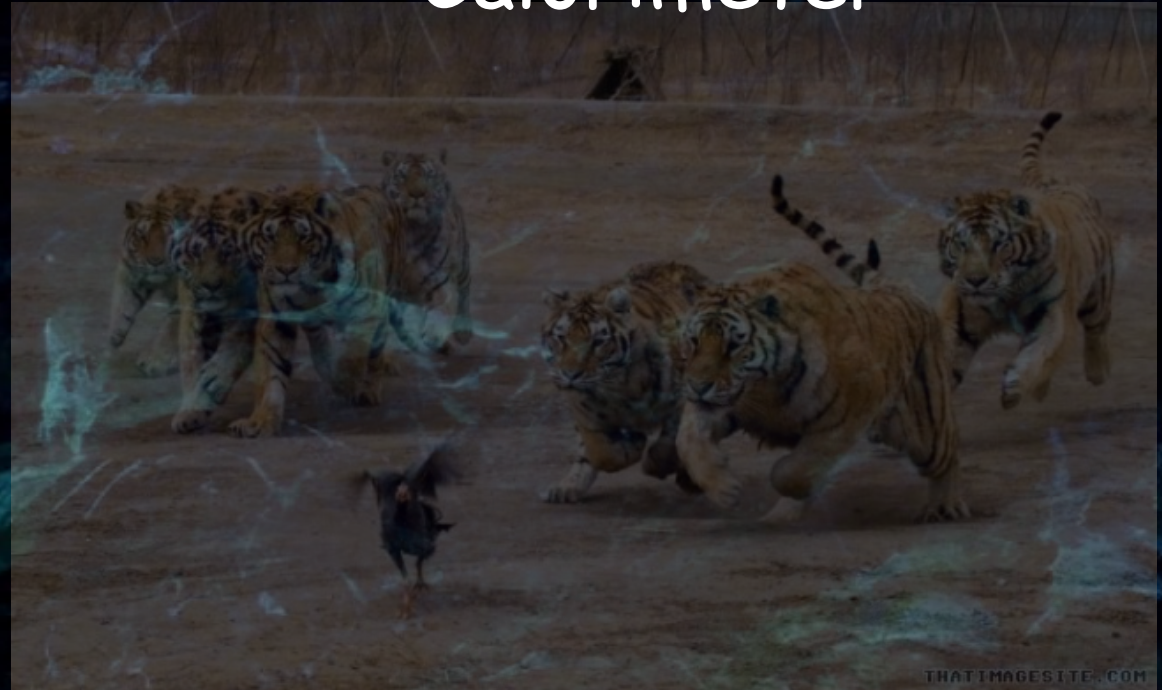
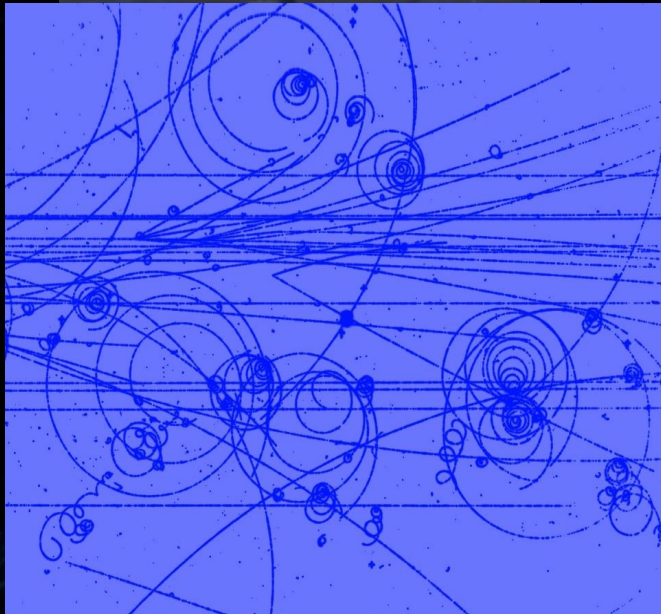

# Particle detectors are like...

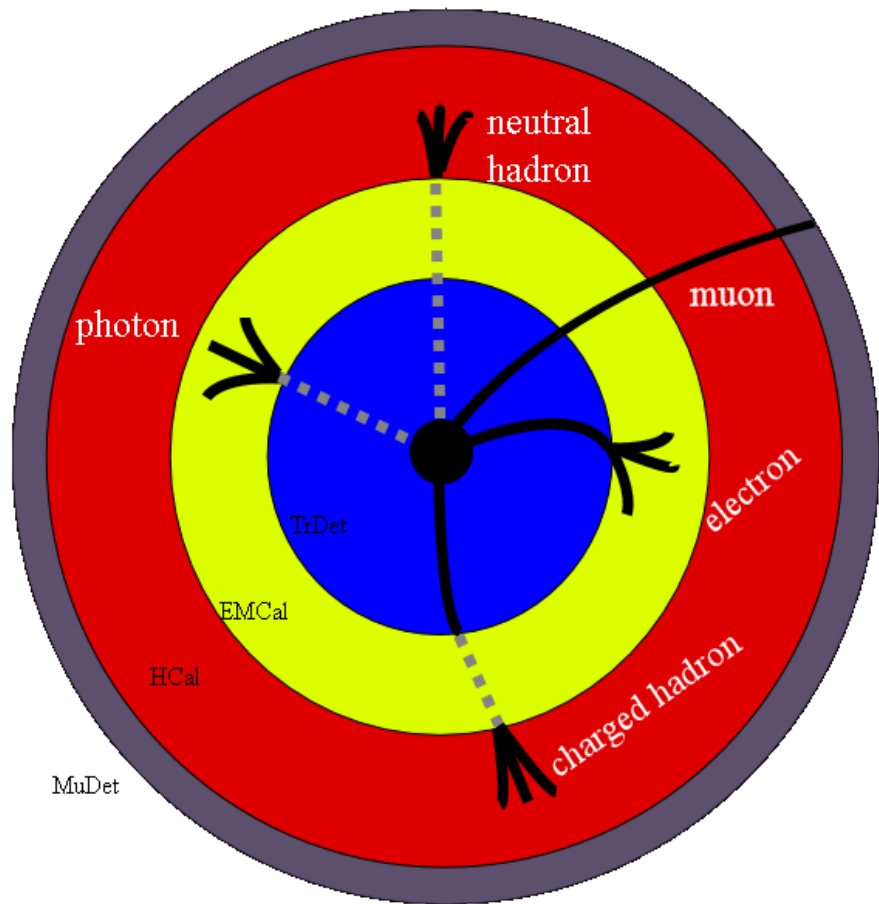

MuDet: muon detectors  
TrDet: trace detector + vertex detector  
EMCal: elektromagnetický kaloriméter  
HCal: hadron kaloriméter





# Particle identification in CMS

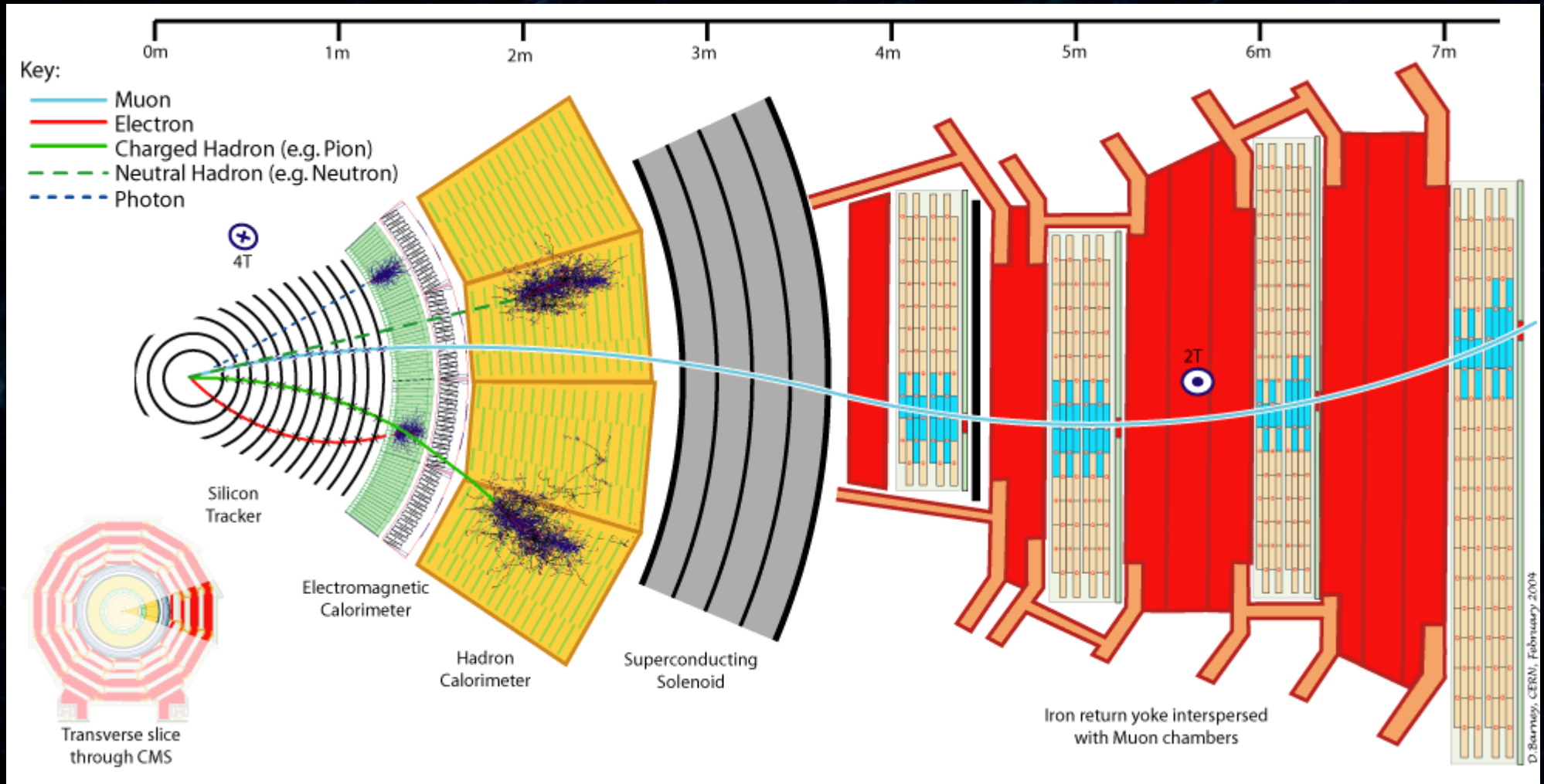

# The Inner Tracker

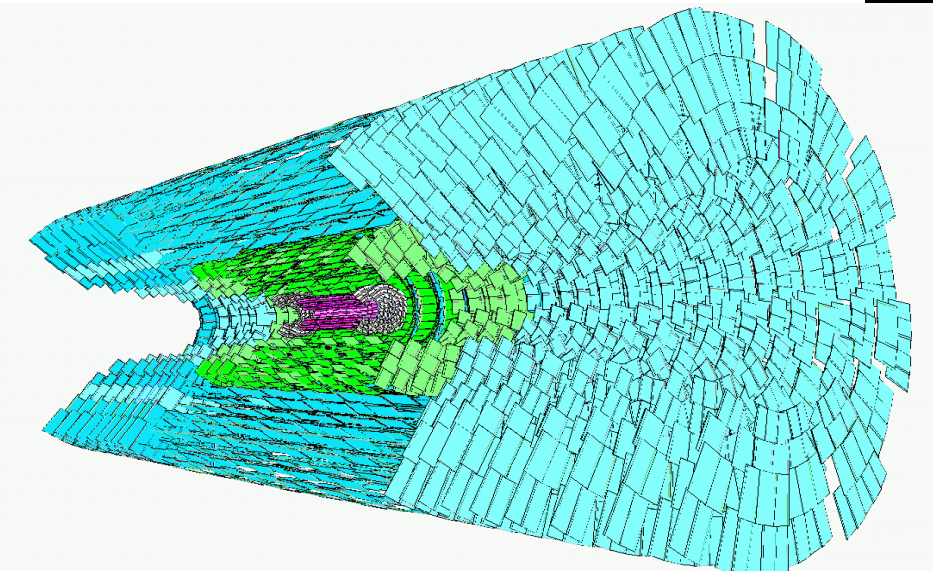
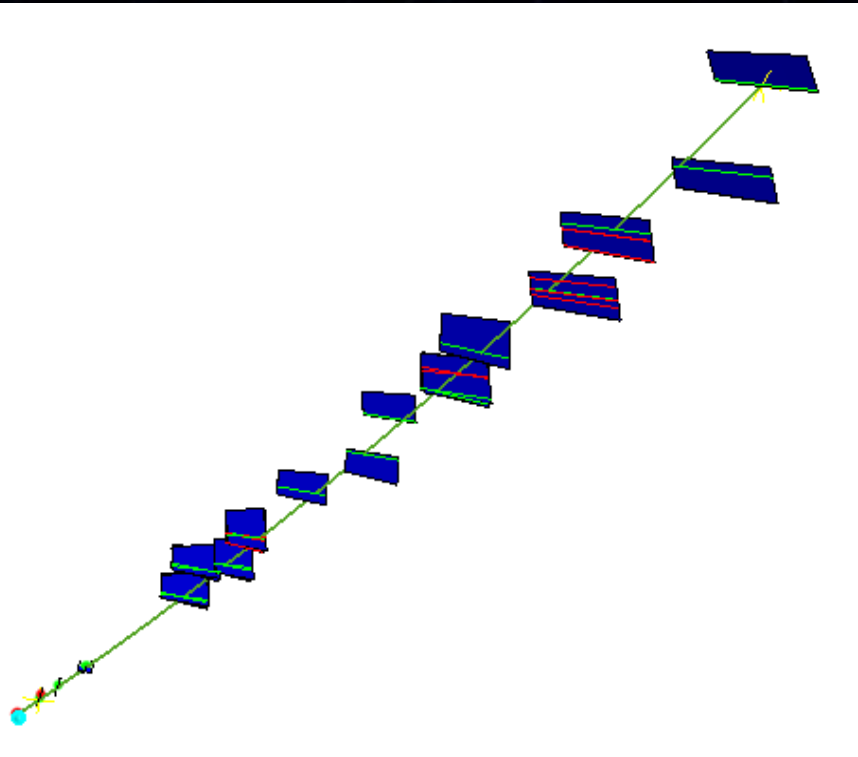

- Measures the trajectories of charged particles  
*momentum = 1/curvature*
- The biggest silicon detector in history, over 220m<sup>2</sup> of silicon
- Inner part - 3 layers of pixel detectors, outer part 10-11 layers of silicon microstrips
- 75 millions of read-out channels

# Event „pile-up“

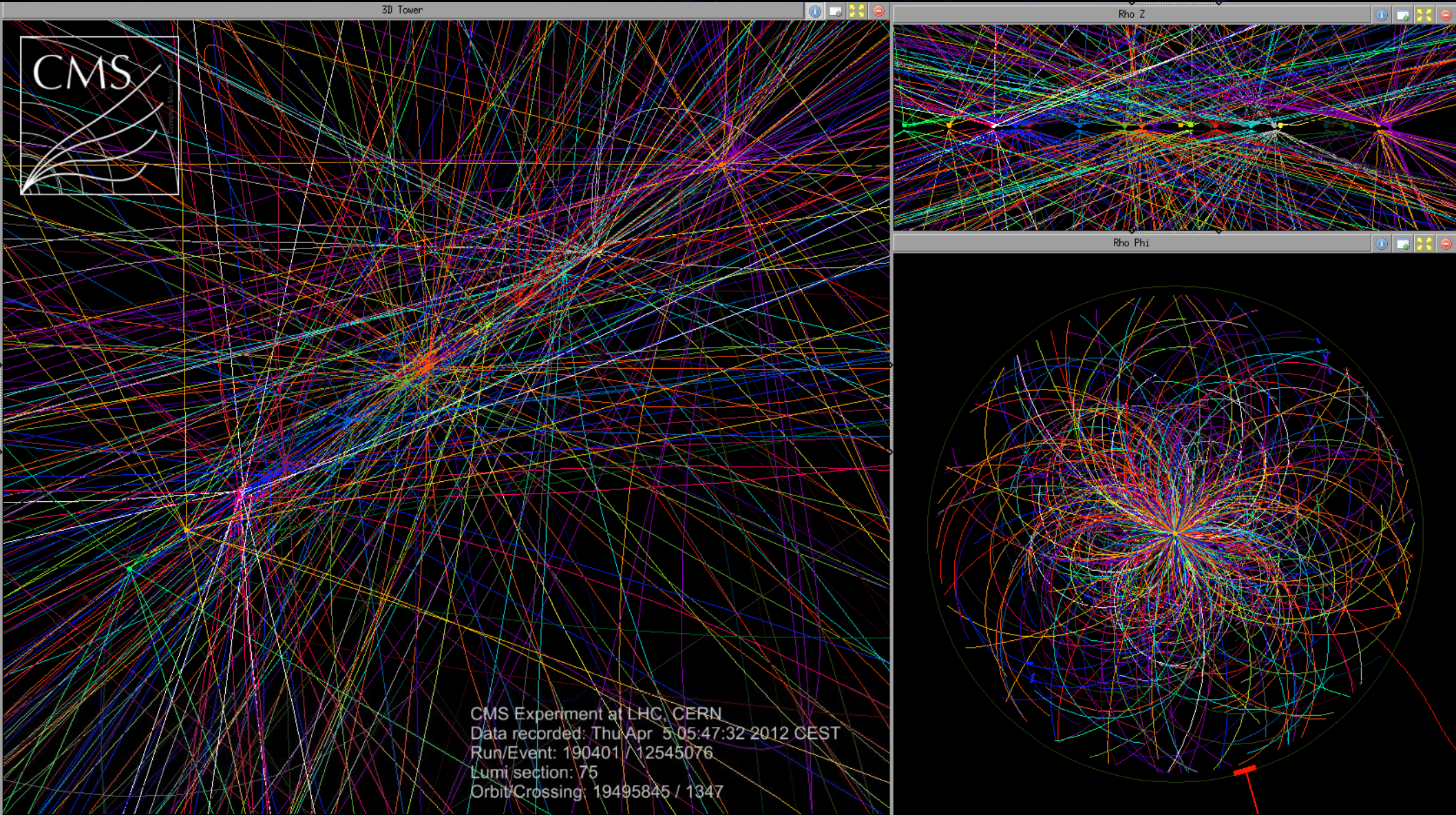

In the LHC, several proton-proton collisions can occur in a single bunch crossing (The image shows an event with 29 reconstructed vertices)

# Electromagnetic Calorimeter

- Electron and photon energy measurement
- $\sim 80\,000$   $\text{PbWO}_4$  crystals
- Homogeneous detector - crystals act as both the absorber and the scintillator
- Very good energy resolution

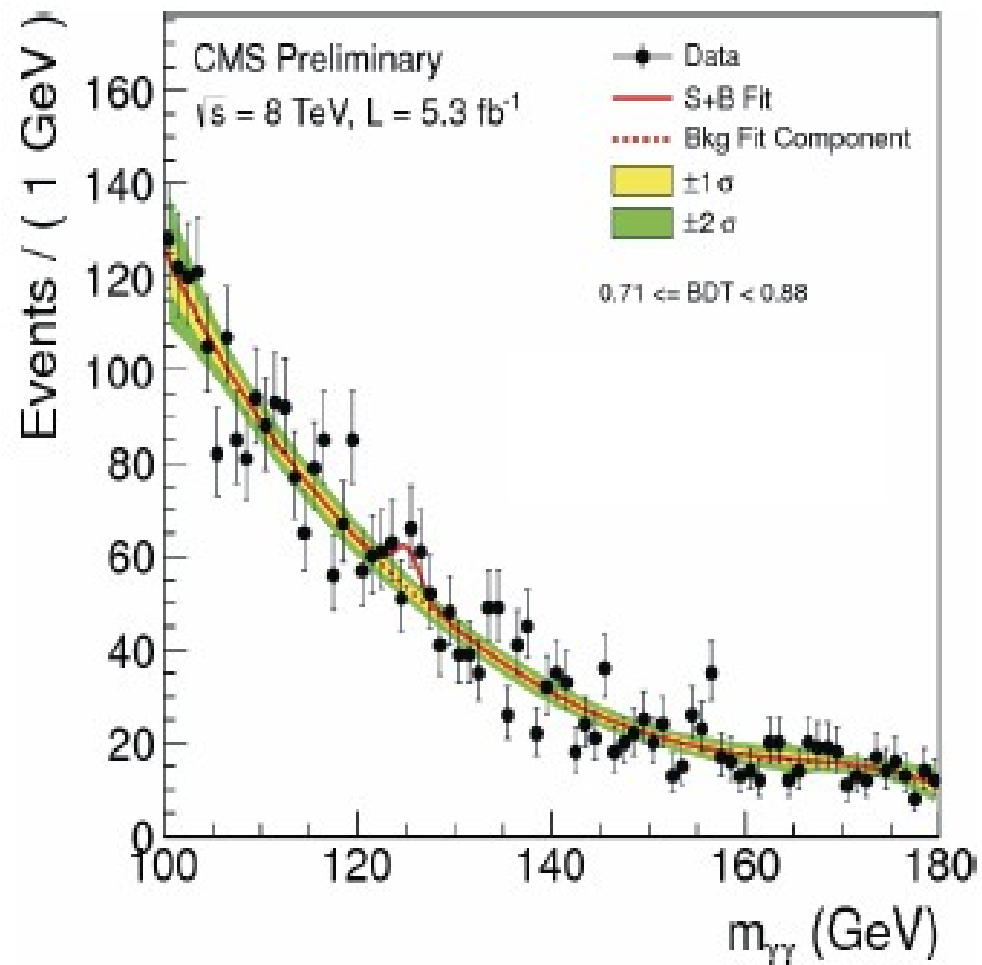
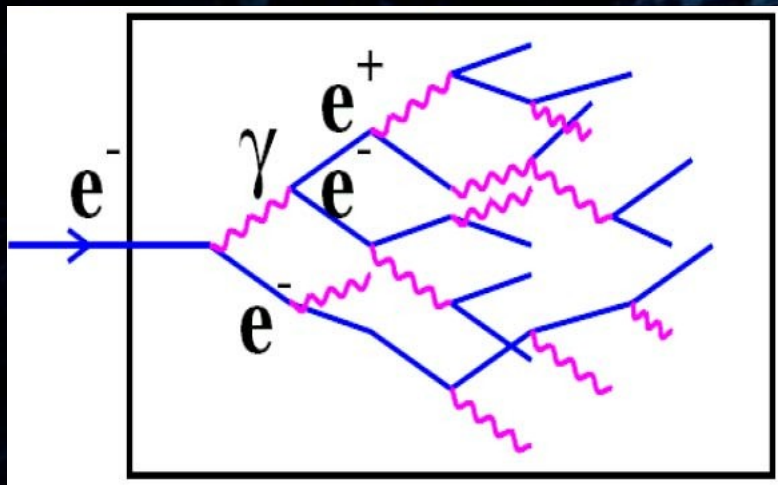

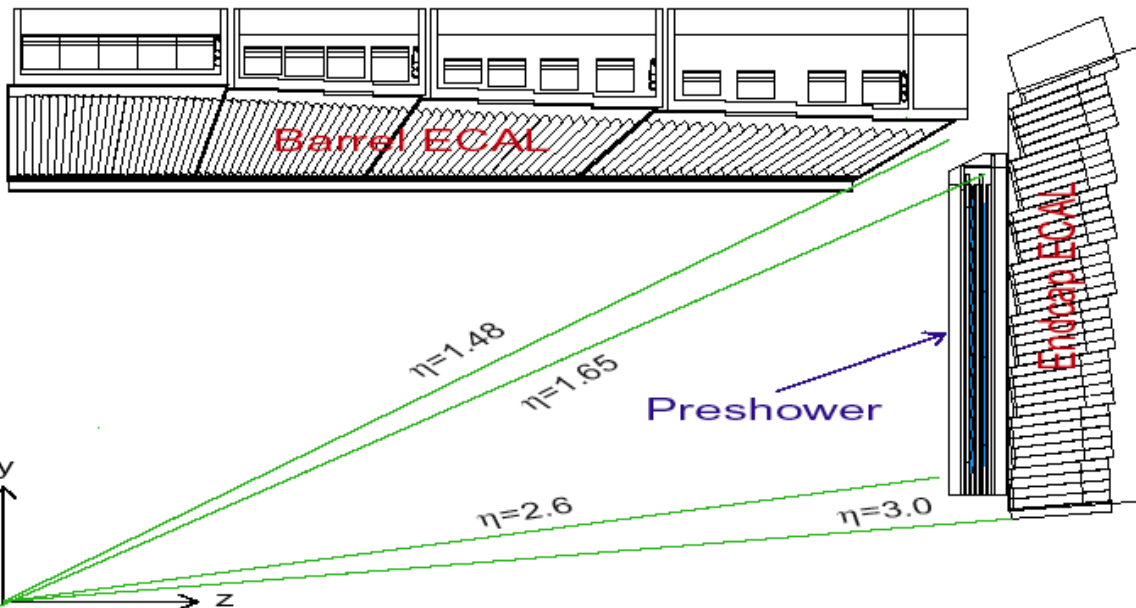
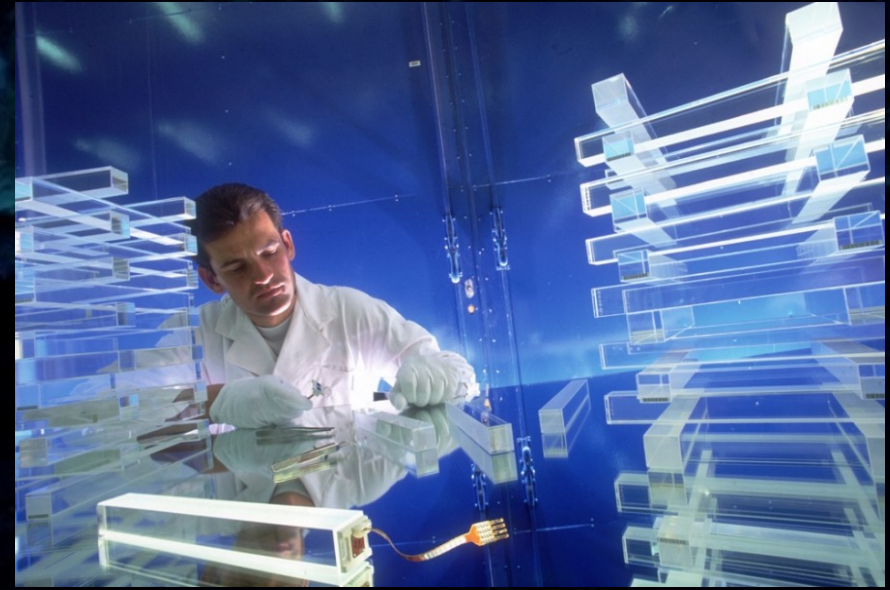

Figure 2: A section through one quadrant of the ECAL.



CMS  
Lab 27  
PH.CMA  
CERN

# Hadron Calorimeter

- Jet energy measurement
- Brass absorber interleaved with scintillator layers
- Steel blocks with embedded quartz fibers in the „forward“ part

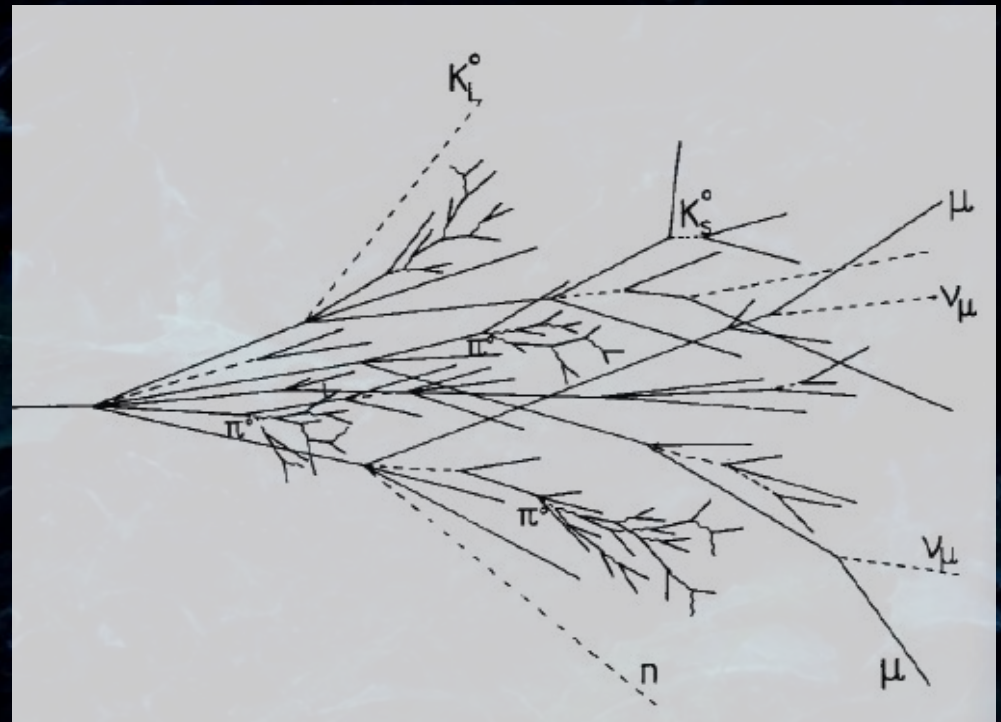
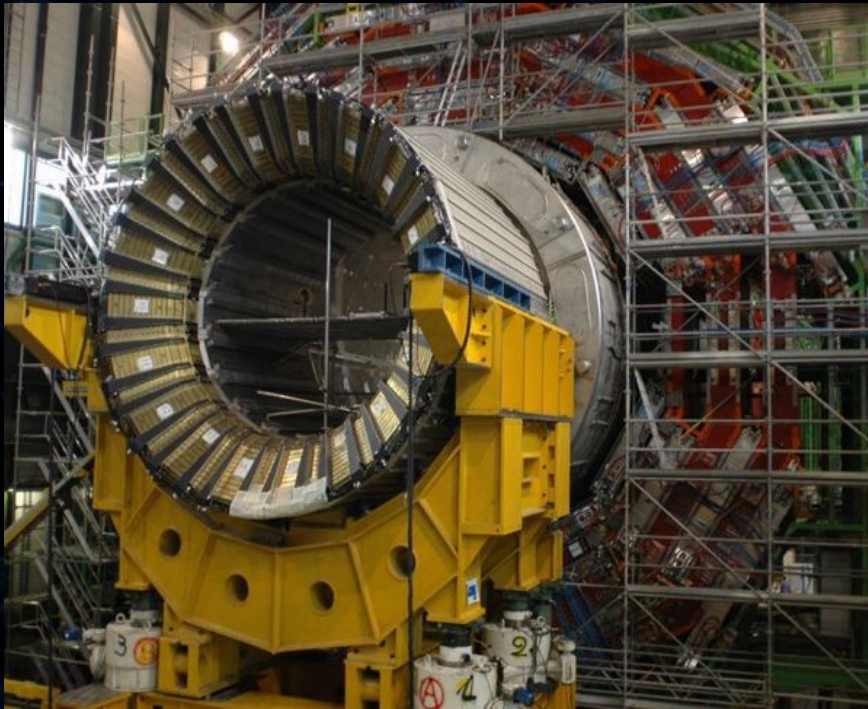
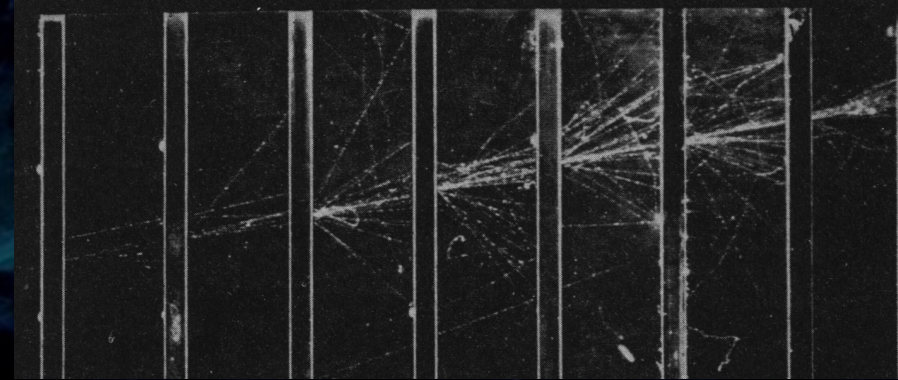

# The $H \rightarrow \gamma\gamma$ channel

$L=0.00 \text{ fb}^{-1}$

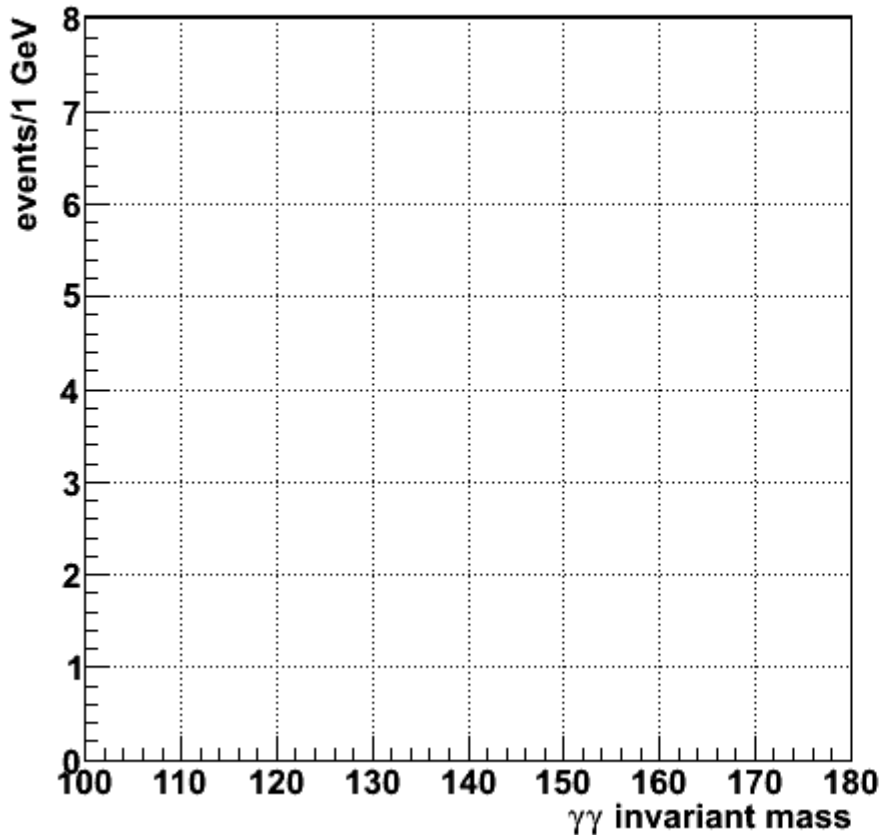

$L=0.00 \text{ fb}^{-1}$

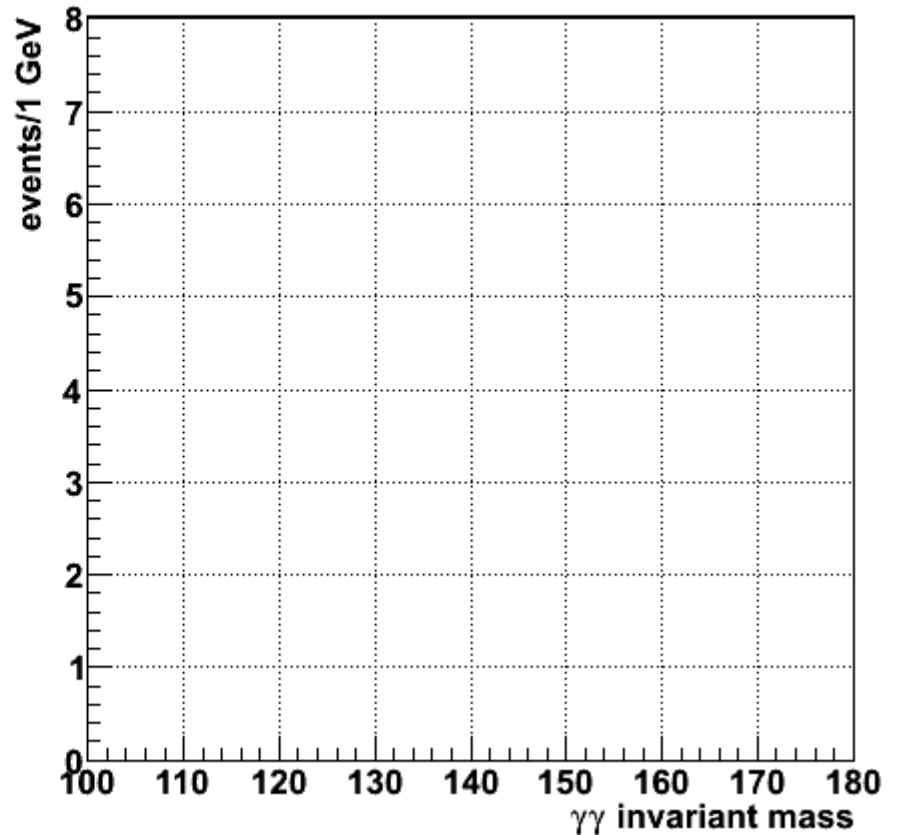

One of these plots contains the (simulated) Higgs boson signal.

Can you spot it?

# The $H \rightarrow \gamma\gamma$ channel

$L=1.00 \text{ fb}^{-1}$

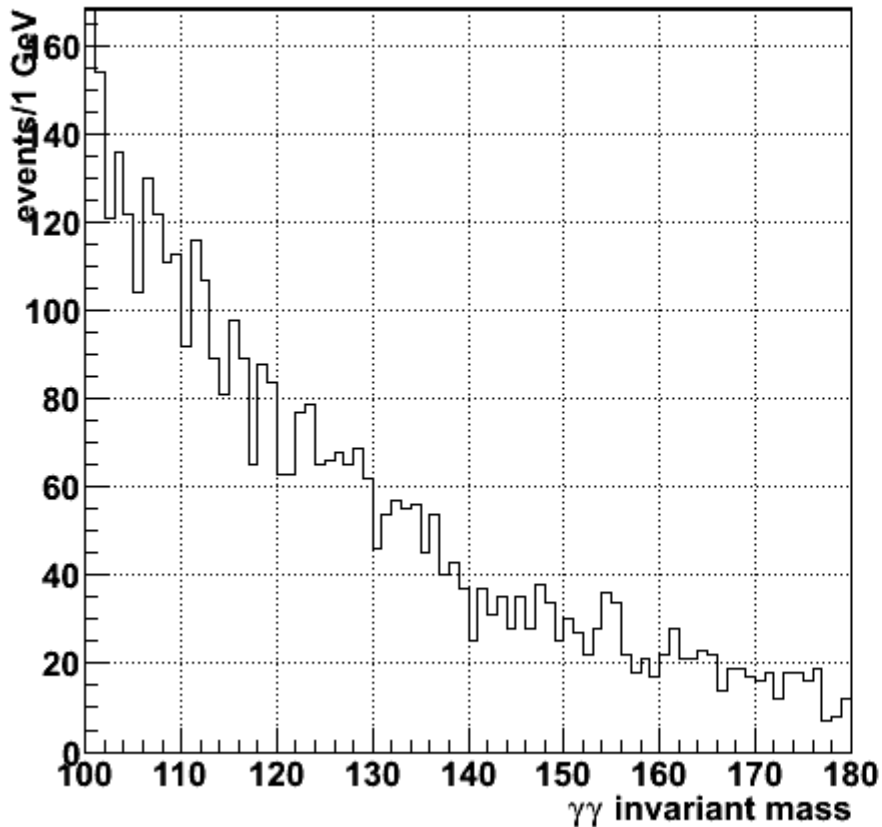

$L=1.00 \text{ fb}^{-1}$

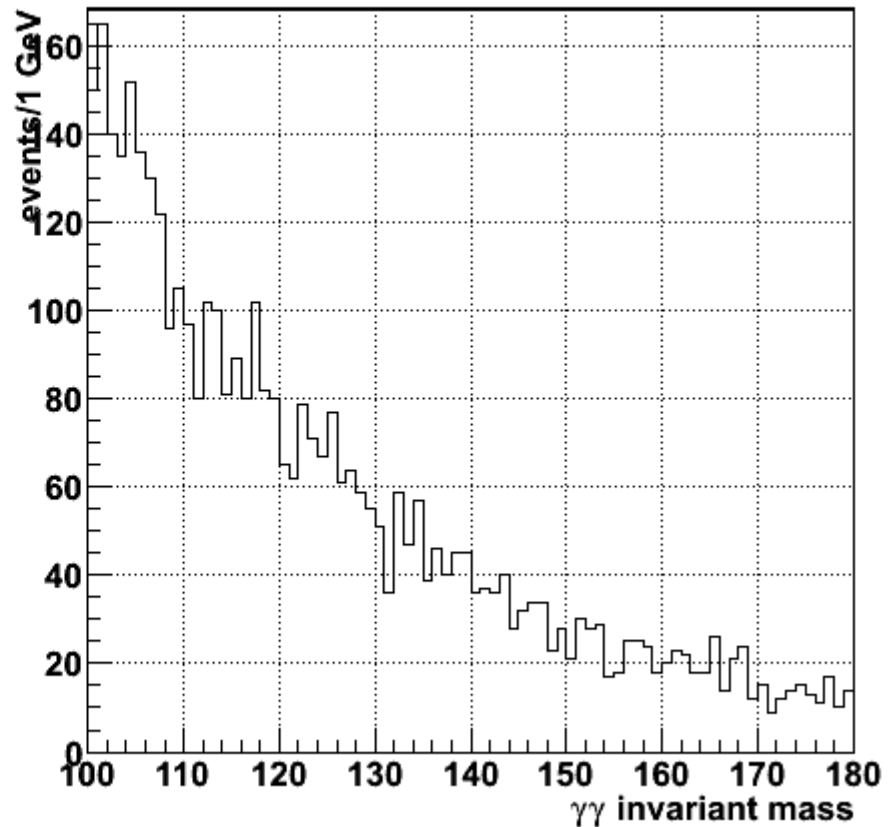

One of these plots contains the (simulated) Higgs boson signal.

Can you spot it?



# The $H \rightarrow \gamma\gamma$ channel

$L=2.00 \text{ fb}^{-1}$

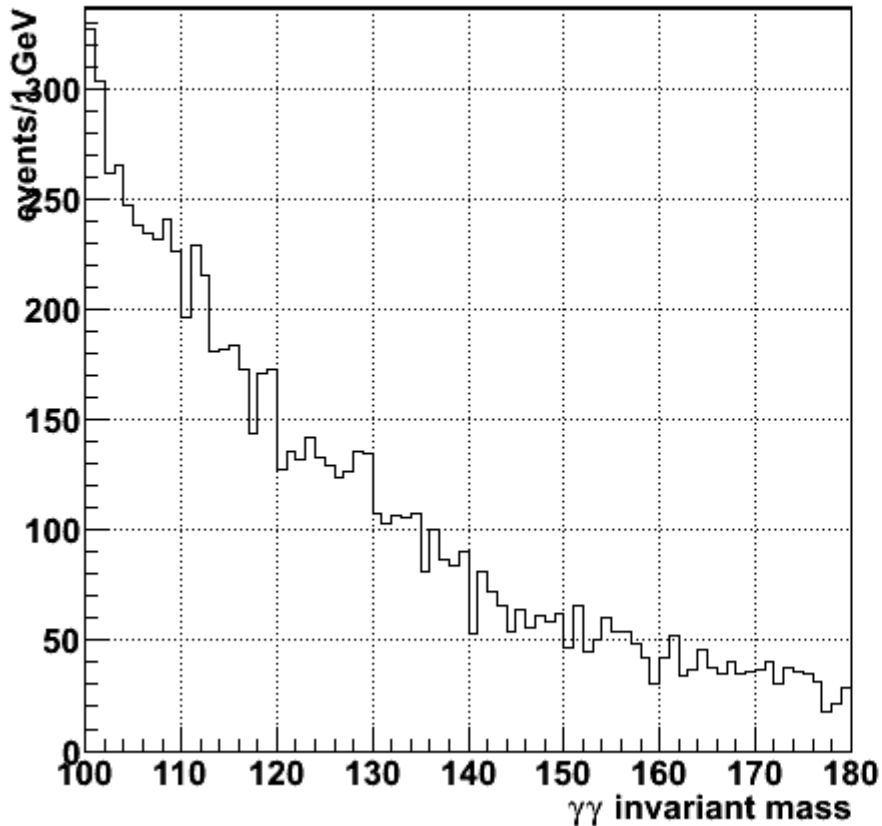

$L=2.00 \text{ fb}^{-1}$

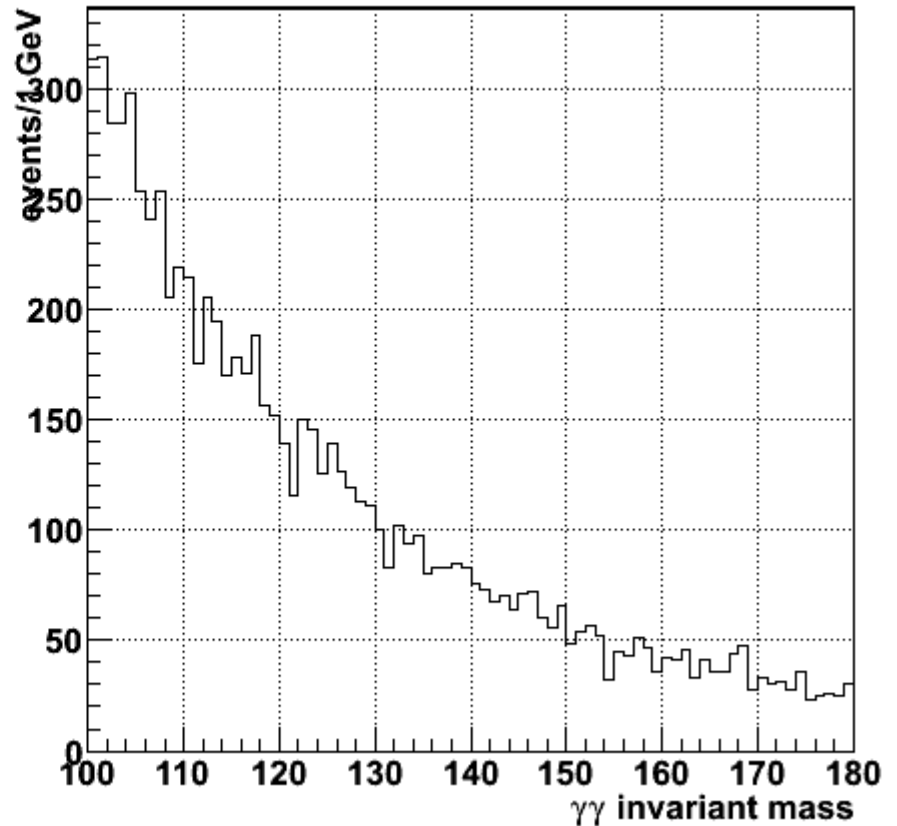

One of these plots contains the (simulated) Higgs boson signal.

Can you spot it?

# The $H \rightarrow \gamma\gamma$ channel

$L=4.00 \text{ fb}^{-1}$

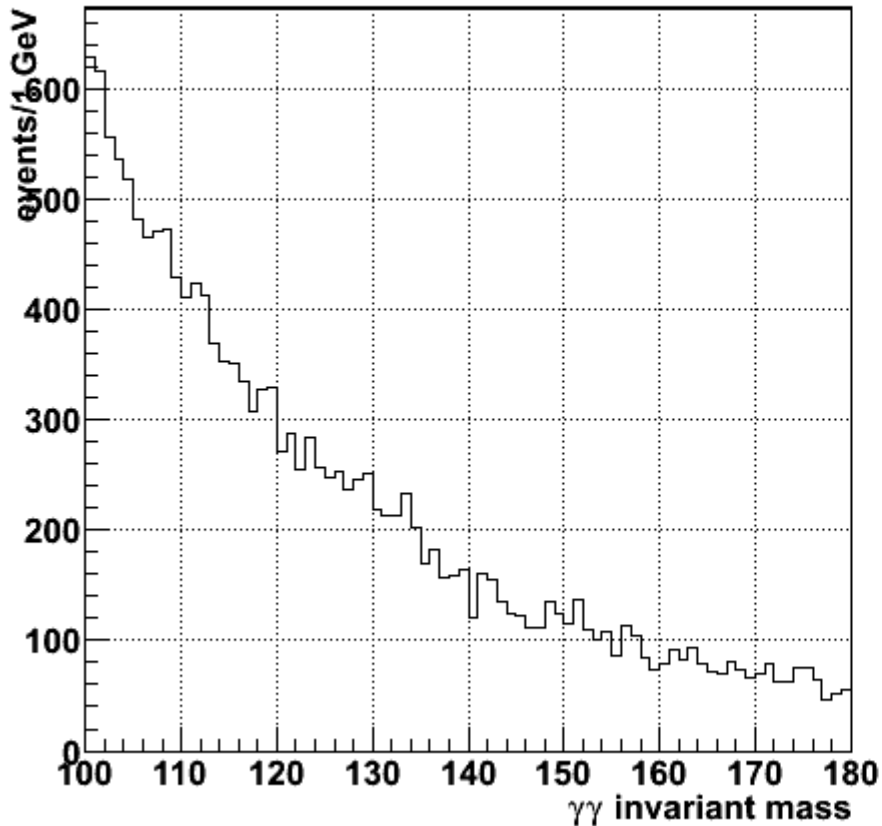

$L=4.00 \text{ fb}^{-1}$

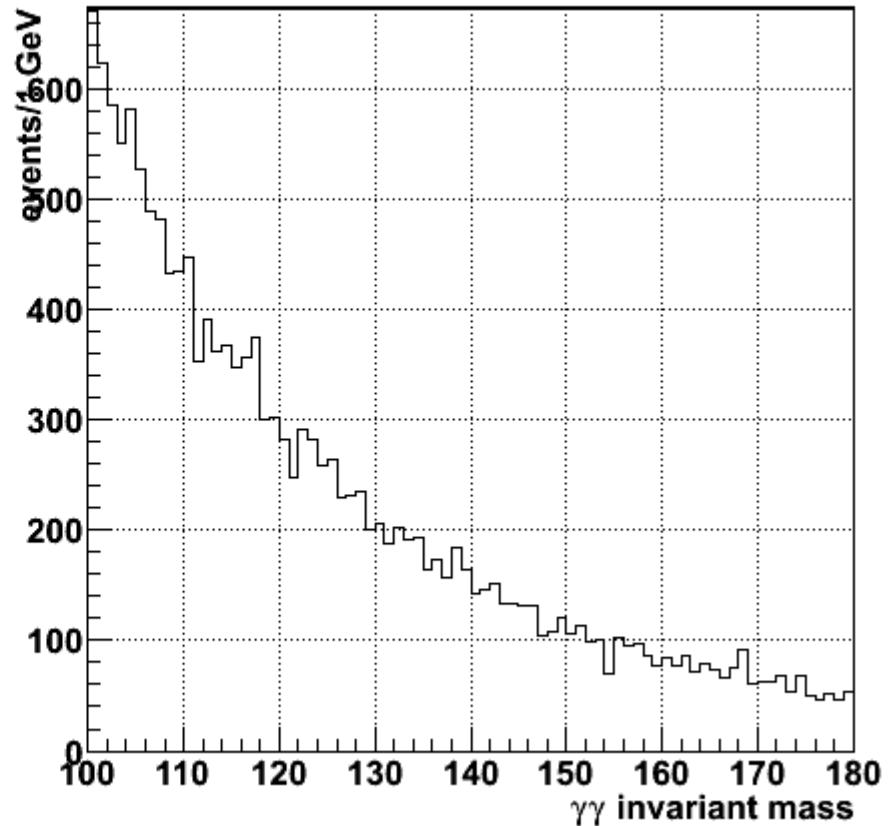

One of these plots contains the (simulated) Higgs boson signal.

Can you spot it?

# The $H \rightarrow \gamma\gamma$ channel

$L=8.00 \text{ fb}^{-1}$

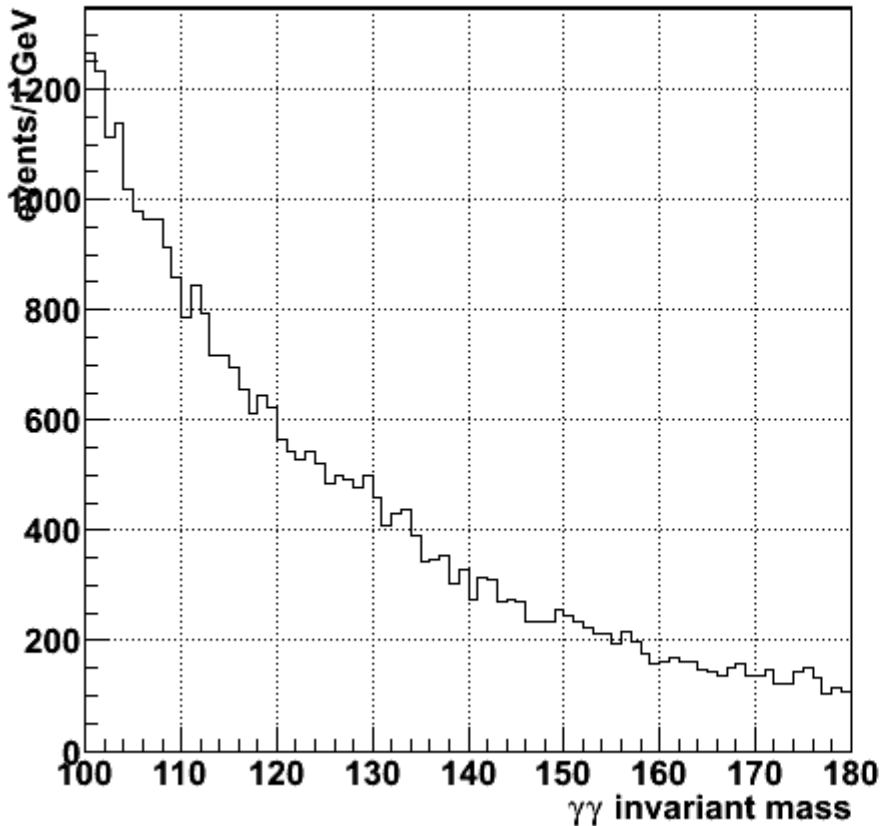

$L=8.00 \text{ fb}^{-1}$

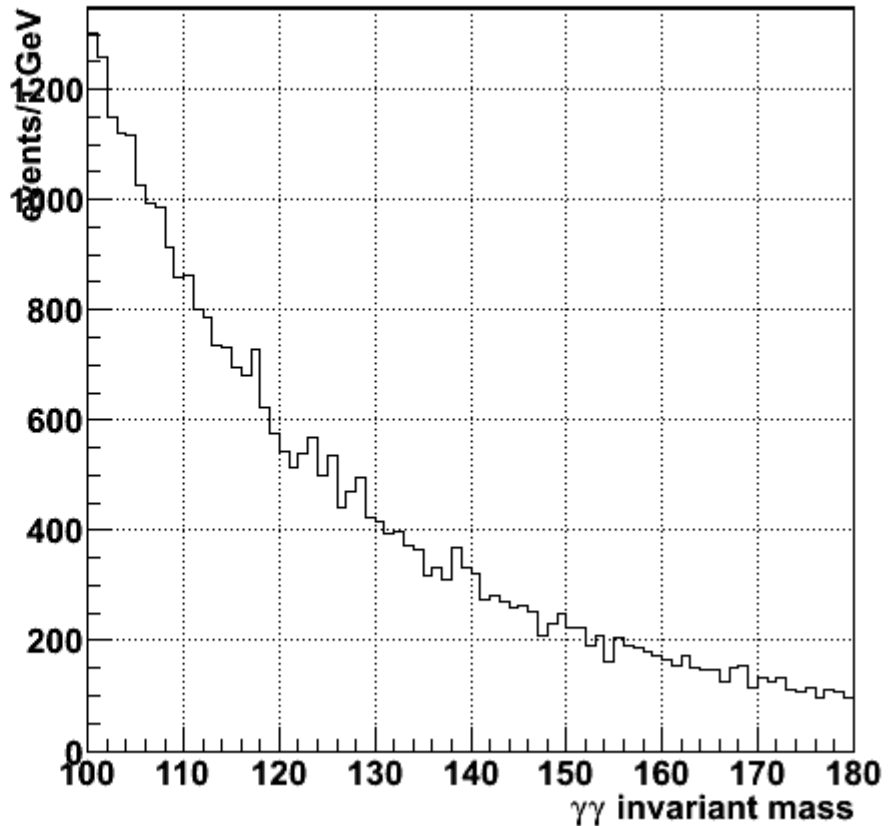

One of these plots contains the (simulated) Higgs boson signal.

Can you spot it?

# The $H \rightarrow \gamma\gamma$ channel

$L=16.00 \text{ fb}^{-1}$

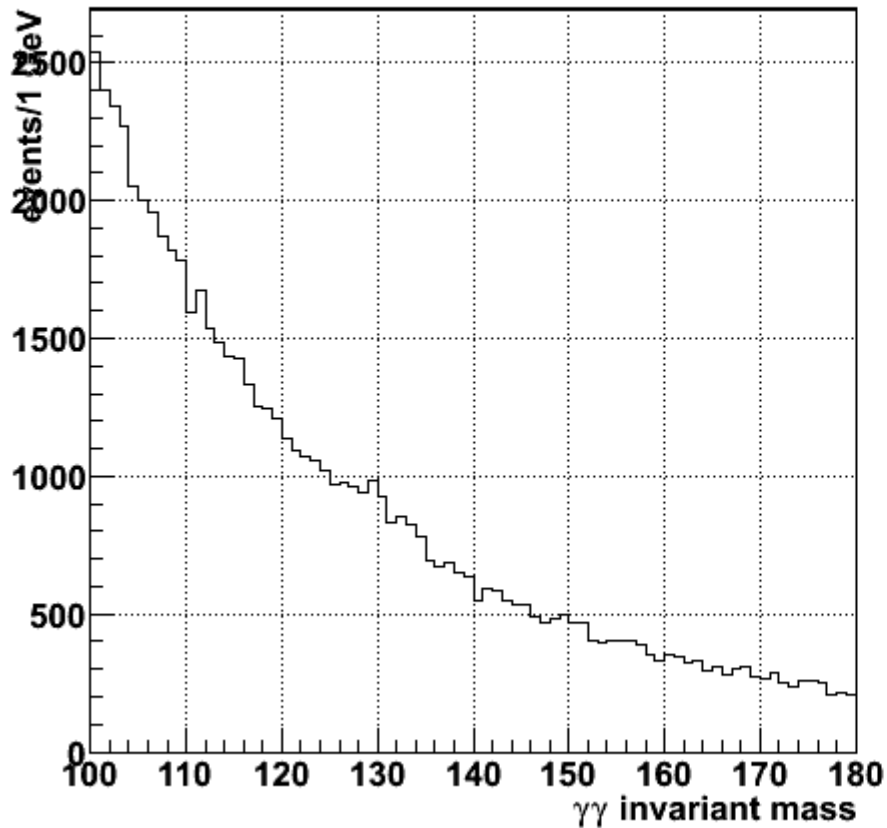

$L=16.00 \text{ fb}^{-1}$

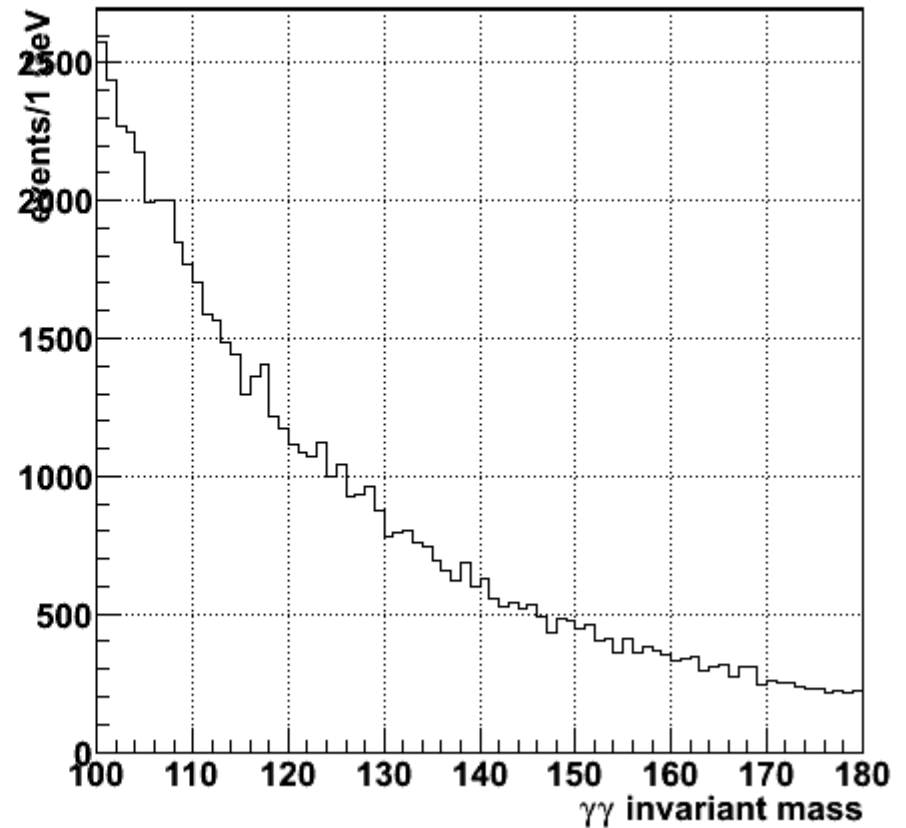

One of these plots contains the (simulated) Higgs boson signal.

Can you spot it?

# The $H \rightarrow \gamma\gamma$ channel

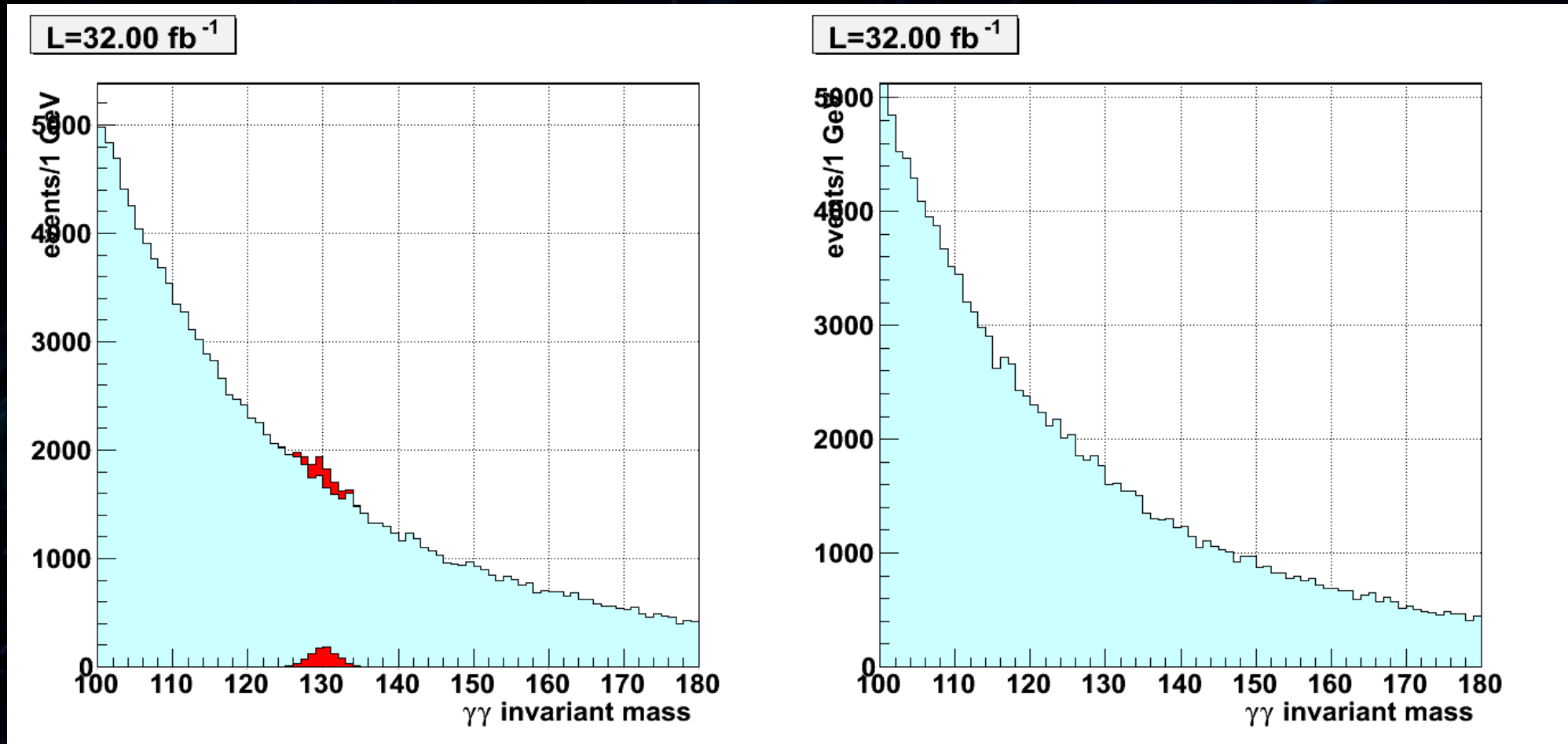

One of these plots contains the (simulated) Higgs boson signal.

Can you spot it?

# The Muon System - Drift Tubes

- Muon trajectory measurement (barrel)
- Measured quantity - drift time of electrons produced by the passing muon
- Known drift velocity  $\rightarrow$  distance measurement ( $\sim 50\text{-}200\mu\text{m}$  precision)
- Alignment very important

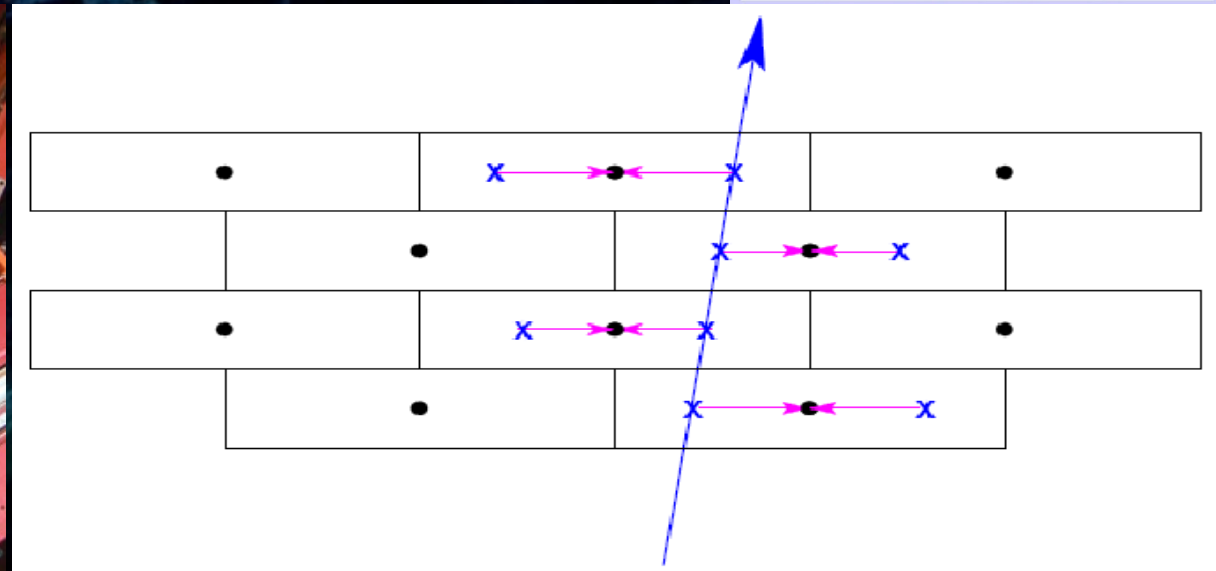
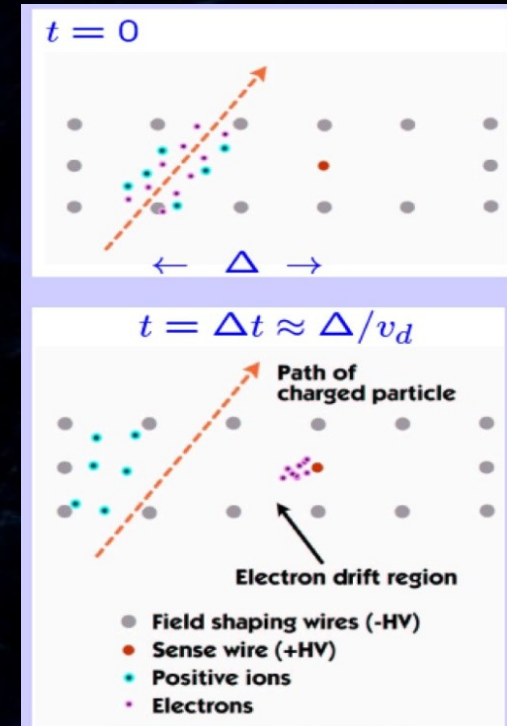

# Cathode Strip Chambers (CSC)

- Muon trajectory measurement in the endcaps
- Gaseous detector with layers of anode wires and cathode strips

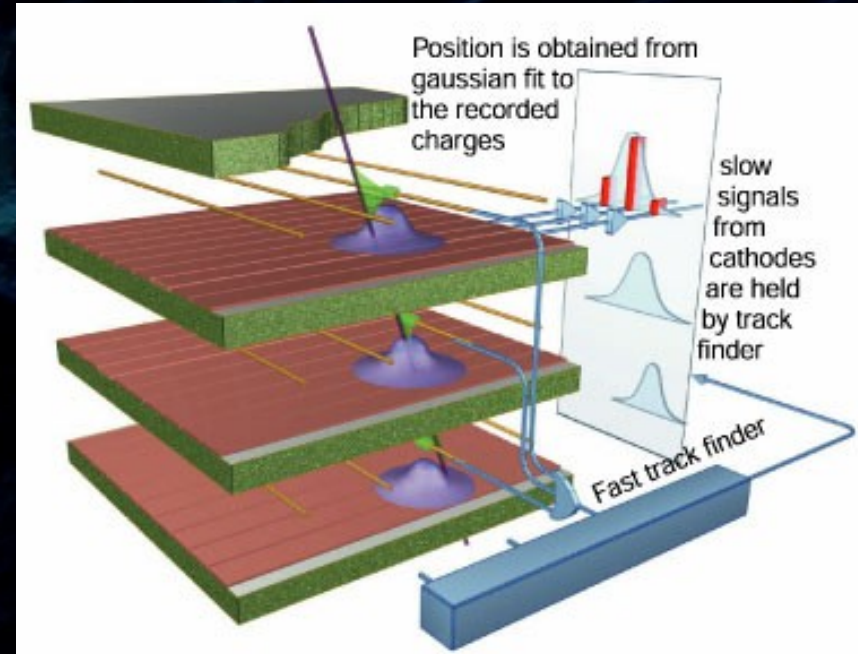

# Trigger

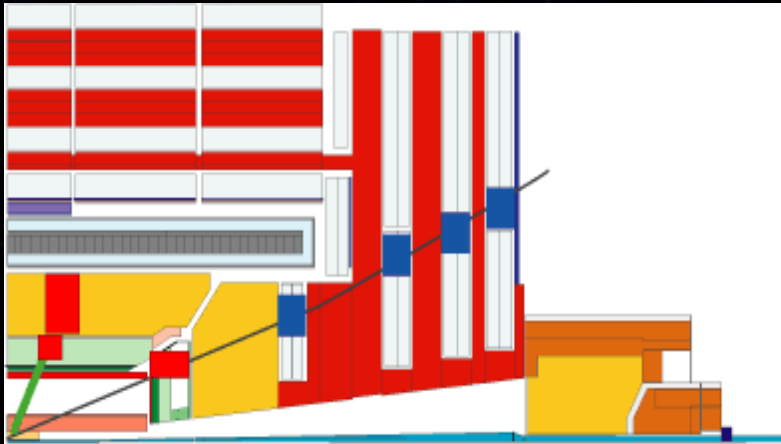

## Level-1 trigger. 40 MHz input :

- Specialized processors (25 ns pipelined, latency < 1  $\mu$ s)
- Local pattern recognition and energy evaluation on prompt macro-granular information from calorimeter and muon detectors
- Particle identification: high  $p_T$  electron, photon, muon, jets, missing  $E_T$

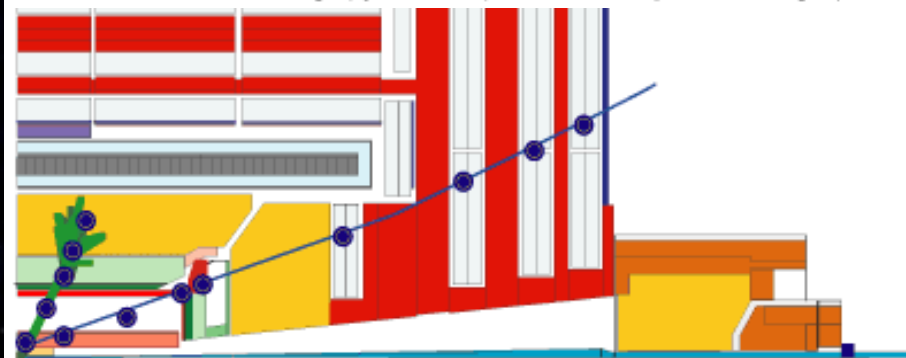

## High trigger levels (>1). 100 kHz input :

- Large network of processor farms
- Clean particle signature. All detector data
- Finer granularity precise measurement
- Effective mass cuts and event topology
- Track reconstruction and detector matching
- Event reconstruction and analysis

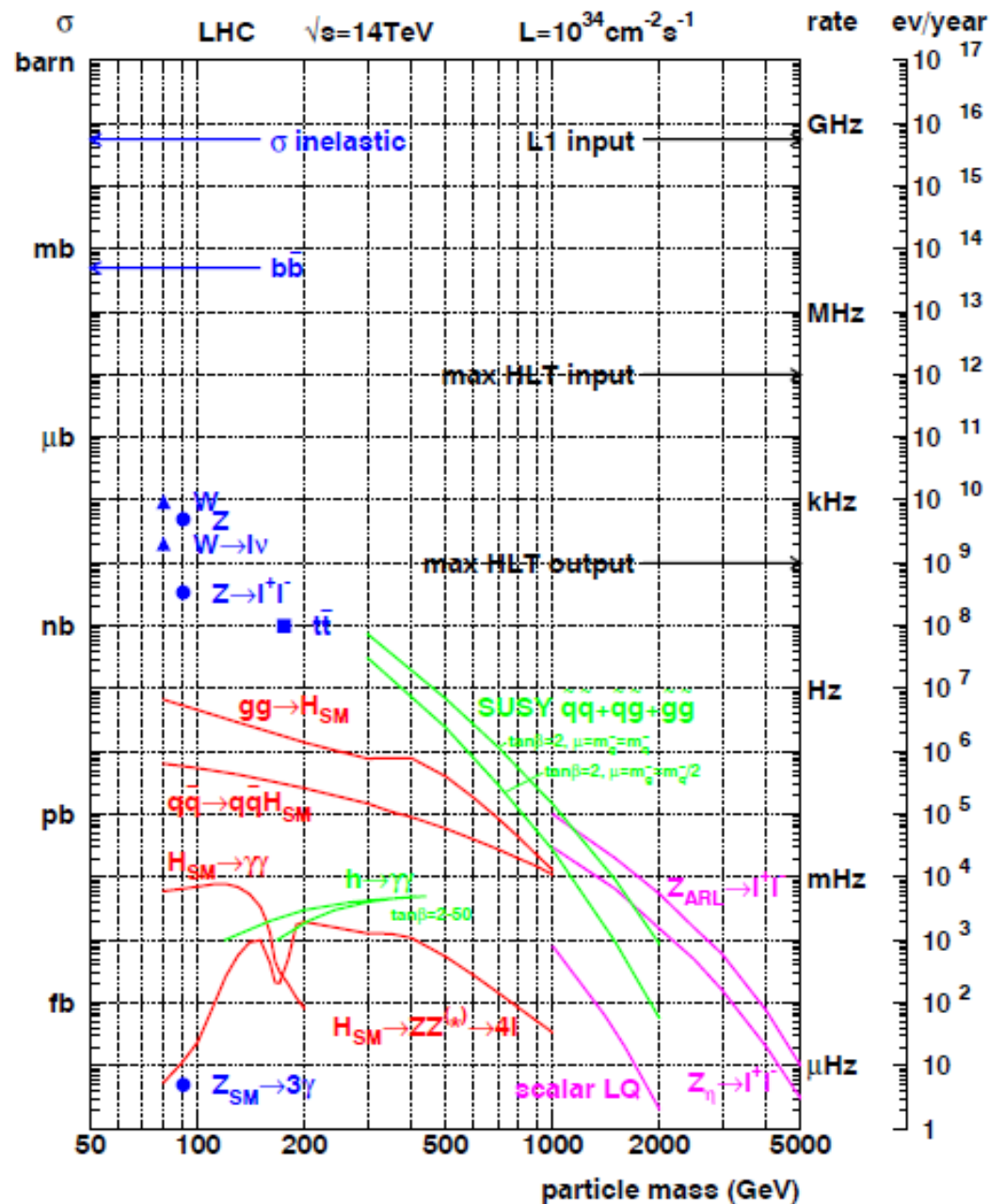



# Once more:

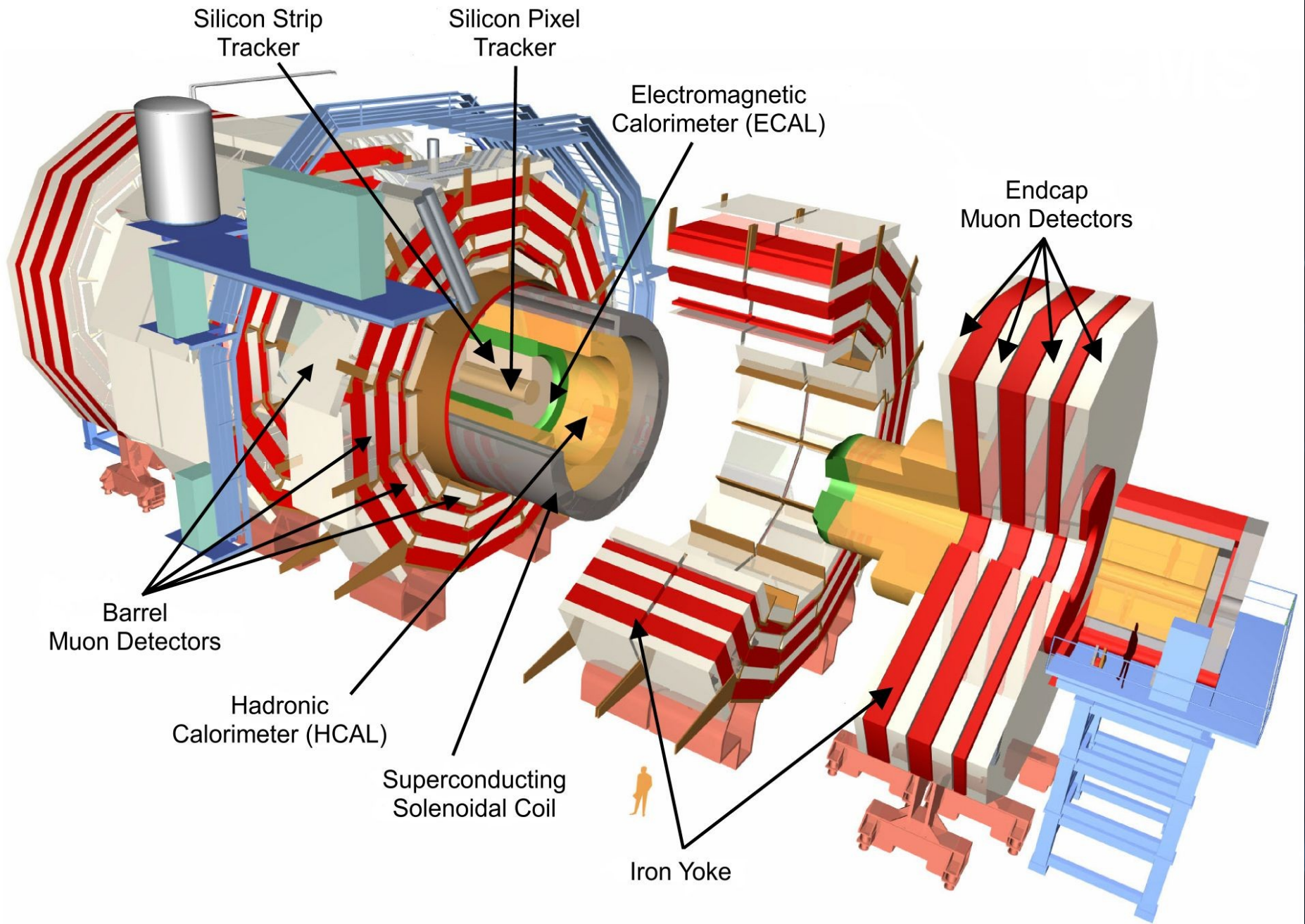

The End

