



RF Measurement Concepts

Fritz Caspers, Piotr Kowina, Manfred Wendt
Accelerator Physics (advanced level)
Warsaw, Poland, 27 September – 9 October 2015

Contents

- ◆ RF measurement methods – some history and overview
- ◆ Superheterodyne Concept and its application
- ◆ Voltage Standing Wave Ratio (VSWR)
- ◆ Introduction to Scattering-parameters (S-parameters)
- ◆ Properties of the S matrix of an N-port ($N=1\dots 4$) and examples
- ◆ Smith Chart and its applications
- ◆ Appendices

Measurement methods - overview (1)

There are many ways to observe RF signals. Here we give a brief overview of the five main tools we have at hand

- ◆ **Oscilloscope: to observe signals in time domain**
 - periodic signals
 - burst and transient signals
 - application: direct observation of signal from a pick-up, shape of common 230 V mains supply voltage, etc.

- ◆ **Spectrum analyzer: to observe signals in frequency domain**
 - sweeps through a given frequency range point by point
 - application: observation of spectrum from the beam or of the spectrum emitted from an antenna, etc.

Measurement methods - overview (2)

◆ Dynamic signal analyzer (FFT analyzer)

- Acquires signal in time domain by fast sampling
- Further numerical treatment in digital signal processors (DSPs)
- Spectrum calculated using Fast Fourier Transform (FFT)
- Combines **features of a scope and a spectrum analyzer**: signals can be looked at directly in time domain or in frequency domain
- Contrary to the SA, also the spectrum of non-periodic signals and transients can be observed
- Application: Observation of tune sidebands, transient behavior of a phase locked loop, etc.

◆ Coaxial measurement line

- old fashion method – no more in use but good for understanding of concept

◆ Network analyzer

- Excites a DUT (device under test, e.g. circuit, antenna, amplifier, etc.) network at a given CW frequency and measures response in magnitude and phase => **determines S-parameters**
- Covers a frequency range by measuring step-by-step at subsequent frequency points
- Application: characterization of passive and active components, time domain reflectometry by Fourier transformation of the reflection response, etc.

Superheterodyne Concept (1)

Design and its evolution

The diagram below shows the basic elements of a single conversion superheterodyne receiver. The essential elements are a local oscillator and a mixer, followed by a fixed-tuned filter and IF amplifier, and are common to all superhet circuits. [super ετερω δυναμις] a mixture of latin and greek ...

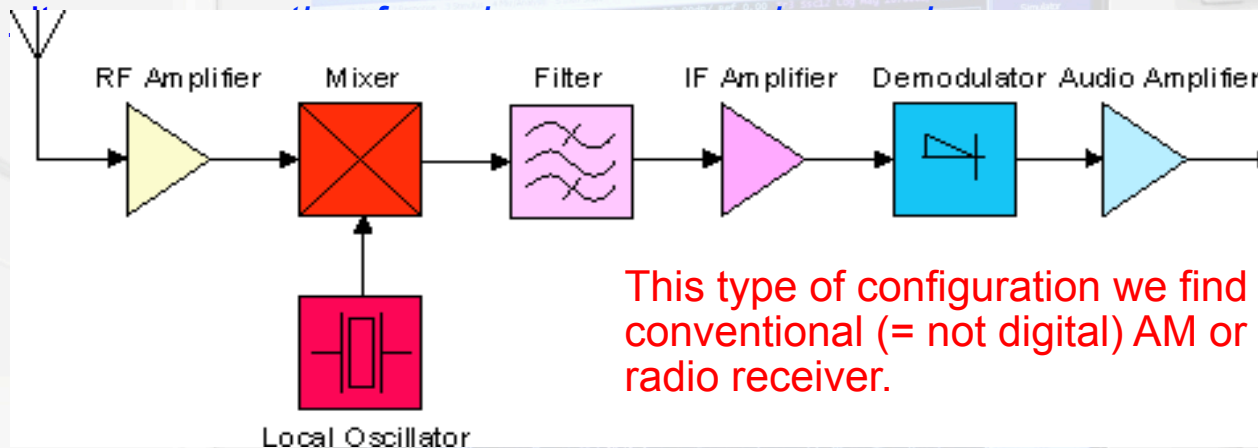

The advantage of this method, most parts of the radio's signal path need to be sensitive just within a narrow range of frequencies. The front end (the part before the frequency converter stage) however, has to operate over a wide frequency range. For example, the FM radio front end need to cover 87–108 MHz, while most gain stages operated at a fixed intermediate frequency (IF) of 10.7 MHz. This minimized the number of stages with frequency tuning requirements.

Superheterodyne Concept (2)

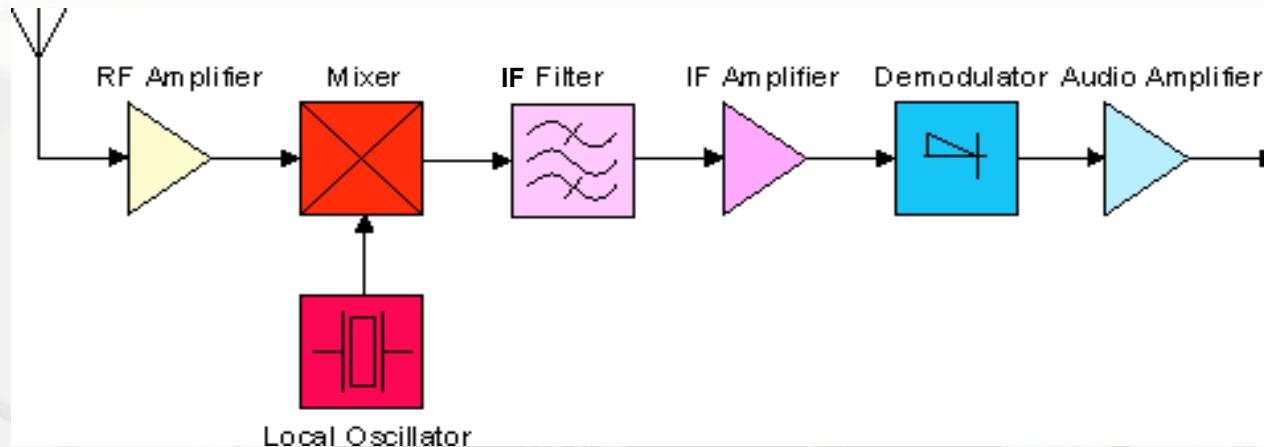

RF Amplifier = wideband front end amplification (RF = radio frequency)

The Mixer can be seen as an analog multiplier which multiplies the RF signal with the **LO** (local oscillator) signal.

The local oscillator has its name because it's an oscillator located in the receiver locally, not far away like a radio transmitter.

IF stands for **intermediate frequency**.

The demodulator typically is an amplitude modulation (AM) demodulator (envelope detector) or a frequency modulation (FM) demodulator, implemented e.g. as a PLL (phase locked loop).

The tuning of a classical radio receiver is performed by changing the frequency of the LO, the IF stays constant.

Example for the Application of the Superheterodyne Concept in a Spectrum Analyzer

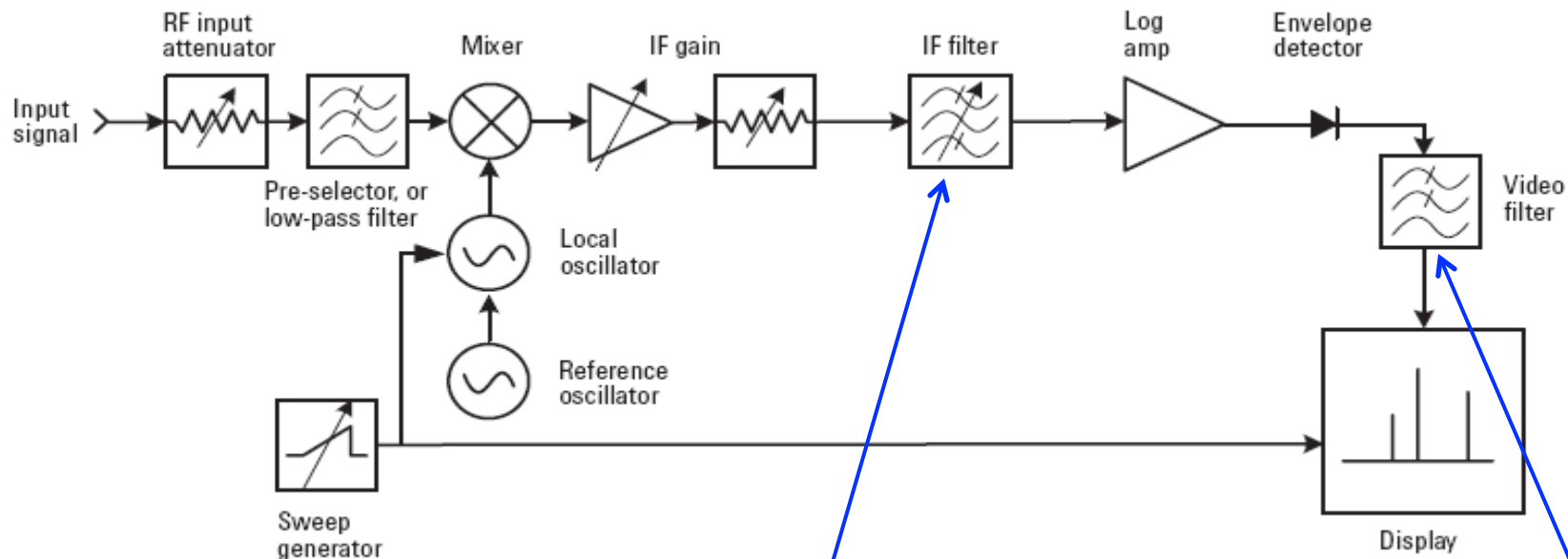

The center frequency is fixed, but the bandwidth of the IF filter can be modified.

The video filter is a simple low-pass with variable bandwidth before the signal arrives at the vertical deflection plates of the cathode ray tube (CRT).

Agilent, 'Spectrum Analyzer Basics,'
Application Note 150, page 10 f.

Another basic measurement example

- ◆ 30 cm long concentric cable with vacuum or air between conductors ($\epsilon_r=1$) and with characteristic impedance $Z_c=50 \Omega$.
- ◆ An RF generator with 50Ω source impedance Z_G is connected at one side of this line.
- ◆ Other side terminated with load impedance: $Z_L=50 \Omega$; $\infty \Omega$ and 0Ω
- ◆ Oscilloscope with high impedance probe connected at port 1

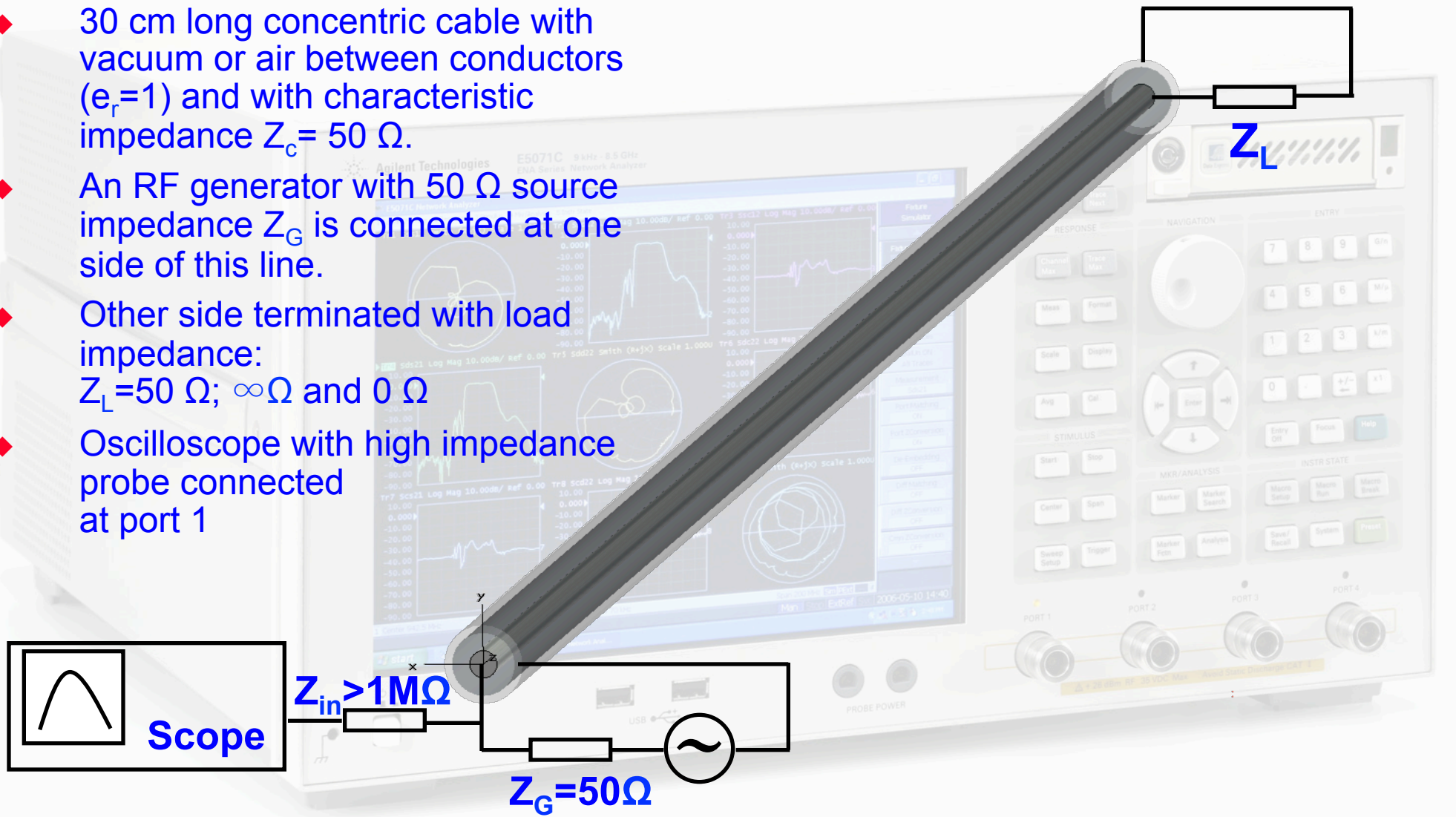

Measurements in time domain using the Oscilloscope

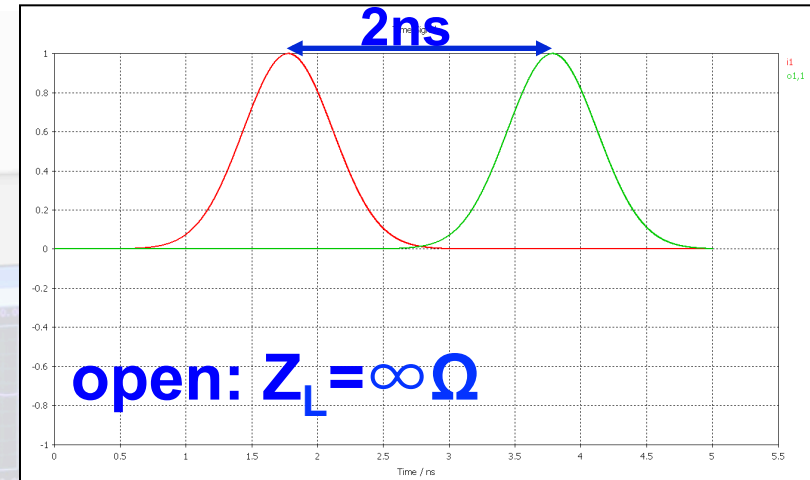
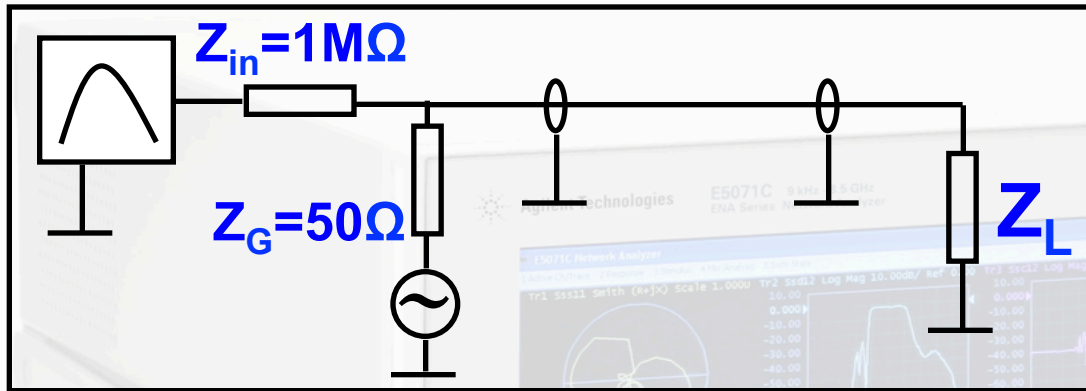

total reflection; reflected signal in phase, delay $2 \times 1\text{ ns}$.

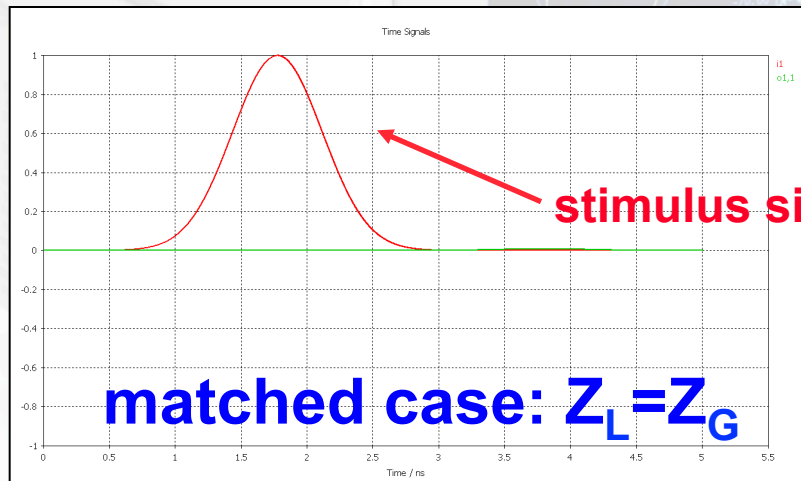

no reflection

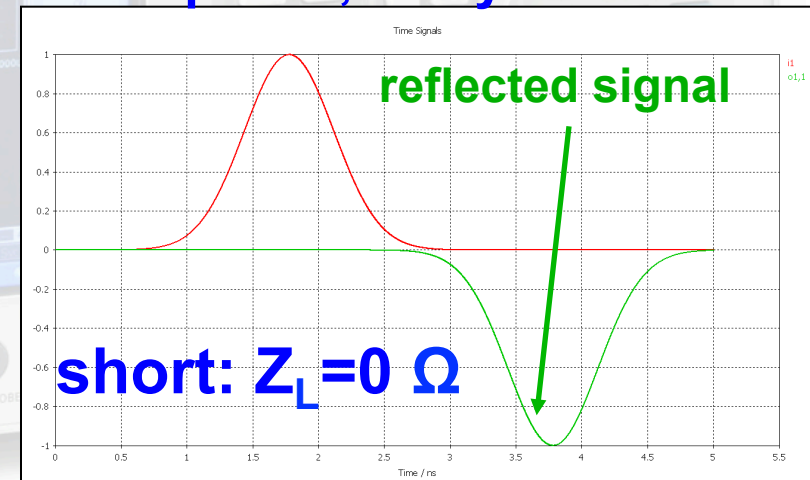

total reflection; reflected signal in contra phase

Impedance matching: How good is our termination?

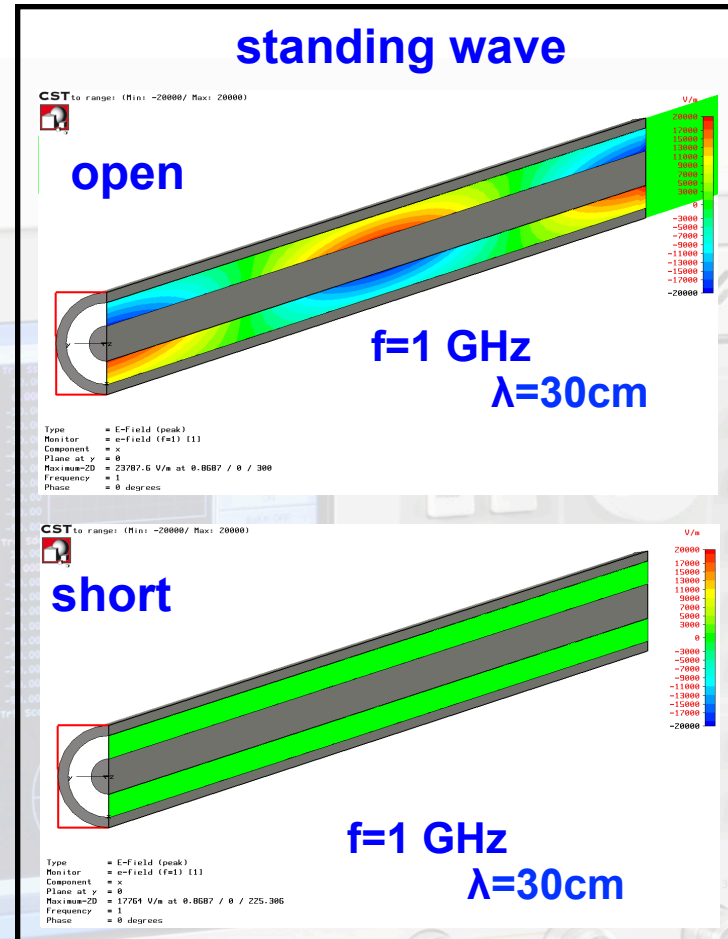
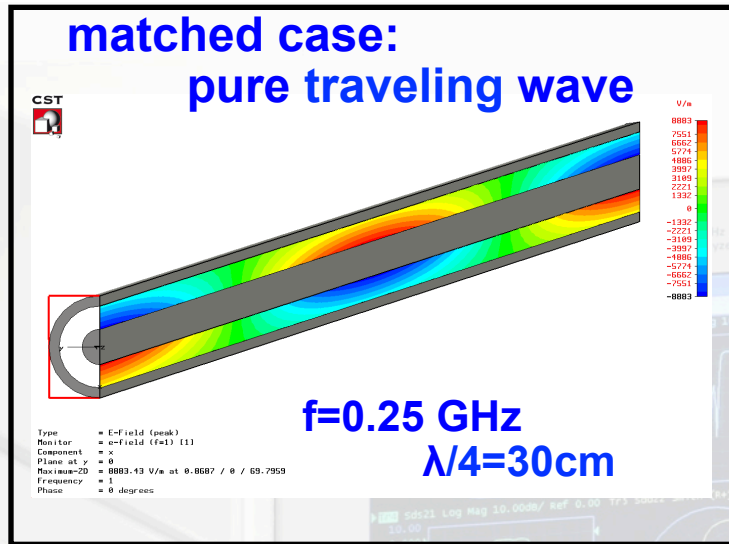

Caution: the color coding corresponds to the radial electric field strength – these are not scalar equipotential lines, which are anyway not defined for time varying fields

- ◆ The patterns for the short and open case are equal; only the phase is opposite, which correspond to different position of nodes.
- ◆ In case of perfect matching: traveling wave only. Otherwise mixture of traveling and standing waves.

Voltage Standing Wave Ratio (1)

Origin of the term “**VOLTAGE** Standing Wave Ratio – VSWR”:

In the “good old days”, when there were no Vector Network Analyzers (VNA) available, the reflection coefficient of some DUT (device under test) was determined with the coaxial measurement line.

Coaxial measurement line: A coaxial line with a narrow slot (slit) in longitudinal direction. In this slit a small E-field probe connected to a crystal detector (detector diode) is moved along the line. By measuring the ratio between **maximum** and **minimum** electric field is detected by the probe, and recorded as **voltage** with respect to the probe's **position**. From those maxima and minima the **reflection coefficient** of the DUT, connector to the end of the line, was determined.

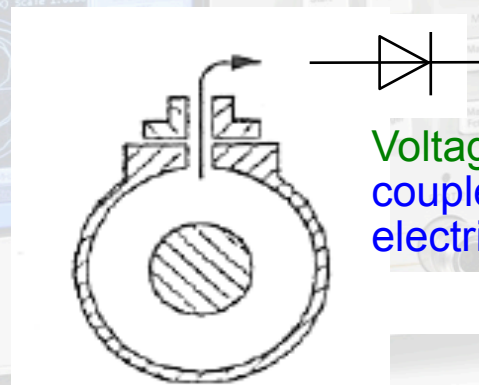
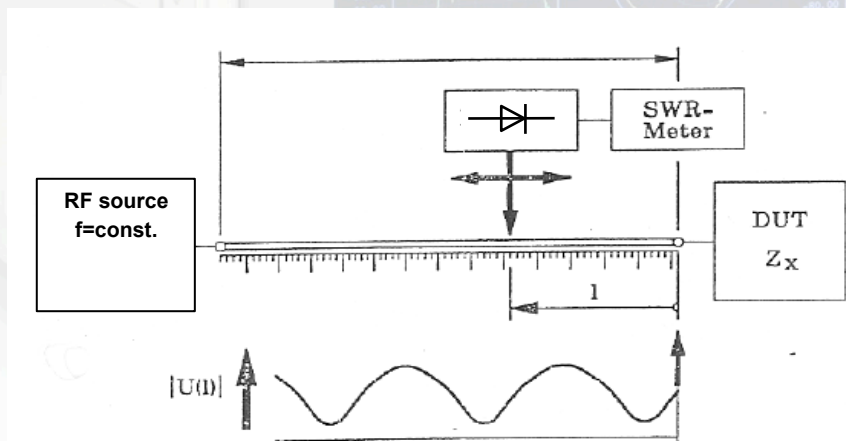

Cross-section of the coaxial measurement line

Voltage Standing Wave Ratio (2)

VOLTAGE DISTRIBUTION ON LOSSLESS TRANSMISSION LINES

For an perfectly terminated transmission-line the magnitude of voltage and current are constant along the line, their phase vary linearly.

In presence of a notable load reflection the voltage and current distribution along a transmission line are no longer uniform but exhibit characteristic ripples. The phase pattern resembles more and more to a staircase rather than a ramp.

A frequently used term is the “Voltage Standing Wave Ratio (VSWR)”, which expresses the ratio between maximum and minimum voltage along the line. It is related to the reflection Γ at the load impedance of the line:

$$V_{\max} = |a| + |b| \quad VSWR = \frac{V_{\max}}{V_{\min}} = \frac{|a| + |b|}{|a| - |b|} = \frac{1 + |\Gamma|}{1 - |\Gamma|}$$
$$V_{\min} = |a| - |b|$$

a : forward traveling wave, b : backward traveling wave

Remember: the reflection coefficient Γ is defined via the **ELECTRIC FIELD** of the incident and reflected wave. This is historically related to the measurement method described here. We know that an open has a reflection coefficient of $\Gamma=+1$ and the short of $\Gamma=-1$. When referring to the magnetic field it would be just opposite.

Voltage Standing Wave Ratio (3)

Γ	VSWR	Refl. Power $ \Gamma ^2$
0.0	1.00	1.00
0.1	1.22	0.99
0.2	1.50	0.96
0.3	1.87	0.91
0.4	2.33	0.84
0.5	3.00	0.75
0.6	4.00	0.64
0.7	5.67	0.51
0.8	9.00	0.36
0.9	19	0.19
1.0	∞	0.00

With a simple detector diode we are only able to measure the signal amplitude, we cannot measure the phase!

Why? – What would be required to measure the phase?

Answer: Because there is no phase reference. With a mixer operating as a phase detector and connected to a reference signal this would be possible.

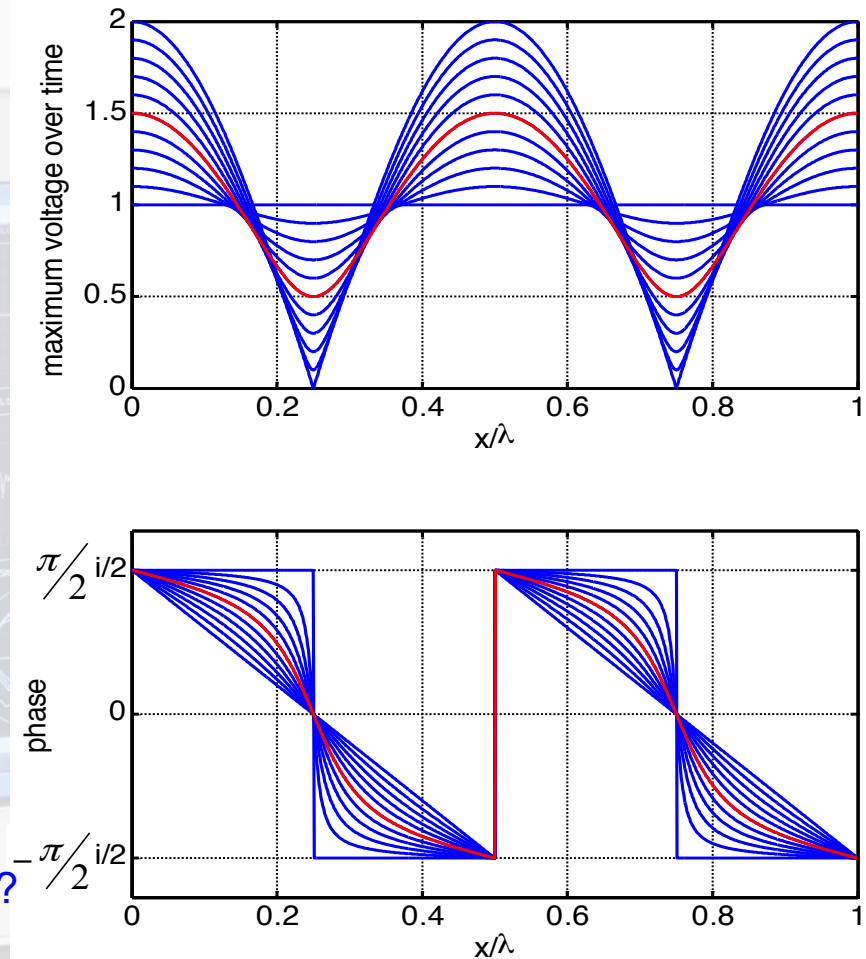

S-parameters- introduction (1)

Look at the windows of this car:

- part of the light incident on the windows is reflected
- the other part of the light is transmitted

- ◆ The optical reflection and transmission coefficients of the car window characterize amounts of transmitted and reflected light.
- ◆ Correspondingly: S-parameters characterize reflection and transmission of (voltage) waves through n-port electrical network
- ◆ Caution: In RF and microwave engineering reflection coefficients are expressed in terms of voltage ratio whereas in optics in terms of power ratio.

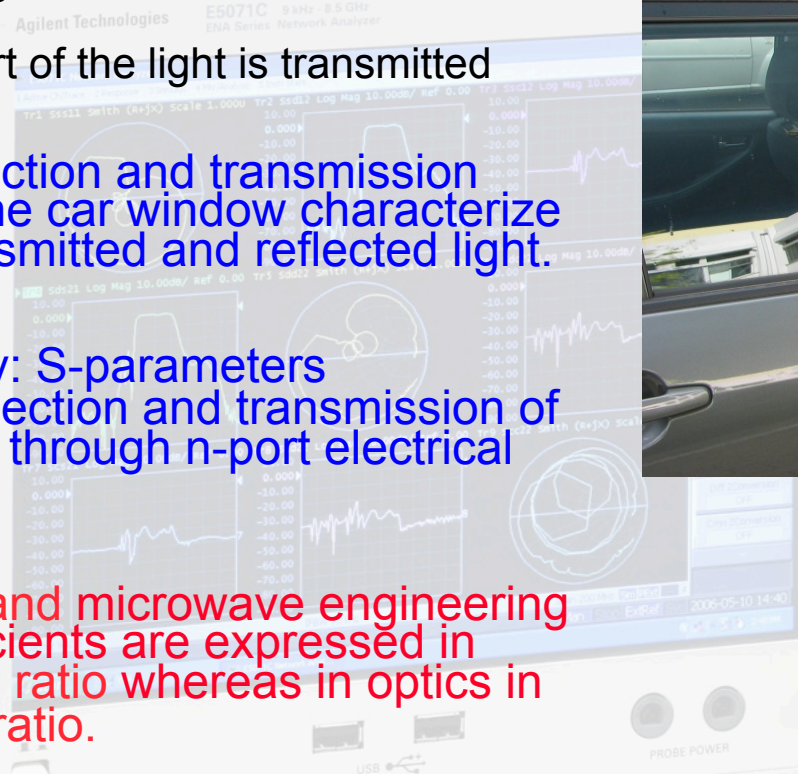

S-parameters- introduction (2)

- ◆ As the linear dimensions of an object approaches one tenth of the (free space) wavelength this circuit element cannot anymore modeled precisely by a single lumped element.
- ◆ In 1965 Kurokawa introduced „power waves” instead of voltage and current waves used so far
K. Kurokawa, 'Power Waves and the Scattering Matrix,' IEEE Transactions on Microwave Theory and Techniques, Vol. MTT-13, No. 2, March, 1965.
- ◆ The essential difference between power wave and current wave is a normalization to square root of characteristic impedance $\sqrt{Z_c}$
- ◆ The abbreviation *S* has been derived from the word *scattering*.
- ◆ Since S-parameters are defined based on traveling waves
-> the absolute value (modulus) does not vary along a lossless transmission-line
-> they can be measured, e.g. of a DUT (Device Under Test) located at some distance from an S-parameter measurement instrument (like Network Analyzer)
- ◆ How are the S-parameters defined?

Simple example: a generator with a load

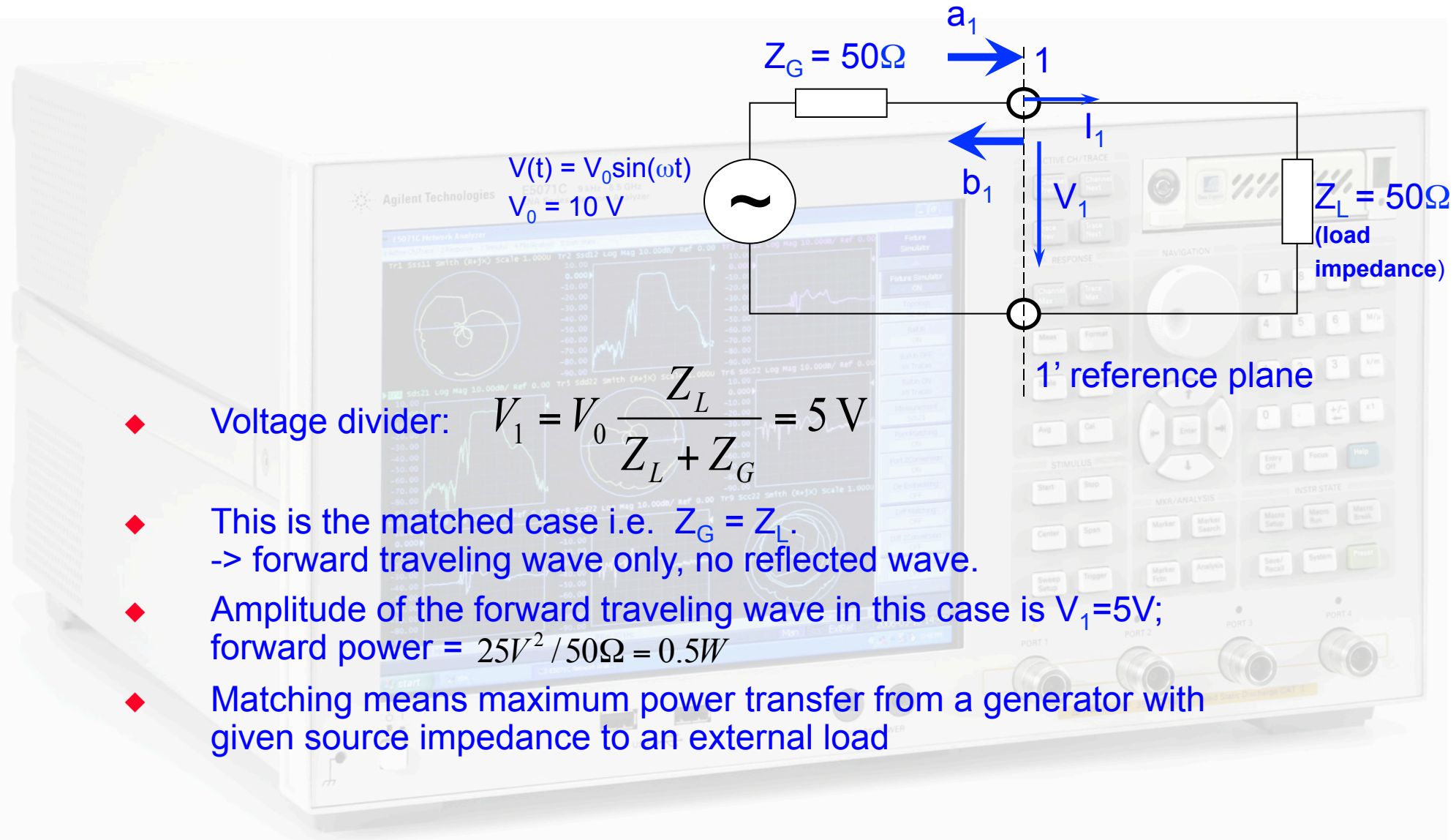

- ◆ Voltage divider: $V_1 = V_0 \frac{Z_L}{Z_L + Z_G} = 5\text{ V}$
- ◆ This is the matched case i.e. $Z_G = Z_L$.
-> forward traveling wave only, no reflected wave.
- ◆ Amplitude of the forward traveling wave in this case is $V_1 = 5\text{ V}$;
forward power = $25V^2 / 50\ \Omega = 0.5\text{ W}$
- ◆ Matching means maximum power transfer from a generator with given source impedance to an external load

Power waves definition (1)

(*see Kurokawa paper):

$$a_1 = \frac{V_1 + I_1 Z_c}{2\sqrt{Z_c}},$$

$$b_1 = \frac{V_1 - I_1 Z_c}{2\sqrt{Z_c}},$$

where the characteristic impedance $Z_c = Z_G$

$$V(t) = V_0 \sin(\omega t)$$

$$V_0 = 10 \text{ V}$$

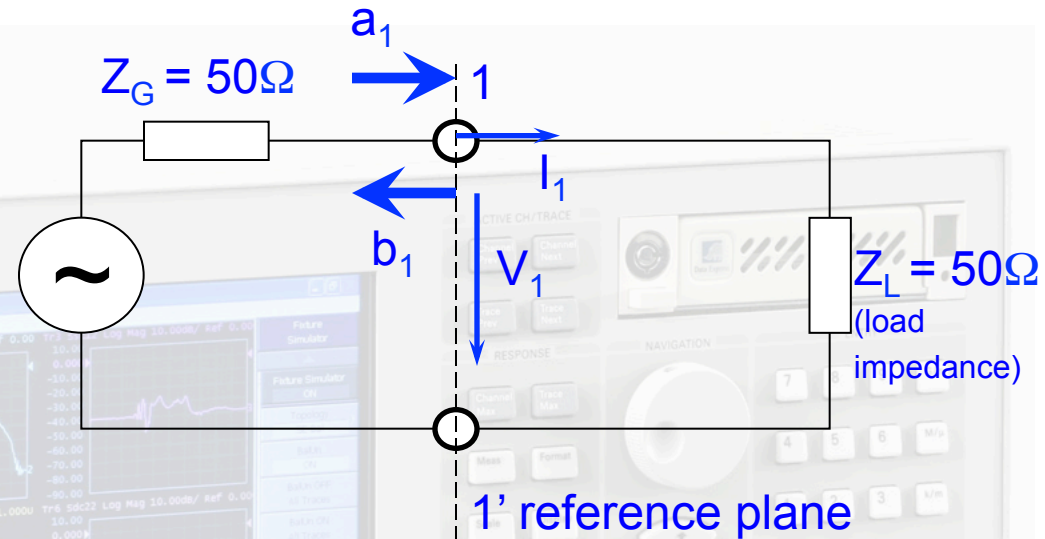

Definition of power waves:

- ◆ a_1 is the wave incident to the terminating one-port (Z_L)
- ◆ b_1 is the wave running out of the terminating one-port
- ◆ a_1 has a peak amplitude of $5\text{V} / \sqrt{50\Omega}$; voltage wave would be just 5V.
- ◆ What is the amplitude of b_1 ? Answer: $b_1 = 0$.
- ◆ **Dimension:** $[V/\sqrt{Z}]$, in contrast to voltage or current waves

Caution! US notation: power = $|a|^2$ whereas European notation (often): power = $|a|^2/2$

Power waves definition (2)

$$a_{-1} = \frac{V_1 + I_1 Z_c}{2\sqrt{Z_c}},$$

$$b_{-1} = \frac{V_1 - I_1 Z_c}{2\sqrt{Z_c}}, \text{ with } Z_c = Z_G$$

$$V(t) = V_0 \sin(\omega t)$$

$$V_0 = 10 \text{ V}$$

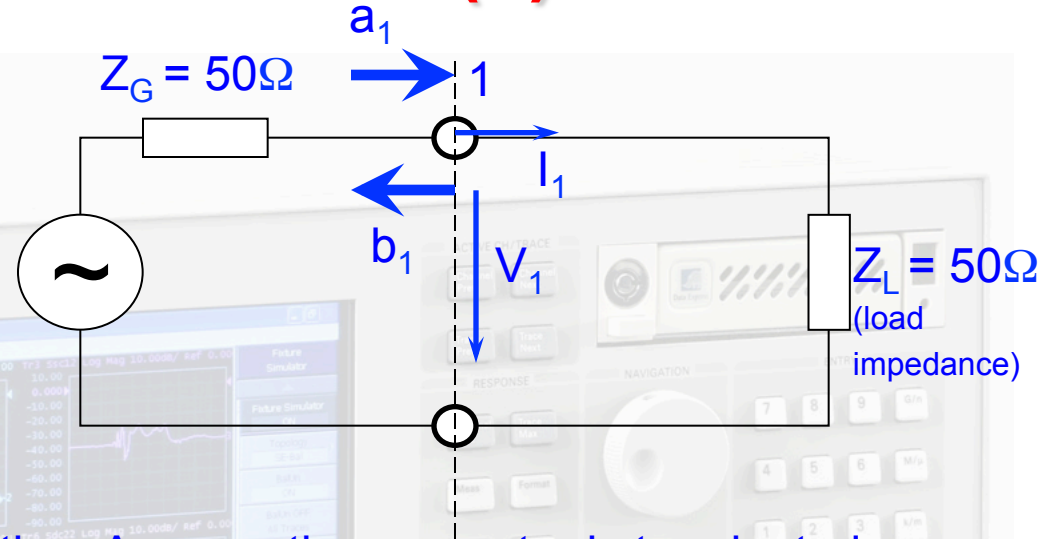

A more practical method for the determination: Assume the generator is terminated with an external load equal to the generator source impedance. In this matched case only a forward traveling wave exists (no reflection). Thus, the voltage on the external (load) resistor is equal to the voltage of the outgoing wave.

$$a_{-1} = \frac{V_0}{2\sqrt{Z_c}} = \frac{\text{incident voltage wave (port1)}}{\sqrt{Z_c}} = \frac{V_1^{inc}}{\sqrt{Z_c}}$$

$$b_{-1} = \frac{\text{reflected voltage wave (port1)}}{\sqrt{Z_c}} = \frac{V_1^{refl}}{\sqrt{Z_c}}$$

$$V_i = \sqrt{Z_c} (a_i + b_i) = V_i^{inc} + V_i^{refl}$$

$$I_i = \frac{1}{\sqrt{Z_c}} (a_i - b_i) = \frac{V_i^{refl}}{Z_c}$$

Caution! US notation: power = $|a|^2$ whereas European notation (often): power = $|a|^2/2$

Example: a 2-port (2)

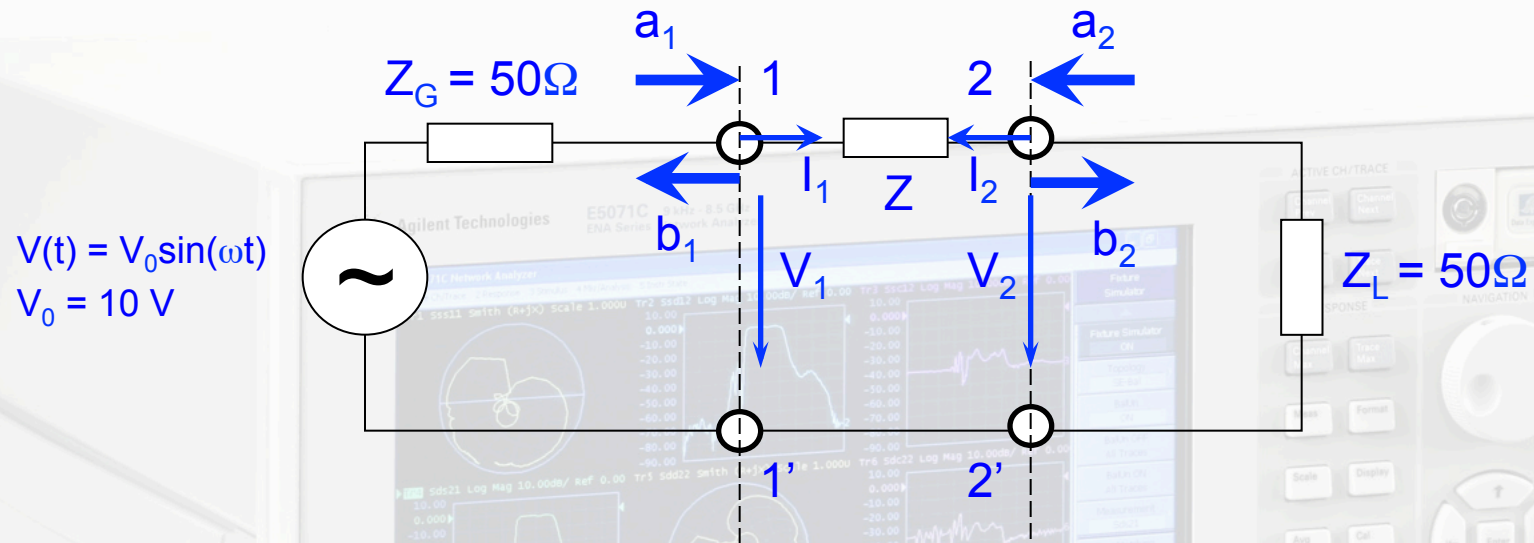

- ◆ A 2-port (or 4-pole) as shown above, is connected between the generator with source impedance and the load
- ◆ Strategy for a practical solution: Determine currents and voltages at all ports (classical network calculation techniques), and from there determine a and b for each port.
- ◆ General definition of a and b traveling waves:
The wave " a_n " always travels towards the N-port (incident waves), while the wave " b_n " always travels away from an N-port (reflected waves).

Example : a 2-port (2)

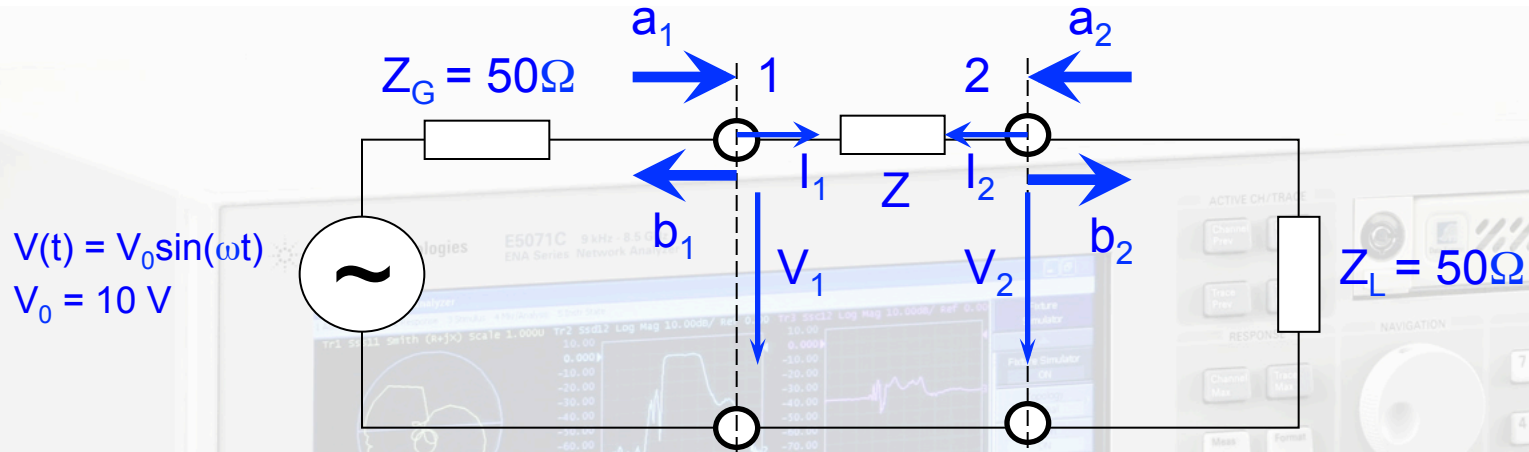

◆ Independent variables a_1 and a_2 are normalized incident voltages waves:

$$a_1 = \frac{V_1 + I_1 Z_c}{2\sqrt{Z_c}} = \frac{\text{incident voltage wave (port1)}}{\sqrt{Z_c}} = \frac{V_1^{inc}}{\sqrt{Z_c}},$$

$$a_2 = \frac{V_2 + I_2 Z_c}{2\sqrt{Z_c}} = \frac{\text{incident voltage wave (port2)}}{\sqrt{Z_c}} = \frac{V_2^{inc}}{\sqrt{Z_c}}$$

◆ Dependent variables b_1 and b_2 are normalized reflected voltages waves:

$$b_1 = \frac{V_1 - I_1 Z_c}{2\sqrt{Z_c}} = \frac{\text{reflected voltage wave (port1)}}{\sqrt{Z_c}} = \frac{V_1^{refl}}{\sqrt{Z_c}}$$

$$b_2 = \frac{V_2 - I_2 Z_c}{2\sqrt{Z_c}} = \frac{\text{reflected voltage wave (port2)}}{\sqrt{Z_c}} = \frac{V_2^{refl}}{\sqrt{Z_c}}$$

S-Parameters – definition (1)

The linear equations expressing a two-port network are:

$$b_1 = S_{11}a_1 + S_{12}a_2$$

$$b_2 = S_{22}a_2 + S_{21}a_1$$

The S-parameters S_{11} , S_{22} , S_{21} , S_{12} are defined as:

$$S_{11} = \left. \frac{b_1}{a_1} \right|_{a_2=0} \equiv \text{Input reflection coeff. } (Z_L = Z_c \Rightarrow a_2 = 0)$$

$$S_{22} = \left. \frac{b_2}{a_2} \right|_{a_1=0} \equiv \text{Output reflection coeff. } (Z_G = Z_c \Rightarrow a_1 = 0)$$

$$S_{21} = \left. \frac{b_2}{a_1} \right|_{a_2=0} \equiv \text{Forward transmission gain}$$

$$S_{12} = \left. \frac{b_1}{a_2} \right|_{a_1=0} \equiv \text{Backward transmission gain}$$

S-Parameters – definition (2)

$$S_{11} = \frac{b_1}{a_1} = \frac{\frac{V_1}{I_1} - Z_c}{\frac{V_1}{I_1} + Z_c} = \frac{Z_1 - Z_c}{Z_1 + Z_c},$$

$$Z_1 = Z_c \frac{(1 + S_{11})}{(1 - S_{11})}, \quad \text{whereas : } Z_1 = \frac{V_1}{I_1} \text{ is the input impedance at port 1}$$

$$|S_{11}|^2 = \frac{\text{Power reflected from input}}{\text{Power incident on input}}$$

$$|S_{22}|^2 = \frac{\text{Power reflected from output}}{\text{Power incident on output}}$$

$$|S_{21}|^2 = \text{Forward transmitted power with } Z_S = Z_L = Z_c$$

$$|S_{12}|^2 = \text{Backward transmitted power with } Z_S = Z_L = Z_c$$

Here the US notion is used, where power = $|a|^2$.

European notation (often): power = $|a|^2/2$

These conventions have no impact on the S-parameters, they are only relevant for absolute power calculations

The Scattering-Matrix (1)

Waves traveling **towards** the n-port: $(a) = (a_1, a_2, a_3, \dots, a_n)$

Waves traveling **away** from the n-port: $(b) = (b_1, b_2, b_3, \dots, b_n)$

The relation between a_i and b_i ($i = 1..n$) can be written as a **system of n linear equations** (a_i = the independent variable, b_i = the dependent variable):

one - port	$b_1 = S_{11}a_1 + S_{12}a_2 + S_{13}a_3 + S_{14}a_4 + \dots$
two - port	$b_2 = S_{21}a_1 + S_{22}a_2 + S_{23}a_3 + S_{24}a_4 + \dots$
three - port	$b_3 = S_{31}a_1 + S_{32}a_2 + S_{33}a_3 + S_{34}a_4 + \dots$
four - port	$b_4 = S_{41}a_1 + S_{42}a_2 + S_{43}a_3 + S_{44}a_4 + \dots$

In compact matrix notation, these equations can also be written as:

$$(b) = (S)(a)$$

The Scattering Matrix (2)

The simplest form is a passive **one-port (2-pole)** with a reflection coefficient Γ .

$$(S) = S_{11} \rightarrow b_1 = S_{11}a_1$$

From the reflection coefficient Γ follows:

$$S_{11} = \frac{b_1}{a_1} = \Gamma$$

Reference plane

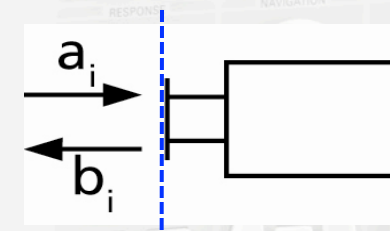

What is the difference between Γ and S_{11} or S_{22} ?

- ◆ Γ is a general definition of a complex reflection coefficient.
- ◆ For a proper S-parameter measurement all ports of the Device Under Test (DUT), including the generator port must be terminated by their characteristic impedance in order to assure that waves traveling away from the DUT (b_n -waves) experience no (multiple) reflections, i.e. converting them into a_n -waves.

The Scattering Matrix (3)

Two-port (4-pole)

$$(S) = \begin{bmatrix} S_{11} & S_{12} \\ S_{21} & S_{22} \end{bmatrix} \quad \begin{aligned} b_1 &= S_{11}a_1 + S_{12}a_2 \\ b_2 &= S_{21}a_1 + S_{22}a_2 \end{aligned}$$

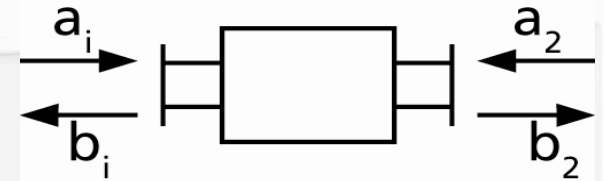

An unmatched load, present at port 2 with a reflection coefficient Γ_{load} transfers to the input port as

$$\Gamma_{in} = S_{11} + S_{21} \frac{\Gamma_{load}}{1 - S_{22}\Gamma_{load}} S_{12}$$

AGAIN:

- ◆ For a proper S-parameter measurement all ports of the Device Under Test (DUT), including the generator port have to be terminated with their characteristic impedance!
- ◆ This assures, all waves traveling away from the DUT (reflected b_n -waves) are perfectly absorbed and do not experience multiple reflections (convert into a_n -waves, and take the measurement in an undefined state).

Evaluation of scattering parameters (1)

Basic relation:

$$b_1 = S_{11}a_1 + S_{12}a_2$$

$$b_2 = S_{21}a_1 + S_{22}a_2$$

Evaluate S_{11} , S_{21} : ("forward" parameters, assuming port 1 = input, port 2 = output e.g. of an amplifier, filter, etc.)

- connect a generator at port 1 of the DUT, and inject a wave a_1
- connect reflection-free terminating lead at port 2 to assure $a_2 = 0$
- calculate/measure
 - wave b_1 (reflection at port 1, no transmission from port2)
 - wave b_2 (reflection at port 2, no transmission from port1)
- evaluate

$$S_{11} = \left. \frac{b_1}{a_1} \right|_{a_2=0} \quad \text{"input reflection factor"}$$

$$S_{21} = \left. \frac{b_2}{a_1} \right|_{a_2=0} \quad \text{"forward transmission factor"}$$

DUT = Device Under Test

Matched receiver or detector

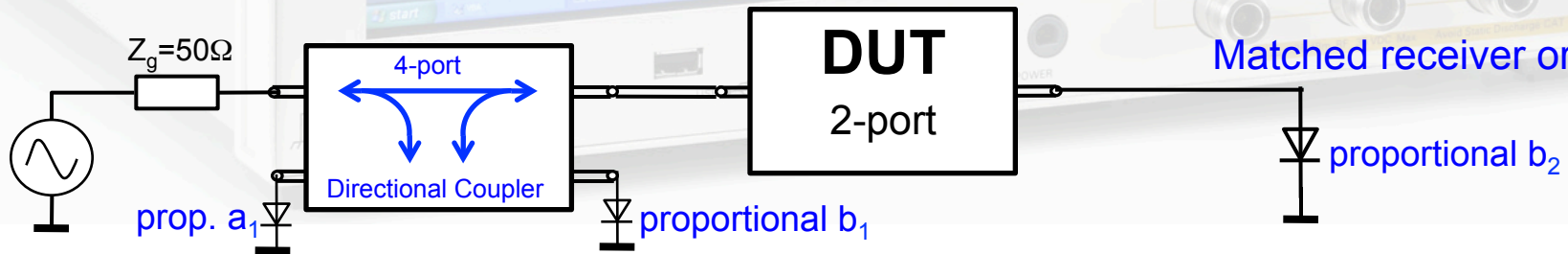

Evaluation of scattering parameters (2)

Evaluate S_{12} , S_{22} : ("backward" parameters)

- interchange generator and load
- proceed in analogy to the forward parameters, i.e. inject wave a_2 and assure $a_1 = 0$
- evaluate

$$S_{12} = \frac{b_1}{a_2} \Big|_{a_1=0} \quad \text{"backward transmission factor"}$$

$$S_{22} = \frac{b_2}{a_2} \Big|_{a_1=0} \quad \text{"output reflection factor"}$$

For a proper S-parameter measurement all ports of the Device Under Test (DUT) including the generator port must be terminated with their characteristic impedance to assure, waves traveling away from the DUT (b_n -waves) are not reflected twice and convert into a_n -waves. (cannot be stated often enough...!)

The Smith Chart (1)

The Smith Chart (in impedance coordinates) represents the complex Γ -plane within the unit circle. It is a conformal mapping of the complex Z -plane on the Γ -plane applying the transformation:

$$\Gamma = \frac{Z - Z_c}{Z + Z_c}$$

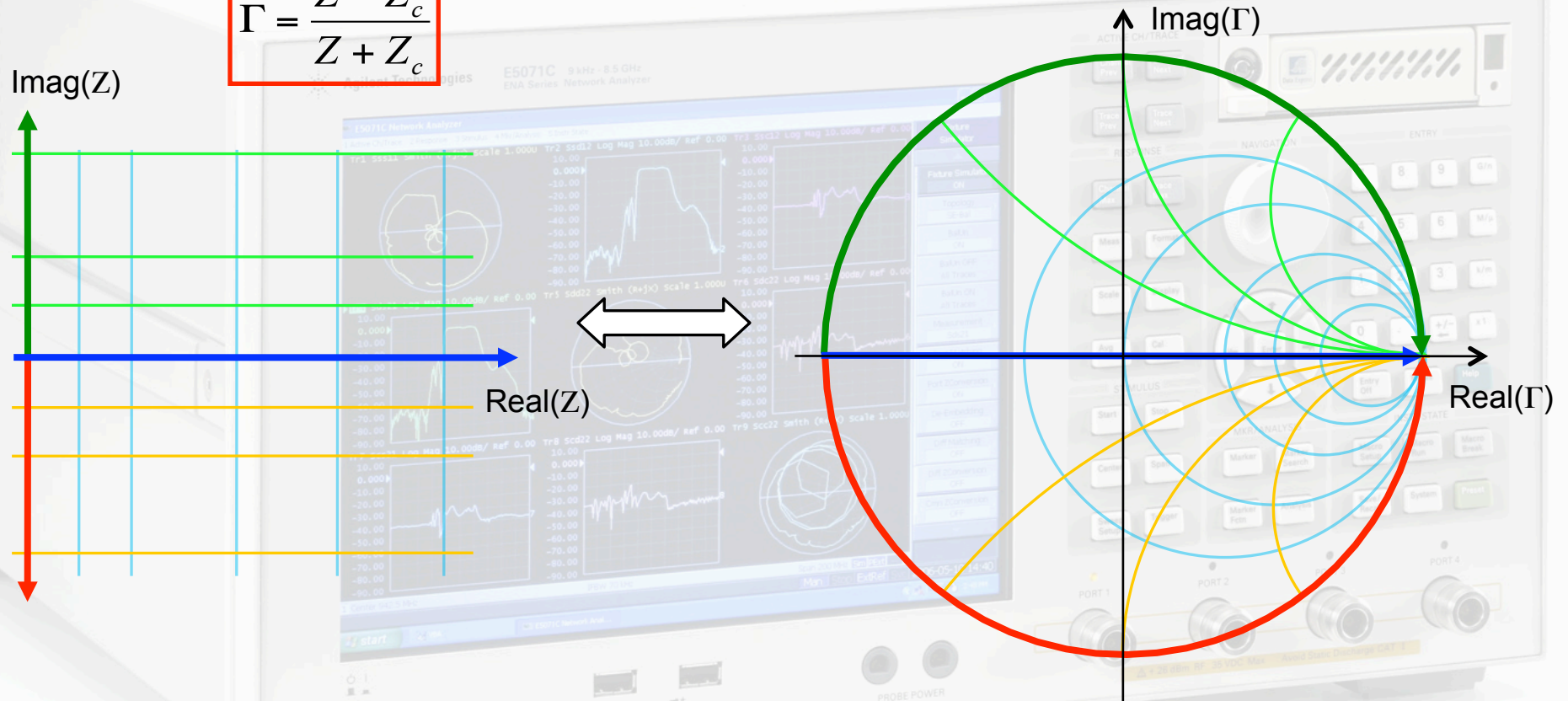

→ The real positive half plane of Z is thus transformed into the interior of the unit circle!

The Smith Chart (2)

This is a “bilinear” transformation with the following properties:

- generalized circles are transformed into generalized circles
 - circle \rightarrow circle
 - straight line \rightarrow circle
 - circle \rightarrow straight line
 - straight line \rightarrow straight line
 - angles are preserved locally
- a straight line is nothing else than a circle with infinite radius
a circle is defined by 3 points
a straight line is defined by 2 points

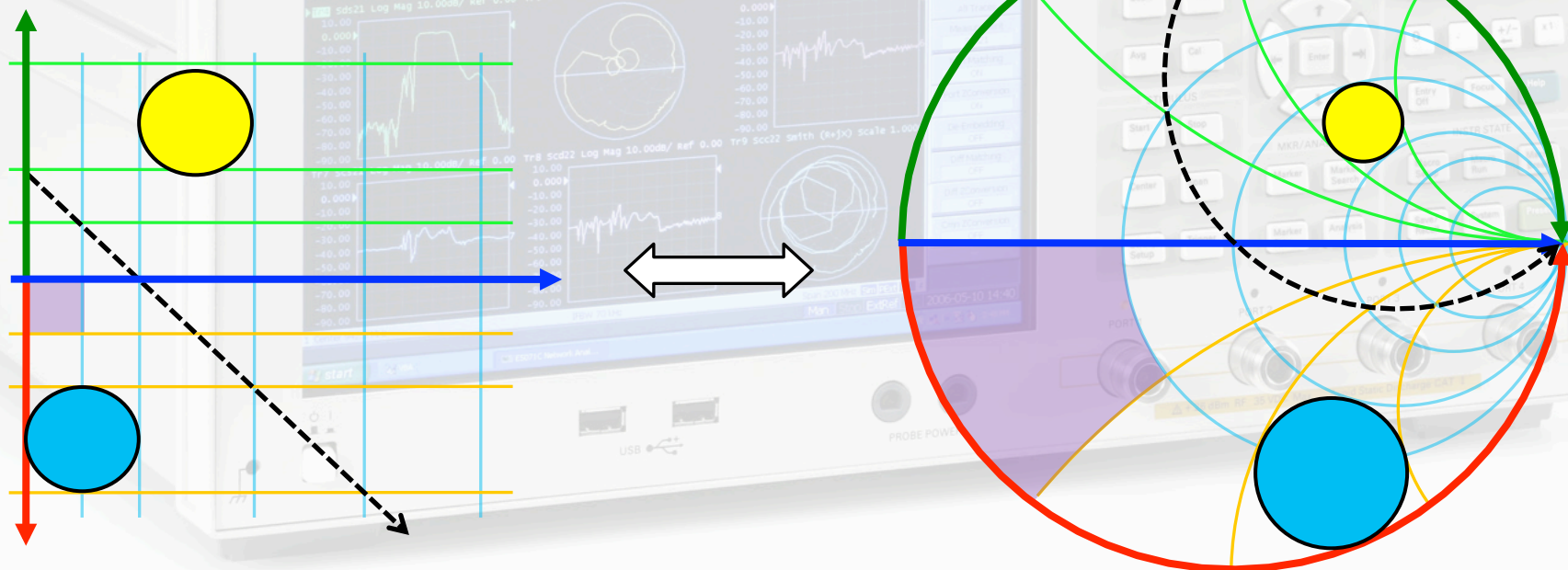

The Smith Chart (3)

All impedances Z are usually normalized by

$$z = \frac{Z}{Z_c}$$

where Z_0 is some characteristic impedance (e.g. 50 Ohm). The general form of the transformation can then be written as

$$\Gamma = \frac{z-1}{z+1} \quad \text{resp.} \quad z = \frac{1+\Gamma}{1-\Gamma}$$

This mapping offers several practical advantages:

1. The diagram includes all “passive” impedances, i.e. those with positive real part, from zero to infinity in a handy format. Impedances with negative real part (“active device”, e.g. reflection amplifiers) would be outside the (normal) Smith chart.
2. The mapping converts impedances or admittances into reflection factors and vice-versa. This is particularly interesting for studies in the radiofrequency and microwave domain where electrical quantities are usually expressed in terms of “direct” or “forward” waves and “reflected” or “backward” waves. This replaces the notation in terms of currents and voltages used at lower frequencies. Also the reference plane can be moved very easily using the Smith chart.

The Smith Chart (4)

The Smith Chart (*Abaque Smith* in French) is the linear representation of the complex reflection factor

$$\Gamma = \frac{b}{a}$$

i.e. the ratio backward/forward wave.

The upper half of the Smith-Chart is “inductive” = positive imaginary part of impedance, the lower half is “capacitive” = negative imaginary part.

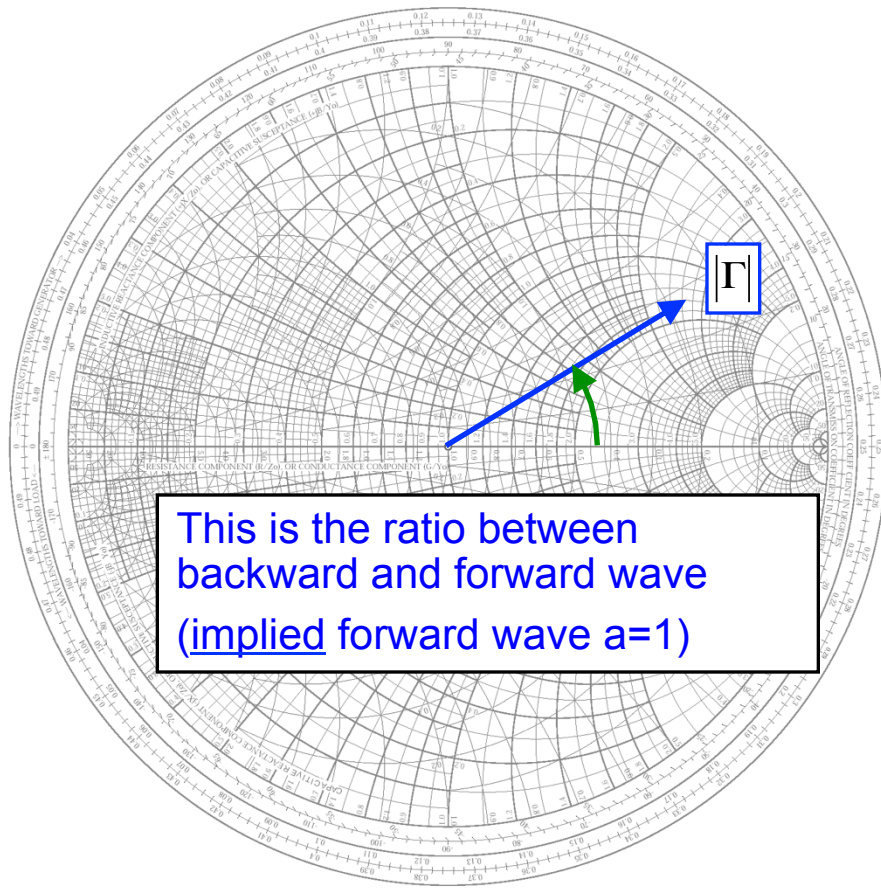

The Smith Chart (5)

3. The distance from the center of the diagram is directly proportional to the magnitude of the reflection factor. In particular, the perimeter of the diagram represents total reflection, $|\Gamma|=1$. This permits easy visualization matching performance.

(Power dissipated in the load) = (forward power) – (reflected power)

$$P = |a|^2 - |b|^2$$

$$= |a|^2 (1 - |\Gamma|^2)$$

available
source power

“(mismatch)”
loss

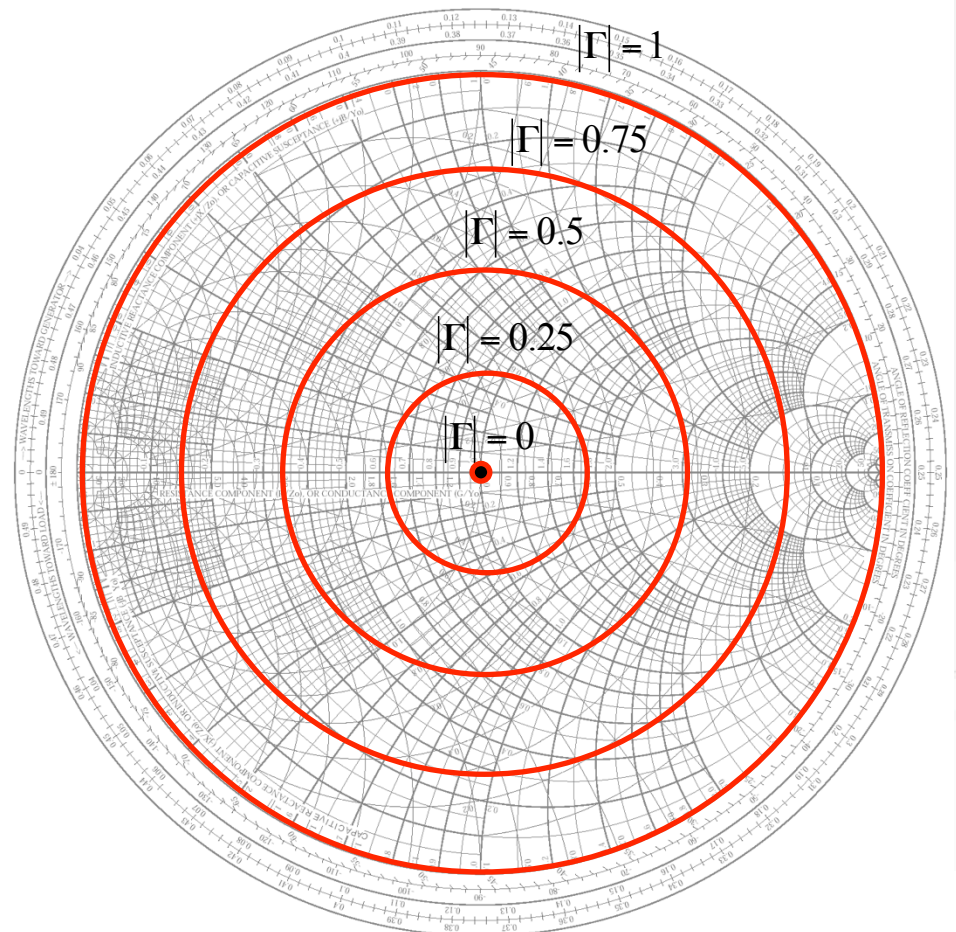

Important points

Important Points:

- ◆ Short Circuit
 $\Gamma = -1, z = 0$
- ◆ Open Circuit
 $\Gamma = 1, z \rightarrow \infty$
- ◆ Matched Load
 $\Gamma = 0, z = 1$
- ◆ On circle $\Gamma = 1$
lossless element
- ◆ Outside circle $\Gamma = 1$
active element, for instance tunnel diode reflection amplifier

Short Circuit

$$z = 0$$

$$\Gamma = -1$$

Open Circuit

$$z = \infty$$

$$\Gamma = +1$$

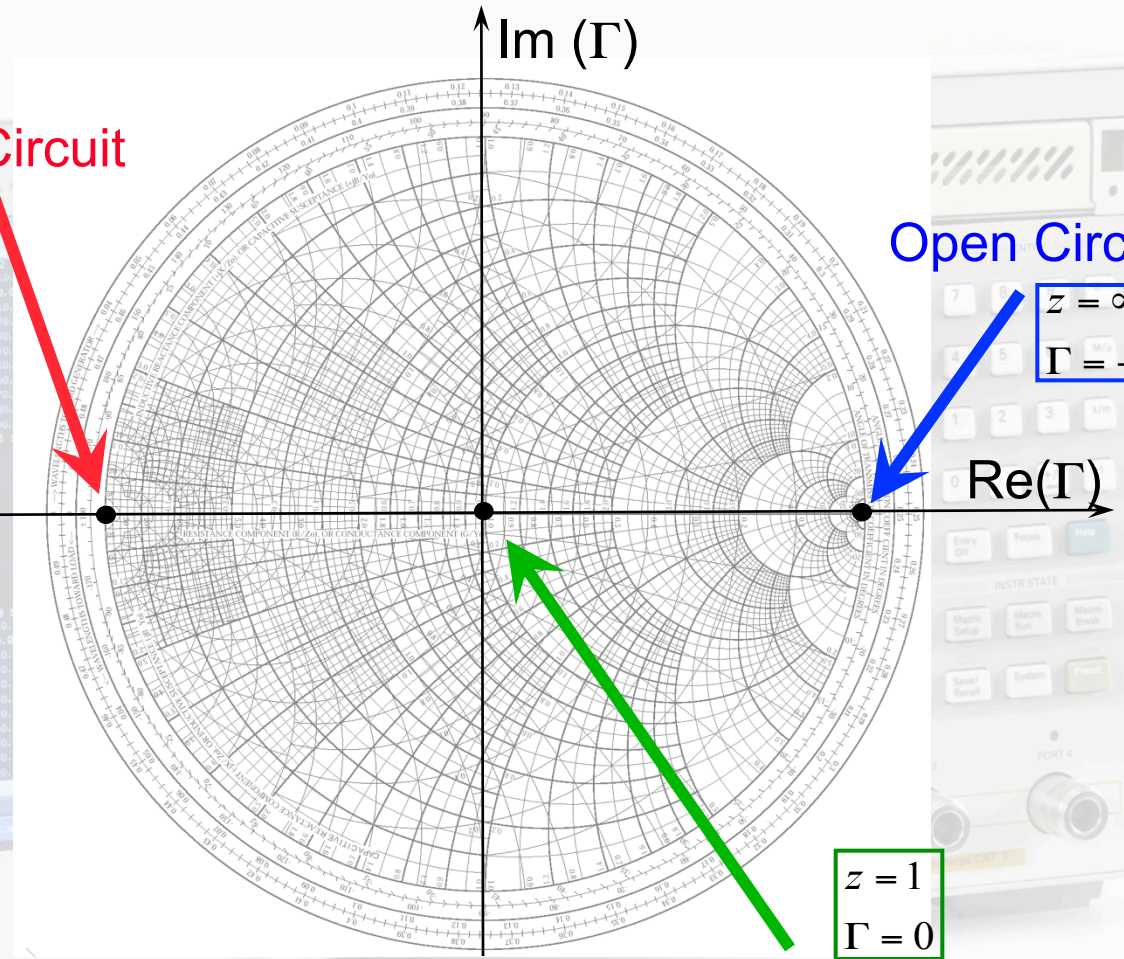

$$z = 1$$

$$\Gamma = 0$$

Matched Load

Coming back to our example

matched case:
pure traveling wave=> no reflection

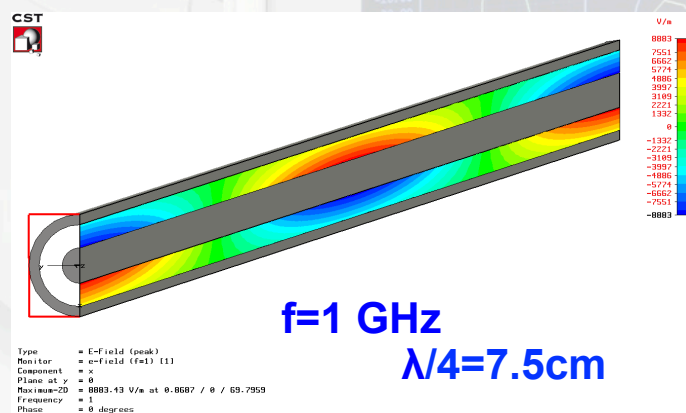
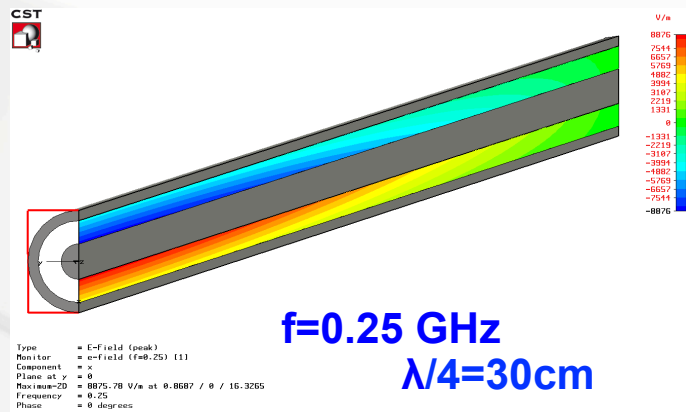

Coax cable with vacuum or air
with a length of 30 cm

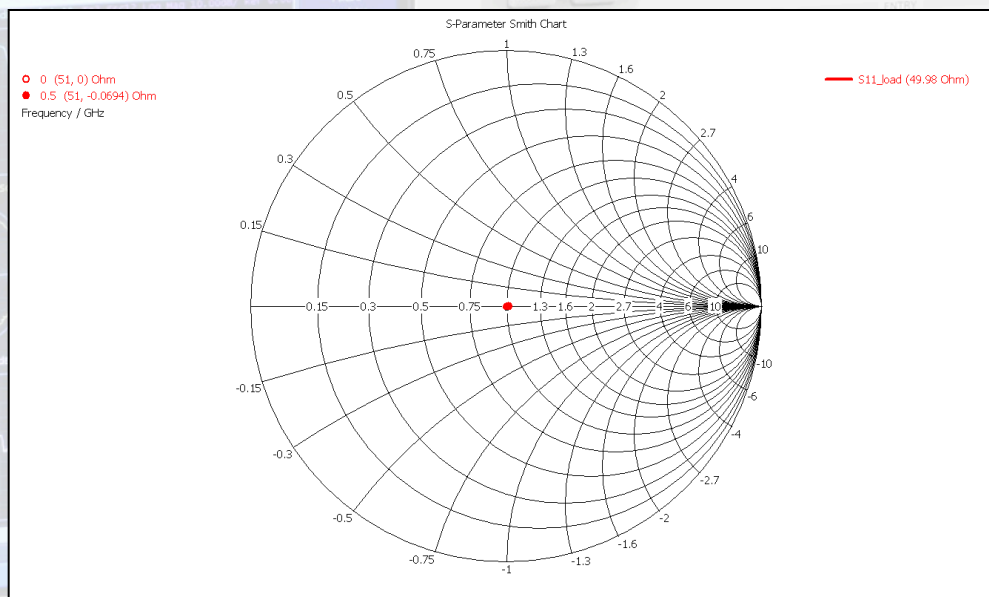

Caution: on the printout this snap shot of the traveling wave appears as a standing wave, however this is meant to be a traveling wave

Impedance transformation using transmission-lines

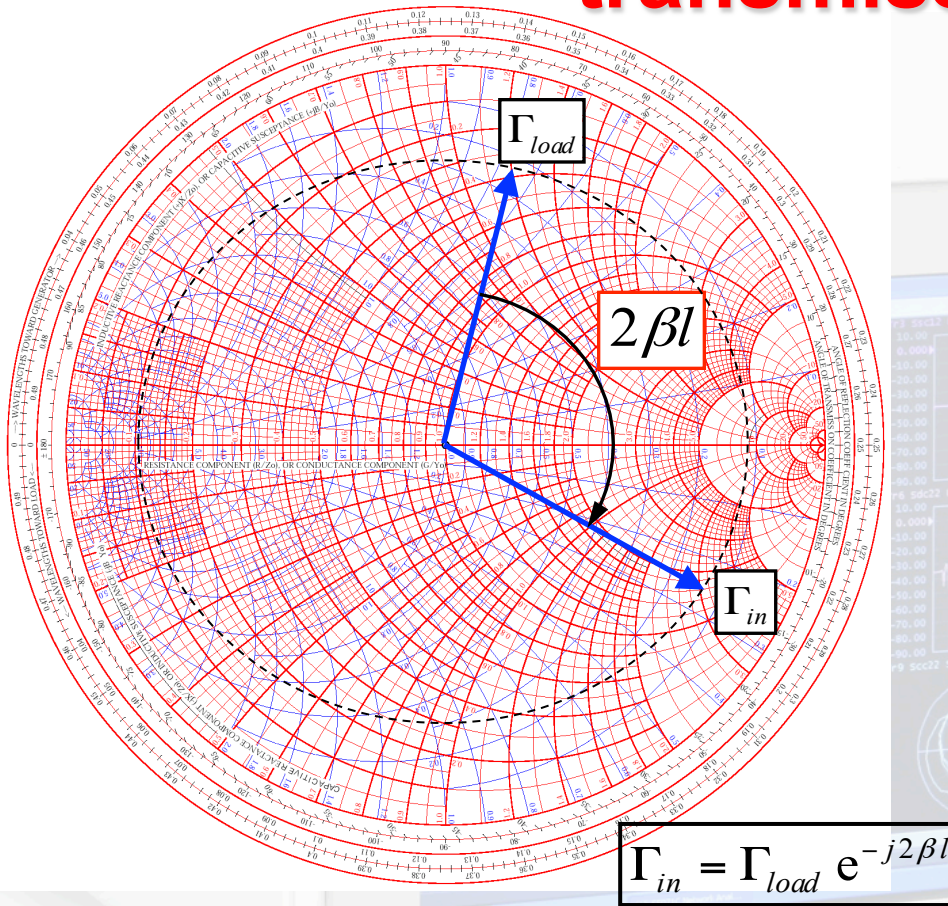

The S-matrix for an ideal, lossless transmission line of length l is given by

$$S = \begin{bmatrix} 0 & e^{-j\beta l} \\ e^{-j\beta l} & 0 \end{bmatrix}$$

where $\beta = 2\pi / \lambda$

is the propagation coefficient with the wavelength λ (this refers to the wavelength on the line containing some dielectric).

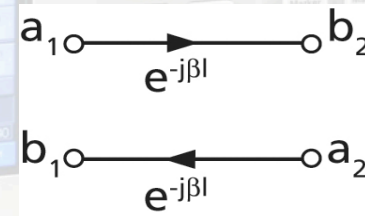

N.B.: The reflection factors are evaluated with respect to the characteristic impedance Z_c of the line segment.

How to remember when adding a section of transmission line, we have to turn clockwise: assume we are at $\Gamma = -1$ (short circuit) and add a short piece of e.g. coaxial cable. We actually introduced an inductance, thus we are in the upper half of the Smith-Chart.

$\lambda/4$ - Line transformations

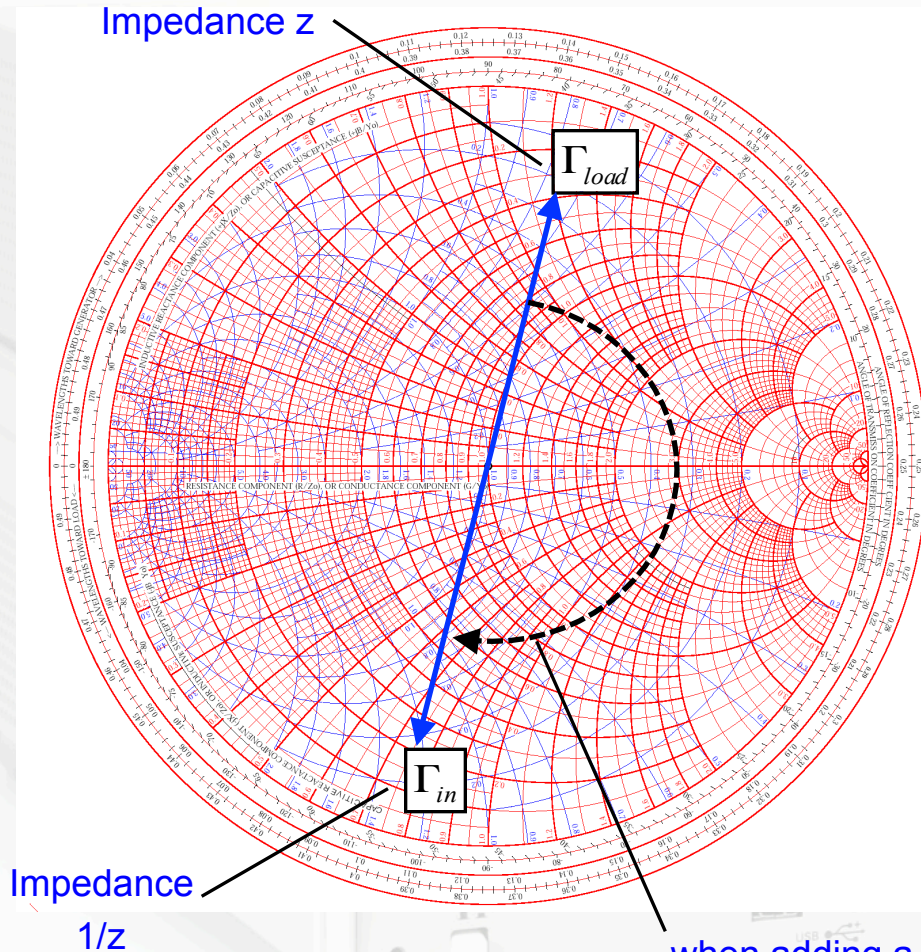

A transmission line of length

$$l = \lambda / 4$$

transforms a load reflection Γ_{load} to its input as

$$\Gamma_{in} = \Gamma_{load} e^{-j2\beta l} = \Gamma_{load} e^{-j\pi} = -\Gamma_{load}$$

This results, a normalized load impedance z is transformed into $1/z$.

In particular, a short circuit at one end is transformed into an open circuit at the other. This is the principle of $\lambda/4$ -resonators.

Again our example (shorted end)

short : standing wave (on the printout you see only a snapshot of movie. It is meant however to be a standing wave.)

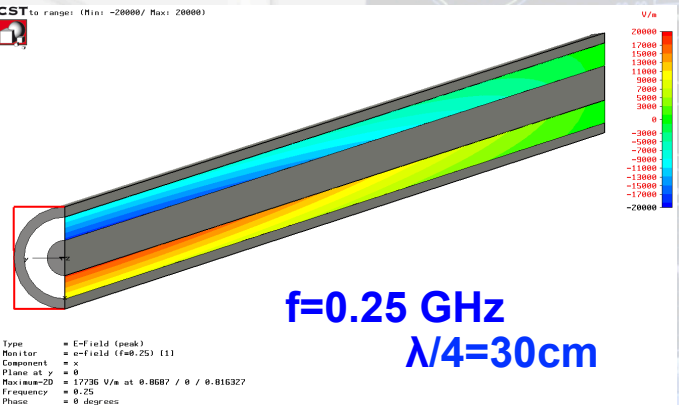
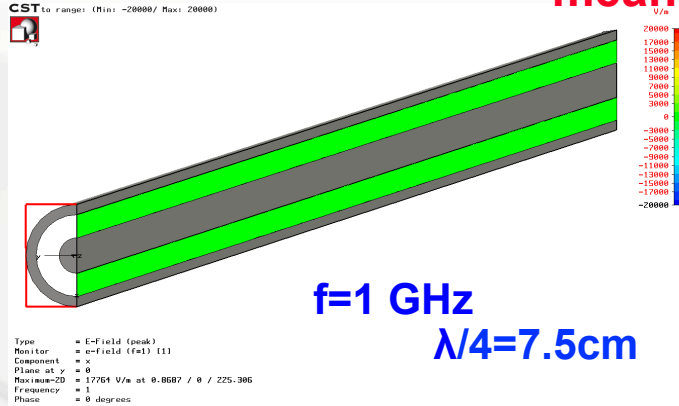

Coax cable with vacuum or air with a length of 30 cm

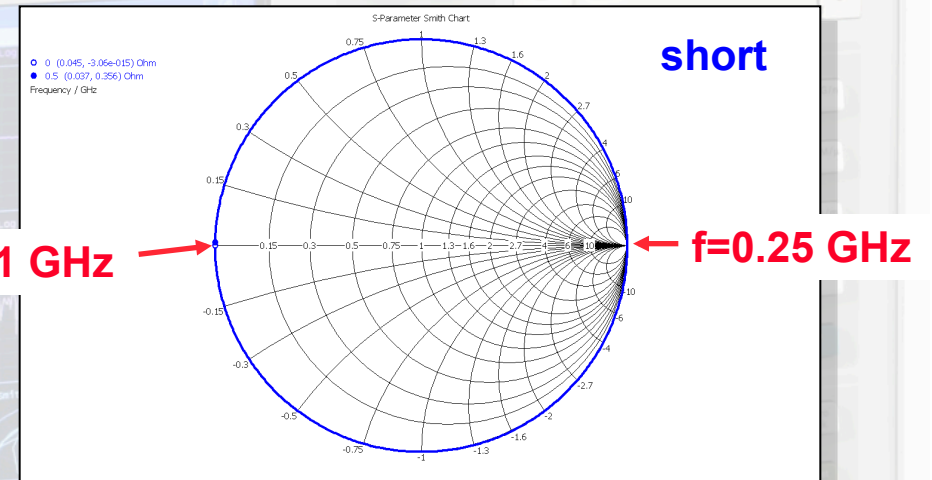

- ◆ If length of the transmission line changes by $\lambda/4$ a short circuit at one side is transformed into an open circuit at the other side.

Again our example (open end)

open : standing wave (on the printout you see only a snapshot of movie. It is meant however to be a standing wave.)

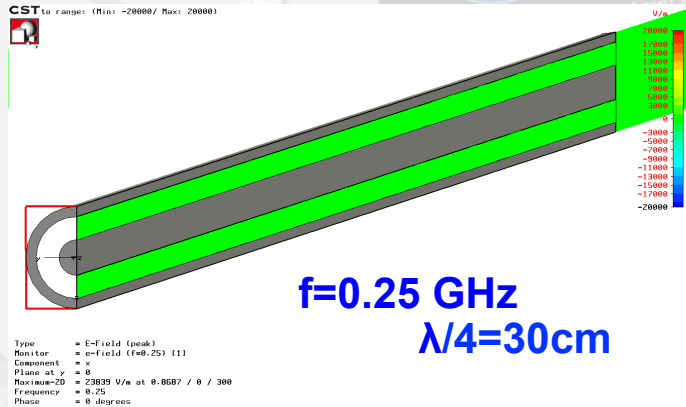
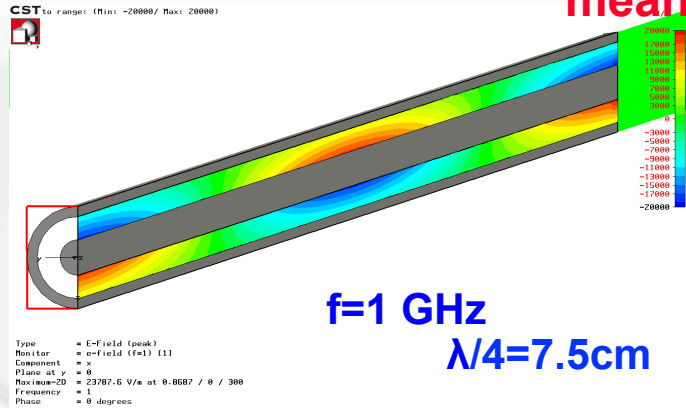

Coax cable with vacuum with a length of 30 cm

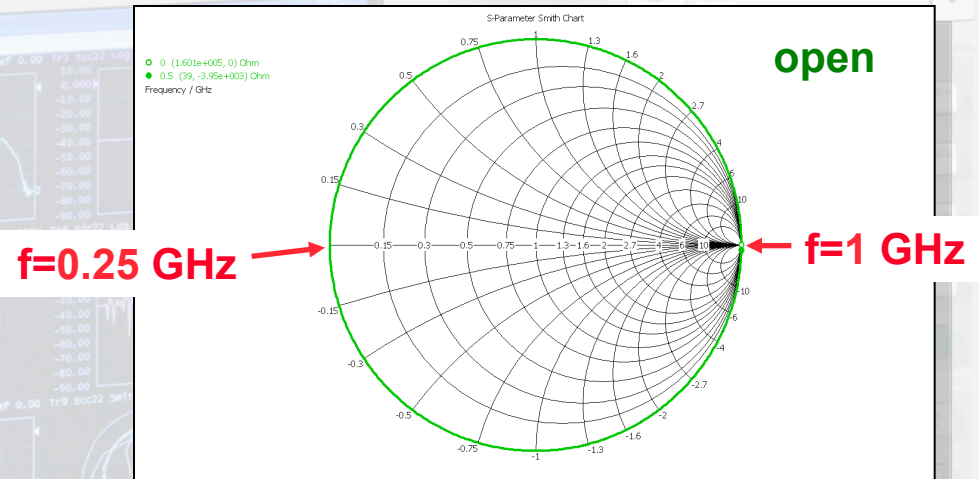

- ◆ The patterns for the short and open terminated case appear similar; However, the phase is shifted which correspond to a different position of the nodes.
- ◆ If the length of a transmission line changes by $\lambda/4$, an open become a short and vice versa!

What awaits you?



Measurements using Spectrum Analyzer and Oscilloscope (1)

- ◆ Measurements of several types of modulation (AM, FM, PM) in the time-domain and frequency-domain.
- ◆ Superposition of AM and FM spectrum (unequal height side bands).
- ◆ Concept of a spectrum analyzer: the superheterodyne method. Practice all the various settings (video bandwidth, resolution bandwidth etc.). Advantage of FFT spectrum analyzers.
- ◆ Measurement of the RF characteristics of a microwave detector diode (output voltage versus input power... transition between regime output voltage proportional input power and output voltage proportional input voltage); i.e. transition between square law and linear region.
- ◆ Concept of noise figure and noise temperature measurements, testing a noise diode, the basics of thermal noise.
- ◆ Noise figure measurements on amplifiers and also attenuators.
- ◆ The concept and meaning of ENR (excess noise ratio) numbers.

Measurements using Spectrum Analyzer and Oscilloscope (2)

- ◆ EMC measurements (e.g.: analyze your cell phone spectrum).
- ◆ Noise temperature of the fluorescent tubes in the RF-lab using a satellite receiver.
- ◆ Measurement of the IP3 (intermodulation point of third order) on RF amplifiers (intermodulation tests).
- ◆ Nonlinear distortion in general; Concept and application of vector spectrum analyzers, spectrogram mode (if available).
- ◆ Invent and design your own experiment !

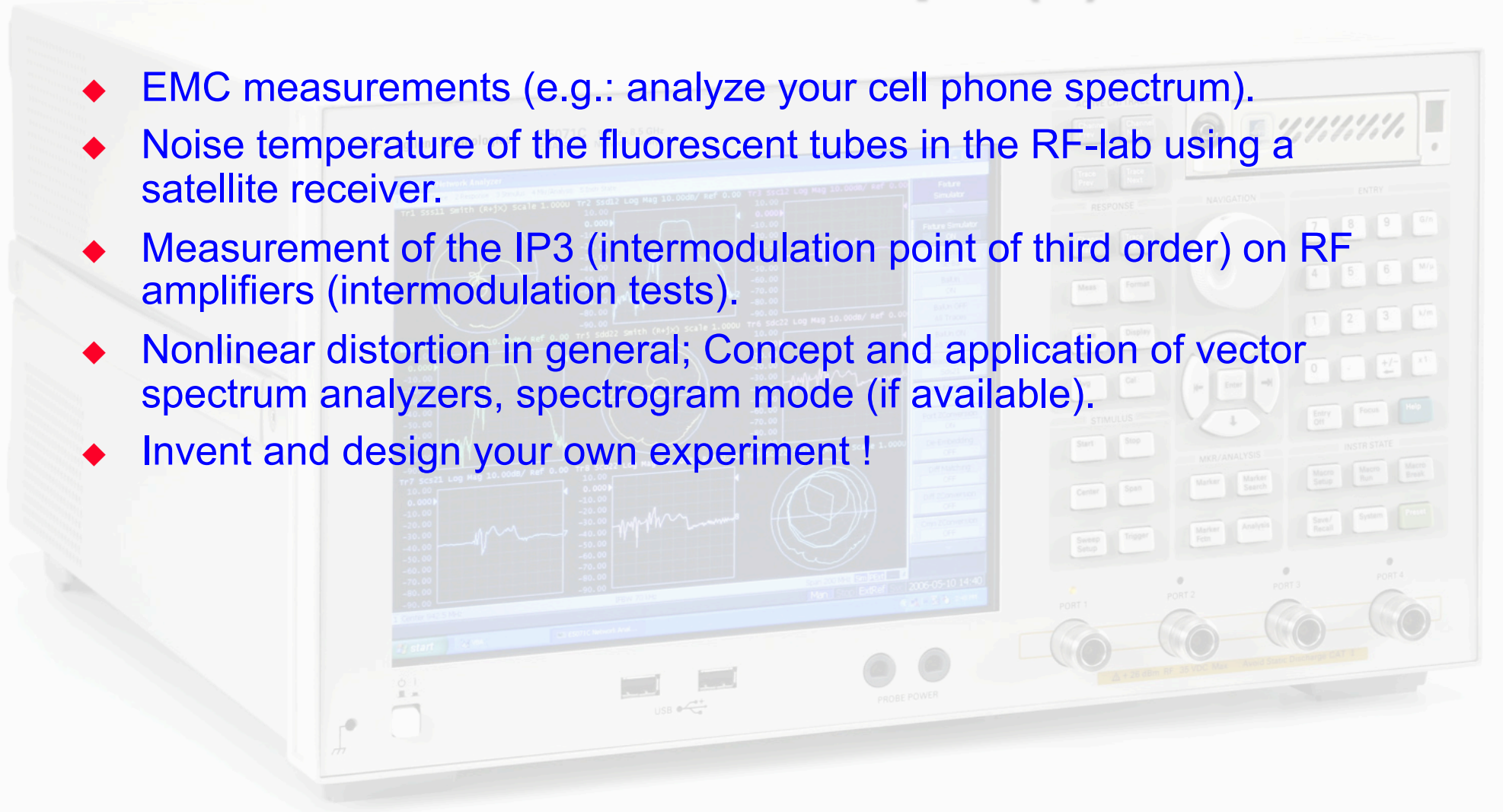

Measurements using Vector Network Analyzer (1)

- ◆ N-port (N=1...4) S-parameter measurements on different reciprocal and non-reciprocal RF-components.
- ◆ Calibration of the Vector Network Analyzer.
- ◆ Navigation in The Smith Chart.
- ◆ Application of the triple stub tuner for matching.
- ◆ Time Domain Reflectometry using synthetic pulse → direct measurement of coaxial line characteristic impedance.
- ◆ Measurements of the light velocity using a trombone (constant impedance adjustable coax line).
- ◆ 2-port measurements for active RF-components (amplifiers):
 - 1 dB compression point (power sweep).
- ◆ Concept of EMC measurements and some examples.

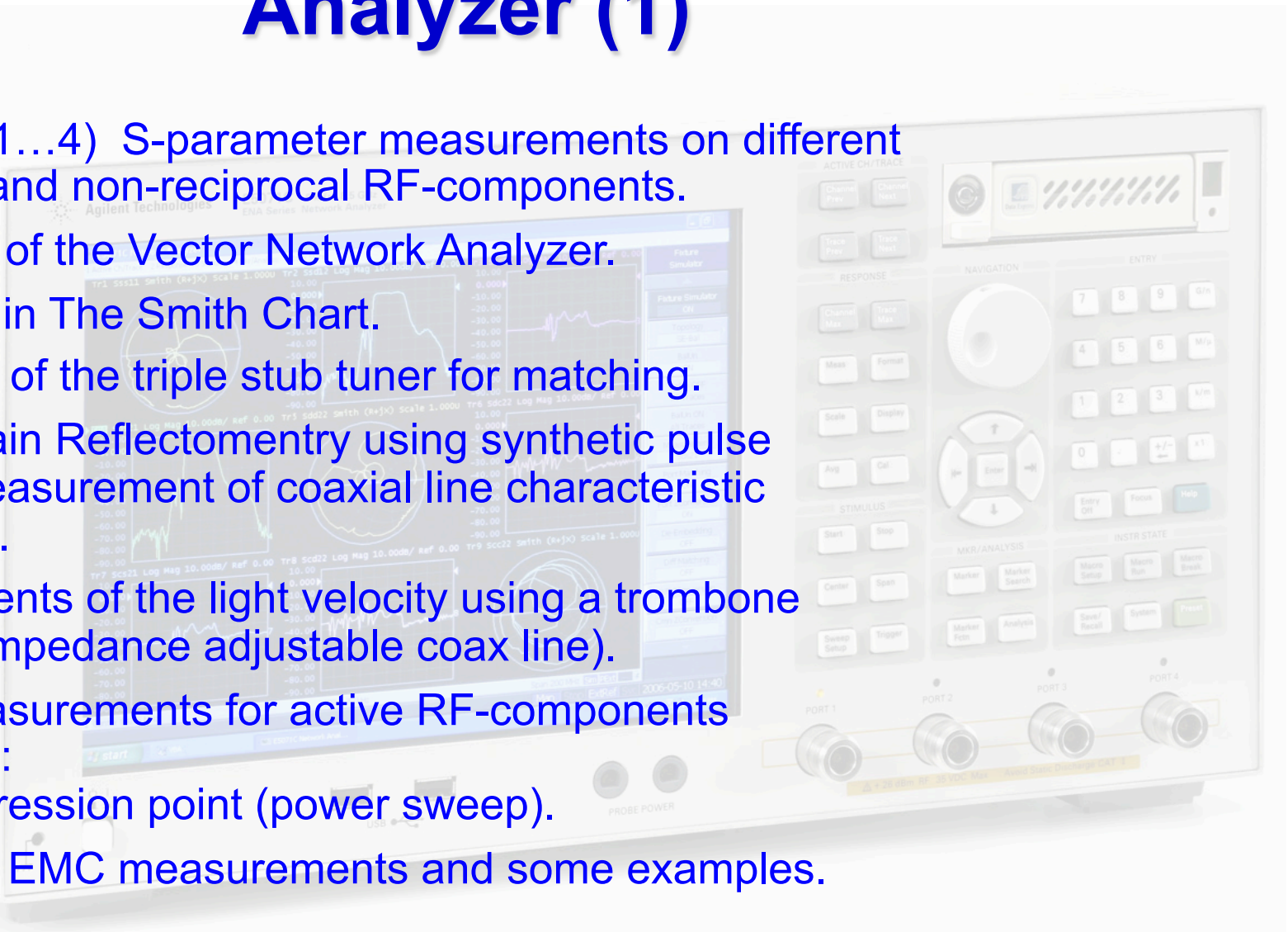

Measurements using Vector Network Analyzer (2)

- ◆ Measurements of the characteristic properties of a cavity resonator (Smith chart analysis).
- ◆ Cavity perturbation measurements (bead pull).
- ◆ Beam coupling impedance measurements applying the wire method (some examples).
- ◆ Beam transfer impedance measurements with the wire (button PU, stripline PU.)
- ◆ Self made RF-components: Calculate build and test your own attenuator in a SUCO box (and take it back home then).
- ◆ Invent and design your own experiment!

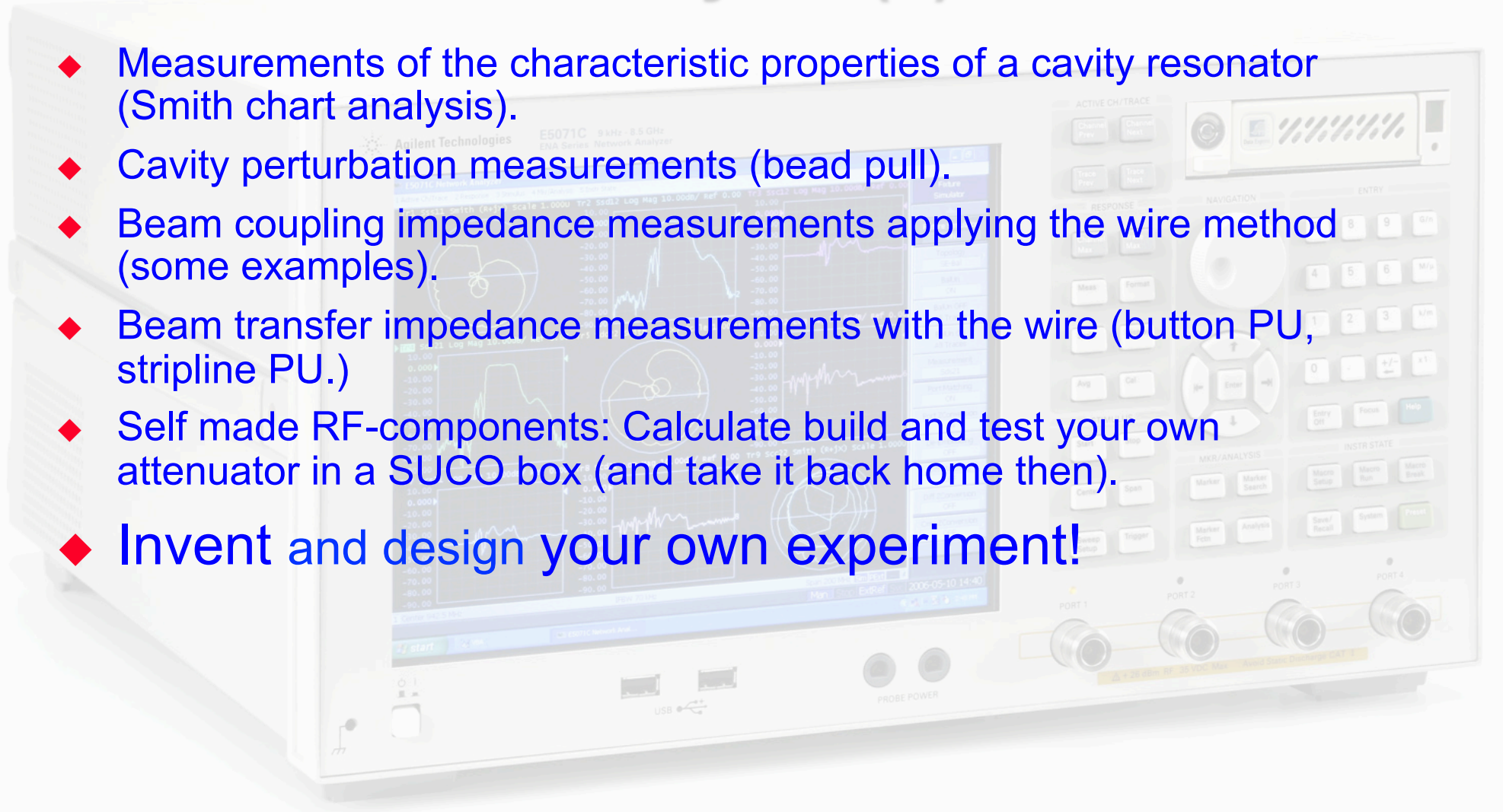

Invent your own experiment!

Build e.g. Doppler traffic radar
(this really worked in practice during
CAS 2011 RF-lab, CHIOS)



or „Tabacco-box” cavity



or test a resonator of any other type.



You will have enough time to think



and have a contact with hardware and your colleagues.

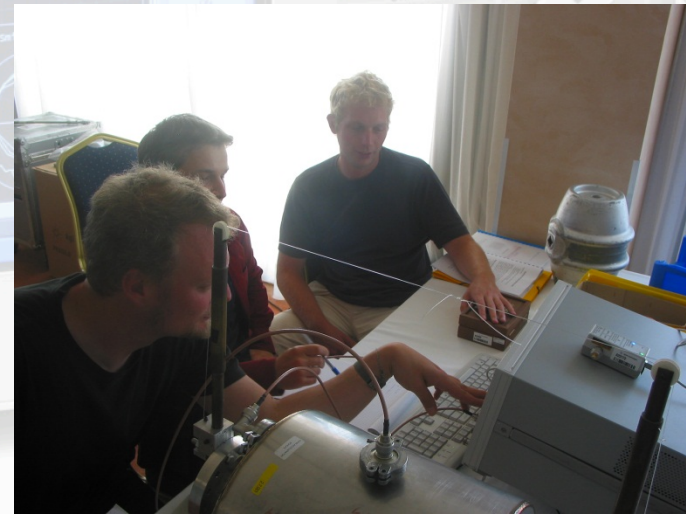

We hope you will have a lot of fun....



Appendix A: Definition of the Noise Figure

$$F = \frac{S_i / N_i}{S_o / N_o} = \frac{N_o}{GN_i} = \frac{N_o}{GkT_0B} = \frac{GN_i + N_R}{GkT_0B} = \frac{GkT_0B + N_R}{GkT_0B}$$

- ◆ F is the **Noise factor** of the receiver
- ◆ S_i is the available signal power at input
- ◆ $N_i = kT_0B$ is the available noise power at input
- ◆ T_0 is the absolute temperature of the source resistance
- ◆ N_o is the available noise power at the output, including amplified input noise
- ◆ N_r is the noise added by receiver
- ◆ G is the available receiver gain
- ◆ B is the effective noise bandwidth of the receiver
- ◆ If the noise factor is specified in a logarithmic unit, we use the term **Noise Figure (NF)**

$$NF = 10 \lg \frac{S_i / N_i}{S_o / N_o} \text{ dB}$$

Measurement of Noise Figure (using a calibrated Noise Source)

Calibrated T_H, T_C Source

DUT

Power Meter

$kT_H B \rightarrow$

$kT_C B \rightarrow$

$N_{OH} = FGkT_O B + (T_H - T_O)kBG$

$N_{OC} = FGkT_O B + (T_C - T_O)kBG$

$$\therefore Y = \frac{N_{OH}}{N_{OC}} = \frac{FT_O + T_H - T_O}{FT_O + T_C - T_O}; \quad F = \frac{\left(\frac{T_H}{T_O} - 1\right) - Y\left(\frac{T_C}{T_O} - 1\right)}{Y - 1}$$

Example:
 $T_H = 10,290^\circ\text{K}$ (argon source), $T_C = 300^\circ\text{K}$
 Measured Y factor: $Y = 9 \text{ dB}$ (7.94:1)
 Then,

$$F = \frac{\frac{10290}{290} - 1 - 7.94\left(\frac{300}{290} - 1\right)}{7.94 - 1} = 4.94; \quad NF(\text{dB}) = 10 \log(4.94) = 6.9 \text{ dB}$$

Appendix B: Examples of 2-ports (1)

Line of $Z=50\Omega$, length $l=\lambda/4$

$$(S) = \begin{bmatrix} 0 & -j \\ -j & 0 \end{bmatrix} \quad \begin{aligned} b_1 &= -ja_2 \\ b_2 &= -ja_1 \end{aligned}$$

Port 1:

Port 2:

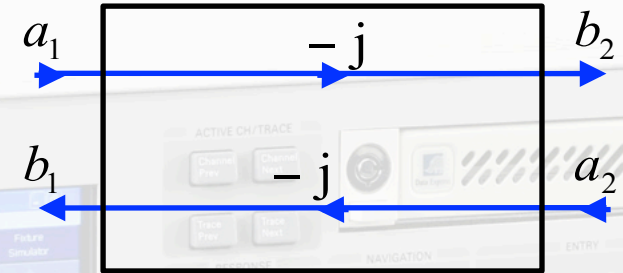

Attenuator 3dB, i.e. half output power

$$(S) = \frac{1}{\sqrt{2}} \begin{bmatrix} 0 & 1 \\ 1 & 0 \end{bmatrix} \quad \begin{aligned} b_1 &= \frac{1}{\sqrt{2}} a_2 = 0.707 a_2 \\ b_2 &= \frac{1}{\sqrt{2}} a_1 = 0.707 a_1 \end{aligned}$$

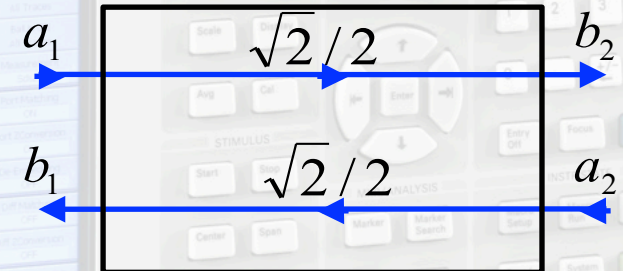

RF Transistor

$$(S) = \begin{bmatrix} 0.277 e^{-j59^\circ} & 0.078 e^{j93^\circ} \\ 1.92 e^{j64^\circ} & 0.848 e^{-j31^\circ} \end{bmatrix}$$

backward transmission

forward transmission

non-reciprocal since $S_{12} \neq S_{21}$!

=different transmission forwards and backwards

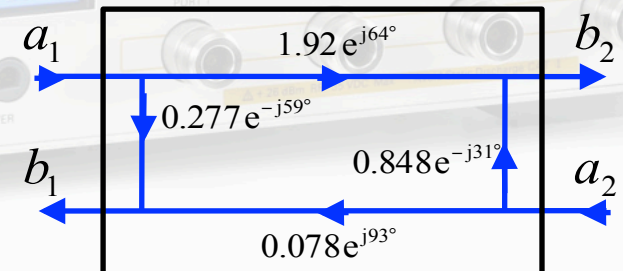

Examples of 2-ports (2)

Ideal Isolator

$$(S) = \begin{bmatrix} 0 & 0 \\ 1 & 0 \end{bmatrix}$$

$$b_2 = a_1$$

only forward transmission

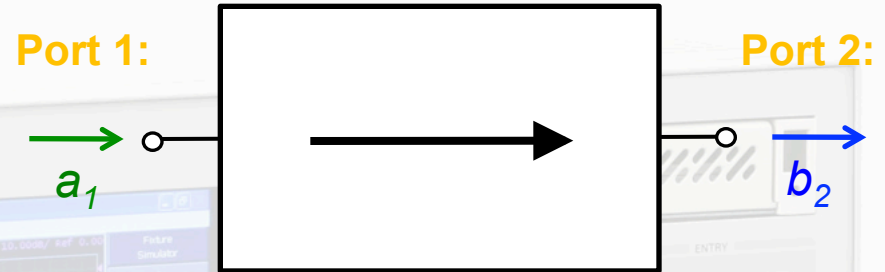

Faraday rotation isolator

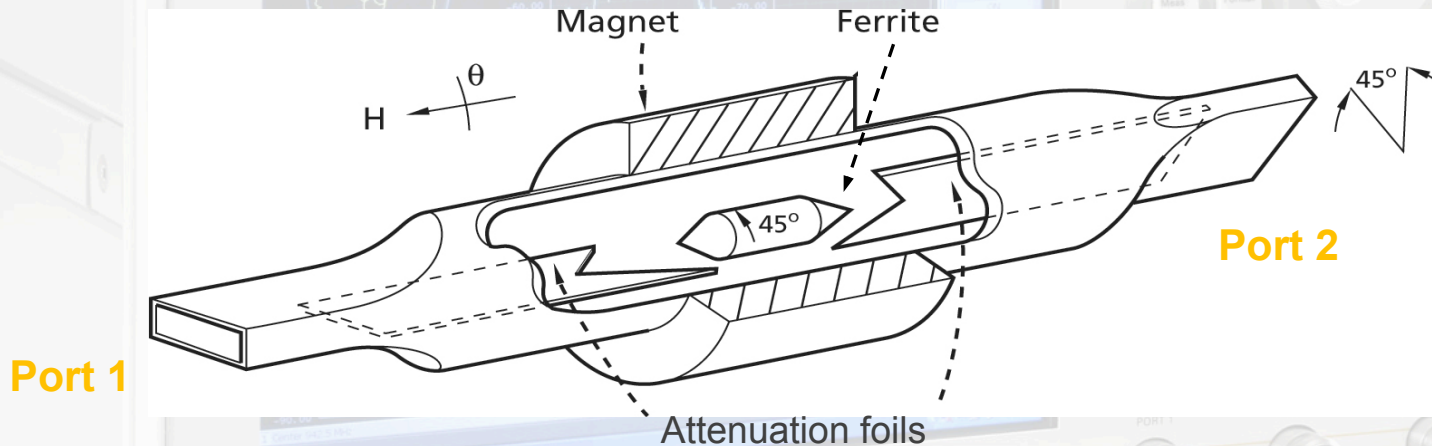

The left waveguide uses a TE_{10} mode (=vertically polarized H field). After transition to a circular waveguide, the polarization of the mode is rotated counter clockwise by 45° by a ferrite. Then follows a transition to another rectangular waveguide which is rotated by 45° such that the forward wave can pass unhindered. However, a wave coming from the other side will have its polarization rotated by 45° clockwise as seen from the right hand side.

Pathing through a 2-port (1)

In general:

$$\Gamma_{in} = S_{11} + \frac{S_{12}S_{21}\Gamma_L}{1 - S_{22}\Gamma_L}$$

where Γ_{in} is the reflection coefficient when looking through the 2-port and Γ_{load} is the load reflection coefficient.

The outer circle and the real axis in the simplified Smith diagram below are mapped to other circles and lines, as can be seen on the right.

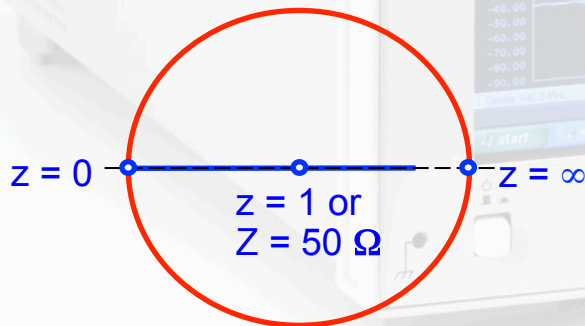

Line $\lambda/16$:

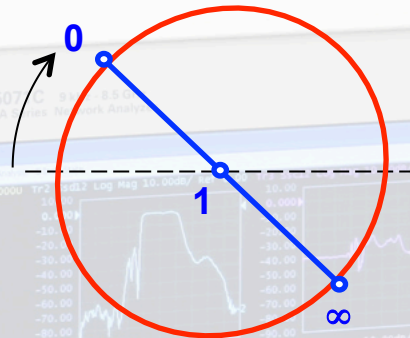

Attenuator 3dB:

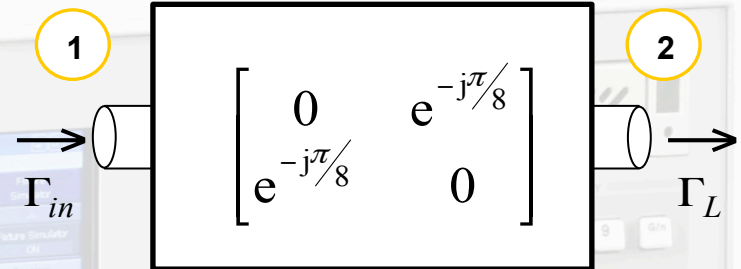
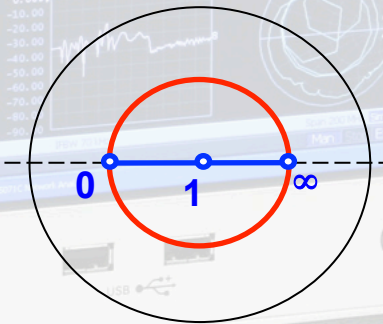

$$\Rightarrow \Gamma_{in} = \Gamma_L e^{-j\pi/4}$$

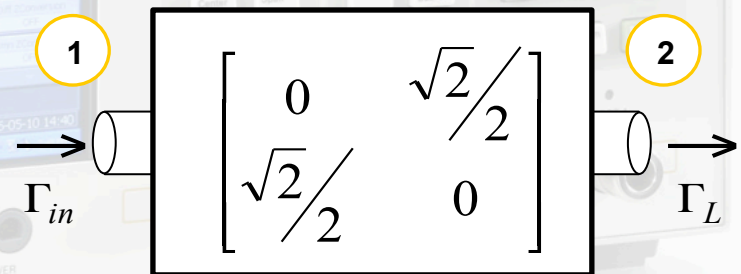

$$\Rightarrow \Gamma_{in} = \Gamma_L / 2$$

Pathing through a 2-port (2)

Lossless
Passive
Circuit

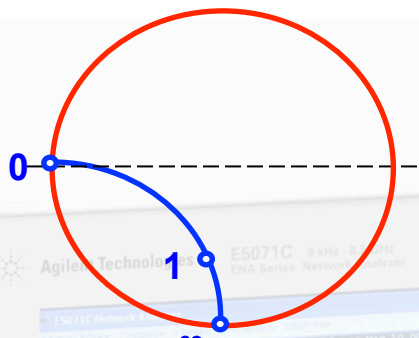

1

If S is unitary

$$S^* S = \begin{bmatrix} 1 & 0 \\ 0 & 1 \end{bmatrix}$$

2

→ Lossless Two-Port

Lossy
Passive
Circuit

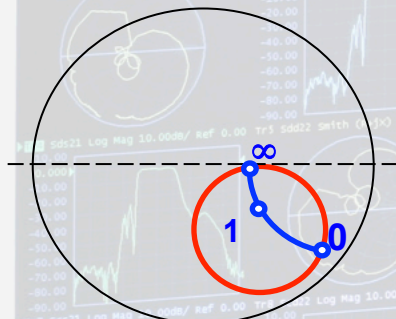

1

Lossy Two-Port:

If $K_{LINVILL} < 1$
 $K_{ROLLET} > 1$

2

unconditionally stable

Active
Circuit

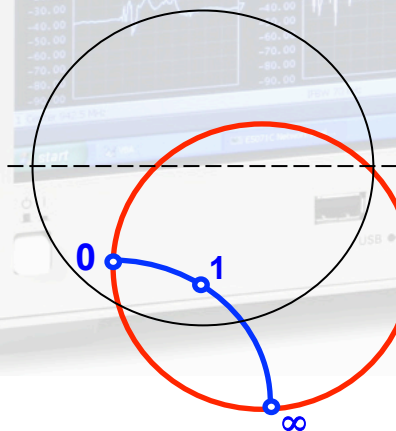

1

Active Circuit:

If $K_{LINVILL} \geq 1$
 $K_{ROLLET} \leq 1$

2

potentially unstable

Examples of 3-ports (1)

Resistive power divider

$$(S) = \frac{1}{2} \begin{bmatrix} 0 & 1 & 1 \\ 1 & 0 & 1 \\ 1 & 1 & 0 \end{bmatrix}$$

$$b_1 = \frac{1}{2}(a_2 + a_3)$$

$$b_2 = \frac{1}{2}(a_1 + a_3)$$

$$b_3 = \frac{1}{2}(a_1 + a_2)$$

3-port circulator

$$(S) = \begin{bmatrix} 0 & 0 & 1 \\ 1 & 0 & 0 \\ 0 & 1 & 0 \end{bmatrix}$$

$$b_1 = a_3$$

$$b_2 = a_1$$

$$b_3 = a_2$$

The ideal circulator is lossless, matched at all ports, but not reciprocal. A signal entering the ideal circulator at one port is transmitted exclusively to the next port in the sense of the arrow.

Port 1:

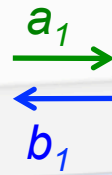

Port 2:

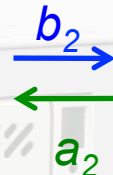

Port 3:



Port 2:

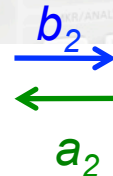

Port 1:

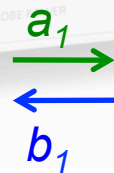

Port 3:

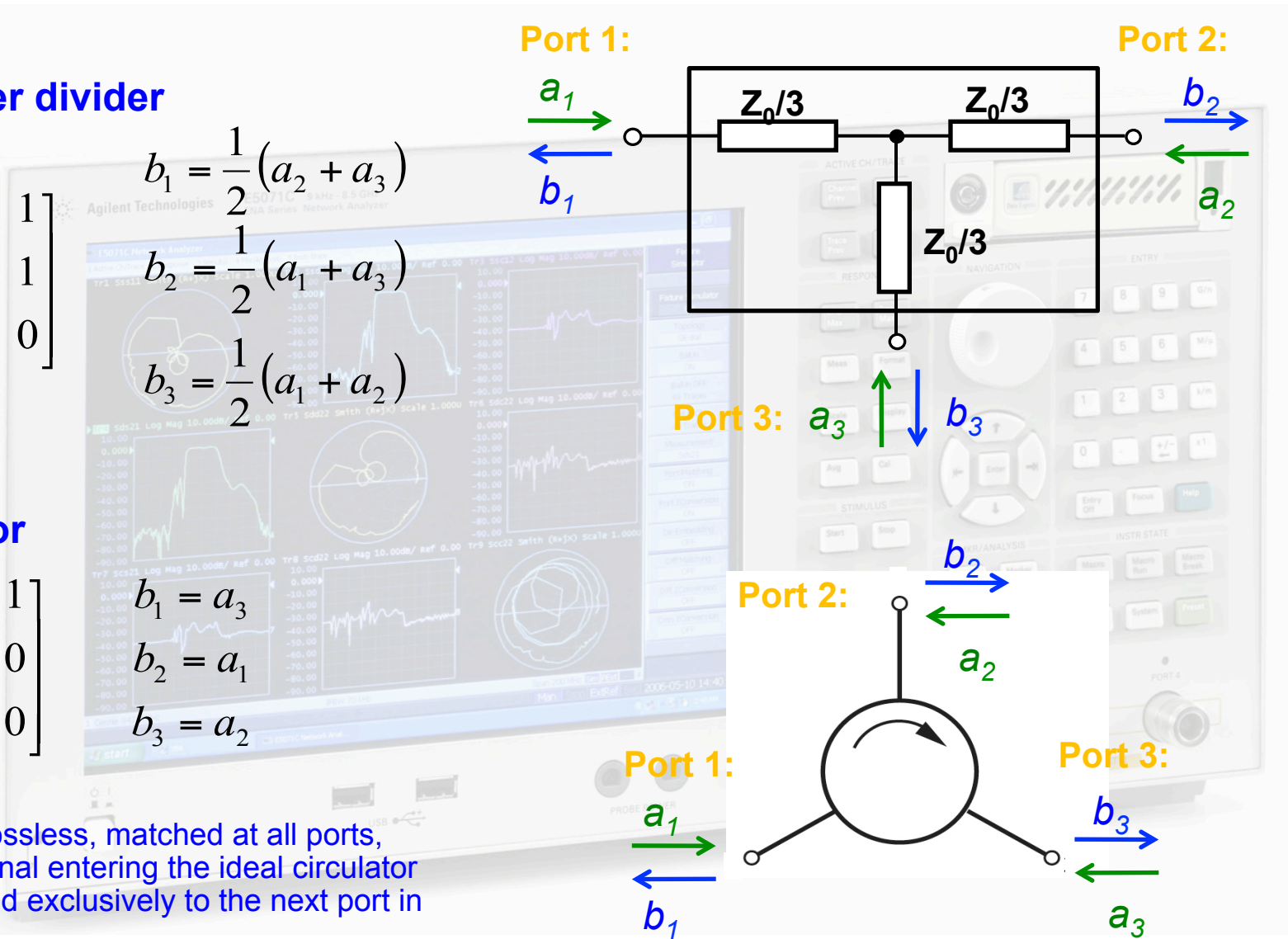

Examples of 3-ports (2)

Practical implementations of circulators:

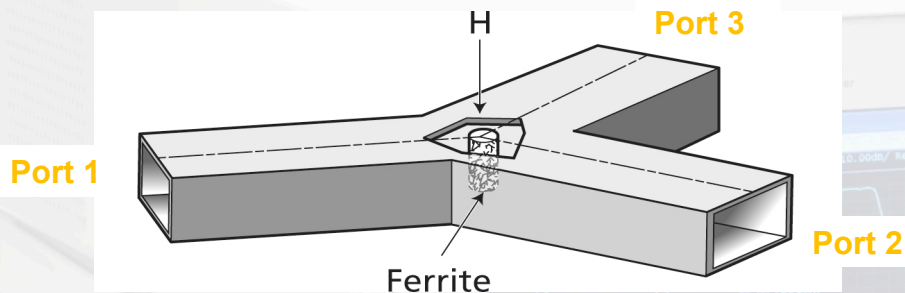

Waveguide circulator

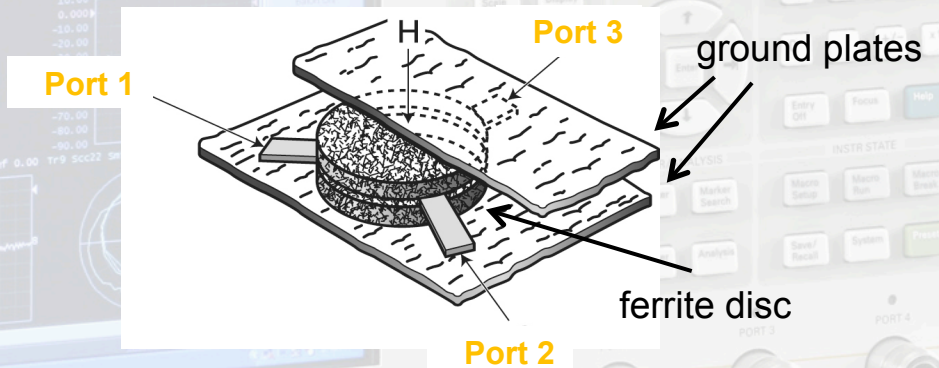

Stripline circulator

A circulator contains a volume of ferrite. The magnetically polarized ferrite provides the required non-reciprocal properties, thus power is only transmitted from port 1 to port 2, from port 2 to port 3, and from port 3 to port 1.

Examples of 4-ports (1)

Ideal directional coupler

$$(S) = \begin{bmatrix} 0 & jk & \sqrt{1-k^2} & 0 \\ jk & 0 & 0 & \sqrt{1-k^2} \\ \sqrt{1-k^2} & 0 & 0 & jk \\ 0 & \sqrt{1-k^2} & jk & 0 \end{bmatrix} \quad \text{with } k = \left| \frac{b_2}{a_1} \right|$$

To characterize directional couplers, three important figures are used:

the coupling

$$C = -20 \log_{10} \left| \frac{b_2}{a_1} \right|$$

the directivity

$$D = -20 \log_{10} \left| \frac{b_4}{b_2} \right|$$

the isolation

$$I = -20 \log_{10} \left| \frac{a_1}{b_4} \right|$$

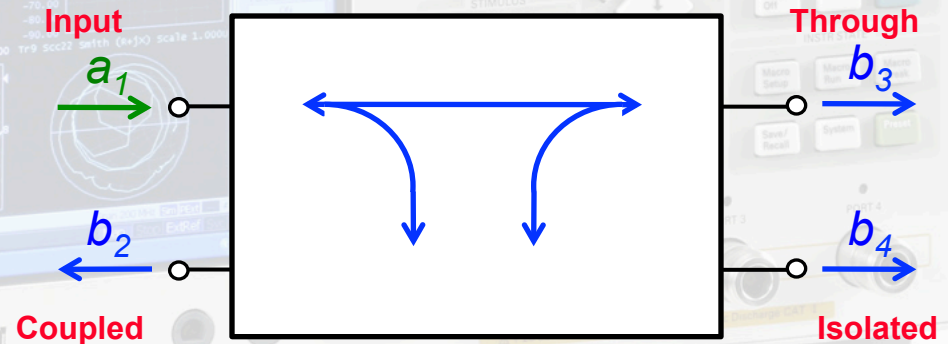

Appendix C: T matrix

The T-parameter matrix is related to the incident and reflected normalised waves at each of the ports.

$$\begin{pmatrix} b_1 \\ a_1 \end{pmatrix} = \begin{bmatrix} T_{11} & T_{12} \\ T_{21} & T_{22} \end{bmatrix} \begin{pmatrix} a_2 \\ b_2 \end{pmatrix}$$

T-parameters may be used to determine the effect of a cascaded 2-port networks by simply multiplying the individual T-parameter matrices:

$$[T] = [T^{(1)}][T^{(2)}] \dots [T^{(N)}] = \prod_N [T^{(i)}]$$

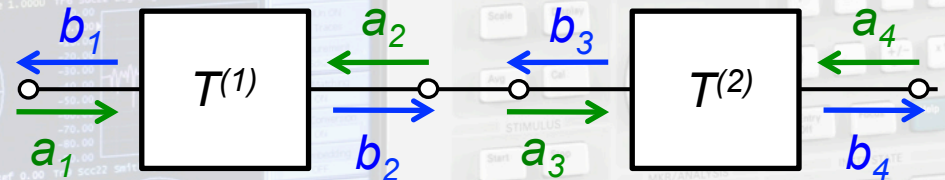

T-parameters can be directly evaluated from the associated S-parameters and vice versa.

From S to T:

$$[T] = \frac{1}{S_{21}} \begin{bmatrix} -\det(S) & S_{11} \\ -S_{22} & 1 \end{bmatrix}$$

From T to S:

$$[S] = \frac{1}{T_{22}} \begin{bmatrix} T_{12} & \det(T) \\ 1 & -T_{21} \end{bmatrix}$$

Appendix D: A Step in Characteristic Impedance (1)

Consider a connection of two coaxial cables, one with $Z_{C,1} = 50 \Omega$ characteristic impedance, the other with $Z_{C,2} = 75 \Omega$ characteristic impedance.

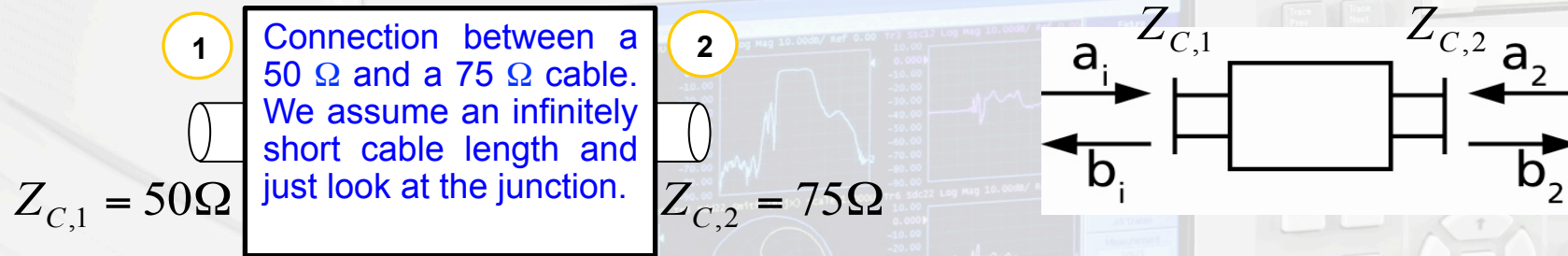

Step 1: Calculate the reflection coefficient and keep in mind: all ports have to be terminated with their respective characteristic impedance, i.e. 75 Ω for port 2.

$$\Gamma_1 = \frac{Z - Z_{C,1}}{Z + Z_{C,1}} = \frac{75 - 50}{75 + 50} = 0.2$$

Thus, the voltage of the reflected wave at port 1 is 20% of the incident wave, and the reflected power at port 1 (proportional Γ^2) is $0.2^2 = 4\%$. As this junction is lossless, the transmitted power must be 96% (conservation of energy). From this we can deduce $b_2^2 = 0.96$. **But: how do we get the voltage of this outgoing wave?**

Example: a Step in Characteristic Impedance (2)

Step 2: Remember, a and b are **power-waves**, and defined as voltage of the forward- or backward traveling wave normalized to $\sqrt{Z_C}$.

The tangential electric field in the dielectric in the 50 Ω and the 75 Ω line, respectively, must be continuous.

$$Z_{C,1} = 50\Omega$$

$$Z_{C,2} = 75\Omega$$

$$PE \ \epsilon_r = 2.25$$

$$\text{Air, } \epsilon_r = 1$$

t = voltage transmission coefficient, in this case: $t = 1 + \Gamma$

This is counterintuitive, one might expect $1 - \Gamma$. Note that the voltage of the transmitted wave is higher than the voltage of the incident wave. But we have to normalize to $\sqrt{Z_C}$ to evaluate the corresponding S-parameter. $S_{12} = S_{21}$ via reciprocity! But $S_{11} \neq S_{22}$, i.e. the structure is NOT symmetric.

$$V_{\text{incident}} = 1$$
$$V_{\text{reflected}} = 0.2$$
$$V_{\text{transmitted}} = 1.2$$

Example: a Step in Characteristic Impedance (3)

Once we have determined the voltage transmission coefficient, we have to normalize to the ratio of the characteristic impedances, respectively. Thus we get for

$$S_{12} = 1.2 \sqrt{\frac{50}{75}} = 1.2 \cdot 0.816 = 0.9798$$

We know from the previous calculation that the reflected power (proportional Γ^2) is 4% of the incident power. Thus 96% of the power are transmitted.

Check done $S_{12}^2 = 1.44 \frac{1}{1.5} = 0.96 = (0.9798)^2$

$$S_{22} = \frac{50 - 75}{50 + 75} = -0.2 \text{ To be compared with } S_{11} = +0.2!$$

Example: a Step in Characteristic Impedance (4)

Visualization in the Smith chart:

As shown in the previous slides the voltage of the transmitted wave is

$$V_t = a + b, \text{ with } \Gamma = 1 + \Gamma$$

and subsequently the current is

$$I_t Z = a - b.$$

Remember: the reflection coefficient Γ is defined with respect to voltages. For currents the sign inverts. Thus a positive reflection coefficient in the normal definition leads to a subtraction of currents or is negative with respect to current.

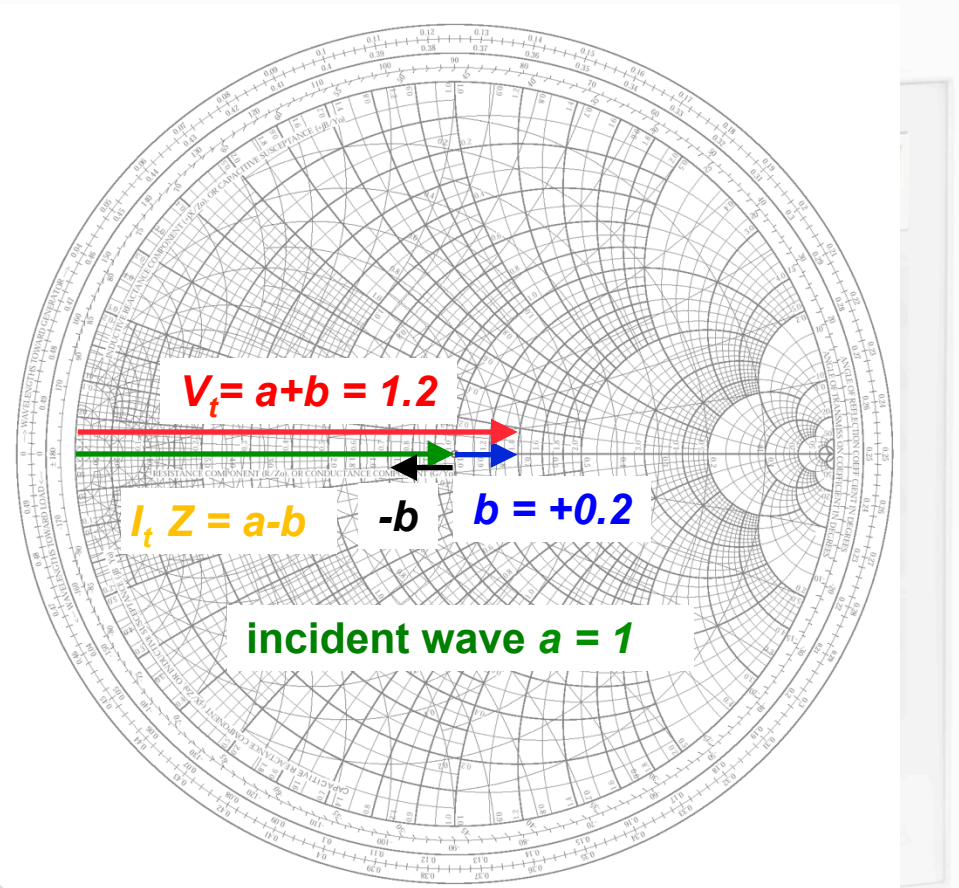

Note: here Z_{load} is real

Example: a Step in Characteristic Impedance (5)

General case:

Thus we can read from the Smith chart immediately the amplitude and phase of voltage and current on the load (of course we can calculate it when using the complex voltage divider).

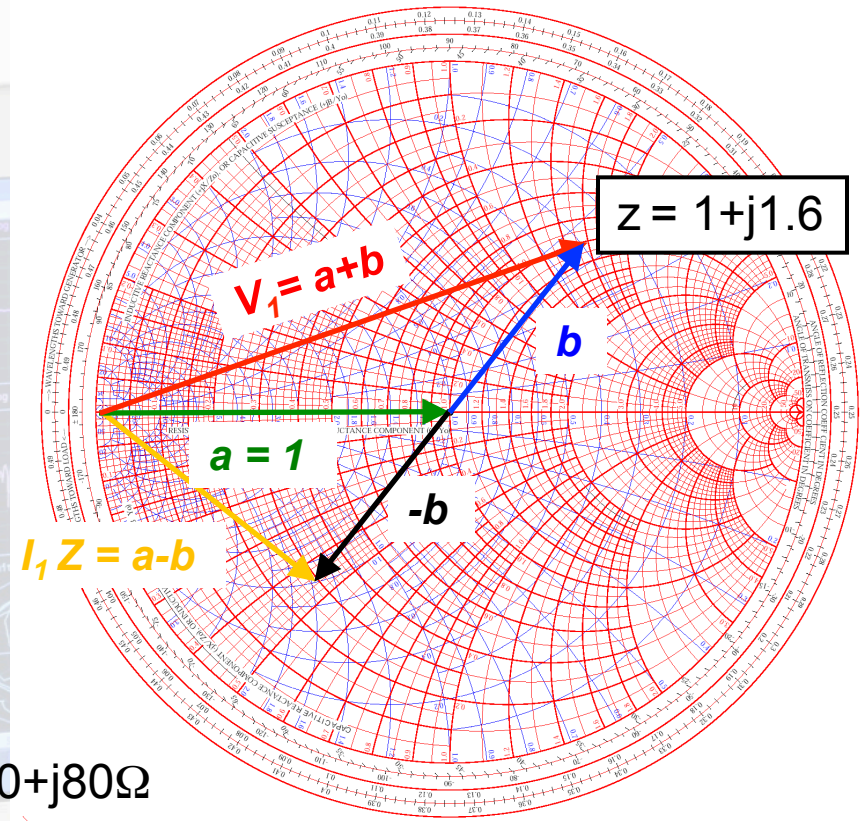
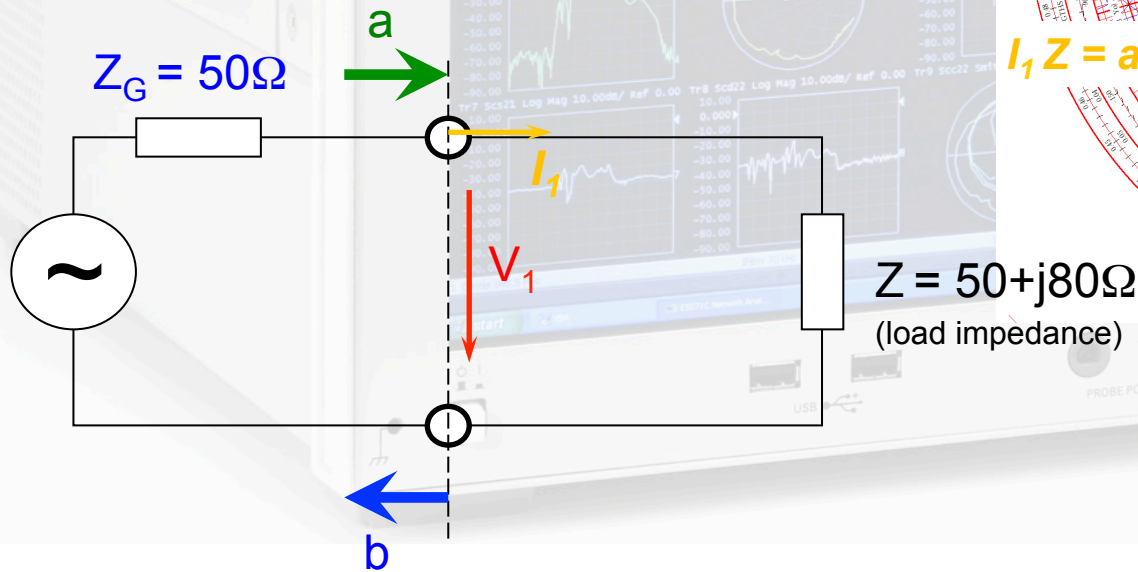

Appendix E: Navigation in the Smith Chart (1)

in blue: Impedance plane ($=Z$)

in red: Admittance plane ($=Y$)

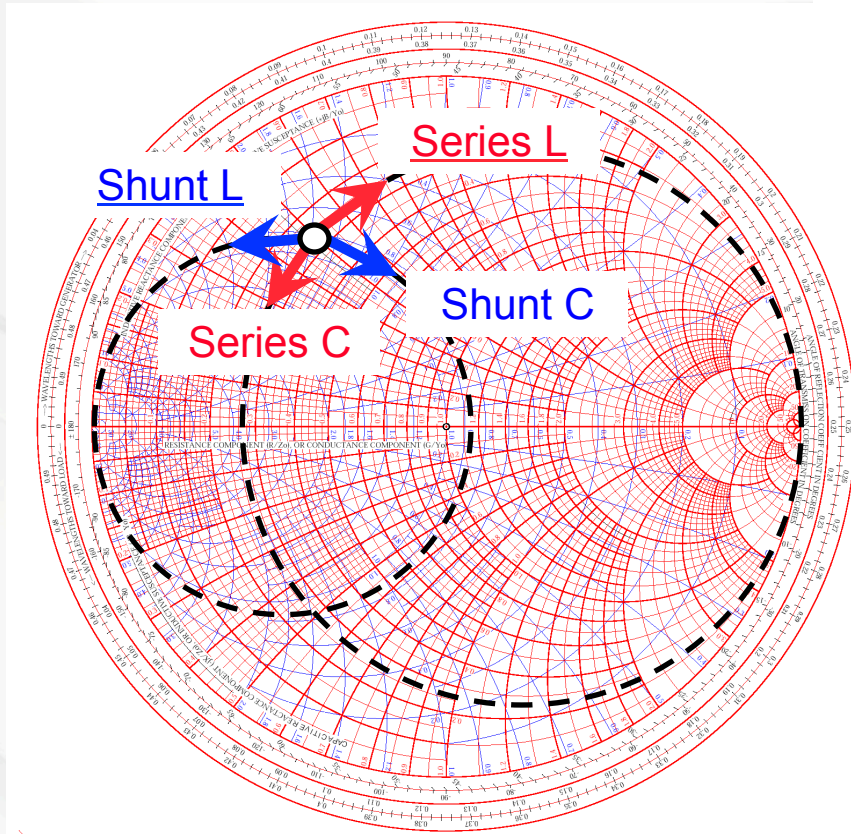

	<u>Up</u>	<u>Down</u>
Red circles	<u>Series L</u>	Series C
Blue circles	<u>Shunt L</u>	Shunt C

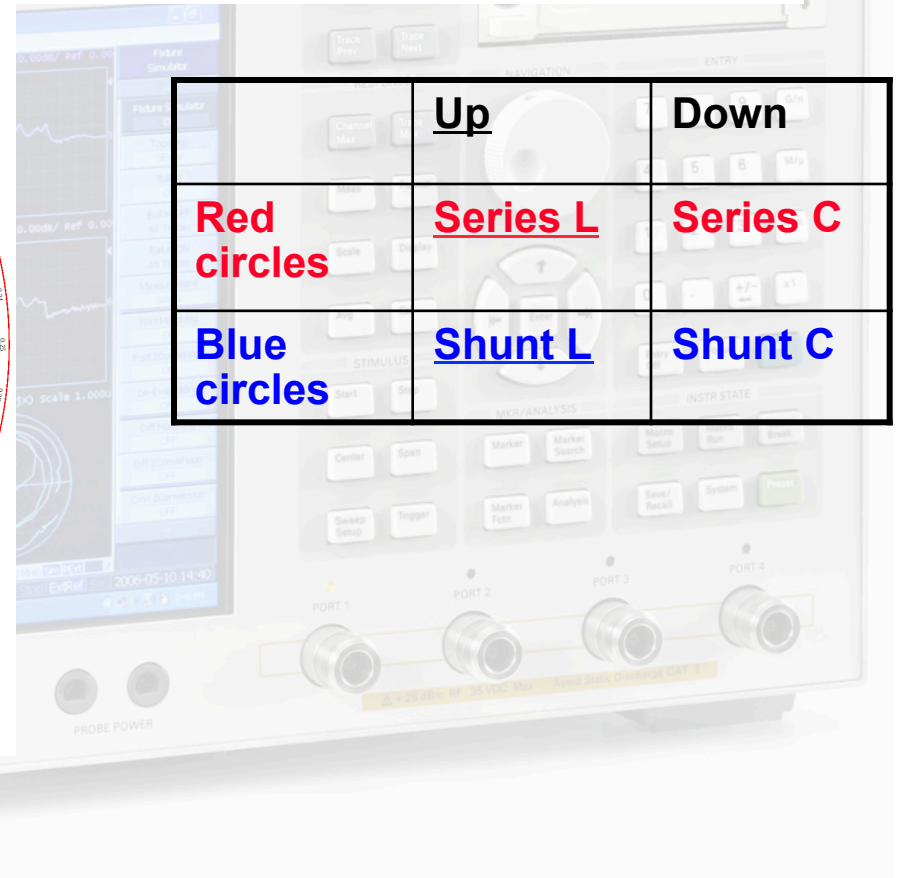

Navigation in the Smith Chart (2)

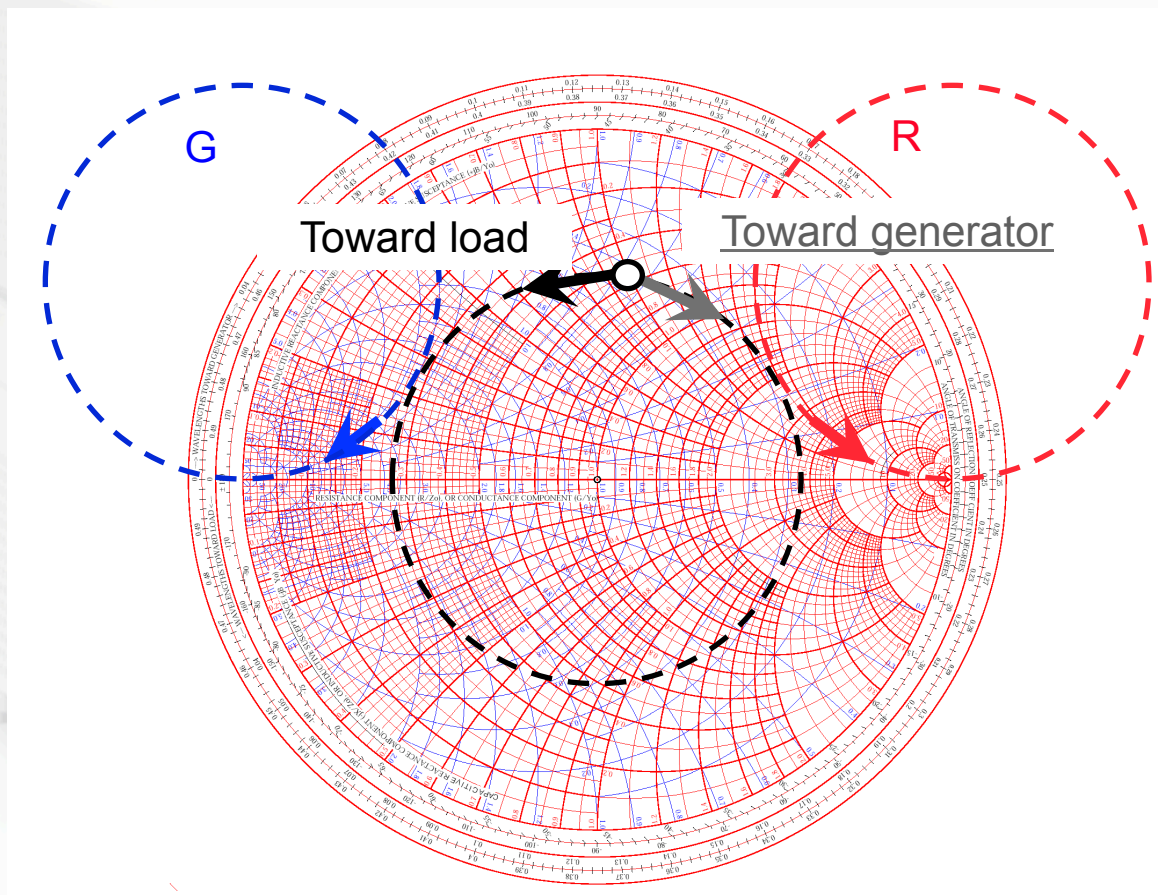

Red arcs	Resistance R
Blue arcs	Conductance G
Concentric circle	Transmission line going Toward load Toward generator

Appendix F: The RF diode (1)

- ◆ We are not discussing the generation of RF signals here, just the detection
- ◆ Basic tool: fast RF* diode (= Schottky diode)
- ◆ In general, Schottky diodes are fast but still have a voltage dependent junction capacity (metal – semi-conductor junction)

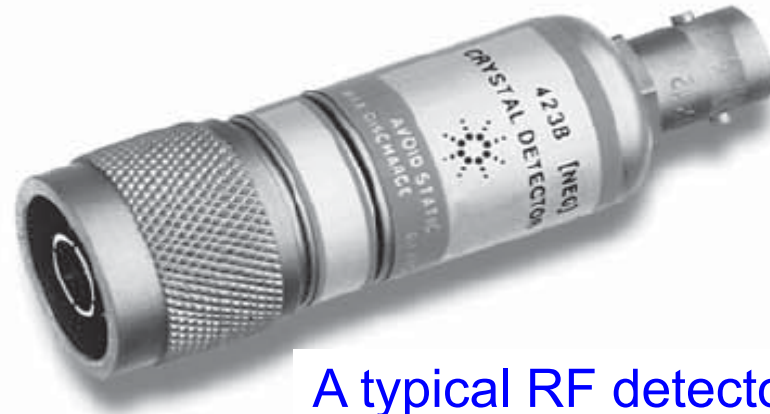

A typical RF detector diode
Try to guess from the type of the connector which side is the RF input and which is the output

Equivalent circuit:

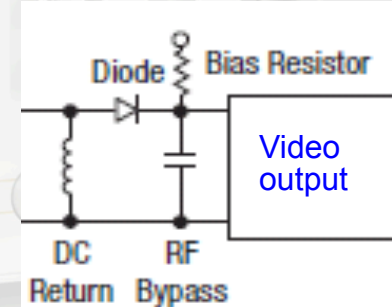
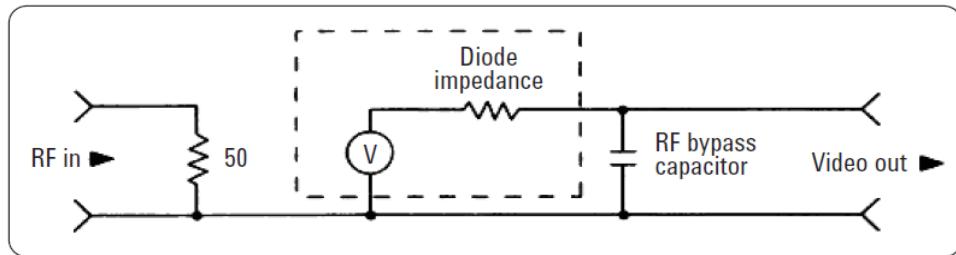

*Please note, in this lecture we will use RF (radio-frequency) for both, the RF and the microwave range, since there is no defined borderline between the RF and microwave regime.

The RF diode (2)

◆ Characteristics of a diode:

The current as a function of the voltage for a barrier diode can be described by the Richardson equation:

$$I = AA^{**2} \exp\left(-\frac{q\phi_B}{kT}\right) \left[\exp\left(\frac{qV}{NkT}\right) - 1\right]$$

where

A = area (cm²)

A^{**} = modified Richardson constant (amp/oK)²/cm²

k = Boltzman's Constant

T = absolute temperature (°K)

φ_B = barrier heights in volts

V = external voltage across the depletion layer
(positive for forward voltage) - V - IR_S

R_S = series resistance

I = diode current in amps (positive forward current)

n = ideality factor

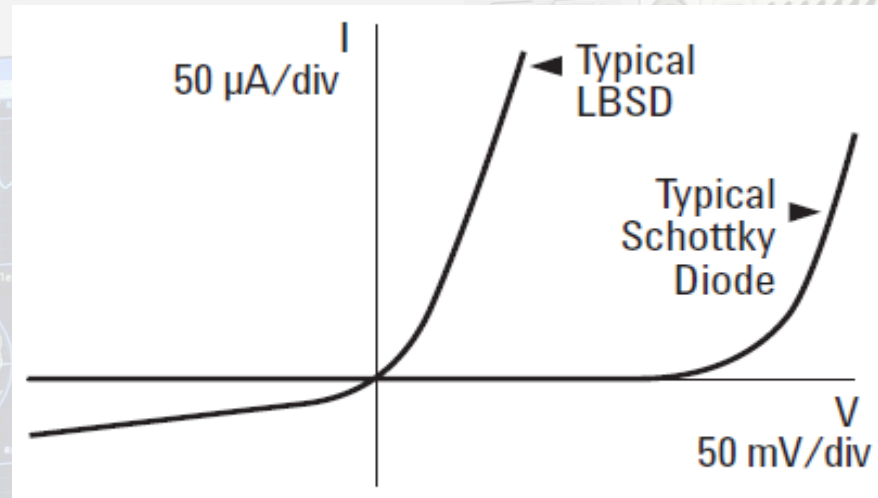

Ideal Commutator

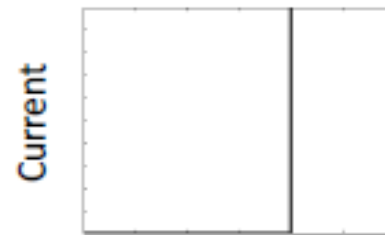

◆ The RF diode is NOT an ideal commutator for small signals! We cannot apply big signals otherwise burnout

The RF diode (3)

- ◆ This diagram depicts the so called square-law region where the output voltage (V_{Video}) is proportional to the input power

Since the input power is proportional to the square of the input voltage (V_{RF}^2) and the output signal is proportional to the input power, this region is called square-law region.

In other words:

$$V_{\text{Video}} \sim V_{\text{RF}}^2$$

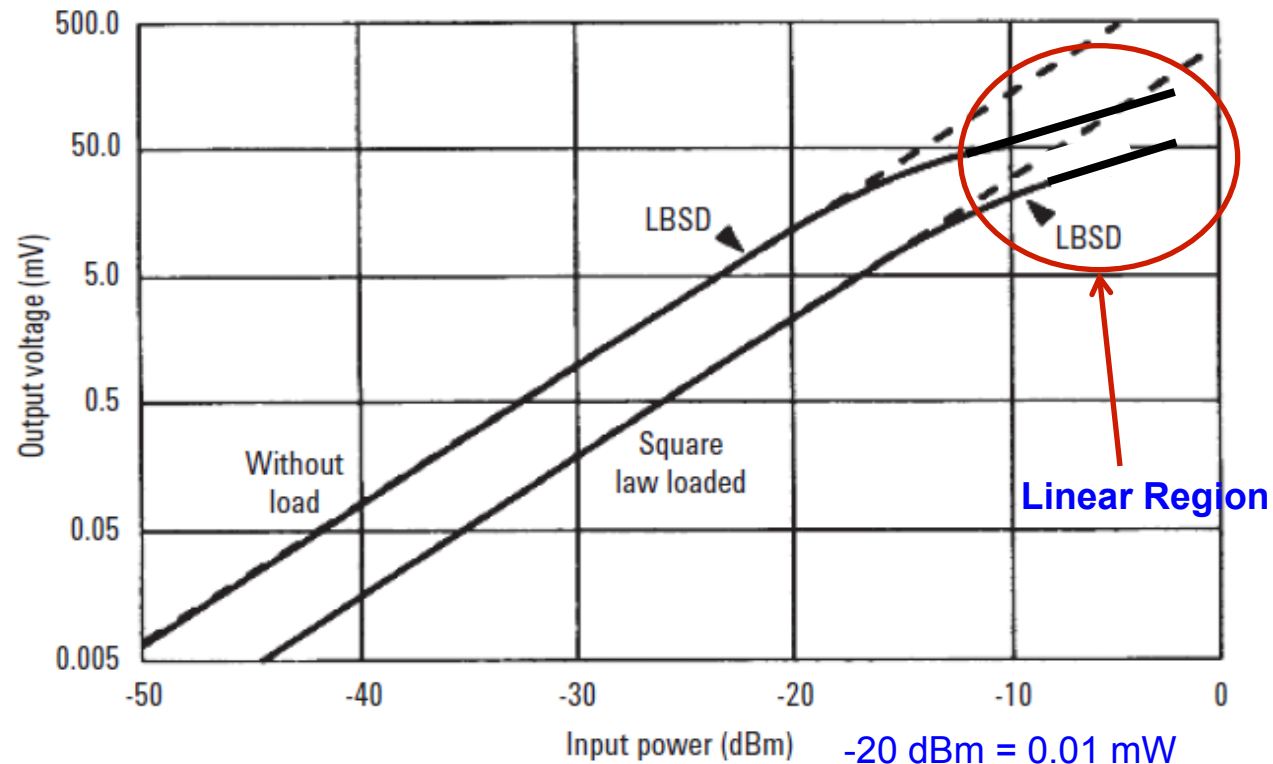

- ◆ The transition between the linear region and the square-law region is typically between -10 and -20 dBm RF power (see diagram).

The RF diode (5)

- ◆ Due to the square-law characteristic we arrive at the thermal noise region already for moderate power levels (-50 to -60 dBm) and hence the V_{Video} disappears in the thermal noise

- ◆ This is described by the term *tangential signal sensitivity (TSS)* where the detected signal (Observation BW, usually 10 MHz) is 4 dB over the thermal noise floor

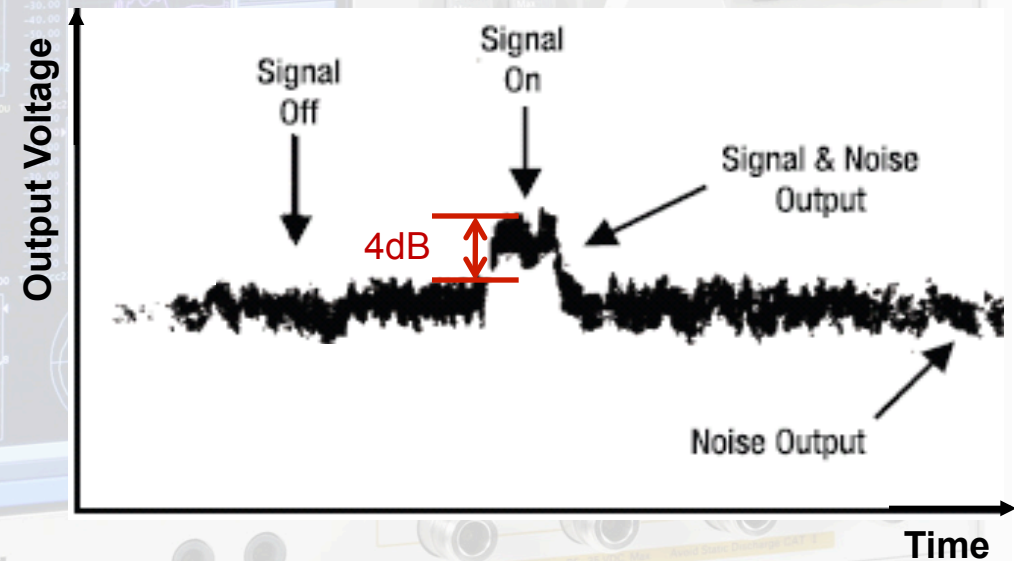

Appendix G: The RF mixer (1)

- ◆ For the detection of very small RF signals we prefer a device that has a linear response over the full range (from 0 dBm (= 1mW) down to thermal noise = -174 dBm/Hz = $4 \cdot 10^{-21}$ W/Hz)
- ◆ It is called “RF mixer”, and uses 1, 2 or 4 diodes in different configurations (see next slide)
- ◆ Together with a so called LO (local oscillator) signal, the mixer works as a signal multiplier, providing a very high dynamic range since the output signal is always in the “linear range”, assuming the mixer is not in saturation with respect to the RF input signal (For the LO signal the mixer should always be in saturation!)
- ◆ The RF mixer is essentially a multiplier implementing the function

$f_1(t) \cdot f_2(t)$ with $f_1(t) = \text{RF signal}$ and $f_2(t) = \text{LO signal}$

$$a_1 \cos(2\pi f_1 t + \varphi) \cdot a_2 \cos(2\pi f_2 t) = \frac{1}{2} a_1 a_2 [\cos((f_1 + f_2)t + \varphi) + \cos((f_1 - f_2)t + \varphi)]$$

- ◆ Thus we obtain a response at the IF (intermediate frequency) port as sum and difference frequencies of the LO and RF signals

The RF mixer (2)

◆ Examples of different mixer configurations

A. Single-Ended Mixer

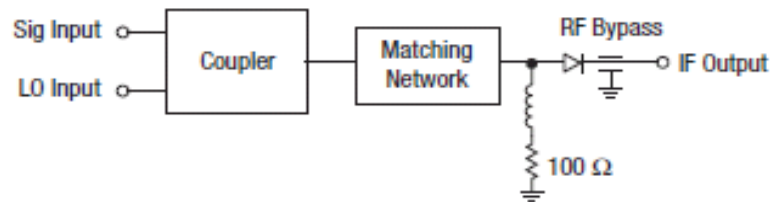

B. Balanced Mixers

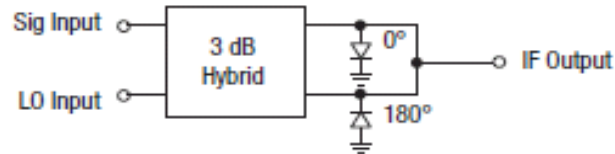
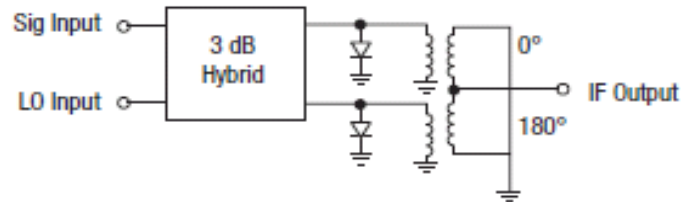

C. Double-Balanced Mixer

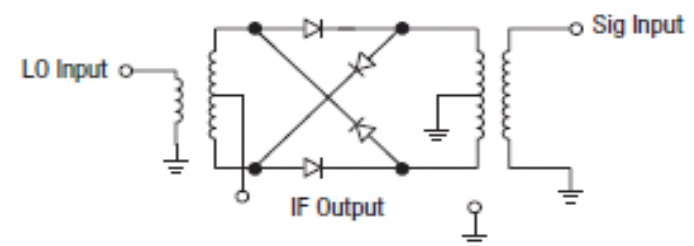

◆ A typical coaxial mixer (SMA connector)

The RF mixer (3)

◆ Response of a mixer in time and frequency domain:

◆ Input signals here:

◆ LO = 10 MHz

◆ RF = 8 MHz

◆ Mixing products at 2 and 18 MHz and higher order terms at higher frequencies

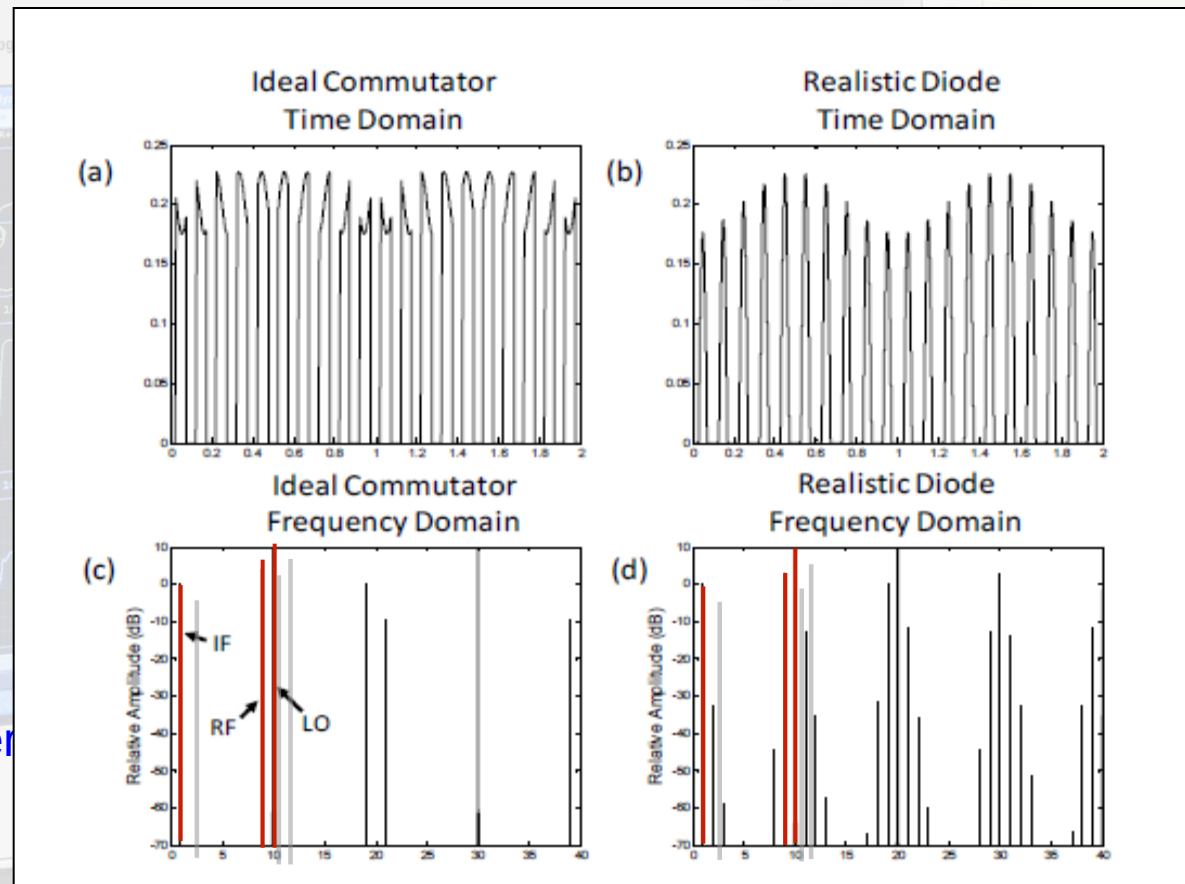

The RF mixer (4)

Dynamic range and IP3 of an RF mixer

- ◆ The abbreviation IP3 stands for *third order intermodulation point*, where the two lines shown in the right diagram intersect. Two signals ($f_1, f_2 > f_1$) which are closely spaced by Δf in frequency are simultaneously applied to the DUT. The intermodulation products appear at $+\Delta f$ above f_2 and at $-\Delta f$ below f_1 .
- ◆ This intersection point is usually not measured directly, but extrapolated from measurement data at much lower power levels to avoid overload and/or damage of the DUT.

