

Experimental particle. physics

esipap...
European School of Instrumentation
in Particle & Astroparticle Physics

5.

particle experiment design
(and a few words on
S/B optimization)



SUISSE
FRANCE

CMS

LHCb

CERN
Prévessin

ATLAS

CERN
Meyrin

SPS - 7 km

PS - 2.6 km

ALICE

LHC - 27 km

The ATLAS detector

[expected performance]

EM Calorimeters: $\sigma/E \approx 10\%/\sqrt{E} \oplus 0.7\%$

excellent e/ γ identification
good energy resolution (e.g. for $H \rightarrow \gamma\gamma$)

Precision Muon Spectrometer: $\sigma/p_t \approx 10\% @ 1 \text{ TeV}$

fast trigger response
good momentum resolution
(e.g. $A/Z' \rightarrow \mu\mu$, $H \rightarrow 4\mu$)

Hadron Calorimeter:

$\sigma/E \approx 50\%/\sqrt{E} \oplus 3\%$
good jet resolution
good missing E_T resolution
(e.g. $H \rightarrow \tau\tau$)

Inner Detector:

Si Pixel & strips; TRT
 $\sigma/p_t \approx 5 \cdot 10^{-4} p_t \oplus 0.001$
good impact parameter res., i.e.
 $\sigma(d_0) \approx 15 \mu\text{m} @ 20 \text{ GeV}$
(e.g. $H \rightarrow b\bar{b}$)

Magnets:

Solenoid (inner detector): 2 T
Toroid (muon spectrometer): 0.5 T

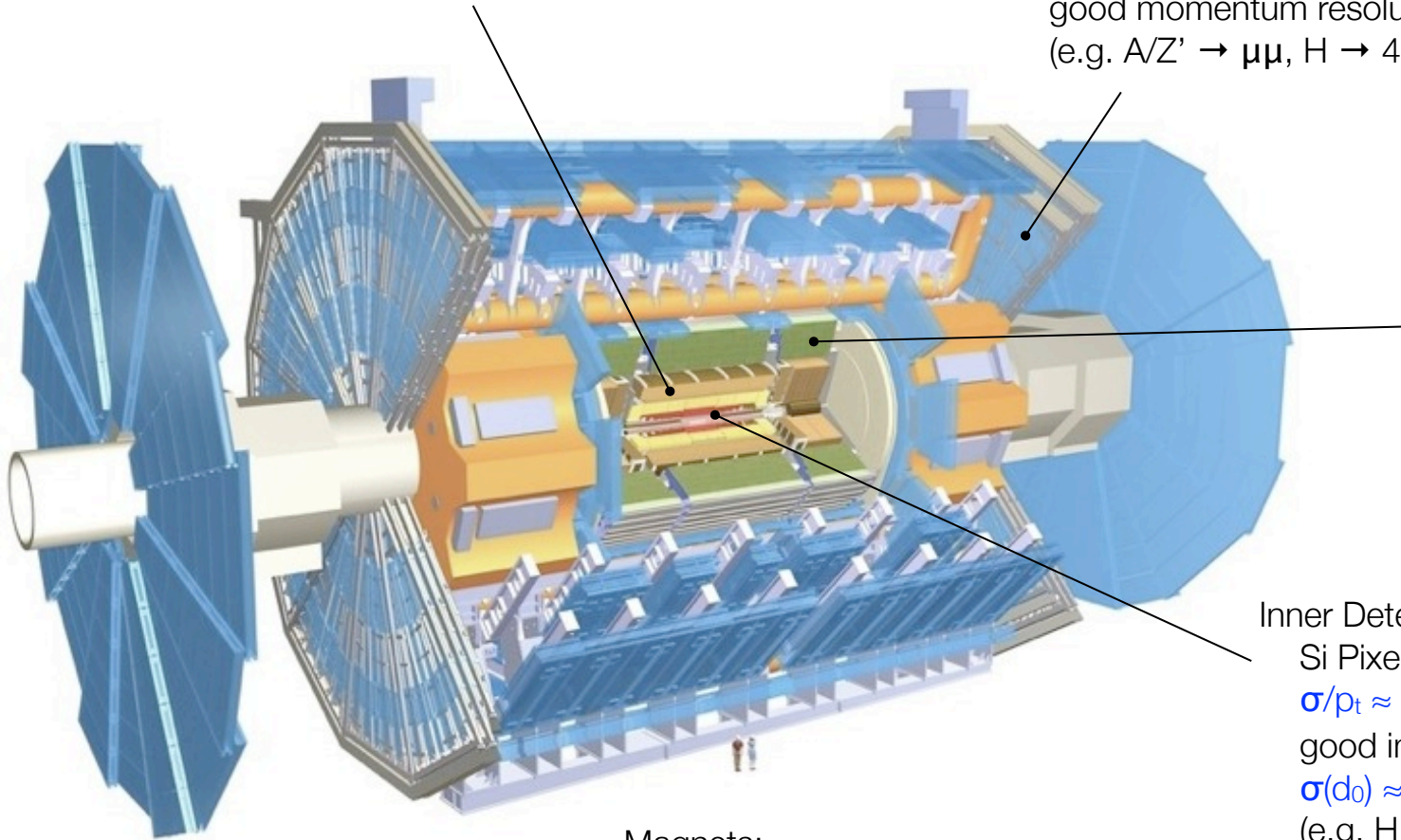

The CMS detector

[expected performance]

Inner Detector:

$$\sigma/p_t \approx 5 \cdot 10^{-4} p_t \oplus 0.001$$

[vs. ATLAS $\sigma/p_t \approx 5 \cdot 10^{-4} p_t \oplus 0.001$]

EM Calorimeters:

$$\sigma/E \approx 3\%/\sqrt{E} \oplus 0.5\%$$

[vs. ATLAS: $\sigma/E \approx 10\%/\sqrt{E} \oplus 0.7\%$]

Hadron Calorimeter:

$$\sigma/E \approx 100\%/\sqrt{E} \oplus 5\%$$

[vs. ATLAS: $\sigma/E \approx 50\%/\sqrt{E} \oplus 3\%$]

Muon Spectrometer

$$\sigma/p_t \approx 10\% @ 1 \text{ TeV}$$

[vs. ATLAS: $\sigma/p_t \approx 10\% @ 1 \text{ TeV}$]

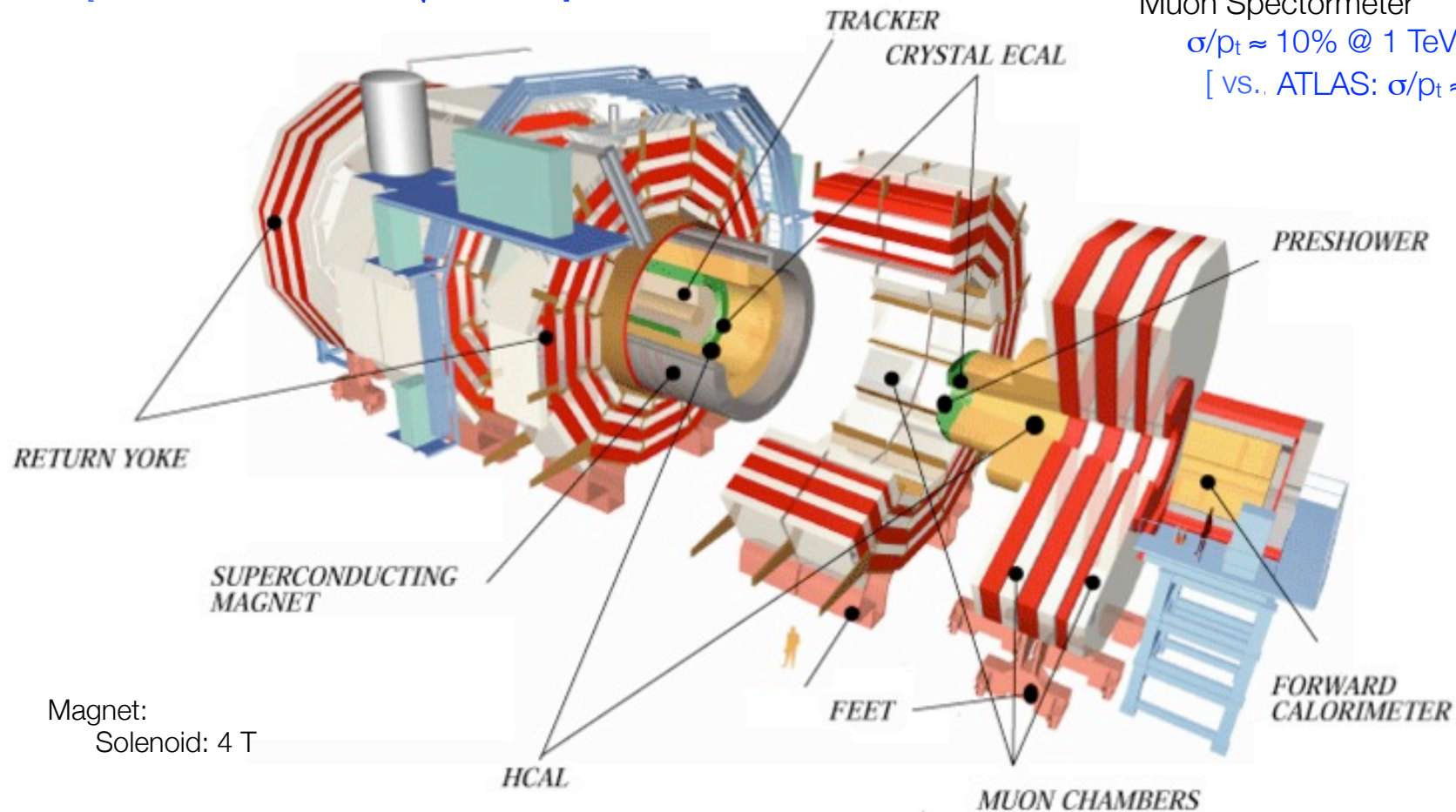

Magnet:
Solenoid: 4 T

The ATLAS detector

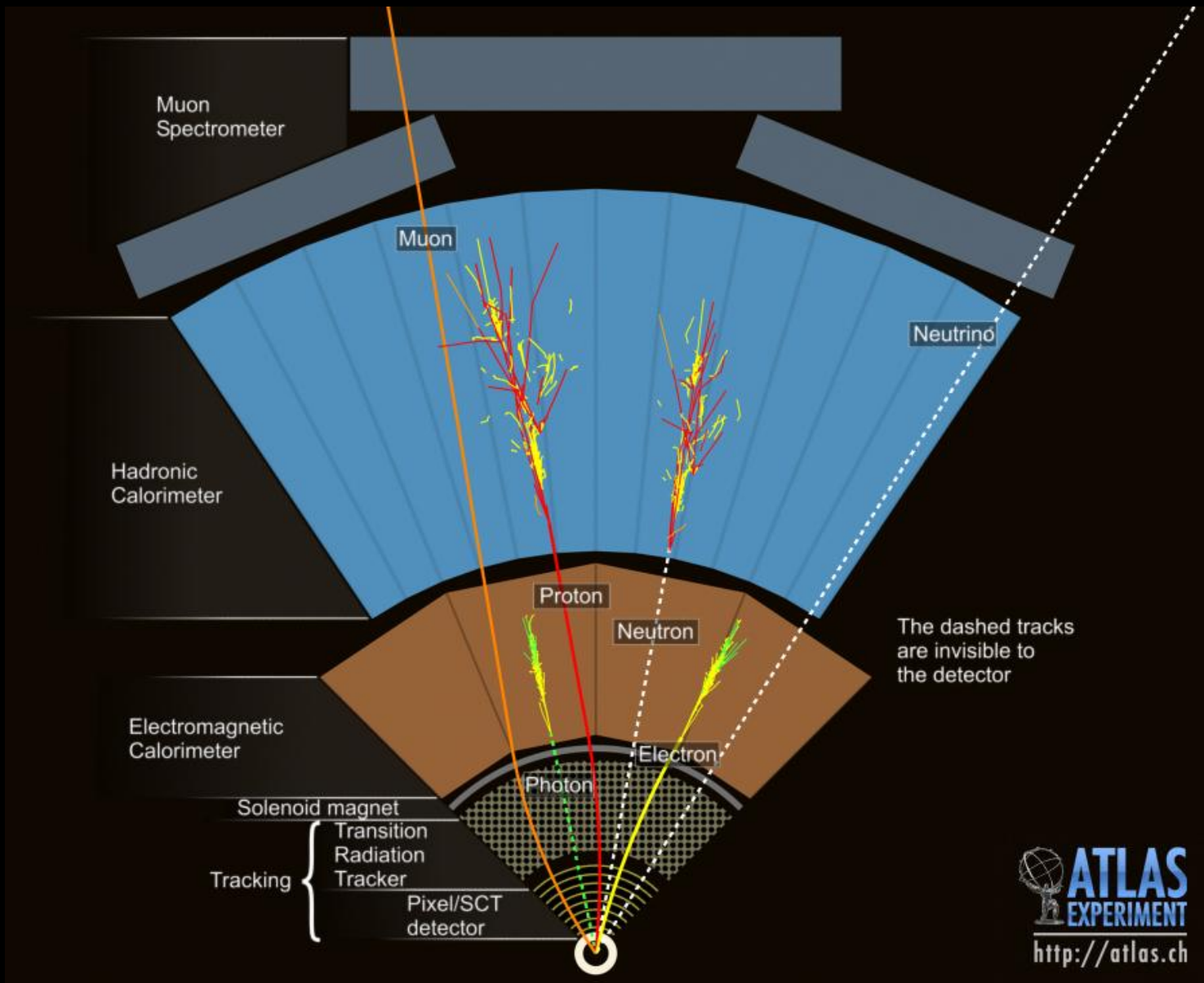

The CMS detector

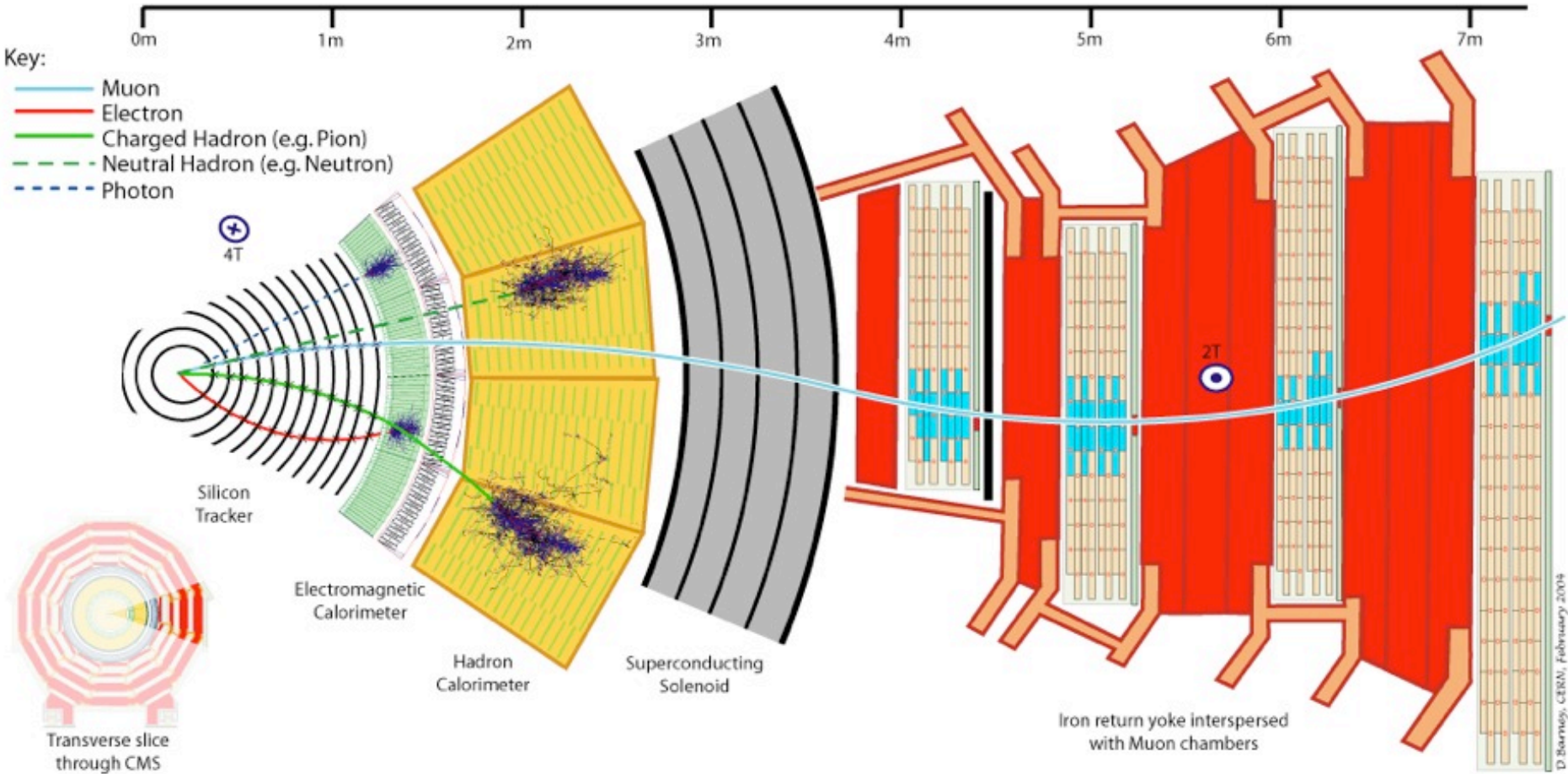

Main Design Parameters Comparison

TABLE 2 Main design parameters of the ATLAS and CMS detectors

Parameter	ATLAS	CMS
Total weight (tons)	7000	12,500
Overall diameter (m)	22	15
Overall length (m)	46	20
Magnetic field for tracking (T)	2	4
Solid angle for precision measurements ($\Delta\phi \times \Delta\eta$)	$2\pi \times 5.0$	$2\pi \times 5.0$
Solid angle for energy measurements ($\Delta\phi \times \Delta\eta$)	$2\pi \times 9.6$	$2\pi \times 9.6$
Total cost (million Swiss francs)	550	550

This table (and others) from:

Daniel Froidevaux and Paris Sphicas, "GENERAL-PURPOSE DETECTORS FOR THE LARGE HADRON COLLIDER",
Annu. Rev. Nucl. Part. Sci. 2006. 56:375–440

ATLAS vs. CMS

ATLAS

CMS

Magnetic field

2 T solenoid + toroid
(0.5 T barrel; 1 T end-cap)

4 T solenoid + return yoke

Tracker

Si pixels and strips + TRT
 $\sigma/p_T \approx 5 \times 10^{-4} p_T + 0.01$

Si pixels and strips
 $\sigma/p_T \approx 1.5 \times 10^{-4} p_T + 0.005$

EM calorimeter

LAr + Pb
 $\sigma/E \approx 10\%/\sqrt{E} \oplus 0.007$

PbWO₄ crystals
 $\sigma/E \approx 2-6\%/\sqrt{E} \oplus 0.005$

Hadronic calorimeter

Scint. + Fe / LAr + Cu (10 λ)
 $\sigma/E \approx 50\%/\sqrt{E} \oplus 0.03 \text{ GeV}$

Scint. + Cu (5.8 λ + catcher)
 $\sigma/E \approx 100\%/\sqrt{E} \oplus 0.05 \text{ GeV}$

Muon spectrometer

$\sigma/p_T \approx 2\% @ 50 \text{ GeV} -$
 $10\% @ 1 \text{ TeV (ID + MS)}$

$\sigma/p_T \approx 1\% @ 50 \text{ GeV} -$
 $5\% @ 1 \text{ TeV (ID + MS)}$

Trigger

LI + Rol-based HLT (L2 + EF)

LI + HLT (L2 + L3)

$\sigma_m / m_H (H \rightarrow \gamma\gamma)$

1.2 GeV @ $m_H = 120 \text{ GeV}$

0.7 GeV @ $m_H = 120 \text{ GeV}$

- G.Aad et al (ATLAS Collaboration). J. Instrum. 3. s08003 (2008)
- S.Chatrchysn (CMS Collaboration), J. Instrum. 3. s08004 (2008)

Main design choices

- **ATLAS**

- ✓ Invested much in three superconducting toroid magnets and a set of precise muon chambers
 - “This system provides a stand-alone muon momentum measurement”
- ✓ Transition detector in the tracking system (electron vs. pions)
- ✓ Sampling calorimeter
 - Mediocre energy resolution, longitudinal segmentation, fine lateral segmentation
- ✓ Good HAD calorimeter

- **CMS**

- ✓ Invested in highest possible magnetic field (4T)
- ✓ Inner tracker consisting of all silicon detectors
- ✓ Homogeneous EM Calorimeter
 - Excellent energy resolution, no longitudinal segmentation, coarse lateral segmentation
- ✓ Mediocre HAD calorimeter

A wide-angle, low-perspective shot of a massive industrial facility, likely a particle accelerator. The scene is dominated by a central tunnel-like structure lined with large, cylindrical components, possibly magnet sections, each wrapped with orange safety bands. The structure is supported by a complex network of blue and green steel beams and scaffolding. A person in a yellow hard hat and safety vest stands on a platform in the lower center, providing a sense of scale. The lighting is bright and even, highlighting the metallic surfaces and the intricate engineering of the facility.

Magnet systems

Magnet systems

- ATLAS

- ✓ Driven by the goal to achieve a **high-precision stand-alone momentum measurement of muons** “*achieved using an arrangement of a small-radius thin-walled solenoid integrated into the cryostat of the barrel ECAL, surrounded by a system of three large air-core toroids, situated outside the ATLAS calorimeter systems, and generating the magnetic field for the muon spectrometer.*”

- CMS

- ✓ A **single magnet** with “*a high magnetic field in the tracker volume for all p precision momentum measurements, and a high enough return flux in the iron outside the magnet to provide a muon trigger and a second muon momentum measurement.*”

ATLAS magnets



CMS magnet

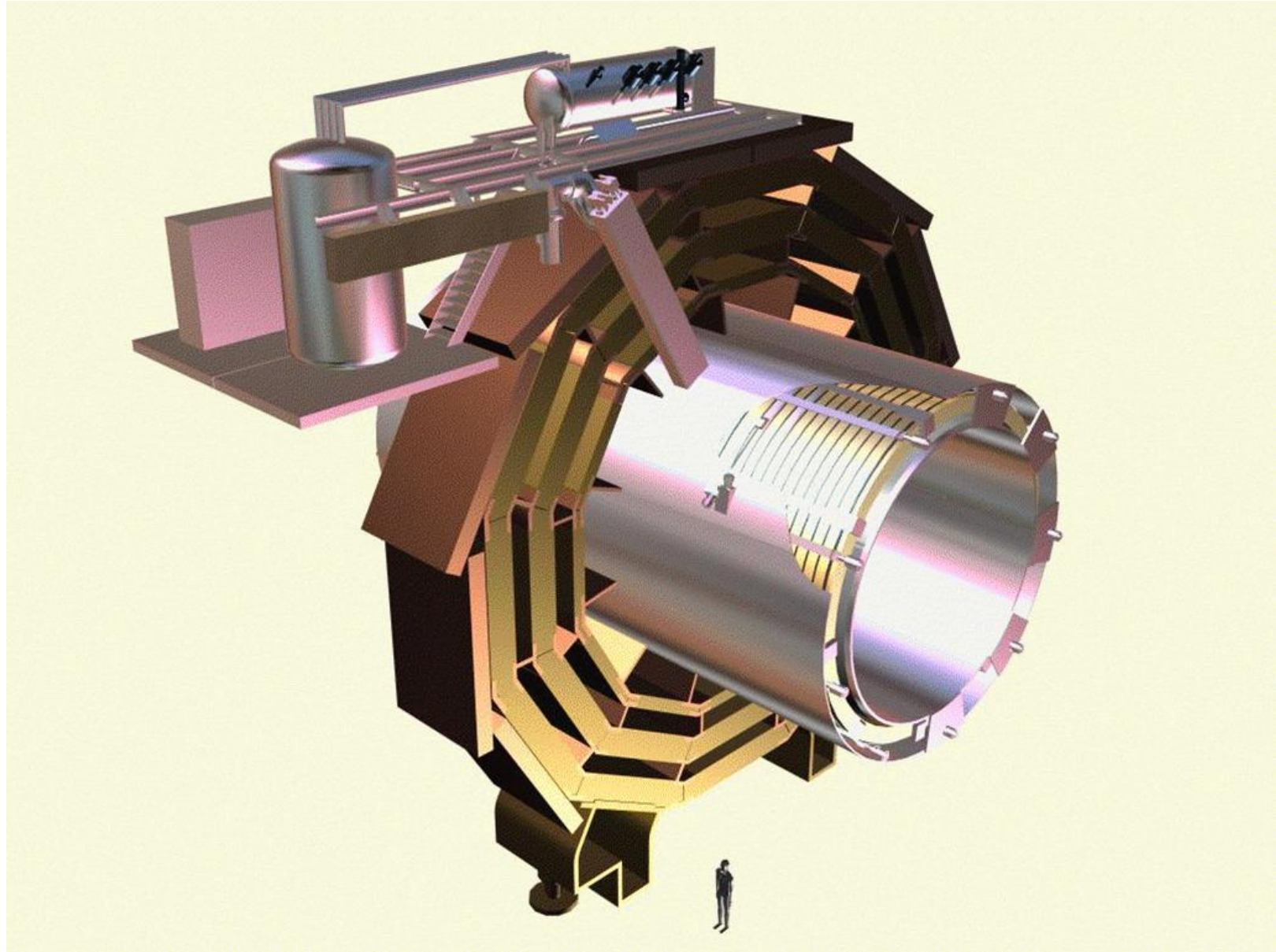

Magnet systems

TABLE 3 Main parameters of the CMS and ATLAS magnet systems

Parameter	CMS		ATLAS	
	Solenoid	Solenoid	Barrel toroid	End-cap toroids
Inner diameter	5.9 m	2.4 m	9.4 m	1.7 m
Outer diameter	6.5 m	2.6 m	20.1 m	10.7 m
Axial length	12.9 m	5.3 m	25.3 m	5.0 m
Number of coils	1	1	8	8
Number of turns per coil	2168	1173	120	116
Conductor size (mm ²)	64 × 22	30 × 4.25	57 × 12	41 × 12
Bending power	4 T · m	2 T · m	3 T · m	6 T · m
Current	19.5 kA	7.7 kA	20.5 kA	20.0 kA
Stored energy	2700 MJ	38 MJ	1080 MJ	206 MJ

A circular view into a complex particle detector, likely the ATLAS or CMS at CERN. The detector consists of multiple concentric layers of sensitive components, including silicon trackers, calorimeters, and muon chambers. The central opening shows a person in a white lab coat looking through the detector, symbolizing the inner tracker systems. The text "Inner tracker systems" is overlaid in large orange letters.

Inner tracker systems

Inner tracking systems

TABLE 4 Main parameters of the ATLAS and CMS tracking systems (see Table 6 for details of the pixel systems)

Parameter	ATLAS	CMS
Dimensions (cm)		
-radius of outermost measurement	101–107	107–110
-radius of innermost measurement	5.0	4.4
-total active length	560	540
Magnetic field B (T)	2	4
BR^2 (T · m ²)	2.0 to 2.3	4.6 to 4.8
Total power on detector (kW)	70	60
Total weight in tracker volume (kg)	≈4500	≈3700
Total material (X/X ₀)		
-at $\eta \approx 0$ (minimum material)	0.3	0.4
-at $\eta \approx 1.7$ (maximum material)	1.2	1.5
-at $\eta \approx 2.5$ (edge of acceptance)	0.5	0.8
Total material (λ/λ_0 at max)	0.35	0.42
Silicon microstrip detectors		
-number of hits per track	8	14
-radius of innermost meas. (cm)	30	20
-total active area of silicon (m ²)	60	200
-wafer thickness (microns)	280	320/500
-total number of channels	6.2×10^6	9.6×10^6
-cell size (μm in $R\phi \times \text{cm}$ in z/R)	80×12	$80/120 \times 10$
-cell size (μm in $R\phi \times \text{cm}$ in z/R)		and $120/180 \times 25$
Straw drift tubes (ATLAS only)		
-number of hits per track ($ \eta < 1.8$)	35	
-total number of channels	350,000	
-cell size (mm in $R\phi \times \text{cm}$ in z)	4×70 (barrel)	
	4×40 (end caps)	

Pixel detectors

TABLE 6 Main parameters of the ATLAS and CMS pixel systems

	ATLAS	CMS
Number of hits per track	3	3
Total number of channels	$80 \cdot 10^6$	$66 \cdot 10^6$
Pixel size (μm in $R\phi \times \mu\text{m}$ in z/R)	50×400	100×150
Lorentz angle (degrees), initial to end	12 to 4	26 to 8
Tilt in $R\phi$ (degrees)	20 (only barrel)	20 (only end cap)
Total active area of silicon (m^2)	$1.7 (n^+ / n)$	$1.0 (n^+ / n)$
Sensor thickness (μm)	250	285
Total number of modules	1744 (288 in disks)	1440 (672 in disks)
Barrel layer radii (cm)	5.1, 8.9, 12.3	4.4, 7.3, 10.2
Disk layer min. to max. radii (cm)	8.9 to 15.0	6.0 to 15.0
Disk positions in z (cm)	49.5, 58.0, 65.0	34.5, 46.5
Signal-to-noise ratio for minimum ionizing particles (day 1)	120	130
Total fluence at $L = 10^{34} (n_{eq}/\text{cm}^2/\text{year})$ at radius of 4–5 cm (innermost layer)	3×10^{14}	3×10^{14}
Signal-to-noise ratio (after $10^{15} n_{eq}/\text{cm}^2$)	80	80
Resolution in $R\phi$ (μm)	≈ 10	≈ 10
Resolution in z/R (μm)	≈ 100	≈ 20

Inner tracking systems

• ATLAS

- ✓ Solenoidal field: 2 T
- ✓ Silicon (strips and pixels) + TRT
 - high granularity and resolution close to interaction region
 - “continuous” tracking at large radii

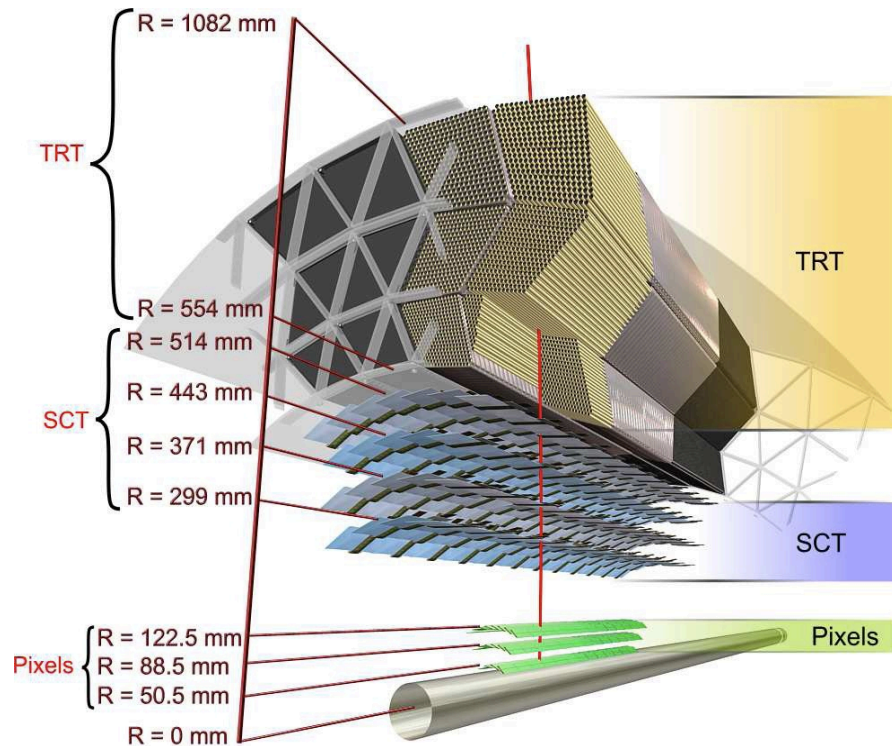

• CMS

- ✓ Solenoidal field: 4 T
- ✓ Full silicon strip and pixel detectors
 - high resolution
 - high granularity

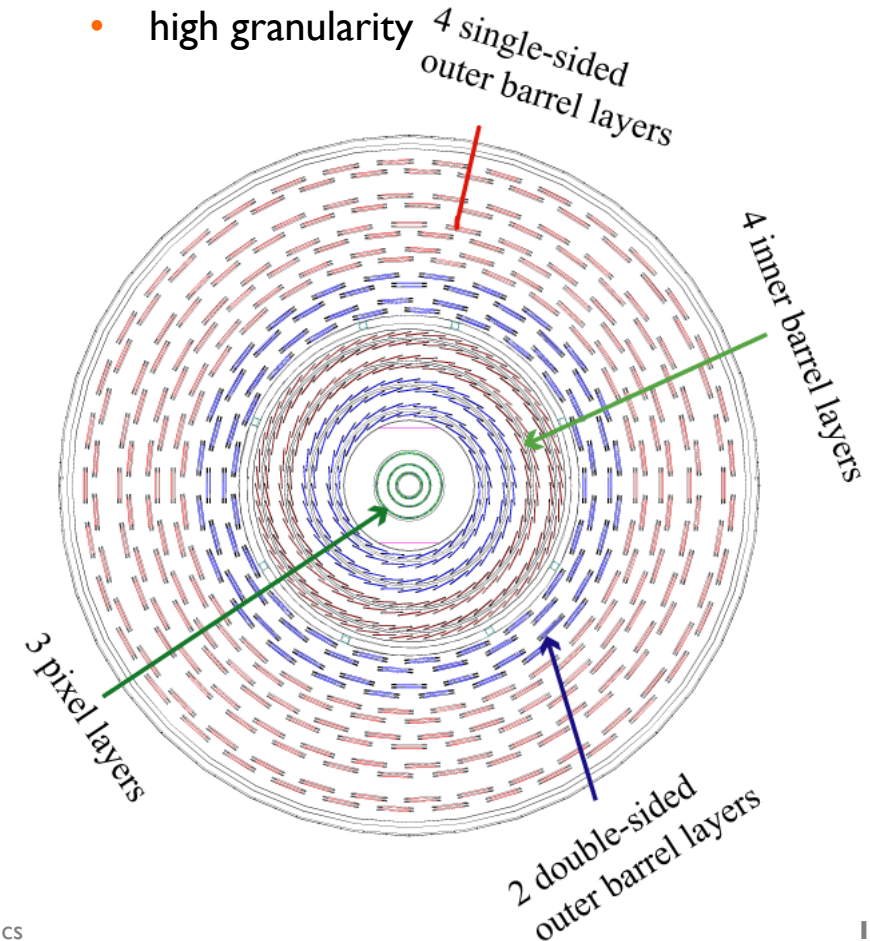

Main performance of tracking systems

	ATLAS	CMS
Reconstruction efficiency for muons with $p_T = 1$ GeV	96.8%	97.0%
Reconstruction efficiency for pions with $p_T = 1$ GeV	84.0%	80.0%
Reconstruction efficiency for electrons with $p_T = 5$ GeV	90.0%	85.0%
Momentum resolution at $p_T = 1$ GeV and $\eta \approx 0$	1.3%	0.7%
Momentum resolution at $p_T = 1$ GeV and $\eta \approx 2.5$	2.0%	2.0%
Momentum resolution at $p_T = 100$ GeV and $\eta \approx 0$	3.8%	1.5%
Momentum resolution at $p_T = 100$ GeV and $\eta \approx 2.5$	11%	7%
Transverse i.p. resolution at $p_T = 1$ GeV and $\eta \approx 0$ (μm)	75	90
Transverse i.p. resolution at $p_T = 1$ GeV and $\eta \approx 2.5$ (μm)	200	220
Transverse i.p. resolution at $p_T = 1000$ GeV and $\eta \approx 0$ (μm)	11	9
Transverse i.p. resolution at $p_T = 1000$ GeV and $\eta \approx 2.5$ (μm)	11	11
Longitudinal i.p. resolution at $p_T = 1$ GeV and $\eta \approx 0$ (μm)	150	125
Longitudinal i.p. resolution at $p_T = 1$ GeV and $\eta \approx 2.5$ (μm)	900	1060

- Momentum resolution on average superior in CMS
- Similar vertexing and b-tagging performances are similar
- Impact of material and B-field already visible on efficiencies

Amount of material in inner trackers

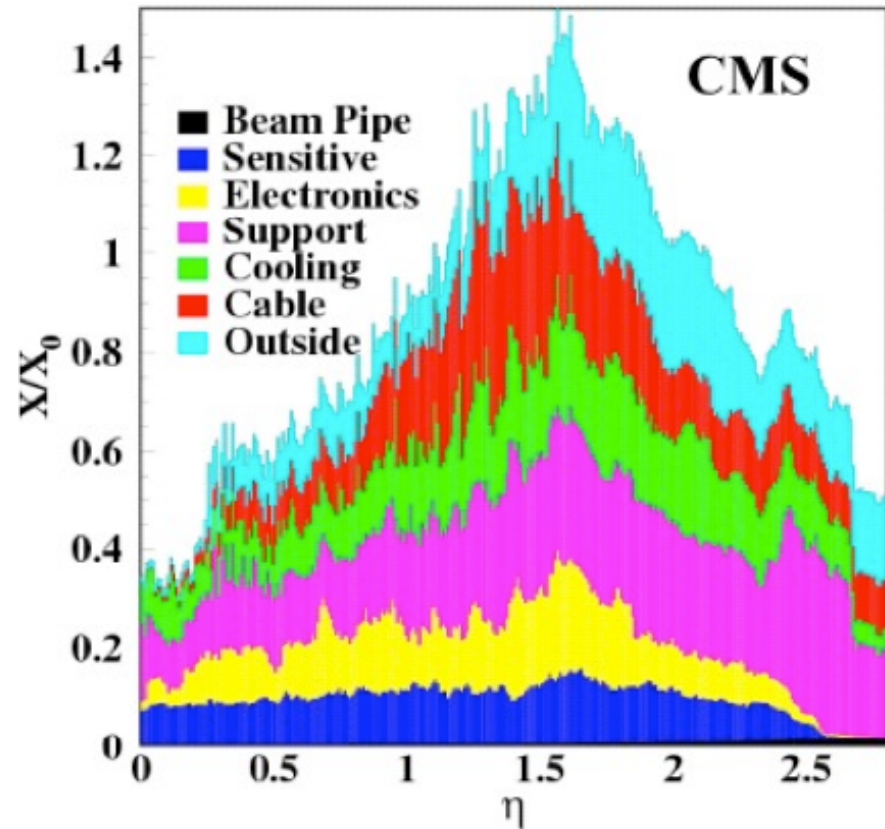
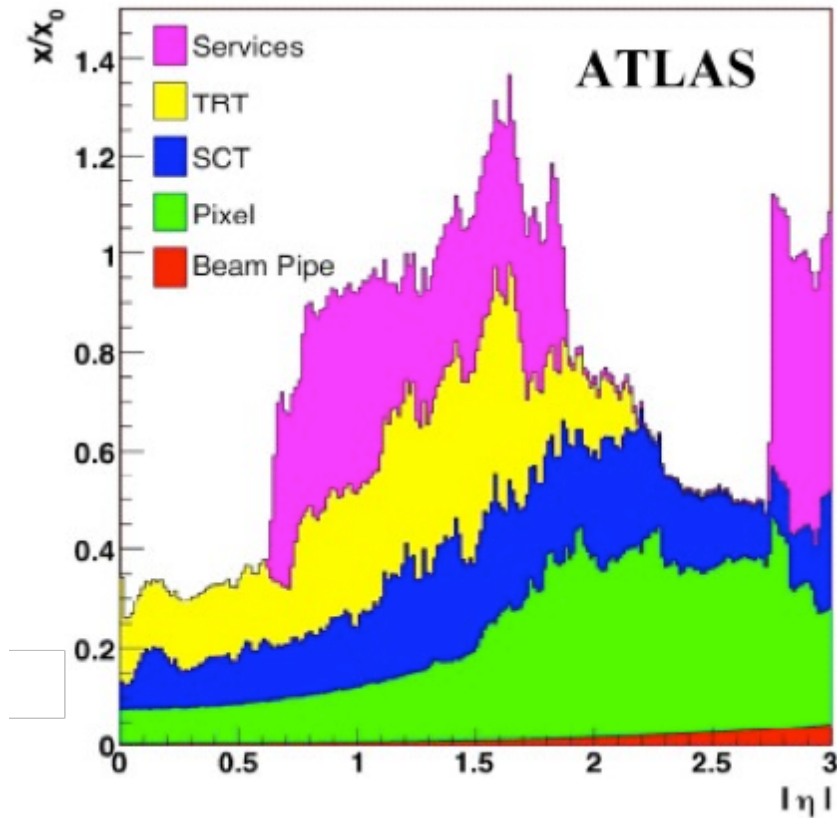

- Active sensors and mechanics account each only for $\sim 10\%$ of material budget
- Need to bring ~ 70 kW power into tracker and to remove similar amount of heat
 - ✓ Very distributed set of heat sources and power-hungry electronics inside volume
 - ✓ Complex layout of services, most of which are difficult to properly implement in detector simulation (calorimeter calibration!)

Electromagnetic calorimeters



Electromagnetic calorimeter

- **ATLAS**

- ✓ EM calorimeter is outside inner solenoidal field
 - More material in front, energy losses, photon conversions
- ✓ Sampling calorimeter
 - Liquid argon + Pb
 - Worse energy resolution
 - High granularity and segmentation (η , ϕ , longitudinally)
 - better PID and rejection
 - position measurement for photons
- ✓ Electrical signals
 - High stability in calibration and radiation resistant

- **CMS**

- ✓ EM calorimeter is bathed in magnetic field
 - Shower shape distortion
- ✓ Homogenous calorimeter
 - PbWO₄ crystal calorimeter
 - Higher intrinsic resolution
 - Poorer segmentation
- ✓ Light signals
 - Crystal light response vary with radiation, calibration vs. time complicated

ATLAS electromagnetic calorimeter

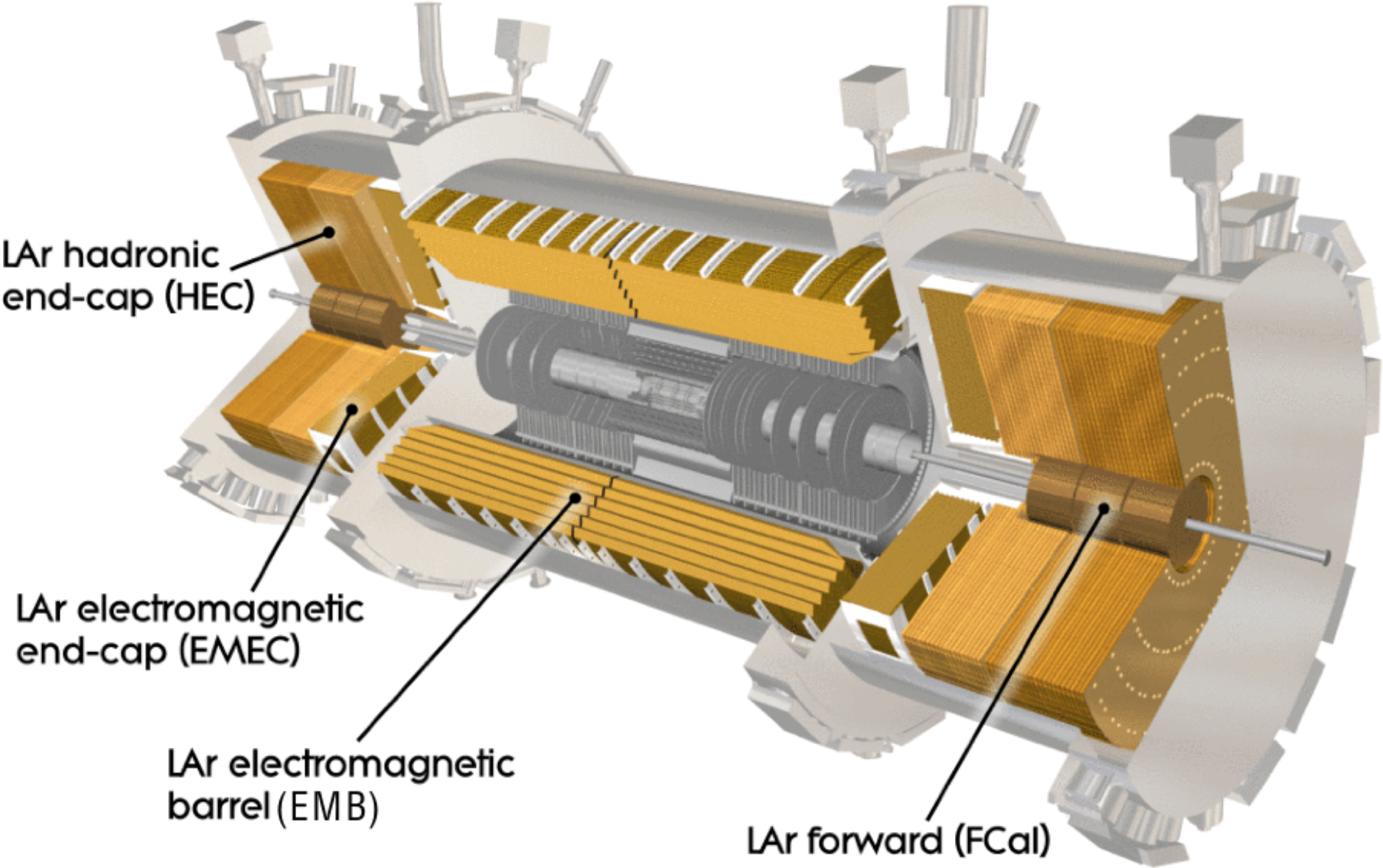

CMS electromagnetic calorimeter

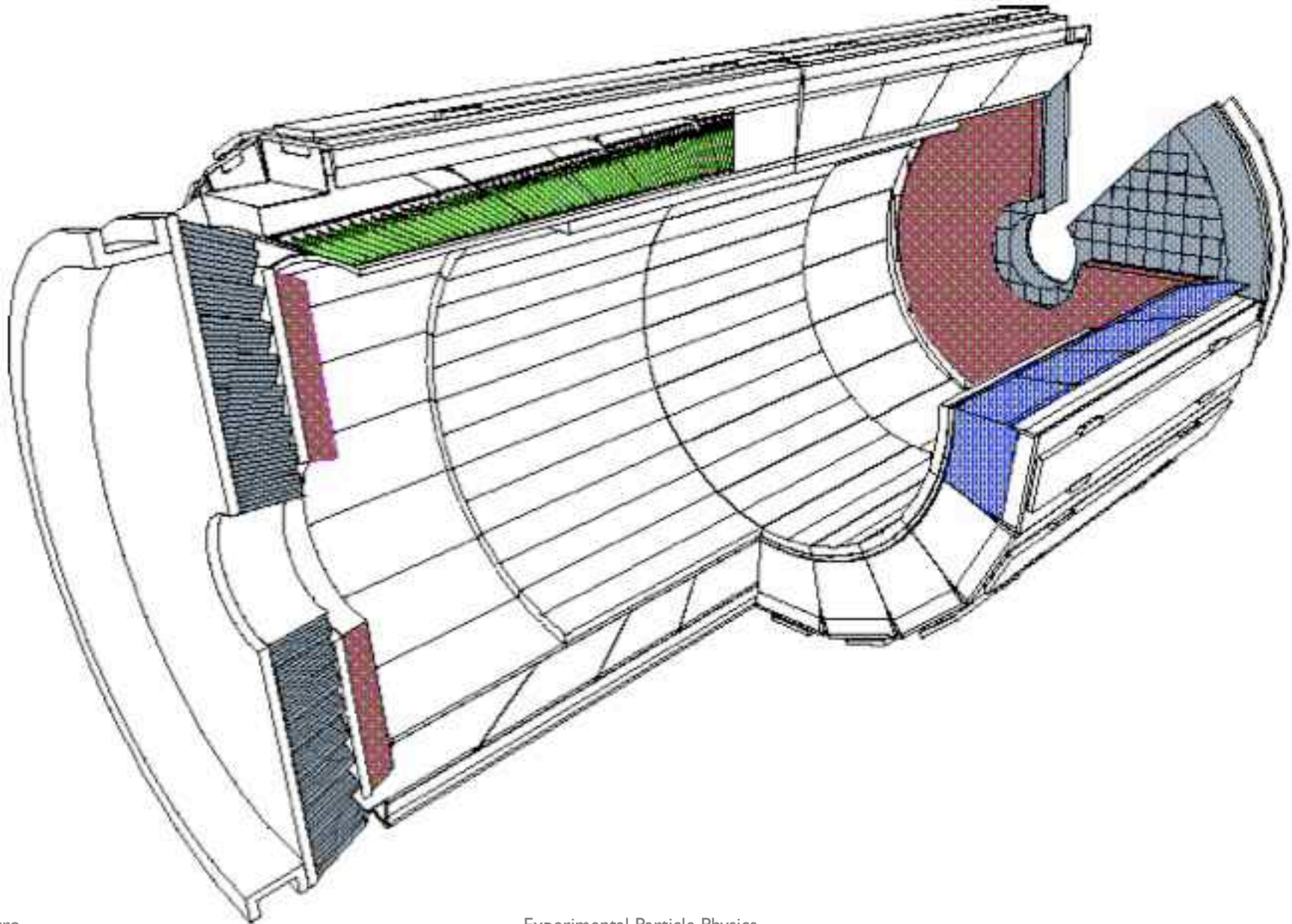

Electromagnetic calorimeters

TABLE 8 Main parameters of the ATLAS and CMS electromagnetic calorimeters

	ATLAS		CMS	
	http://www.annualreviews.org			
Technology	Lead/LAr accordion		PbWO ₄ scintillating crystals	
Channels	Barrel 110,208	End caps 63,744	Barrel 61,200	End caps 14,648
Granularity	$\Delta\eta \times \Delta\phi$		$\Delta\eta \times \Delta\phi$	
Presampler	0.025 × 0.1	0.025 × 0.1		
Strips/ Si-preshower	0.003 × 0.1	0.003 × 0.1 to 0.006 × 0.1		32 × 32 Si-strips per 4 crystals
Main sampling	0.025 × 0.025	0.025 × 0.025	0.017 × 0.017	0.018 × 0.003 to 0.088 × 0.015
Back	0.05 × 0.025	0.05 × 0.025		
Depth	Barrel	End caps	Barrel	End caps
Presampler (LAr)	10 mm	2 × 2 mm		
Strips/ Si-preshower	≈4.3 X ₀	≈4.0 X ₀		3 X ₀
Main sampling	≈16 X ₀	≈20 X ₀	26 X ₀	25 X ₀
Back	≈2 X ₀	≈2 X ₀		
Noise per cluster	250 MeV	250 MeV	200 MeV	600 MeV
Intrinsic resolution	Barrel	End caps	Barrel	End caps
Stochastic term <i>a</i>	10%	10 to 12%	3%	5.5%
Local constant term <i>b</i>	0.2%	0.35%	0.5%	0.5%

Electromagnetic calorimeters

- ATLAS

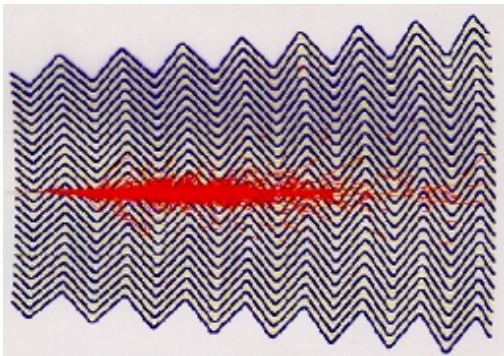
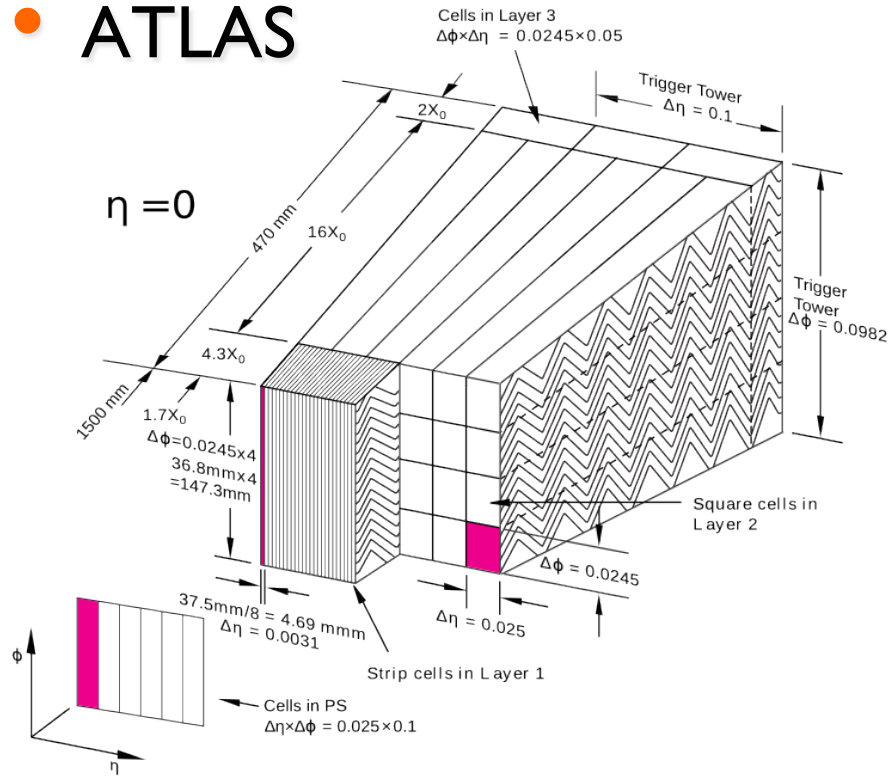

- CMS

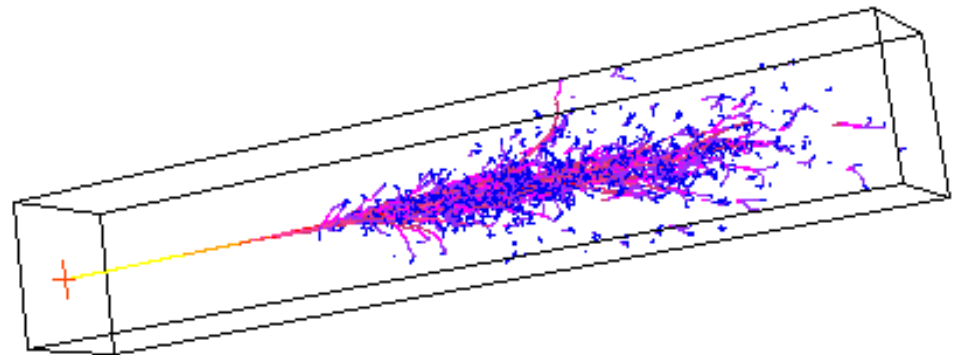

Performance of electromagnetic calorimeters

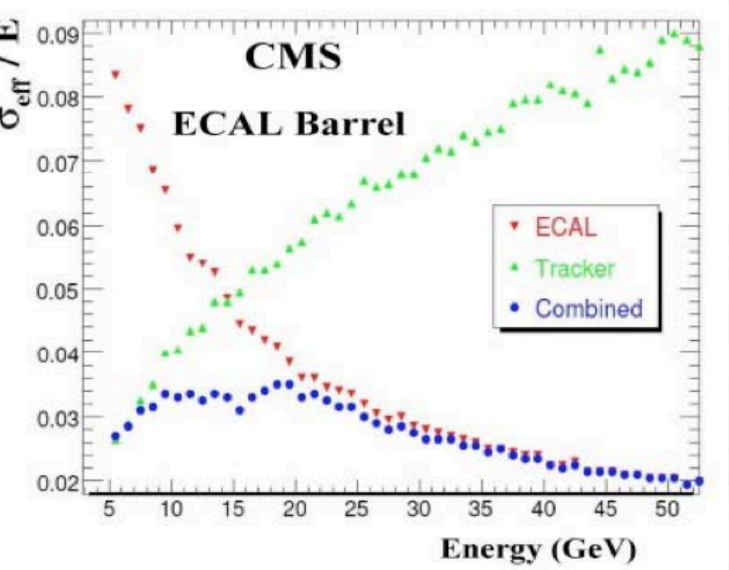
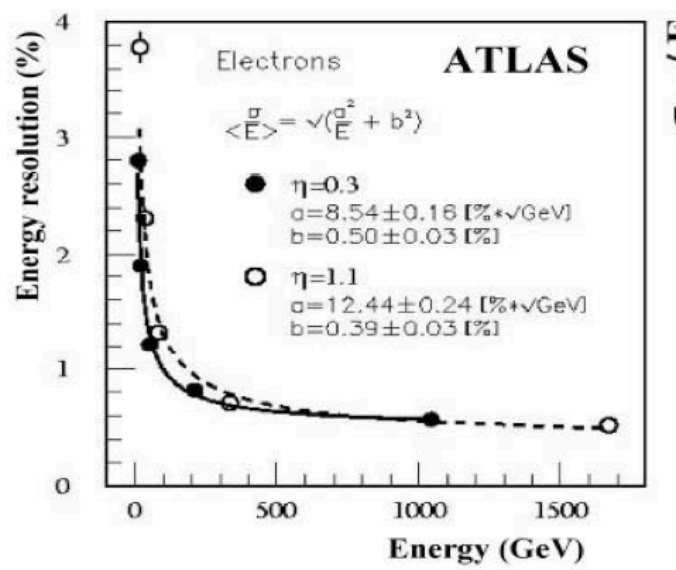
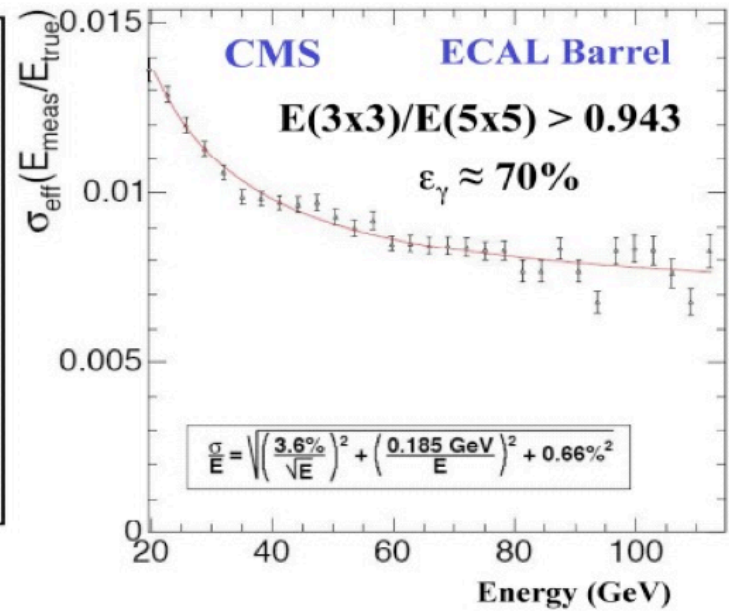
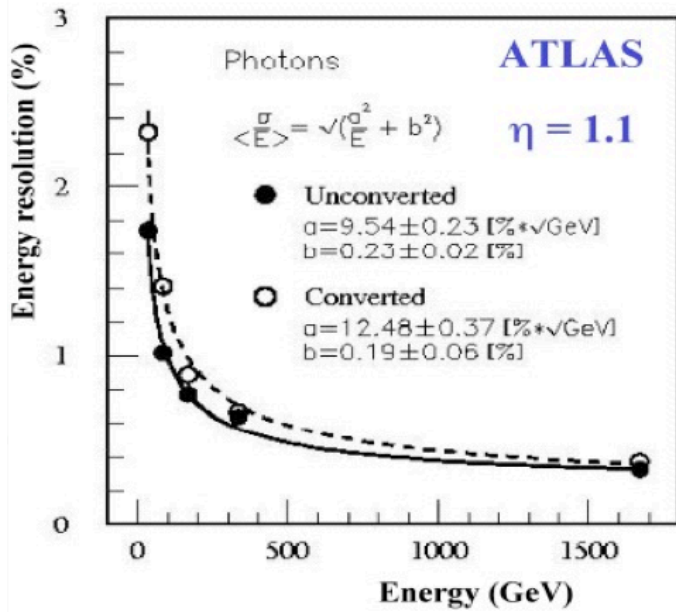



Hadronic calorimeters

ATLAS hadronic calorimeters

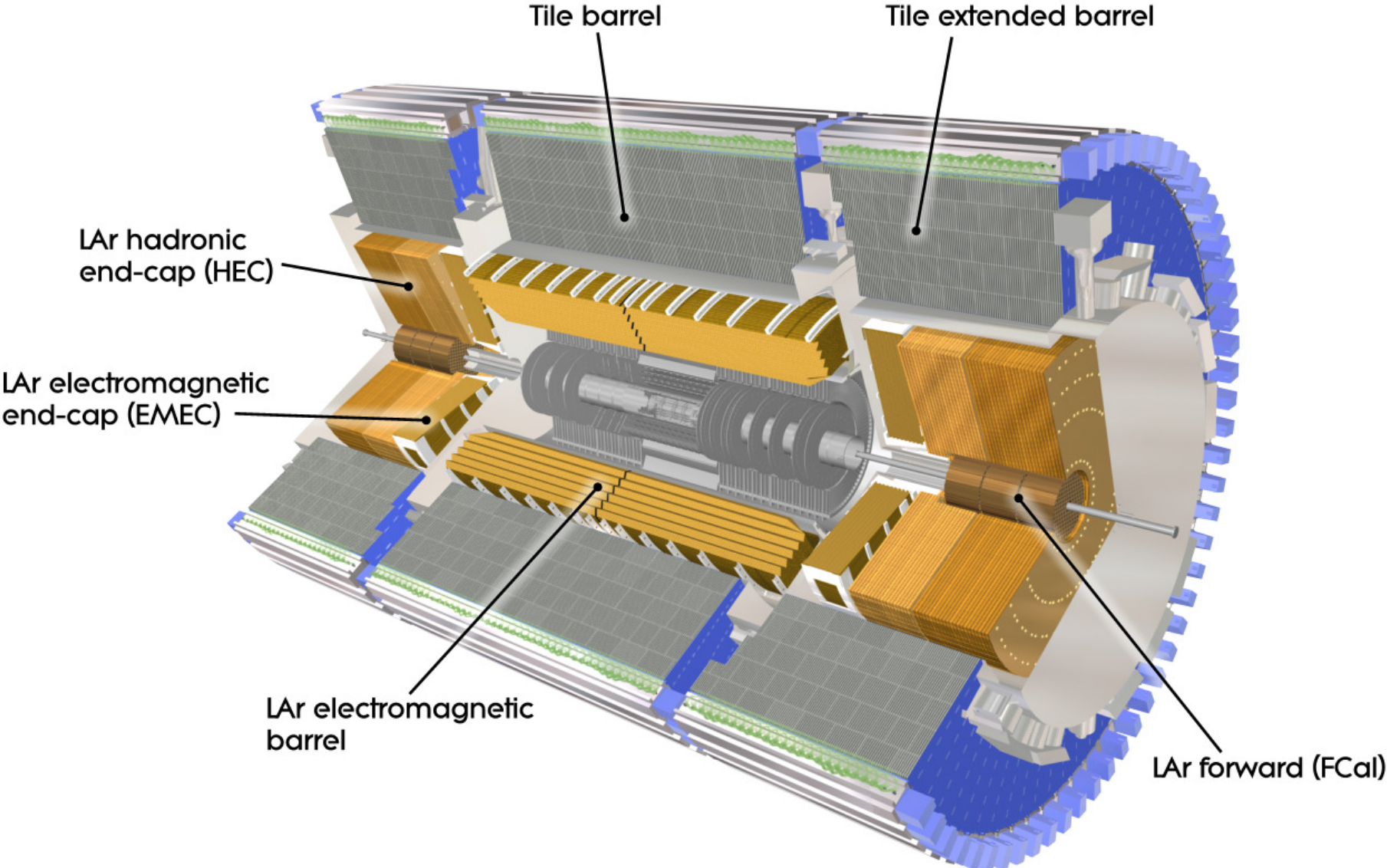

CMS hadronic calorimeter

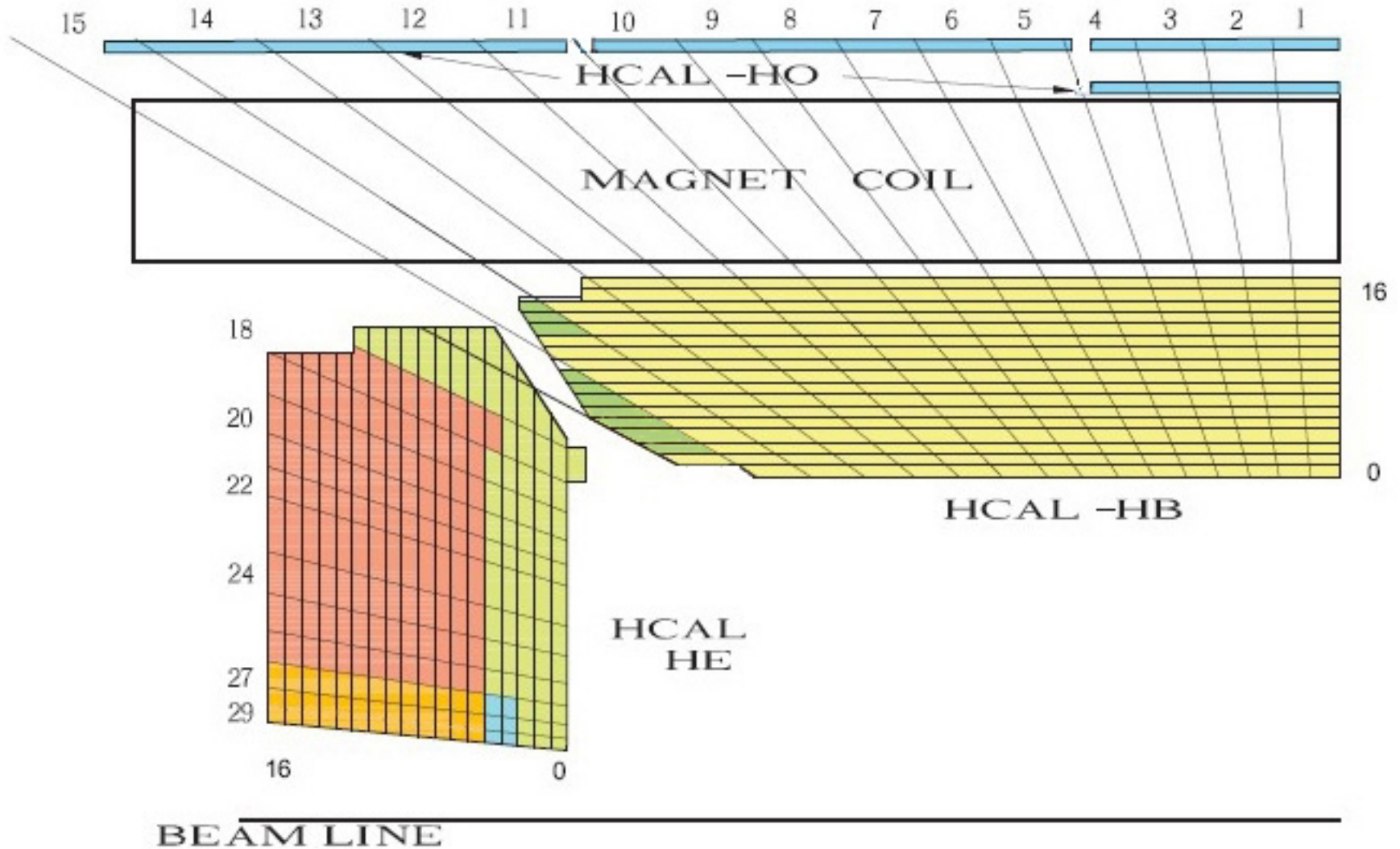



Hadronic calorimeters

TABLE 10 Main performance parameters of the different hadronic calorimeter components of the ATLAS and CMS detectors, as measured in test beams using charged pions in both stand-alone and combined mode with the ECAL

	ATLAS					
	Barrel LAr/Tile		End-cap LAr		CMS	
	Tile	Combined	HEC	Combined	Had. barrel	Combined
Electron/hadron ratio	1.36	1.37	1.49			
Stochastic term	$45\%/\sqrt{E}$	$55\%/\sqrt{E}$	$75\%/\sqrt{E}$	$85\%/\sqrt{E}$	$100\%/\sqrt{E}$	$70\%/\sqrt{E}$
Constant term	1.3%	2.3%	5.8%	< 1%		8.0%
Noise	Small	3.2 GeV		1.2 GeV	Small	1 GeV

The measured electron/hadron ratios are given separately for the hadronic stand-alone and combined calorimeters when available, and the contributions (added quadratically except for the stand-alone ATLAS tile calorimeter) to the pion energy resolution from the stochastic term, the local constant term, and the noise are also shown, when available from published data.

Hadronic absorption length

- ATLASs

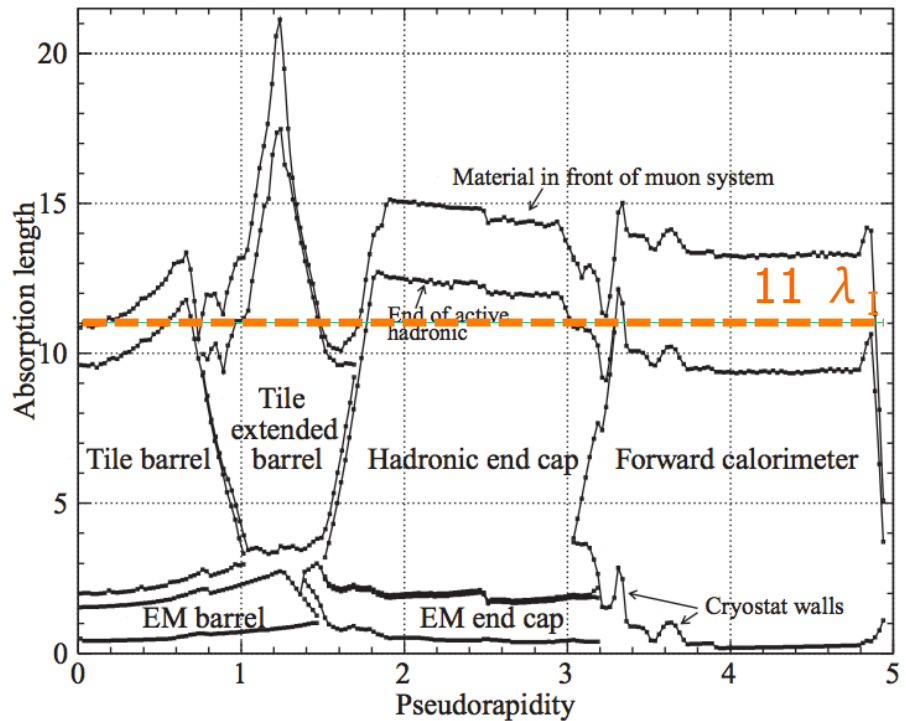

- CMS

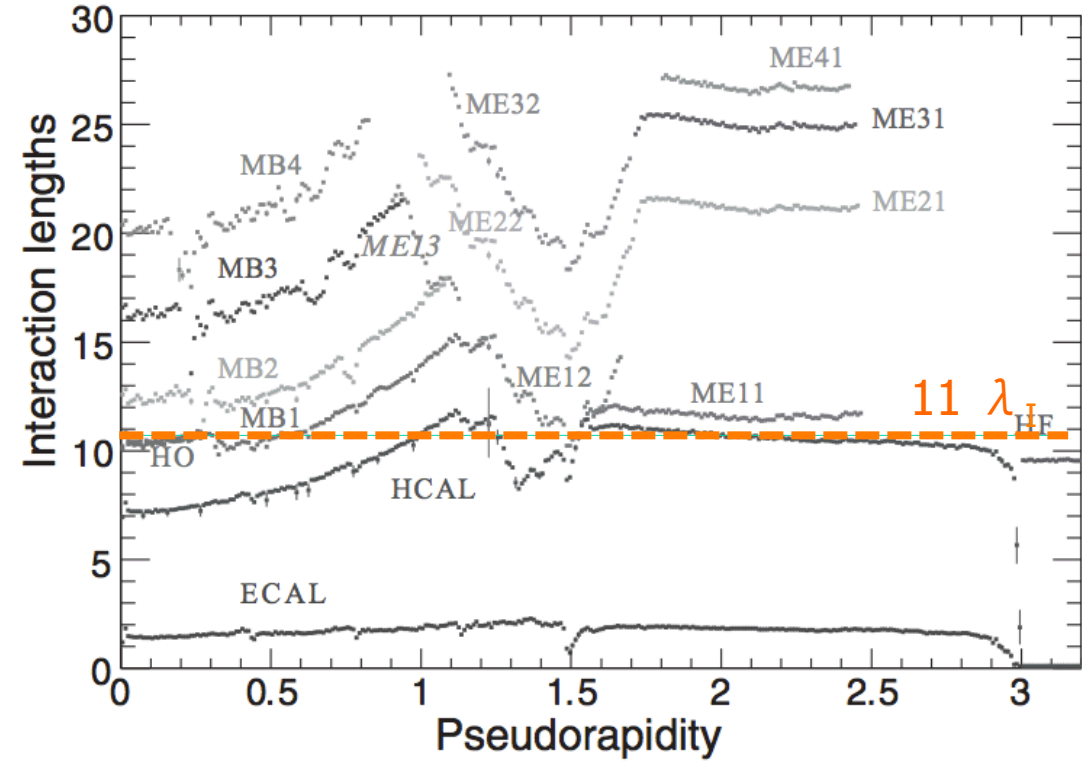

Performance of calorimeters: jets

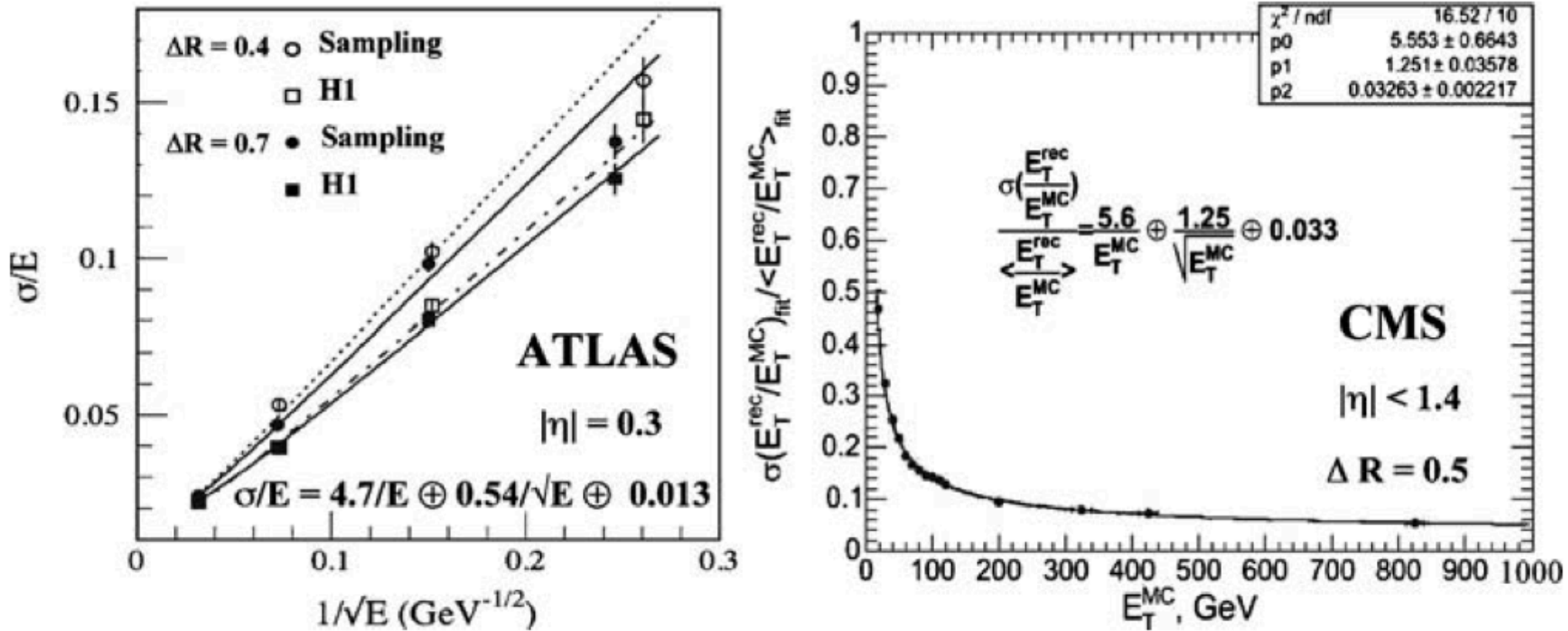

Figure 20 For ATLAS (*left*) and CMS (*right*), expected relative precision on the measurement of the energy of QCD jets reconstructed in the central region as a function of $1/\sqrt{E}$, where E is the jet energy for ATLAS, and as a function of E_T^{MC} , where E_T^{MC} is the jet transverse energy for CMS.

Performance of calorimeters: MET

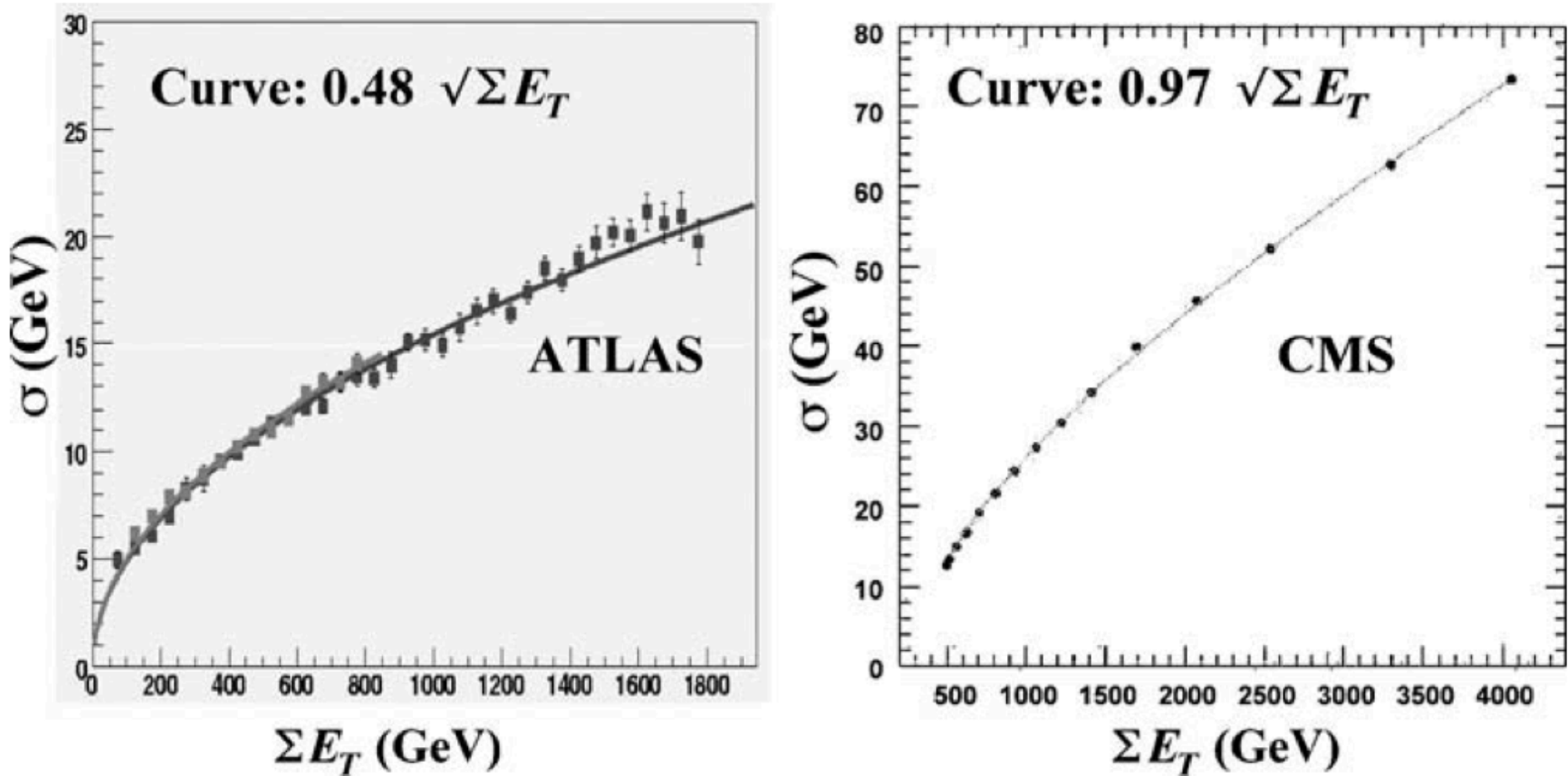

Figure 21 For ATLAS (*left*) and CMS (*right*), expected precision on the measurement of the missing transverse energy as a function of the total transverse energy, ΣE_T , measured in the event.

A wide-angle, fisheye photograph of a large particle detector, likely a muon spectrometer, inside a tunnel. The detector is composed of numerous layers of sensitive components, including calorimeters and tracking chambers, arranged in a cylindrical or barrel-like structure. The interior is densely packed with blue and red cables, and various electronic modules are visible. A central yellow platform with blue structural supports is positioned in the foreground. In the background, a person can be seen working on the detector. The overall scene is brightly lit, highlighting the intricate details of the experimental setup.

Muon spectrometers

Muon spectrometers

- ATLAS

- ✓ independent muon spectrometer with excellent stand-alone capabilities

- CMS

- ✓ superior combined momentum resolution in the central region;
- ✓ limited stand-alone resolution and trigger capabilities
 - multiple scattering in the iron

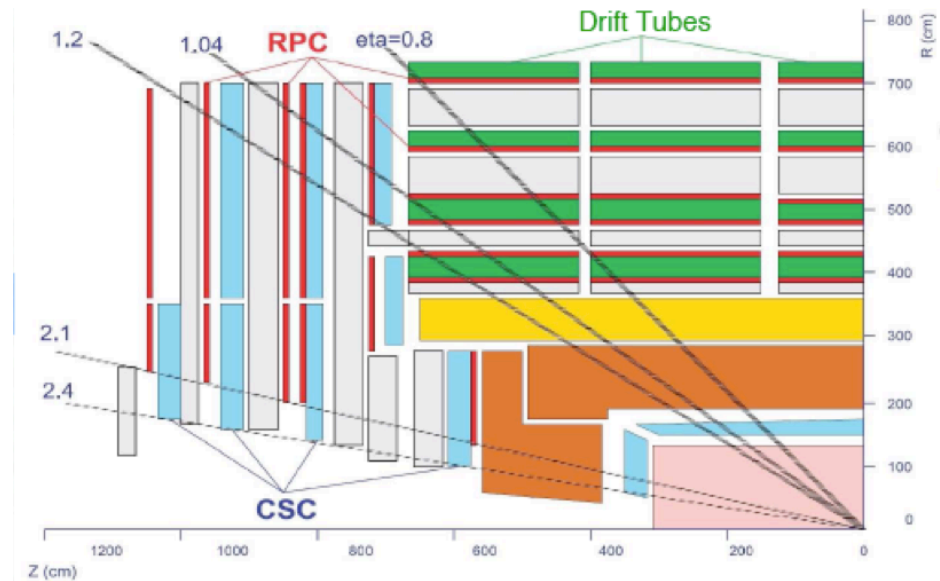
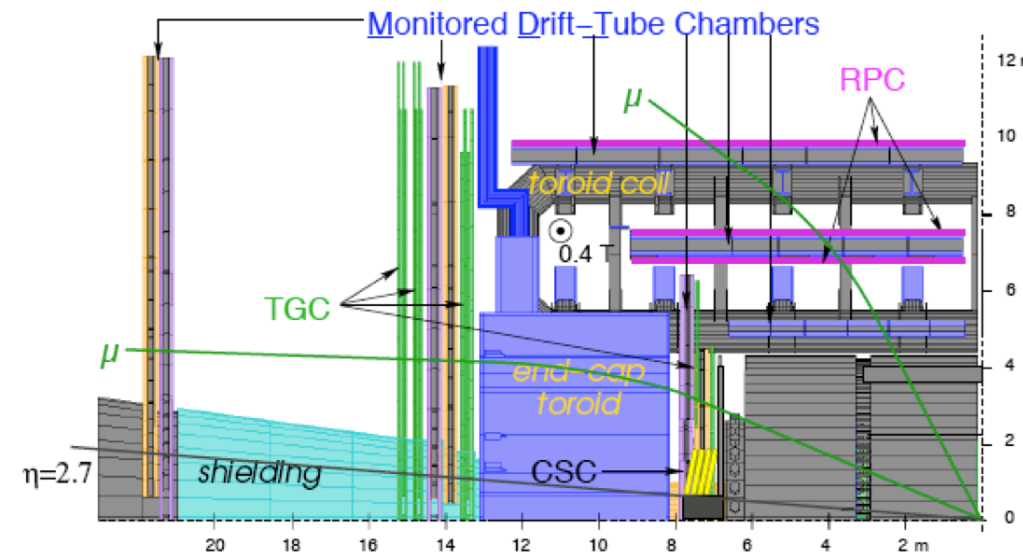

Muon spectrometers

TABLE 11 Main parameters of the ATLAS and CMS muon chambers

	ATLAS	CMS
Drift Tubes	MDTs	DTs
-Coverage	$ \eta < 2.0$	$ \eta < 1.2$
-Number of chambers	1170	250
-Number of channels	354,000	172,000
-Function	Precision measurement	Precision measurement, triggering
Cathode Strip Chambers		
-Coverage	$2.0 < \eta < 2.7$	$1.2 < \eta < 2.4$
-Number of chambers	32	468
-Number of channels	31,000	500,000
-Function	Precision measurement	Precision measurement, triggering
Resistive Plate Chambers		
-Coverage	$ \eta < 1.05$	$ \eta < 2.1$
-Number of chambers	1112	912
-Number of channels	374,000	160,000
-Function	Triggering, second coordinate	Triggering
Thin Gap Chambers		
-Coverage	$1.05 < \eta < 2.4$	—
-Number of chambers	1578	—
-Number of channels	322,000	—
-Function	Triggering, second coordinate	—

Muon spectrometers

TABLE 12 Main parameters of the ATLAS and CMS muon measurement systems as well as a summary of the expected combined and stand-alone performance at two typical pseudorapidity values (averaged over azimuth)

Parameter	ATLAS	CMS
Pseudorapidity coverage		
-Muons measurement	$ \eta < 2.7$	$ \eta < 2.4$
-Triggering	$ \eta < 2.4$	$ \eta < 2.1$
Dimensions (m)		
-Innermost (outermost) radius	5.0 (10.0)	3.9 (7.0)
-Innermost (outermost) disk (z-point)	7.0 (21–23)	6.0–7.0 (9–10)
Segments/superpoints per track for barrel (end caps)	3 (4)	4 (3–4)
Magnetic field B (T)	0.5	2
-Bending power (BL, in T·m) at $ \eta \approx 0$	3	16
-Bending power (BL, in T·m) at $ \eta \approx 2.5$	8	6
Combined (stand-alone) momentum resolution at		
- $p = 10$ GeV and $\eta \approx 0$	1.4% (3.9%)	0.8% (8%)
- $p = 10$ GeV and $\eta \approx 2$	2.4% (6.4%)	2.0% (11%)
- $p = 100$ GeV and $\eta \approx 0$	2.6% (3.1%)	1.2% (9%)
- $p = 100$ GeV and $\eta \approx 2$	2.1% (3.1%)	1.7% (18%)
- $p = 1000$ GeV and $\eta \approx 0$	10.4% (10.5%)	4.5% (13%)
- $p = 1000$ GeV and $\eta \approx 2$	4.4% (4.6%)	7.0% (35%)



what
would
you
choose?

S
 \sqrt{B}



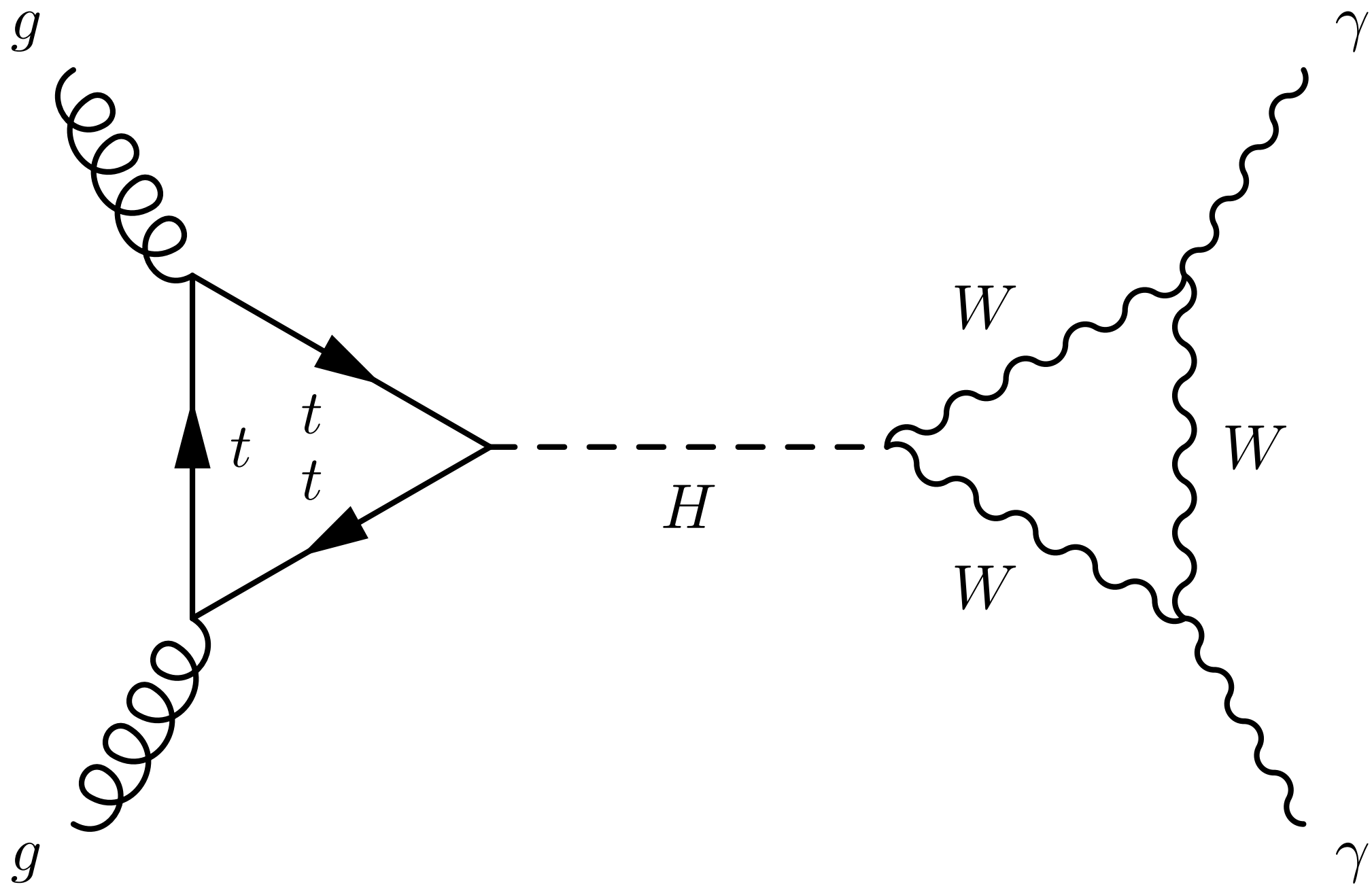

A narrow mass peak...

$$m_{\gamma\gamma} = \sqrt{E_1^\gamma E_2^\gamma (1 - \cos \alpha_{12})}$$

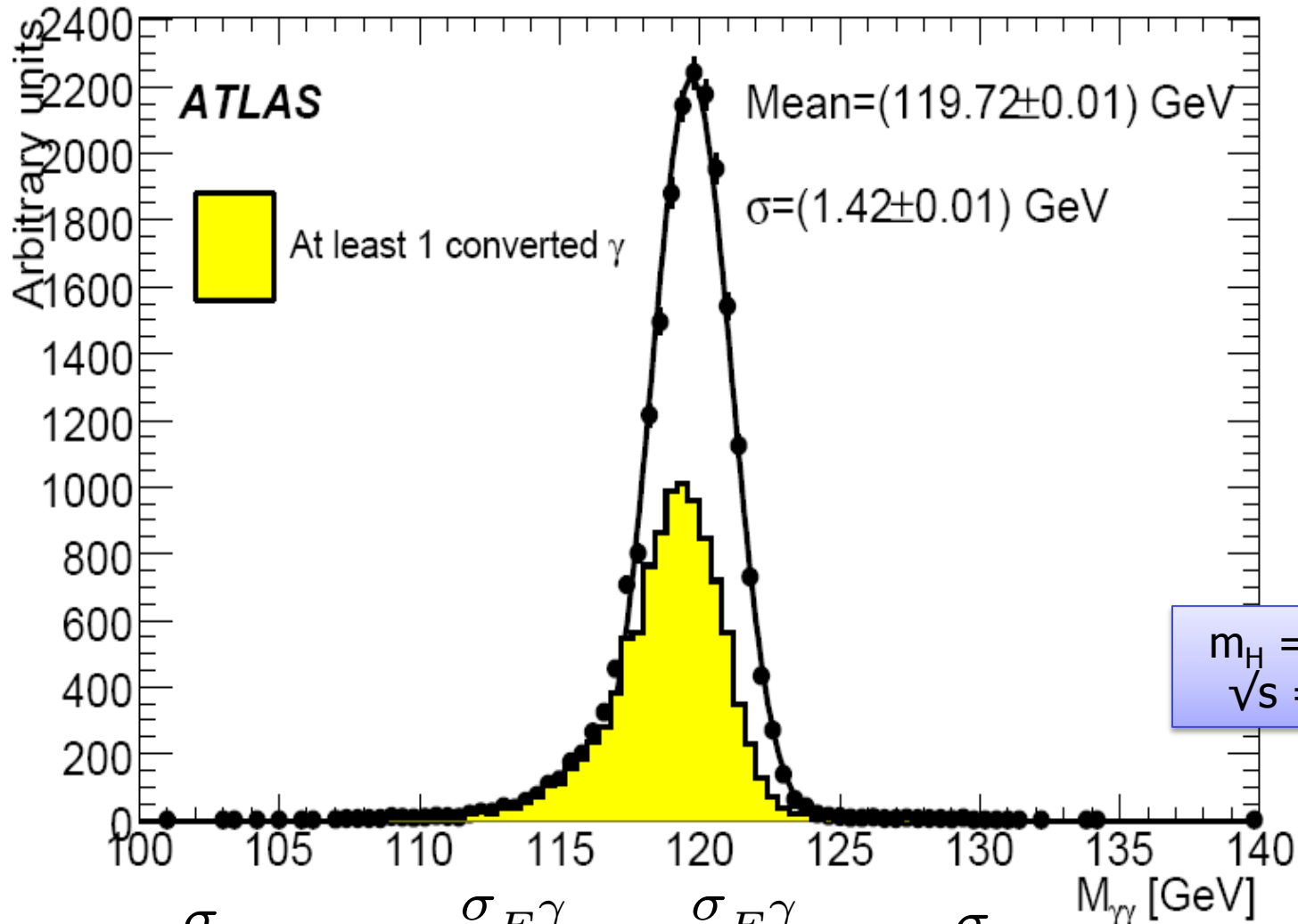

$$\frac{\sigma_{m_{\gamma\gamma}}}{m_{\gamma\gamma}} = \frac{\sigma_{E_1^\gamma}}{E_1^\gamma} \oplus \frac{\sigma_{E_2^\gamma}}{E_2^\gamma} \oplus \frac{\sigma_{\alpha_{12}}}{\tan \alpha_{12}}$$

... on a large background!

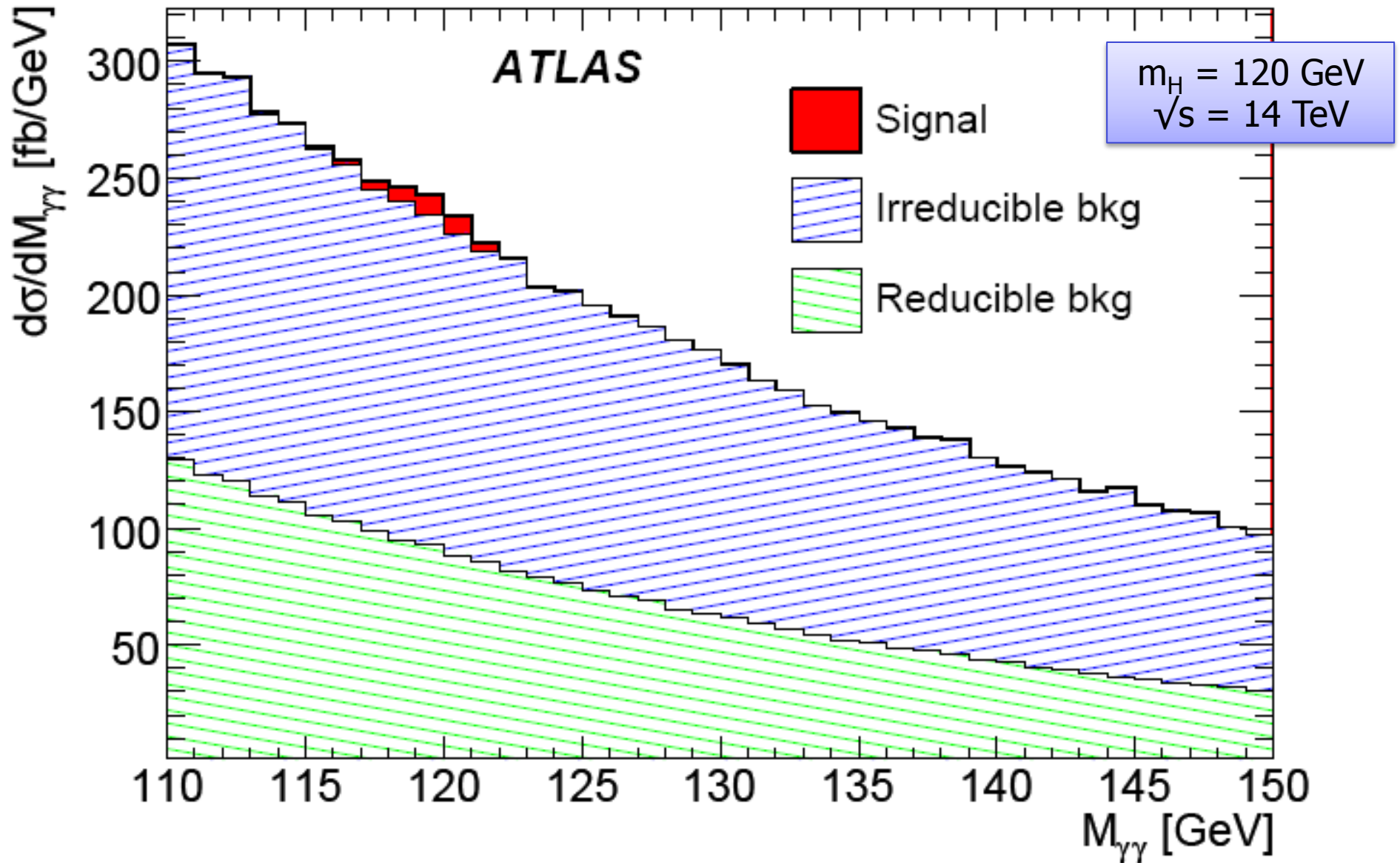

“Irreducible” background

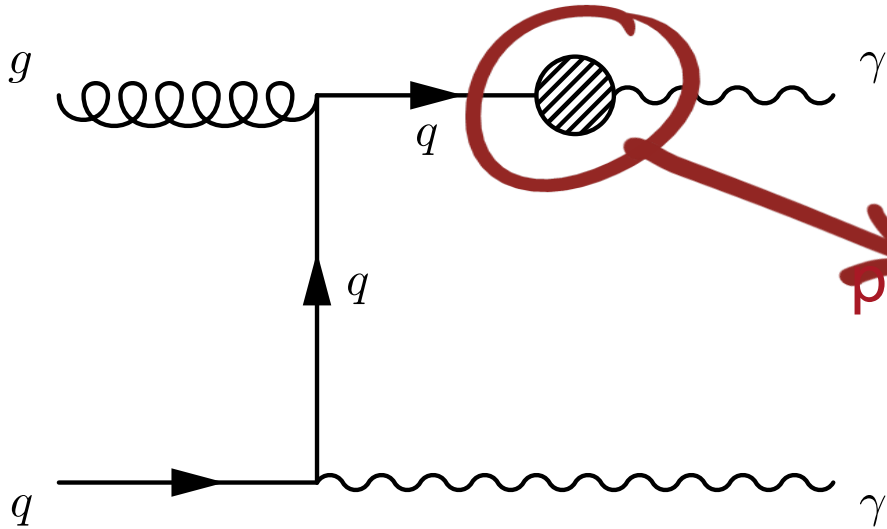
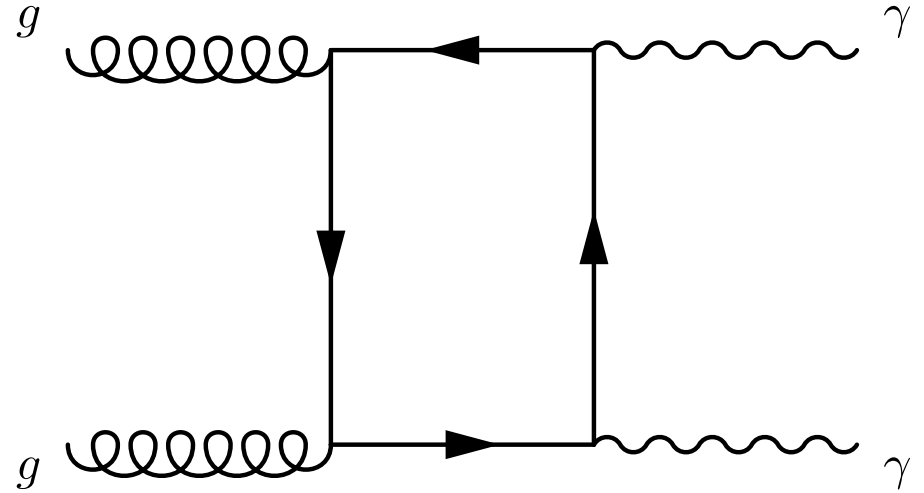
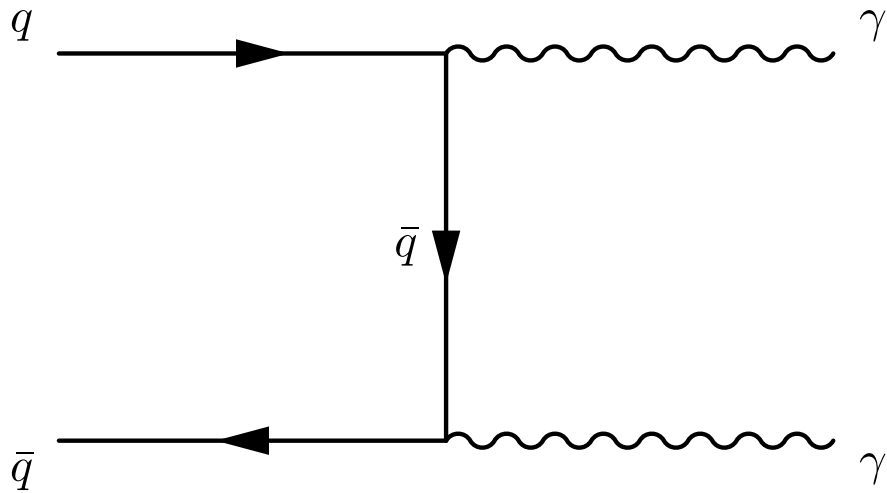

parton fragmentation

“Reducible” background

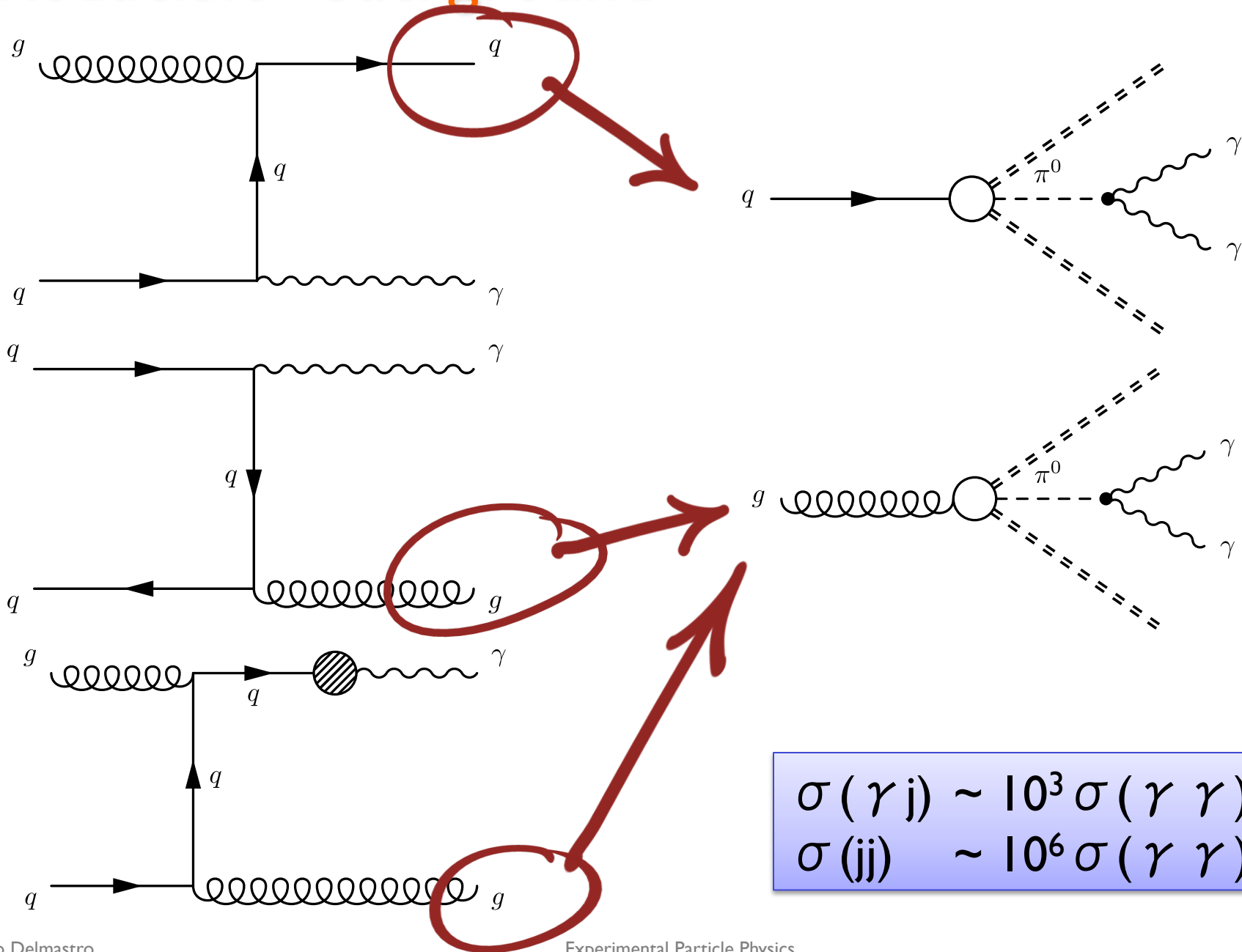

$$\sigma(\gamma j) \sim 10^3 \sigma(\gamma \gamma)$$

$$\sigma(jj) \sim 10^6 \sigma(\gamma \gamma)$$

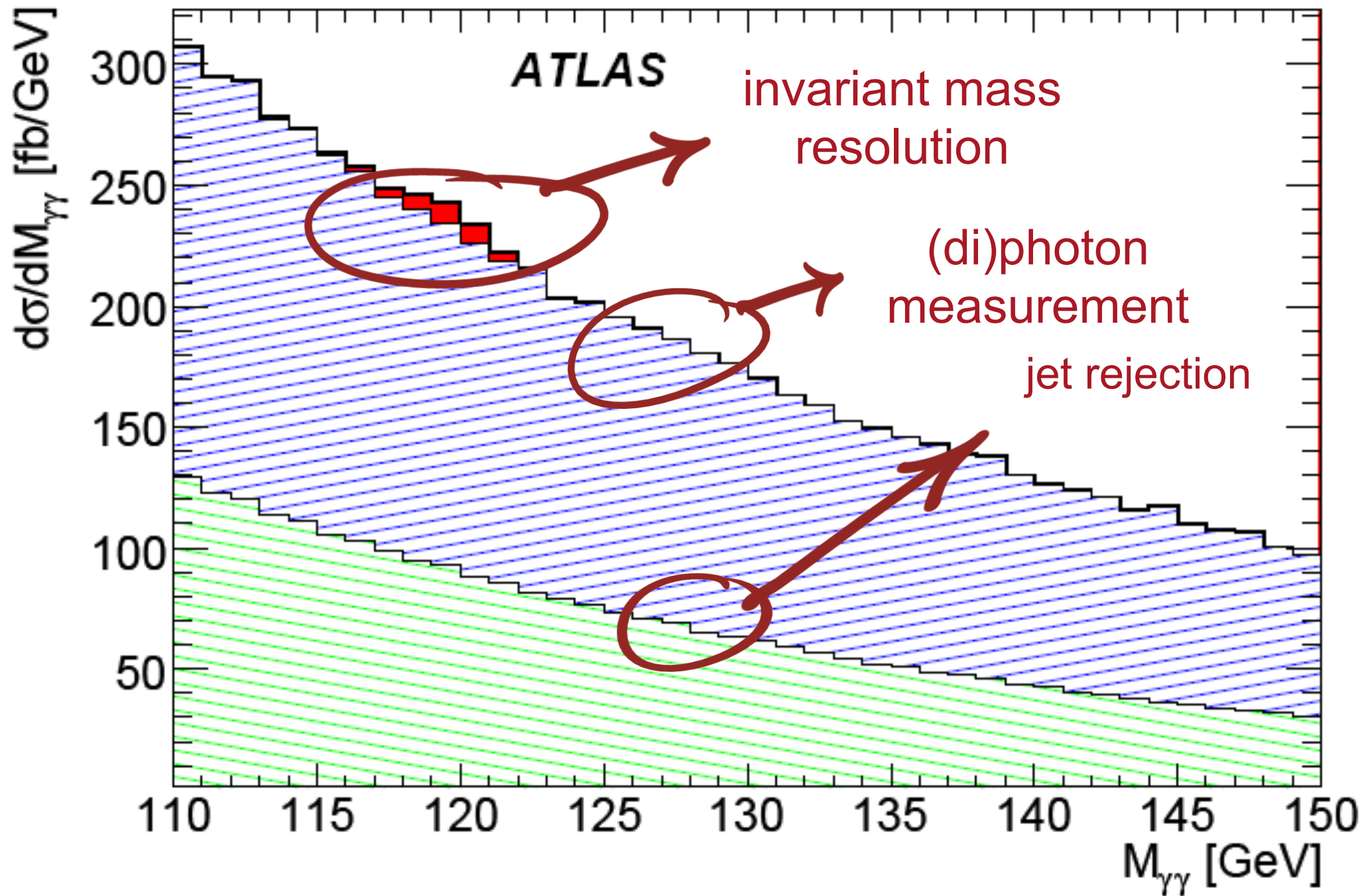

H → γγ: ATLAS vs. CMS

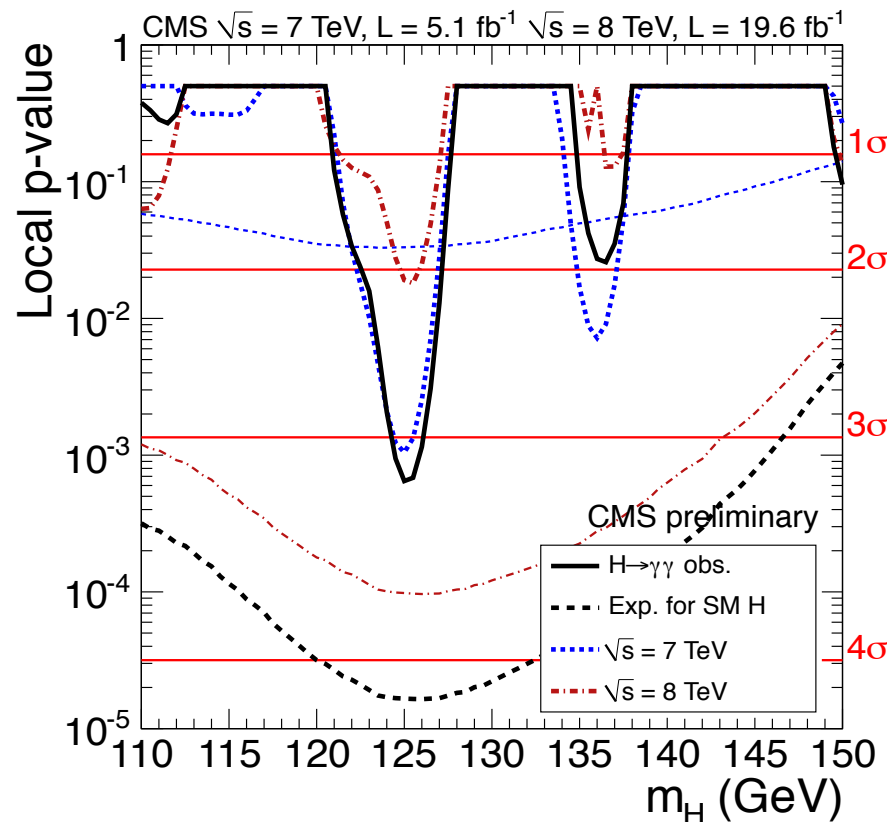
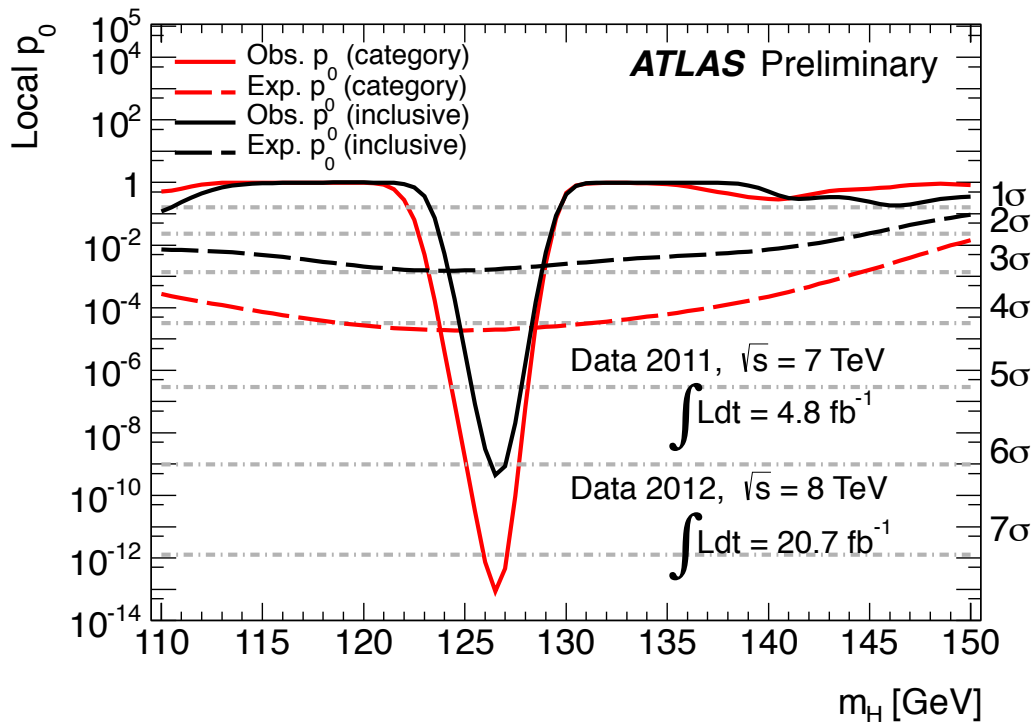

- Significance at $m_H = 126.5$ GeV: **7.4 σ** (expected 4.1)

Significance @ 125.0 GeV: 3.2 σ (4.2 exp.)

With additional data and new analysis: significance decreased compared to the published results

Mass resolution

ATLAS

- Overall mass resolution very stable with time and pile-up

✓ ~1.7 GeV

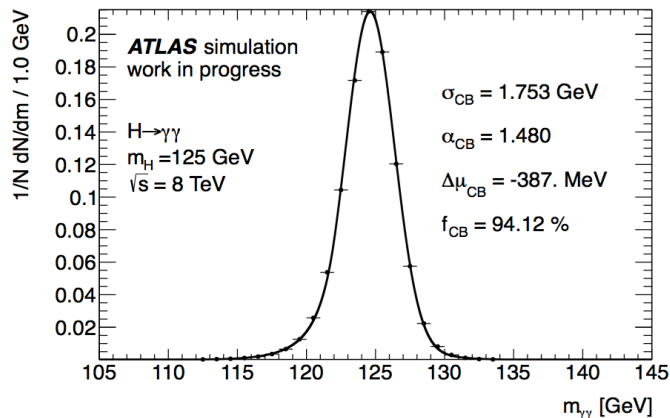

CMS

- Change of crystal calibration from ICHEP 2012 to Moriond/Aspen 2013, claim additional improvement

ICHEP

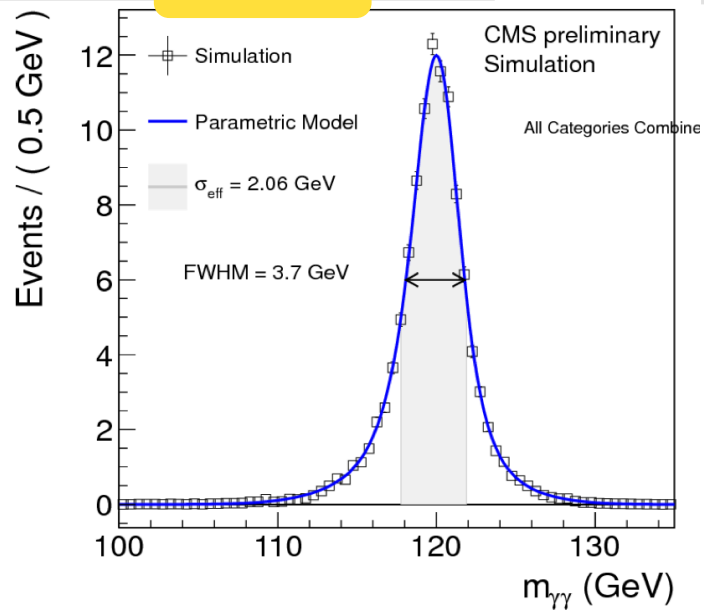

Moriond/Aspen

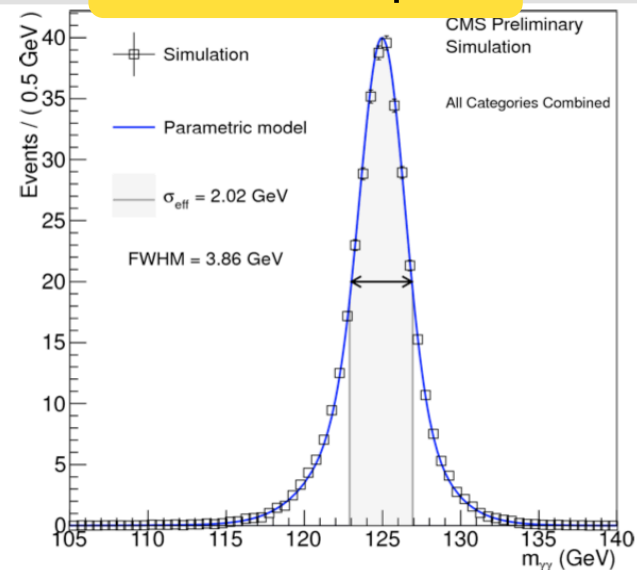

H \rightarrow $\gamma\gamma$ weighted mass spectra

