

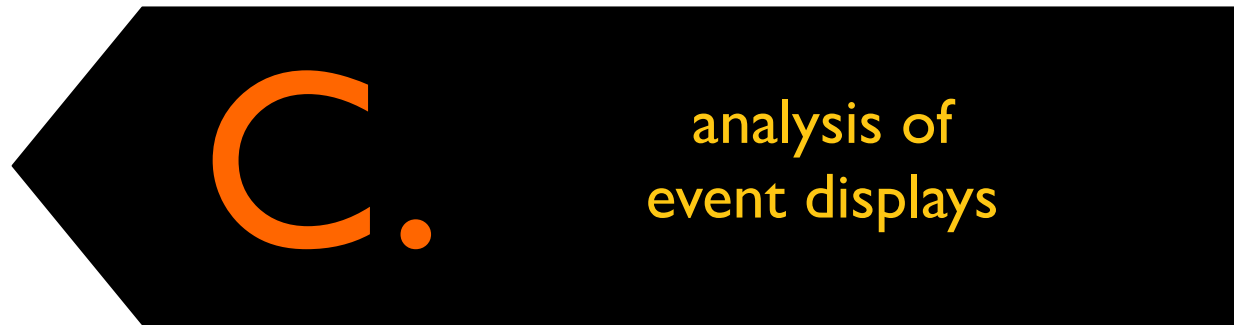

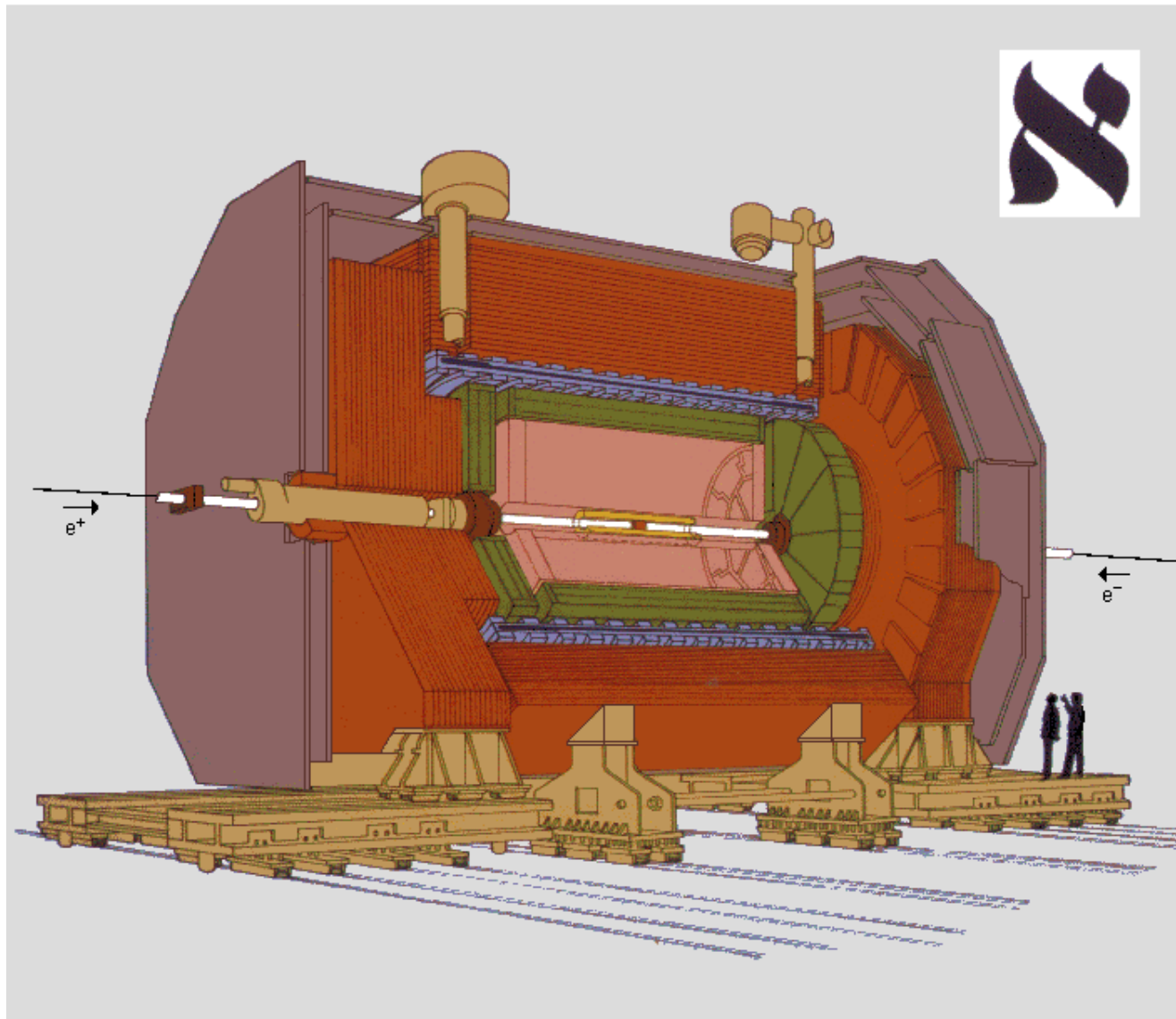





Experimental particle. physics

esipap...
European School of Instrumentation
in Particle & Astroparticle Physics





-  Vertex Detector
-  Inner Tracking Chamber
-  Time Projection Chamber
-  Electromagnetic Calorimeter
-  Superconducting Magnet Coil
-  Hadron Calorimeter
-  Muon Chambers
-  Luminosity Monitors

The ALEPH Detector

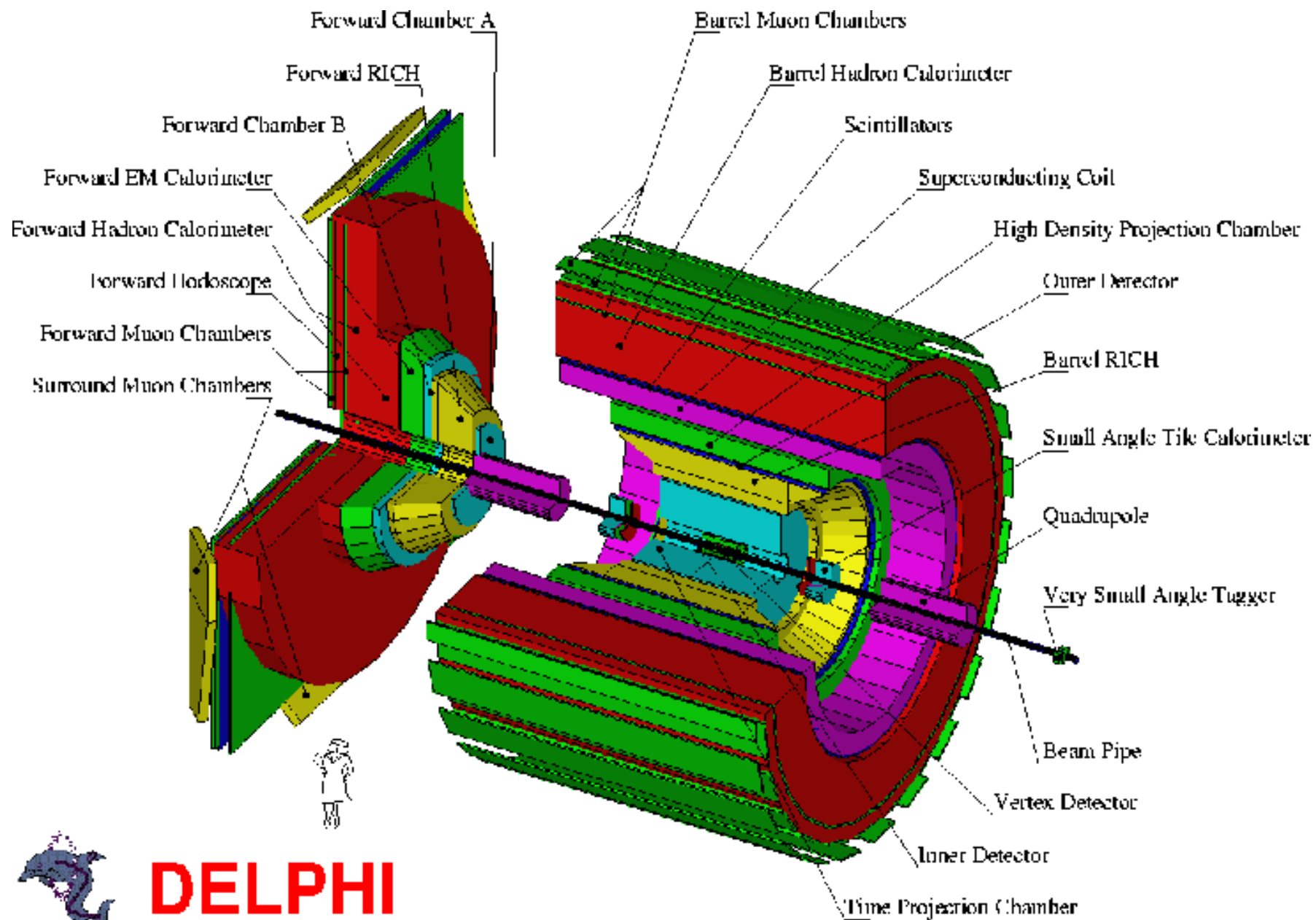

DELPHI

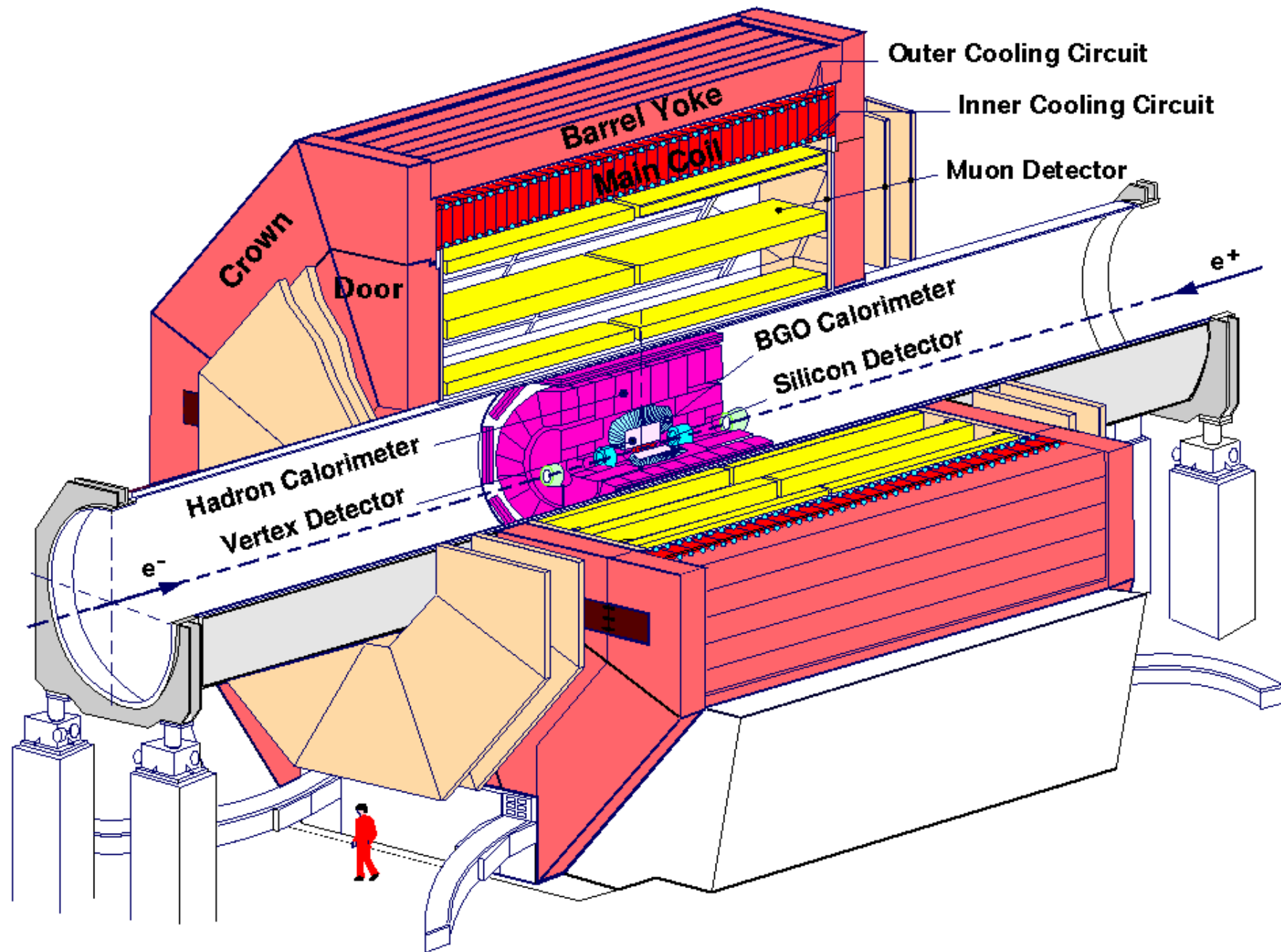

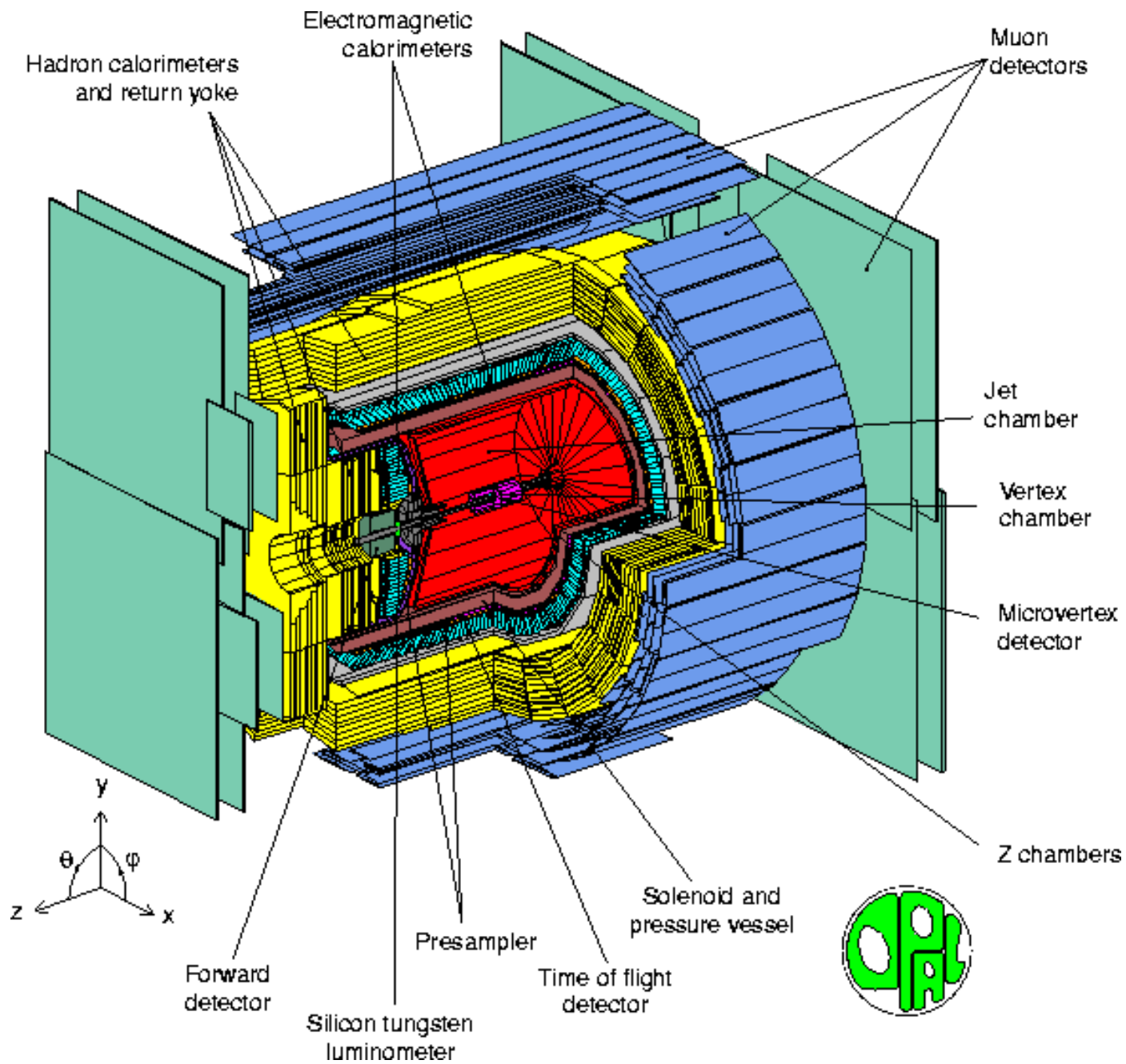

Event display game

- (A) $Z \rightarrow e^+ e^-$
- (B) $Z \rightarrow \mu^+ \mu^-$
- (C) $Z \rightarrow \tau^+ \tau^-$
- (D) $Z \rightarrow q \bar{q}$
- (E) $Z \rightarrow q \bar{q} g$
- (F) $ZZ \rightarrow e^+ e^- \mu^+ \mu^-$
- (G) $ZZ \rightarrow e^+ e^- q \bar{q}$
- (I) $WW \rightarrow e \nu \mu \nu$
- (L) $WW \rightarrow \mu \nu \mu \nu$
- (M) $WW \rightarrow \tau \nu \tau \nu$
- (N) $WW \rightarrow \tau \nu \mu \nu$
- (O) $WW \rightarrow e \nu q \bar{q}$
- (P) $WW \rightarrow \mu \nu q \bar{q}$
- (Q) $WW \rightarrow \tau \nu q \bar{q}$
- (R) $WW \rightarrow q \bar{q} q \bar{q}$

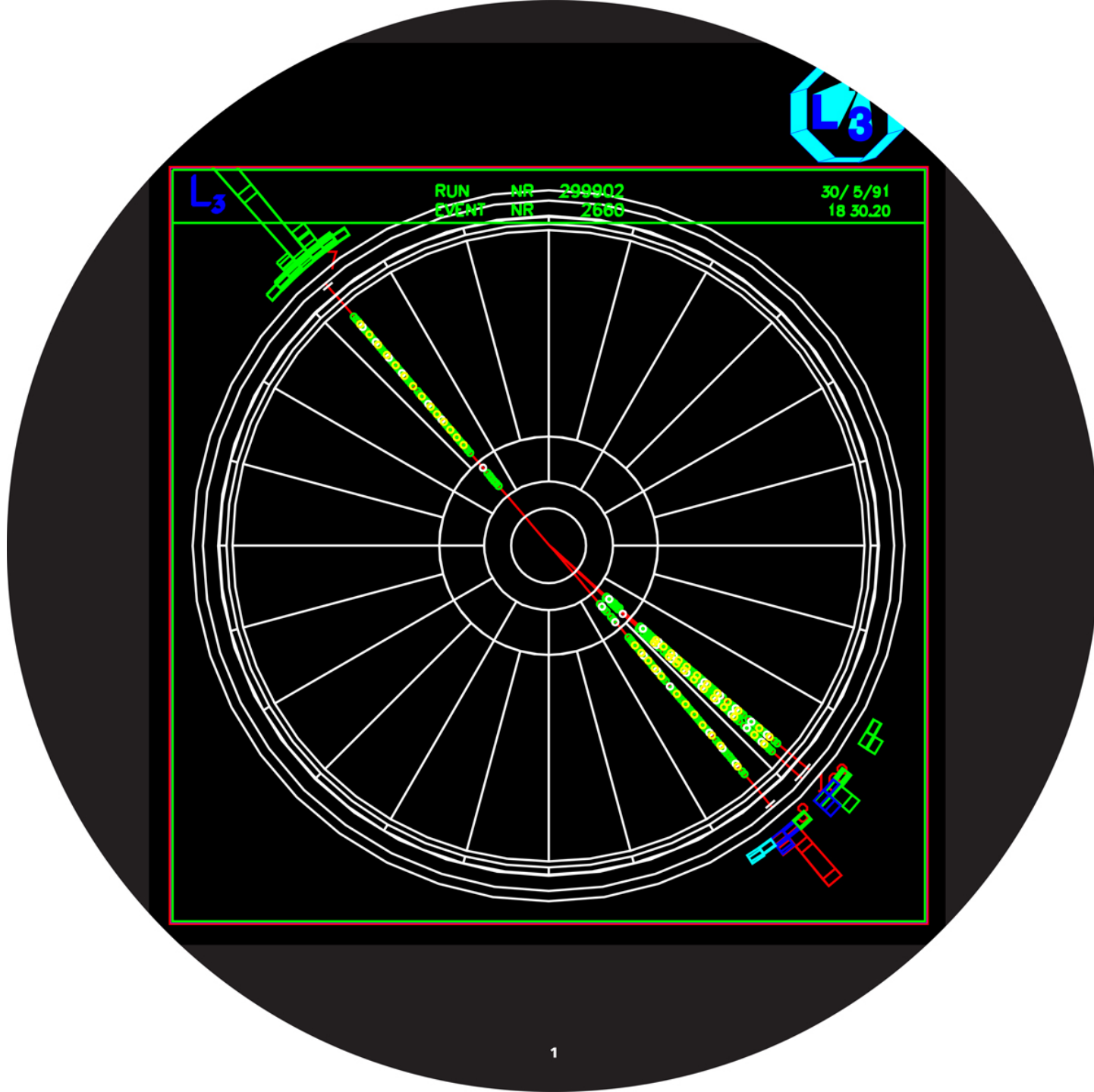

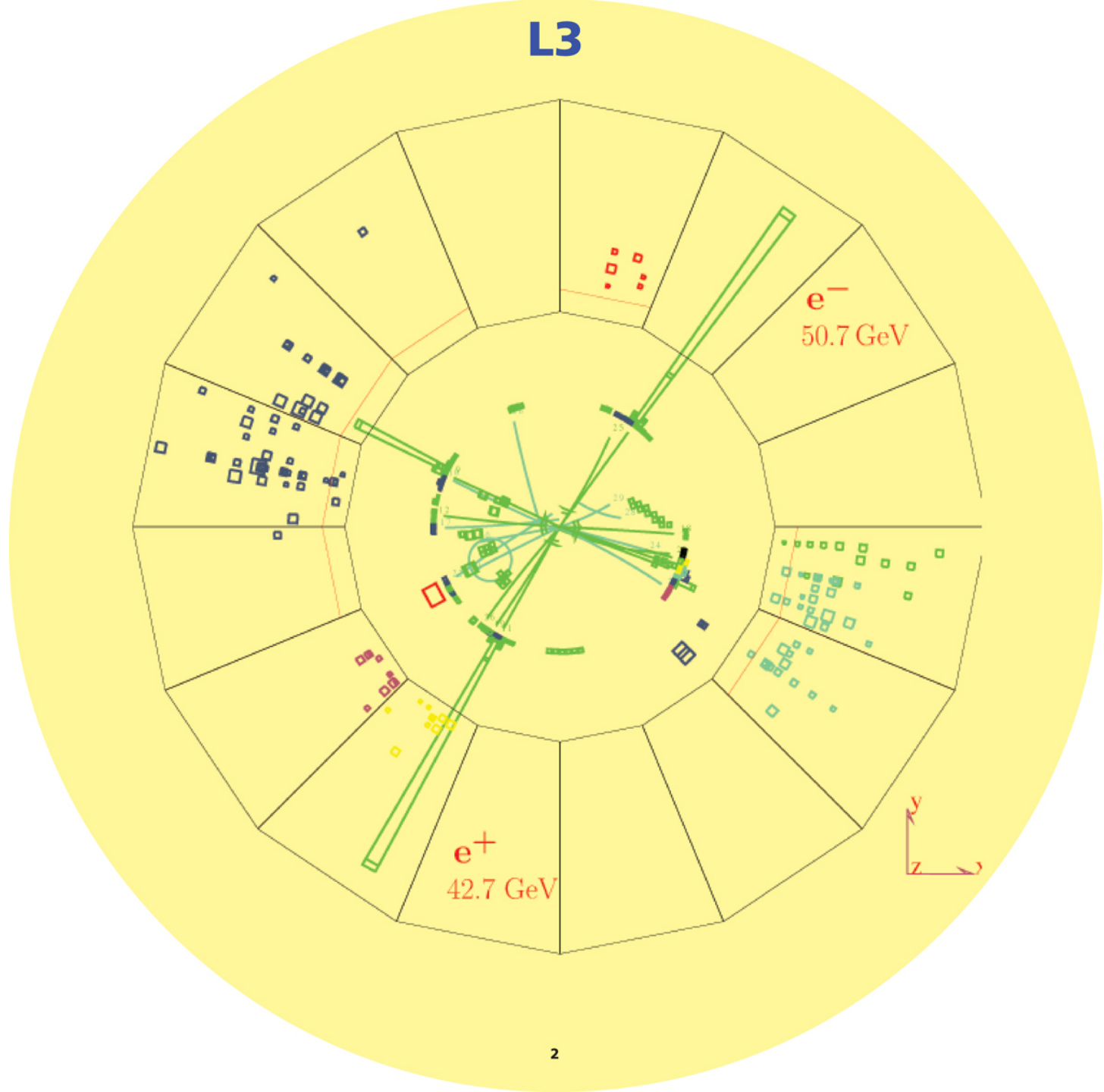

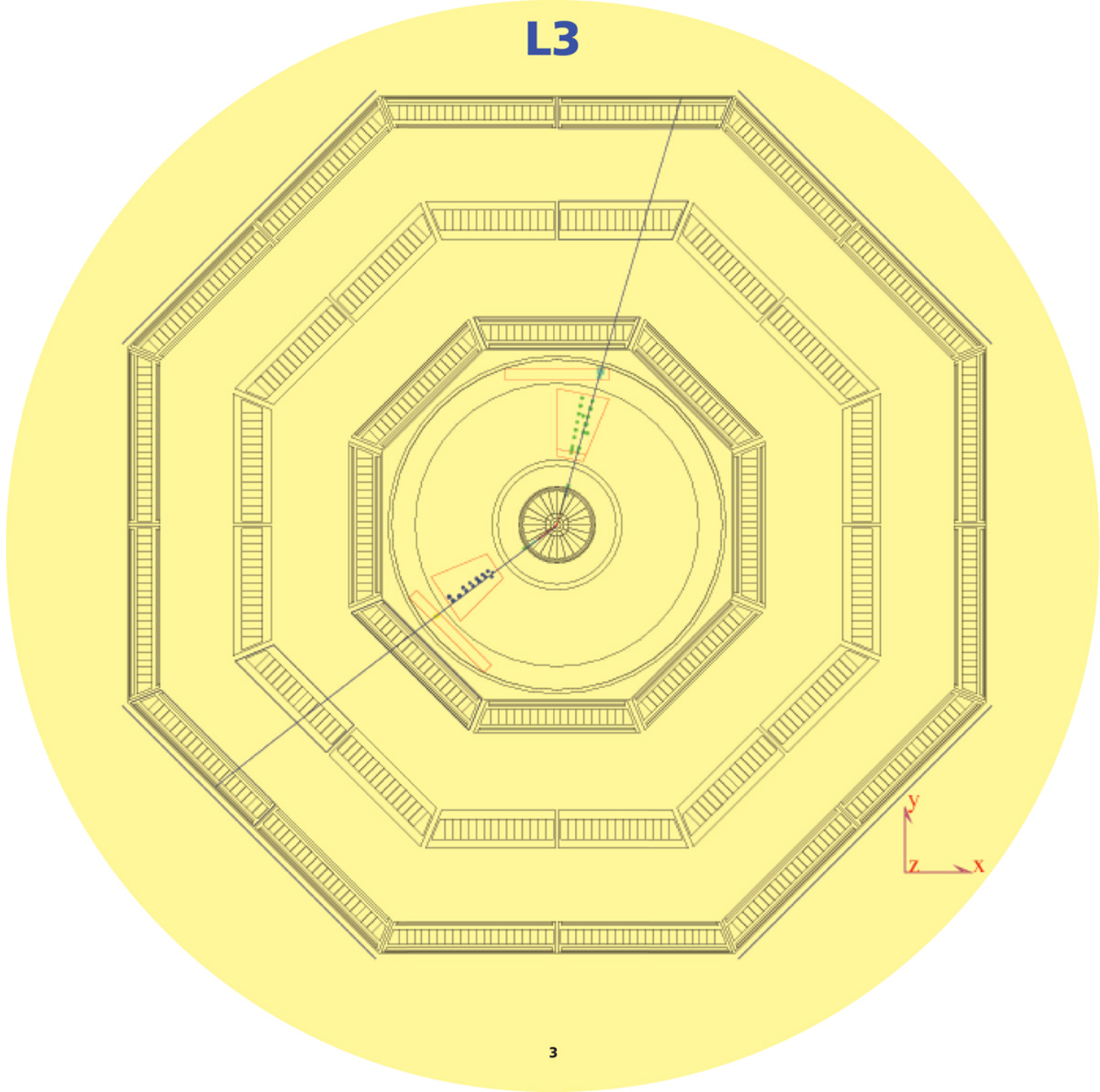

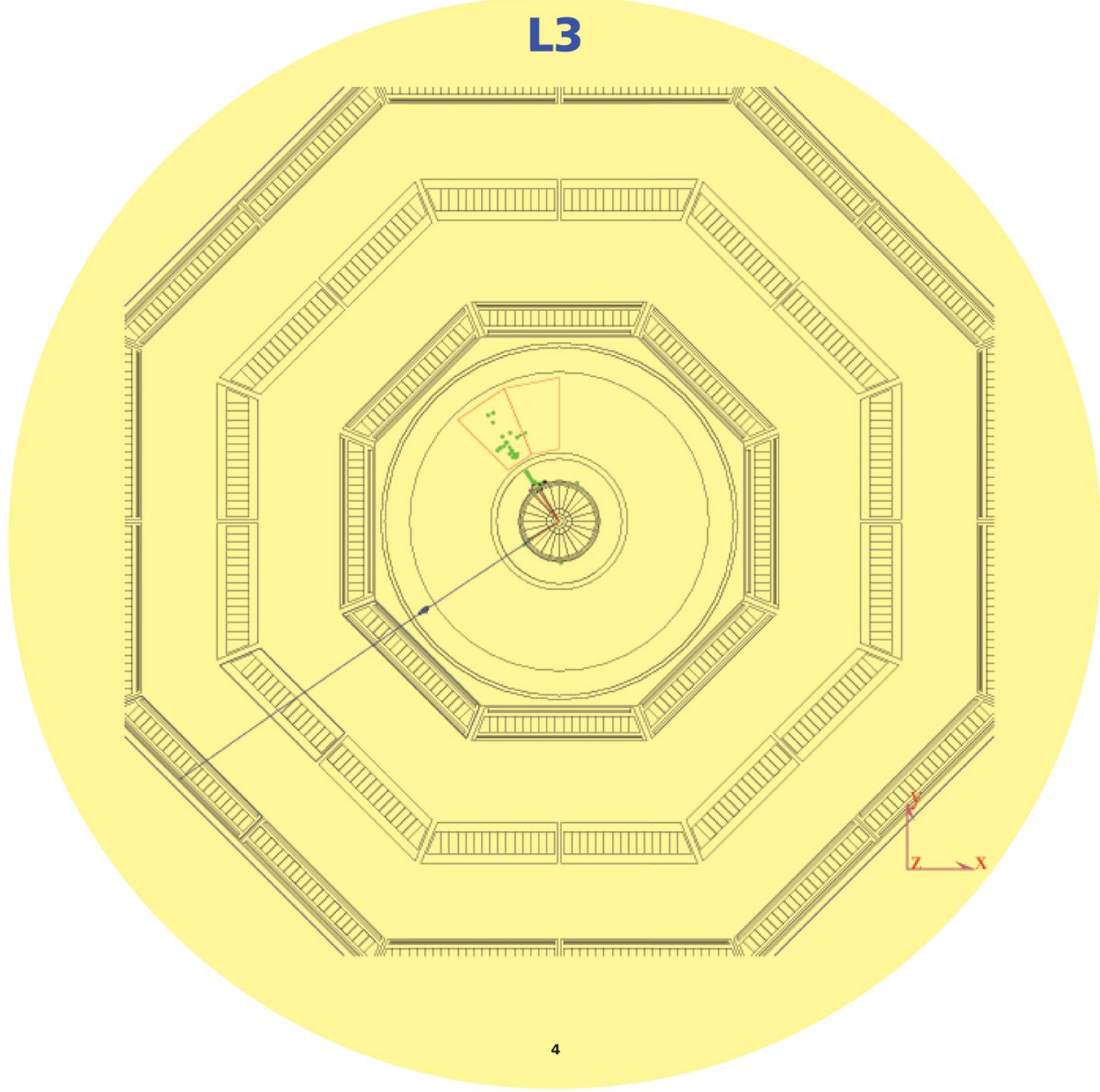

ALEPH

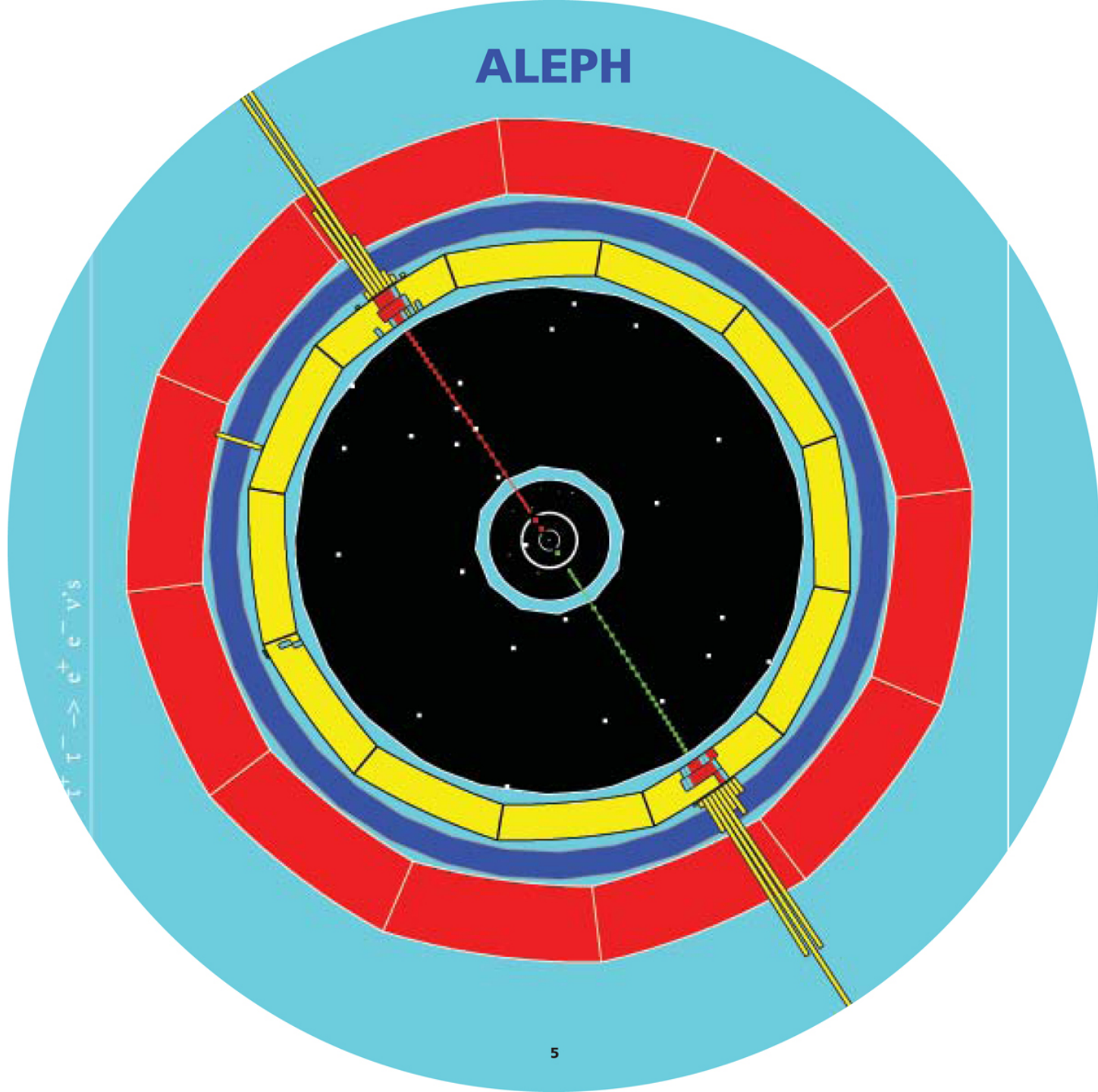

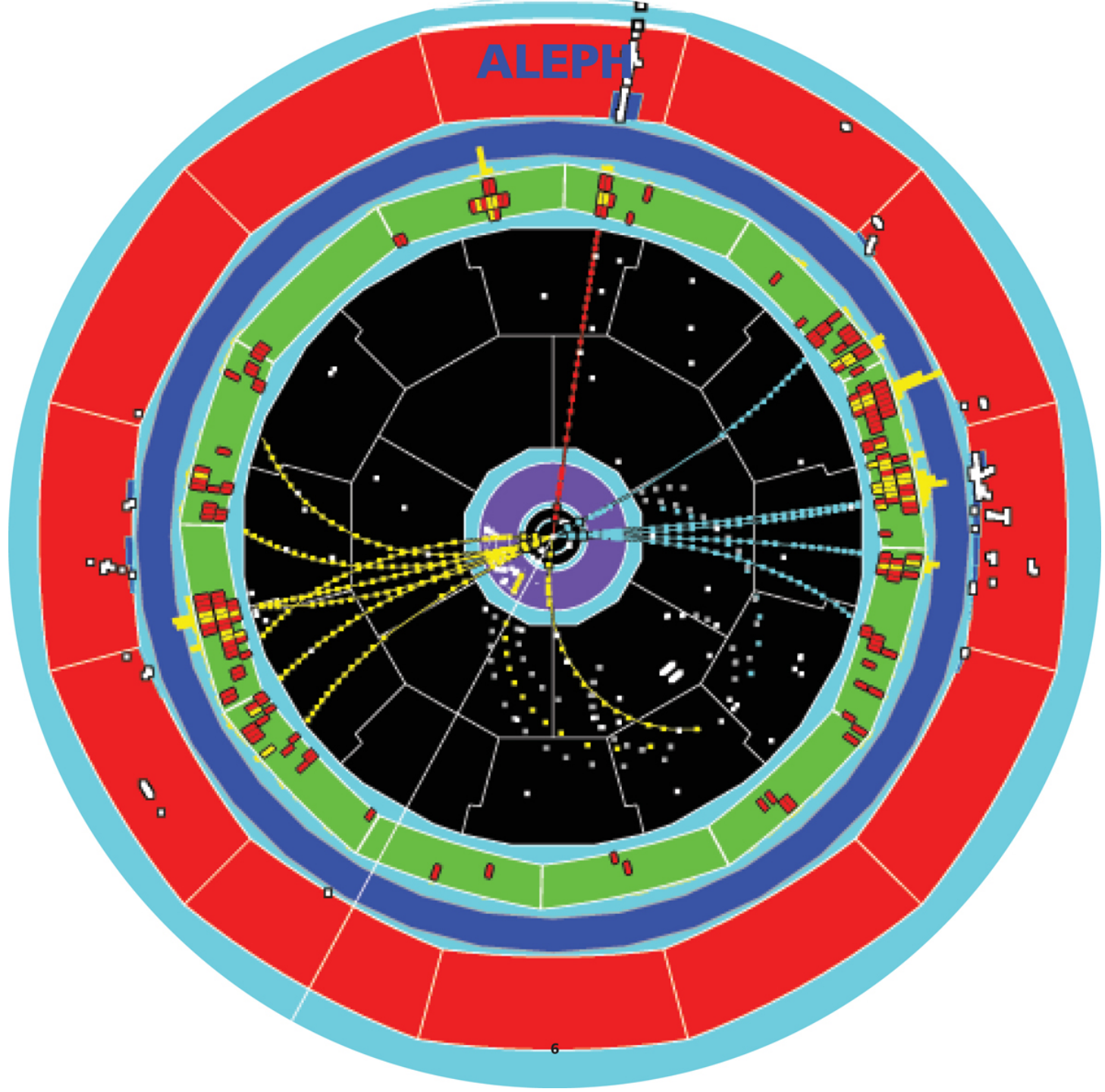

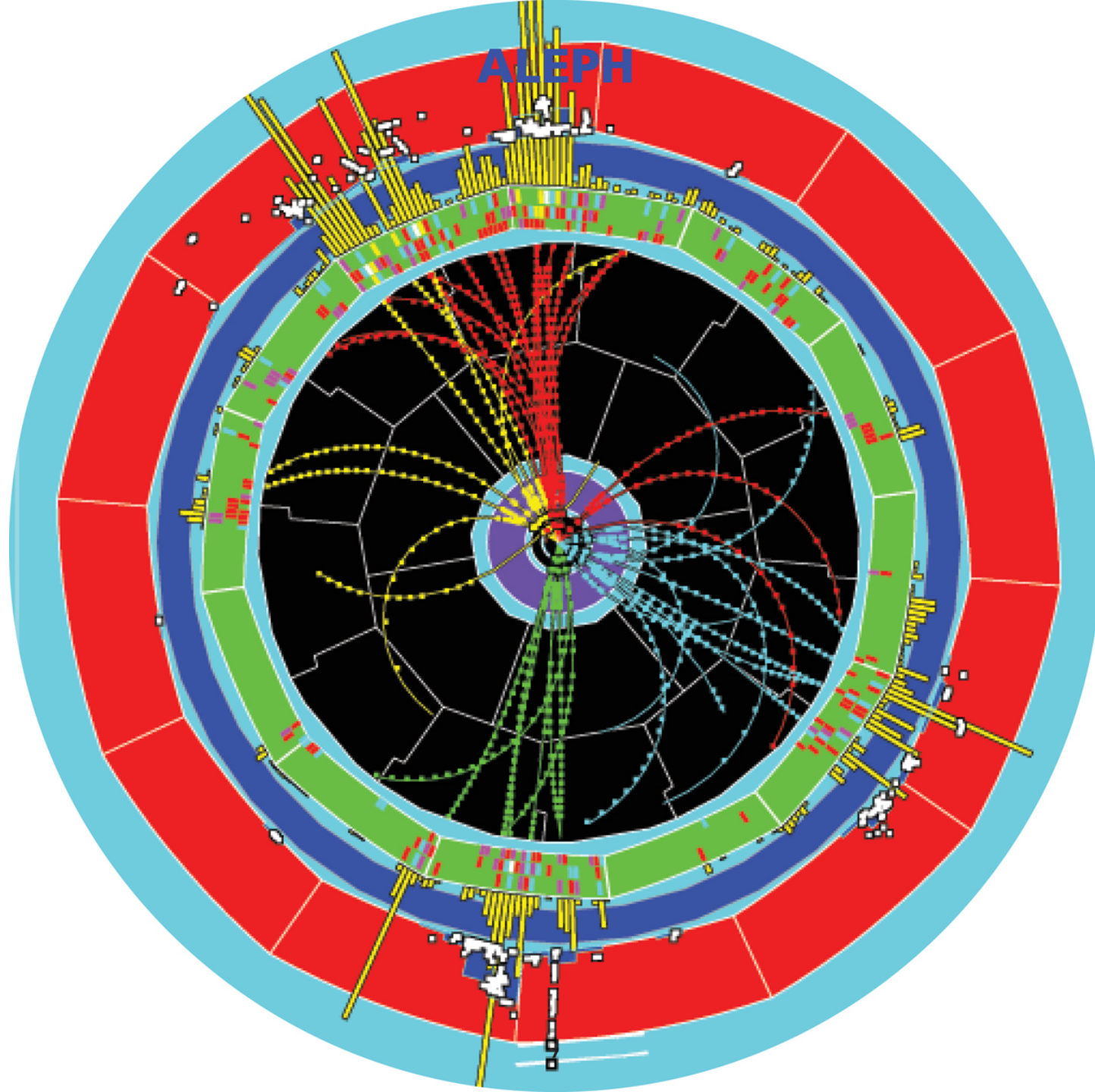

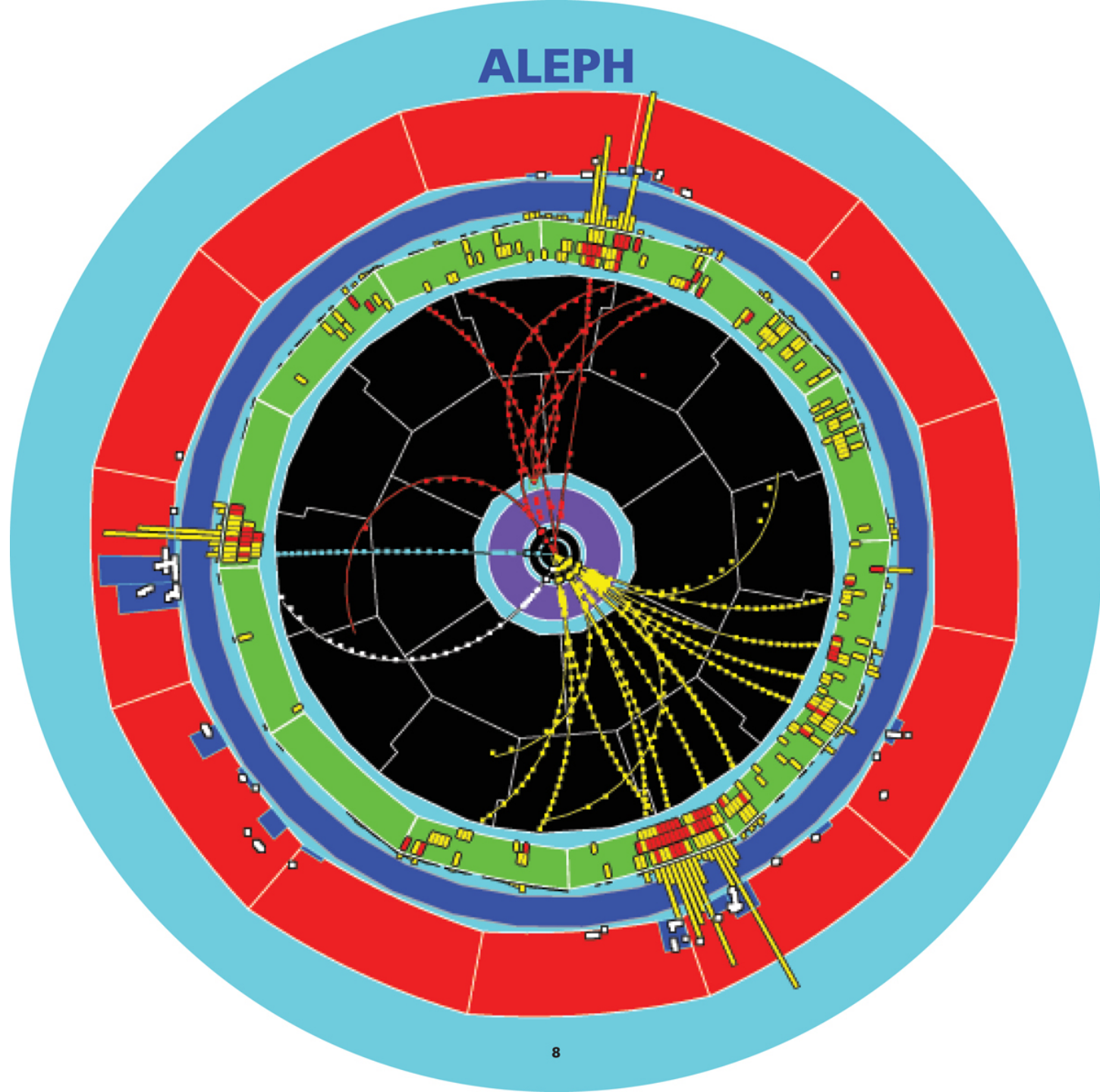

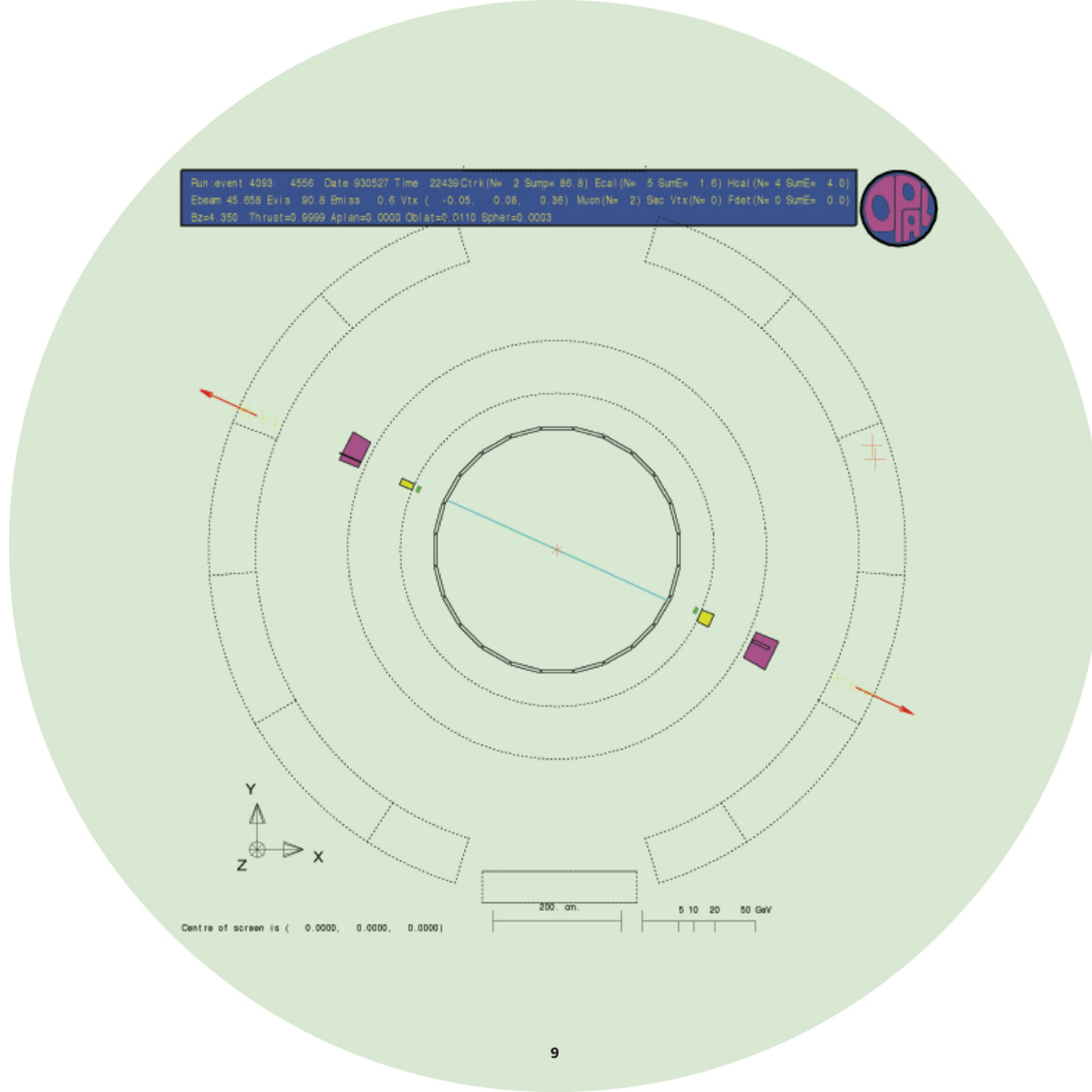

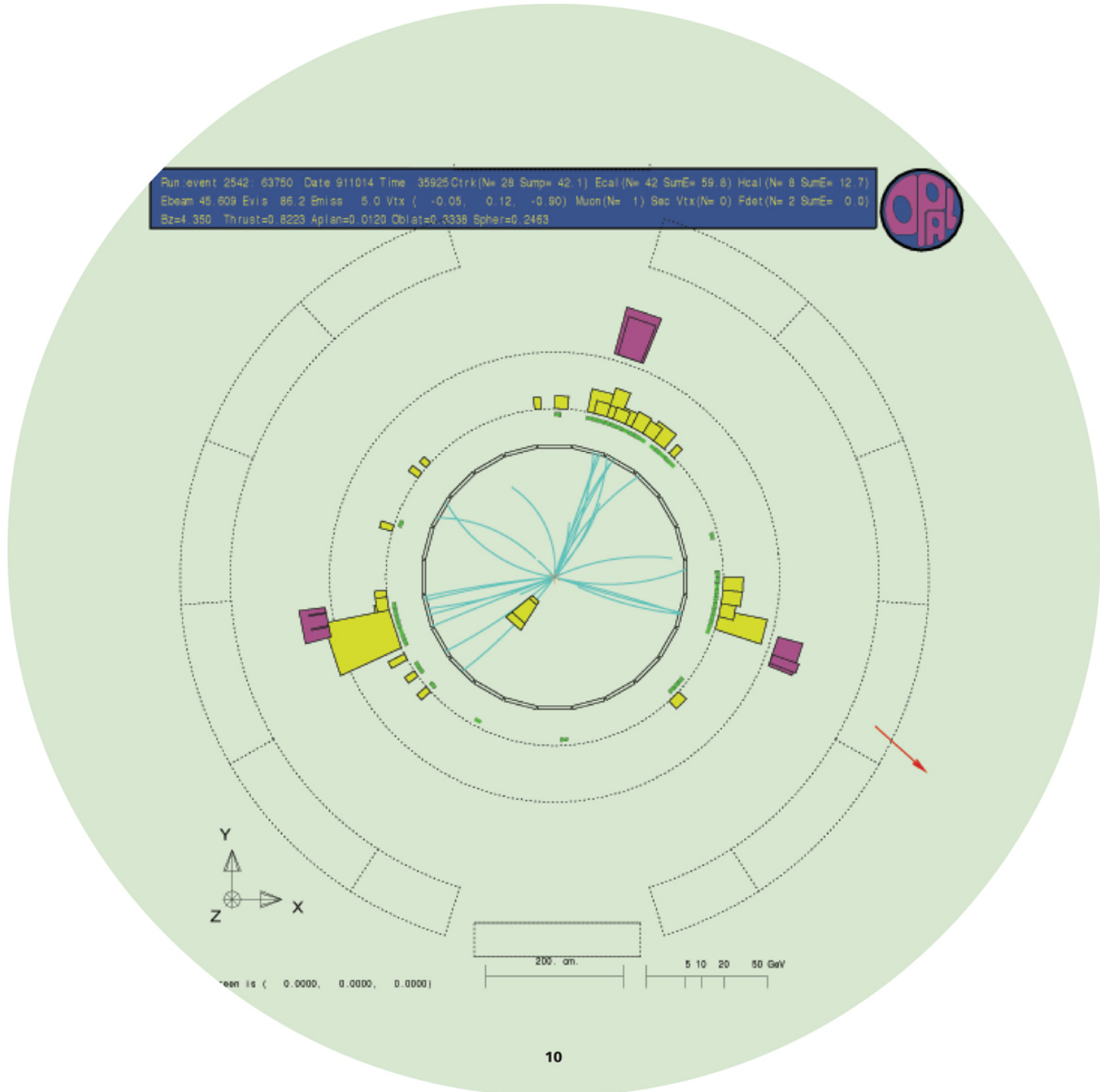

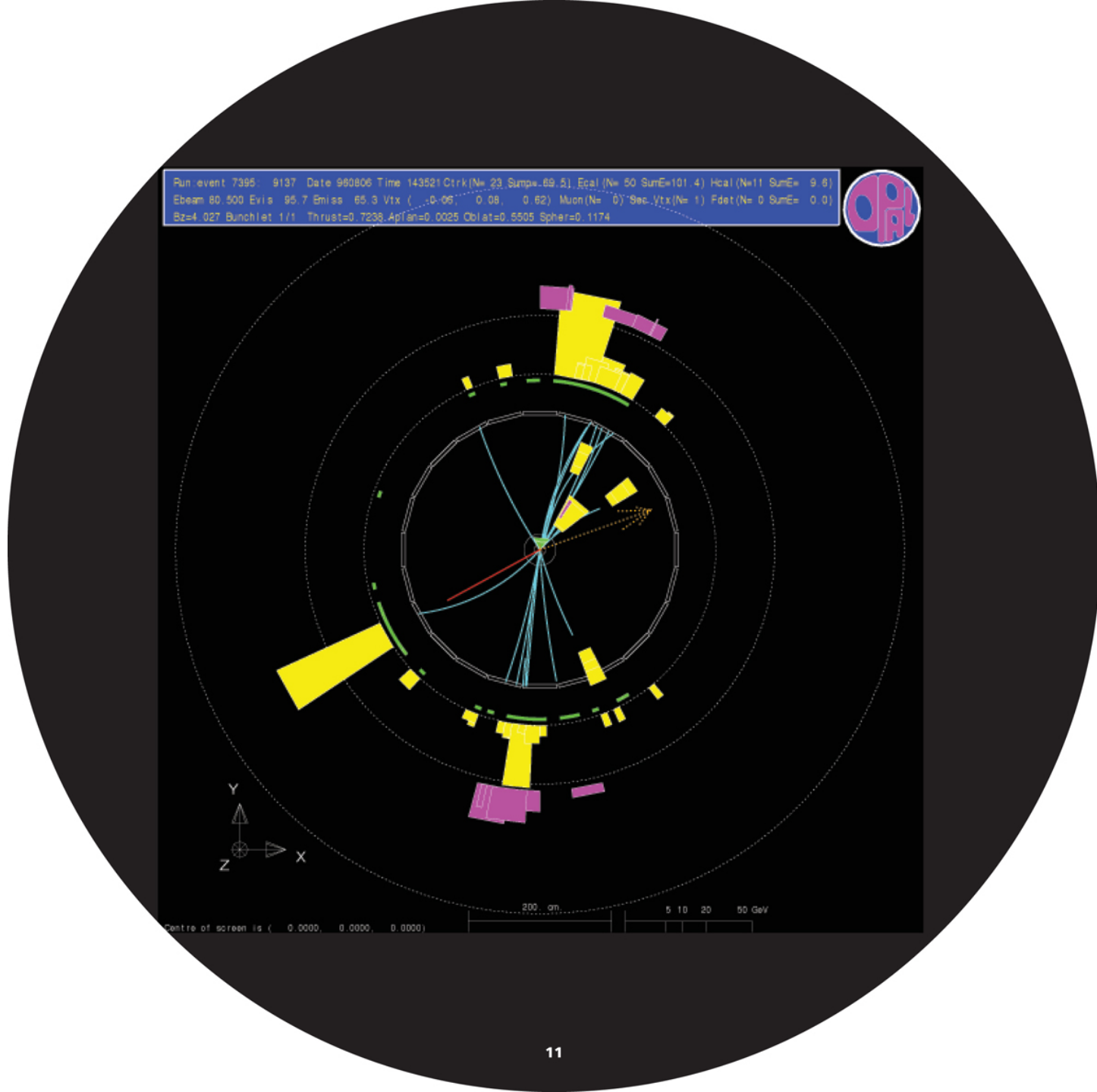

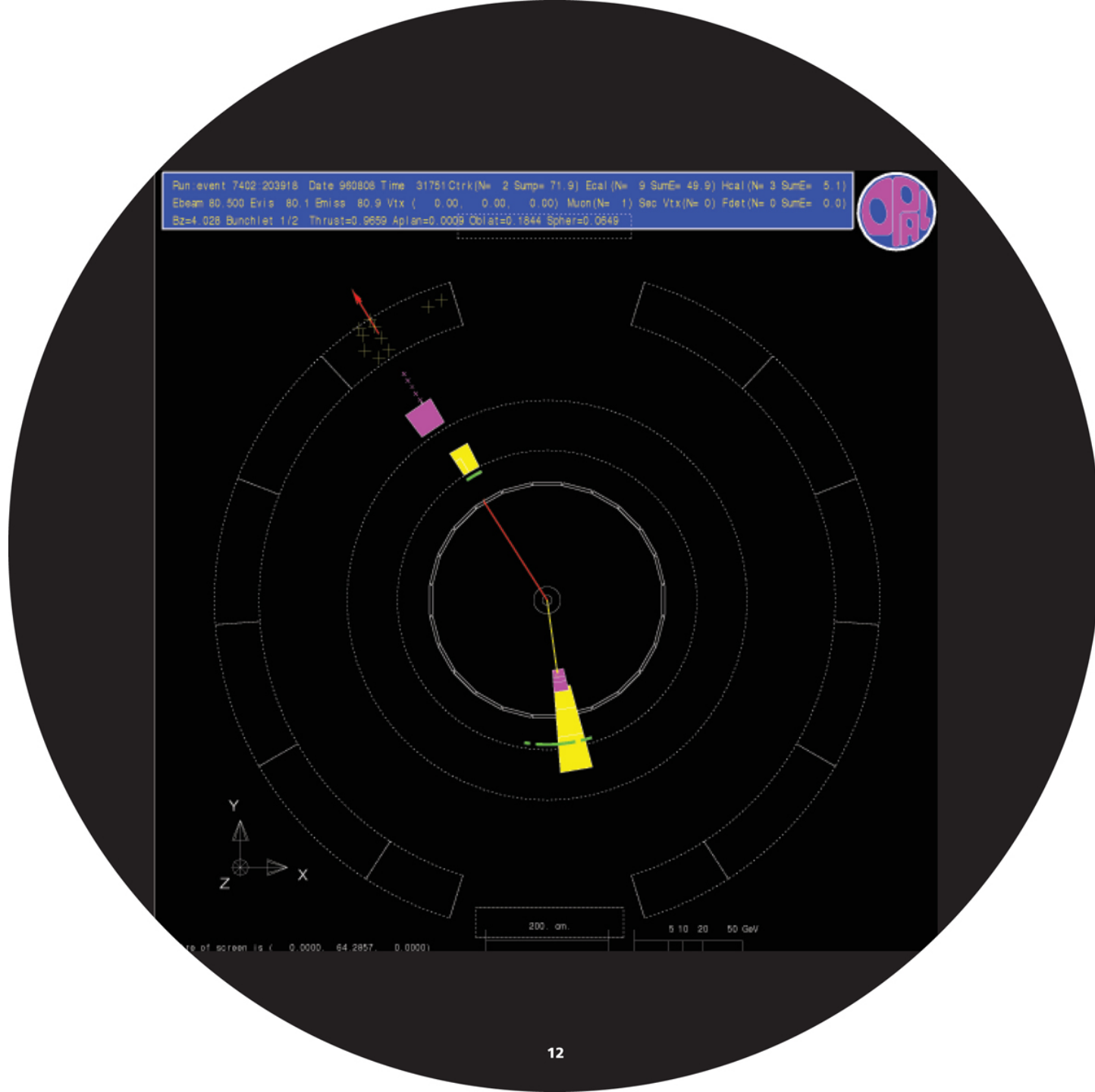

DELPHI

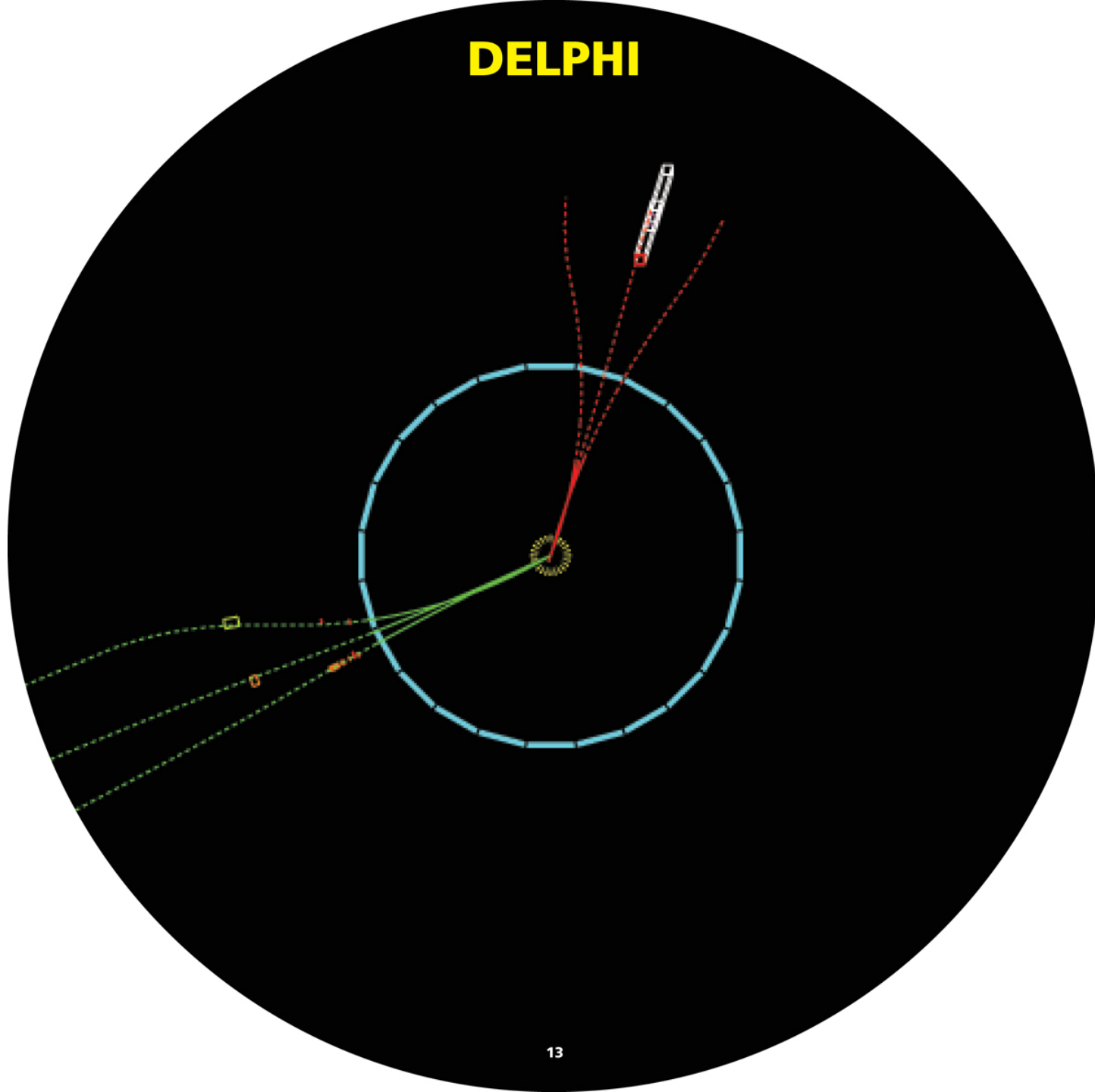

DELPHI

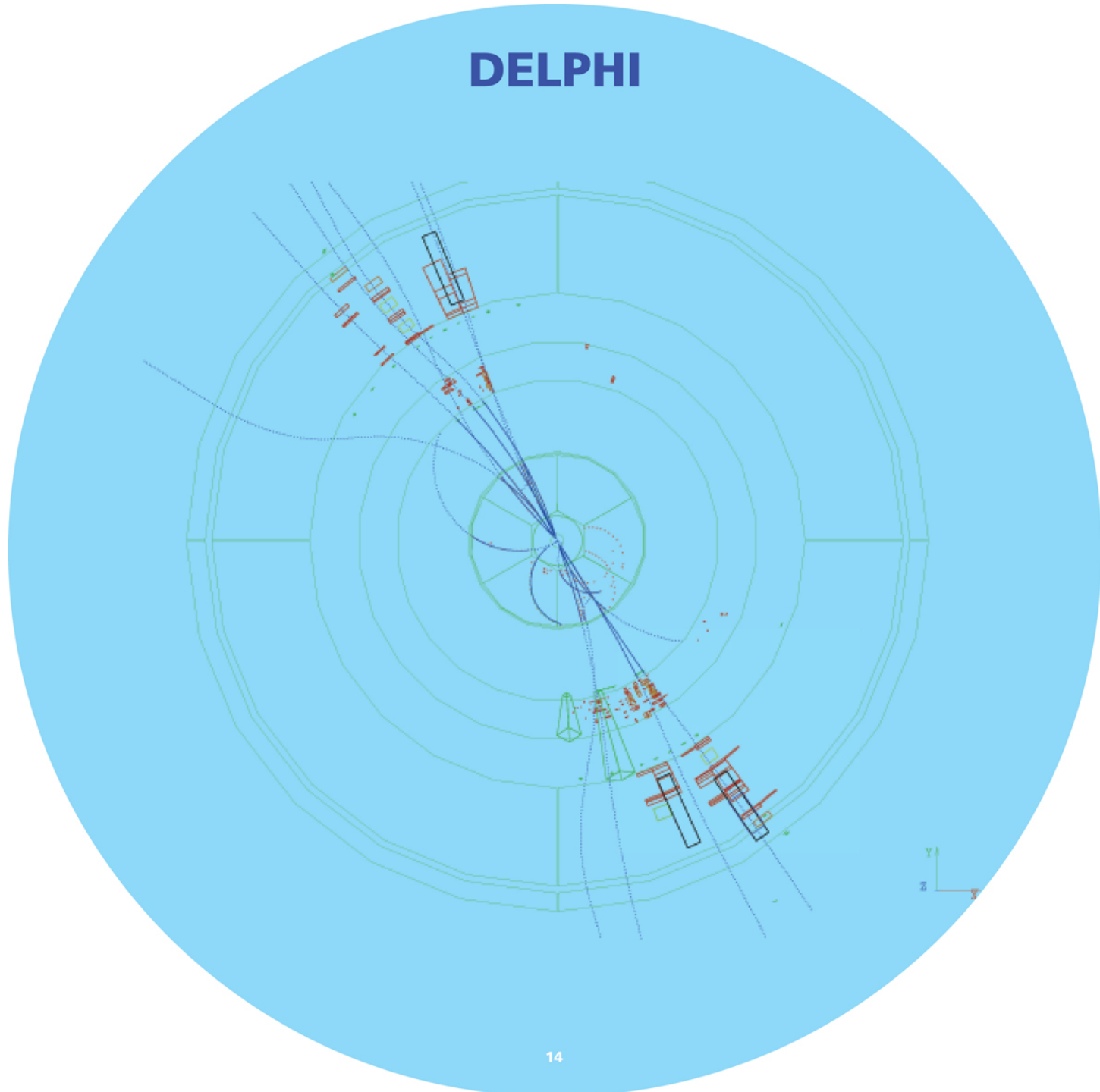

DELPHI

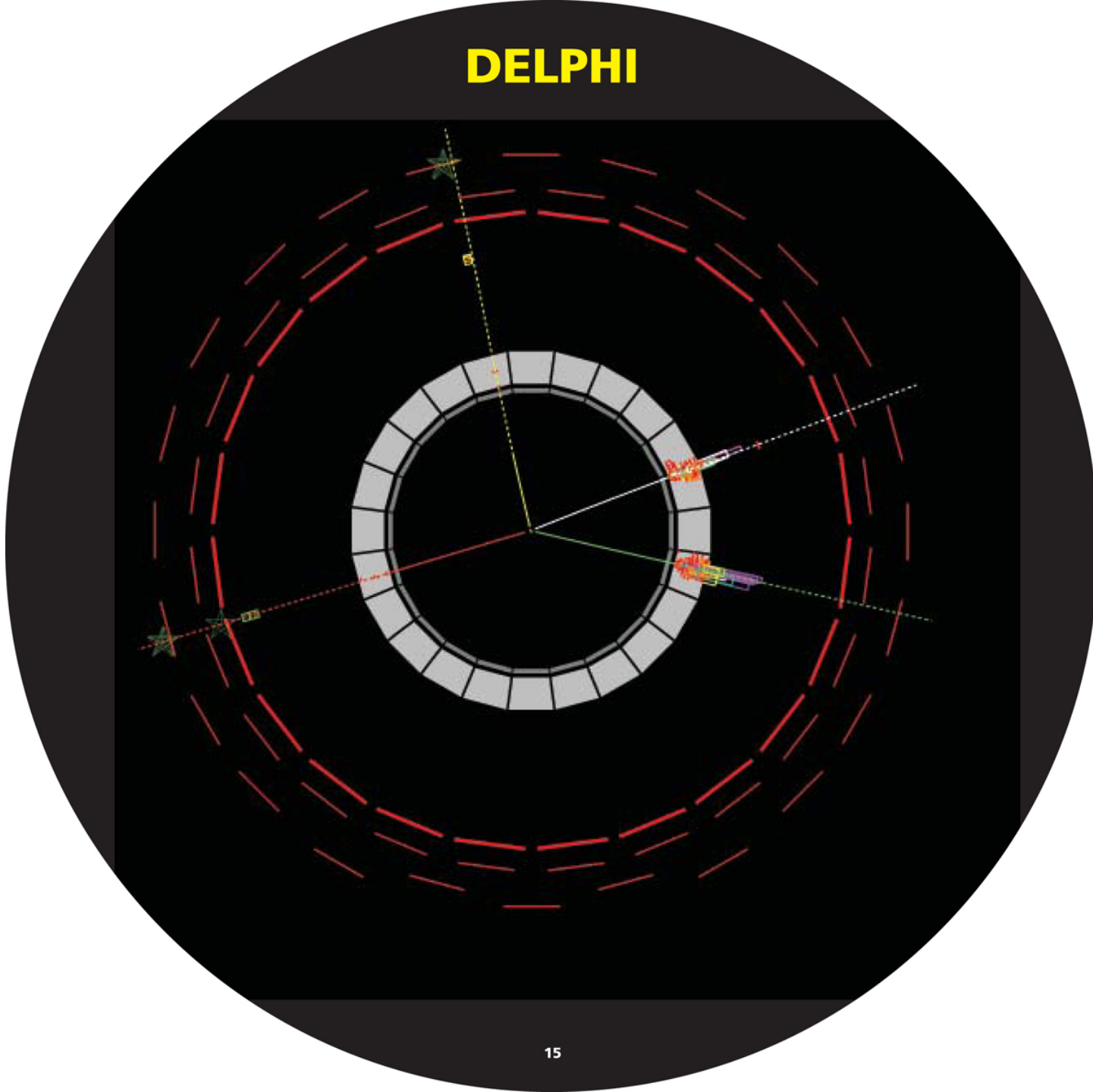

DELPHI

