



esipap...

European School of Instrumentation
in Particle & Astroparticle Physics

15-16 February 2016, Archamps



Tracking

Jérôme Baudot
(baudot@in2p3.fr)

IPHC
Institut Pluridisciplinaire
Hubert CURIE
STRASBOURG

Lecture outline

1. Basic concepts
2. Position sensitive detectors
3. Standard algorithms
4. Advanced algorithms
5. Optimizing a tracking system
6. References

first lecture

second lecture

third lecture

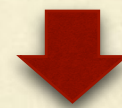

practice

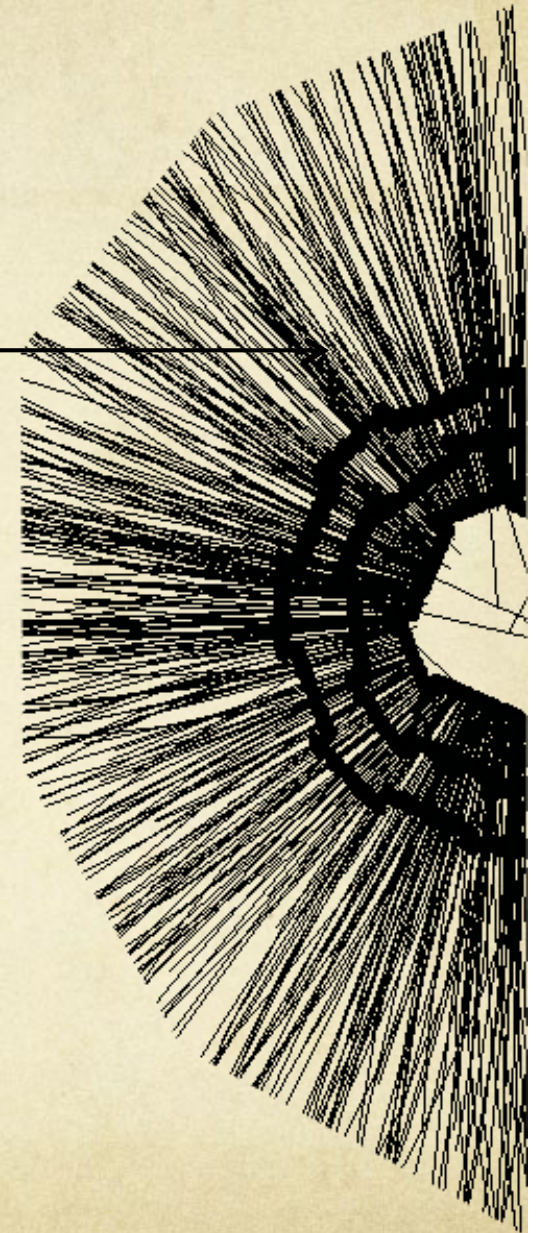

1. Motivations & basic concepts

- Motivations
- Types of measurements
- The 2 main tasks
- Environmental considerations
- Figures of merit

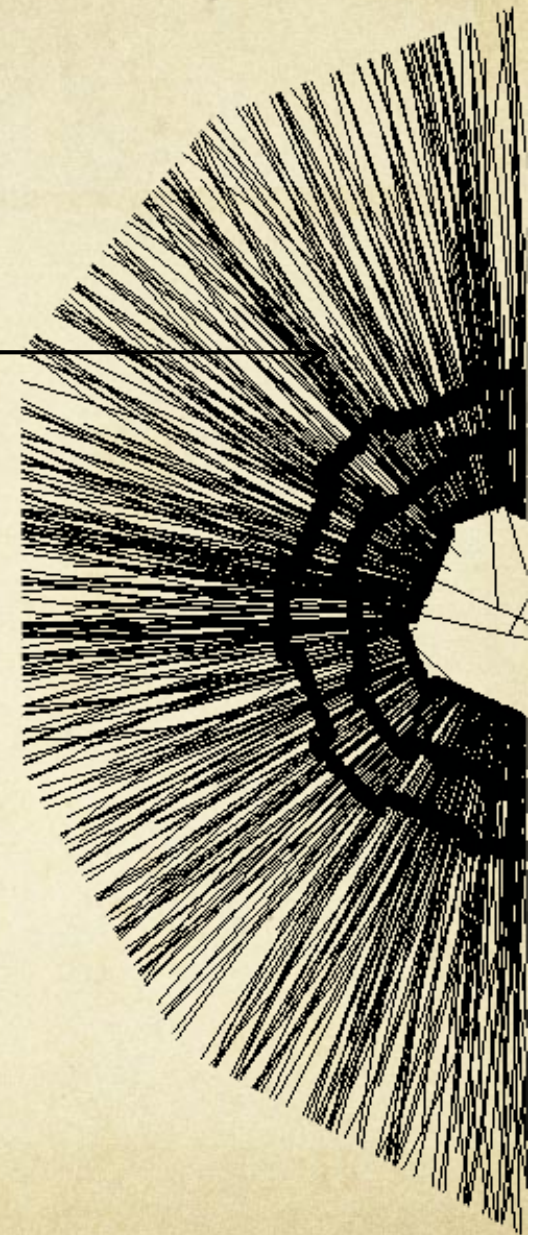

- Understanding an event
 - Individualize tracks \approx particles
 - Measure their properties
 - LHC: ~ 1000 particles per 25 ns “event”
- Track properties
 - **Momentum** \Leftrightarrow curvature in B field
 - Reconstruct invariant masses
 - Contribute to jet energy estimation
 - **Energy** \Leftrightarrow range measurement
 - Limited to low penetrating particle
 - **Mass** \Leftrightarrow dE/dx measurement
 - **Origin** \Leftrightarrow vertexing (track merging)
 - Identify decays
 - Measure flight distance
 - **Extension** \Leftrightarrow particle flow algorithm (pfa)
 - Association with calorimetric shower

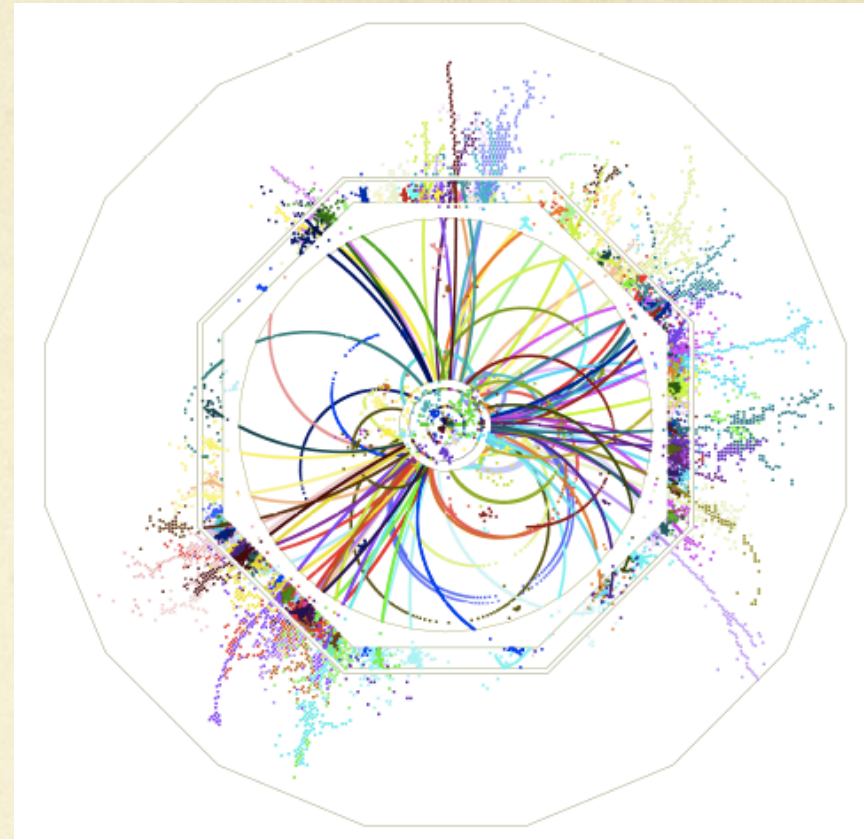

8 jets event ($t\bar{t}h$) @ 1 TeV ILC

1. Motivations & Basic Concepts

Momentum measurement

○ Magnetic field curves trajectories $\frac{d\vec{p}}{dt} = q\vec{v} \times \vec{B}$

→ Rewritten with position (x) and path length (l) → basic equation: $\frac{d^2\vec{r}}{dl^2} \propto \frac{q\vec{B}(x)}{\|\vec{p}\|} \frac{d\vec{r}}{dl}$

→ In $B=4T$ a $10 \text{ GeV}/c$ particle will get a sagitta of 1.5 cm @ $1m$

○ Fixed-target experiments

- Dipole magnet on a restricted path segment
- Measurement of deflection (angle variation)

○ Collider experiment

- Barrel-type with axial B over the whole path
- Measurement of curvature (sagitta)

○ Other arrangements

- Toroidal B ... not covered

○ **Two consequences**

- Position sensitive detectors needed
- Perturbation effects on trajectories limit precision on track parameters

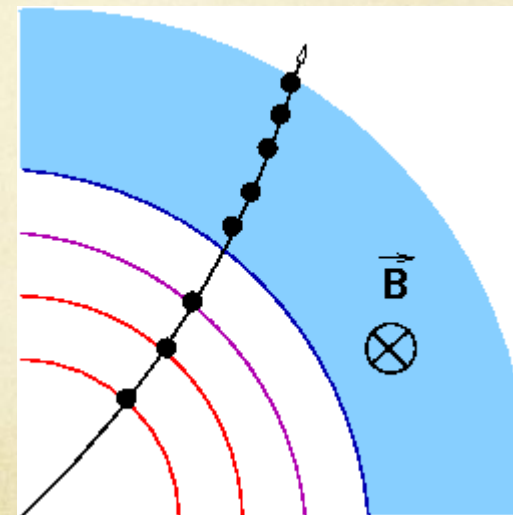
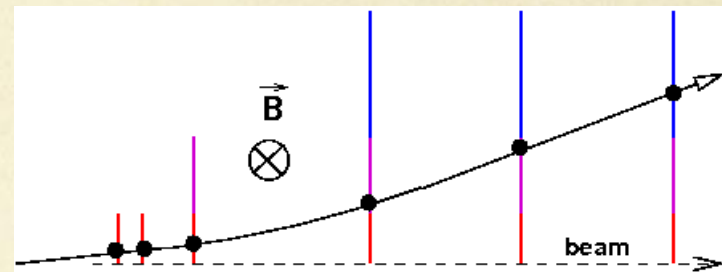

$$\frac{p_T(\text{GeV}/c)}{q} = 0.3 \cdot B(\text{T}) \cdot R(\text{m})$$

○ Identifying through topology

→ Short-lived weakly decaying particles

- Charm c $\tau \sim 120 \mu\text{m}$
- Beauty b $\tau \sim 470 \mu\text{m}$
- tau, strange/charmed/beauty particle

○ Exclusive reconstruction

- Decay topology with secondary vertex
- Exclusive = all particles associated

○ Inclusive “kink” reconstruction

- Some particles are invisible (ν)

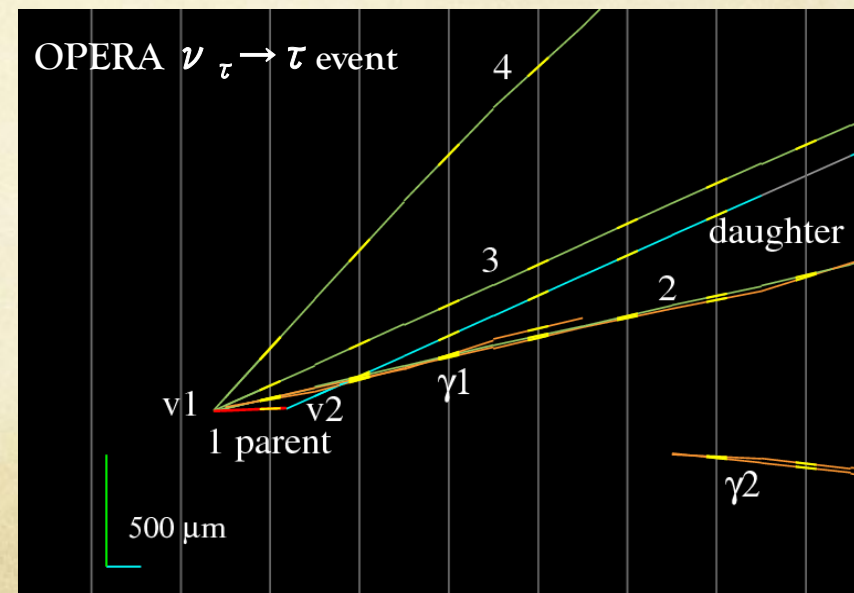
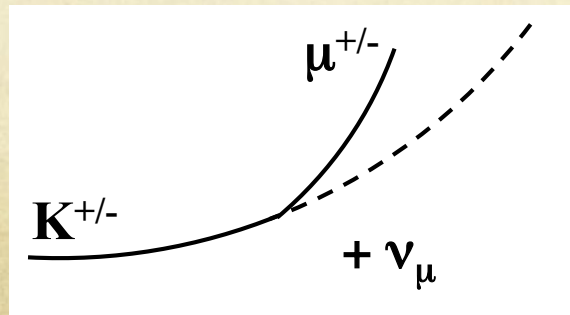
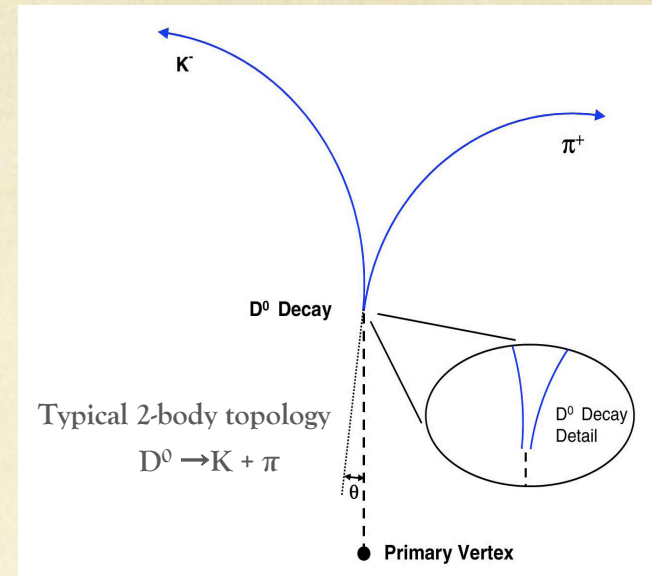

○ Inclusive reconstruction

- Selecting parts of the daughter particles = flavor tagging
- based on impact parameter (IP)
- $\sigma_{IP} \sim 20\text{-}100 \mu\text{m}$ requested

○ Definition of impact parameter (IP)

- Also DCA = distance of closest approach from the trajectory to the primary vertex
- Full 3D or 2D (transverse plane d_{ρ}) + 1D (beam axis)
- Sign extremely useful for tagging

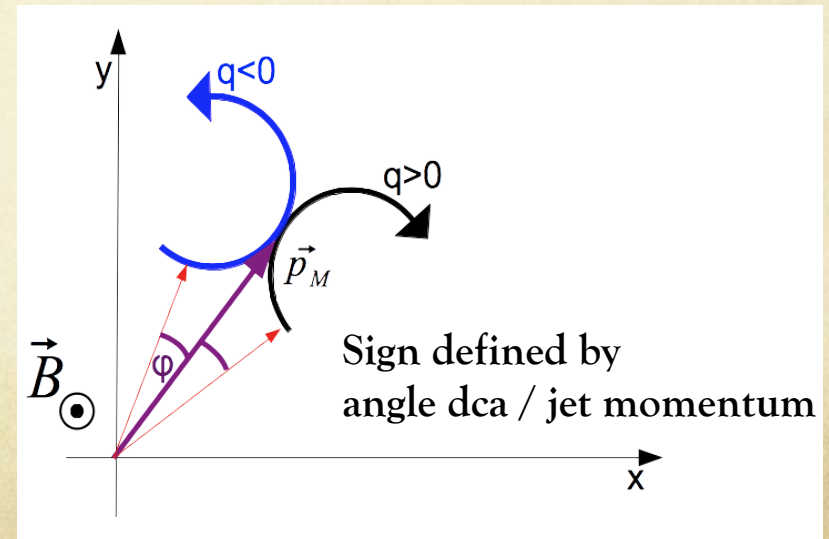
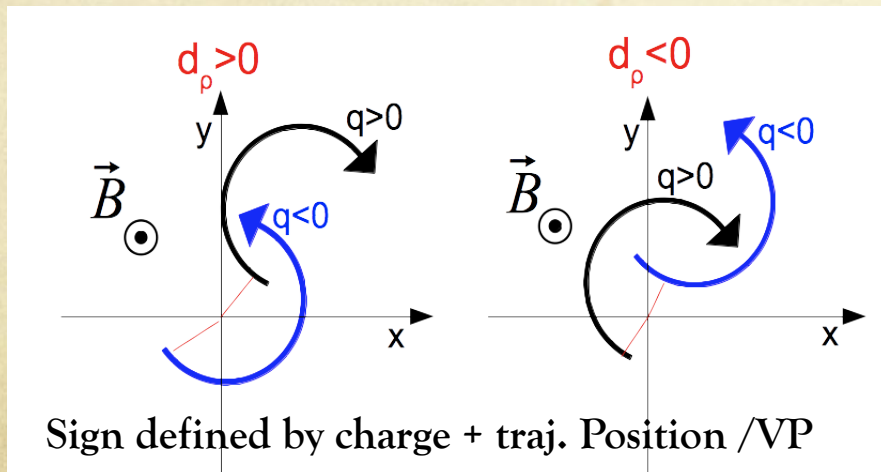
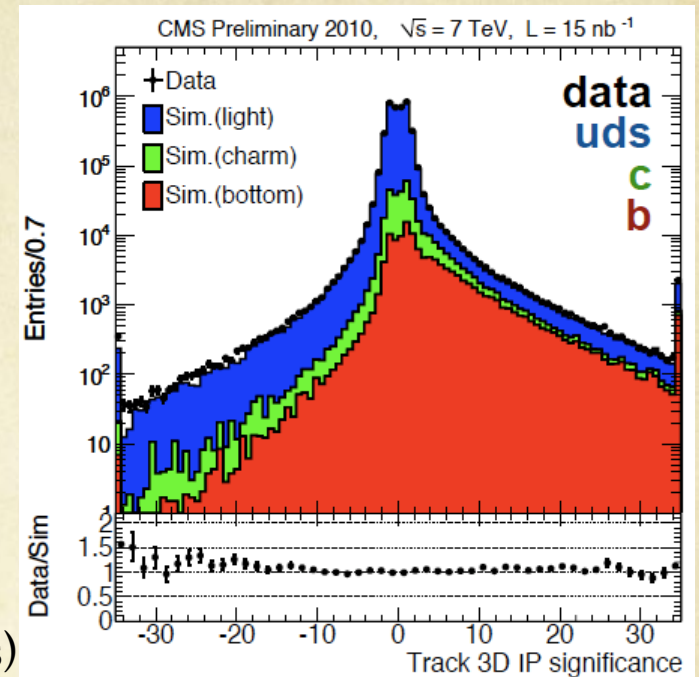

○ Finding the event origin

- Where did the collision did occur?
= Primary vertex
- (life)Time dependent measurements
 - CP-asymmetries @ B factories ($\Delta z \approx 60-120 \mu\text{m}$)
- Case of multiple collisions / event
 - $\gg 10$ vertex @ LHC

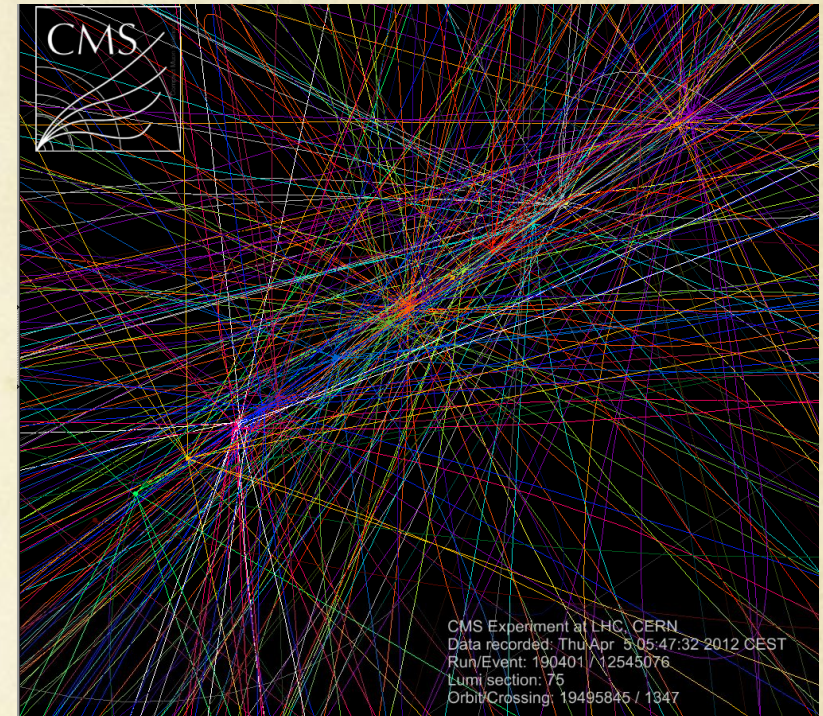

○ Remarks for collider

- Usually no measurement below 1-2 cm / primary vertex
- Requires **extrapolation**

- Usually not a tracker task
 - CALORIMETERS (see lecture by Isabelle)
 - Indeed calorimeters gather material to stop particles while trackers try to avoid material (multiple scattering)
 - however...calorimetry tries to improve granularity
- Particle flow algorithm
 - LHC / ILC
- Energy evaluation by counting particles
 - Clearly heretic for calorimetry experts
 - Requires to separate E_{deposit} in dense environment
- Range measurement for low energy particles
 - Stack of tracking layers
 - Modern version of nuclear emulsion

NOT COVERED

○ Reminder on the physics (see other courses)

- > Coulomb scattering mostly on nuclei
- > Molière theory description as a **centered** gaussian process
 - the thinner the material, the less true -> large tails

○ In-plane description (defined by vectors $\mathbf{p}_{in}, \mathbf{p}_{out}$)

- > Corresponds to (ϕ, θ) with $\mathbf{p}_{in} = \mathbf{p}_z$ and $p_{out}^2 = p_{out,z}^2 + p_{out,T}^2$

$$\begin{cases} p_{out} \cos\theta \approx p_{out,z} \\ p_{out,T} = p_{out} \sin\theta \approx p_{out} \theta \end{cases}$$

$$\sigma_\theta = \frac{13.6 \text{ (MeV/c)}}{\beta p} \cdot z \cdot \sqrt{\frac{\text{thickness}}{X_0}} \cdot \left[1 + 0.038 \ln\left(\frac{\text{thickness}}{X_0}\right) \right]$$

(note : $\phi \in [0, 2\pi]$ uniform)

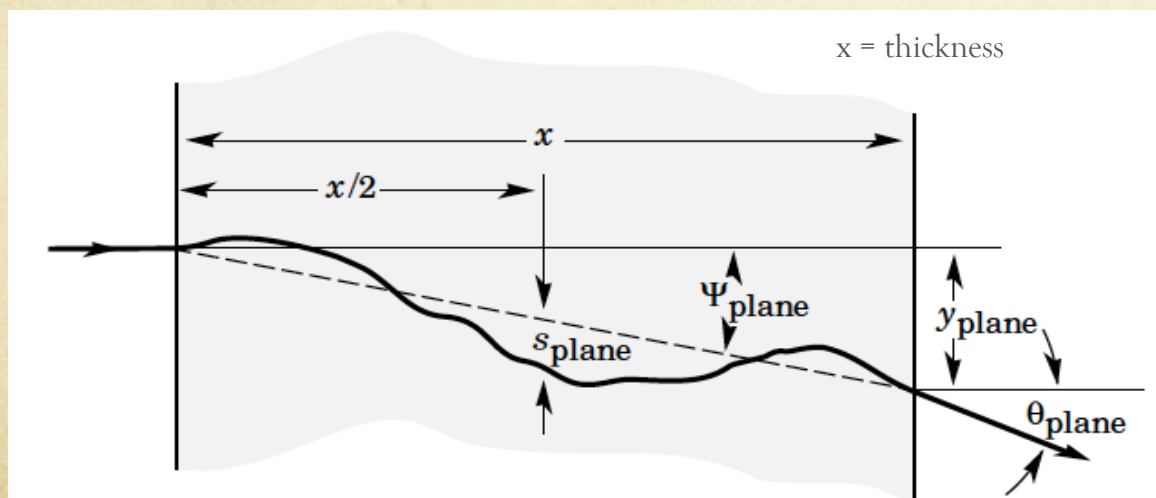

X_0 = radiation length
 Same definition as in calorimetry
 This is accidental

- In-space description (defined by fixed x/y axes)
 - Corresponds to (θ_x, θ_y) with $p_{out,T}^2 = p_{out,x}^2 + p_{out,y}^2$ $\begin{cases} p_{out} \sin\theta_x \approx p_{out} \theta_x \\ p_{out} \sin\theta_y \approx p_{out} \theta_y \end{cases} \Rightarrow \theta^2 = \theta_x^2 + \theta_y^2$
 - θ_x and θ_y are independent gaussian processes $\sigma_\theta^2 = \sigma_{\theta_x}^2 + \sigma_{\theta_y}^2$ and $\sigma_{\theta_x} = \sigma_{\theta_y} = \frac{\sigma_\theta}{\sqrt{2}}$

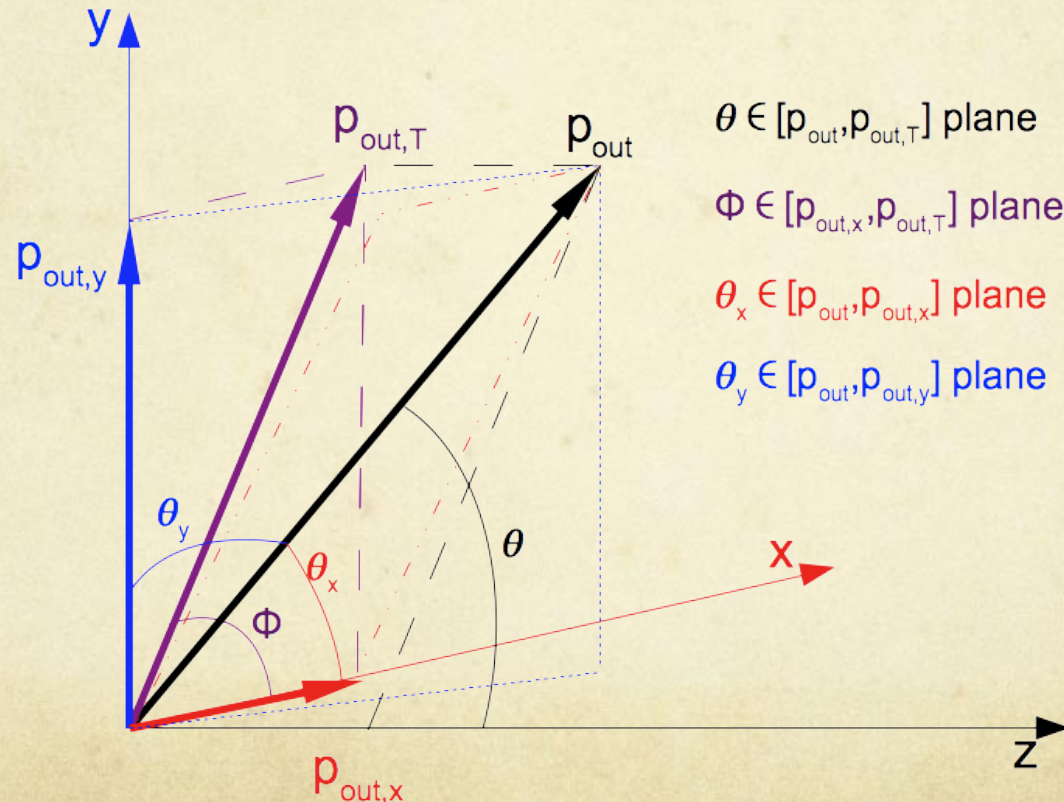

○ Important remark when combining materials

→ Total thickness $T = \sum T_i$, each material (i) with $X_0(i)$

→ Definition of effective radiation length $\Rightarrow X_{0,eff} = \frac{\sum T_i \times X_0(i)}{T}$

→ Consider **single gaussian** process $\sigma_{eff} \propto \sqrt{\frac{T}{X_{0,eff}}}$

and never do variance addition
(which minimize deviation)

~~$$\sigma_{eff} = \sqrt{\sum \frac{T_i}{X_0(i)}}$$~~

○ Impact on tracking algorithm

- May drive choice of method

○ Photon conversion

- Alternative definition of radiation length

probability for a high-energy photon to generate a pair over a path dx : $\text{Prob} = \frac{dx}{\frac{9}{7} X_0}$

- $\gamma \rightarrow e^+e^-$ = conversion vertex

- Generate troubles :

- Additional unwanted tracks
- Decrease statistics for electromagnetic calorimeter

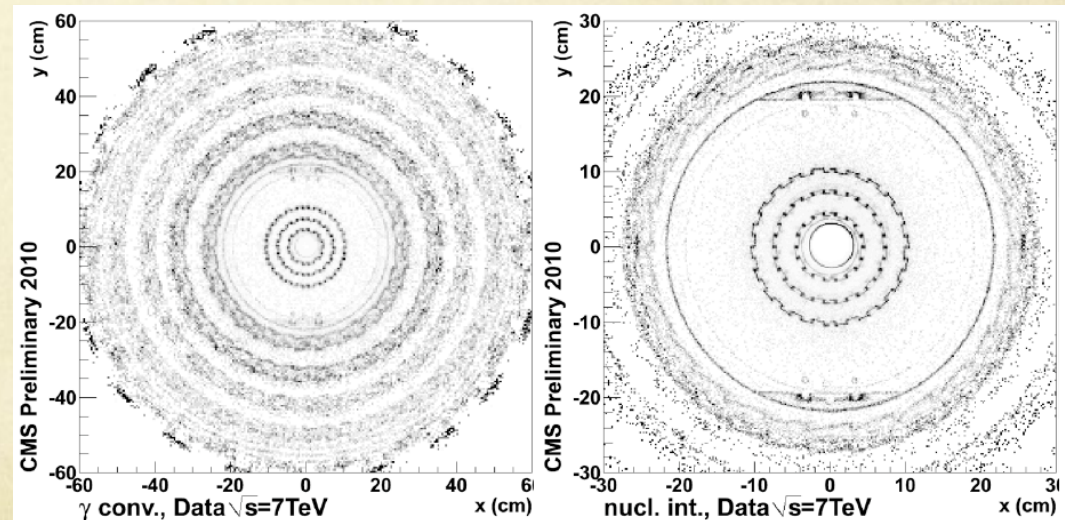

CMS “picture” of material budget
through photon conversion vertices
(silicon tracker only)

- Basic inputs from detectors
 - Succession of 2D or 3D points (or track segments)
 - ➔ Who's who ?
- 2 steps process
 - Step 1: track identification = **finding** = pattern recognition
 - Associating a set of points to a track
 - Step 2: track **fitting**
 - Estimating trajectory parameters ➔ momentum
- Both steps require
 - **Track model** (signal, background)
 - Knowledge of **measurement uncertainties**
 - Knowledge of **materials traversed** (Eloss, mult. scattering)
- Vertexing needs same 2 steps
 - Identifying tracks belonging to same vertex
 - Estimating vertex properties (position + 4-vector)

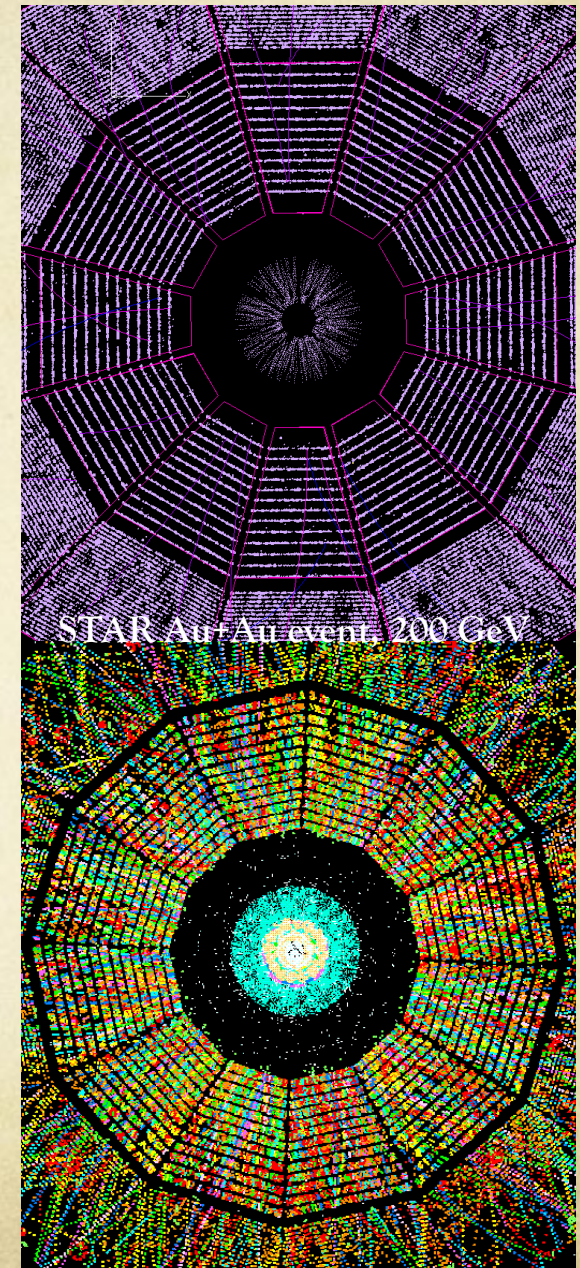

○ Telescope mode

- **Single particle at a time**
 - Sole nuisance = background
- Trigger from beam
 - Often synchronous
- Goal = get the incoming direction

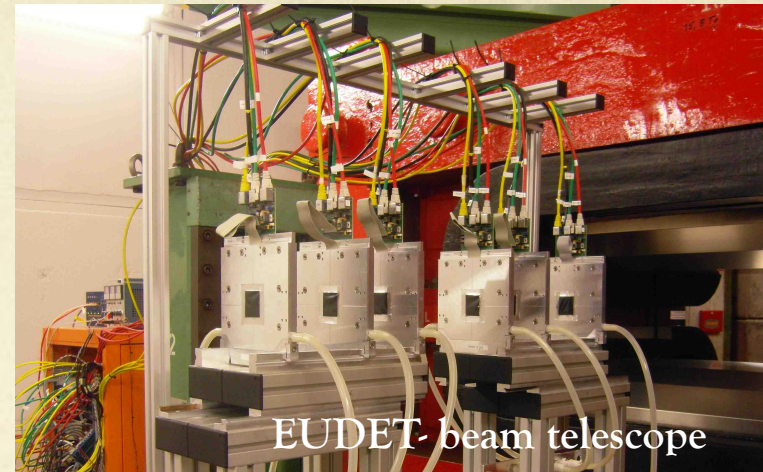

○ The astroparticle way

- Similar to telescope mode
- No synchronous timing
- Ex: deep-water ν telescopes

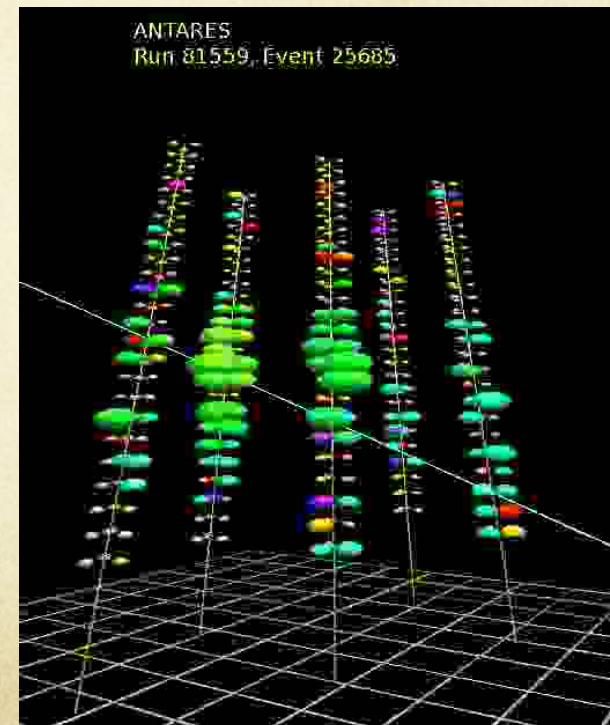

- Life in a real experiment is tough (for detectors of course)
 - Chasing small cross-sections → large luminosity and/or energy
 - Short interval between beam crossing
 - LHC: 25 ns (and >10 collisions / crossing)
 - CLIC: 5 ns (but not continuous)
 - Large amount of particles (could be > 10^7 part/cm²/s) → background, radiation
 - makes the finding more complicated
 - Vacuum could be required (space, very low momentum particles (CBM, LHCb))

- Radiation tolerance
 - Two types of energy loss
 - Ionizing (generate charges): dose in Gy = 100 Rad
 - Non-ionizing (generate defects in solid): fluence in $n_{\text{eq}}(1\text{MeV})/\text{cm}^2$
 - The more inner the detection layer, the harder the radiation (radius² effect)
 - Examples for most inner layers:
 - LHC: 10^{15} to $<10^{17}$ $n_{\text{eq}}(1\text{MeV})/\text{cm}^2$ with 50 to 1 MGy
 - ILC: $<10^{12}$ $n_{\text{eq}}(1\text{MeV})/\text{cm}^2$ with 5 kGy

○ Timing consideration

- **Integration time** drives occupancy level (important for finding algorithm)
- **Time resolution** offers time-stamping of tracks
 - Tracks in one “acquisition event” could be associated to their proper collision event if several have piled-up
- Key question = triggered or not-triggered experiment?

○ Heat concerns

- Spatial resolution → segmentation → many channels
Readout speed → power dissipation/channel
 - Efficient cooling techniques exist BUT
add material budget and may not work everywhere (space)
- } Hot cocktail!

○ Summary

- Tracker technology driven by environmental conditions: hadron colliders (LHC)
- Tracker technology driven by physics performances: lepton colliders (B factories, ILC),
heavy-ion colliders (RHIC, LHC)
- Of course, some intermediate cases: superB factories, CLIC

○ For detection layer

- **Detection efficiency**
 - Mostly driven by Signal/Noise
 - Note: Noise = signal fluctuation ⊕ readout (electronic) noise
- **Intrinsic spatial resolution**
 - Driven by segmentation (not only)
 - Useful tracking domain $\sigma < 1\text{mm}$
- Linearity and resolution on dE/dx
- **Material budget**
- “Speed” (integration time, time resolution, ...)

○ For detection systems (multi-layers)

- **Two-track resolution**
 - Ability to distinguish two nearby trajectories
 - Mostly governed by signal spread / segments
- **Momentum resolution** $\frac{\sigma(p)}{p}$
- **Impact parameter resolution**
 - Sometimes called “distance of closest approach” to a vertex

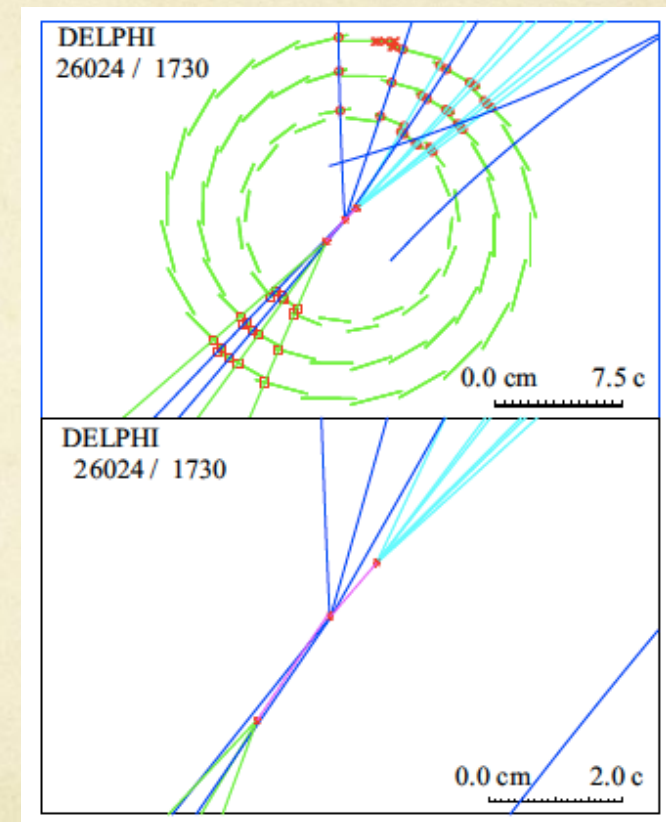

2. Detection technologies

- Intrinsic resolution
- Single layer systems
 - Silicon, gas sensors, scintillator
- Multi-layer systems
 - Drift chamber and TPC
- Tentative simplistic comparison
- Magnets
- Leftovers
- Practical considerations

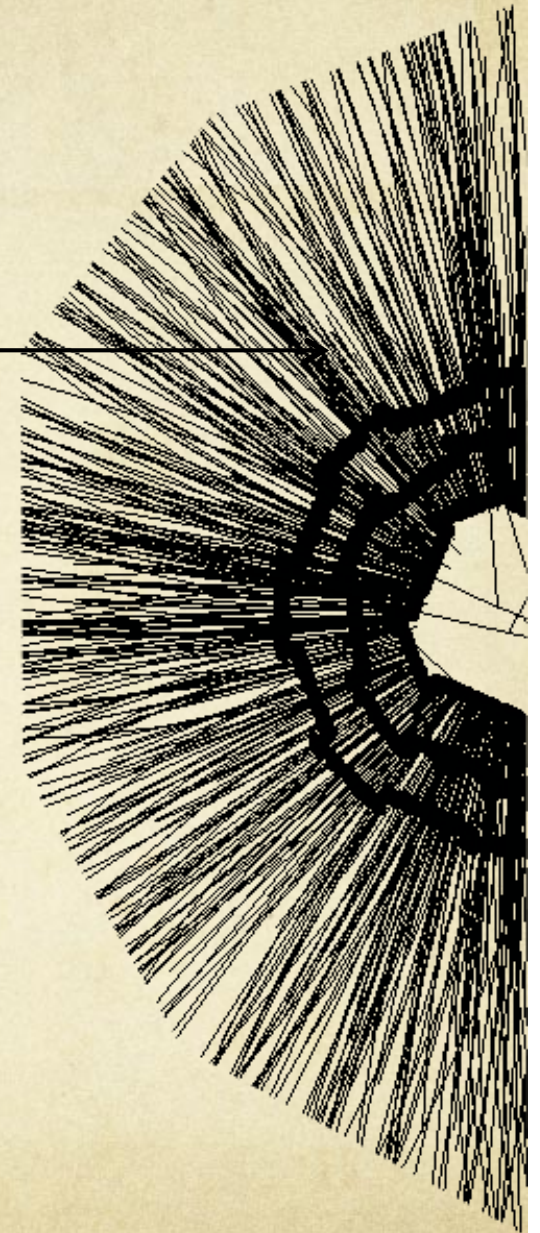

1. Motivations & Basic Concepts:

Intrinsic resolution

○ Position measurement comes from segmentation

→ Pitch

○ Digital resolution $\sigma = \frac{\text{pitch}}{\sqrt{12}}$

○ Improvement from signal sharing

→ Position = charge center of gravity

$$\sigma \propto \frac{\text{pitch}}{\text{signal/noise}}$$

→ Effects generated by

- Secondary charges spread inside volume
- Inclined tracks (however, resol. limited at large angles)

→ Potential optimization of segmentation / sharing

- Work like signal sampling theory (Fourier transform)

→ Warnings:

- Lorentz force from B mimic the effect
- counterproductive / 2-track resolution

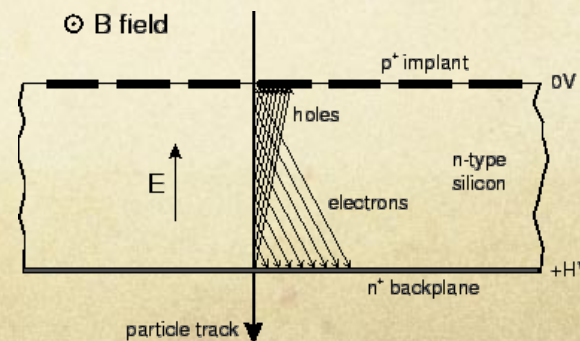
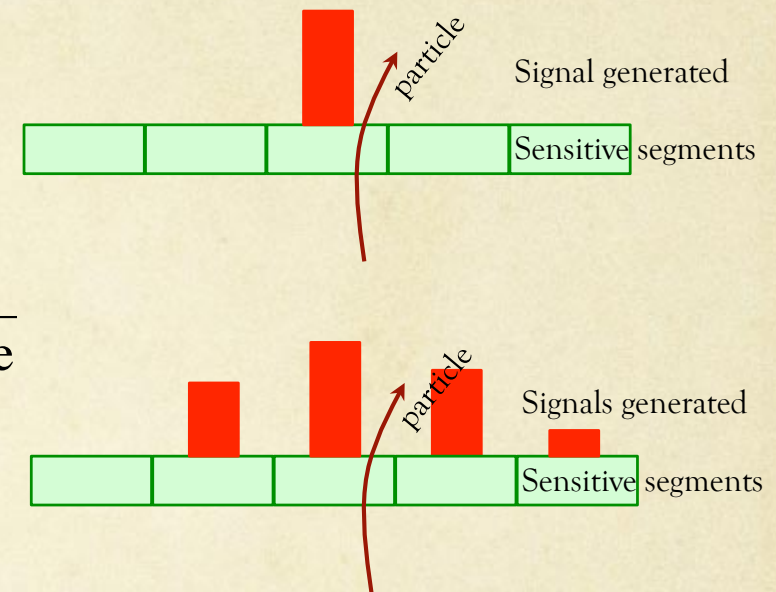

2. Detector Technologies:

Silicon sensors: strips

○ Basic sensitive element

- E-h pairs are generated by ionization in silicon
 - 3.6 eV needed
 - 300 μm thick Si generates ~ 22000 charges for MIP BUT beware of Landau fluctuation
- Collection: P-N junction = diode
 - Full depletion (10 to 0.5 kV) generates a drift field (10^4 V/cm)
 - Collect time ~ 15 ps/ μm

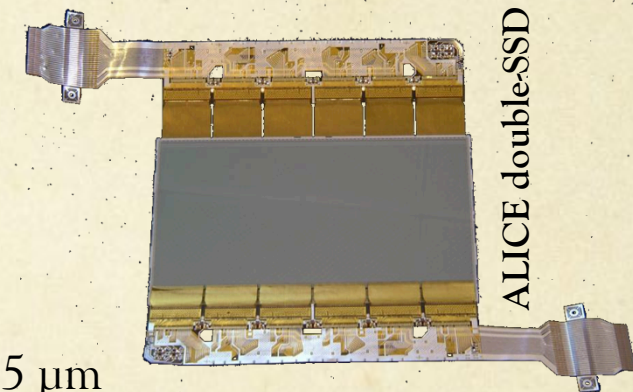
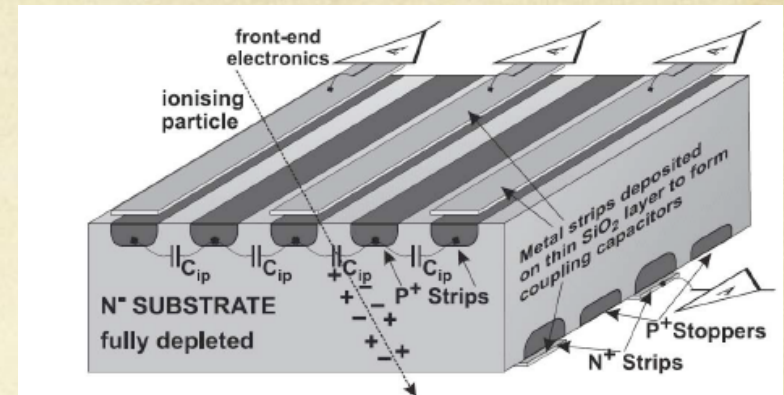

○ Silicon strip detectors

- sensor "easily" manufactured with pitch down to ~ 25 μm
- 1D if single sided
- Pseudo-2D if double-sided
 - Stereo-angle useful against ambiguities
- Difficult to go below 100 μm thickness
- Speed and radiation hardness: LHC-grade

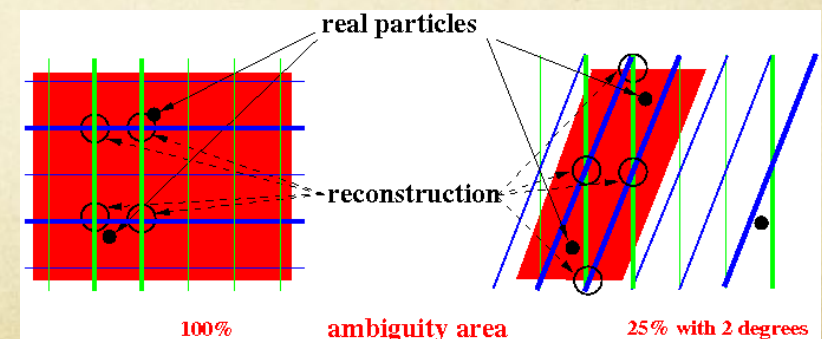

2. Detector Technologies:

Silicon sensors: hybrid-pixels

○ Concept

- Strips → pixels on sensor
- One to one connection from electronic channels to pixels

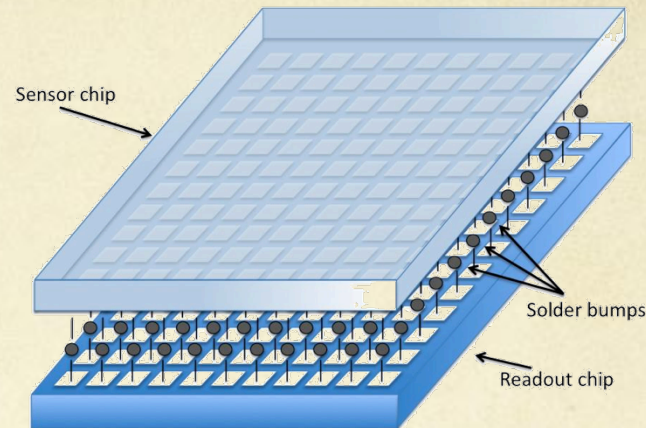

○ Performances

- Real 2D detector & keep performances of strips
 - Can cope with LHC rate (speed & radiation)
- Pitch size limited by physical connection and #transistors for treatment
 - minimal (today): $50 \times 50 \mu\text{m}^2$
 - typical: $100 \times 150 / 400 \mu\text{m}^2$
 - spatial resolution about $10 \mu\text{m}$
- Material budget
 - Minimal(today): $100(\text{sensor}) + 100(\text{elec.}) \mu\text{m}$
- Power budget: $10 \mu\text{W}/\text{pixel}$

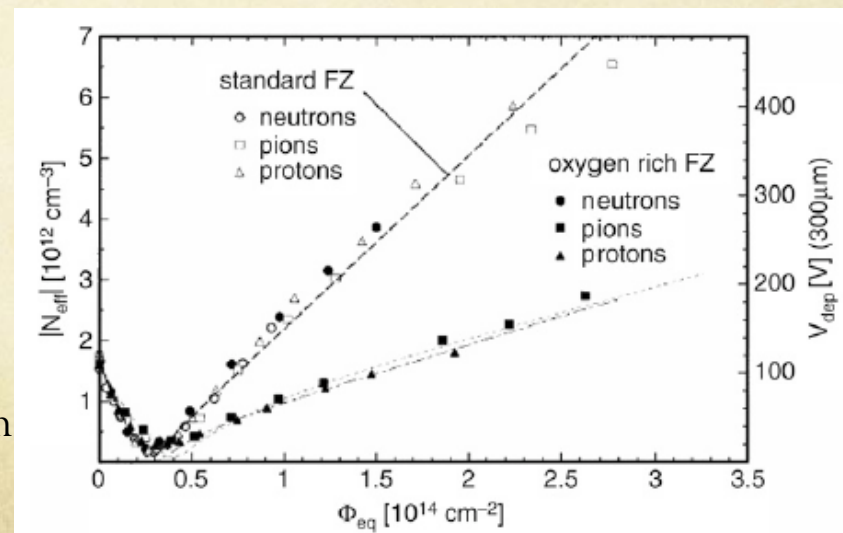
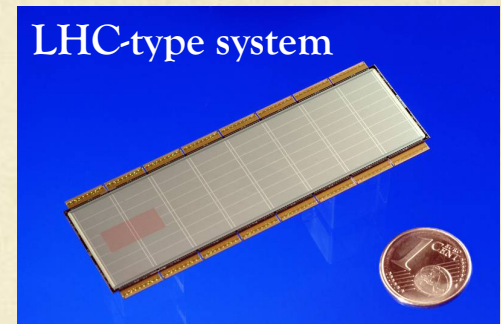

2. Detector Technologies:

CMOS Pixel Sensor

○ Concept

- Use industrial CMOS process
 - Implement an array of sensing diode
 - Amplify the signal with transistors near the diode
- Gain in granularity: pitch down to $\sim 10 \mu\text{m}$
- Gain in sensitive layer thickness $\sim 10\text{-}20 \mu\text{m}$
- BEWARE: full-depletion not systematically available
 - Slow (100 ns) thermal drift
 - Limited non-ionizing rad. tolerance

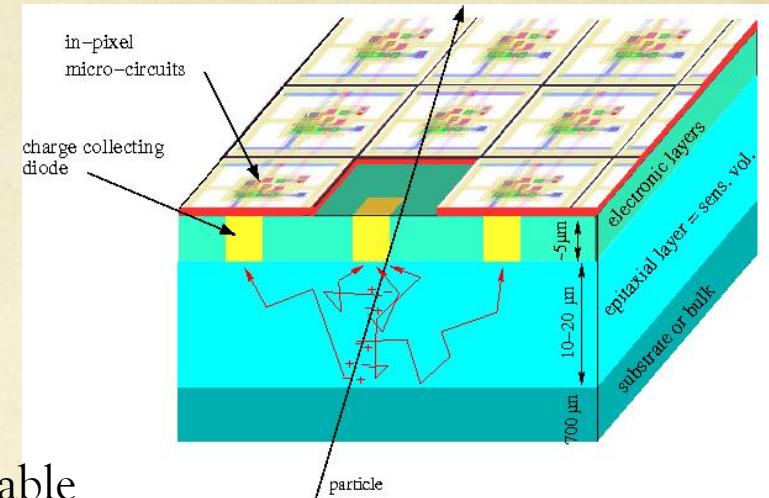

○ Performances

- Spatial resolution 1-10 μm (in 2 dimensions)
- Material budget: $\lesssim 50 \mu\text{m}$
- Power budget: 1-5 $\mu\text{W}/\text{pixel}$
- Integration time $\sim 20\text{-}100 \mu\text{s}$ demonstrated
 - $\sim 1 \mu\text{s}$ in development

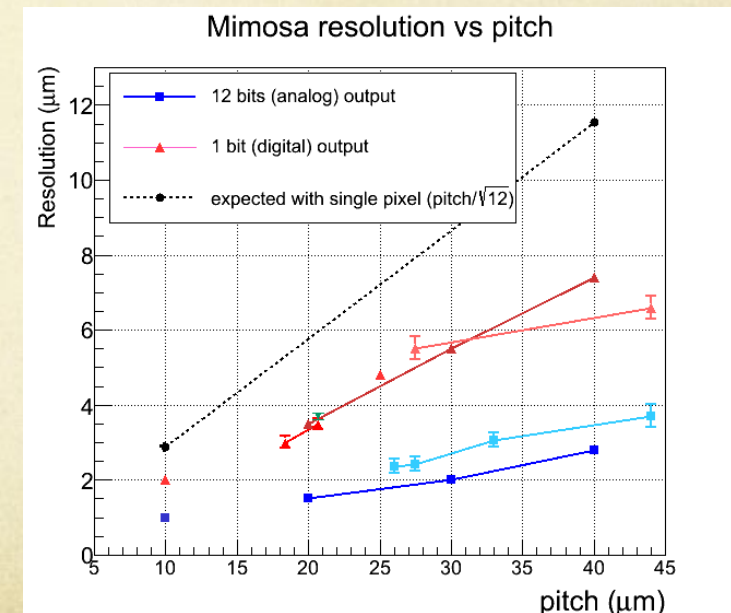

2. Detector Technologies:

Wire chambers

○ Basic sensitive element

- Metallic wire, 1/r effect generated an avalanche
- Signal depends on gain (proportional mode) typically 10^4
- Signal is fast, a few ns

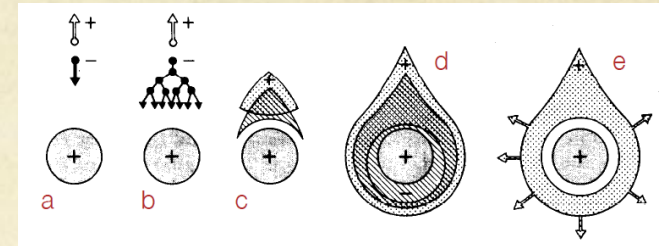

○ Gas proportional counters

- Multi-Wire Proportional Chamber
 - Array of wires
 - 1 or 2D positioning depending on readout
 - Wire spacing (pitch) limited to 1-2 mm
- Straw or drift tube
 - One wire in One tube
 - Extremely fast (compared to Drift Chamber)
 - Handle high rate
 - Spatial resolution $<200 \mu\text{m}$
 - Left/right ambiguity

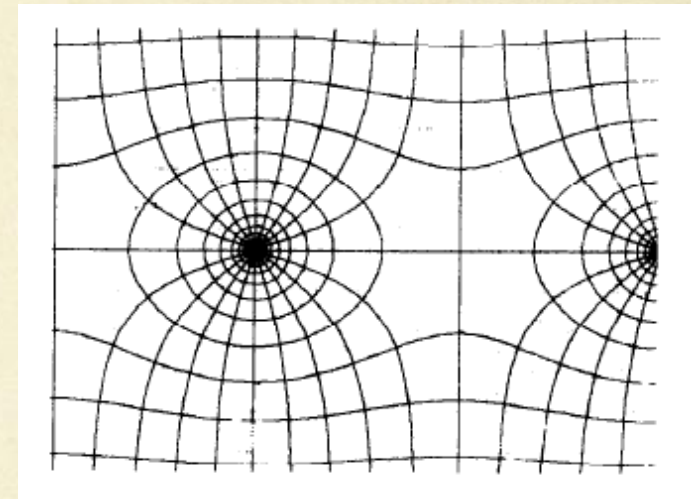

Electric fields line
around anode wires

2. Detector Technologies:

Wire chambers “advanced”

○ Micro-pattern gas multipliers

→ MSGC

- Replace wires with lithography micro-structures
- Smaller anodes pitch 100-200 μm
- BUT Ageing difficulties due to high voltage and manufacturing not so easy

→ GEM

- Gain 10^5
- Hit rate 10^6 Hz/cm^2

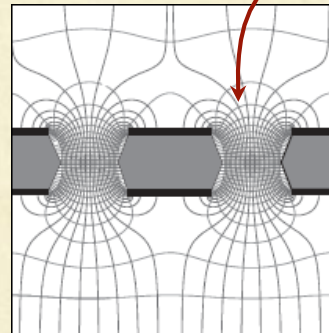

→ MICROME GAS

- Even smaller distance anode-grid
- Hit rate 10^9 Hz/cm^2

→ More development

- Electron emitting foil working in vacuum!

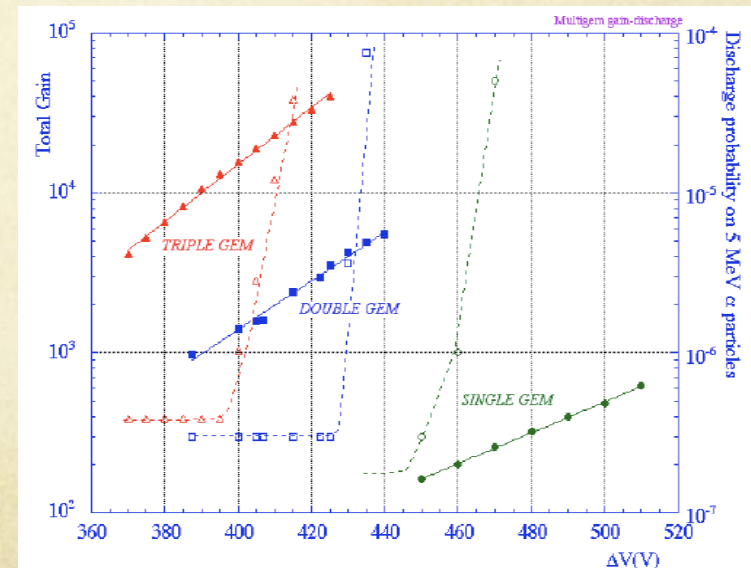
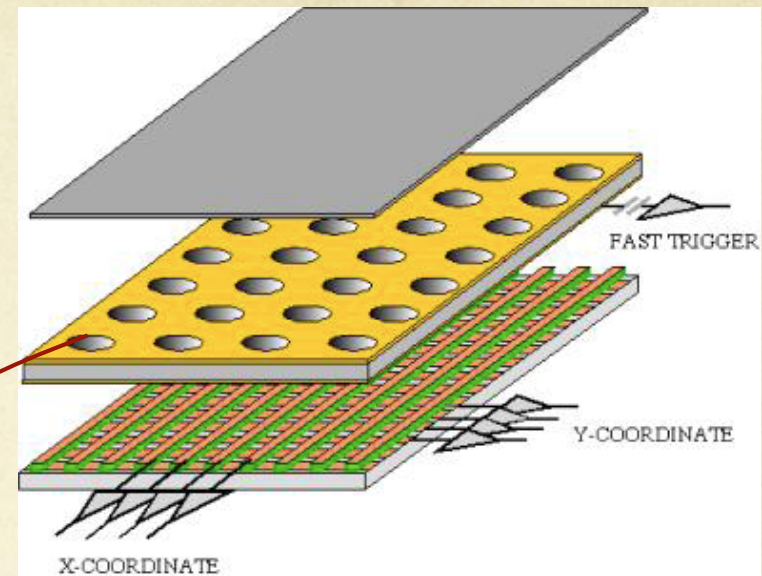

2. Detector Technologies:

Drift chambers

○ Basic principle

- Mix field and anode wires
 - Generate a drift
- Pressurize gas to increase charge velocity (few atm)
- 3D detector
 - 2D from wire position
 - 1D from charge sharing at both ends

○ Spatial Resolution

- Related to drift path

$$\sigma \propto \sqrt{\text{drift length}}$$

- Typically 100-200 μm

○ Remarks

- Could not go to very small radius

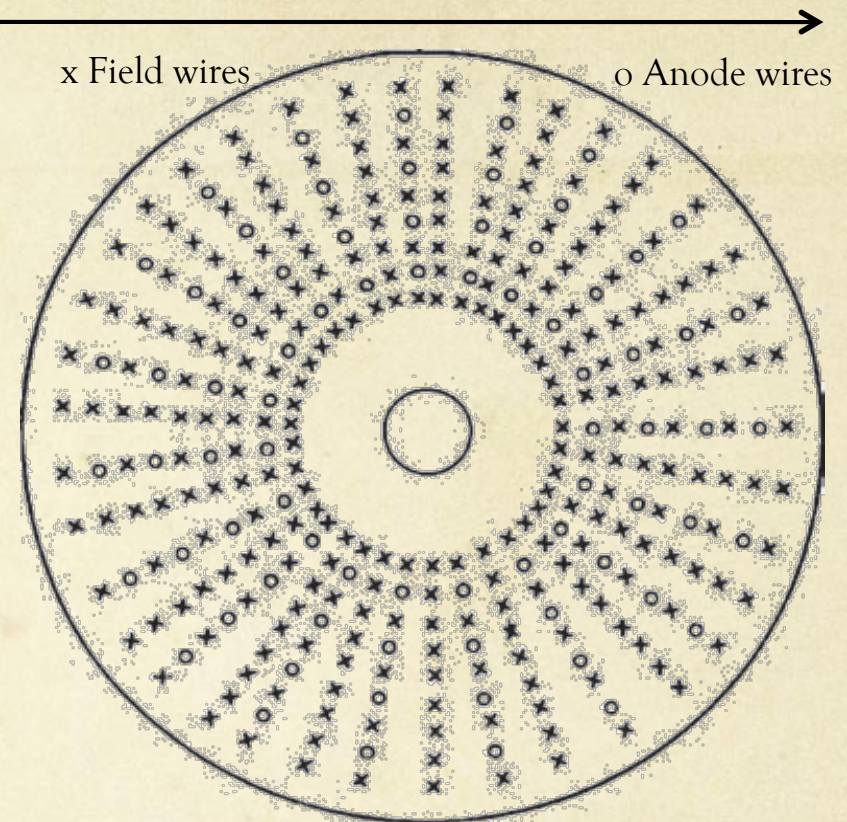

Same principle
with straw tubes

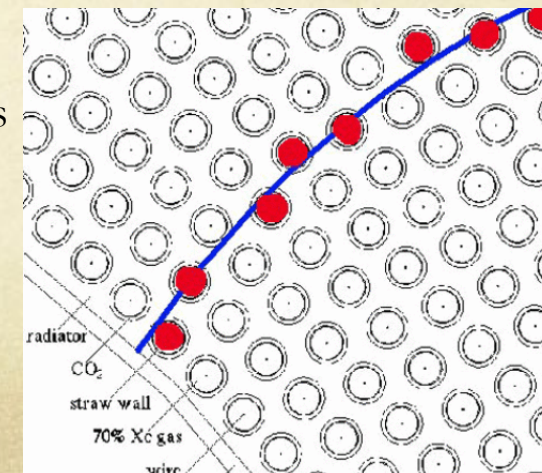

○ Benefits

- Large volume available
- Multi-task: tracking + Part. Identification

○ Basic operation principle

- Gas ionization → charges
- Electric field → charge drift along straight path
- Information collected
 - 2D position of charges at end-cap
 - 3rd dimension from drift time
 - Energy deposited from #charges
- Different shapes:
 - rectangles (ICARUS)
 - Cylinders (colliders)
 - Volumes can be small or very large

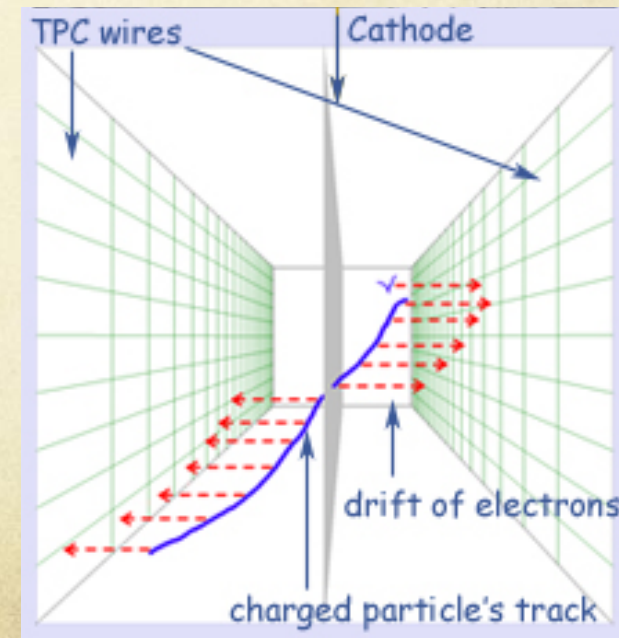
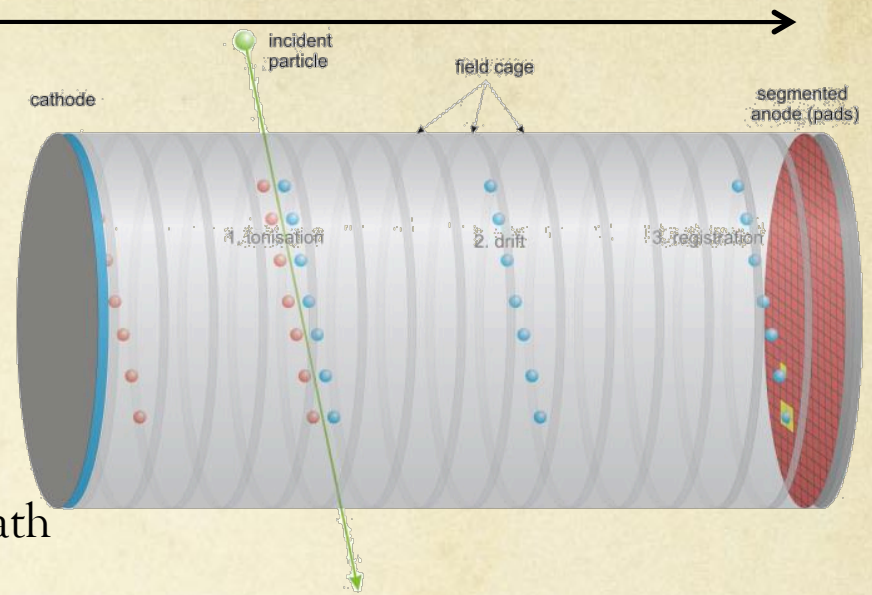

○ End cap readout

- Gas proportional counters
 - Wires+pads, GEM, Micromegas

○ Performances

- Two-track resolution $\sim 1\text{cm}$
- Transverse spatial resolution $\sim 100 - 200\ \mu\text{m}$
- Longitudinal spatial resolution $\sim 0.2 - 1\ \text{mm}$
- Longitudinal drift velocity: 5 to 7 $\text{cm}/\mu\text{s}$
 - ALICE TPC (5m long): 92 μs drift time
- Pro
 - Nice continuously spaced points along trajectory
 - Minimal multiple scattering (inside the vessel)
- Cons
 - Limiting usage with respect to collision rate

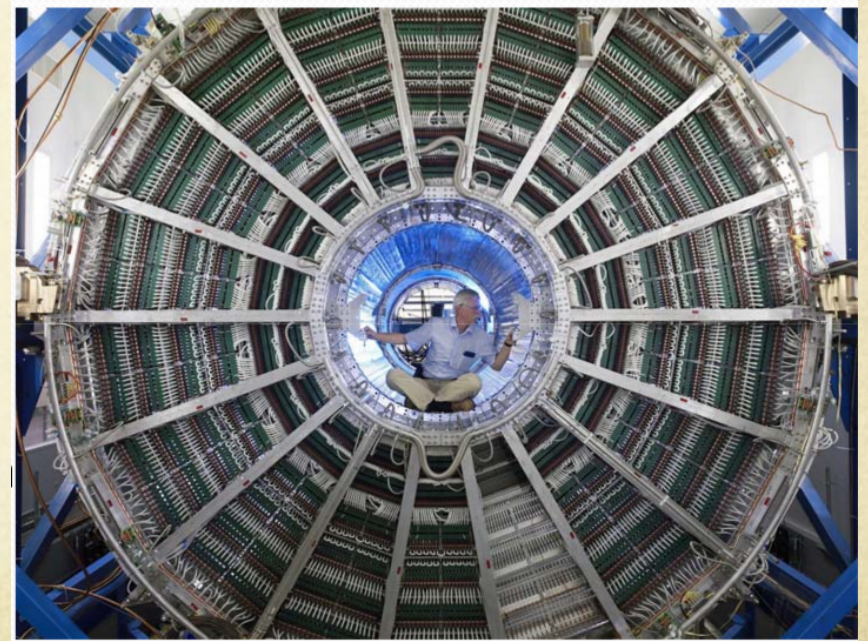
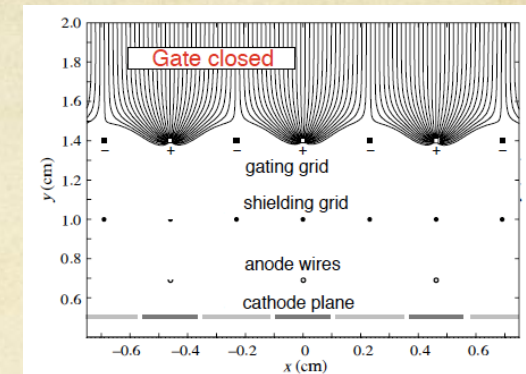
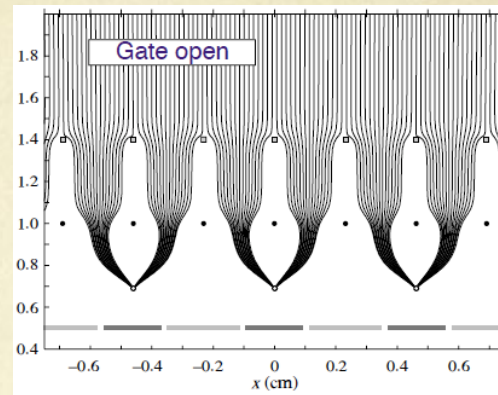

2. Detector Technologies:

Tentative “simplistic” comparison

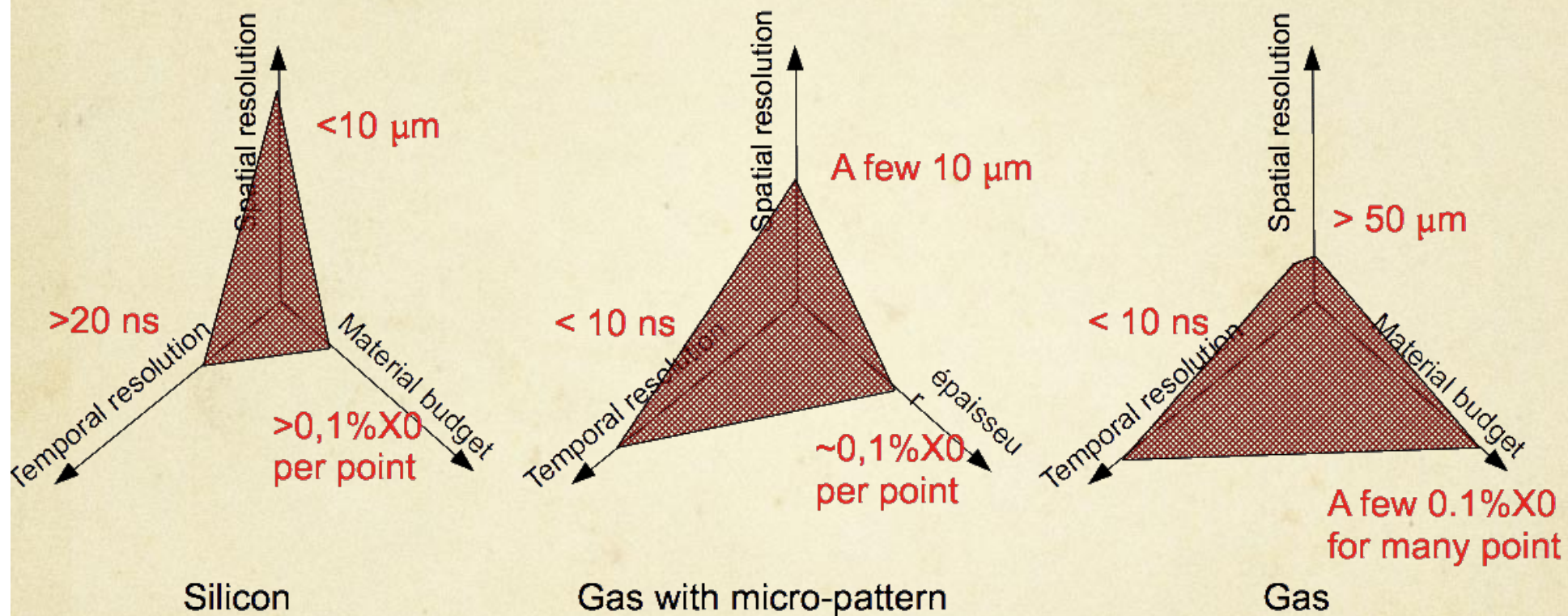

○ Solenoid

- Field depends on current I , length L , # turns N
 - on the centerline
$$B = \frac{\mu_0 NI}{\sqrt{L^2 + 4R^2}}$$
 - Typically: 1 T needs 4 to 8 kA
 - **superconducting** metal to limit heat
- Field uniformity needs flux return (iron structure)
 - Mapping is required for fitting (remember $B(\mathbf{x})$?)
 - Usually performed with numerical integration
- Calorimetry outside → limited material → **superconducting**
- Fringe field calls for compensation

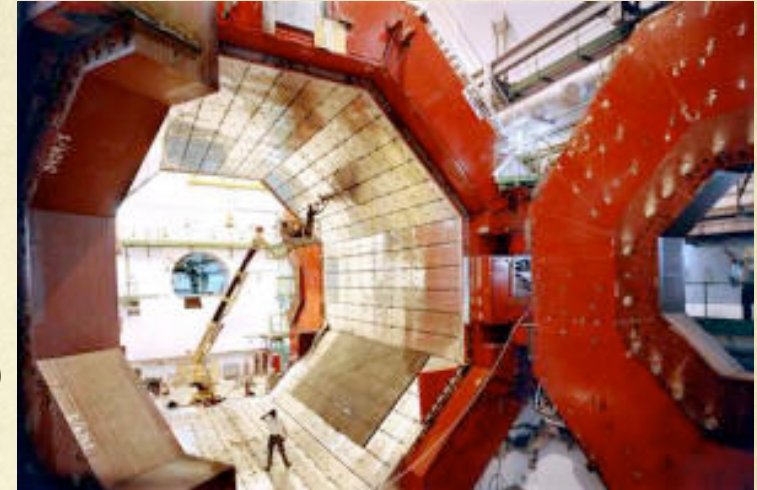

	Field (T)	Radius (m)	Length (m)	Energy (MJ)
ALICE	0.5	6		150
ATLAS	2	2.5	5.3	700
CMS	4	5.9	12.5	2700
ILC	4	3.5	7.5	2000

○ Superconduction

- cryo-operation → quenching possible !
- Magnetic field induces energy: $E \propto B^2 R^2 L$
 - Cold mass necessary to dissipate heat in case of quench

2. Detector Technologies:

Practical considerations

○ From a detection principle to a detector

- Build large size or many elements
 - Manufacture infrastructures
 - Characterization capabilities
 - Production monitoring

- Integration in the experiment
 - Mechanical support
 - Electrical services (powering & data transmission)
 - Cooling (signal treatment dissipates power)

- Specific to trackers
 - Internal parts of multi-detectors experiment
→ limited space
 - Material budget is ALWAYS a concern
 - ⇒ trade-offs required

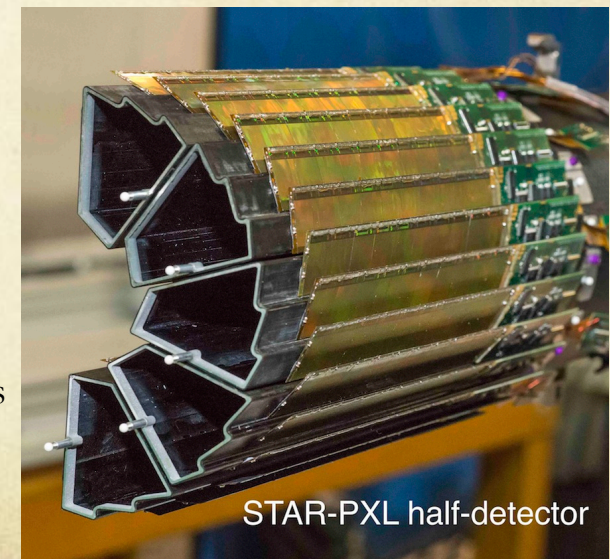
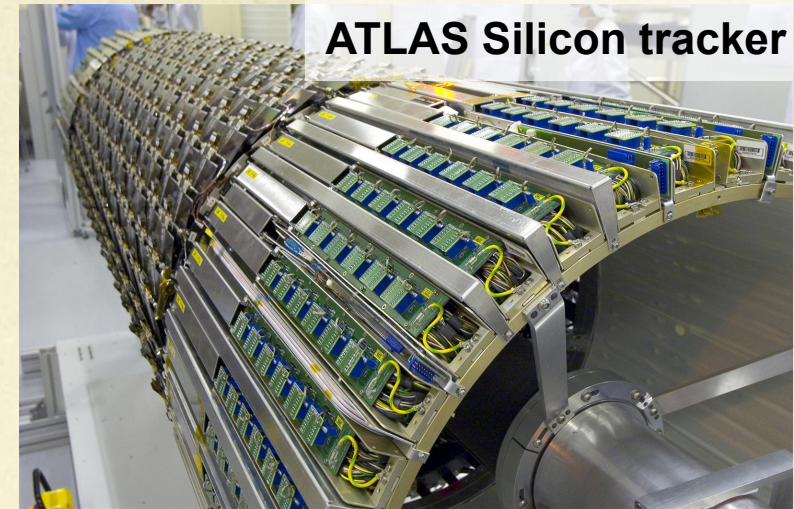

○ Silicon drift detectors

- Real 2D detectors made of strips
- 1D is given by drift time

○ Diamond detectors

- Could replace silicon for hybrid pixel detectors
- Very interesting for radiation tolerance

○ Plasma sensor panels

- Derived from flat television screen
- Still in development

○ Charge Coupled Devices (CCD)

- Fragile/ radiation tolerance

○ Signal generation

- see Ramo's theorem

○ DEPFET

- Depleted Field Effect Transistor detector
- Real 2D and partly monolithic

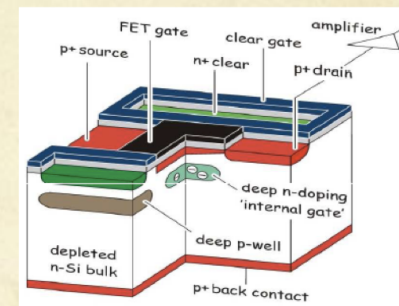

○ Nuclear emulsions

- One of the most precise $\sim 1\mu\text{m}$
- No timing information → very specific applications

○ Scintillators

- Extremely fast (100 ps)
- Could be arranged like straw tubes
- But quite thick ($X_0 \sim 2\text{ cm}$)

3. Standard algorithms

- Finders
- First evaluation of momentum resolution
- Fitters
- Alignment

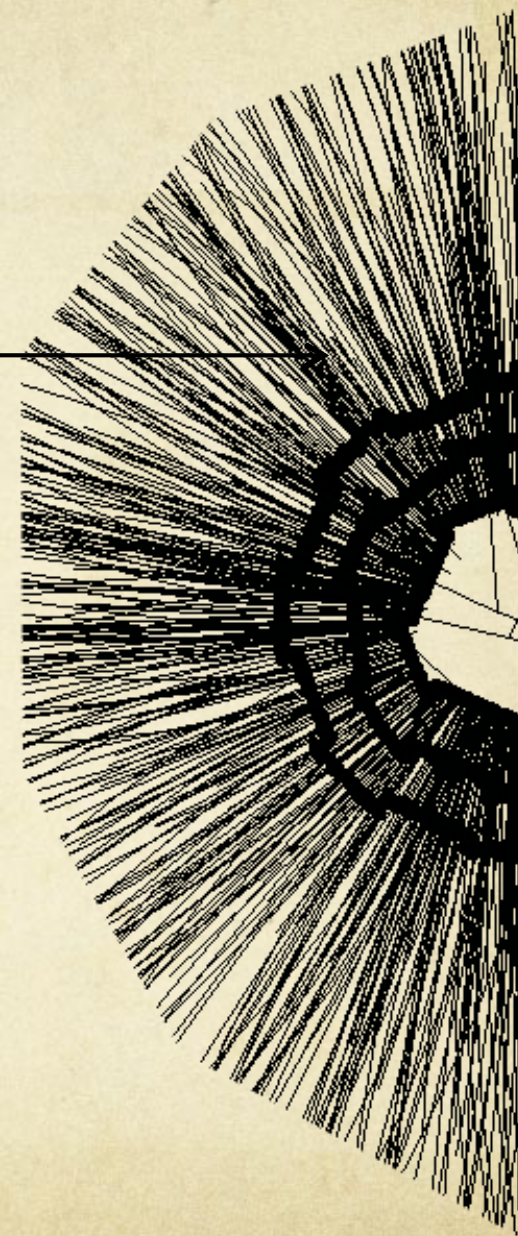

○ Global methods

- Transform the coordinate space into **pattern space**
 - “pattern” = parameters used in track model
- Identify the “best” solutions in the new phase space
- Use all points at a time
 - No history effect
- Well adapted to evenly distributed points with same accuracy

○ Local methods

- Start with a **track seed** = restricted set of points
 - Could require good accuracy from the beginning
- Then extrapolate to next layer-point
 - And so on...**iterative procedure**
- “Wrong” solutions discarded at each iteration
- Possibly sensitive to “starting point”
- Well adapted to redundant information

**FINDING drives
tracking efficiency**

3. Standard algorithms:

Track model

○ A simple example

- Straight line in 2D: model is $x = a \cdot z + b$
- Track parameters (a, b) ; N measurements x_i at z_i ($i=1..N$)

○ A more complex example

- Helix in 3D with magnetic field
- Track parameters $(\phi, z, D, \tan \lambda, C)$
- Measurements (ϕ, z)

$$\phi(r) = \gamma_0 + \arcsin \frac{Cr + (1 + CD)D/r}{1 + 2CD}$$
$$z(r) = z_0 + \frac{\tan \lambda}{C} \arcsin \left(C \sqrt{\frac{r^2 - D^2}{1 + 2CD}} \right)$$

○ Generalization

- Parameters: P-vector \mathbf{p}
- Measurements: N-vector \mathbf{c}
- Model: function $f(\mathcal{R}^P \rightarrow \mathcal{R}^N)$

$$f(\mathbf{p}) = \mathbf{c}$$

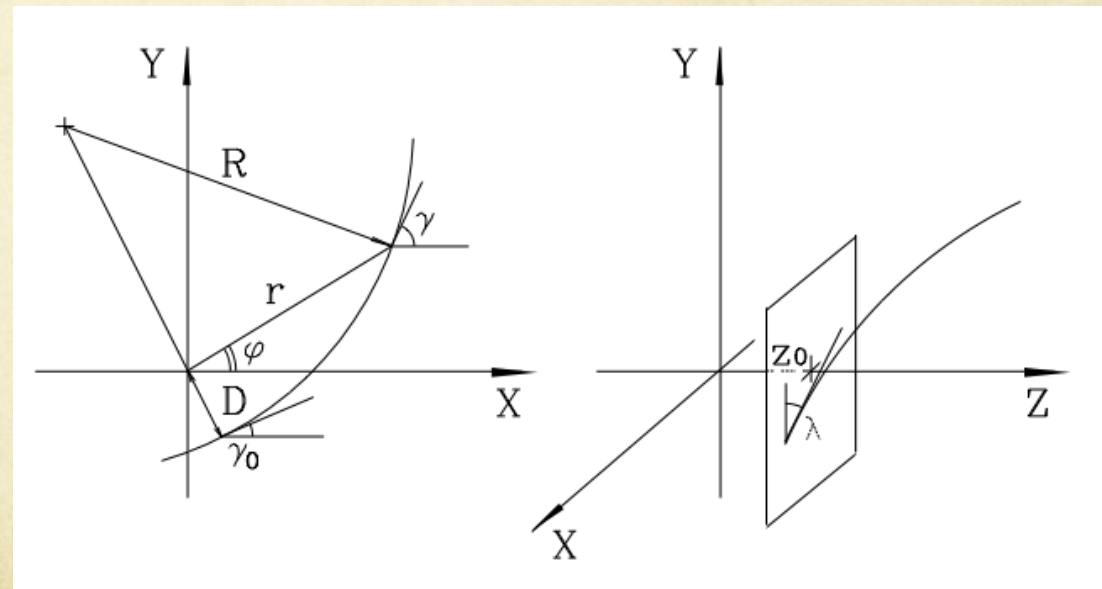

3. Standard algorithms:

Local method 1/2

○ Track seed = initial segment

- Made of few (2 to 4) points
 - One point could be the expected primary vtx
- Allows to initialize parameter for track model
- Choose most precise layers first
 - usually inner layers
- But if high hit density
 - Start farther from primary interaction @ lowest density
 - Limit mixing points from different tracks

○ Extrapolation step

- Out or inward (=toward primary vtx) onto the next layer
- Not necessarily very precise, especially **only local model** needed
 - Extrapolation uncertainty \lesssim layer point uncertainty
 - Computation speed important
- Match (associate) nearest point on the new layer
 - Might skip the layer if point missing
 - Might reject a point: if worst track-fit or if fits better with another track

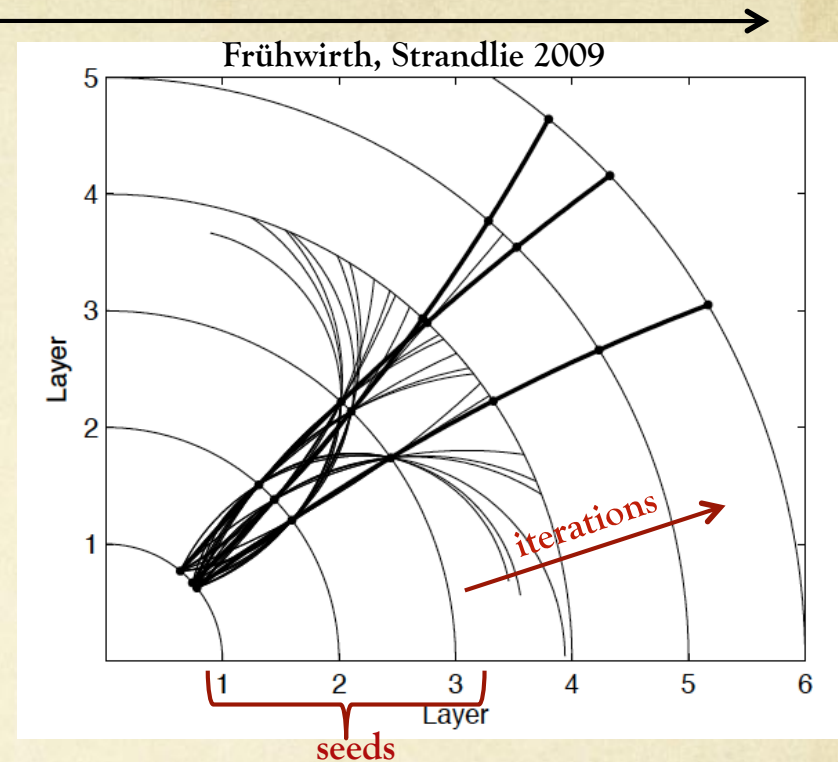

○ Variant with track segments

- First build “tracklets” on natural segments
 - Sub-detectors, or subparts with same resolution
- Then match segments together
- Typical application:
 - Segments large tracker (TPC) with vertex detector (Si)
 - layers dedicated to matching

○ Variant with track roads

- Full track model used from start

○ Variant with Kalman filter

- See later

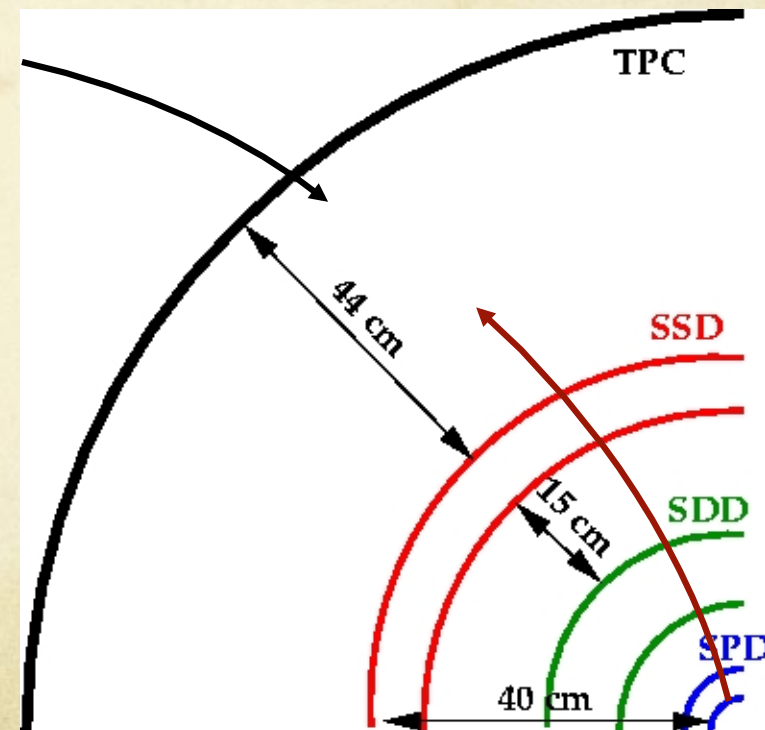

○ Brute force = combinatorial way

- Consider all possible combination of points to make a track
- Keep only those compatible with model
- Usually too time consuming...

○ Hough transform

→ Example straight track:

- Coord. space $y = a*x + b \Leftrightarrow$ pattern space $b = y - x*a$
- Each point (y,x) defines a line in pattern space
- All lines, from points belonging to same straight-track, cross at same point (a,b)
- In practice:
discretize pattern space and search for maximum
- Applicable to circle finder
 - needs two parameters as well (r, ϕ) of center
if track is assumed to originate from $(0,0)$
- More difficult for more than 2 parameters...

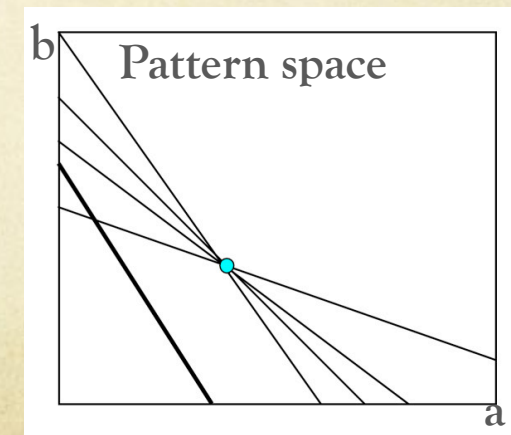
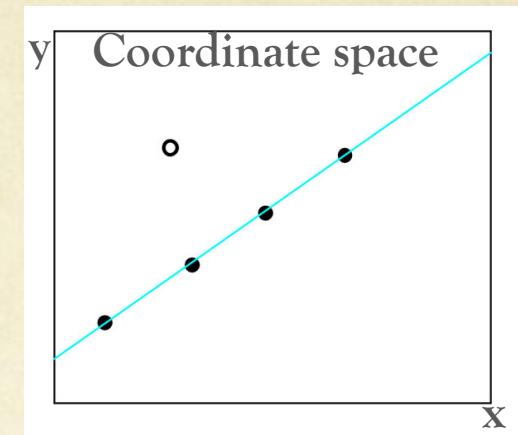

○ Conformal mapping

→ Helix transverse projection = Circle

- $(x-a)^2 + (y-b)^2 = r^2$
- Transform to $u = x/(x^2+y^2)$, $v = y/(x^2+y^2)$
- Then: $v = -(a/b) u + (1/2b)$

○ Why do we need to fit?

- Measurement error
- Multiple scattering error

○ Global fit

- Assume knowledge of:
 - all track points
 - full correlation matrix
 - difficult if $\sigma_{\text{mult. scatt.}} \gtrsim \sigma_{\text{meas.}}$
- Least square method

○ Iterative fit

- Iterative process:
 - points included in the fit one by one
 - could be merged with finder step
- Kalman filter

**FITTING drives
track extrapolation
& momentum res.**

○ Linear model hypothesis

- P track parameters \mathbf{p} , with N measurements c (could be 2xM coordinates)

$$\vec{c} = \vec{c}_s + A(\vec{p} - \vec{p}_s) + \vec{\varepsilon}$$

- \mathbf{p}_s = known starting point, **A = track model** NxP matrix,
 ε = error vector corresponding to \mathbf{V} = covariance NxN matrix

○ Sum of squares:

$$\sum \frac{(\text{model} - \text{measure})^2}{\text{uncertainty}^2} \quad \longrightarrow \quad S(\vec{p}) = (\vec{c}_s + A(\vec{p} - \vec{p}_s) - \vec{c})^T V^{-1} (\vec{c}_s + A(\vec{p} - \vec{p}_s) - \vec{c})$$

○ Best estimator (minimizing variance)

$$\frac{dS}{d\vec{p}}(\vec{p}) = 0 \quad \longrightarrow \quad \underline{\vec{p}} = \vec{p}_s + (A^T V^{-1} A)^{-1} A^T V^{-1} (\vec{c} - \vec{c}_s)$$

- Variance (= uncertainty) of the estimator: $\underline{V}_{\vec{p}} = (A^T V^{-1} A)^{-1}$

- Estimator \mathbf{p} follows a χ^2 law with N-P degrees of freedom

○ Problem \Leftrightarrow inversion of a PxP matrix ($A^T V^{-1} A$)

- But real difficulty could be computing \mathbf{V} (NxN matrix)

← layer correlations if multiple scattering non-negligible if $\sigma_{\text{mult. scatt.}} \gtrsim \sigma_{\text{meas}}$

3. Standard algorithms:

Kalman filter 1/2

○ Dimensions

- P parameters for track model
- D measurements at each point (usually $D < P$)
- K measurement points ($N = K \times D$)

○ Starting point

- Initial set of parameters: first measurements
- With large uncertainties if unknowns

○ Iterative method

- Propagate to next layer = prediction
 - Using the **system equation** $\vec{p}_k = G \vec{p}_{k-1} + \vec{\omega}_k$
 - $G = P \times P$ matrix, ω = perturbation associated with covariance $P \times P$ matrix V_ω
 - Update the covariance matrix with additional uncertainties $V_{k|k-1} = V_{k-1} + V_{\omega_k}$
(ex: material budget between layers)
- Add new point to update parameters and covariance, using the **measure equation** $\vec{m}_k = H \vec{p}_k + \vec{\epsilon}_k$
 - $H = D \times P$ matrix, ϵ = measure error associated with **diagonal** covariance $D \times D$ matrix V_m
 - Weighted means of prediction and measurement using variance $\Leftrightarrow \chi^2$ fit
- Iterate...

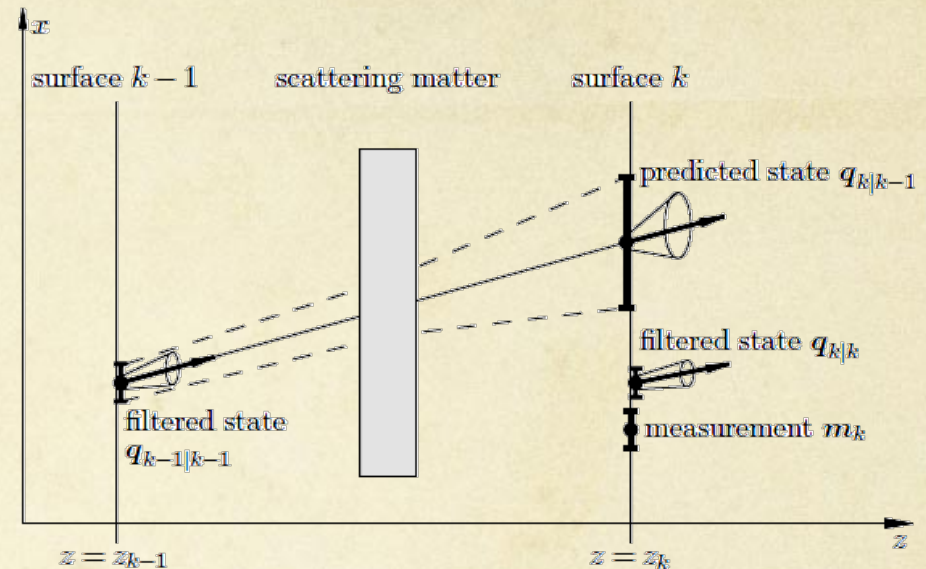

$$\vec{p}_k = \left(V_{k|k-1}^{-1} \vec{p}_{k|k-1} + H^T V_{m_k}^{-1} \vec{m}_k \right) \cdot \left(V_{k|k-1}^{-1} + H^T V_{m_k}^{-1} H \right)^{-1}$$

○ Forward and backward filters

- Forward estimate of \vec{p}_k : from 1 → k-1 measurements
- Backward estimate of \vec{p}_k : from k+1 → K measurements
- Independent estimates → combination with weighted mean = smoother step

○ Computation complexity

- only PxP, DxP or DxD matrices computation ($\ll N \times N$)

○ Mixing with finder

- After propagation step: local finder
- Some points can be discarded if considered as outliers in the fit (use χ^2 value)

○ Include exogenous measurements

- Like dE/dx, correlated to momentum
- Additional measurement equation $\vec{m}'_k = H' \vec{p}_k + \vec{\varepsilon}'_k$

$$\vec{p}_k = \left(V_{k|k-1}^{-1} \vec{p}_{k|k-1} + H^T V_{m_k}^{-1} \vec{m}_k + H'^T V_{m'_k}^{-1} \vec{m}'_k \right) \cdot \left(V_{k|k-1}^{-1} + H^T V_{m_k}^{-1} H + H'^T V_{m'_k}^{-1} H' \right)^{-1}$$

3. Standard algorithms:

Alignment strategy

○ Let's come back to one initial & implicit hypothesis

- “We know where the points are located.”
- True to the extent we know where the detector is!
- BUT, mechanical instability (magnetic field, temperature, air flow...) and also drift speed variation (temperature, pressure, field inhomogeneity...) limit our knowledge
- Periodic determination of positions and deformations needed = alignment

○ Methods

- Track model depends on new “free” parameters, i.e. the alignment

- **Global alignment:**

- Fit the new params. to minimize the overall χ^2 of a set of tracks (Millepede algo.)
- Beware: many parameters could be involved (few 10^3 can easily be reached)

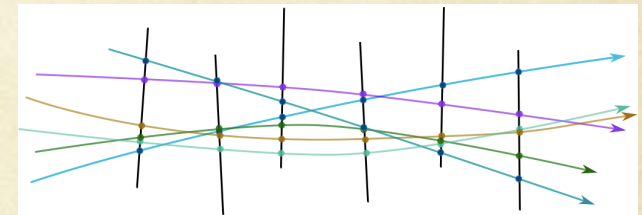

- **Local alignment:**

- Use tracks reconstructed with reference detectors
 - Align other detectors by minimizing the “residual” (track-hit distance) width
- Use a set of well known tracks and tracking-“friendly” environment to avoid bias

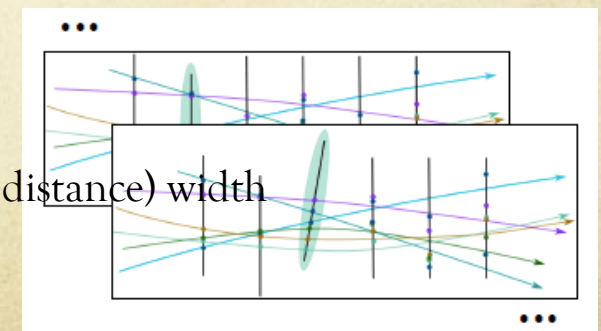

4. Advanced methods

- Why ?
- (Gaussian sum filter: *not treated yet*)
- Neural network
- Cellular automaton

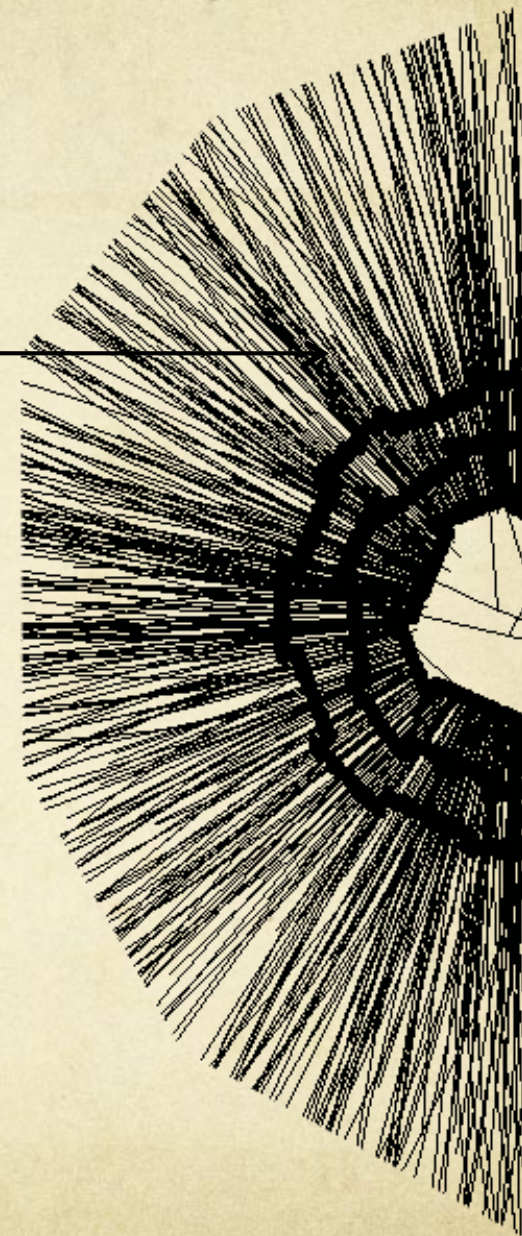

4. Advanced methods

Adaptive methods

- Shall we do better?
 - Higher track/vertex density, less efficient the classical method
 - Allows for many options and best choice
- Adaptive features
 - **Dynamic change** of track parameters during finding/fitting
 - Measurements are weighted according to their uncertainty
 - Allows to take into account several “normally excluded” info
 - **Many hypothesis are handled simultaneously**
 - But their number decrease with iterations (annealing like behavior)
 - Non-linearity
 - Often CPU-time costly (is that still a problem?)
- Examples
 - Neural network, Elastic nets, Gaussian-sum filters, Deterministic annealing

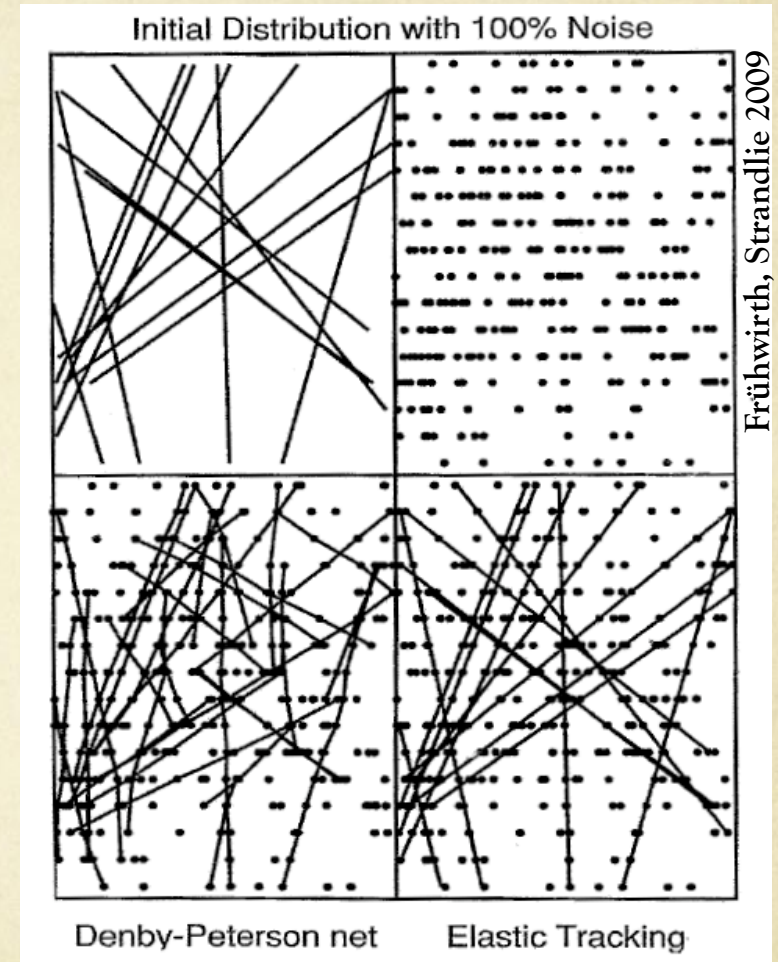

○ Cellular automaton

- Initialization
 - built any cell (= segment of 2 points)
- Iterative step
 - associate neighbour cells (more inner)
 - Raise “state” with associated cells
 - Kill lowest state cells

J. Lettenbichler *et al.*, 2013

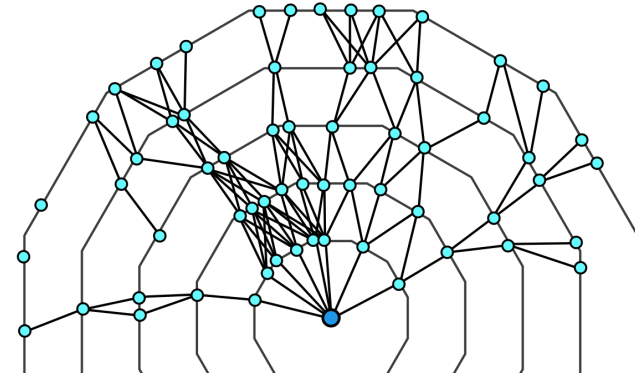

0 (black), 1 (red), 2 (orange), 3 (green), 4 (cyan)

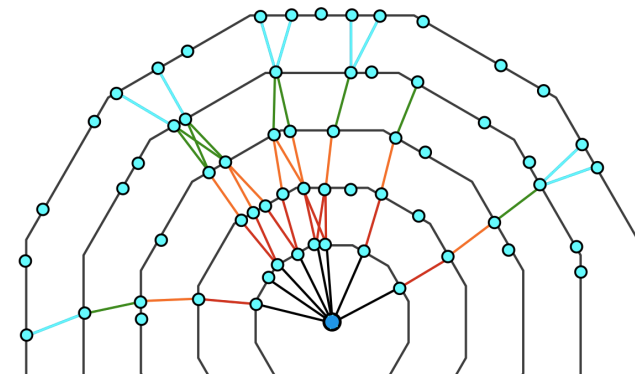
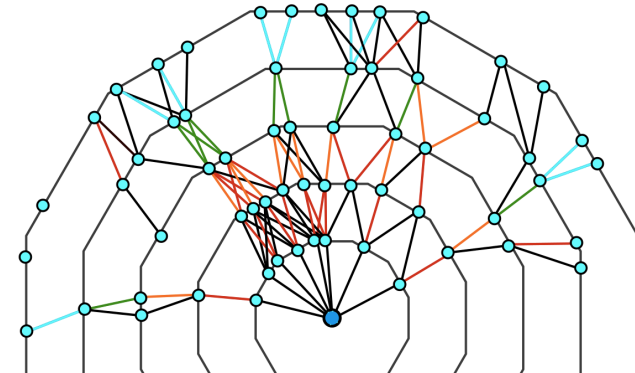

5. Deconstructing some tracking systems

- CMS (colliders)
- AMS, ANTARES (telescopes)

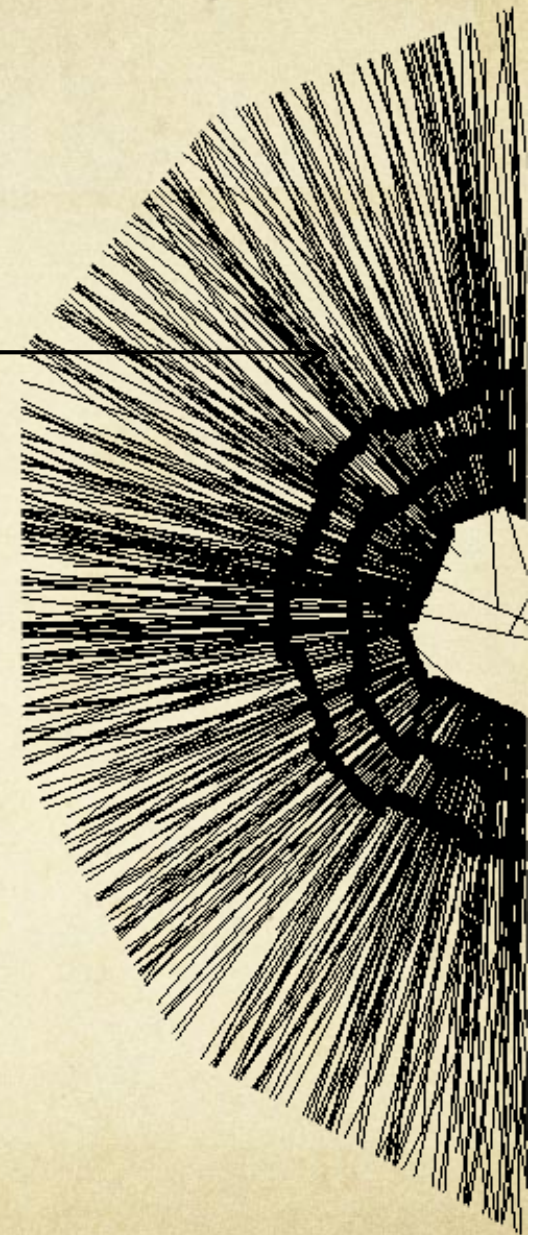

5. Some tracking systems:

CMS

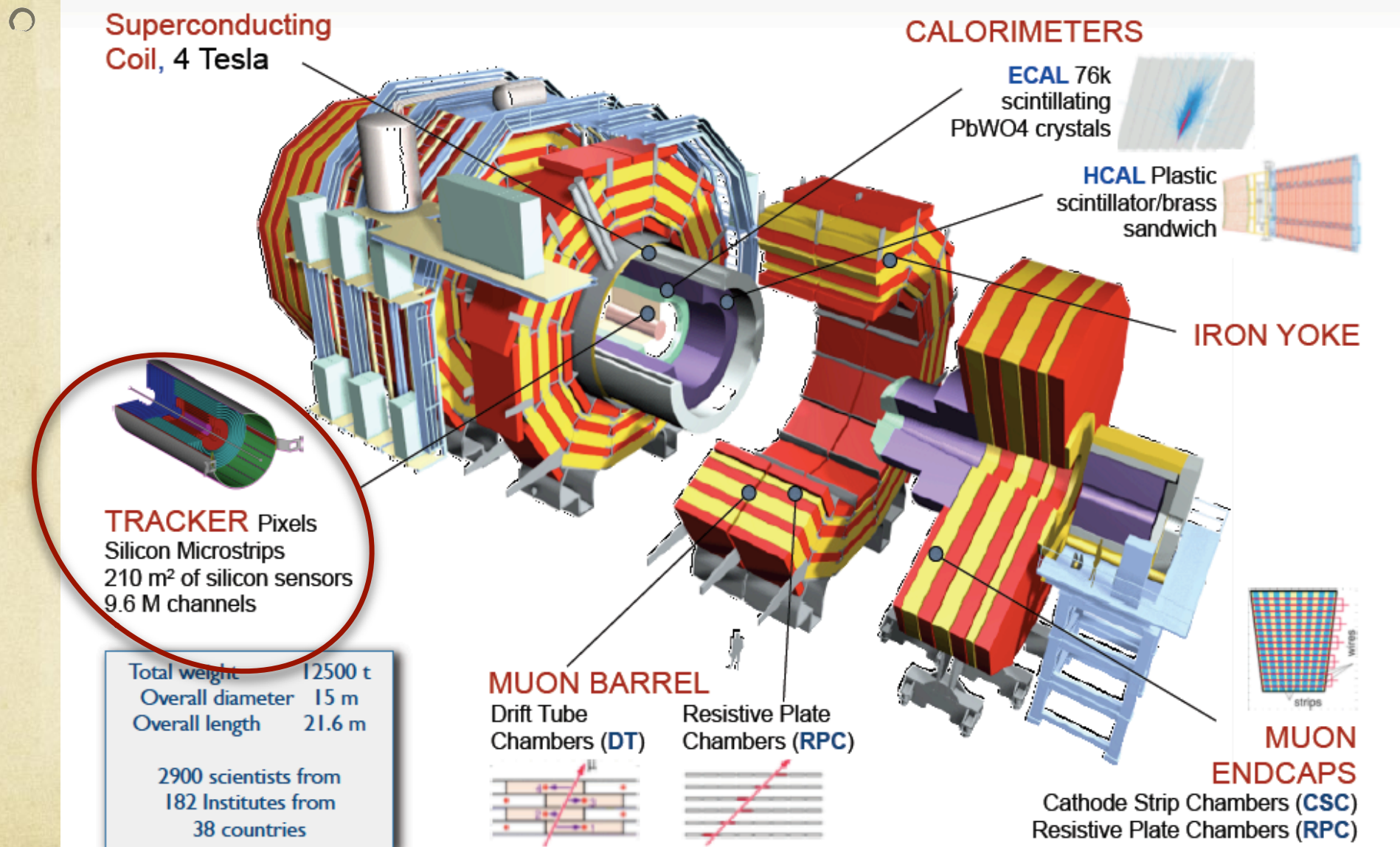

5. Some tracking systems:

CMS

○ The trackerS

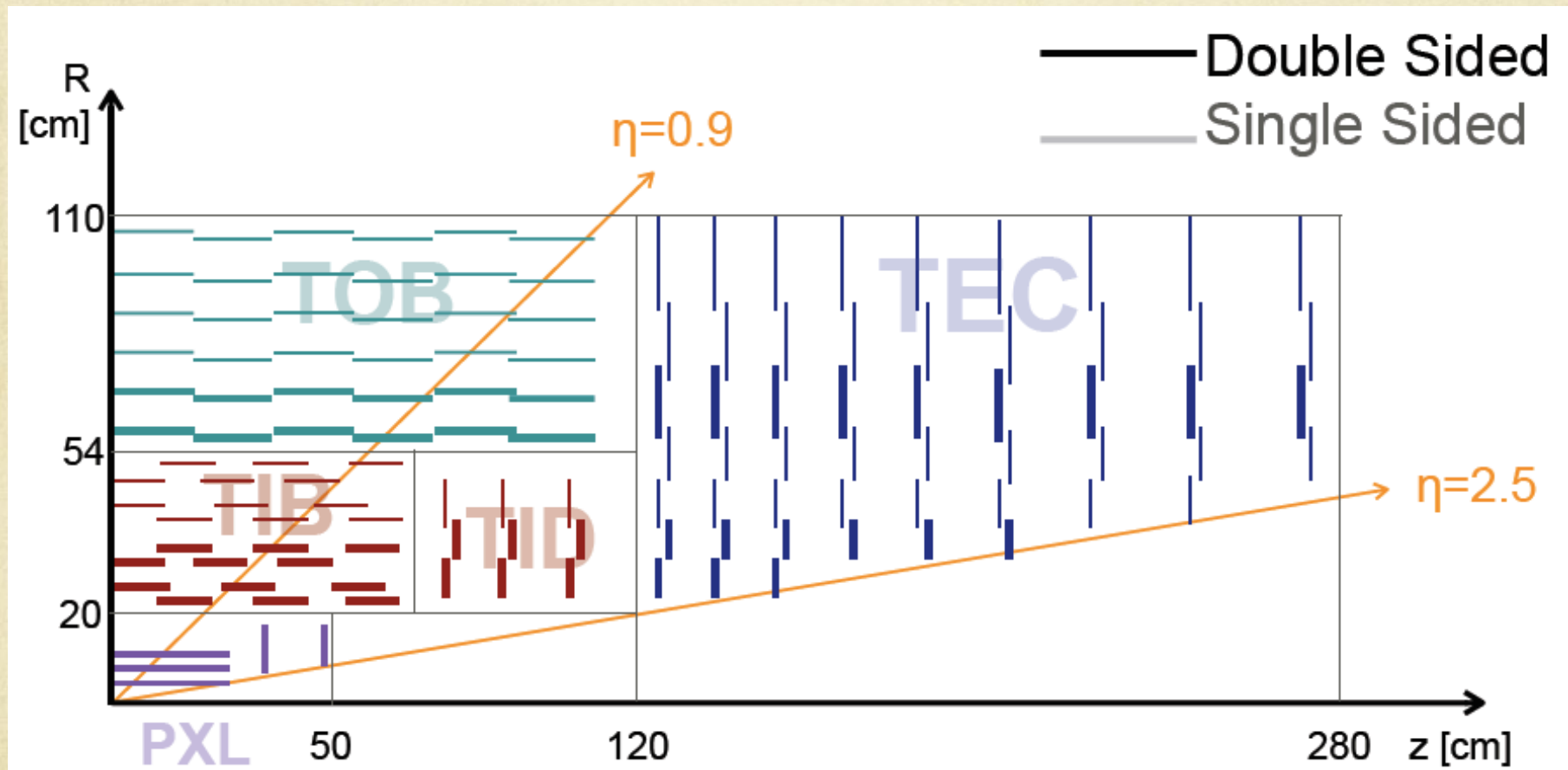

5. Some tracking systems:

CMS

○ Alignment residual width

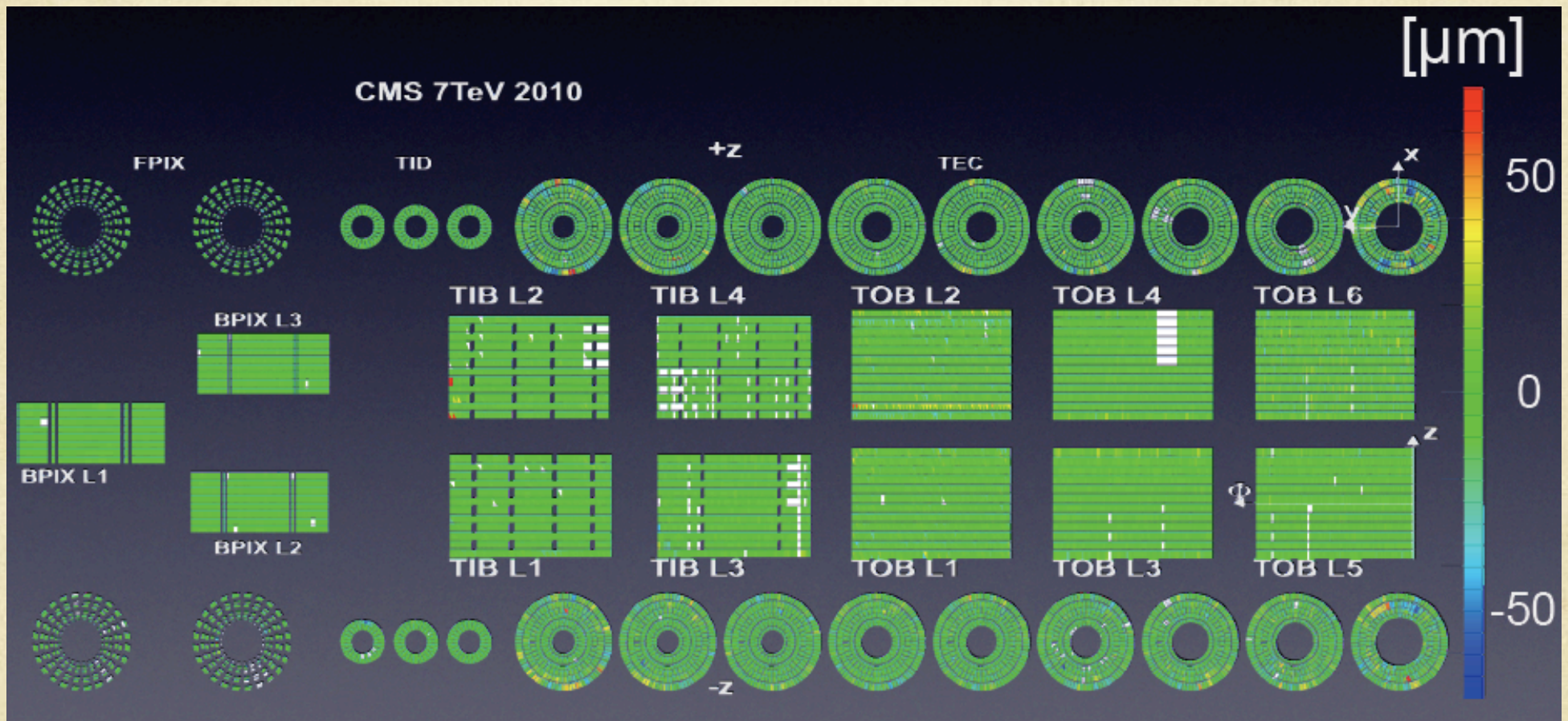

5. Some tracking systems:

CMS

- Taking a picture of the material budget
 - Using secondary vertices from $\gamma \rightarrow e^+e^-$
- Measuring it by data/simulation comparison

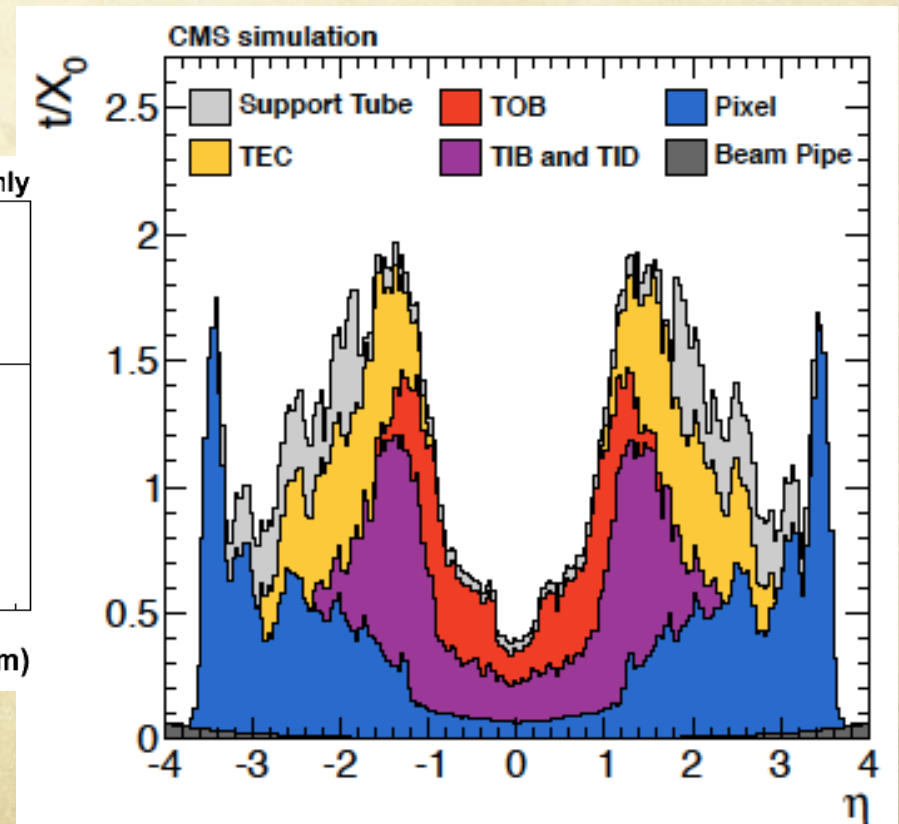
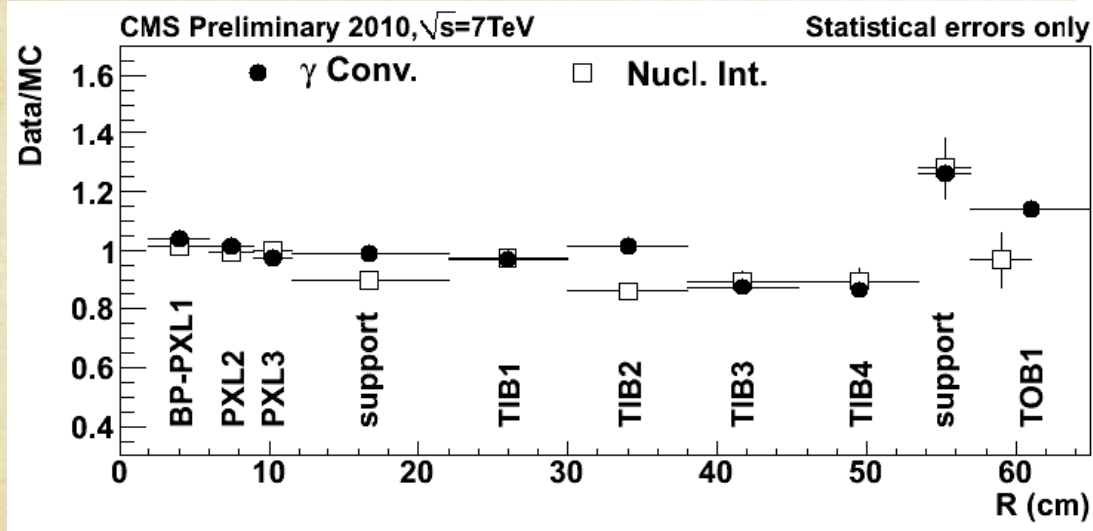
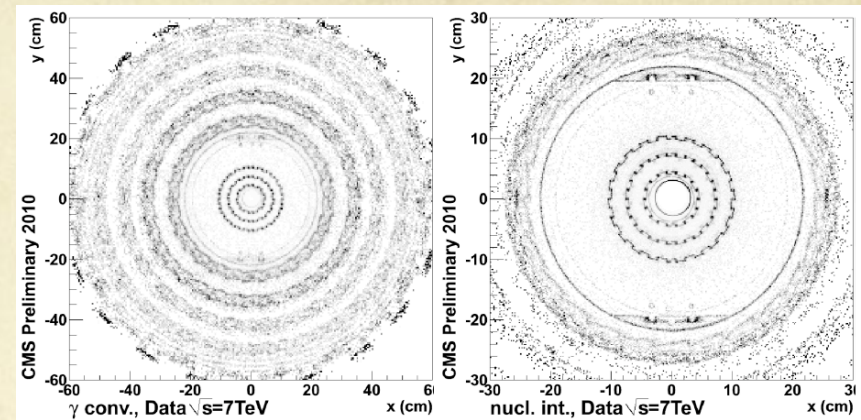

5. Some tracking systems:

CMS

- Tracking algorithm = multi-iteration process

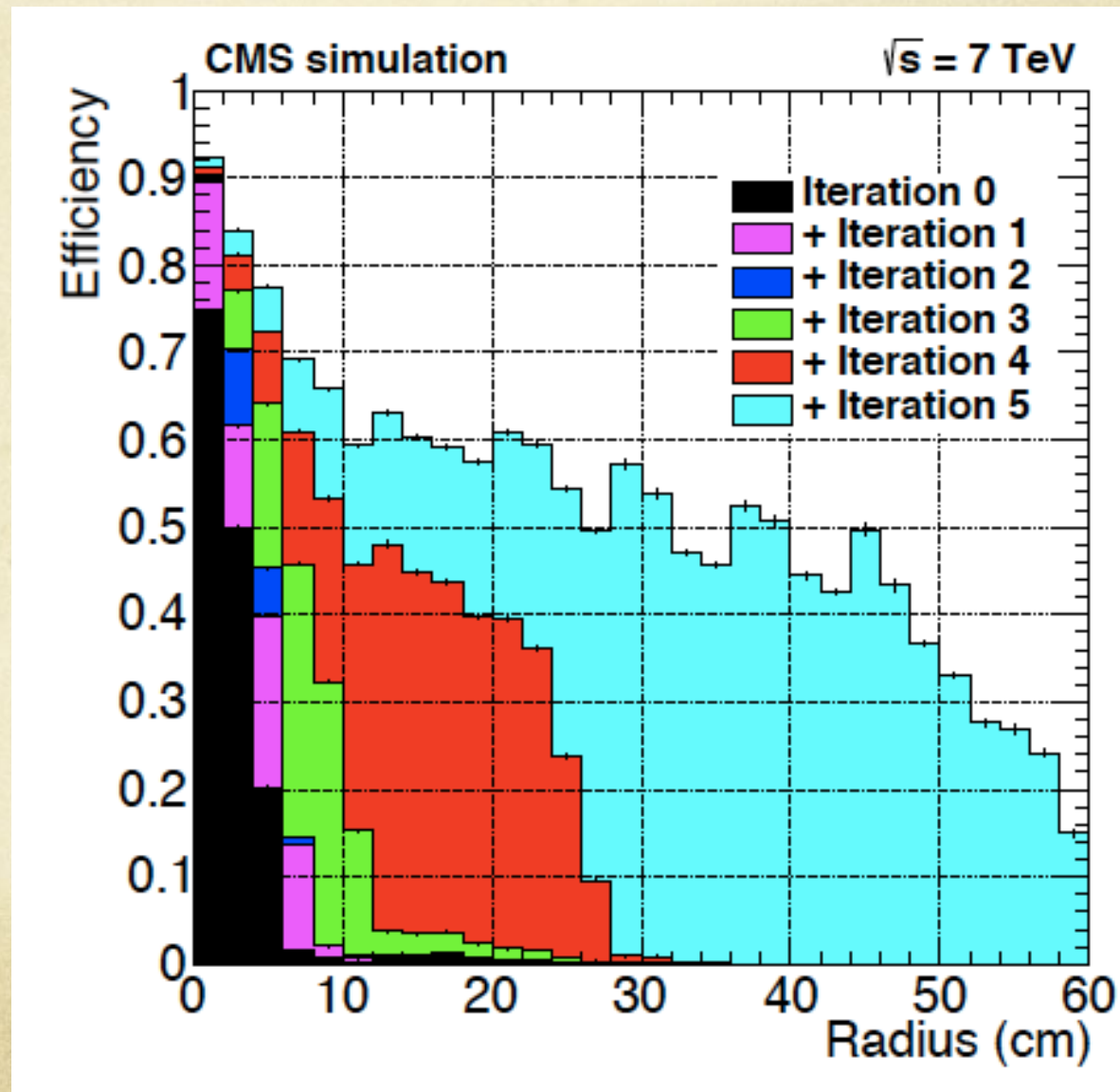

5. Some tracking systems:

CMS

○ Tracking efficiency

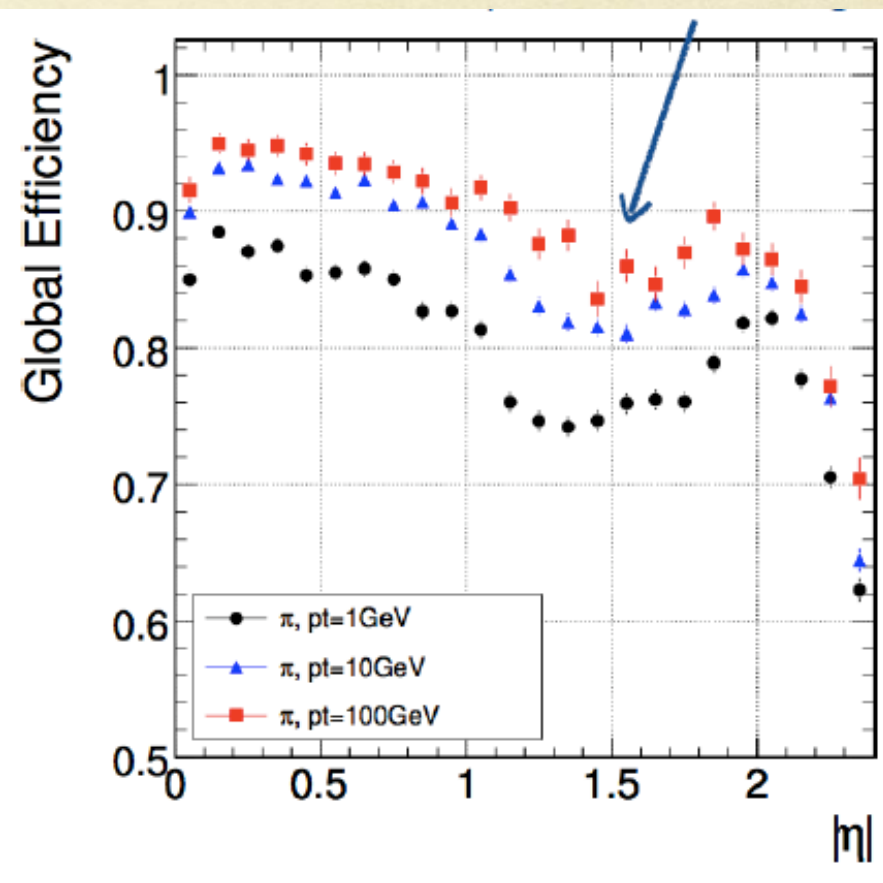
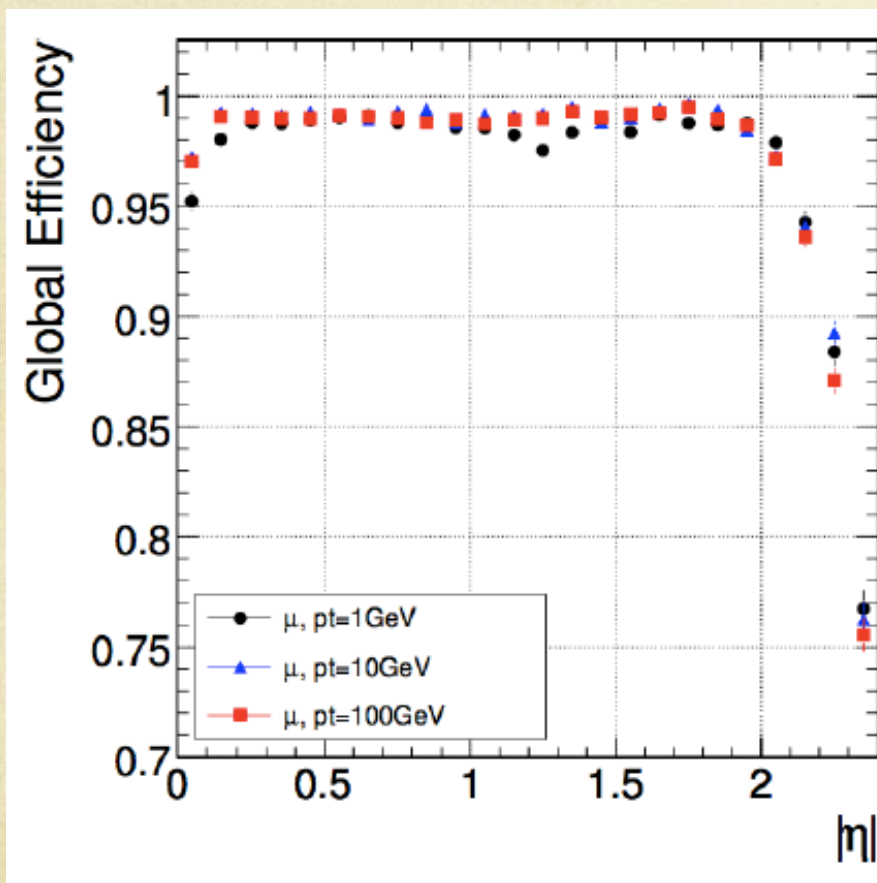

5. Some tracking systems:

CMS

○ Tracking resolution

d_0 = transverse impact parameter

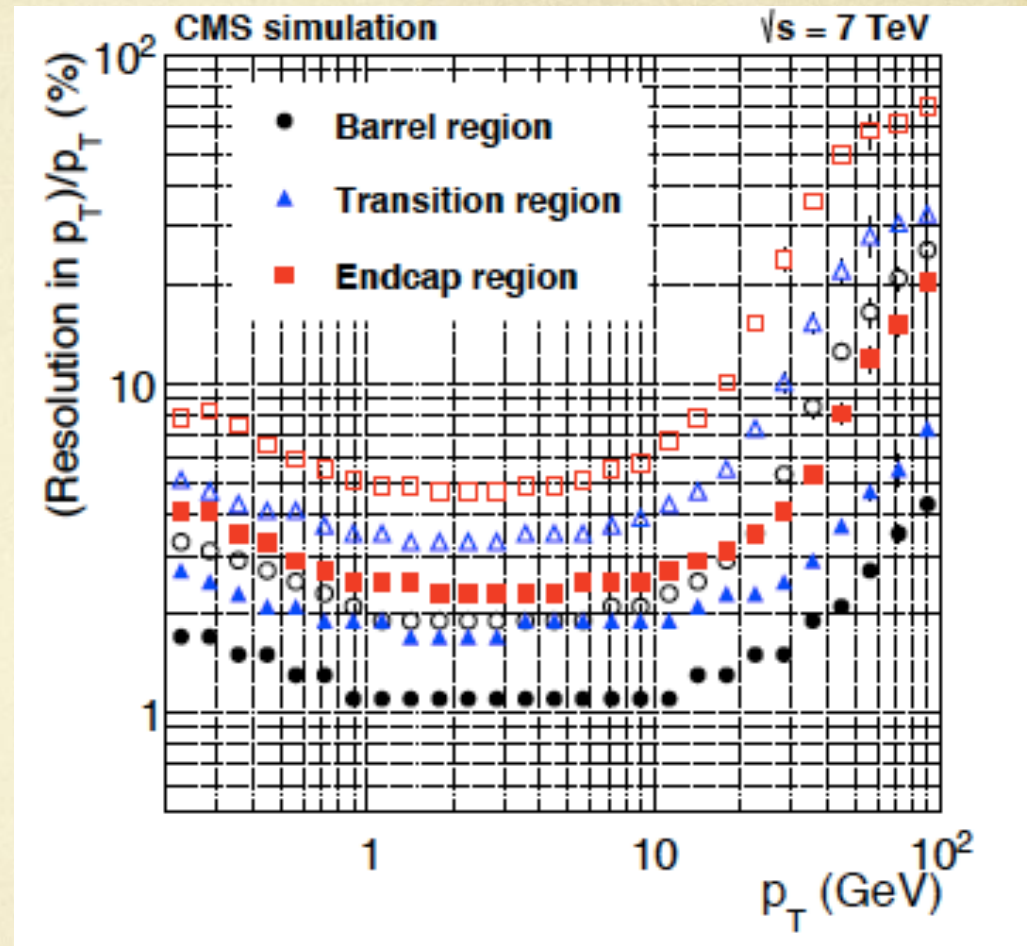
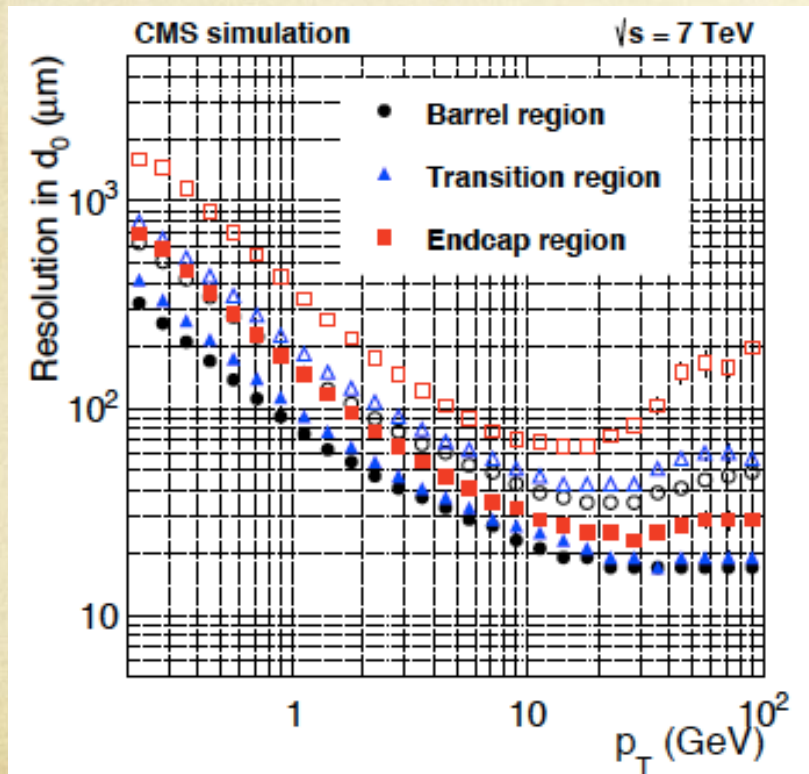

5. Some tracking systems:

CMS

○ Tracking resolution

ALICE figure

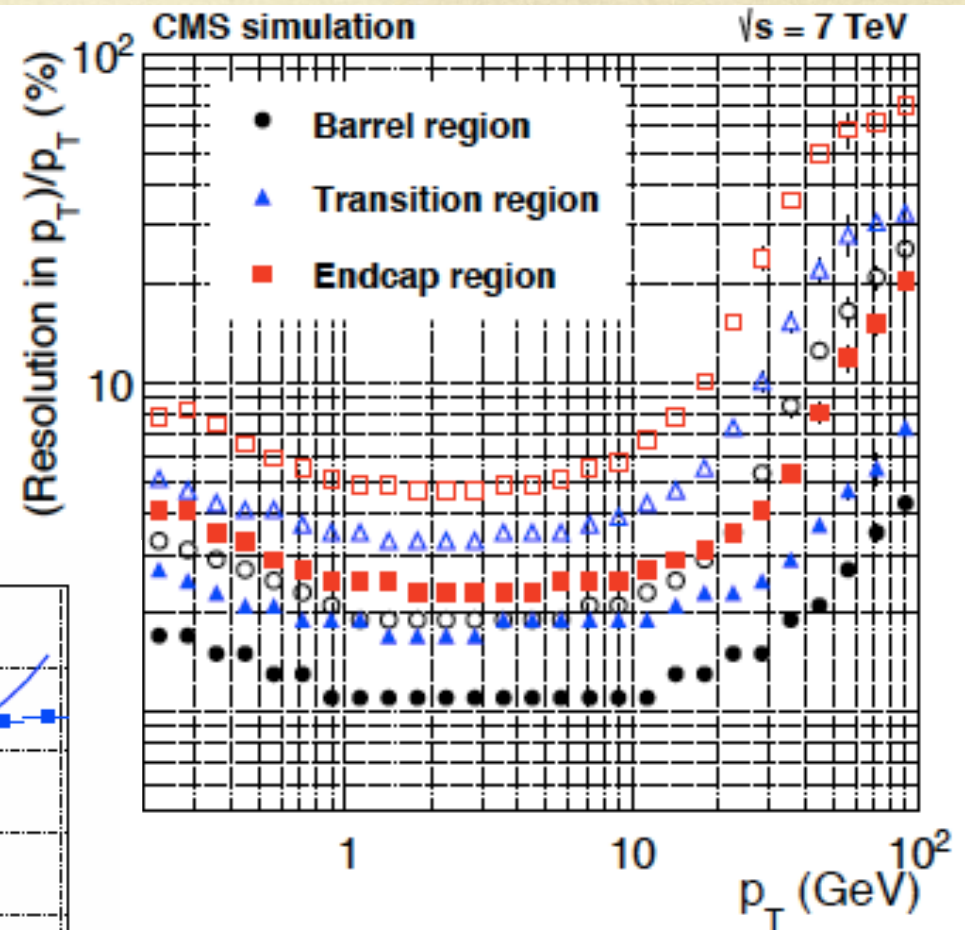
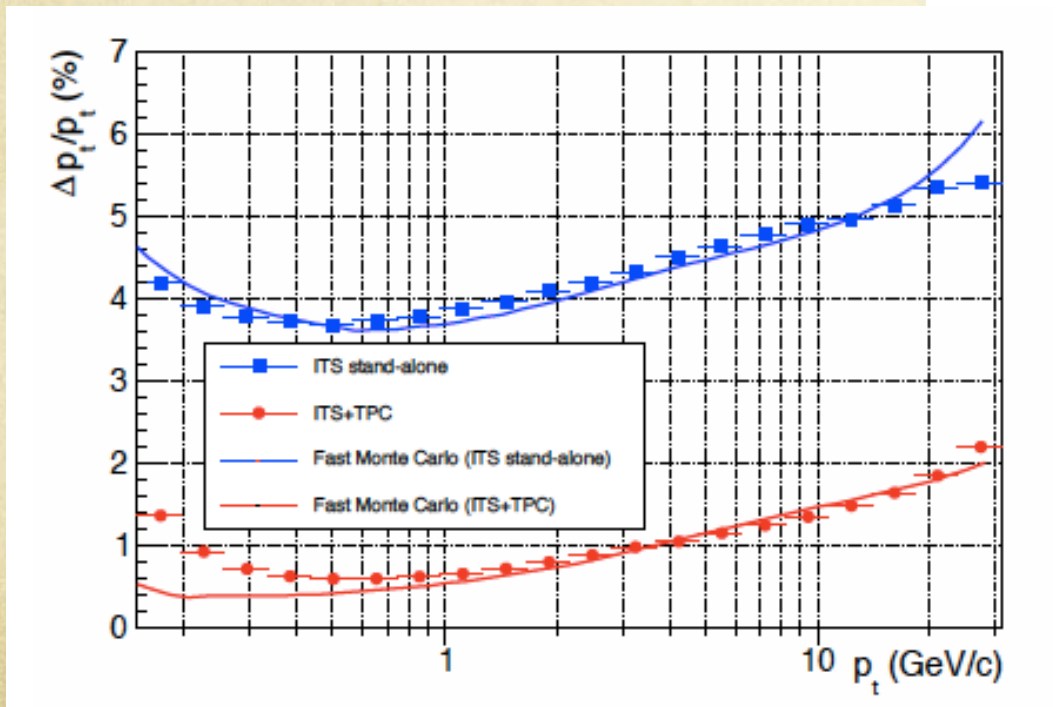

5. Some tracking systems:

Impact parameter resolution

$$\sigma_{IP} \propto \frac{\sqrt{R_{\text{ext}}^2 \sigma_{\text{int}}^2 + R_{\text{int}}^2 \sigma_{\text{ext}}^2}}{R_{\text{ext}} - R_{\text{int}}} \oplus \frac{R_{\text{int}} \sigma_{\theta(\text{ms})}}{p \sin^{3/2}(\theta)}$$

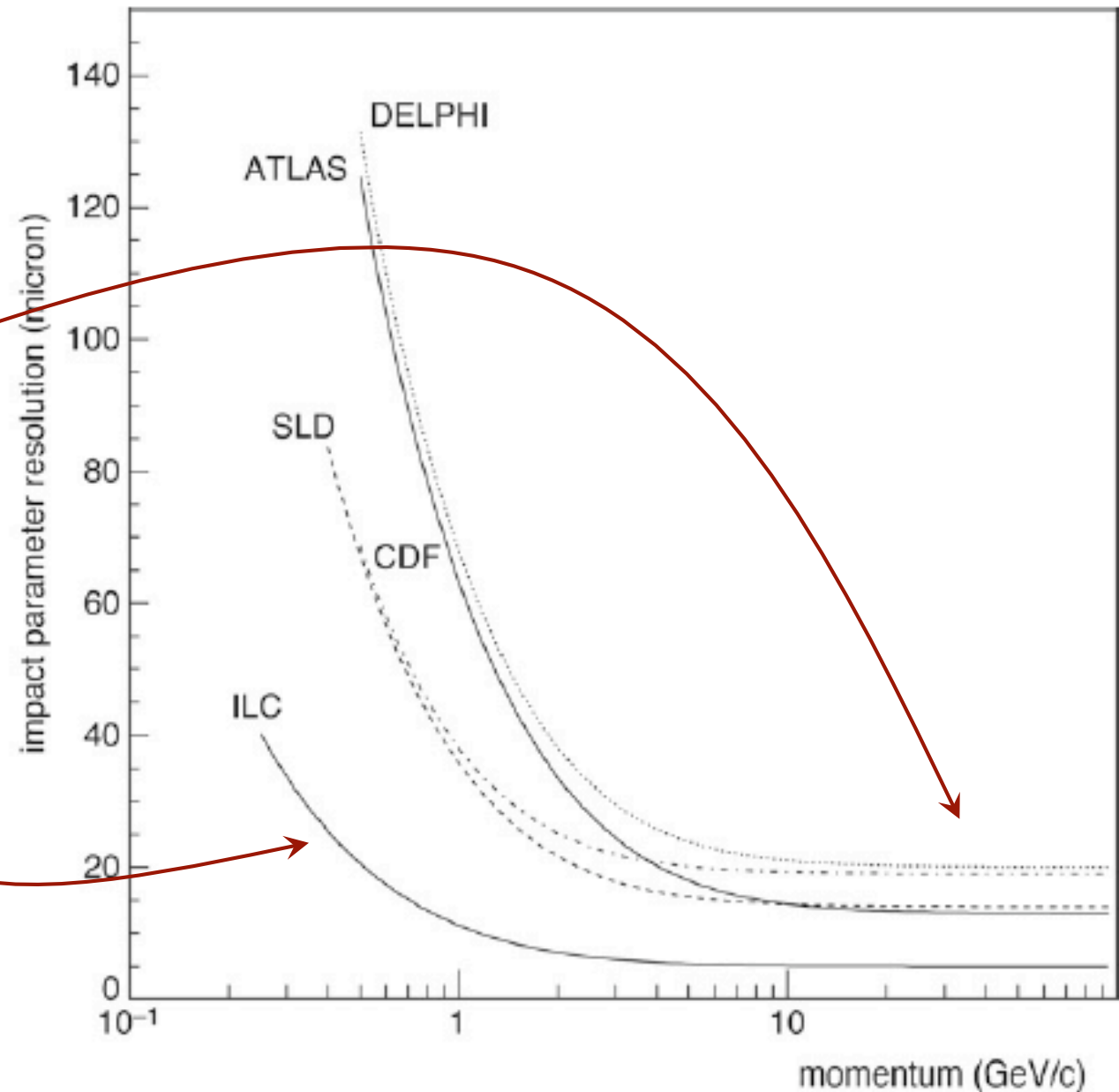

AMS: A TeV precision, multipurpose particle physics spectrometer in space.

Particles and nuclei are defined by their charge (Z) and energy ($E \sim P$)

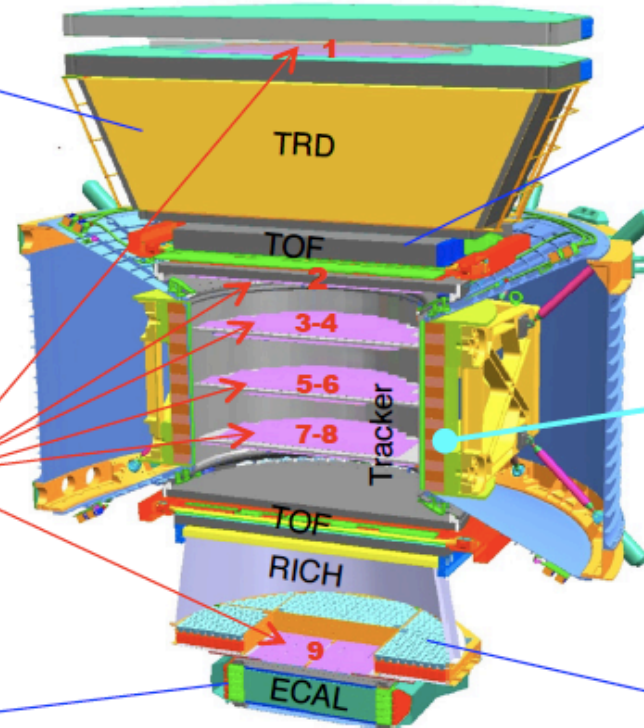
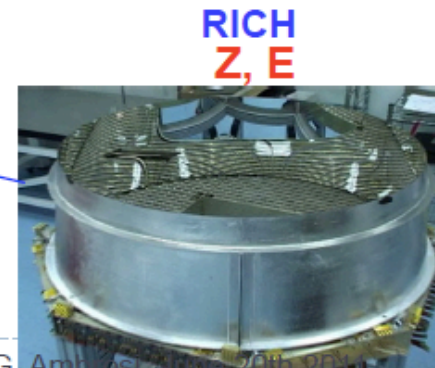
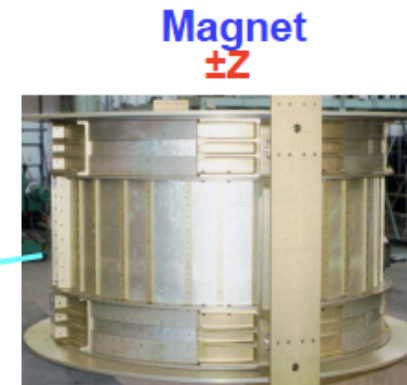
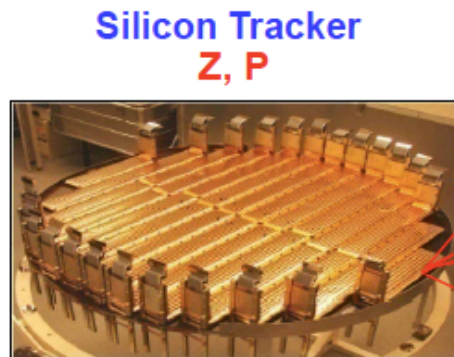
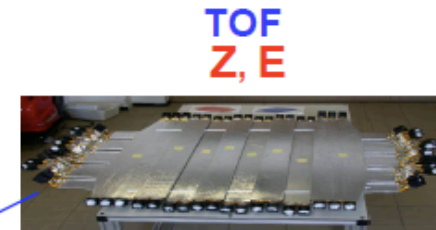
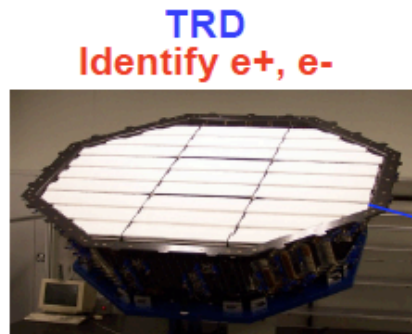

Z, P are measured independently by the Tracker, RICH, TOF and ECAL

G. Ambrosi, June 20th 2011

5. Some tracking systems:

AMS

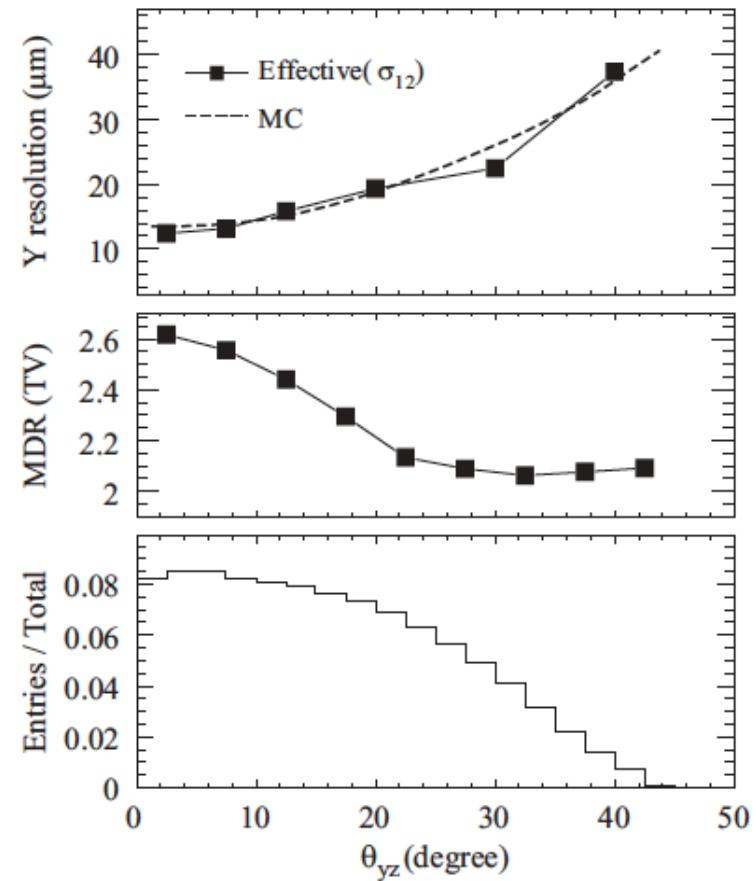
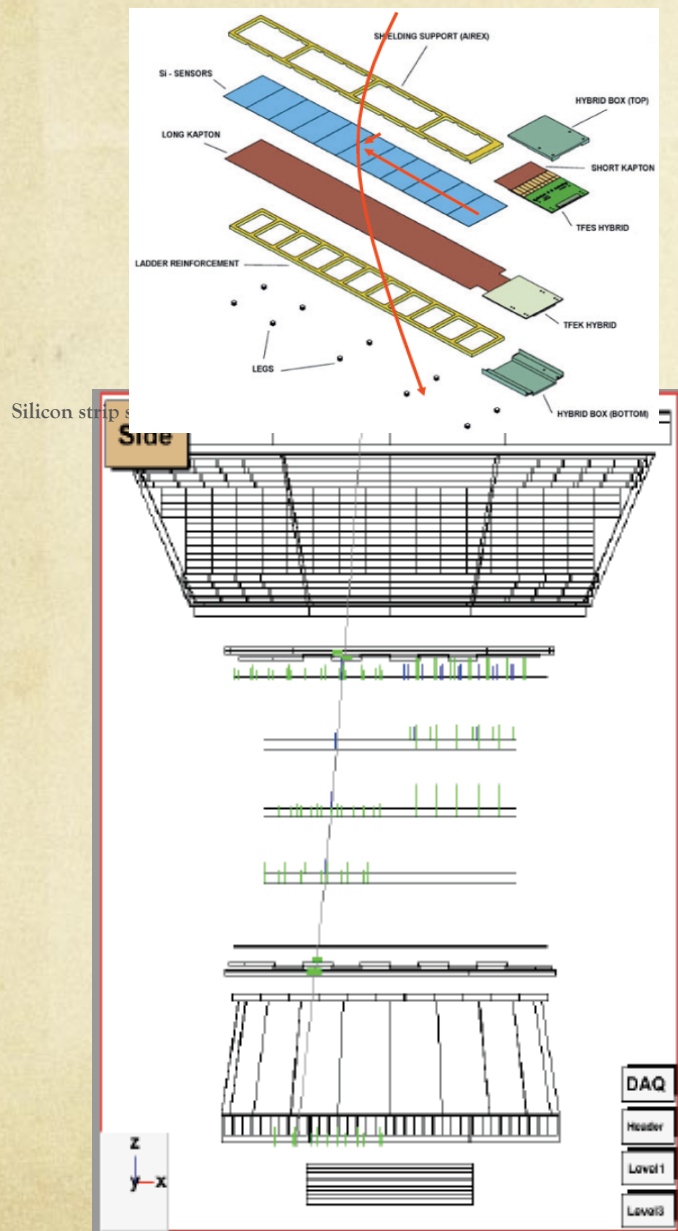
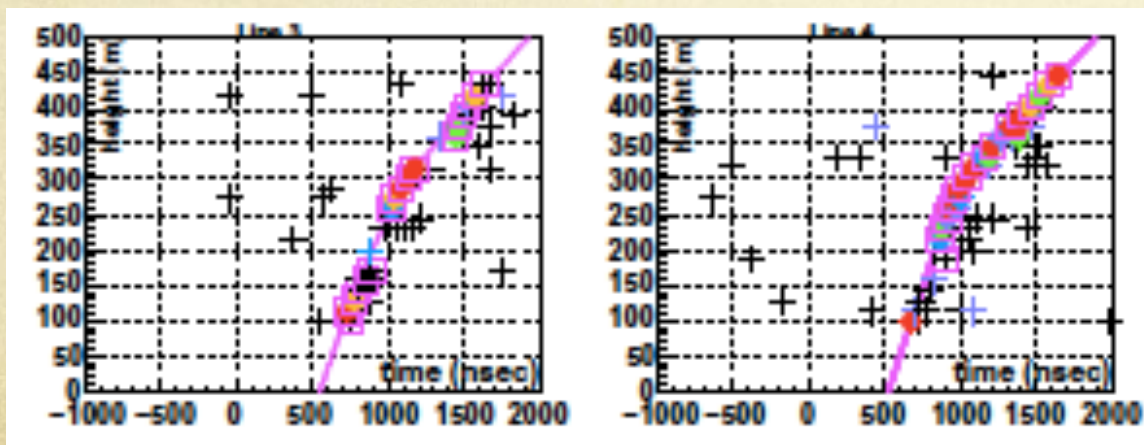
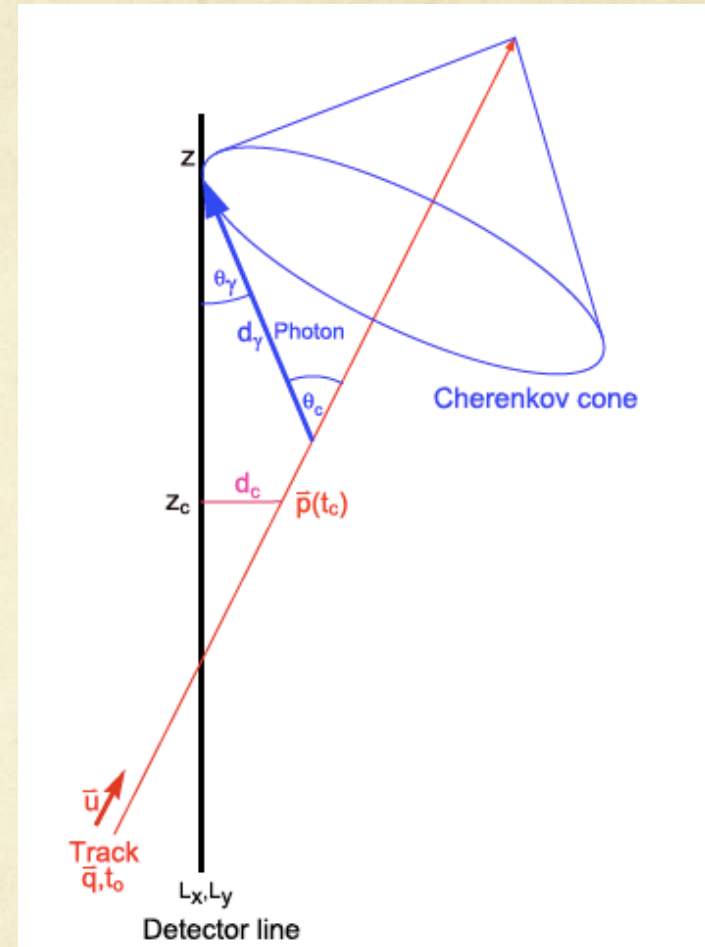
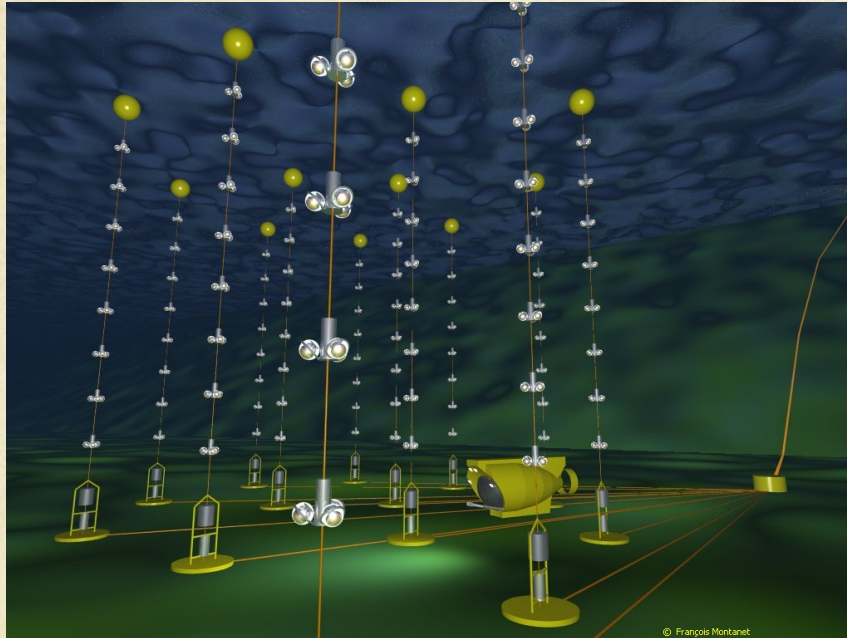

Fig. 5. The effective position resolution (weighted average of two Gaussian widths) in the y-coordinate for different inclination angles (top), the Maximum Detectable Rigidity (MDR, 100% rigidity measurement error) as a function of the inclination angle estimated for 1TV proton incidence with the simulation (middle), and the inclination angle distribution in the geometric acceptance of the tracker (bottom).

5. Some tracking systems:

ANTARES



Summary

- **Fundamental characteristics of any tracking & vertexing device:**
 - (efficiency), granularity, material budget, power dissipation, “timing”, radiation tolerance
 - All those figures are intricated: each technology has its own limits

- **Many technologies available**
 - None is adapted to all projects (physics + environment choose, in principle)
 - Developments are ongoing for upgrades & future experiments
 - Goal is to extent limits of each techno. → convergence to a single one?

- **Reconstruction algorithms**
 - Enormous boost (variety and performances) in the last 10 years
 - Each tracking system has its optimal algorithm

- **Development trend**
 - Always higher hit rates call for more data reduction
 - Tracking info in trigger → high quality online tracking/vertexing

- **Link with:**
 - PID: obvious with TPC, TRD, topological reco.
 - Calorimetry: Particle flow algorithm, granular calo. using position sensors

References

- R.Frühwirth, M.Regler, R.K.Bock, H.Grote, D.Notz
Data Analysis Techniques for High-Energy Physics
Cambridge University Press, 2nd edition 2000
- P. Billoir
Statistics for trajectometry,
proceedings of SOS 2012, [doi:10.1051/epjconf/20135503001](https://doi.org/10.1051/epjconf/20135503001)
- ...and of course the Particle Data Group review
<http://pdg.web.cern.ch>, “Reviews, Tables, Plots” section
- D. Green
The Physics of Particle Detectors
ed. Cambridge University Press 2005
(some sections describing tracking)

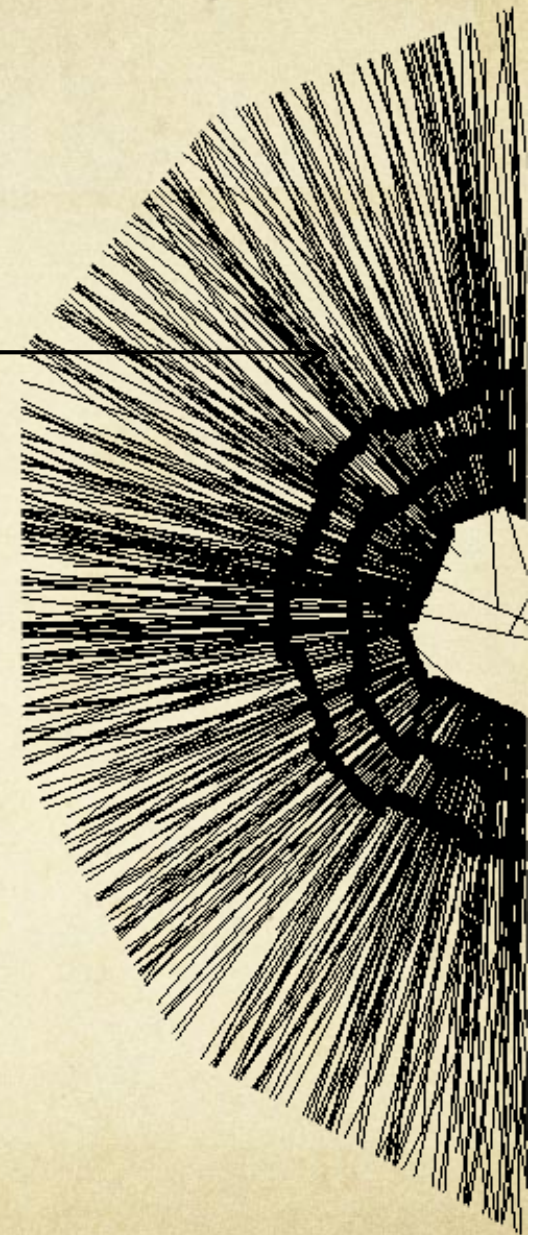

- **Detector technologies**
 - H.G.Moser: *Silicon detector systems in high energy physics*, Progress in Particle and Nuclear Physics 63 (2009) 186237, [doi:10.1016/j.pnpnp.2008.12.002](https://doi.org/10.1016/j.pnpnp.2008.12.002)
 - V.Lepeltier: Review on TPC's, Journal of Physics: Conference Series 65 (2007) 012001, [doi:10.1088/1742-6596/65/1/012001](https://doi.org/10.1088/1742-6596/65/1/012001)
 - Fabio Sauli
Gaseous Radiation Detectors: Fundamentals and Applications
ed. Cambridge University Press 2014
 - Helmut Spieler,
Semiconductor Detector Systems,
ed. Oxford Univ. Press 2005
 - Leonardo Rossi, Peter Fischer, Tilman Rohe and Norbert Wermes
Pixel Detectors: From Fundamentals to Applications,
ed. Springer 2006

○ Reconstruction algorithm & fit

- A.Strandlie & R.Frühwirth : *Track and Vertex Reconstruction: From Classical to Adaptive Methods*, Rev. Mod. Phys. 82 (2010) 1419–1458, [doi:10.1103/RevModPhys.82.1419](https://doi.org/10.1103/RevModPhys.82.1419) and many references therein.
- R Mankel : *Pattern recognition and event reconstruction in particle physics experiments*, Rep. Prog. Phys. 67 (2004) 553–622, [doi:10.1088/0034-4885/67/4/R03](https://doi.org/10.1088/0034-4885/67/4/R03)
- C.Höpner, S.Neubert, B.Ketzer, S.Paul ; *A New Generic Framework for Track Fitting in Complex Detector Systems (GENFIT)*, Nucl.Instr.Meth. A 620 (2010) 518-525,2010, [doi:10.1016/j.nima.2010.03.136](https://doi.org/10.1016/j.nima.2010.03.136)
- V. Karimäki : *Effective circle fitting for particle trajectories*
Nucl. Instr. Meth. A 305 (1991) 187-191
- M. Valentan, M. Regler, R. Frühwirth : *Generalization of the Gluckstern formulas I & II*
Nucl. Instr. Meth. A 589 (2008) 109–117 & A 606 (2009) 728–742
- *Proceedings of the first LHC Detector Alignment Workshop*, report CERN-2004-007, cdsweb.cern.ch/search?p=reportnumber%3ACERN-2007-004
also consult lhc-detector-alignment-workshop.web.cern.ch

○ Contributions from experiments

- S.Haino et al., *The performance of the AMS-02 silicon tracker evaluated during the pre-integration phase of the spectrometer*, Nuclear Instruments and Methods in Physics Research A 630 (2011) 78–81, [doi:10.1016/j.nima.2010.06.032](https://doi.org/10.1016/j.nima.2010.06.032)
- G.Piacquadio, ATLAS Alignment, Tracking and Physics Performance Results, proceedings of VERTEX 2010, [PoS\(VERTEX 2010\)015](#)
- A.Venturi, CMS Alignment, Tracking and Physics Performance Results, proceedings of VERTEX 2010, [PoS\(VERTEX 2010\)016](#)
- J.Aguilar et al., A fast algorithm for muon track reconstruction and its application to the ANTARES neutrino telescope, J. Astro. Phys. 34 (2011) 652-662, [doi10.1016/j.astropartphys.2011.01.003](https://doi.org/10.1016/j.astropartphys.2011.01.003)
- S.Amerio, Online Track Reconstruction at Hadron Collider, Proceedings of ICHEP 2010, [PoS\(ICHEP 2010\)481](#)
- F.Arneodo et al., **Performance of a liquid argon time projection chamber exposed to the CERN West Area Neutrino Facility neutrino beam**, Phys.Rev. D 74(2006)112001, [doi:10.1103/PhysRevD.74.112001](https://doi.org/10.1103/PhysRevD.74.112001)

Was not discussed

- Particle interaction with matter
- The readout electronics
- Cooling systems
- The magnets to produce the mandatory magnetic field for momentum measurement
- Vertexing

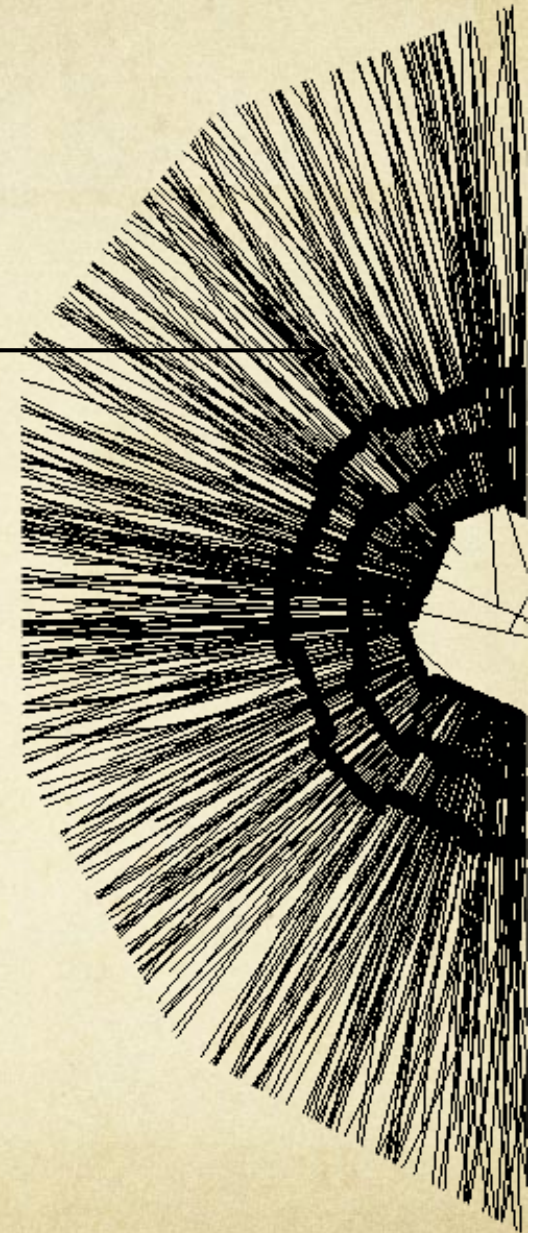

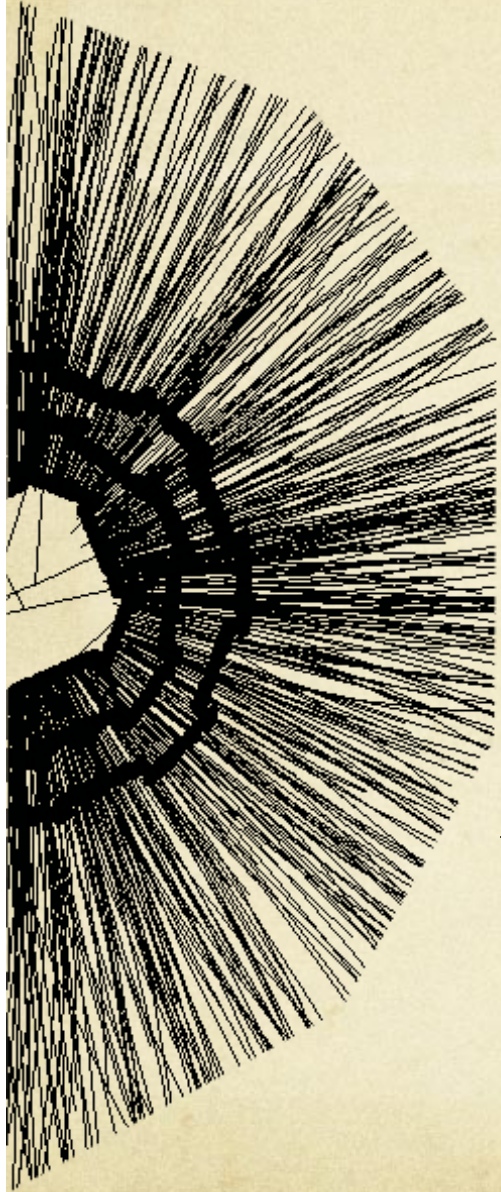

Backups

Backups:

OPAL drift chamber

○



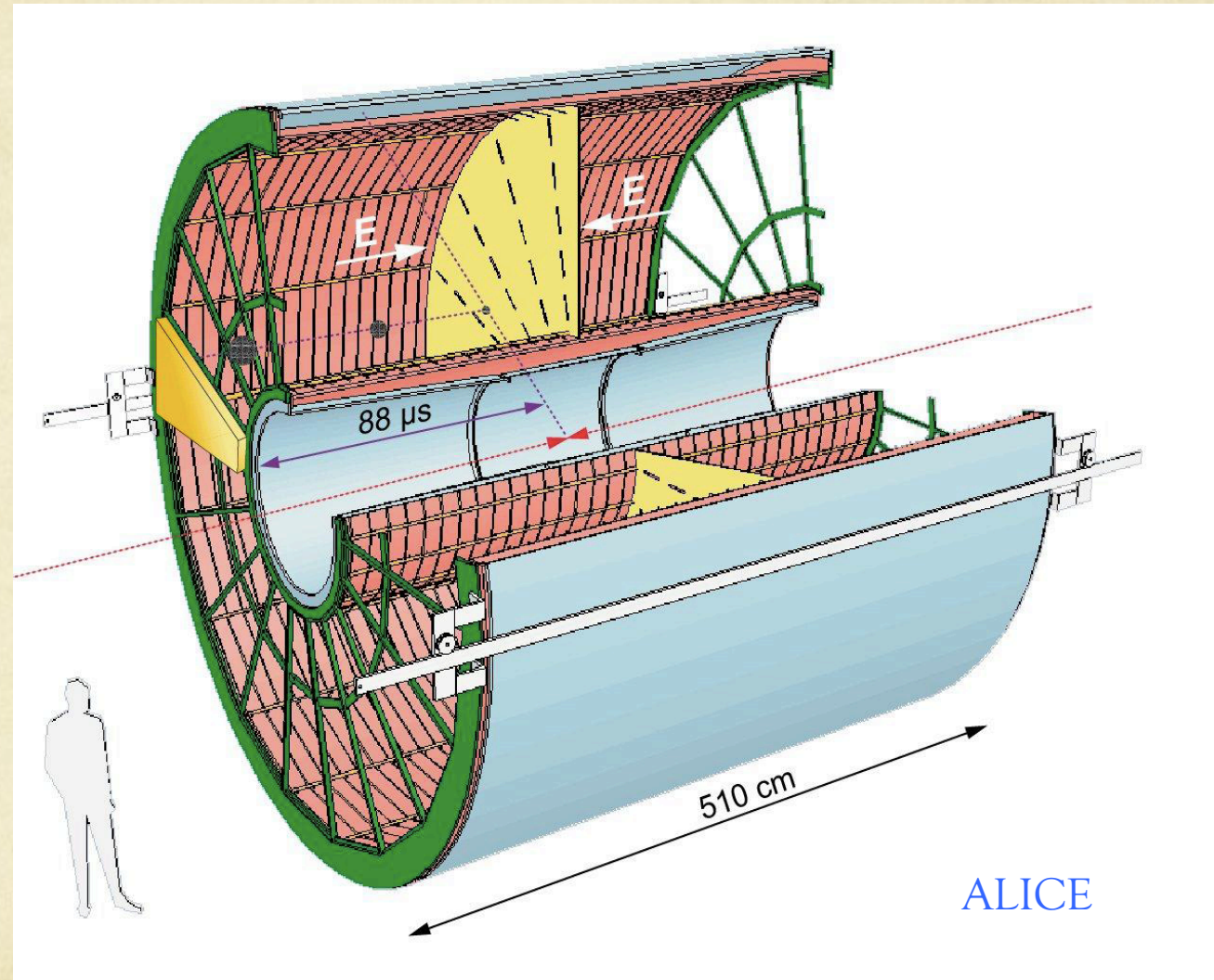

(ALICE) TPC dE/dx

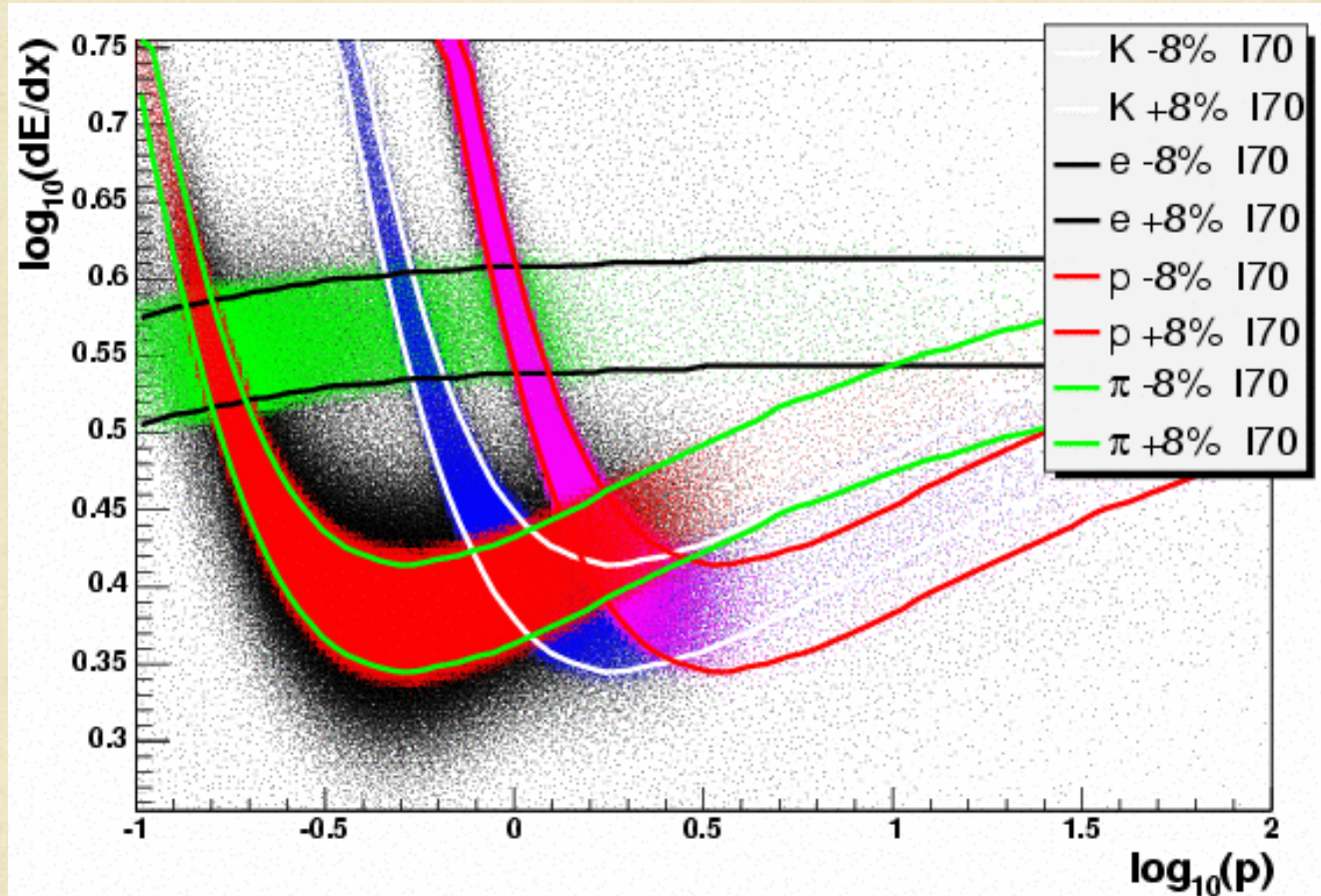

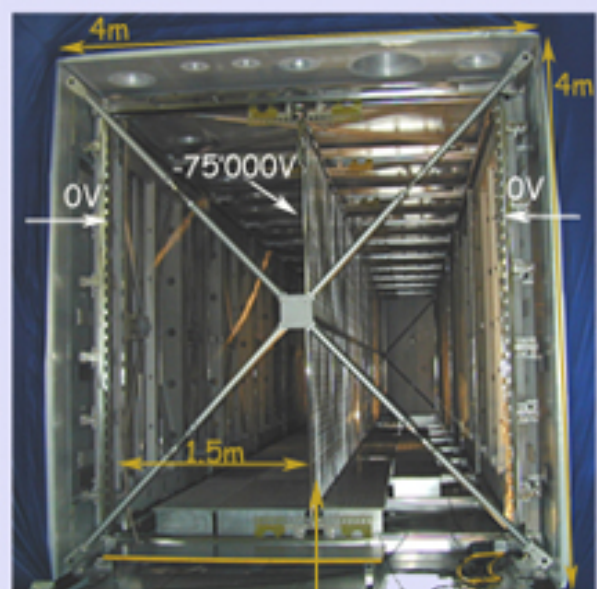
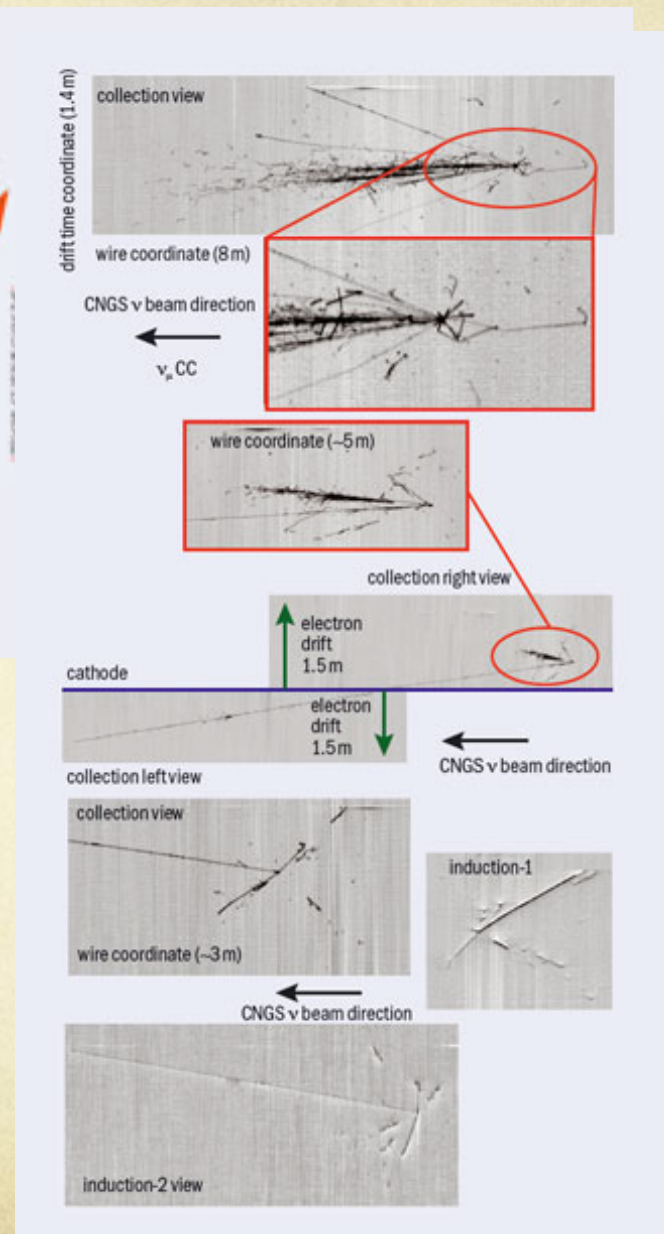
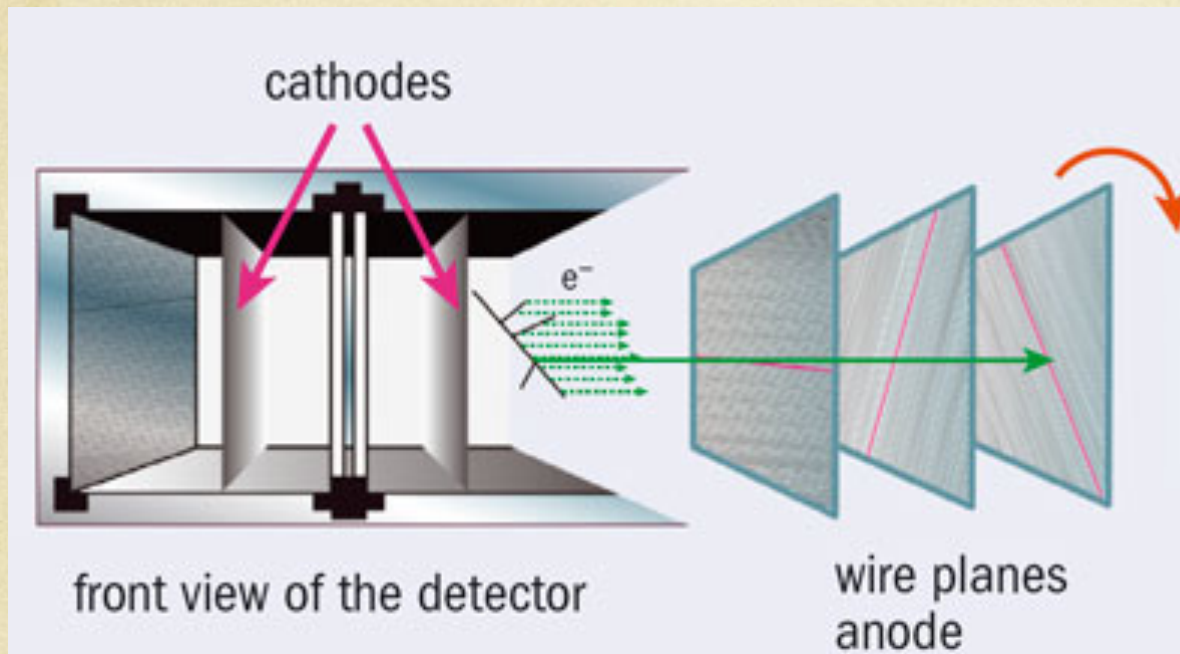

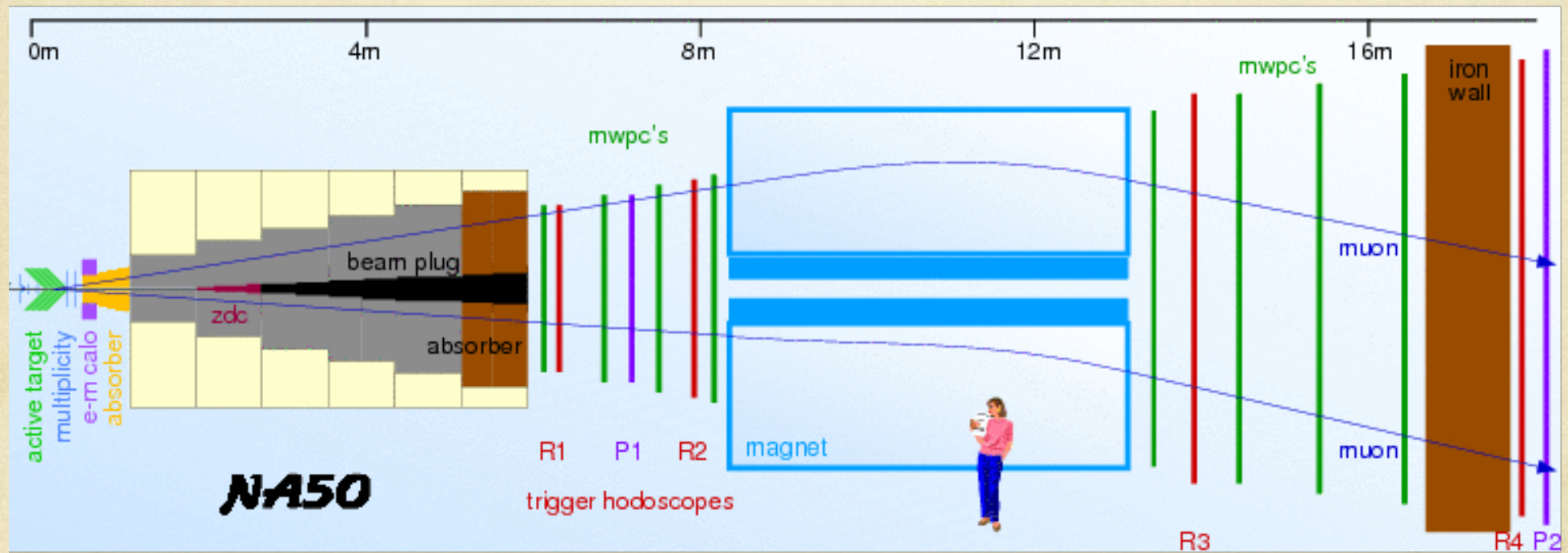

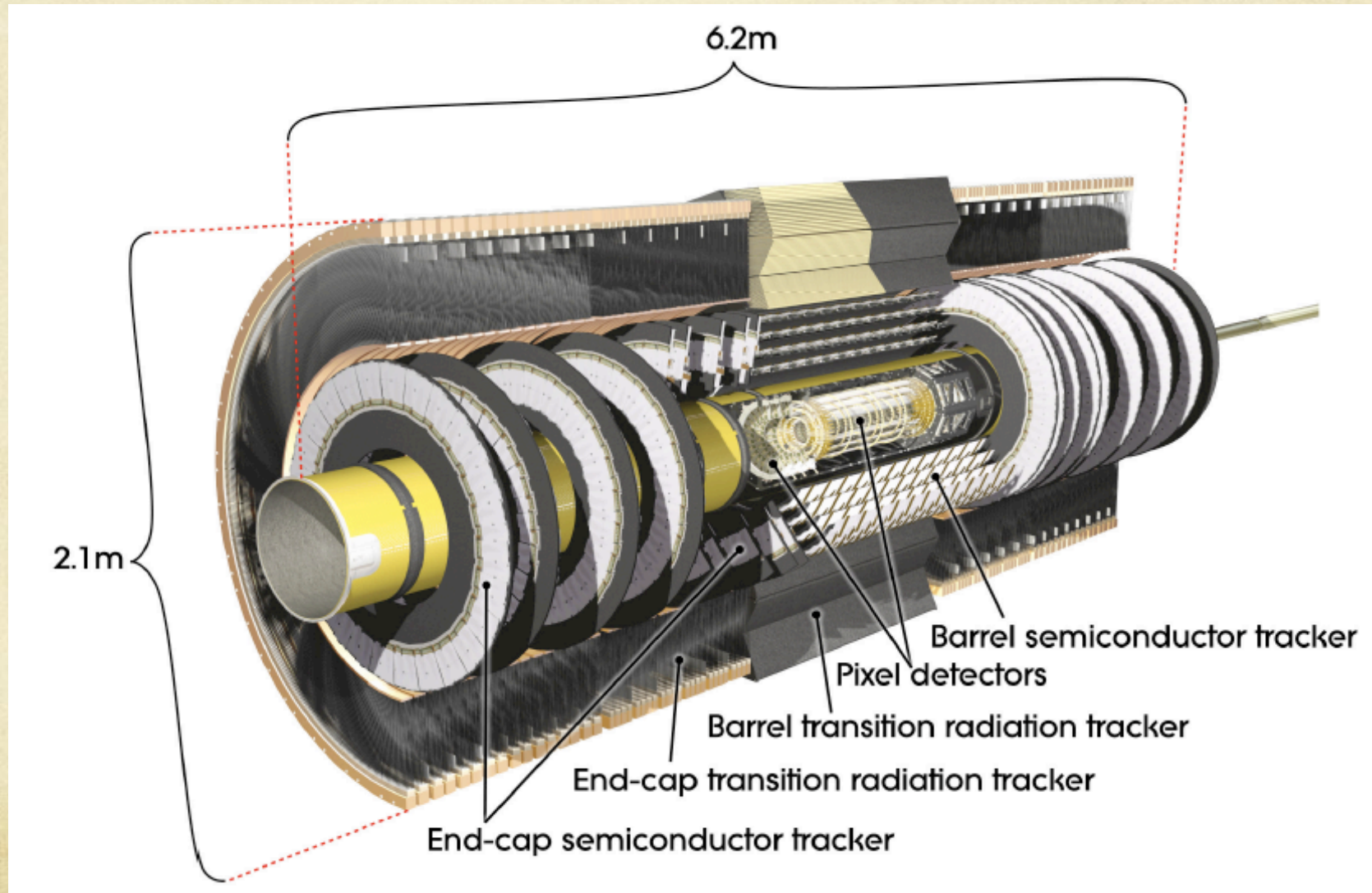

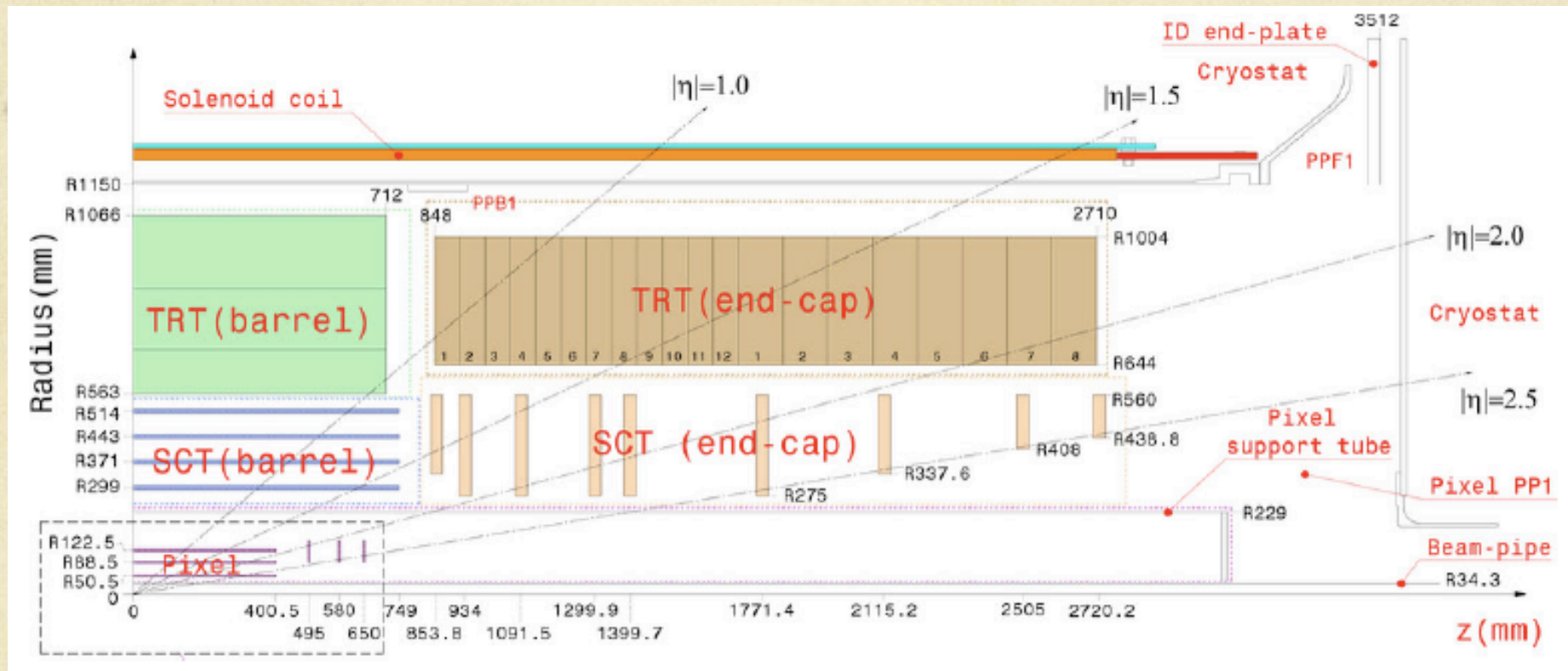

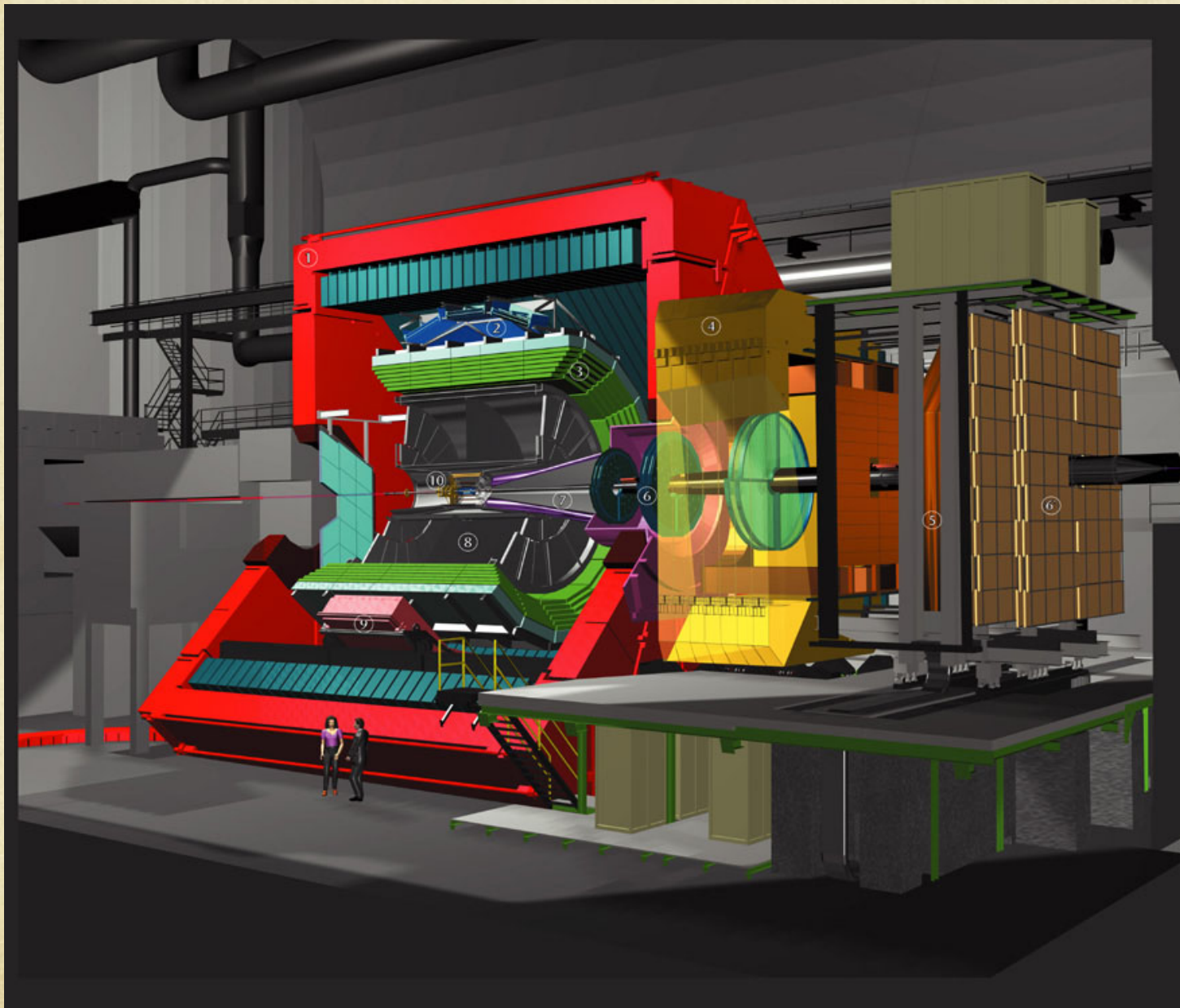

- 1• L3 MAGNET
- 2• HMPID
- 3• TOF
- 4• DIPOLE MAGNET
- 5• MUON FILTER
- 6• TRACKING CHAMBERS
- 6• TRIGGER CHAMBERS
- 7• ABSORBER
- 8• TPC
- 9• PHOS
- 10• ITS



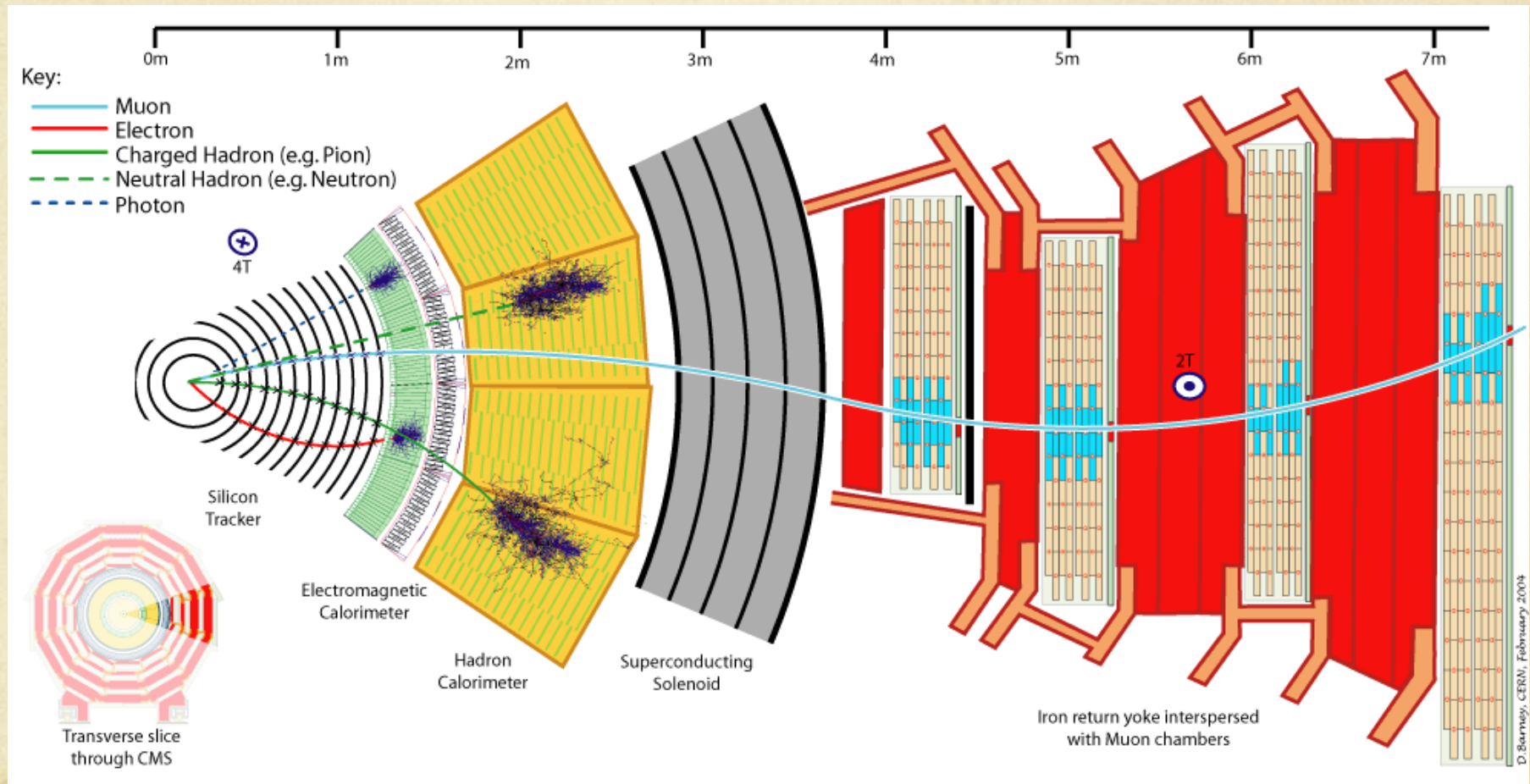

DEPFET

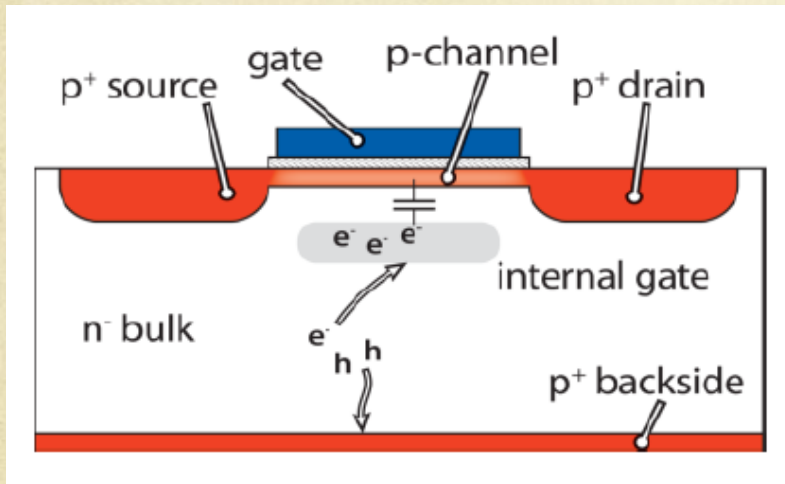

Silicon drift

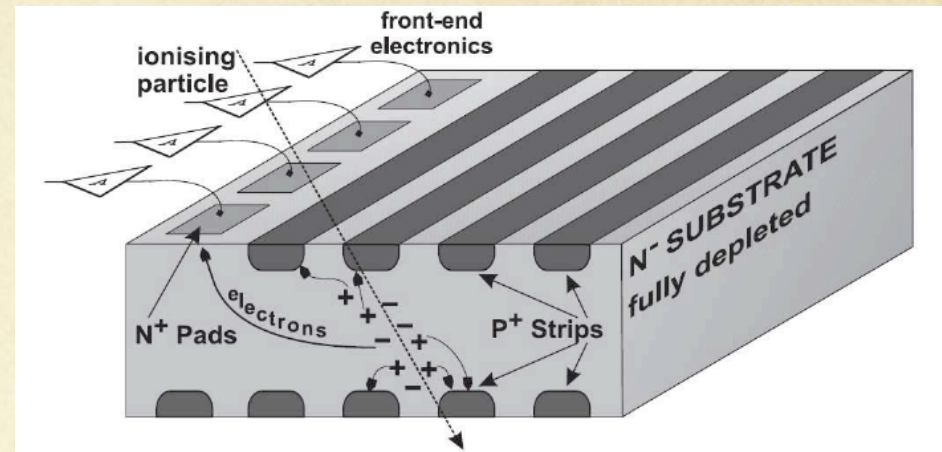

CCD

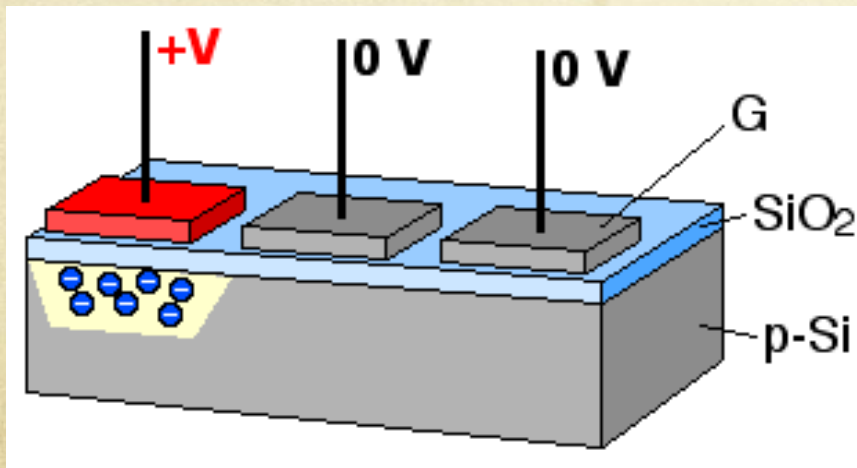

MICROMEAS

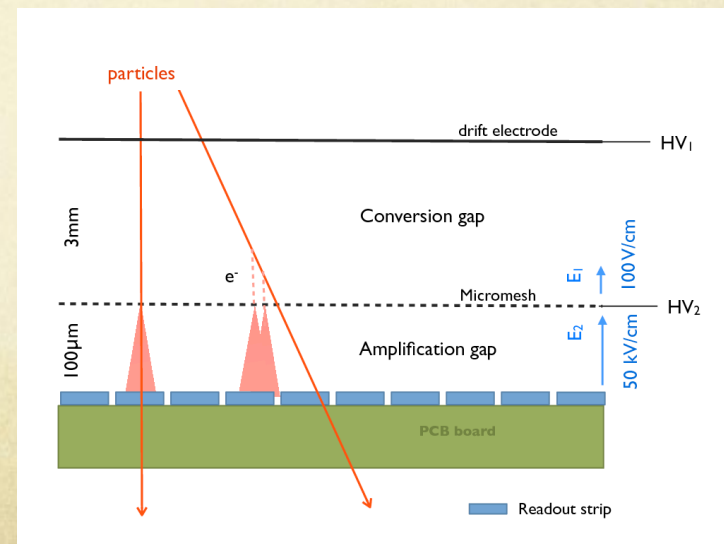

○ Hypothesis

- > M detectors, each with σ single point accuracy

- > Uniform field over L from dipole

- Trajectory: $\Delta p = p \Delta\alpha$ $\Delta\alpha = \left| \frac{0.3qBL}{p} \right|$
- Bending:

- > Geometrical arrangement optimized for resolution

- Angular determination on input and output angle:

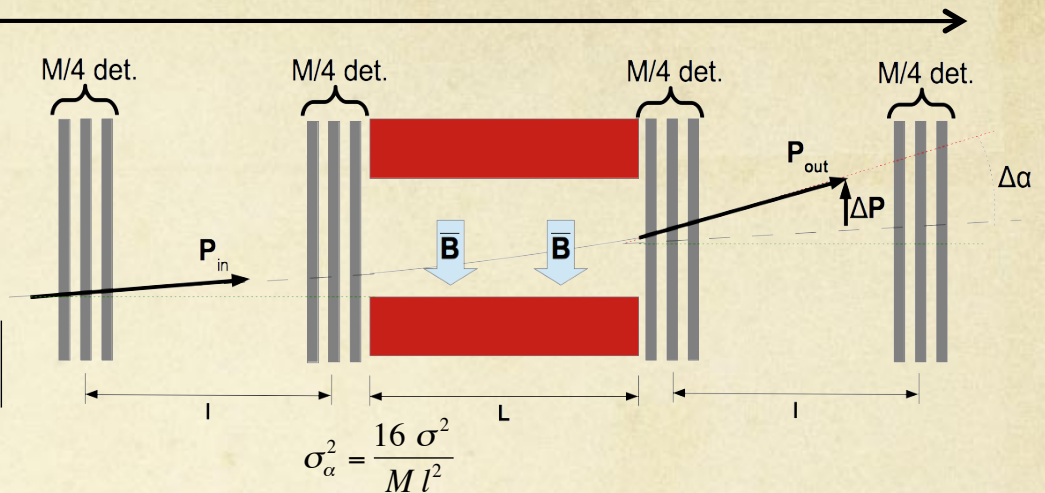

○ Without multiple scattering $\Delta\alpha = \left| \frac{0.3qBL}{p} \right|$

- > Uncertainty on momentum