

Radiation Safety for High Power Operation

D. Ridikas for Task 5

List of objectives:

- Shielding against prompt radiation and induced radioactivity
- Containment of radioactivity
- Characterization of nuclear waste and disposal of spent targets
- Conformity of the proposed installation to the legislation

Major efforts on the 4 MW target station !

Task 5: Participants and work plan

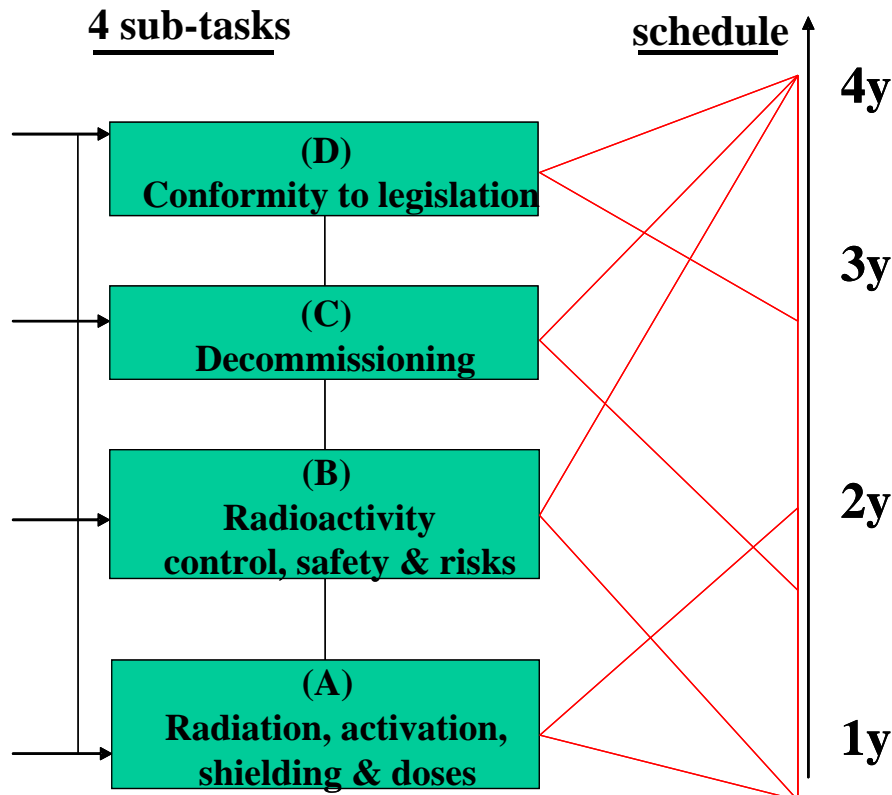

<u>Participants:</u>		<u>role</u>
1.	GANIL, France	- sub-task D
2.	FZJ, Germany	- sub-task C
3.	LMU, Germany	- sub-task B
4.	CERN, EU	- sub-task A
5.	CEA, France	- <u>coordination</u>
6.	NIPNE, Romania	- contribution
7.	FI, Lithuania	- contribution
8.	Univ. Warsaw, Poland	- contribution

External partners:
ORNL, ANL, TRIUMF, JAEA, KAERI

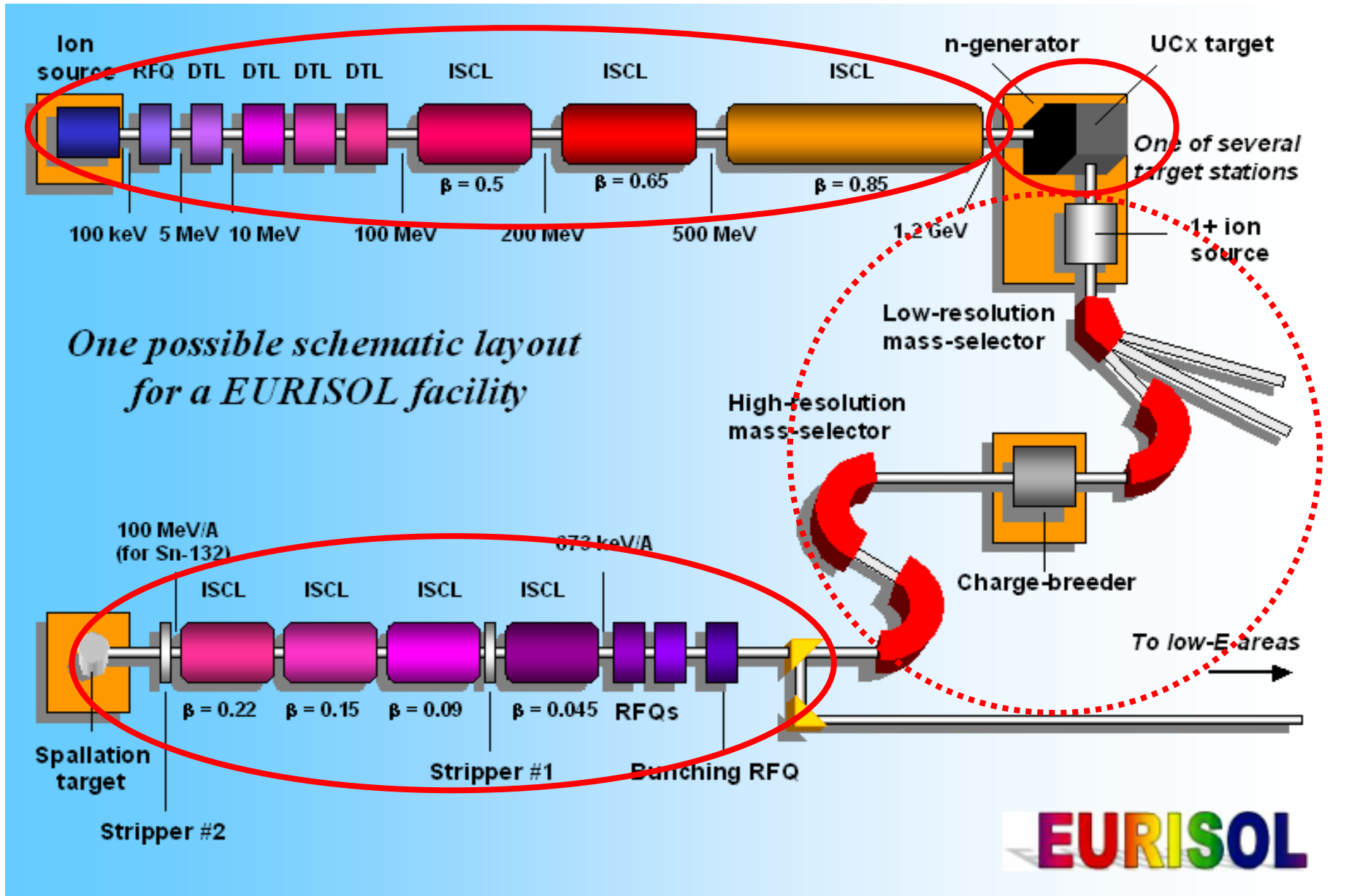

E_p	570 MeV
I_p	1.2 mA (1.8)
W	0.7MW (1.0)
V_{PbBi}	~ 82 liters
Main pump	~4.00 l/s
T_{transit}	~20 s

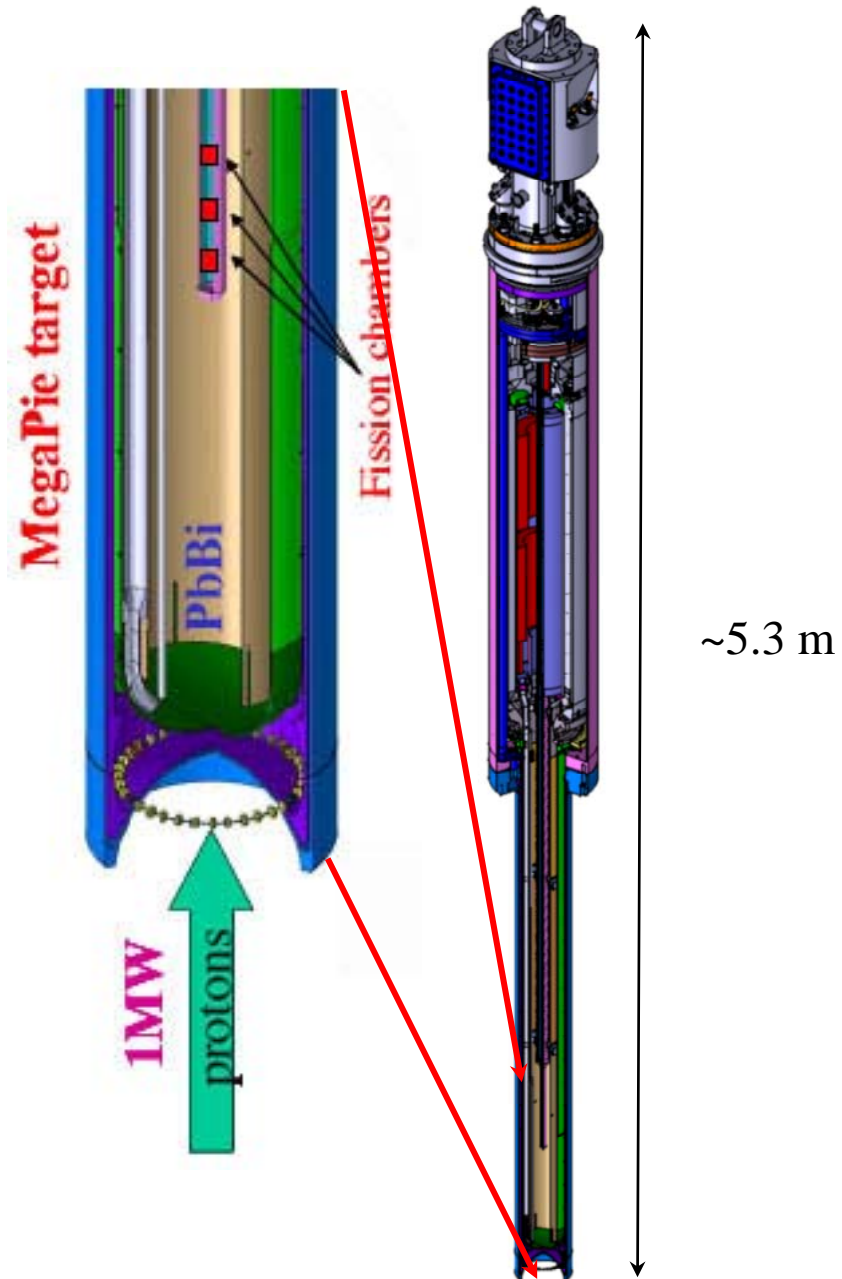

**1st beam on the target since
14 August and still running!**

J-PARK/JAEA - thanks to H. Nakashima

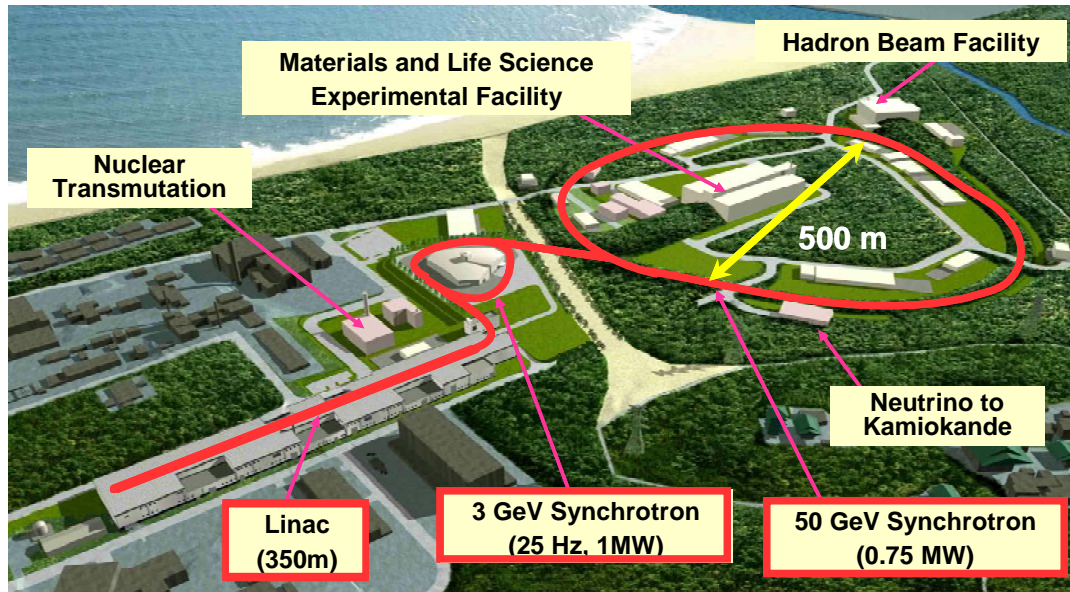

→ Facility Under construction ←

- 3GeV, 1MW, 25Hz, proton beam
- Mercury target of 1.4m³
- Moderators with liquid H of 260l
- Shield of about 10,000t and movable target structure

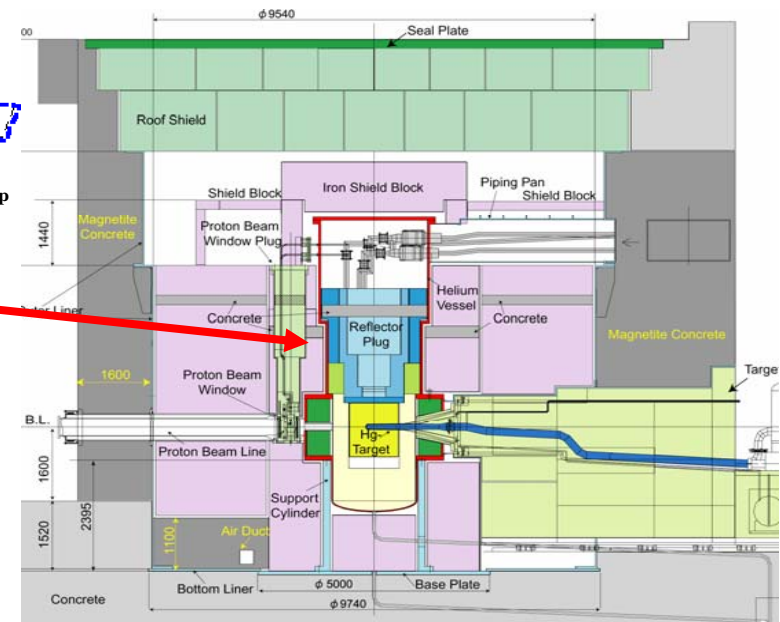
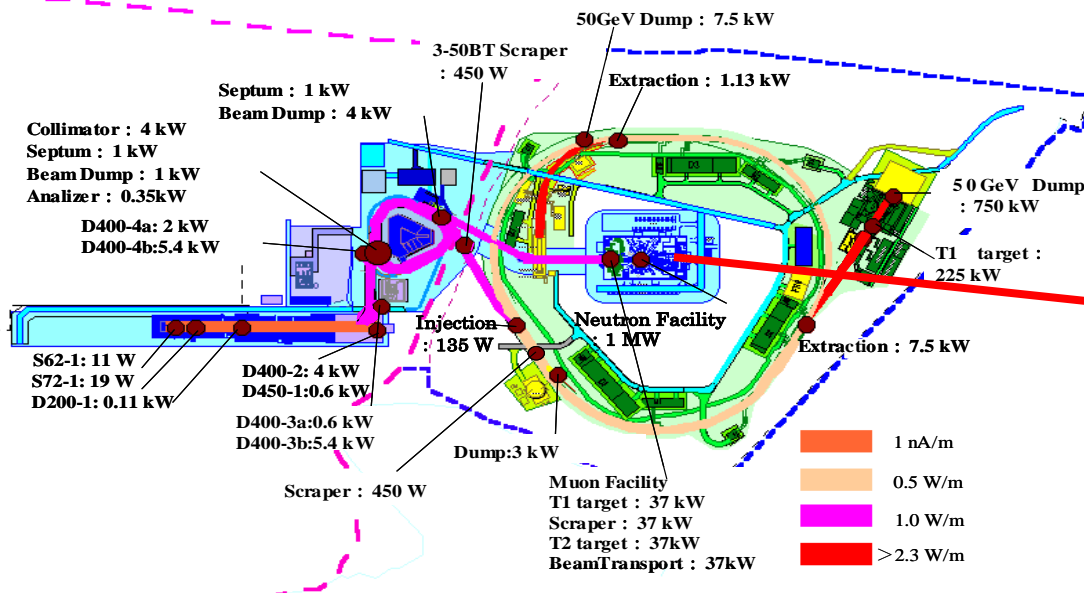

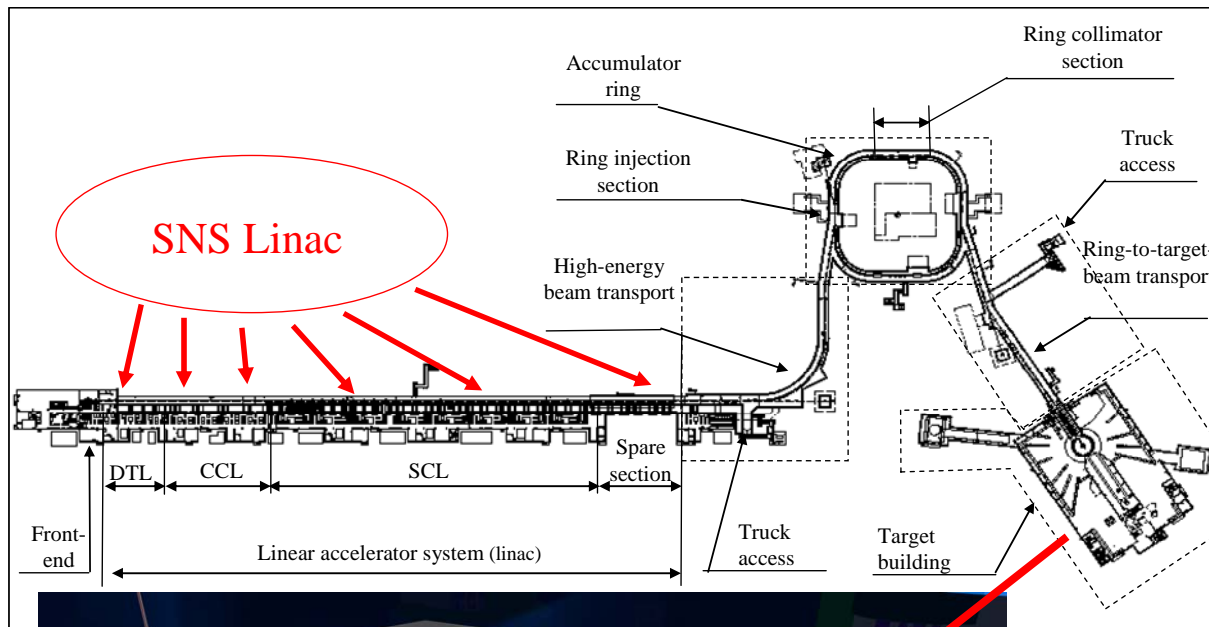

- The SNS has started operation in 2006
- 1GeV protons on liquid Hg (1.4 MW)
- The peak neutron flux ~20–100x ILL
- SNS will be the world's leading facility for neutron scattering

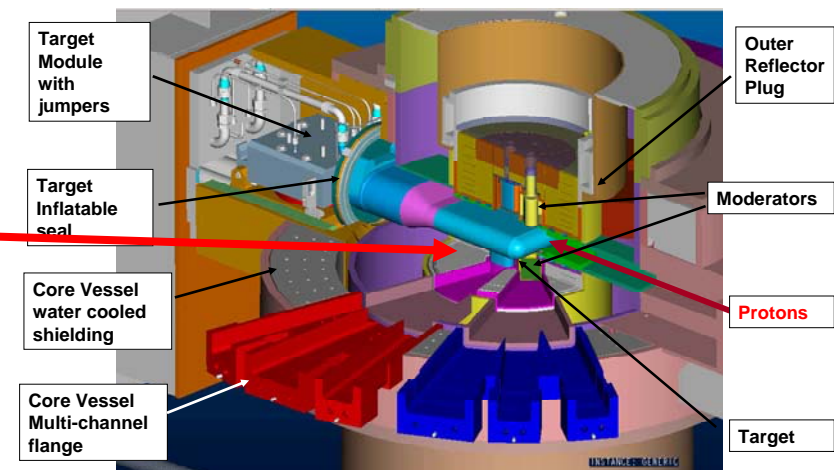
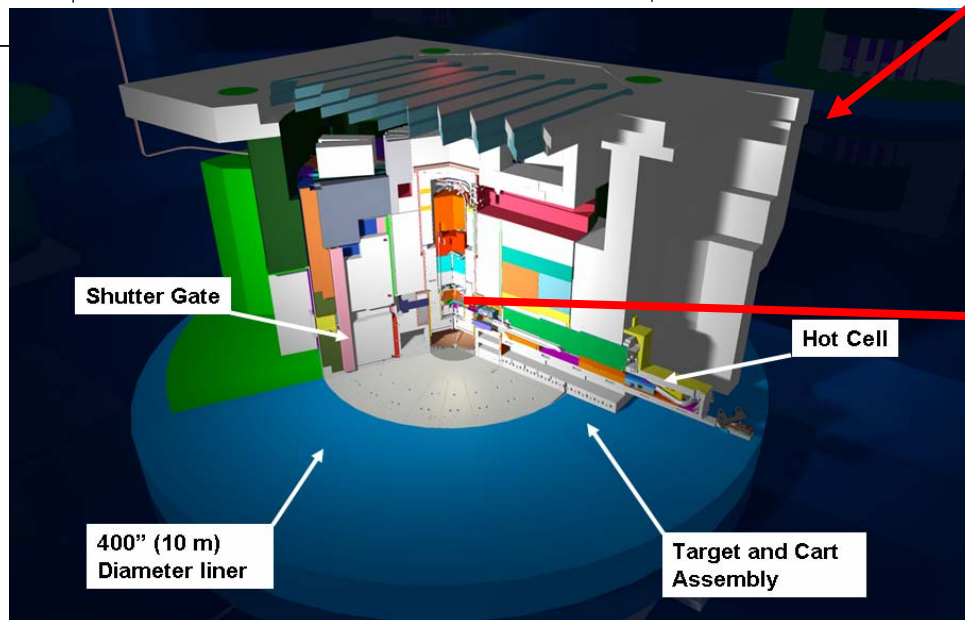

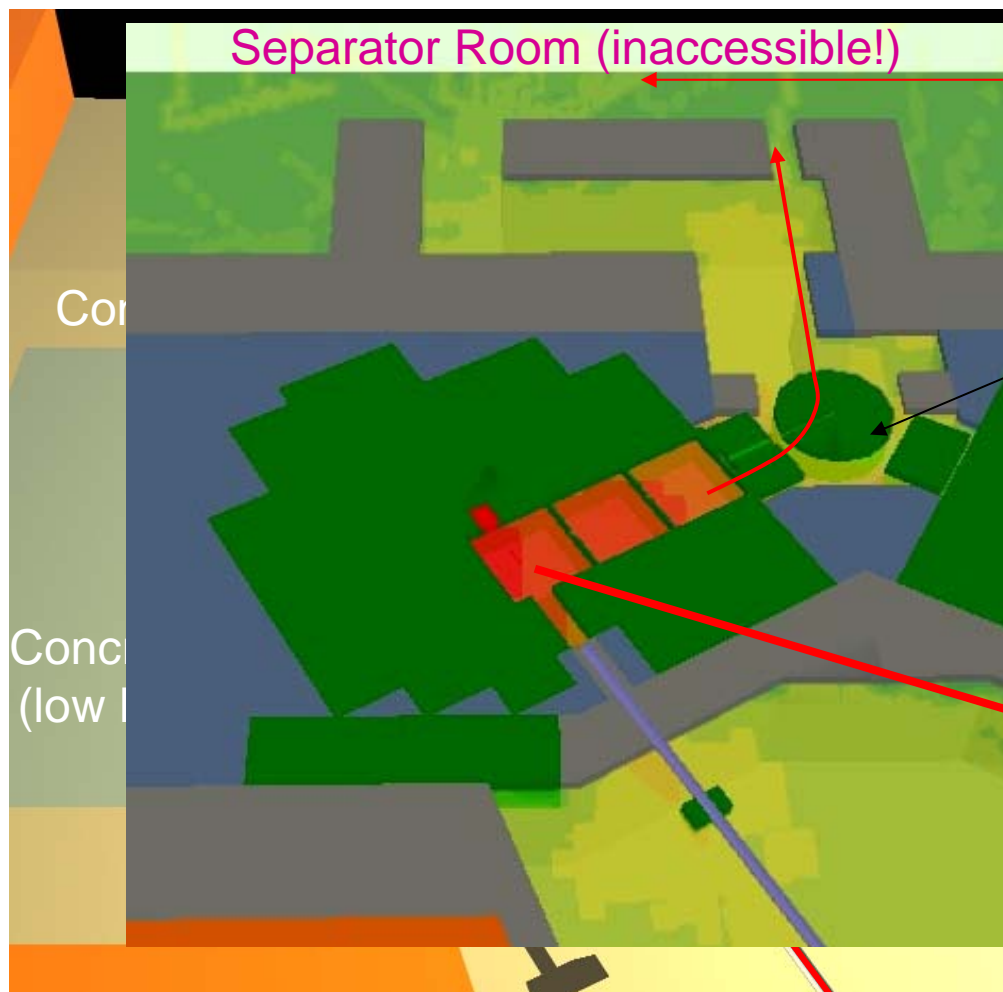

$\sim 1 \text{ mSv h}^{-1}$
(To prevent radiation damage)

Pre-separator



Target: $50 \text{ g cm}^{-2} \text{ UC}_2$
 $E_p = 500 \text{ MeV}$
 $I_p = 100 \mu\text{A}$

Proton beam

No license so far!

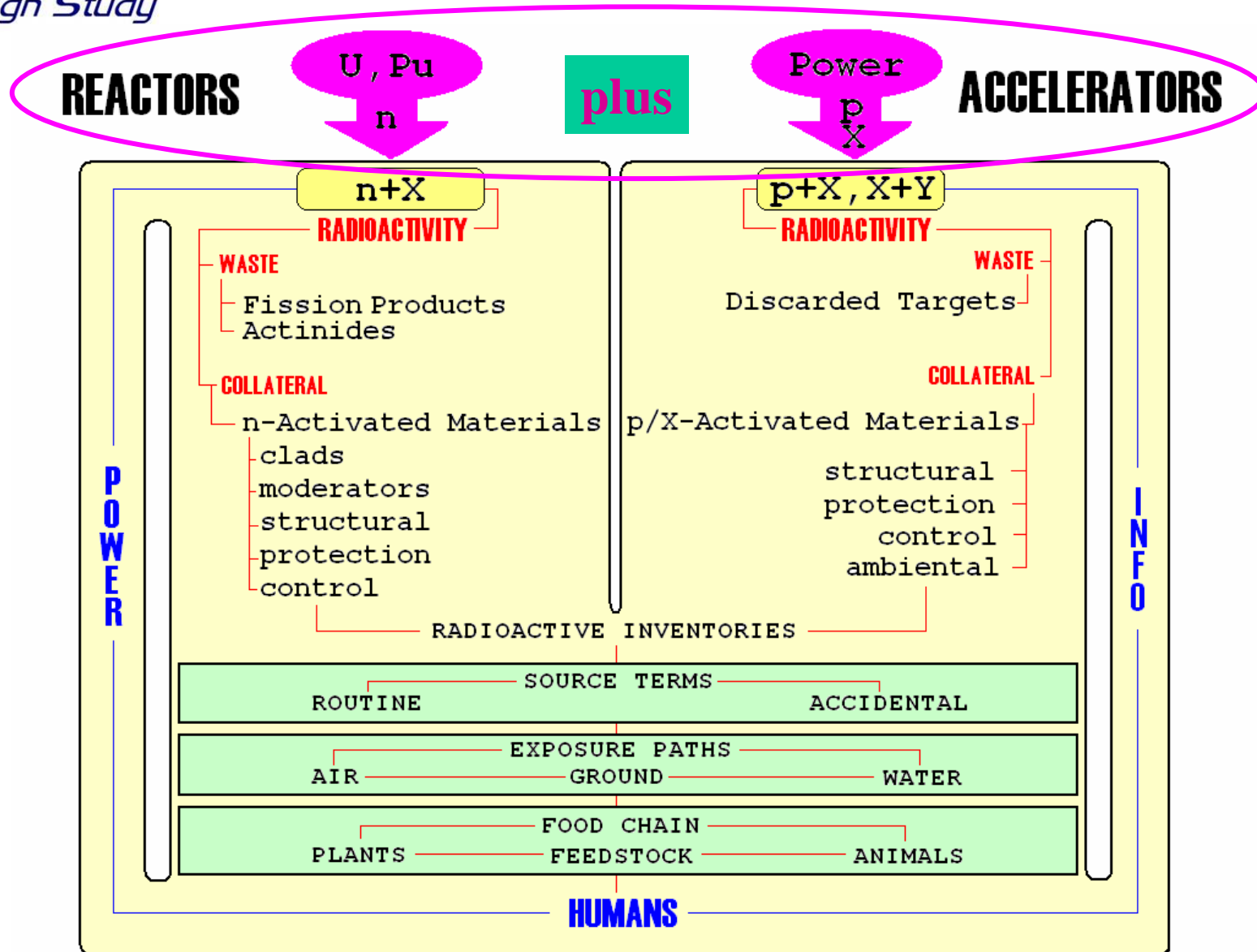

EURISOL → combination of both!

A) Shielding of the proton driver

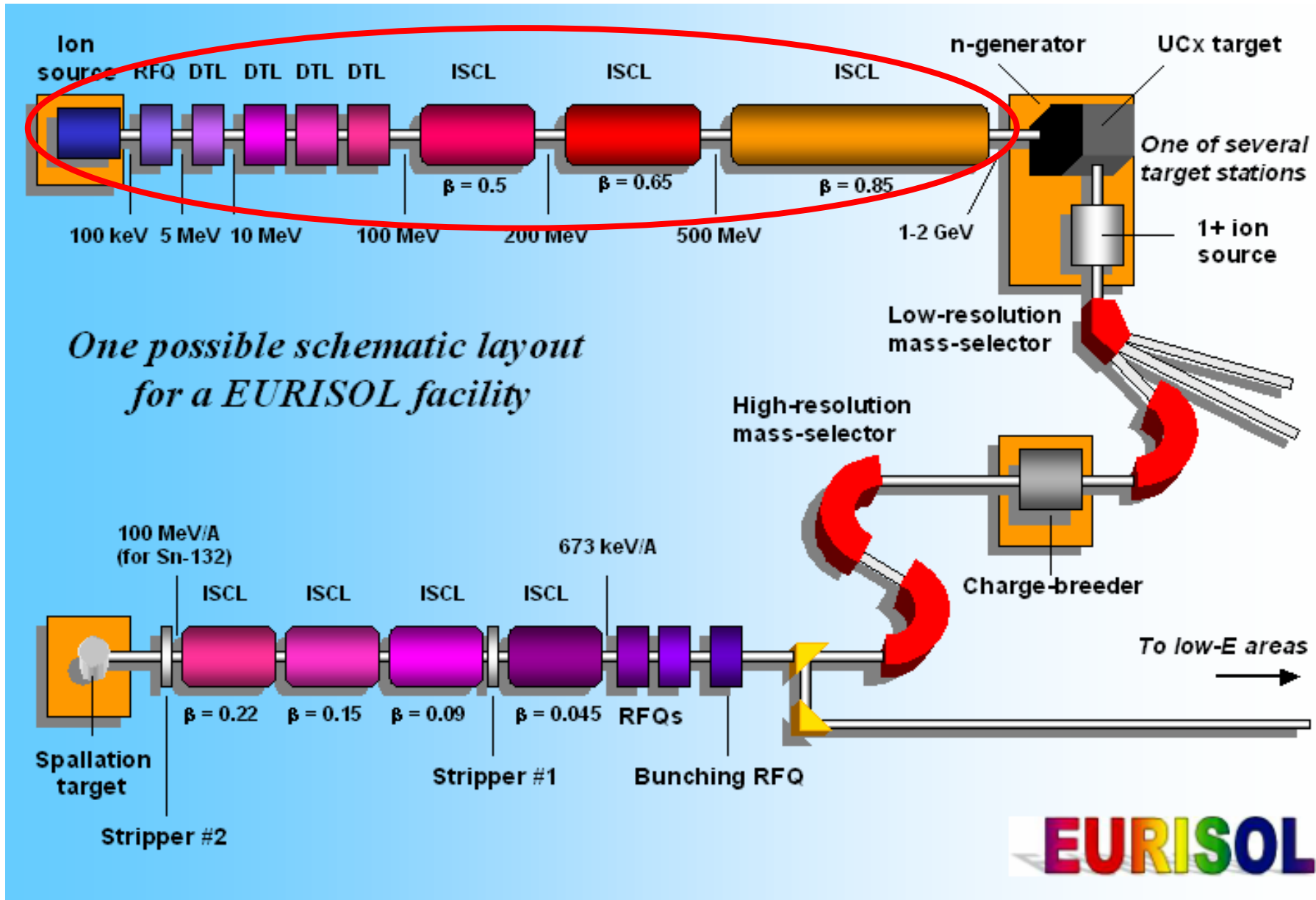

A) Shielding benchmarks

p(1.6 GeV) + Fe → neutrons

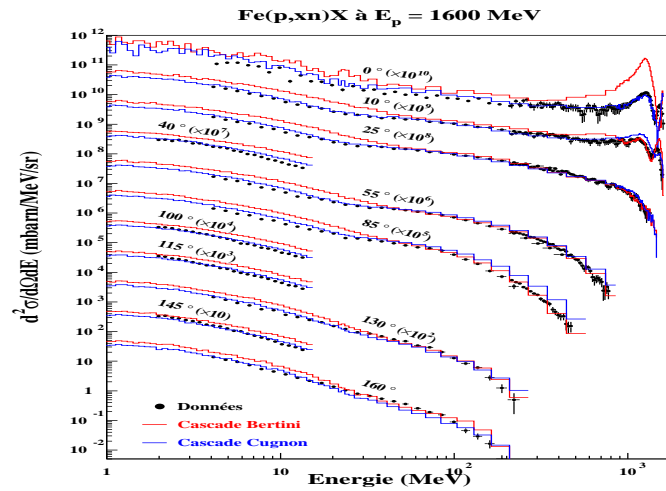

J.-C. David et al. (CEA)

Neutron penetration in iron shield

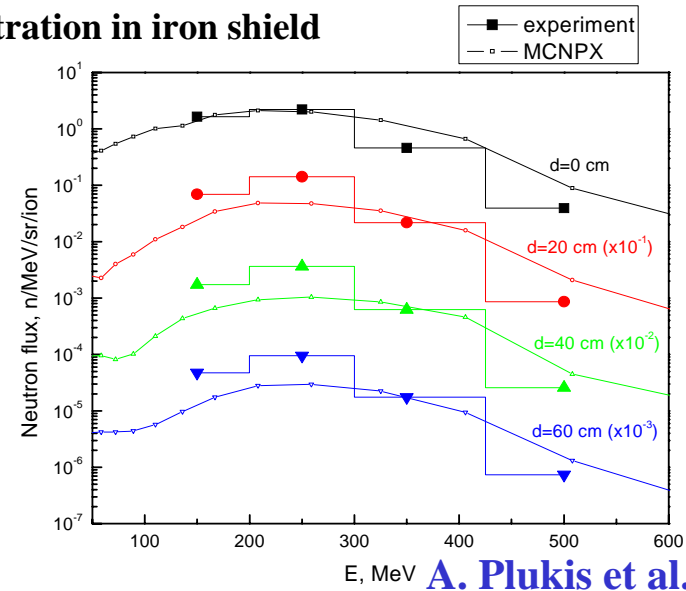

A. Plukis et al. (FI)

p(0.8 GeV) + U → neutrons

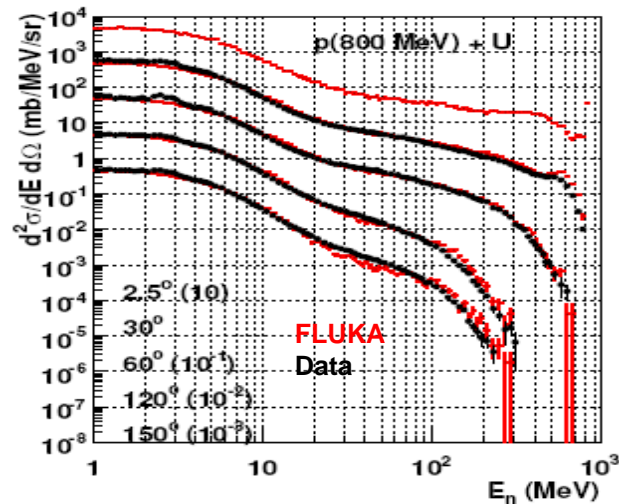

M. Felcini et al. (CERN)

Neutron penetration in concrete shield

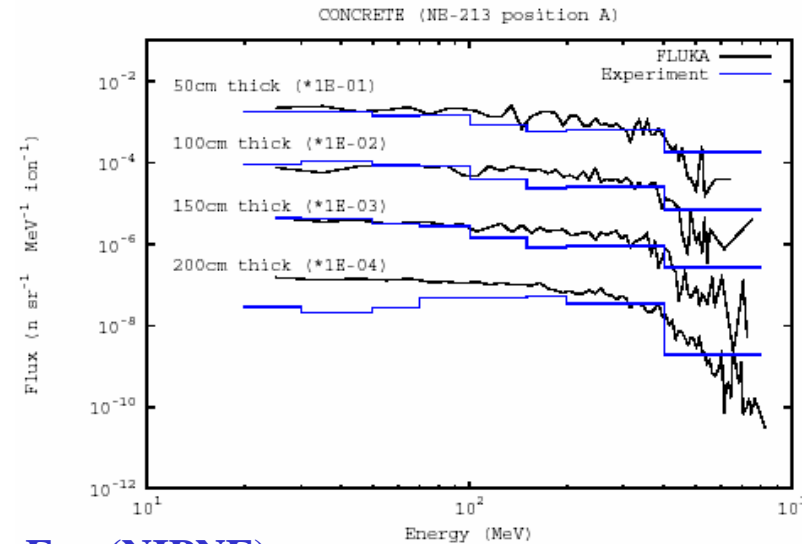

D. Ene (NIPNE)

A) Shielding of the proton driver

Guidelines for ESS by P. Berkvens et al. (2006)

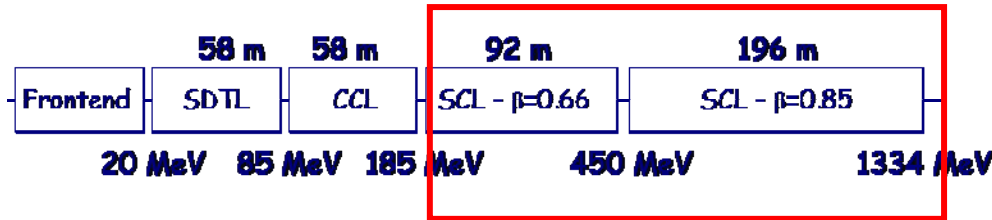

Shielding criteria:

- Normal losses of 1W/m
- Dose rates < 1.0 $\mu\text{Sv/h}$

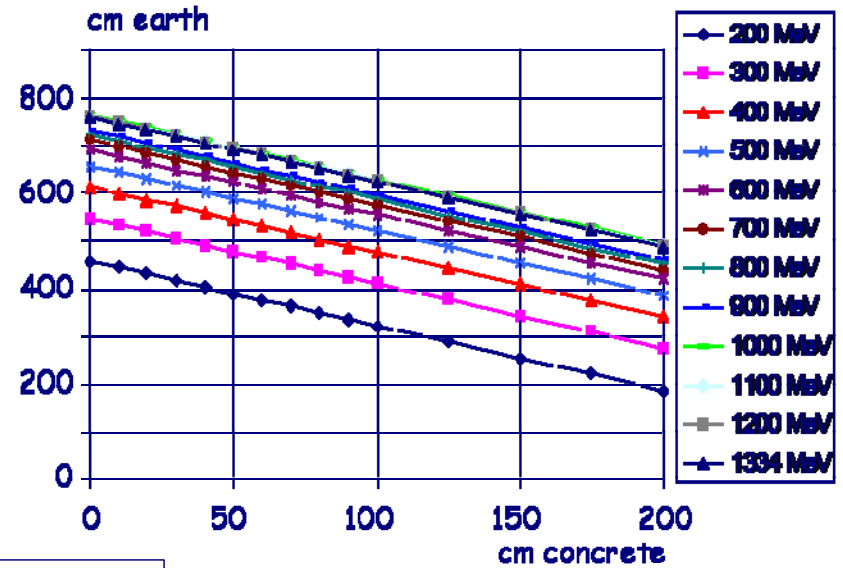

Definition of earth shielding for a given concrete thickness

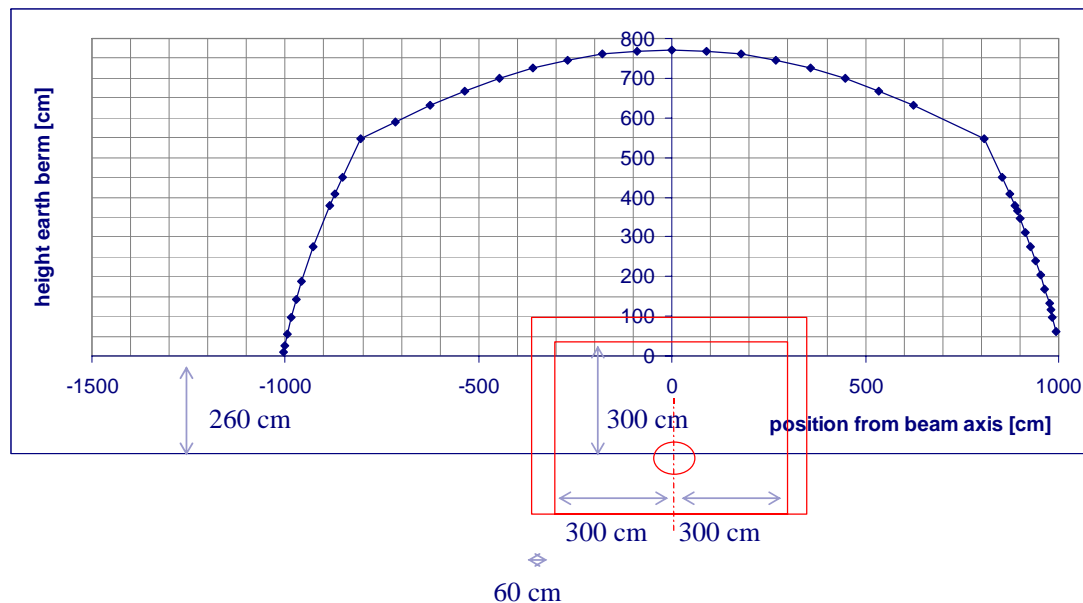

Cross check: MC versus deterministic

Shielding thickness	Monte Carlo	Moyer model
45 cm concrete + 4.75 m earth	2.5 $\mu\text{Sv/h}$	3.8 $\mu\text{Sv/h}$

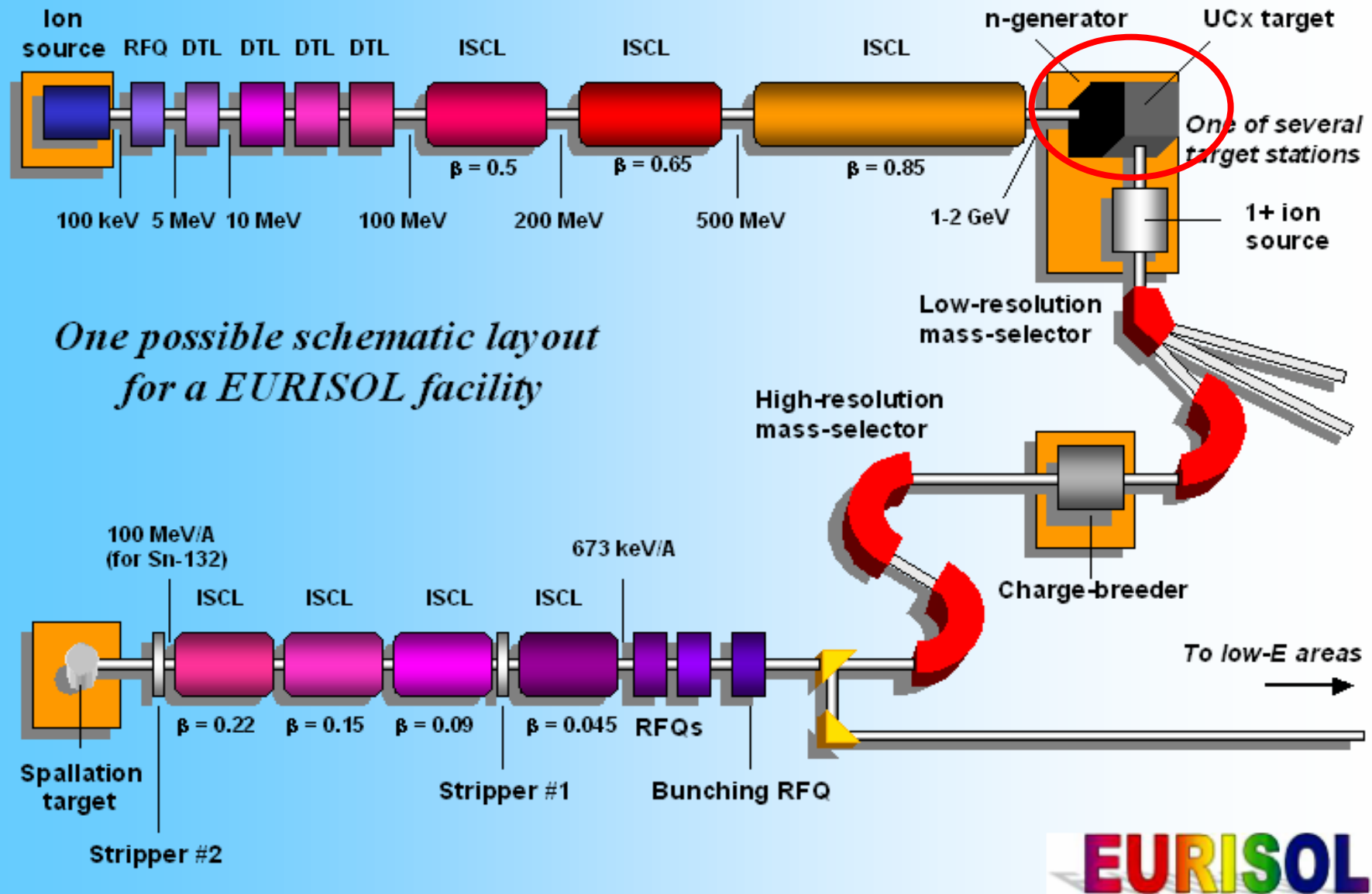

A) Shielding of the 4 MW target

T. Otto & M. Felcini (CERN)

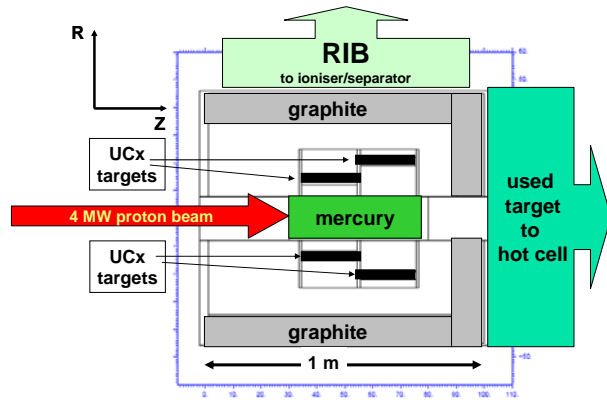

Condition for dose rates $< 1 \mu\text{Sv/h}$

- 2 m of iron
- For $\theta = 0, 90 \text{ \& } 180^\circ \rightarrow 9.0, 8.0 \text{ \& } 5.5 \text{ m of concrete}$
- To be complemented with earth

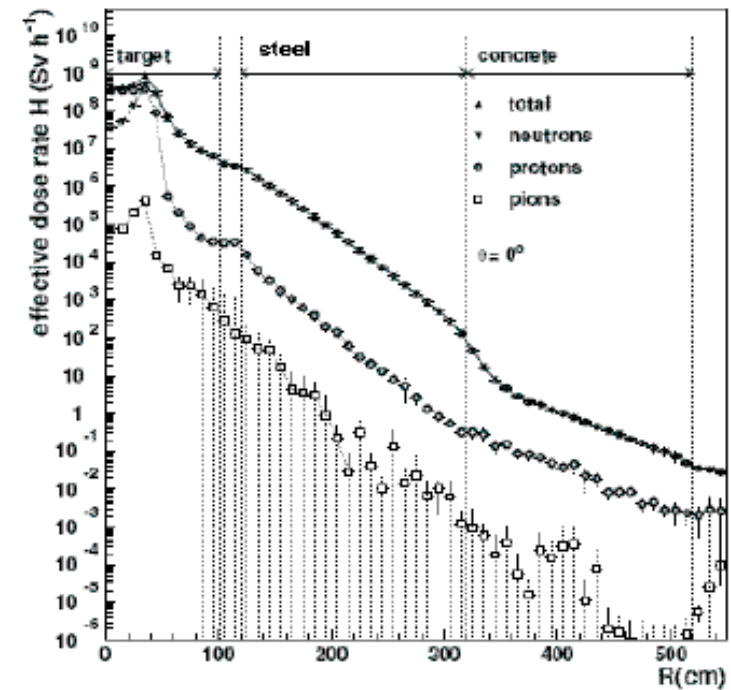
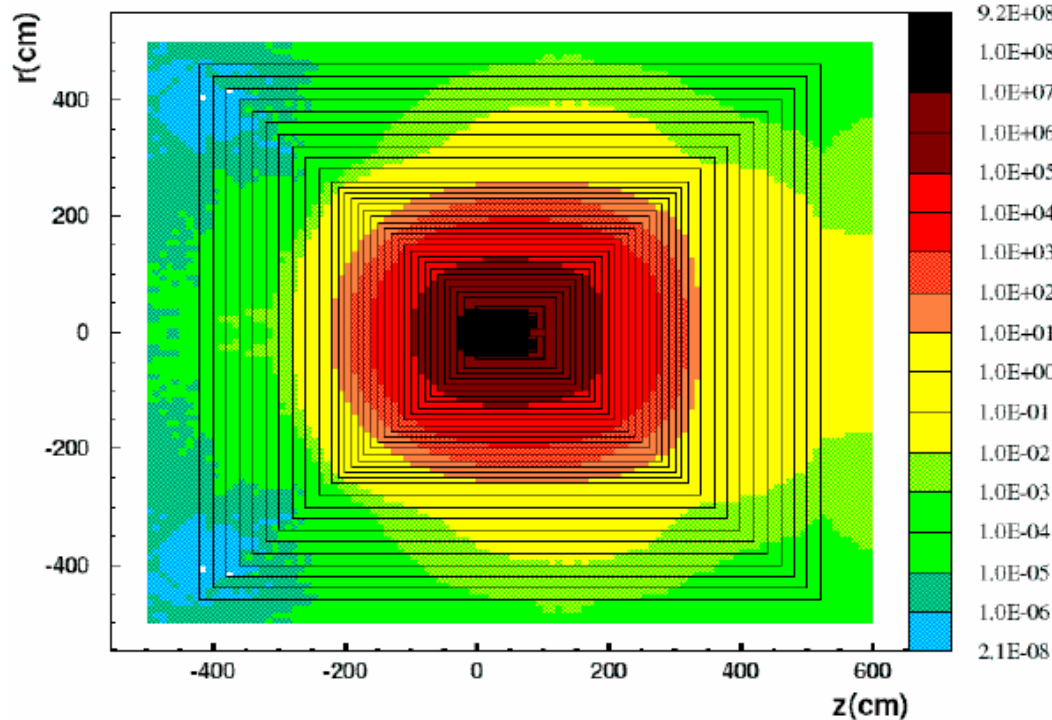

A) Shielding of the postaccelerator

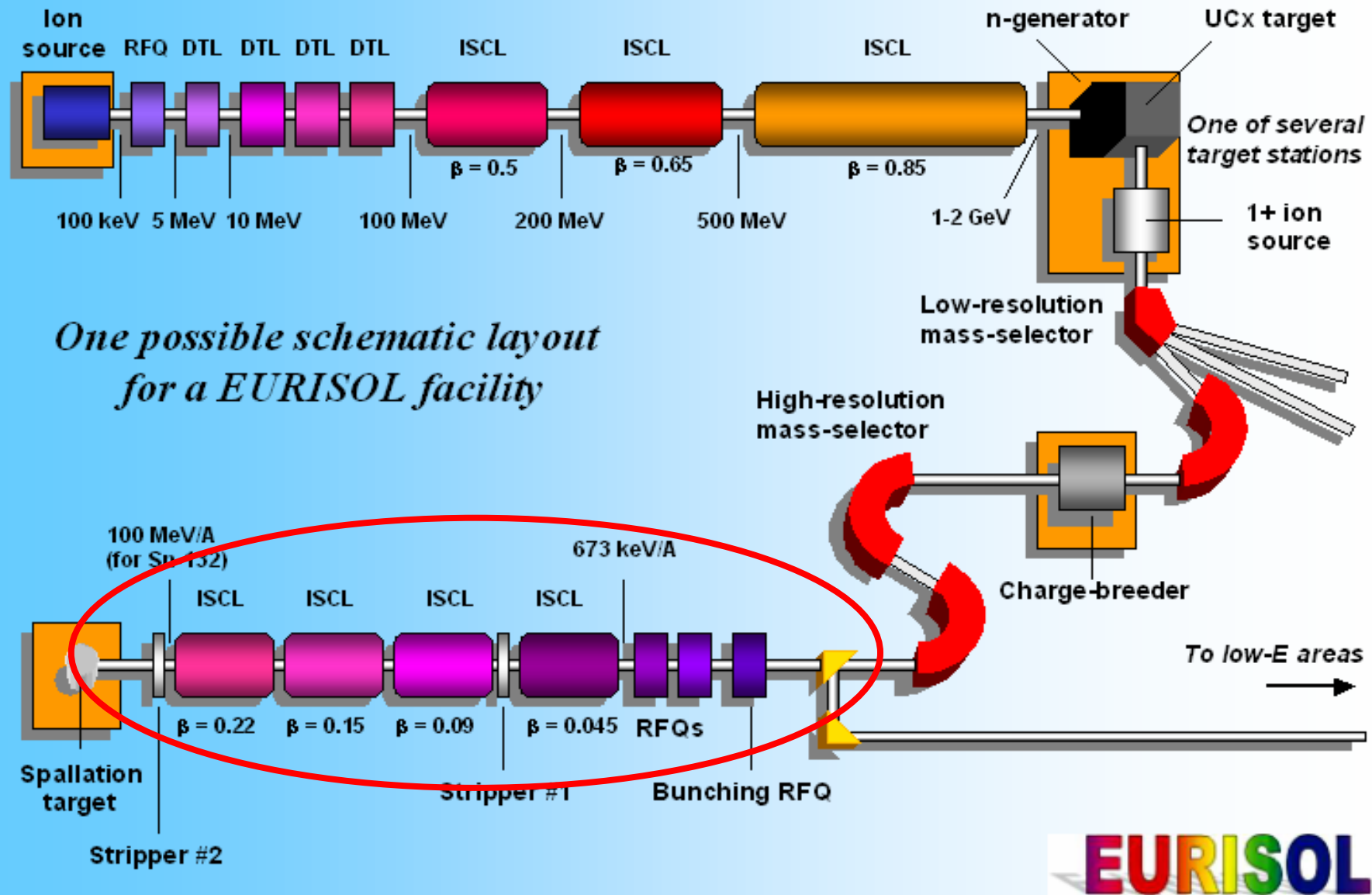

Production of neutrons
RIKEN data : Ar(95MeV/u)+Cu

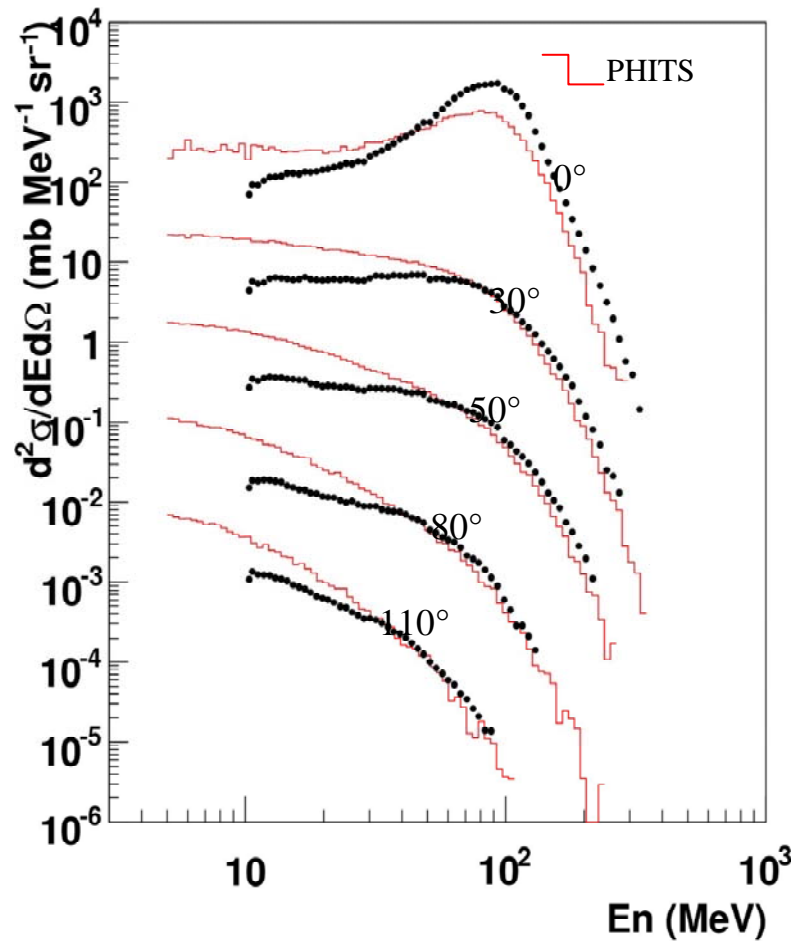

Production of neutrons
HIMAC data : Ar(560MeV/u)+Cu

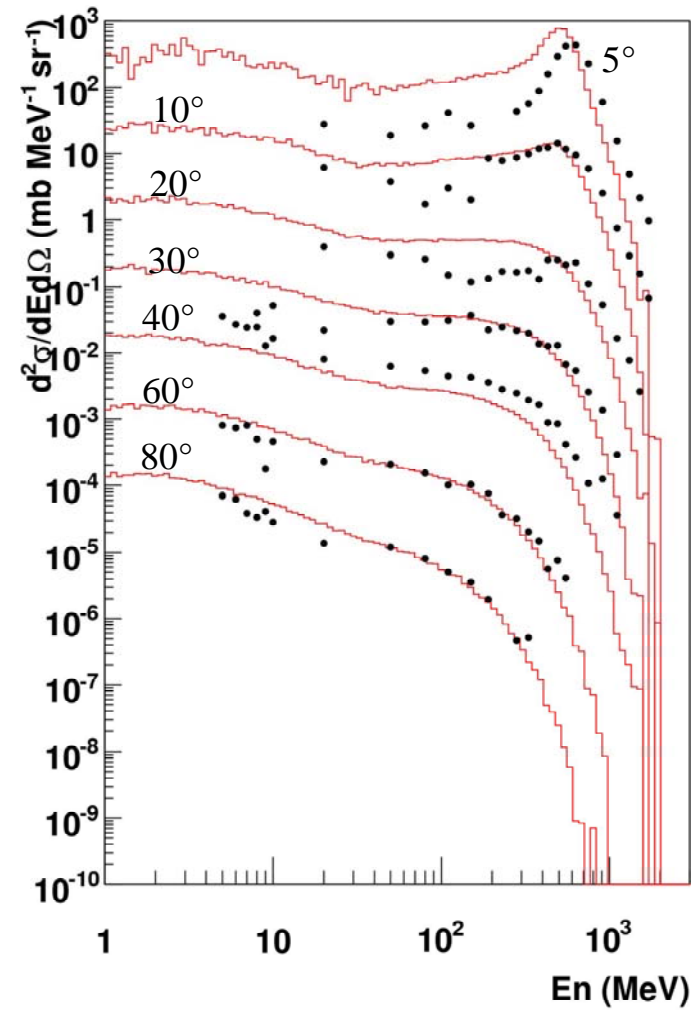

B. Rapp et al. (CEA)

A) Shielding of the postaccelerator

Assumption: 100 MeV/u ^{132}Sn + Cu at $I = 6 \times 10^{12}$ pps; beam loss of 1 second

Resulting Dose Map

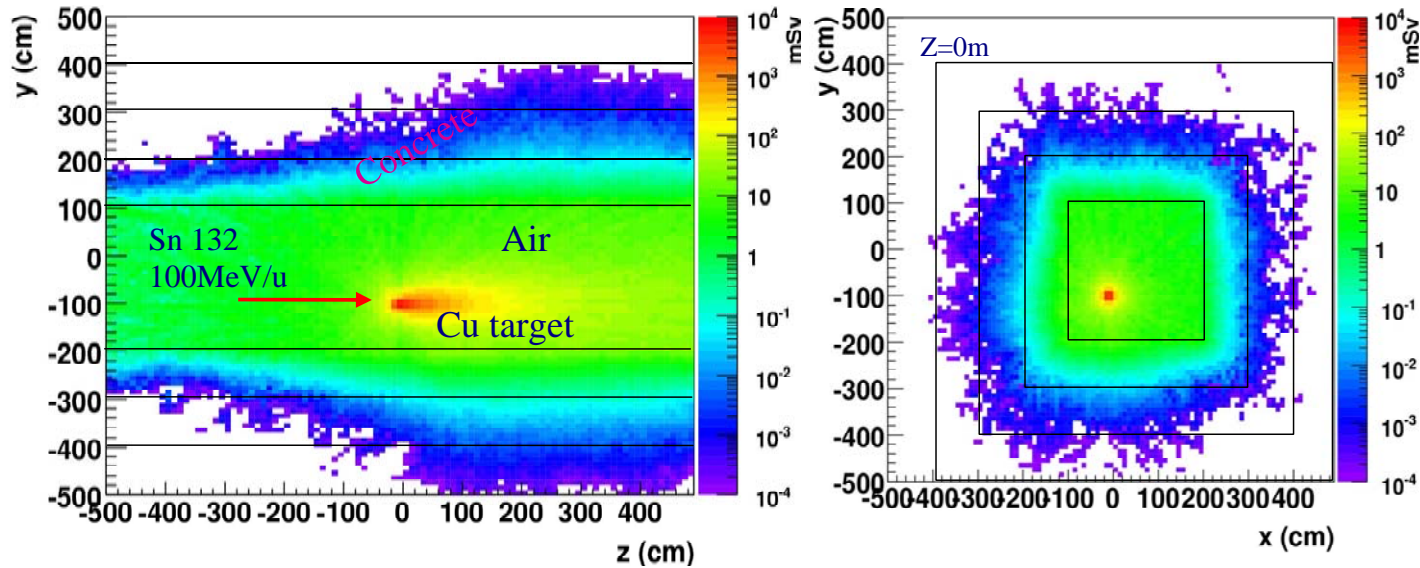

Condition for dose rates:
 $20\text{mSv} / 2000 \text{ h} \rightarrow < 10 \mu\text{Sv/h}$

Assumption for losses:
1 s beam loss once a day with probability of $10^{-5}/\text{m}$

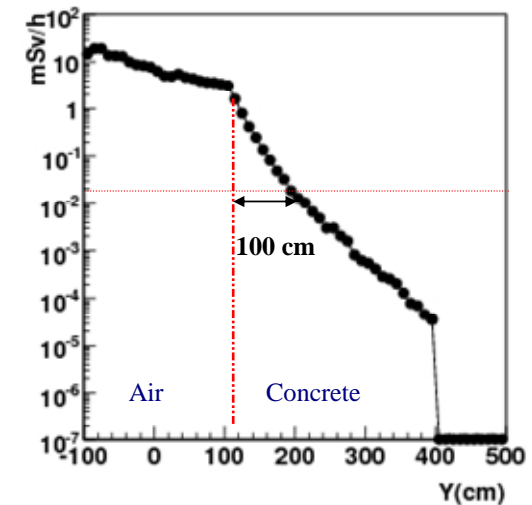
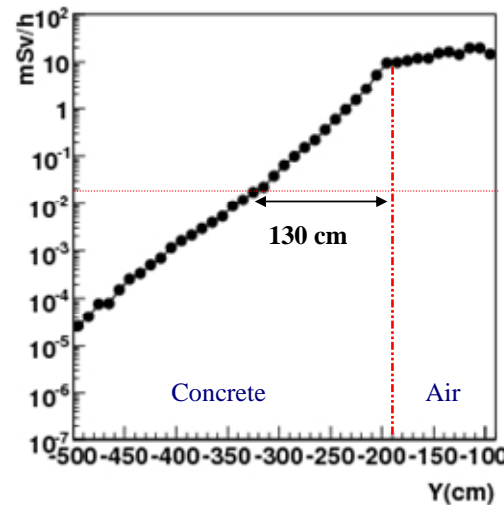

B. Rapp et al. (CEA)

A) Activation of the 4 MW target

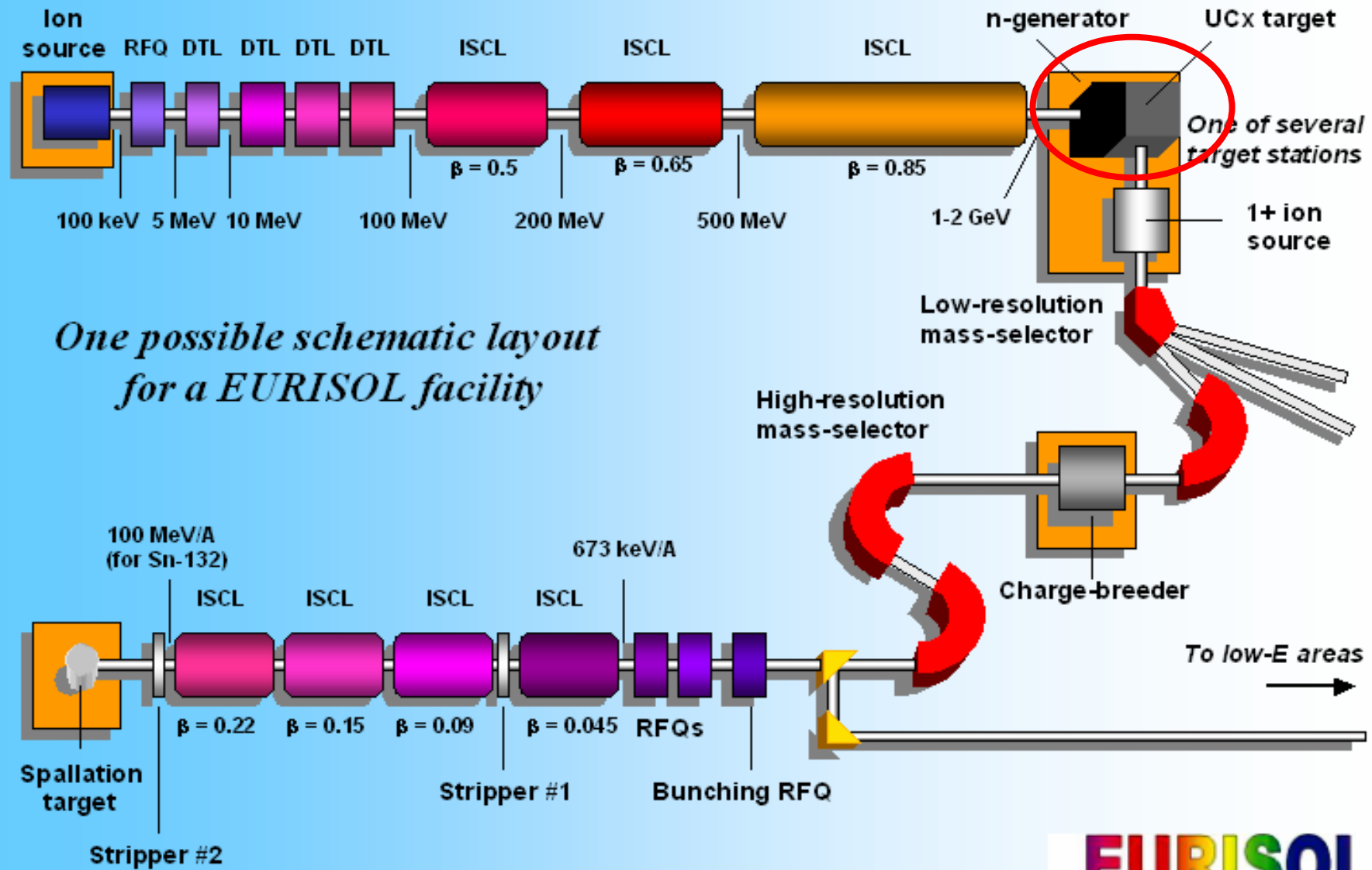

One possible schematic layout for a EURISOL facility

1GeV p+Pb

Production of Residual Nuclei

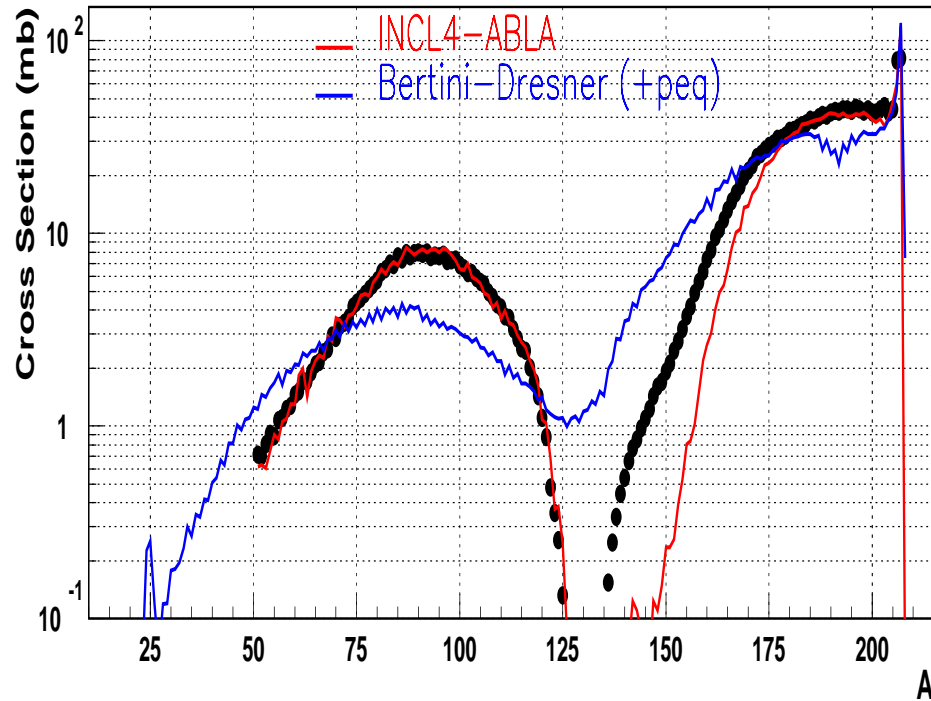

J.-C. David et al. (CEA)

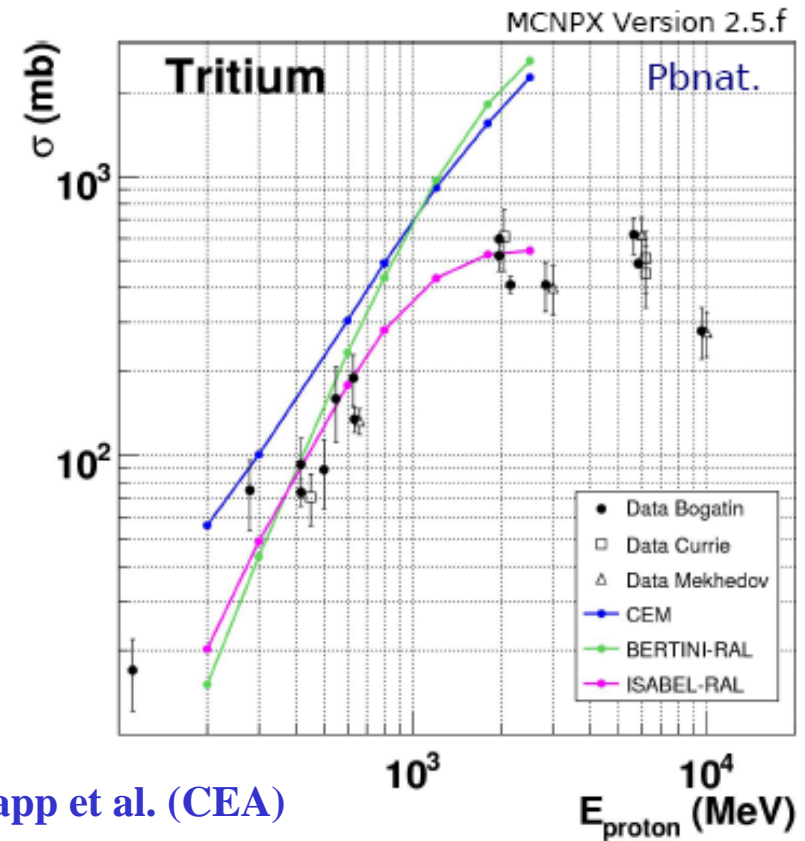

B. Rapp et al. (CEA)

A) Activation of Hg and UCx

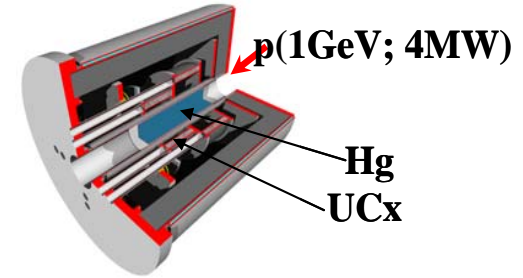
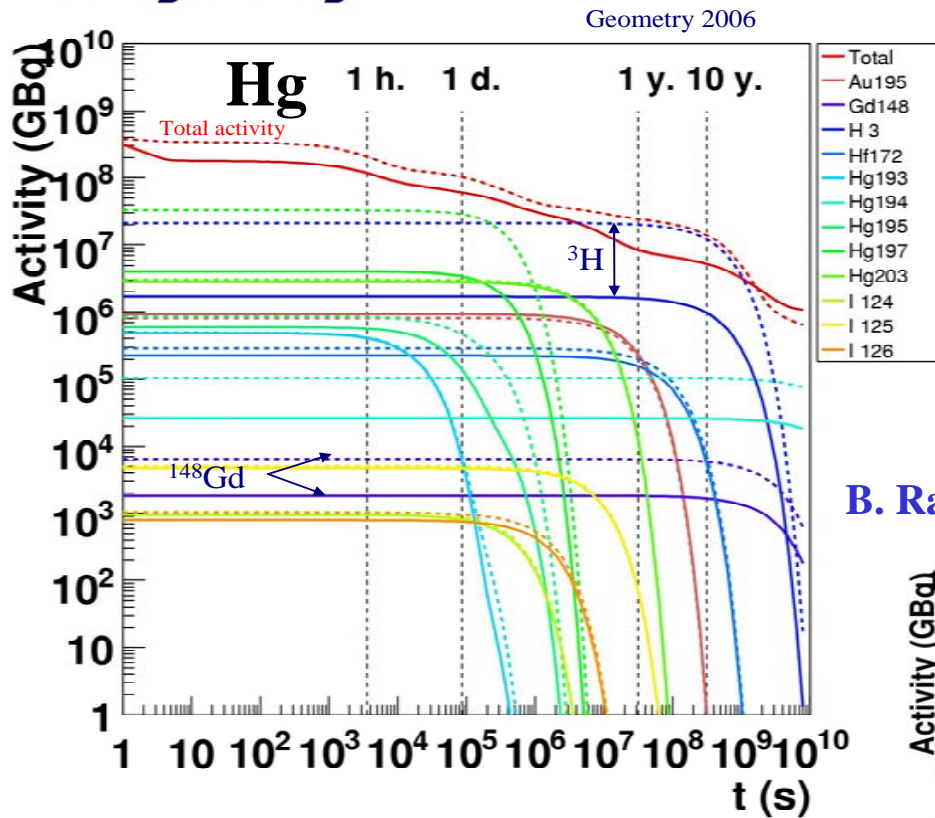

◇ Irradiation : 40 years operation, 5000 h/year, 4MW beam power

◇ Important differences appears in nuclide yield production, and consequently in Hg target activity

B. Rapp et al. (CEA)

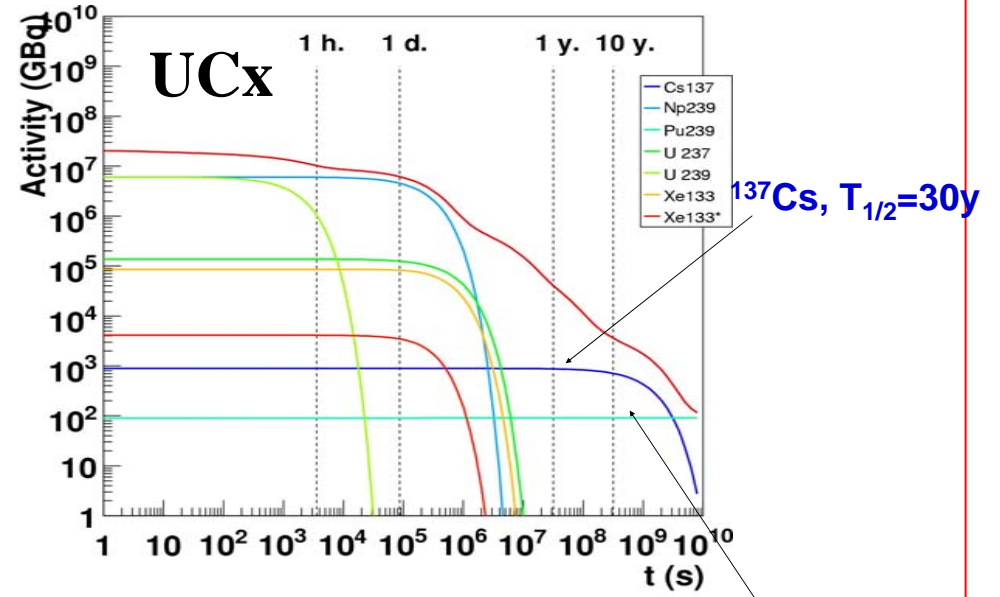

→ induced activity comparable to the research reactor + α emitters

→ production of ^{239}Pu : ~50 g/year

T. Otto et al. (CERN)

40 years irradiation at 2.28 MW

1 MBq/g < A < 1GBq/g
 1 kBq/g < A < 1MBq/g
 1 Bq/g < A < 1kBq/g
 A < 1Bq/g

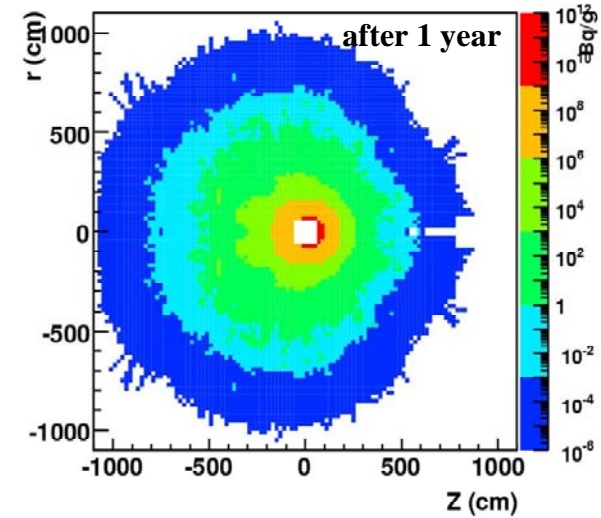
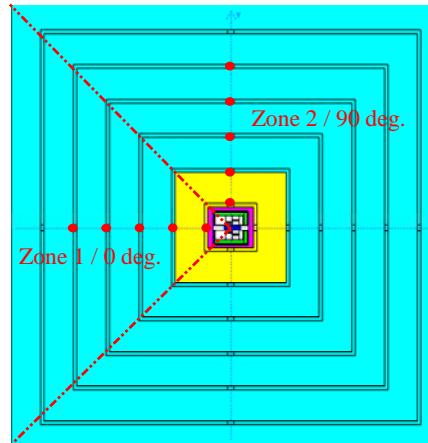

Concrete, 0 degree, at 1m70

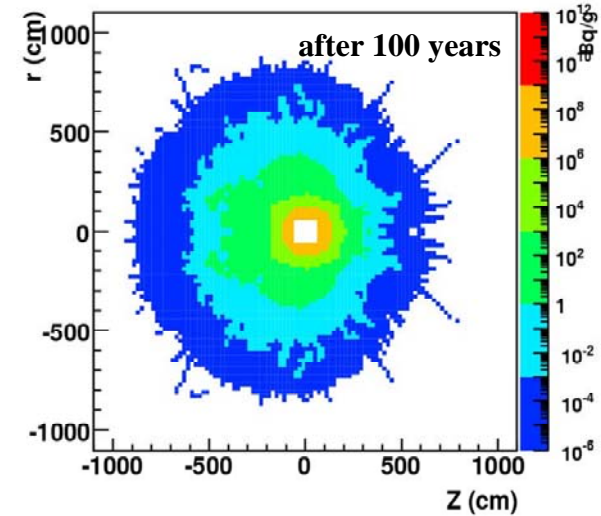
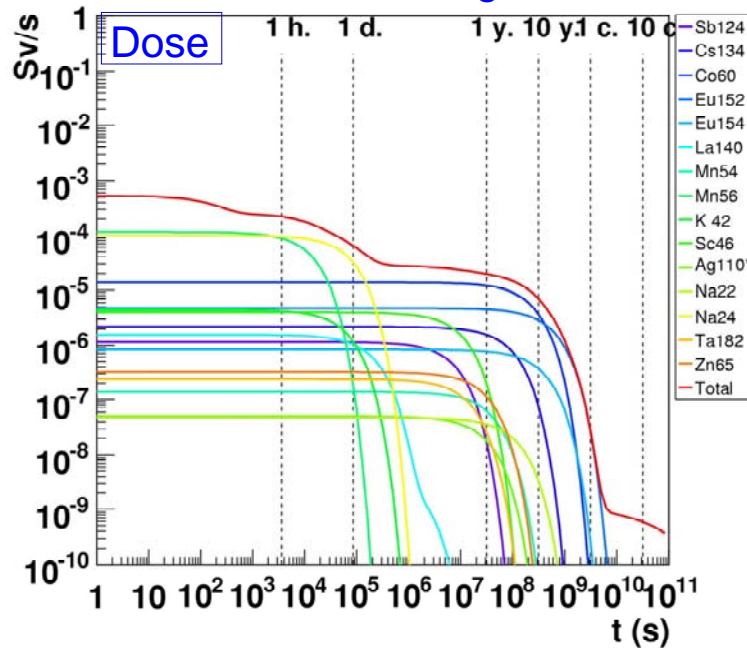

B. Rapp et al. (CEA)

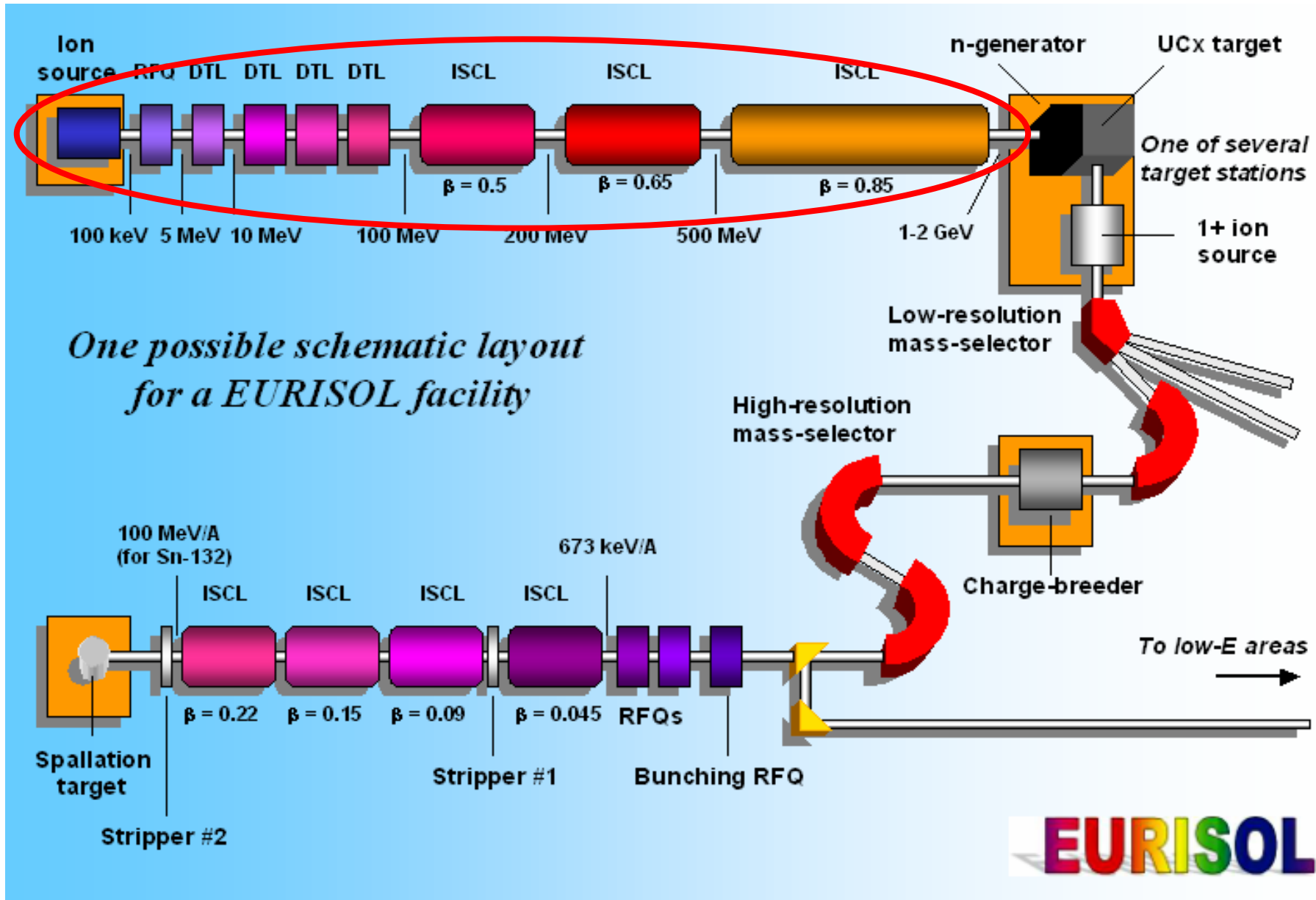

Goal: prediction of radioactivity at the boundary of the supervised area

Conservative assumptions:

- maximum concentration at the source
- saturated water flow
- small partition coefficient K_d & high $T_{1/2}$
- ...

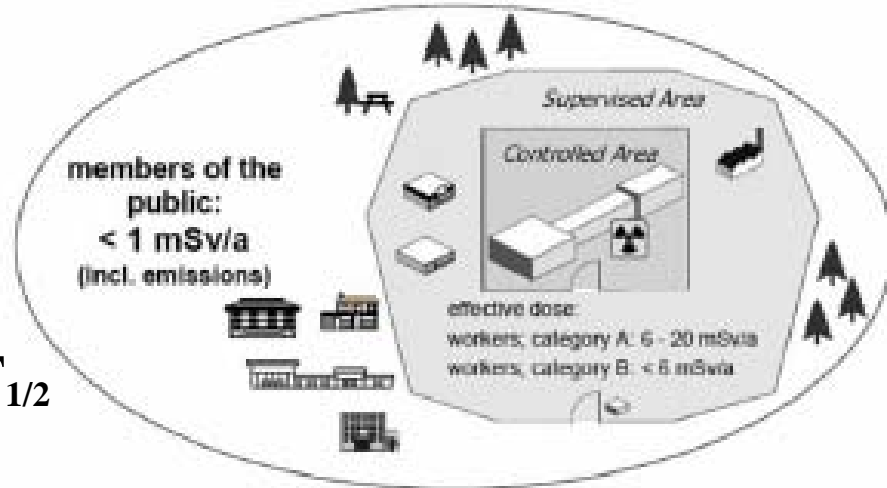

Tools used:

TRACE
water flow simulations needed for

PATRACE
particle tracking (includes sorption & decay)

	Half-life			
	^{32}P 14.26 d 5 cm ³ /g	^{45}Ca 163 d 5 cm ³ /g	^3H 12.323 a 0 cm ³ /g	^{36}Cl 300000 a 0 cm ³ /g
	^{55}Co 17.54 h 30 cm ³ /g	^{35}S 87.5 d 14 cm ³ /g	^{60}Co 5.272 a 30 cm ³ /g	^{14}C 5730 a 7 cm ³ /g
	^{24}Na 14.96 h 76 cm ³ /g	^{57}Co 271.79 d 30 cm ³ /g	^{54}Mn 312.2 d 50 cm ³ /g	^{32}Si 172 a 35 cm ³ /g

Prolingheur et al. (FZJ)

Linac tunnel

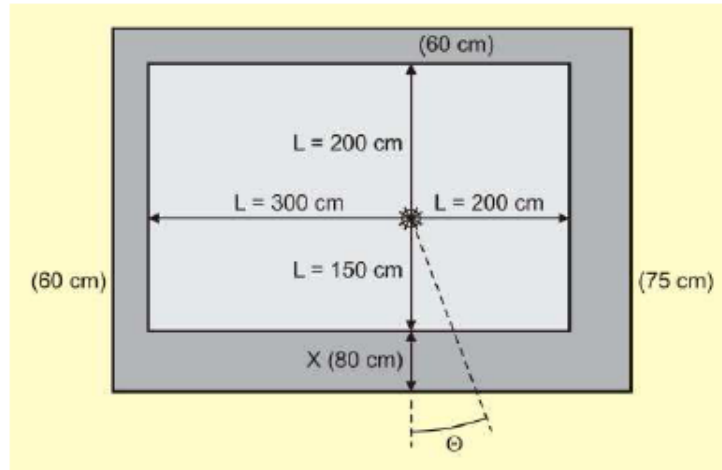

Final goal:

- **Committed effective doses**
- **Effectiveness of the shielding**
- **Generalization of the method**
- **Extension of the boundary area**

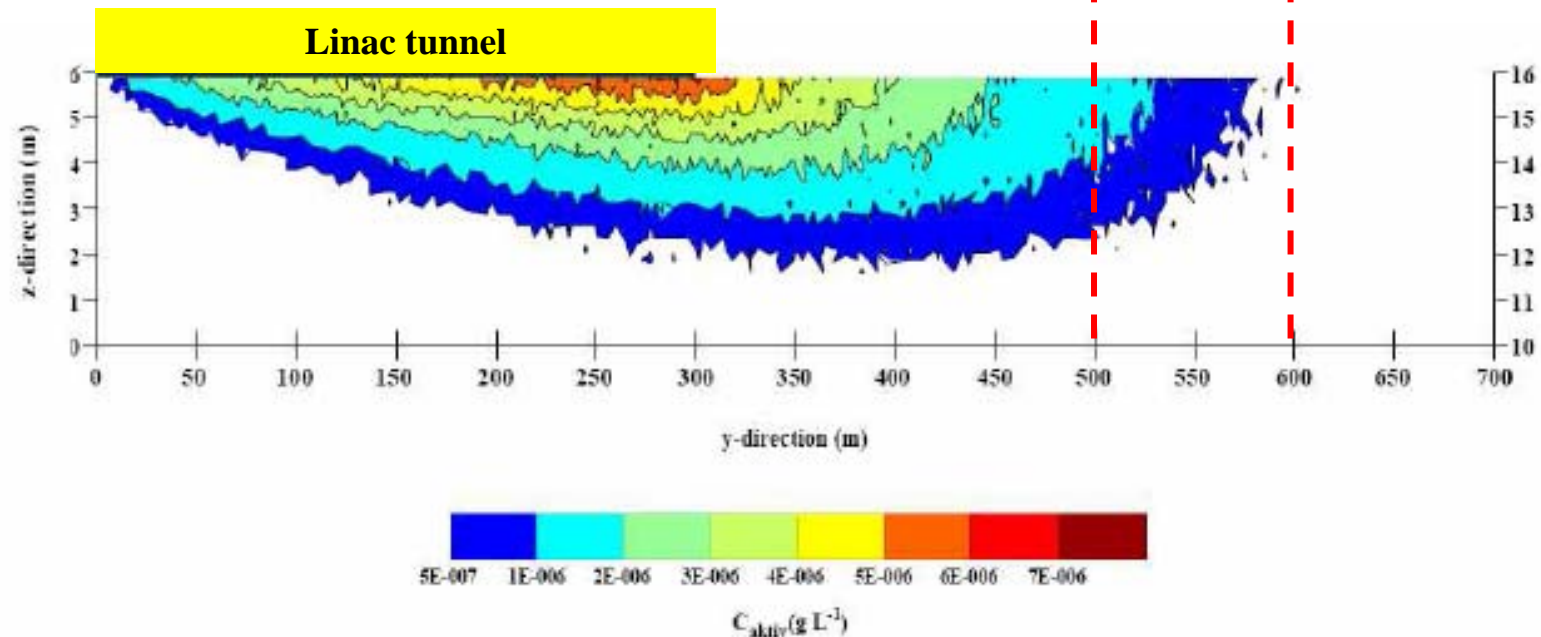

Activity Distribution (MOVAK 3D)

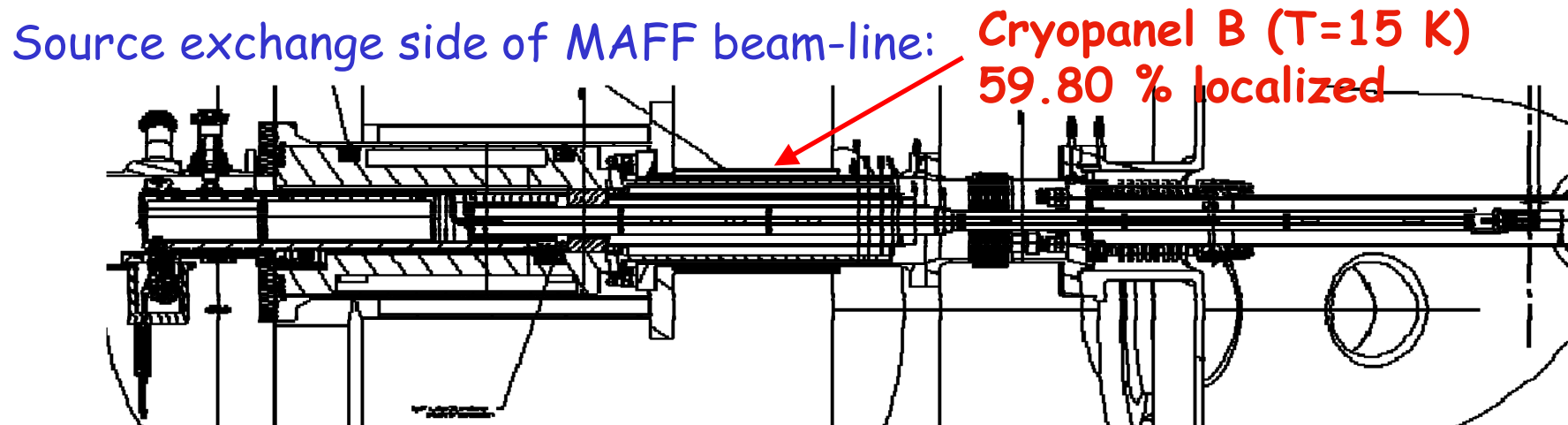
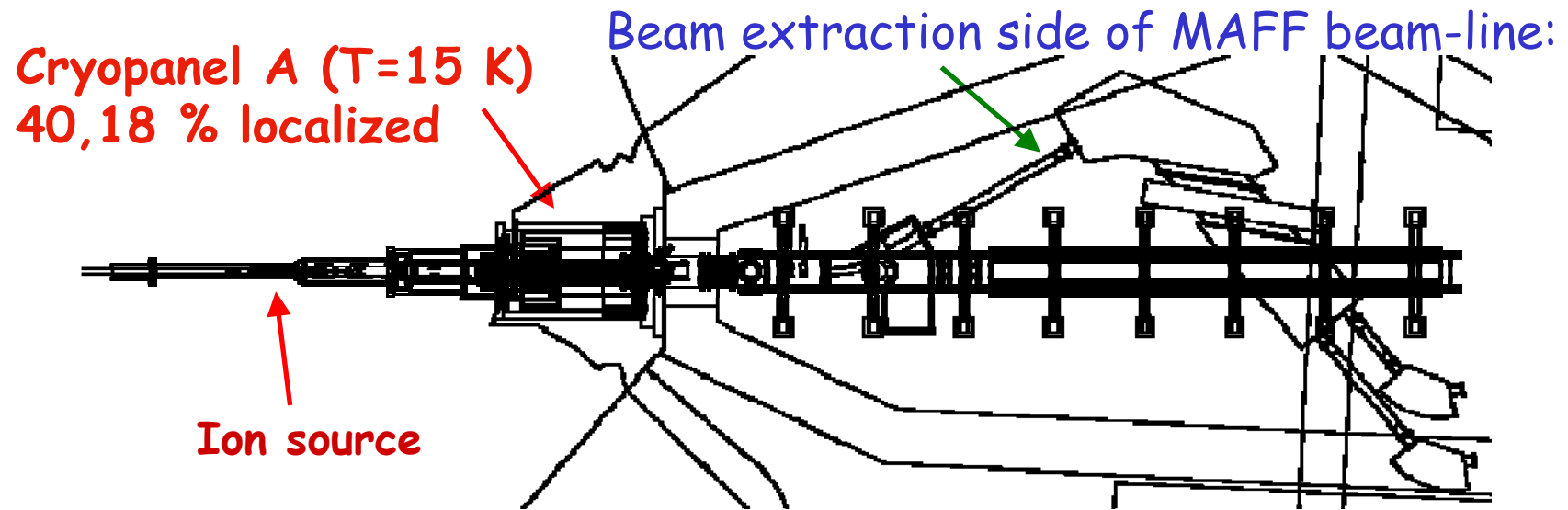

Simulations: cryopanel will localize 99.98% of volatile radioactivity

Comparison: 2 cryotrap designs

'large' panel (GP):

- double-walled tube
- 6 spiral gas channels
- no passive shield



- turbulent regions of gas flow with compression/expansion
-> anisotropic temperature distribution

'small' panel (SP):

- only for comparative tests
- 1 bent tube
- 2 passive shielding paddles

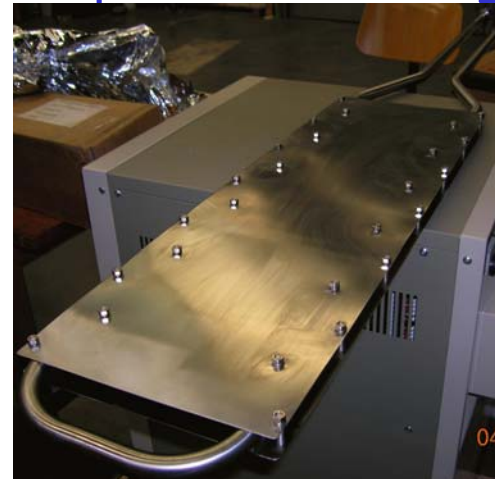

- unambiguous gas flow characteristics
- simple mechanical design, no weldings

Surface ratio: $A(GP)/A(SP) \sim 18$ (without shield)

Cryotrap Testbench at MLL/Garching

cryotrap coupled to He refrigerator: ~ 600 W cooling power at 12 K

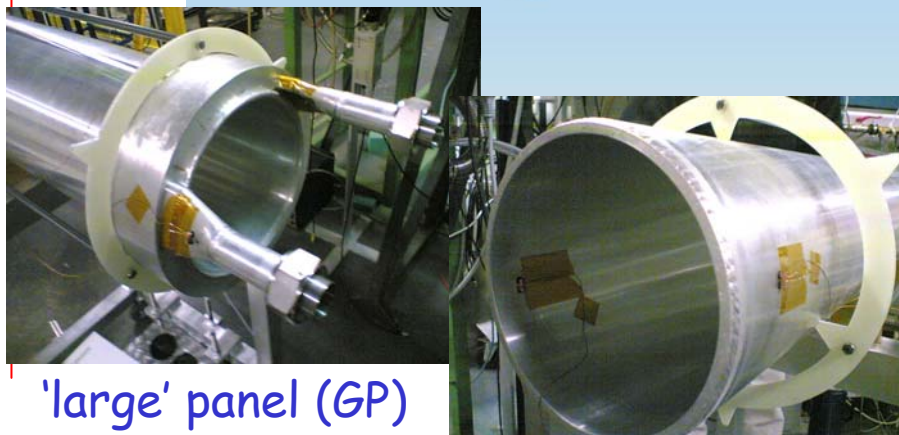
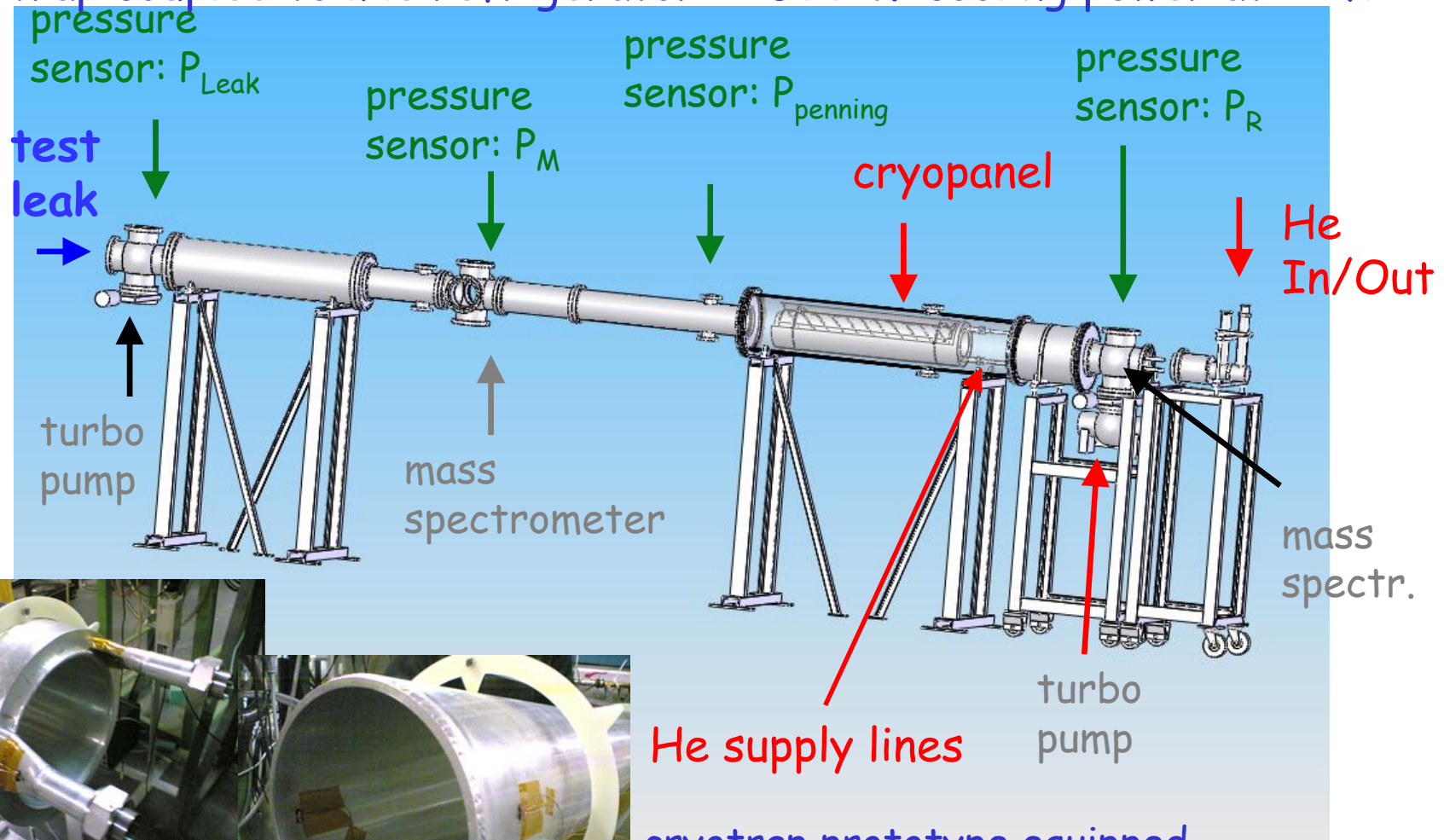

'large' panel (GP)

cryotrap prototype equipped with 6 thermal sensors (Si diodes)

Localization capability of Cryotrap

'carry over': fraction of leaking gas load transported across cryotrap
 ↻ retention capability (vs. pressure behind cryotrap)

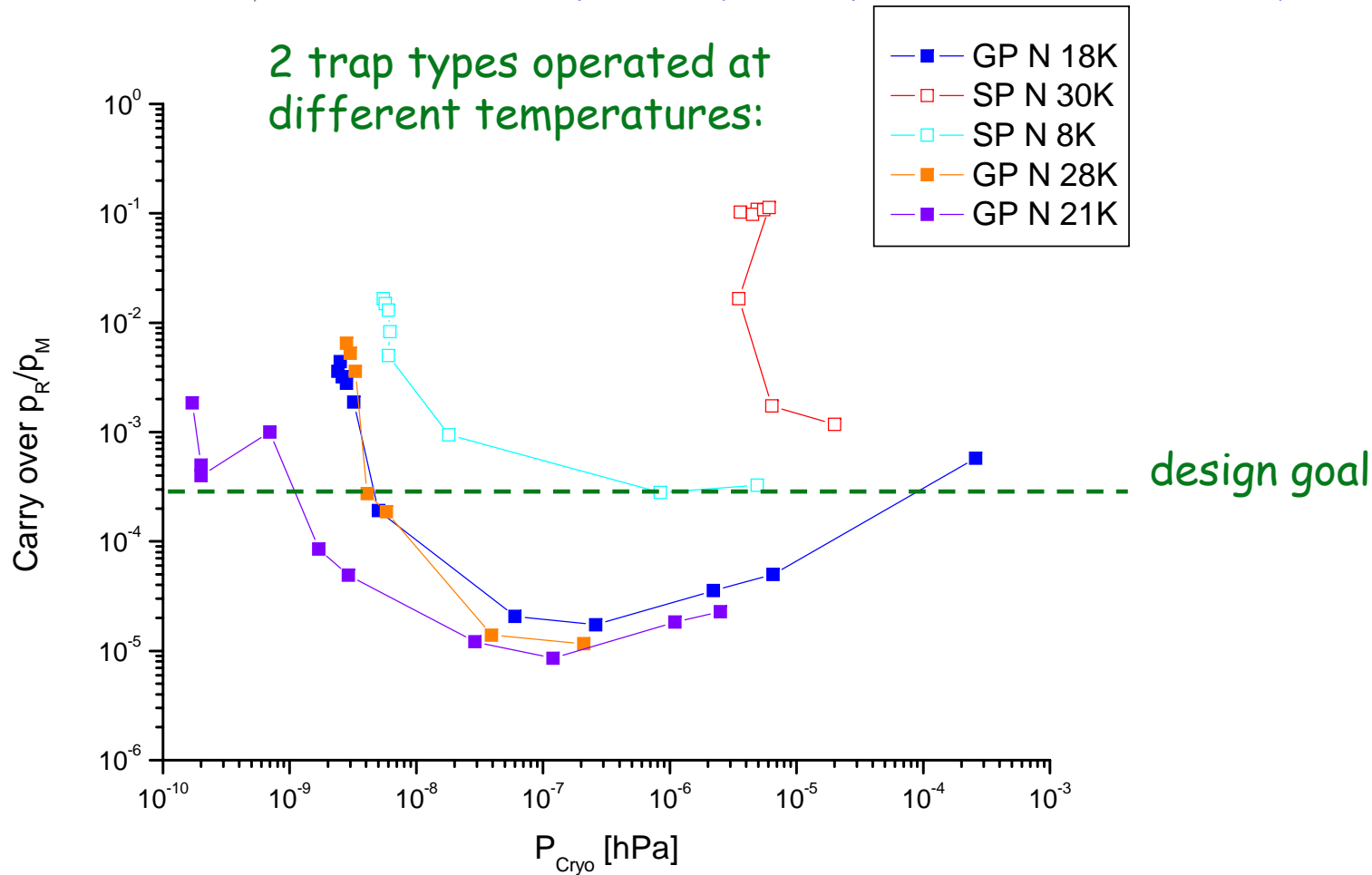

→ cryotrap works within (simulated) expectations!

test slow diffusion filter for aerosols (between decay tanks and release stack):

test setup:

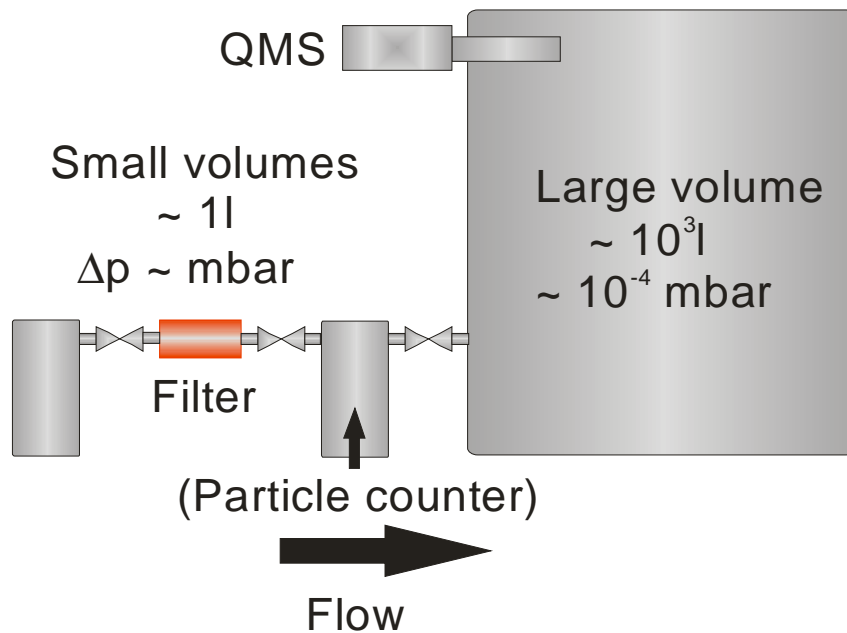

large-volume vacuum chamber (~2 m³, bakeable) with QMS:

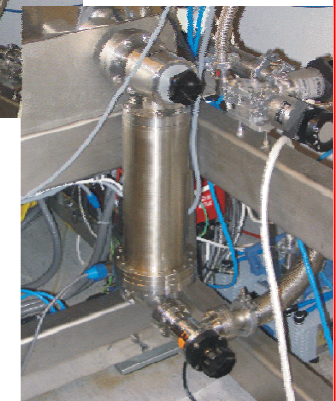

- cleanest, most efficient all-metal filter available
- sintered nickel membrane filter
- specification:
 - particle retention: > 99.9999999%
 - < 0.03 particles/liter larger than 0.01μm

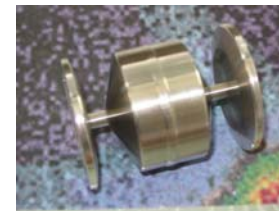

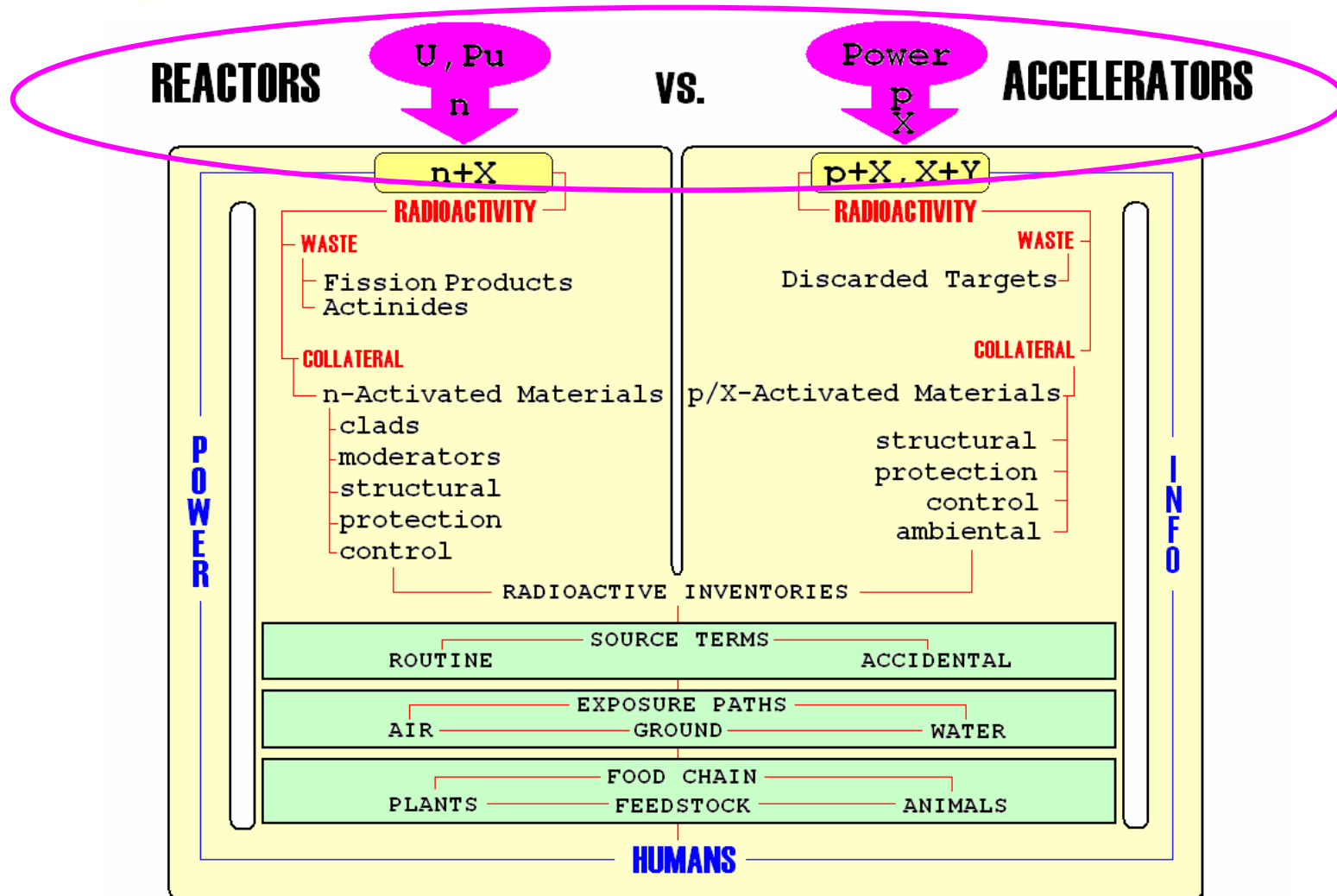

Combination of knowledge on accelerator & research reactor based nuclear installations → creation of dedicated toolkit → ADS!

→ Methodology **validated, recommended & accepted** by international regulatory bodies

→ **Tools, data & knowledge** to be used in *environmental and health impact*

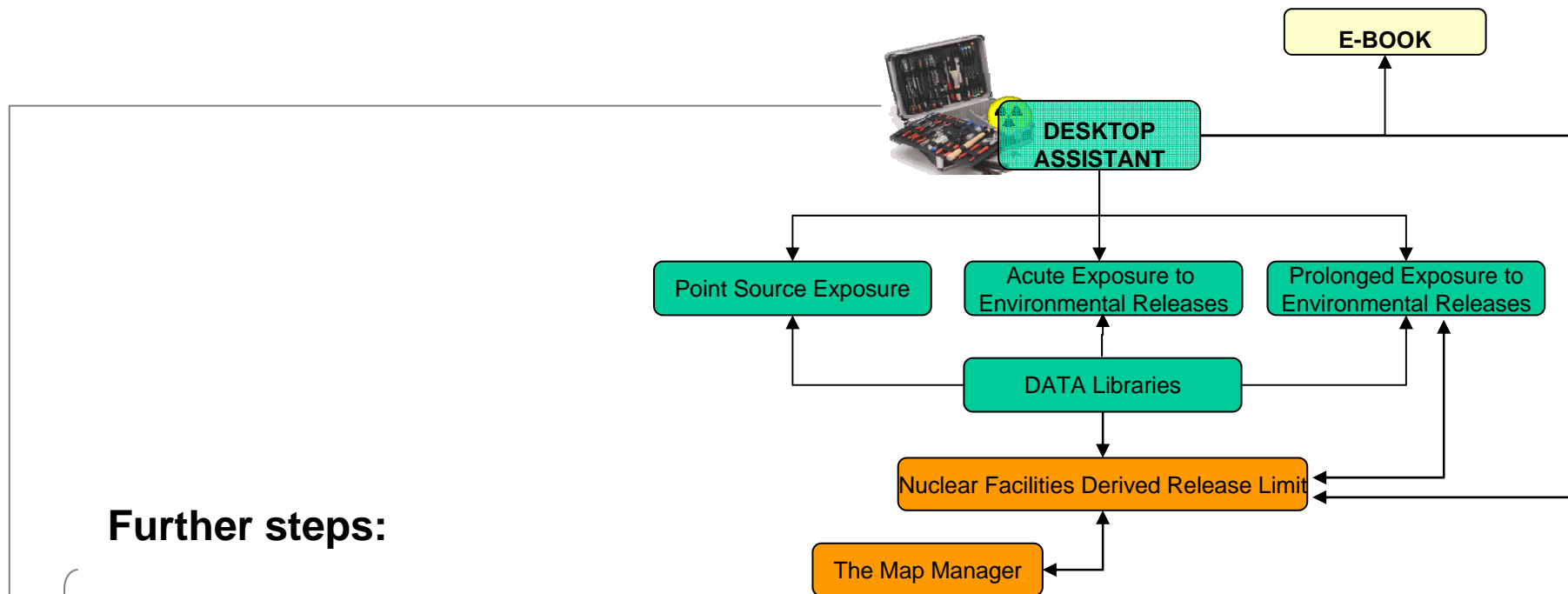

Further steps:

- *Derived Intervention Levels (DIL)*
- *Exposure from underground water contamination*
- *Development of a resident GIS platform*
- *Cadastral Impact Analysis (GIS based)*
- ...

Example: Point Source Exposure

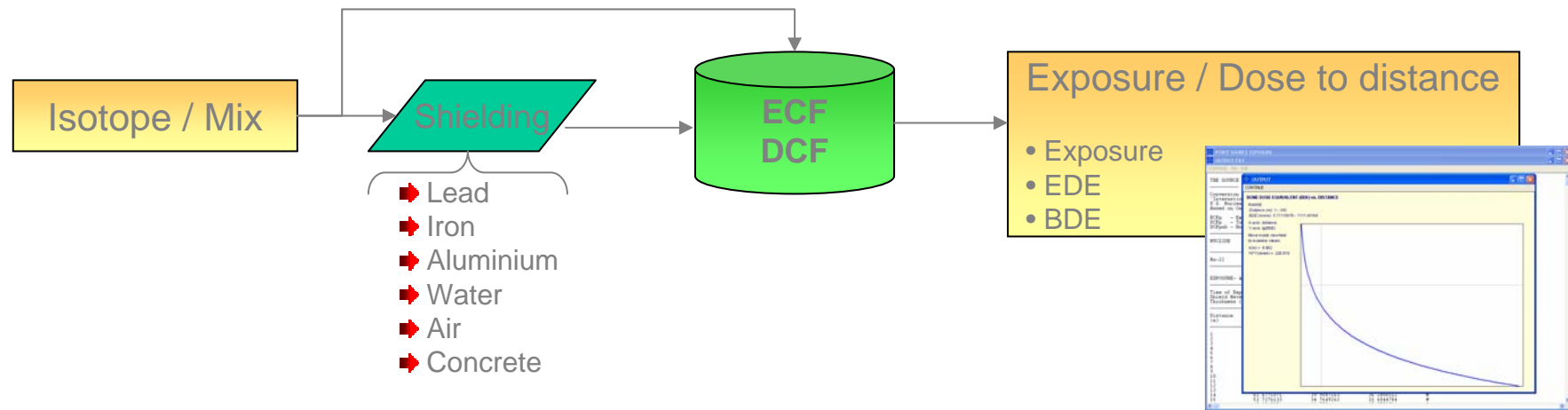

Example: Derived Release Limits

Definition of the Complex Nuclear Compound in terms of

- Emission Sources
- Receptors
- Weather conditions
- ...

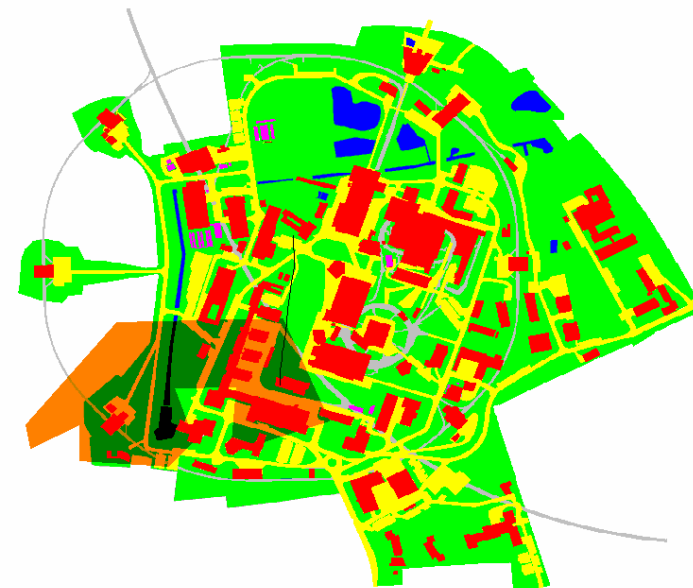

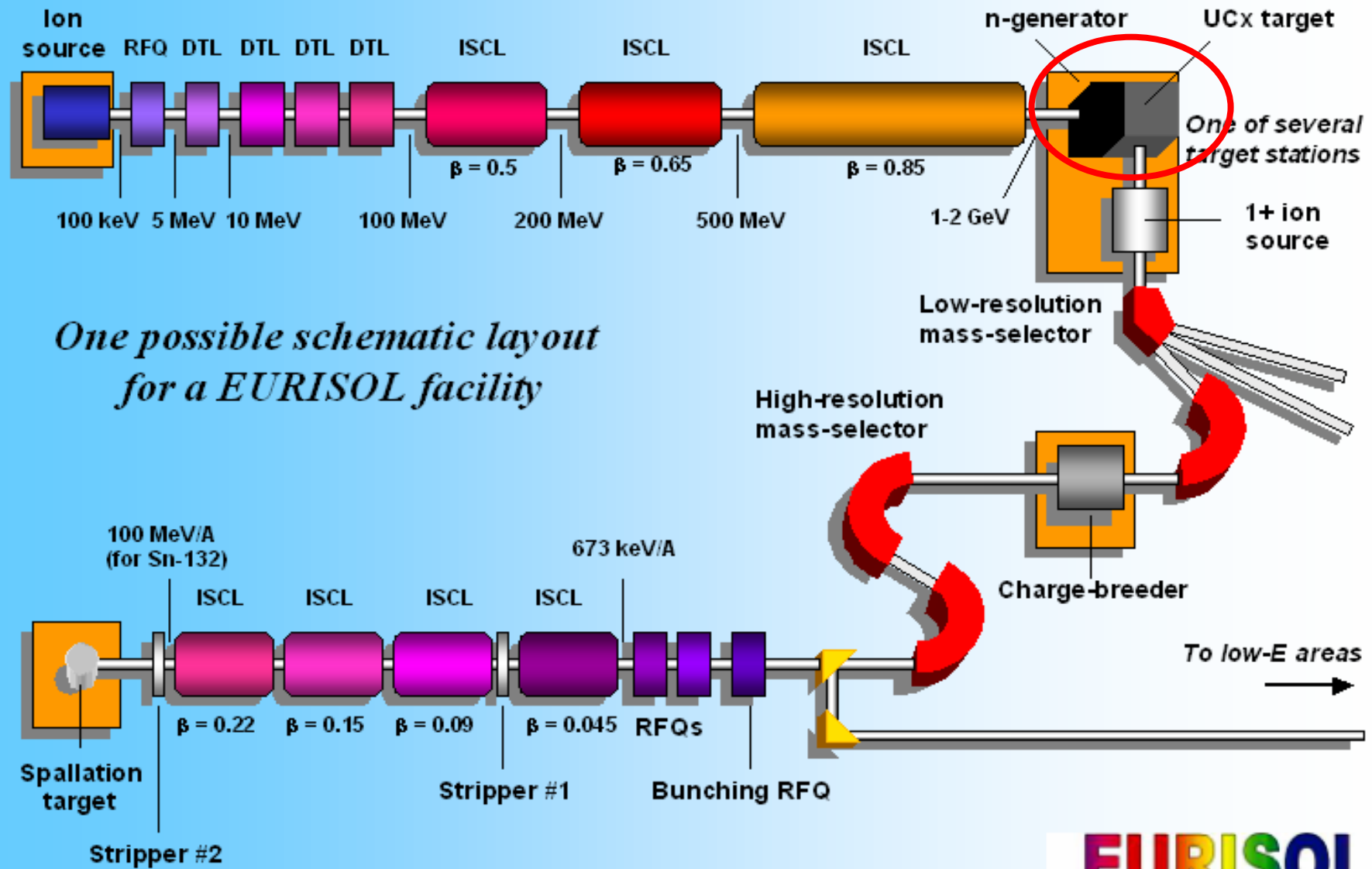

One possible schematic layout for a EURISOL facility

A) DNs in the liquid Hg loop

J-PARK

Dimension :
Width 2.6 m
Length 13.0 m
Height 4.0 m
Weight :
about 260 ton
Moving Distance
22 m

Delayed neutrons

Prompt neutrons

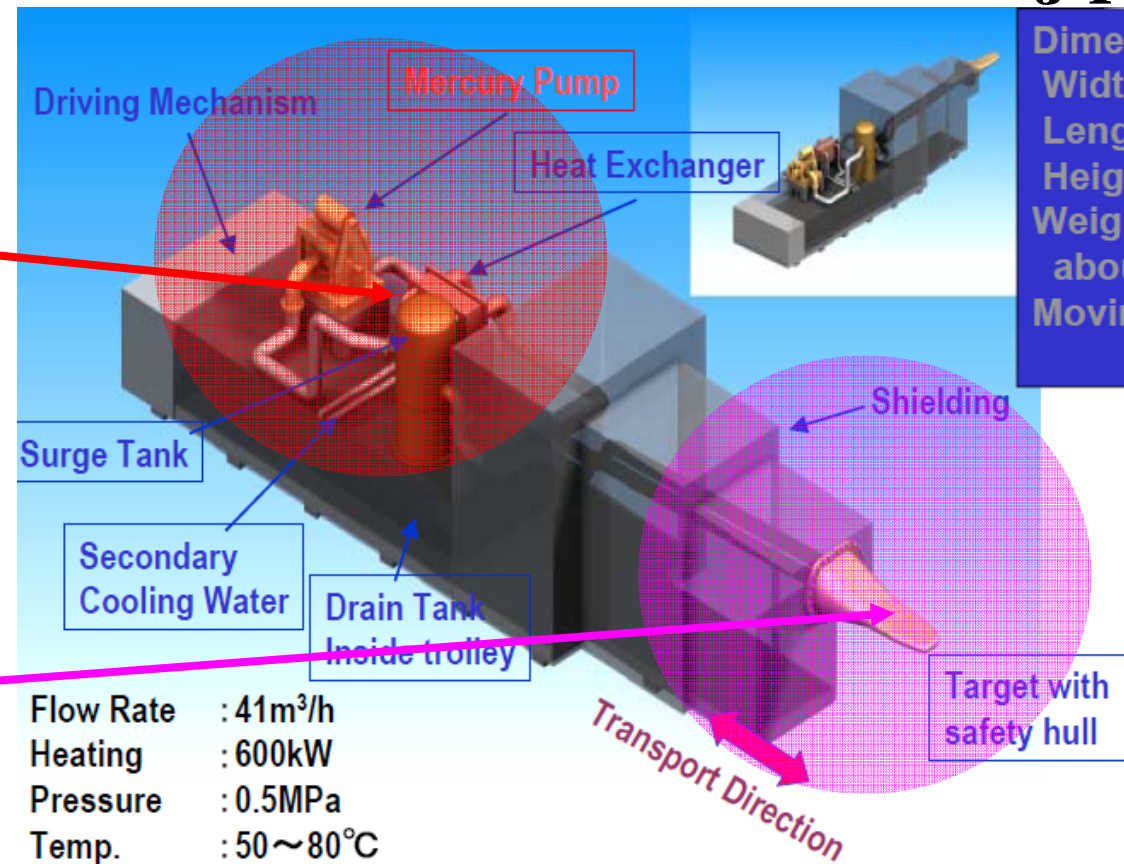

short Hg transit time →
“moving” beta, photon and **delayed neutron (DN)** radioactivity

Experimental characterization of DNs from 1GeV p + Pb (55 cm); PNPI-

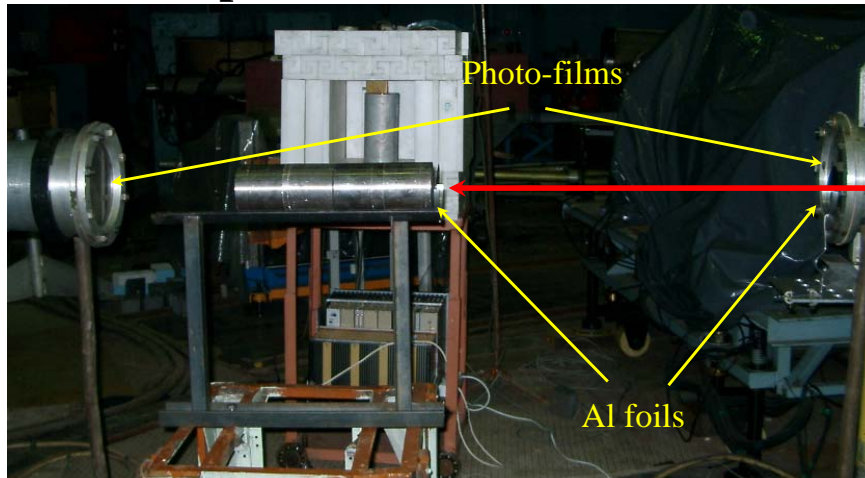

1 GeV protons

p(1GeV) + Pb (55 cm thick; 10 cm Ø)
at 1mA (1 MW)

Pb 55 cm

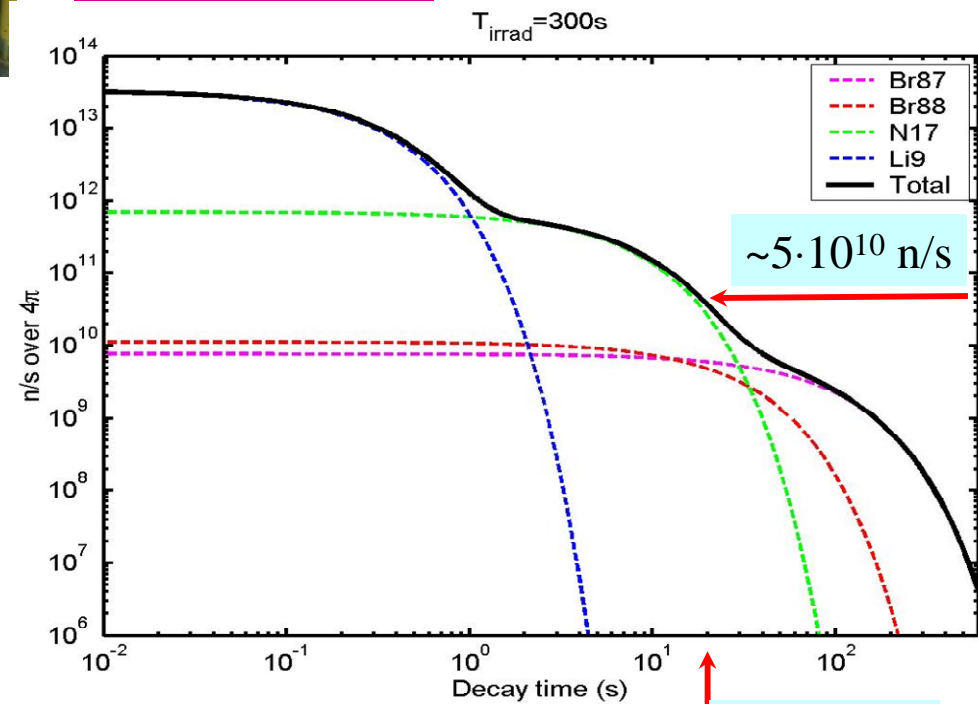
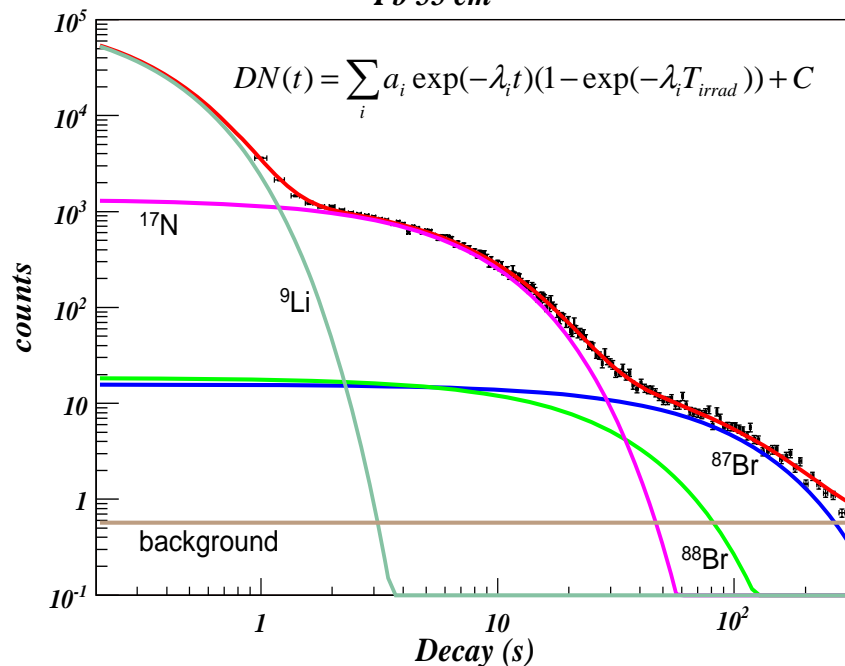

$\sim 5 \cdot 10^{10}$ n/s

~ 20 s after

A. Prevost et al. (CEA)

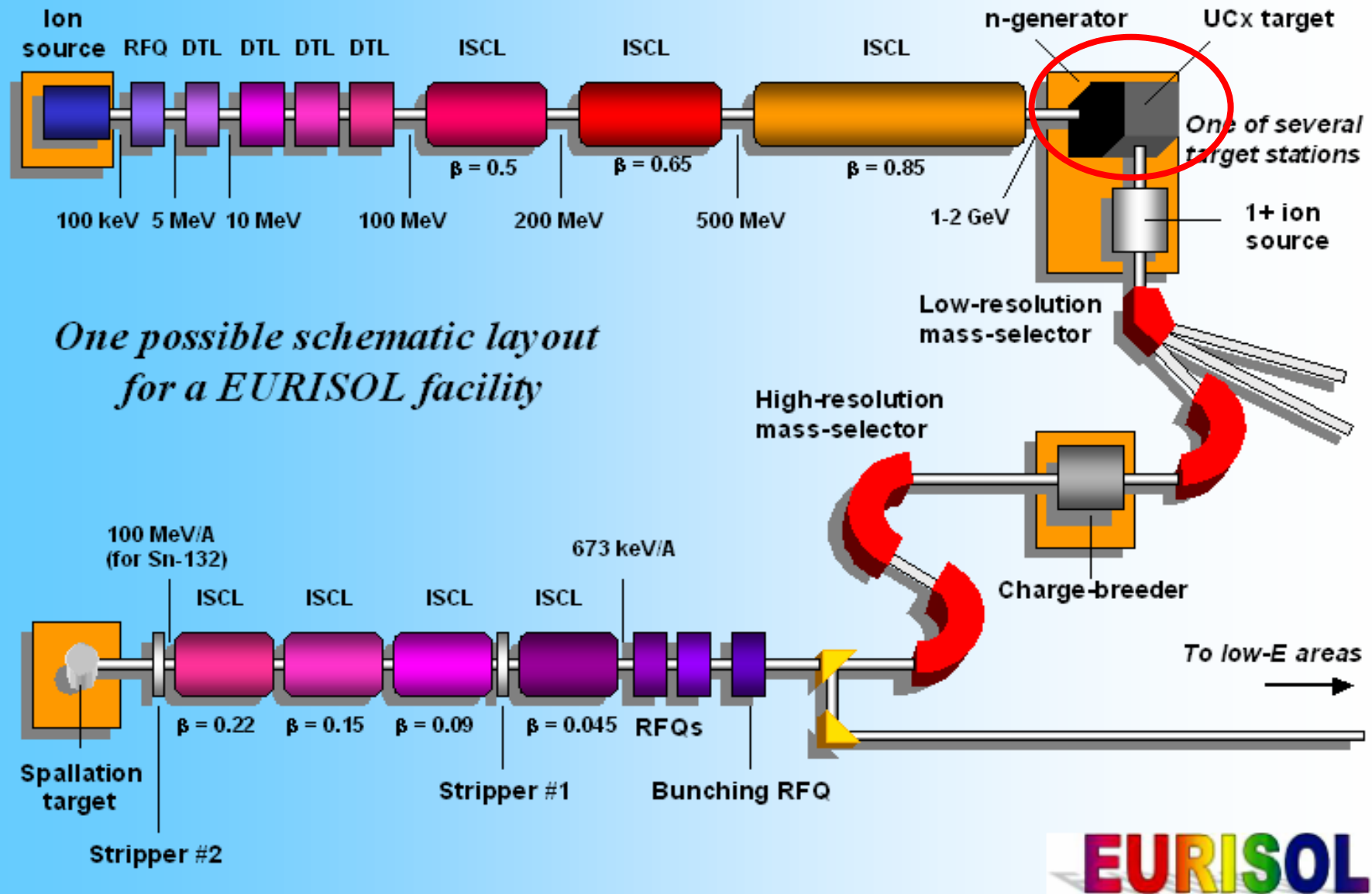

One possible schematic layout for a EURISOL facility

A schematic layout for Hg-target disposal strategy

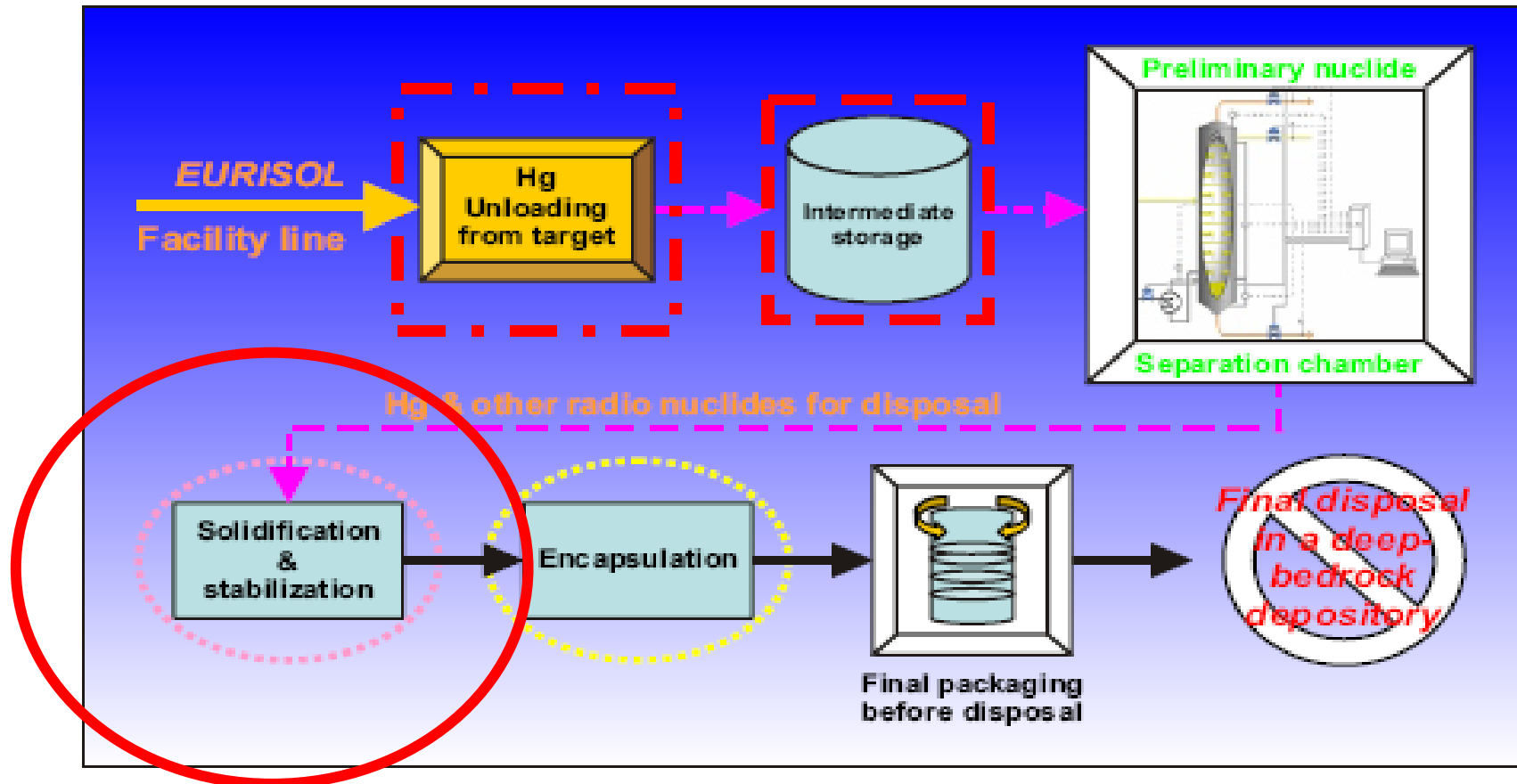

Chiriki et al. (FZJ)

A) Chemical stabilization of Hg as an inorganic compound, e.g. HgS , HgSe , HgO , Hg_2Cl_2 , HgCl_2

✓ HgS is highly insoluble in water, stable solid, and dominating mercury mineral in nature

✓ HgS is a powder and instead of a paste as amalgams, thus making it is an easier process

✓ HgS has very high loading compared to transition metal amalgams (Zn amalgam was studied)

✓ Formation process is a single step reaction

✓ Elemental sulfur is relatively cheap, and enough process options are available with sulfur

B) Stabilization by dissolution in metals called amalgamation, e.g. Cu, Zn, Sn, Ag, dental amalgam, Alloy powders

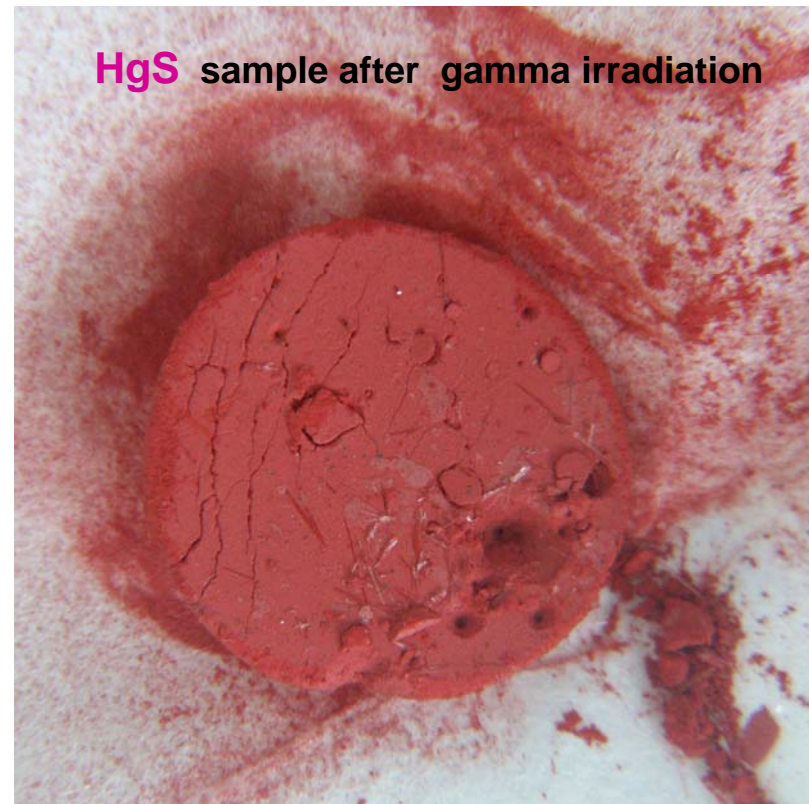

Chiriki et al. (FZJ)

Optimistic Summary

**Work is in progress but
we are only at the end of the beginning!**

Thanks to all participants!

CERN: T. Otto, M. Felcini

LMU: T. Thirof, W. Carli, M. Gross, A. Kohlhund, F. Nebel, J. Neumayr,
R. Stoepler, J. Szerypoet

FZJ: R. Moormann, K. Bongardt, S. Chiriki, J. Fachinger, M. Herbst,
B. Heuel-Fabianek, R. Nabbi, N. Prolingheuer, H. Schaal, B. Schlögl,
K. Verfondern

NIPNE: F. Negoita, D. Vamanu, B. Vamanu, V. Acasandrei, D. Ene

FI: A. Plukis, R. Plukiene, E. Maceika, A. Zukauskaite

CEA: D. Ridikas, B. Rapp, A. Prevost, V. Blideanu, J.C. David, D. Dore

GANIL: B. Rannou, M. Fadil

UW: L. Pienkowski, W. Gawlikowicz

